

## *Digital Image Receptor*

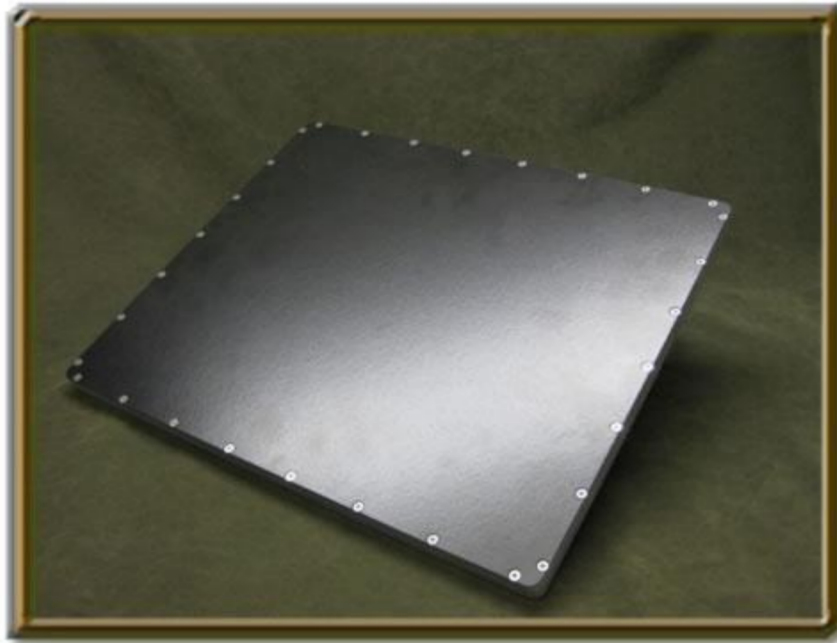

The PaxScan 2530C is a radiographic low speed fluoroscopic imaging sub-system

**Abstract** The PaxScan<sup>®</sup> 2530C Operating Instructions (P/N 42891-000) covers safety, setup, operation, and maintenance of the PaxScan 2530C digital x-ray imager. The imager is a component sub-system intended for integration by a qualified systems integrator.



Varian Medical Systems, Inc  
X-Ray Products  
1678 So. Pioneer Rd  
Salt Lake City, UT 84104  
United States  
+ 1 801 972 5000 Phone



Varian Medical Systems UK Ltd.  
Gatwick Road, Crawley  
West Sussex RH10 9RG  
United Kingdom

**Notice** Information in this manual is subject to change without notice. Varian is not liable for errors or omissions contained in this manual or for any damages incurred in connection with furnishing or use of this material.

This document contains proprietary information protected by copyright. No part of this document may be reproduced, translated, or transmitted without the express written permission of Varian Medical Systems, Inc.

**Updates** For updates to these instructions, please refer to the *Release Notes*

**Trademarks** Paxscan<sup>®</sup> is a registered trademark and ViVA<sup>™</sup> is a trademark of Varian Medical Systems, Inc. Microsoft<sup>®</sup> is a registered trademark and Windows<sup>™</sup> is a trademark of Microsoft Corporation. EPIX<sup>®</sup> is a registered trademark of EPIX, Inc.

© Varian Medical Systems, Inc.  
All rights reserved. Printed in the United States of America  
Use is prohibited without Varian's express written consent

Proprietary & Confidential Information

**Technical Support**

If help is needed, please contact our applications support group by e-mail or telephone at the following locations.

E-mail: [paxscan.service@varian.com](mailto:paxscan.service@varian.com)

▪ International Offices

*Sales*

▪ Italy	
Corso Susa, 299B 10098 Rivoli (Torino), Italy	+ 39 011 955 03 96 Phone + 39 011 953 62 59 Fax
▪ Japan	
6F METLIFE Kabutocho Bldg. 5-1 Nihonbashi Kabutocho Chuo-ku Tokyo 103-0026, Japan	+ 81 3 4486 5070 Phone + 81 3 4486 5069 Fax
▪ Neitherland	
Zutphensestraat 160A 6971 ET Brummen The Netherlands	+ 31 575 566 093 Phone + 31 575 566 538 Fax
▪ Switzerland	
P.O. Box 38 1714 Heitenried - Switzerland	+ 41 26 495 32 58 Phone + 41 26 495 32 59 Fax

*Sales and Technical Support*

▪ China	
Varian Pan-Pacific Beijing Branch No. 8 Yun Cheng Street Beijing Economic – Technological Development Area (BDA) Beijing 100176, China E-mail: <a href="mailto:xraychina@varian.com">xraychina@varian.com</a>	+ 010 8785 8785 Phone + 010 8785 8954 Fax
Varian Pan-Pacific Shanghai Branch Room 2208, Central Plaza 227 North HuangPi Road Shanghai 200003, China	+ 86 21 6375 8953 Phone + 86 21 6375 8957 Fax

*Sales, Technical Service and Warehouse*

▪ Germany	
Karl-Arnold-StraBe 12 D-47877 Wilich, Germany Sales, Technical Service and Warehouse E-mail: <a href="mailto:sales-xray@varian.com">sales-xray@varian.com</a>	+ 49 2154-92 4980 Phone + 49 2154-92 4994 Fax

## Chapter Summary

- 1** Introduction
- 2** Getting Started
- 3** Paxscan Software
- 4** Modes of Operation
- 5** Calibration Procedures
- 6** Image Acquisition
- 7** Safety
- 8** Maintenance
- 9** Trouble Shooting
- 10** Problem Report
- 11** Appendix

## Index

Introduction .....	6
Shipment Contents.....	6
Optional Parts .....	6
Intended Use.....	7
Safety Warnings, Precautions and Contraindications.....	7
Explanation of Symbols .....	8
Getting Started.....	9
System Overview .....	9
Figure 1-0 Imager Configuration .....	9
Connecting the Cables.....	10
Table 1-0 Cable Connection Details .....	10
Figure 2-0 Cable Connection.....	11
Figure 2-1 LED Status Indicators .....	11
Paxscan System Software.....	13
Software Installation.....	13
Receptor Files Installation.....	18
Modes of Operation .....	19
Table 2-0 PaxScan 2530C Operational Mode .....	19
Default Mode.....	20
Operation States .....	20
Calibration Procedures .....	21
Offset Calibration .....	21
Gain Calibration .....	24
Table 3-0 Gain Calibration: All Modes .....	25
Low Speed Fluoroscopic Mode Gain Calibration.....	26
<i>VIVA</i> Mode Settings .....	30
Image Acquisition .....	32
Low Speed FluoroscopyMode .....	32
Safety.....	35
Electro-Magnetic Interference.....	35
Electrical Shock Protection .....	35

## Index

Environment Conditions .....	35
Altitude Limits .....	35
Regulatory .....	36
Maintenance .....	37
Cleaning and Disinfection.....	37
Repairs.....	37
Proper Disposal .....	37
Troubleshooting.....	38
How To Reach Us .....	39
PaxScan 2530C Problem Report Customer Information.....	40
Appendix A .....	41
Figure A.1 Schematic for “User_Sync” and “Expose_OK” Signal.....	42
Figure A.2 2530C Timing Diagram.....	43
Appendix B.....	44
Figure B.1 Diagnostic Data for 2530C .....	44
Appendix C.....	46
External Power .....	46

## Introduction

The PaxScan® 2530C is a high-resolution, radiographic, low speed fluoroscopic digital X-ray imaging device commonly referred to as a flat panel detector (FPD). The detector together with real-time image processing software (Virtual Command Processor) incorporates the latest high speed electronics technology, used in the Varian real-time imagers, to meet the imaging requirements for new generation medical, dental, and industrial application. The imaging system has three main components: The amorphous silicon FPD, Virtual Command Processor software, and universal single-output power supply.

## Shipment Contents

Flat Panel Detector Assembly

PaxScan Receptor Install CD

(Files specific to the detector in shipment)

PaxScan Software CD

Virtual CP/ViVA System Software L.07 (or higher)

Receptor Power Interface Cable – part number 26021 (different lengths available)

2530C Operating Instructions

## Optional Parts

External Power Supply – XP Power (OEM)

Cable, Main 110V Hospital Grade

Cable, Main European

Gigabit Ethernet Cable

Intel Pro 1000GT NIC Card

Immediately upon receipt, inspect the shipment and its contents against the Delivery Note enclosed with the shipment for evidence of damage or missing components. Save all shipping containers in case a return is warranted. If there is any discrepancy, please call the PaxScan Service Center at (800) 432-4422 or (801) 972-5000.

## Intended Use

The PaxScan<sup>®</sup> 2530C is specifically designed to deliver real-time x-ray imaging with high sensitivity and optimal image quality at a maximum 30fps over a wide range of x-ray conditions. The small format of the PaxScan<sup>®</sup> 2530C is ideal for both panoramic and 3-D dental applications, specific industrial applications, as well as micro-focus applications.



**PLEASE READ THIS ENTIRE MANUAL BEFORE USING. PRIOR TO USING PLEASE READ AND UNDERSTAND THE WARNING, PRECAUTIONS AND ADVERSE EFFECTS RELATING TO THIS DEVICE.**

## Safety Warnings, Precautions and Contraindications

The PaxScan 2530C is designed to be integrated into a complete X-ray system by qualified system integrator. The system integrator is responsible for obtaining FDA clearance for medical use.



### **Important:**

No part of the PaxScan 2530C is intended to be attached to a patient and/or to contact the patient.

The closeness of the Receptor to the patient is dependent upon the application by the system integrator.

All parts of the PaxScan2530C are suitable for use within the patient environment.



### **Warning:**

The 2530C is not intended to be used as a primary barrier to X-rays. The user is responsible for insuring the safety of the operator, bystanders, and the subjects being radiographed.





**Warning:**

The metal enclosure of the 2530C must be connected to earth ground.



**Warning:**

The equipment is not suitable for use in the presence of a flammable anaesthetic mixture with air, oxygen or nitrous oxide.

**Explanation of Symbols**



On (power: connection to the mains)



Caution / Warning / Important: Describes action or conditions that could result in equipment damage, data loss, or personal injury



Protective Earth Ground



Alternating Current



Off (power: disconnection from the mains)



Direct Current



Handle With Care



Indicates step-by-step description of the respective function follows



Useful / Important information

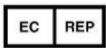

Authorized Representative in the European Community/European Union



Manufacturer



Consult Instructions for Use

## Getting Started

### System Overview

In medical application, the function of the 2530C FPD is to absorb the x-rays that pass through the patient's anatomy, and to convert those X-rays into a digital image. X-rays are absorbed by the Receptor and converted to raw digital data. The raw data is normalized for offset and gain variations pixel-by-pixel in the Virtual Command Processor (VCP) software application packaged provided with the FPD. The VCP performs all the interface functions with the FPD; such as, communication and respective calibration. The VCP also interpolates the value of any pixels identified as defective. These corrections are accomplished in "real-time" and there is no frame delay in the data stream from the Receptor through the VCP. A multi-output power supply provides all the power required for the FPD.

Figure 1-0 shows the configuration of the Receptor in the context of the overall imaging system. The dimension for receptor is:  $18.46 \pm .03 \times 18.46 \pm .03 \times 1.48 \pm .03$ .

Figure 1-0 Imager Configuration

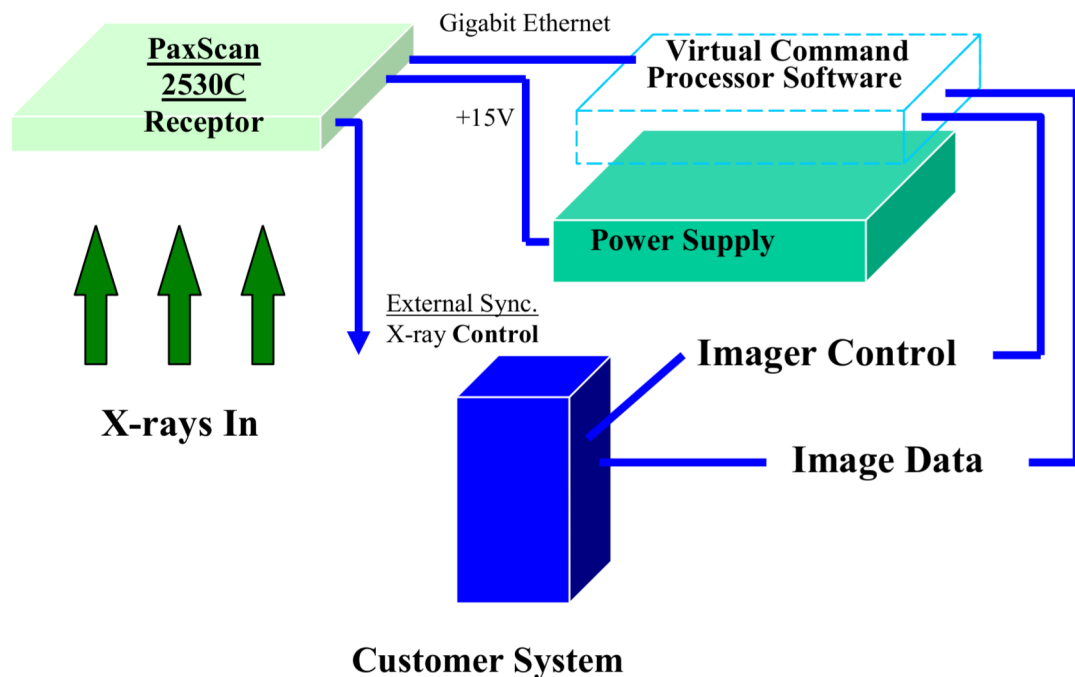

The Receptor operation is controlled using software commands via UART which use an Ethernet's link as physical layer. The set of possible Receptor control operations is supplied to systems integrators in a C++ library of callable functions, in the form of a Win32 DLL. The control of the Receptor is platform-independent

## Connecting the Cables

Connect the cables as described below in Table 1-0 and shown in Figure 1-0. ►

Table 1-0 Cable Connection Details

Step	Action / Description
<p><b>The Flat Panel Receptor includes a cable that terminates into two separate connectors: (a) Receptor Synch Connector to Generator Interface; and (b) the Power Supply Connector. Also included is an Ethernet connection cable. The connections are described below.</b></p>	
1.	<p><b>Receptor Synch Connection to Generator Interface</b></p> <p>This connector is intended to provide the user with a means to synchronize the end-user system-level application with the imager. This connector provides two opto-isolated signals connections , one configured for output and one for input. The output signal named “Expose OK” indicates when the receptor is ready for the generator to produce X-rays and the input named “User Sync” allows the user to trigger the panel readout. See Appendix A, diagram 1.0 for “Expose OK” and “User Sync” signal schematic.</p>
2.	<p><b>Power Supply - (optional)</b></p> <p>This connection provides power to the receptor. Connect the power supply connector to receptor then plug into the main AC supply.</p>
3.	<p><b>Gigabit Ethernet Connection</b></p> <p>Connect the Ethernet connector to a gigabit capable interface in the user’s host computer. The eBus Universal driver may be used in conjunction with any Ethernet adapter. Alternatively to use the High Performance driver, please note that the interface must use the Intel PRO/1000MT or Intel PRO/1000GT Ethernet adapter and Varian supplied driver. An optional Intel PRO/1000GT adaptor PCI-board (PN 23872) is also available from Varian</p>



### Note:

The X-Ray Generator Interface is user supplied equipment.



### Warning:

The Receptor should be mounted onto user supplied equipment using the holes provided in the integral flange.

Figure 2-0 Cable Connection

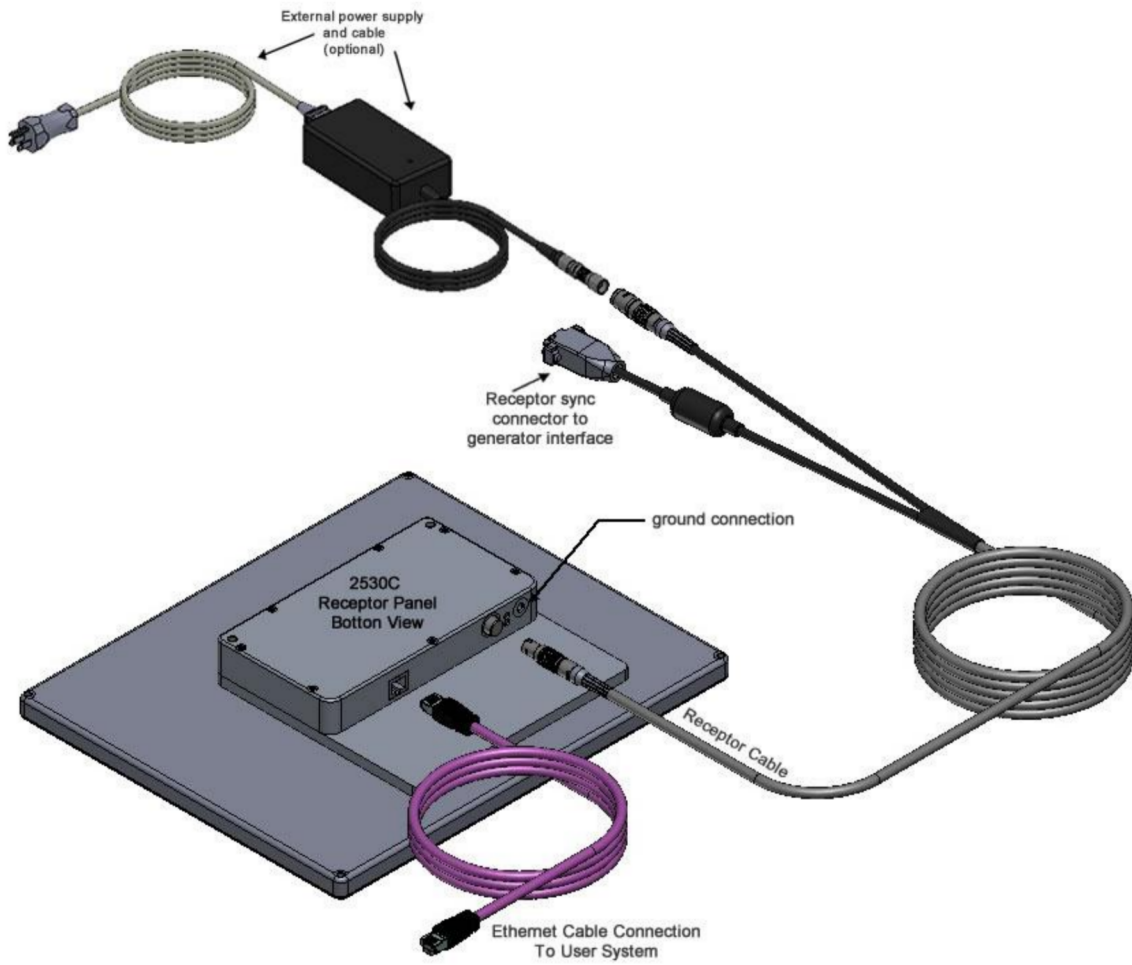
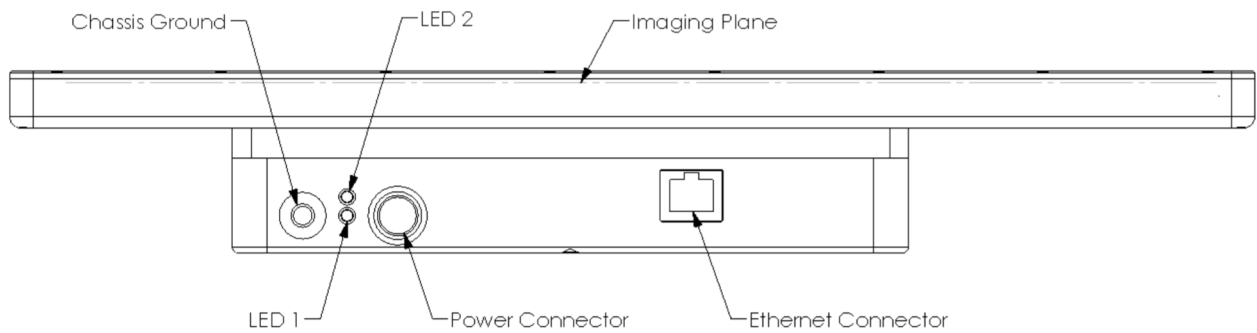

Figure 2-1 LED Status Indicators



The Ethernet port is a GigE port for connection to the workstation. The Ethernet port is a GigE port for connection to the workstation.

LED1 is an indicator that power is applied. If user sync is applied, this LED will blink at the user sync frame rate.

LED2 flashes at the receptor acquisition frame rate. If internal sync is selected, then the LED will flash at the internal sync frame rate. If user sync is selected, then the LED will flash at the user sync frame rate (should match LED1 rate).

**Caution:**

Accessory or optional equipment connected to the analog and digital interfaces must be certified to the respective IEC standards (i.e., IEC 60950-1 for data processing equipment and IEC 60601-1 for medical equipment). Furthermore, all configurations shall comply with the system standard IEC 60601-1-1. Anyone connecting additional or optional equipment to the signal inputs or signal outputs as part of a configuration for medical equipment is therefore responsible for compliance with the equipment standard IEC 60601-1. If in doubt, consult our technical support personnel.



**Warning:** The receptor is not sealed against dripping moisture.



**Warning:** Precautions should be taken to not open the receptor module. Depending upon the type of scintillator used, opening the receptor module may expose the user to potentially toxic materials.

## Paxscan System Software

There are two CDs supplied with this product. The Software CD allows installation of the Virtual CP that provides the Application Program Interface (API) to the receptor, allowing control and image transfer functionality; see the Virtual CP Interface document for more information. The Software CD also includes ViVA™ software which is the viewing application used to perform detector calibration, detector set-up, image acquisition, and image corrections in a Windows PC environment. NOTE: ViVA™ is intended to be used for development, testing, and maintenance purposes only. ViVA™ includes file translators for saving image files in .viv, .raw, .jpg, .bmp file formats and is Windows® 7 compatible. A Software Developer Kit (SDK) including sample code is located in the default install directory:

c:\ProgramFiles\Varian\PaxscanL07\DeveloperFiles

The Receptor software CD is specific to the panel providing calibration and configuration files. Installation of the *Software* and *Receptor* files is briefly discussed in the following sections. Refer to the ViVA Online help for assistance operating ViVA™ and for complete details on software installation refer to VCP Install Guide documentation included in the software CD.

## Software Installation

The Setup.exe in the root directory of the PaxScan CD provides an automated software installation process. Setup.exe automatically launches the L07 installer when the CD is inserted into a CD drives unless the Auto-Run CD option is turned off. ►



### Note:

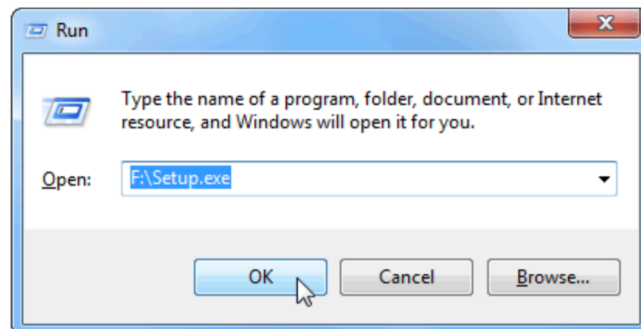

For manual installation use the run command and follow through appropriately.

Step	Action / Results
------	------------------

1. Launch of the L07 installer may display the below two screen shots prompting start of software installation – follow through appropriately.

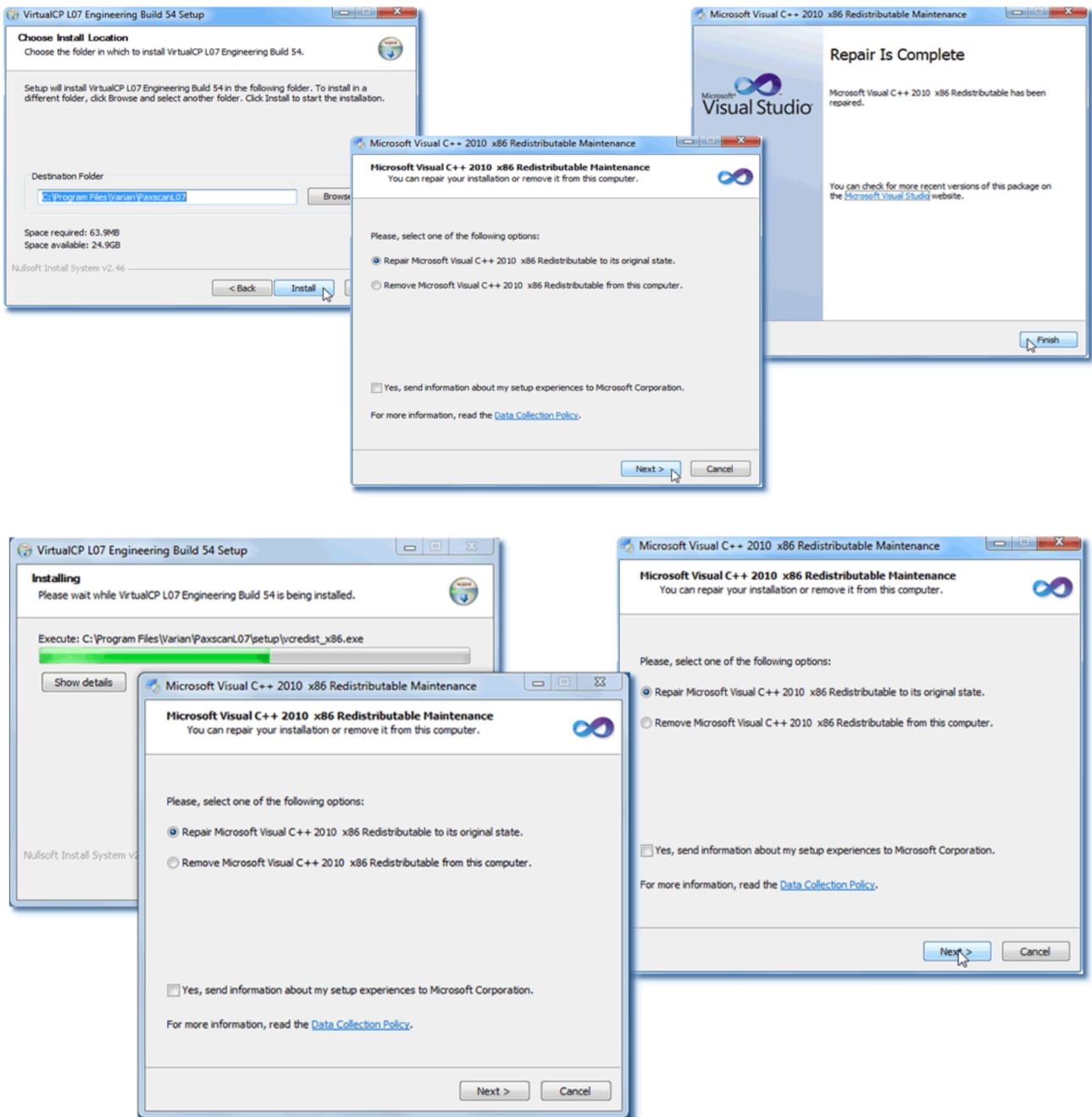

Step	Action / Results
------	------------------

- The software installer will prompt as to whether you want to update the calibration files – IMAGERS directory. click “No” unless you have previously used L01, L02 or L03 with the calibration files. *Refer to the VCP Install Guide documentation included in the software CD for complete details regarding software installation.*

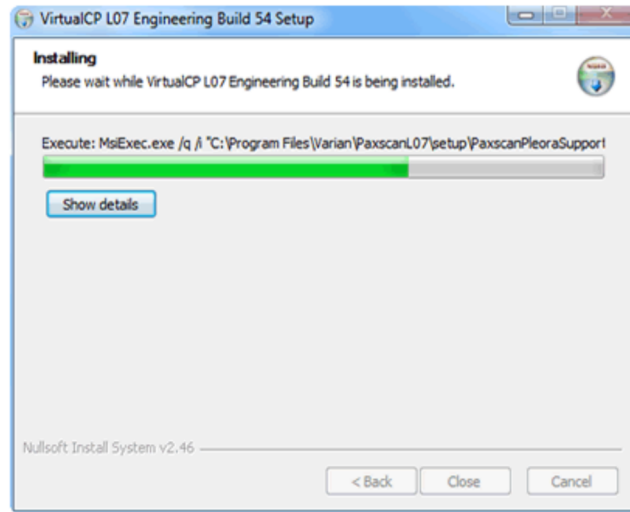

- If you see a Windows security dialog such as the one below, click “Install”.

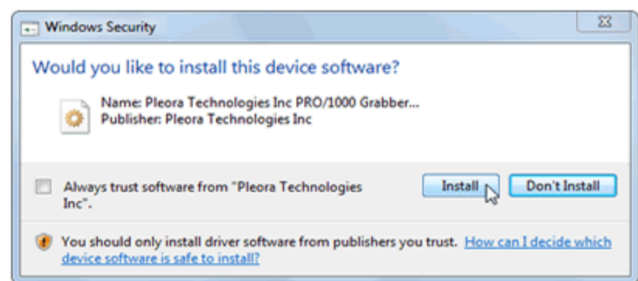
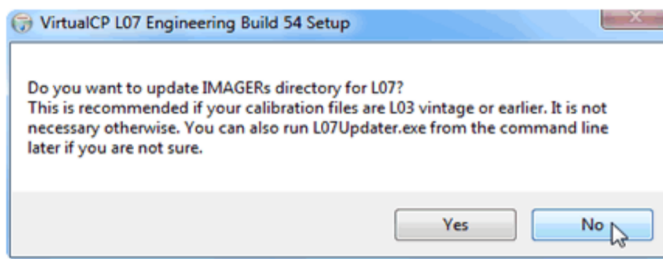



Step	Action / Results
------	------------------

4.

Select the *Intel Pro/1000 MT Desktop Adapter* from the list of adapter options **and** select the *High performance IP Device Driver* from the dropdown. If an adapter not supported by the High Performance driver is in use, select the eBus Universal driver from the dropdown.

Select “Do Nothing” from the dropdown for the other adapter listed as shown in the below screenshots. Finally – click “Install”.

**Important:**

Pleora detects what Ethernet adapters are present and by default selects the 'Do Nothing' for all.

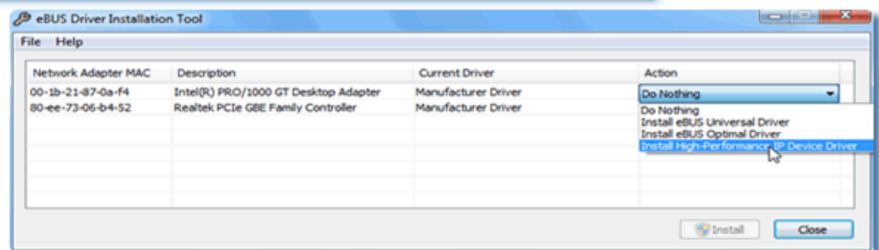
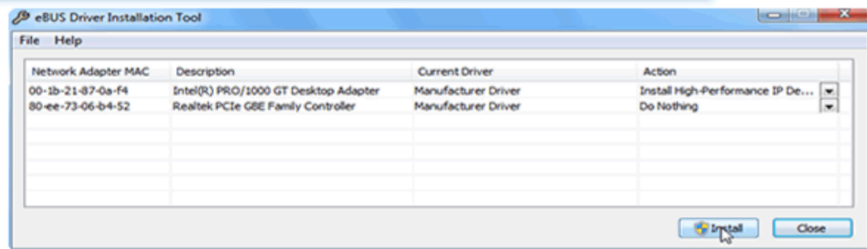
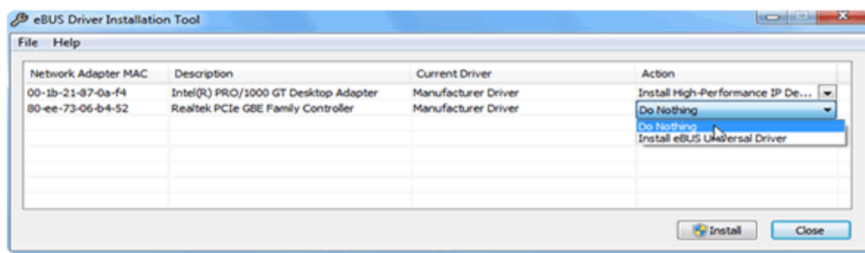

## Step

## Action / Results

5. When installation is complete reboot the computer if it does not do so automatically.

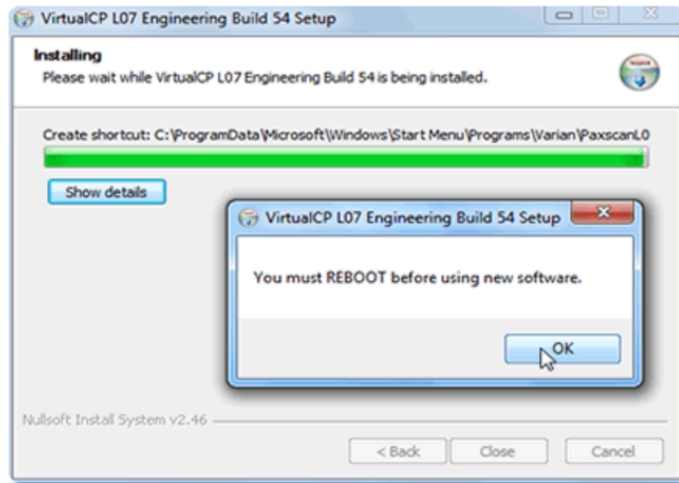

*A WORD ABOUT DRIVERS* → Previous versions of L07 as well as any previous versions of the Pleora High Performance drivers must be removed before attempting to install L07. Assure removal of previous L07 versions by running appropriate uninstaller from the control panel. In addition, if L05 or L06 installs exist with an earlier version Pleora driver, this must be removed by running the uninstall of 'PaxscanPleoraSupport' from the control panel. If L04 was installed previously, then the Pleora driver must be removed manually by running the Pleora driver tool or downloading and installing the manufacturer's driver.

**Note:**

If the L07 installer is run without removing any prior driver version, it will run to completion with apparent success, but VCP (Virtual Control Panel) will not open a receptor link; it will generate a driver version error as shown by the below screen shot. In this case, run the L07 uninstaller; the L07 uninstaller will remove the driver including any older versions. Then re-install L07.

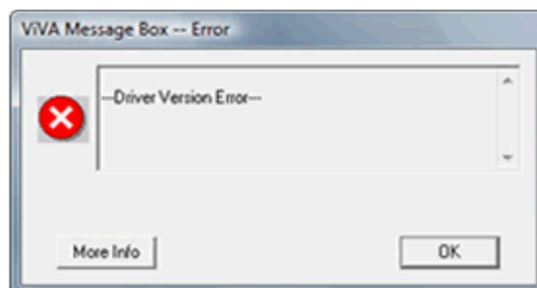

## Receptor Files Installation

Follow through the install screens to complete the PaxScan Receptor installation. You must restart your computer for installation to take effect. ►

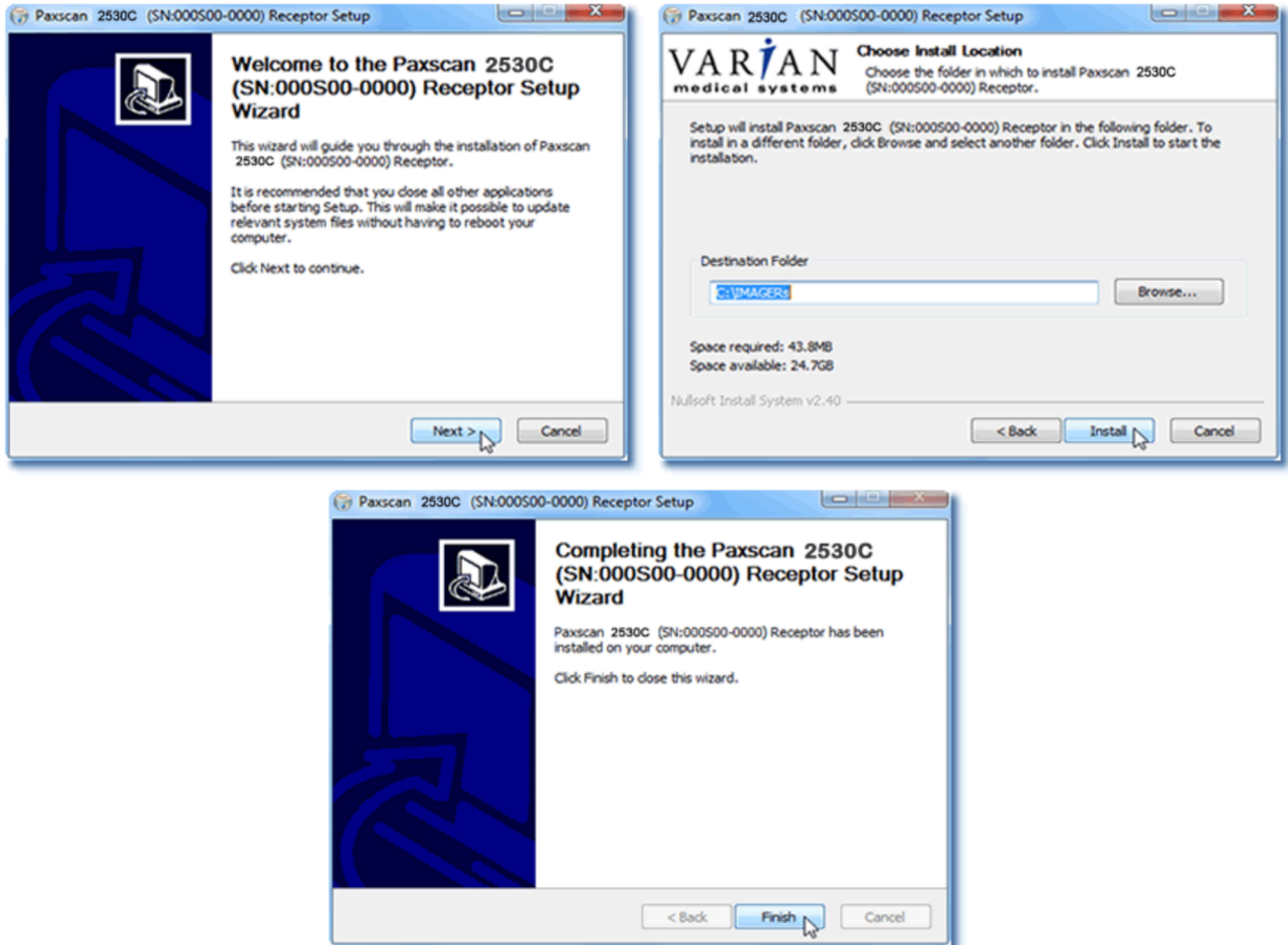

**Modes of Operation**

The PaxScan 2530C one modes of operation as defined in Table 2.0. In general, there is a tradeoff between varying gain and signal capacitance. Any combination can go into the one mode of operation to match the sensitivity of the imager is optimized to match the X-ray dose used in each mode.

The purpose of each mode is to configure the detector to achieve optimal performance during specific imaging procedures. Modes are defined by a combination of factors, such as pixel binning, frame rates, analog gain, field-of-view, and continuous versus single acquisition. Each mode requires a unique set of calibration files. Refer to the ViVA Online help documentation for complete details.



**Note:**

The system can only be in one mode at a given moment.

Not every mode will be available with every system. The OEM should work with PaxScan technical support for configuration of the mode(s) which best suit the customer’s intended application.

**Table 2-0 PaxScan 2530C Operational Mode**

Mode	Max Frame Rate (Hz)	Pixel Binning	Gain/ Capacitor	Image Area	Frame Size	Active Frame Size	Acquisition Type
Low Speed Fluoroscopy	1	1x1	2pF VG1	Full Field	2176 x 1792	2156 x 1772	Fluoroscopy



**Note:**

There are a wide range of gains and feedback capacitor selections that can be tailored to fit your application. Please contact Varian for details.

## Default Mode

Mode 0 is the default, although this can be configured to meet the customer's specific application requirements. The default mode will be invoked automatically upon system power-up when a link is opened or receipt of a reset state command. ViVA will normally remember the last mode used and select it for future launches.

## Operation States

The operational states of the imager can be categorized as follows:

- **Offset calibration:** (always OEM-initiated)
- **Gain calibration:** (always OEM-initiated)
  
- **Continuous acquisition:** (low speed fluoroscopy-type)

## Calibration Procedures

### Offset Calibration

Prior to acquiring images, an offset calibration must be performed for each mode you intend to use. Offset calibration compensates for fixed pattern pixel intensity variations in the image, associated with the dark current and electronic offsets. The Offset reference image is an average of a series of frames acquired without X-ray illumination and referred to as dark fields. ►

- Offset calibration should not be performed during X-ray.
- The X-ray-to-digital conversion factor does not change as a result of calibration.
- An offset calibration should be performed as often as necessary for acceptable images in the application the receptor is being used in. The offset varies as a function of panel temperature and frame rate.
- A different offset reference image is necessary for each operating mode, therefore it is important to update the offset data for each of the operating modes.

Step	Action / Results
1.	To perform offset calibration, click the <i>ViVA</i> icon  launches the application.



Step	Action / Results
------	------------------

- Select the *Link to Virtual CP (VCP)* option under Acquisition from the menu bar or the *Link / Mode* drop down box. The main purpose of the VCP is to establish connection to the PaxScan imaging system to control the acquisition of digital images captured.  
Note: After applying power to the receptor, please wait 6 seconds for the FPGA to initialize before opening the link.
- Then, select desired Mode from the *Link / Mode* drop down box: The 2530C supports a number of Fluoroscopy modes of operation as defined in Table 2.0 and shown in below screenshot.

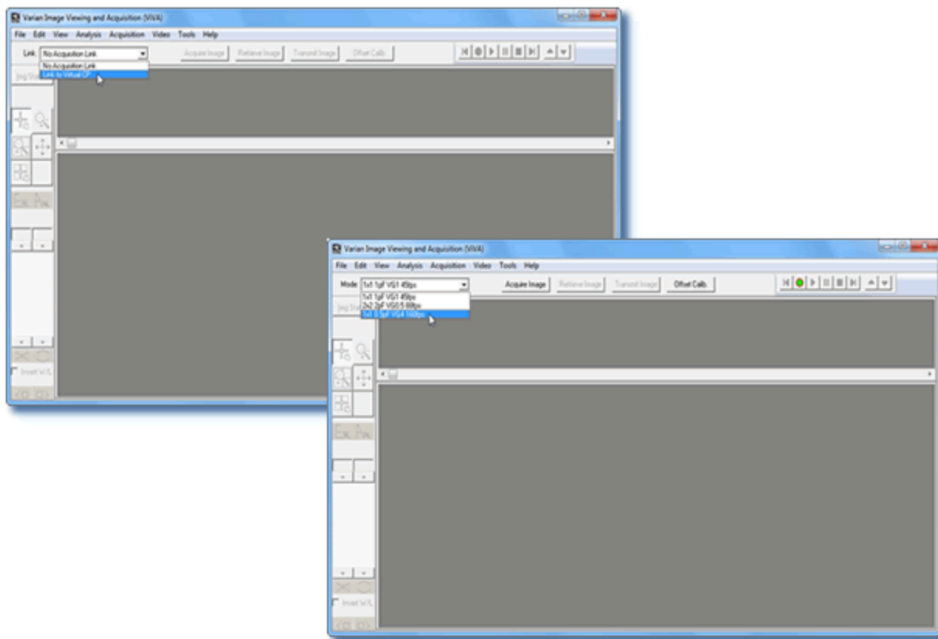
**Note:**

It is recommended that a delay of at least 20 seconds be allowed after an X-ray exposure, before commencing with offset calibration. Since there is some inherent lag in the detector, this delay avoids introduction of a latent image into the offset reference image.

Step	Action / Results
------	------------------

- Click Offset Calibration button or select from the menu bar under Acquisition.

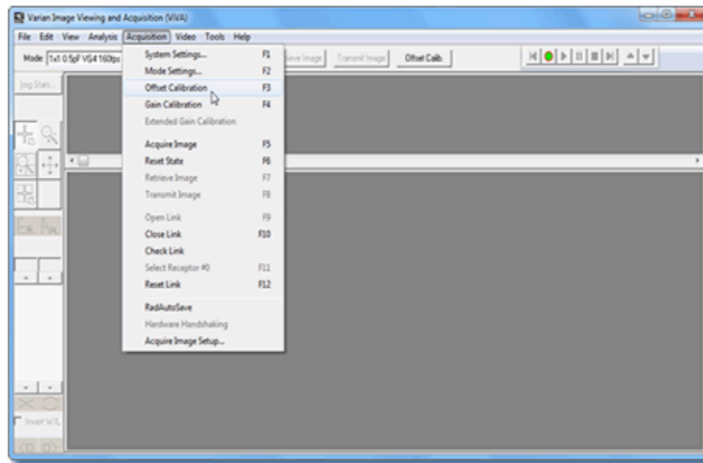

- An accumulating Dark Frames window appears followed by an offset calibration acquisition completion. Offset calibration is required for each additional receptor, respectively.

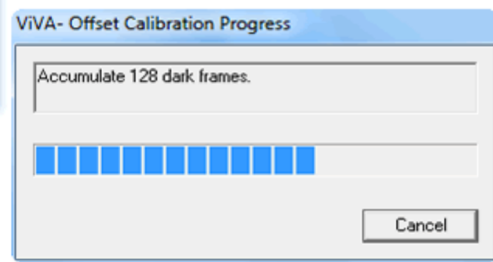
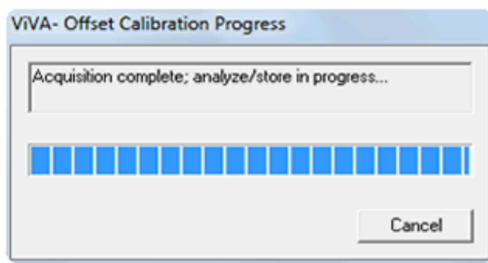



## Gain Calibration

To compensate for non-uniformities in the Receptor, a gain reference image (flat field) is used by the Corrections module as required to correct all images. The flat field image must be captured by the Virtual Command Processor (VCP) prior to acquiring images. The process of capturing the flat field image is known as Gain Calibration.

Gain calibration is based upon the linear response of the Receptor to dose. Normalization is achieved by applying the flat field image acquired during the Gain calibration to all images corrected by the VCP. Normalization will fail with pixels that are responding to dose in a non-linear manner. Pixels responding to dose in a non-linear manner are usually caused by the saturation of the Receptor, or a low signal-to-noise ratio.



### Note:

It is critical to acquire the flat field image within a range that is large enough to be higher than the background noise created by the X-ray source and readout electronics of the Receptor, but lower than the saturation point of the imager.

Flat field images acquired near or exceeding the saturation point will cause normalization failures with all images acquired until a Gain calibration with the correct dose is performed. We recommend that flat field images be acquired with a median count of 8,000 – 16,000. This range will ensure that Gain calibration will meet both the upper and lower dose requirements under all modes of operation. Dose requirements are determined by the settings of the generator X-ray source.

To reduce the effects of noise, the average of each pixel in the flat field image is calculated by accumulating a number of frames into an internal memory buffer, then dividing the sum of each pixel by the number of frames acquired.



### Note:

Using larger numbers of calibration frames to capture the flat field image will result in more accurate calibration.

The number of calibration frames used during Gain and Offset calibrations can be adjusted under the *Mode Settings* pull down menu. We recommend accumulating a minimum of 32 frames.

The general procedure for Gain calibration for all modes is as follows in Table 3-0 and described below. Detailed instructions on performing gain calibrations are covered in the ViVA Online help documentation.

**Table 3-0 Gain Calibration: All Modes**

Step	Action	Results
1.	Warm Up	To ensure proper warm up, the PaxScan 2530C Receptor must be operational for a least two (1) hours prior to Gain calibration. Operational means that the receptor is powered up and the link is open. The receptor runs at a decreased power level until the link is opened.
2.	Radiation	A uniform flat field with no object in the path of the X-Ray beam. The radiation should ideally be at a level and technique representative of the typical radiation dose for the Receptor during typical procedures, keeping in mind general consideration outlined above.  Note: The exact level of the radiation during calibration will not influence the calibration as long as the signal level is not saturated.
3.	Offset Calibration	Software automatically performs a new Offset calibration referred to as dark field acquisition.  Note: X-Rays <i>must not be used</i> for this part of the calibration.
4.	Repeat	The above procedure must be repeated for each of the stored imaging modes.

## Low Speed Fluoroscopic Mode Gain Calibration

Take the following steps to complete fluoroscopic gain calibration. ►

Step	Action / Results
------	------------------

1. Ensure the desired receptor and imaging mode appears in the *Link Mode* drop down box.
2. Select Gain Calibration from the menu bar under *Acquisition*
3. Remove all objects from beam, initiate X-ray exposure, then press “Continue”.

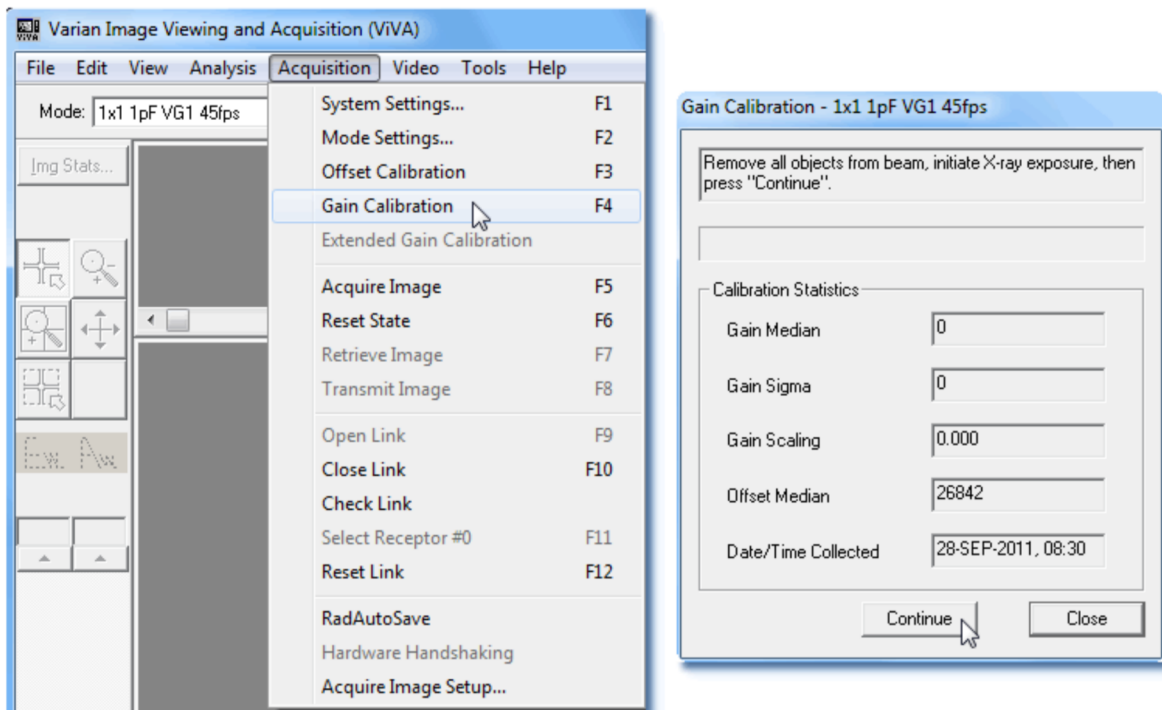

Step	Action / Results
------	------------------

- The imager will now begin acquiring Flat Field images.
- With Flat Field accumulation complete, terminate X-ray beam, wait 20 seconds, and press “continue”.

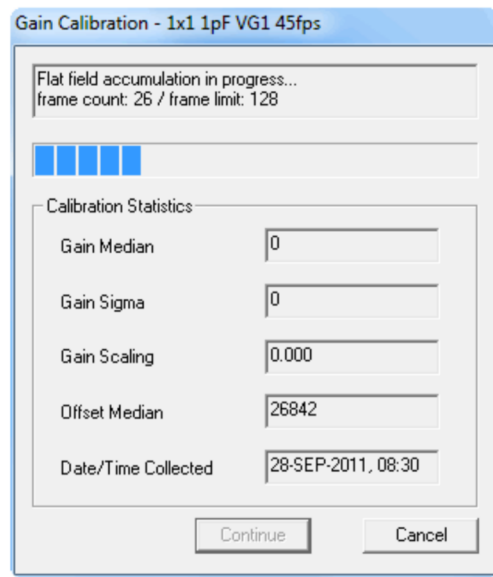

Step	Action / Results
------	------------------

6. Dark field accumulation begins with progress status shown in the display window.

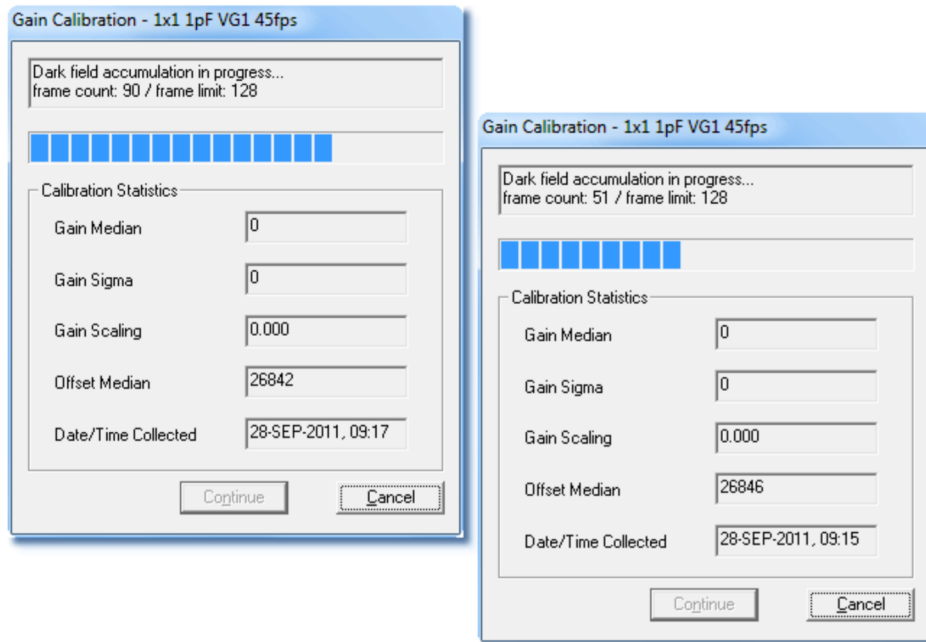

7. Low Speed Fluoroscopic gain calibration completes with display of the gain calibration statistics. Gain median count should be around 12000 +/- 4000 as shown in below screenshot.

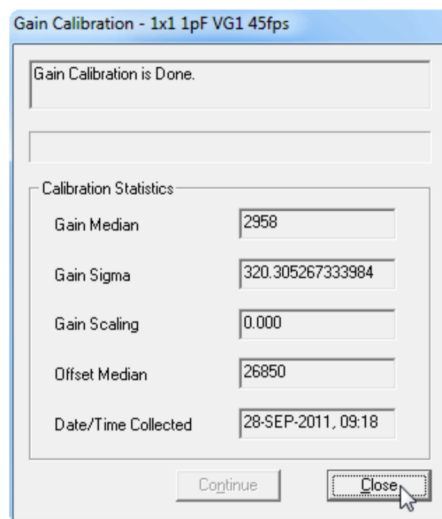

**Important:** *Points of note about low speed fluoroscopic Gain calibration:*

- If the median value is higher than 16,000, the dose used needs to be decreased and the gain calibration repeated.
- If the median value is lower than 8,000, the dose needs to be increased and the gain calibration repeated
- Gain calibration should be performed at regular intervals, typically once every three (3) months, or whenever the central beam of the X-ray source has been moved relative to the Receptor.
- Replacement of the X-ray tube will require a new gain calibration to be performed.
- We recommend accumulating a minimum of 32 frames for gain calibration for optimal image quality. However, the actual number of calibration frames used must be determined solely by the system integrator depending upon their specific performance requirements.

**Note:**

For additional assistance operating ViVA<sup>™</sup>, use the ViVA Online help documentation.

**Note:**

*Operator Control* is user supplied equipment.

## ViVA Mode Settings

The calibration and system settings are verified as follows. To view these settings take the following steps. ►

- | Step | Action / Results   |
|------|--|
| 1.   | Make sure the link to the VCP is established and desired receptor is selected from the <i>Link / Mode</i> drop down <i>box</i> .   |
| 2.   | Select <i>Mode Settings</i> from the menu bar under <i>Acquisition</i> to make adjustments to Calibration settings. Frame Rate settings are changeable. If the User Sync is checked, the user must supply an external trigger which determines the frame rate. |

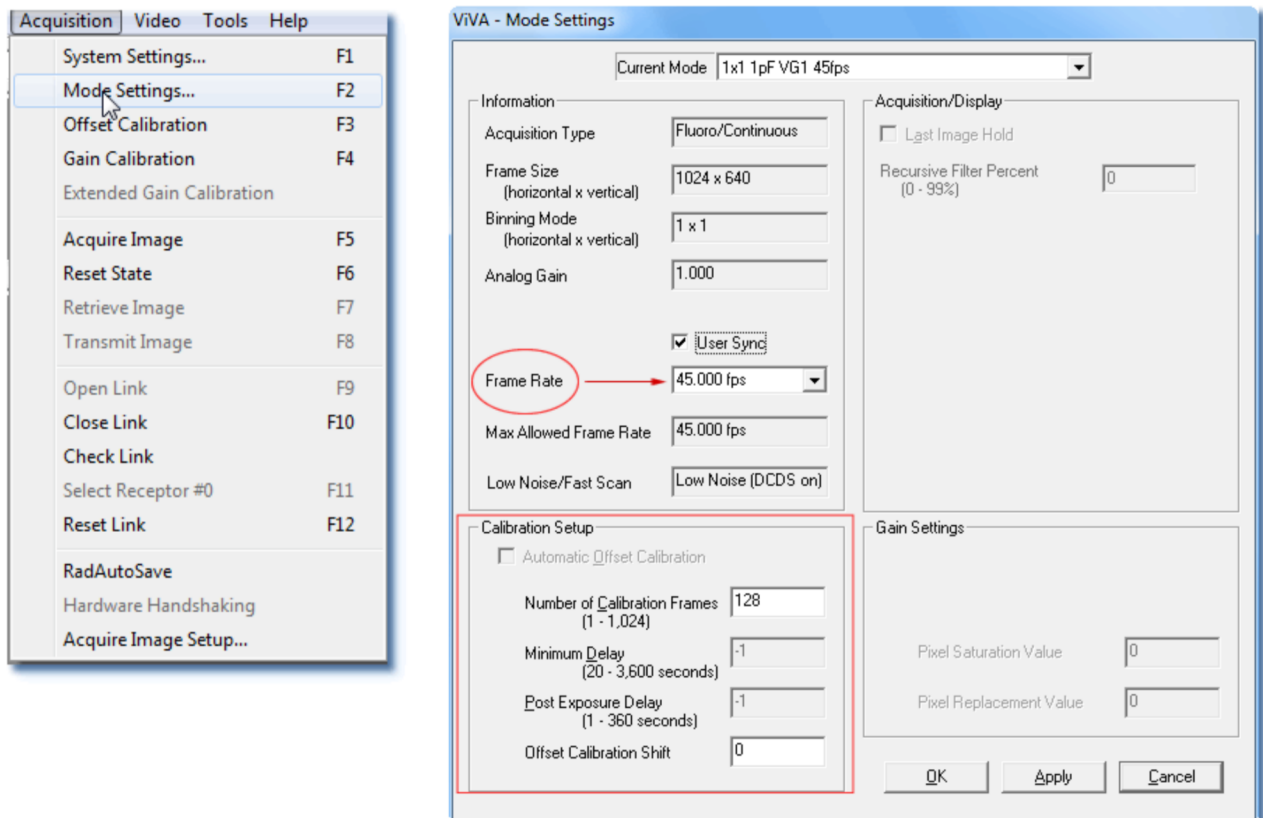

Step	Action / Results
------	------------------

- System settings are verified as follows. Select system settings from the menu bar under *Acquisition* which will bring up a dialog box. On the left side of the dialog box, unchangeable information about the system is displayed. On the right side are *Image Correction* settings. These check boxes allow the user to select which image correction algorithms are applied.

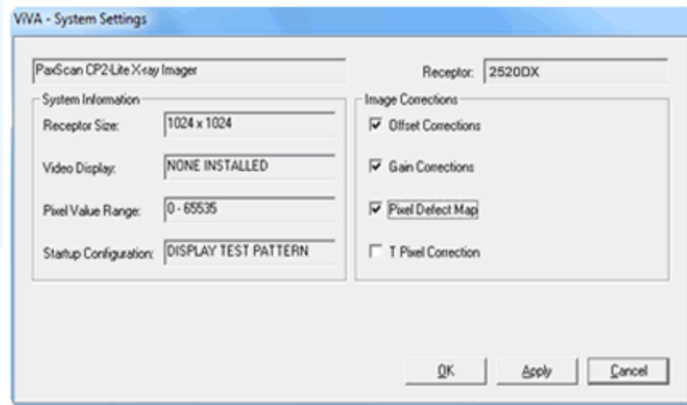
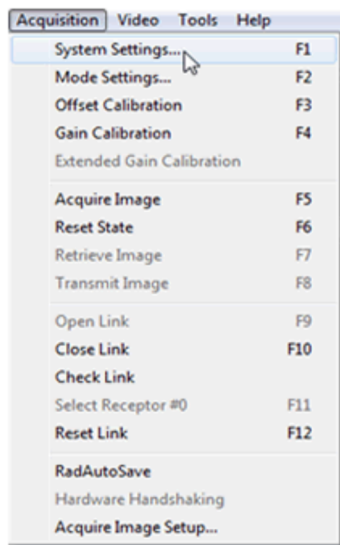



## Image Acquisition

Once Offset and Gain Calibration is performed, you are ready to acquire images.

### Low Speed Fluoroscopy Mode

The low speed fluoroscopy mode is commonly used for its ability to provide low frame rate serial acquisitions. ▶

Step	Action / Results
------	------------------

1. Select desired mode from the *Link Mode* drop down box.
2. Make sure hardware handshaking is unchecked.

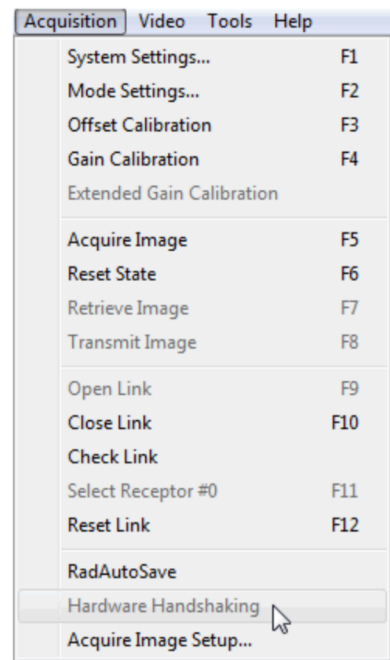
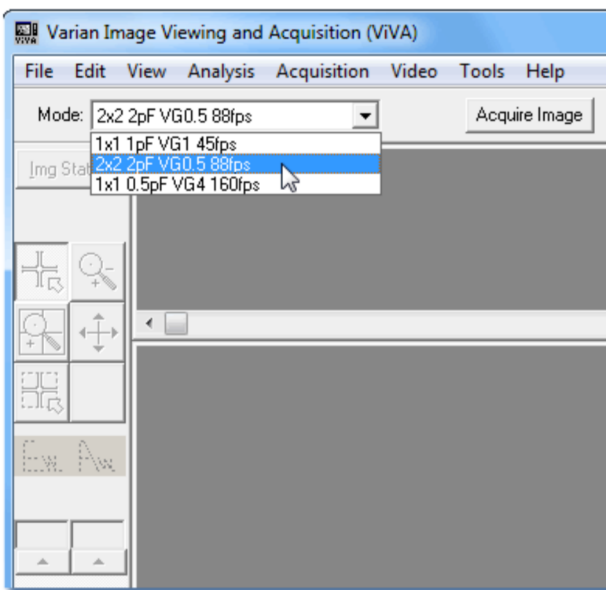

Step	Action / Results
------	------------------

3. Select the *Acquire Image* button or the green radio button on right invokes imager to begin acquiring images.

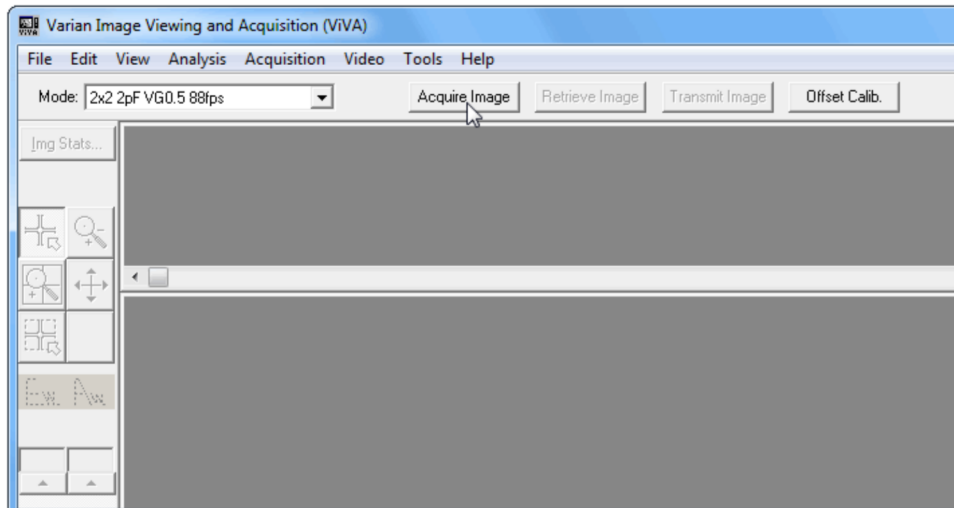

4. Upon first acquisition the following two windows will appear — the first one provides buffer allocation information and the other an area for user comments. Select the ok and cancel button, respectively to continue.

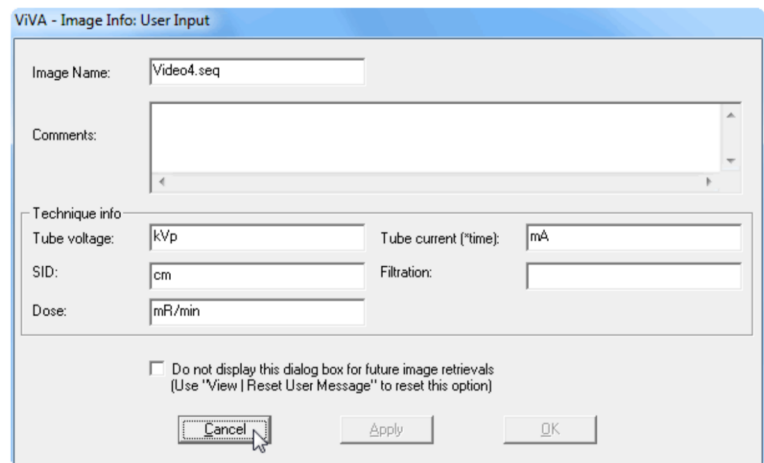
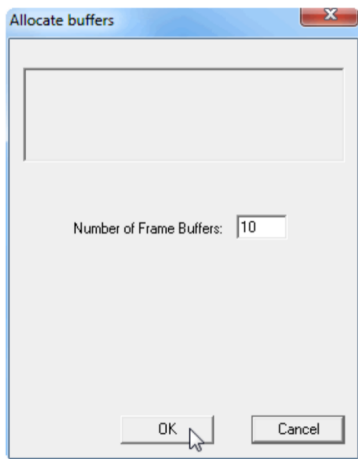

Step	Action / Results
------	------------------

5. Following the acquisition the below window will appear providing active image capture data.

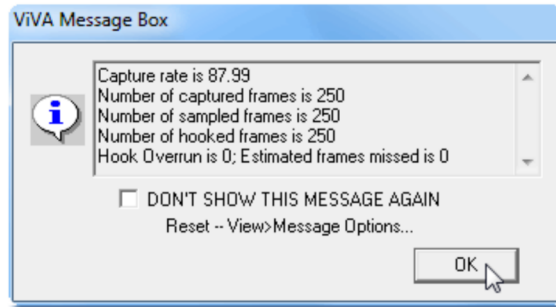

6. Acquired image can be saved in the *seq/avi* file format by selecting File / Save As.

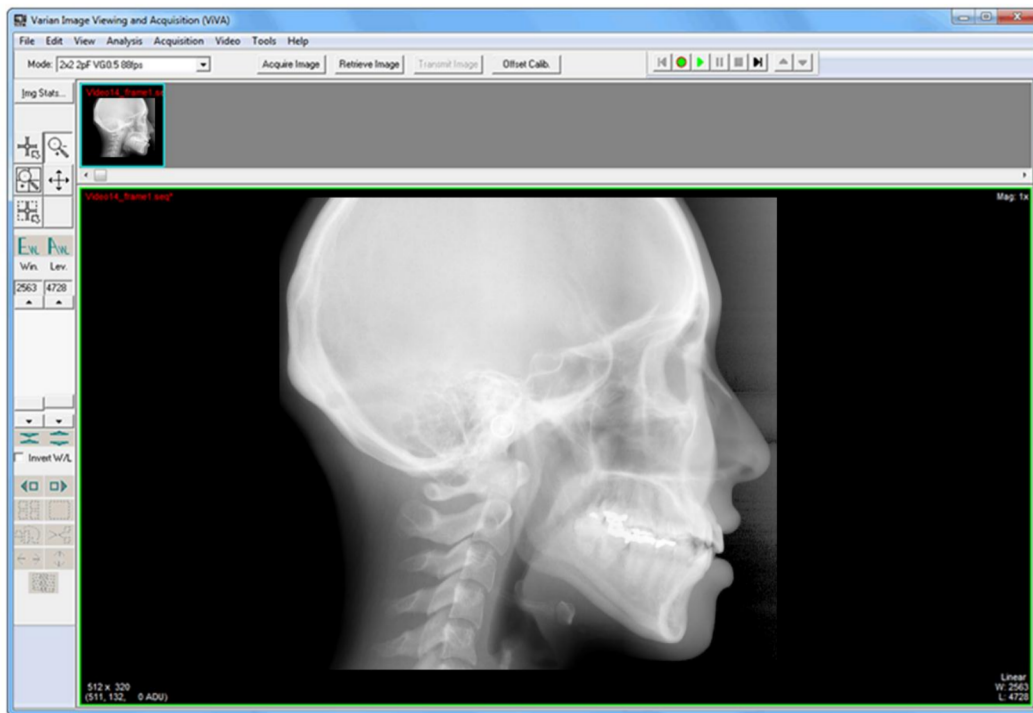

## Safety

### Electro-Magnetic Interference

This equipment generates, uses and can radiate radio frequency (RF) energy and, if not installed and used in accordance with the instructions, may cause harmful interference to other devices in the vicinity. In any and all circumstances; however, there is no guarantee that interference will not occur in a particular installation. If this equipment does cause harmful interference to other devices, which can be determined by turning the equipment off and on, the user is encouraged to try to correct the interference by one or more of the measures listed in the **Troubleshooting** section.

### Electrical Shock Protection

- External Power Supply Specification - (optional):
  - type: XP Power model AHM85PS15, ratings: Input Voltage 100 – 240V, Input Frequency 50-60Hz, Input Current 1.5 A, DC Output 15V
- Panel electrical rating if the power supply is not provided with the unit:
  - Continuous power rating is: 17 Watts
  - Input voltage is: 13VDC – 32VDC

### Environment Conditions

Storage/Shipping Temperature:	-20° C to +70° C ambient
Storage/Shipping Humidity:	10 to 90% RH non-condensing
Operating Temperature (measured at center back cover):	10 to 35° C
Operating Humidity (non-condensing):	10 to 90% RH

Rigorous environmental testing is conducted on an engineering basis using a sample imager

### Altitude Limits

The Paxscan Digital Imager Receptor is rated to operate at an altitude  $\leq 3000\text{m}$ .

## Regulatory

- The PaxScan® 2530C is an associated equipment x-ray medical equipment with respect to electrical shock, fire and mechanical hazards only in accordance with UL 60601-1 Medical Electrical Equipment, Part 1: General Requirements for Safety 1<sup>st</sup> ed., IEC 60601-1, IEC Medical Electrical Equipment Part 1: General Requirements for Safety 2<sup>nd</sup> ed., IEC 60601-1 Medical Electrical Equipment Part 1: General Requirements for Basic Safety and Essential Performance 3<sup>rd</sup> ed., ANSI/AAMI ES60601-1 Medical Electrical Equipment, Part 1: General Requirements for Basic Safety and Essential Performance 1<sup>st</sup> ed., CAN/CSA-C22.2 NO. 601.1-M90, 2005 Medical Electrical Equipment Part 1: General Requirements for Safety, and CSA-C22.2 No 60601-1 Medical Electrical Equipment, Part 1 General Requirements for Basic Safety and Essential Performance 2<sup>nd</sup> ed., EN/IEC 60601-1-2 Medical Electrical Equipment Part 1-2: General Requirements for Basic Safety and Essential Performance – Collateral Standard: Electromagnetic Compatibility 3rd ed.
- Class I – does not contain any applied part
- **CE Mark** - Varian Medical Systems' imaging products are designed and manufactured to meet the Low Voltage Directive 2006/95/EC and MDD 93/42/EEC.
- A Declaration of Conformity has been filed for this product and available upon request by contacting Varian Medical Systems - X-Ray Products.

## Maintenance

### Cleaning and Disinfection

The flat panel receptor and connected cables are likely to be soiled during use. The specific material most likely to become soiled is the X-ray grade carbon fiber input window and aluminum housing.

Cleaning and disinfecting of the input window should be performed as needed.

Wiping the surfaces with a soft cloth dampened with soap and water will generally clean the surfaces.

Proper disinfection requires that a disinfectant solution be used; such as Sani-Cloth<sup>®</sup> Plus, a hospital grade, EPA registered low to intermediate-level product for hard, non-porous surfaces and equipment. Use disinfectants in accordance with the manufacturer's instructions.

### Repairs

**Note:**

No user serviceable parts. If repairs are necessary, please see *How To Reach Us*.

The least replaceable units (LRU) are:

- Receptor Assembly
- Main Power Cable

### Proper Disposal

The 2530C receptor should be returned to Varian Medical Systems for disposal. We request that you obtain an RMA number using the same procedure for warranty/returns of products.

Contact: PAXSCAN.RMA@VARIAN.COM

**Warning:**

Precautions should be taken to not open the receptor module. Depending upon the type of scintillator used, opening the receptor module may expose the user to potentially toxic materials.

## Troubleshooting

Problem	Solution
Imager fails to respond	1. Check cables.
Loss of communication between imager and software	1. Power cycle the imager by disconnecting the power supply and reconnecting. 2. Restart ViVA and reset the link.
Imager causes Electro-Magnetic Interference	1. Reorient or relocate the receiving device. 2. Increase the separation between the equipment. 3. Connect the other device(s) into an outlet on a different circuit. 4. Consult the manufacturer or field service technician for help.
Poor Image Quality.	1. Confirm that image corrections are all selected in the Systems Settings dialog box in ViVA . 2. Re-acquire gain and offset images. 3. Assure that the exposures are appropriate for gain calibration images (not saturated).
Software hangs up.	Restart ViVA and reset the link.
Acquired image is completely dark.	Increase the exposure and acquire a new image. If the image is still dark, verify that all cables are properly connected. Turn the power "OFF" and "ON". Acquire a new image.
Out of virtual memory.	Close some of the windows that are currently open.
Residual x-ray image from previous exposure shows in current image.	Charge on the sensor pixels from a super saturated exposure may cause a residual image. It can be erased by taking another image or multiple images without X-rays until the residual image is gone.
ViVA error message	1. Please complete PaxScan 2530C Problem Report. 2. Email the error log file generated to: <a href="mailto:paxscan.service@varian.com">paxscan.service@varian.com</a> . This log file is normally found at C:\Documents and Settings\All Users\Documents\DrWatson\drwtsn32.log

## How To Reach Us

In order to provide you with the most comprehensive technical support, (hardware or software), please complete the problem report on following page before contacting your Varian representative. If you prefer E-mailing the information to us, a .pdf version of this form is included on the CD you received with your system. You may also fax the completed form.

To speak with our technical support personnel:

- Call (800) 432-4422 or (801) 972-5000.
- E-mail the report to [paxscan.service@varian.com](mailto:paxscan.service@varian.com), or
- Fax a copy of the Problem Report to (801) 972-5023



**PaxScan 2530C Problem Report Customer Information**

<b>Date:</b>	<b>Your Name</b>	<b>Company/Unit Name:</b>
<b>Email:</b>	<b>Phone Number:</b>	<b>Fax Number:</b>
<b>Product Information.</b>		
<b>PaxScan Part Number: Imager Serial Number: Software Revision #:</b>		
<b>Operation I was trying to perform (be as specific as possible:</b>		
<b>What happened (use additional sheets as necessary):</b>		

Fax to: (801) 972-5050 or E-mail: [paxscan.service@varian.com](mailto:paxscan.service@varian.com)

**Appendix A**

The synchronization interface to the imager consists of one opto-isolated input signal and one opto-isolated output signal. Connection to these two signals can be made via the 8 pin LEMO connector on the imager or via 9 pin D-Sub connector on Varian cable Receptor Interface Cable.

The *User\_Sync* input is used to trigger imager readout if the imager is in User Sync mode (see chapter 5, Mode Settings). In order to activate this input the customer system needs to provide a current of at least 5mA ( $V_{in\_min} = 4V$ ) to the imagers opto-coupler input . Maximum forward photodiode current is 25mA ( $V_{in\_max} = 15V$ ,  $V_f$  is typically 1.2V).

<i>User_Sync</i> pulse duration	
pulse duration < 200 usecs	User Sync signal is ignored
Pulse duration > 200 usecs	Imager readout is activated and image data is transmitted via Ethernet

The panel readout is triggered on the falling edge of the user sync pulse. In normal mode the minimum user sync pulse width is 200 useconds.

The output from the imager is the *Expose\_OK*, signal which can be used to trigger the generator. Expose OK is active low (optocoupler on) when the panel is not being readout. In pulsed x-ray systems, the x-ray pulse should be delivered when Expose OK is active. The duration of Expose OK is (frame time- readout time). The readout time varies according to the mode. If the exposure pulse exceeds the Expose OK window, artifacts can result.

The maximum sink current for Expose OK is 50mA. Maximum  $V_{ceo}$  is 80 V. Maximum collector power dissipation is 150mW.

Figure A.1 Schematic for “User\_Sync” and “Expose\_OK” Signal

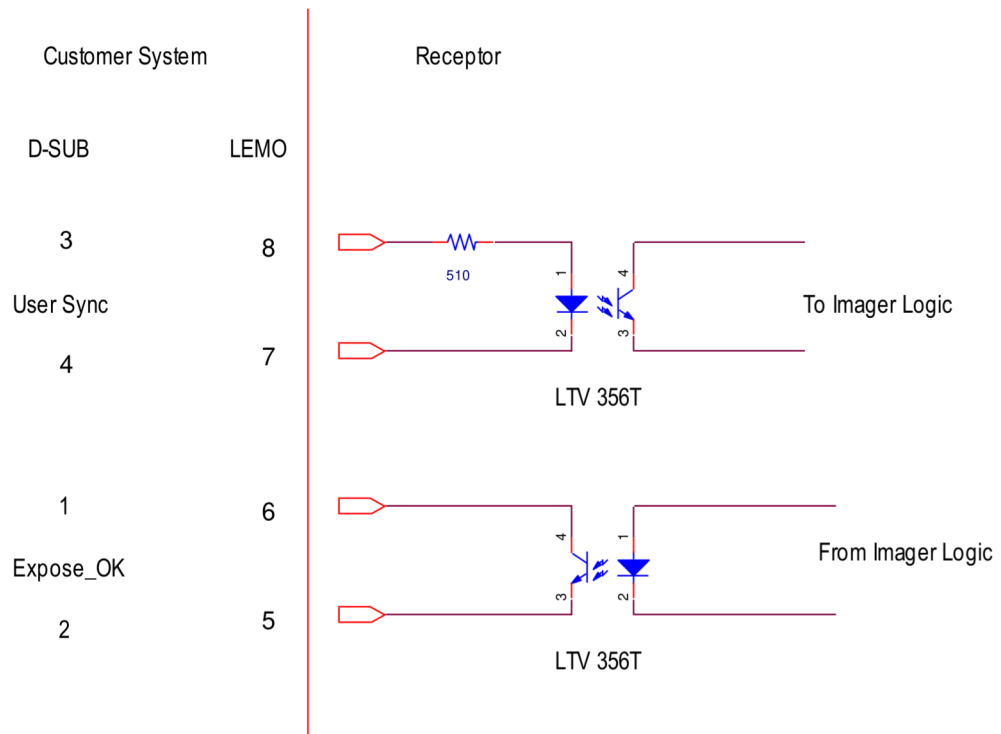
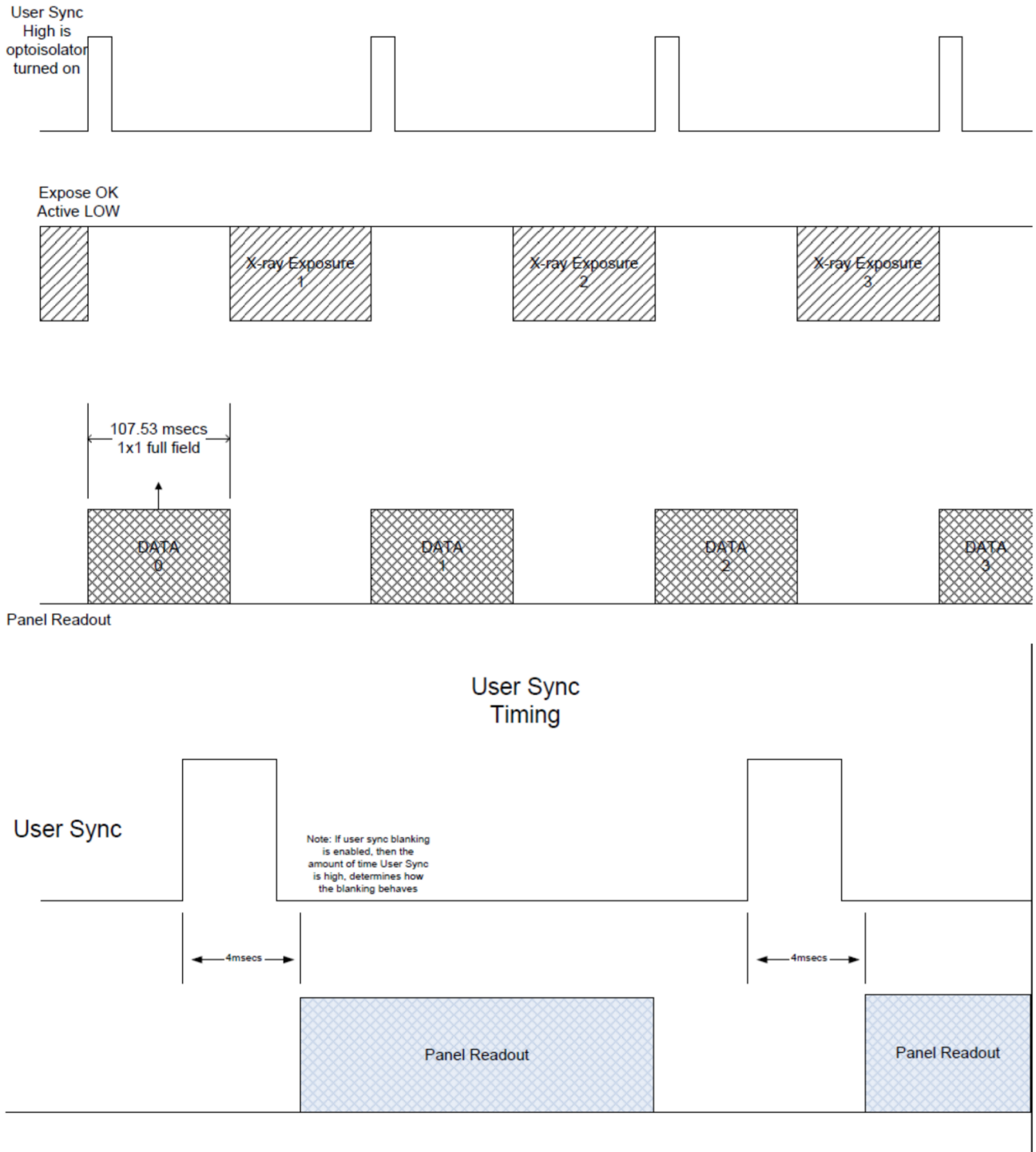

Figure A.2 2530C Timing Diagram



## Appendix B

### Diagnostic Data

The first 40 pixels of each image contains data that pertains to the image and the receptor. It is possible to monitor certain internal voltages, internal temperatures, firmware version, and frame count. The frame counter is a free running counter that increments with every frame start.

**Figure B.1 Diagnostic Data for 2530C**

Pixel Column	Register Name	16 bit data	Formula	Note
0	Start Sequence			
1	Start Sequence			
2	Start Sequence			
3	Start Sequence			
4	Start Sequence			
5	Start Sequence			
6	Start Sequence			
7	Start Sequence			
8	Protocol Mode			
9	Panel Type	1313DX=40 1515DX=41 2520DX=42 2530C=43		
10	Firmware revision and build	Bit 15~8=Revision Bit7~0=Build		
11	Frame Info	Not Used		
12	Frame Count	16 bit frame counter		Continuous counter
13	Board Serial Number LSW			
Pixel Column	Register Name	16 bit data	Formula	Note
14	Board Serial Number Middle Word			
15	Board Serial Number MSW			
16	Panel Temp Sensor 1			U48
17	Panel Temp Sensor 2			U49
18	Panel Temp			U50

	Sensor 3			
19	Panel Temp Sensor 4			U51
20	Panel Temp Sensor 5			
21	Panel Temp Sensor 6			
22	Panel Temp Sensor 7			
23	Panel Temp Sensor 8			
24	Voltage 1	1800-1900	$V=0.0006105*(ADC)$	1.2VD
25	Voltage 2	1650-1750	$V=0.0010175*(ADC)$	1.8VD
<b>Pixel Column</b>	<b>Register Name</b>	<b>16 bit data</b>	<b>Formula</b>	<b>Note</b>
26	Voltage 3	2100-2200	$V=0.001468*(ADC)$	3.3VD
27	Voltage 4	2700-2800	$V=0.001468*(ADC)$	M4VA
28	Voltage 5	1600-1700	$V=0.007329*(ADC)$	M12VA
29	Voltage 6	2100-2200	$V=0.003656*(ADC)$	7.8VRAW
30	Voltage 7	1650-1800	$V=0.009768*(ADC)$	17VA
31	Voltage 8	0	0	GND
32	Voltage 9	1900-2100	$V=0.002135*(ADC)$	4.5VRAW
33	Voltage 10	1600-1700	$V=0.003068*(ADC)$	5VA
34	Voltage 11	1650-1850	$V=0.004923*(ADC)$	AVGL
35	Voltage 12	1200-1500	$V=0.009768*(ADC)$	AVGH
36	Voltage 13	950-1050	$V=0.00458*(ADC)$	ABIAS
37	Voltage 14	Not Used	Not Used	Not Used
38	Voltage 15	Not Used	Not Used	Not Used
39	Voltage 16	Not Used	Not Used	Not Used

## Appendix C

### External Power

The table below shows the power requirements for two different input voltages. The range of input voltage is 12VDC to 32VDC.

Supply Voltage	Power On Surge	Current	Power
24VDC	3.5A	650mA	15.6 Watts
15VDC	4.2A	1080mA	16.2 Watts