

©2019 SIMMCONN Labs, LLC All rights reserved

NewScope-0Jr Operating Manual

June 7, 2020

NewScope-0Jr Operating Manual

- 1 Introduction 3
 - 1.1 Kit configurations 3
- 2 Installation 4
 - 2.1 Initial Inspection..... 4
 - 2.2 Installation of the NewScope-0Jr Kit..... 6
 - 2.2.1 Read before installation 6
 - 2.2.2 Installation on a 3561A unit 7
 - 2.2.3 Installation on an 8920A/B or 8921A unit 12
 - 2.2.4 Installation on an 859x Spectrum Analyzer 15
 - 2.2.5 Installation on an 8935 series (E3680A, E3681A or E8285A)..... 19
- 3 Operations 20
 - 3.1 Intensity control..... 20
 - 3.2 Color control 20
 - 3.3 LEDs 21
 - 3.4 Jumpers 22
 - 3.5 Other Onboard Connectors 22

1 Introduction

The NewScope-0Jr Color LCD Replacement Kit is designed to replace the small-screen monochrome raster CRT or EL displays used in HP® 3561A, 8920A/B, 8921A, 859xA/B/C/E/L/Q series, 8935 series (E6380A, E6381A) and E8285A¹. The kit supports 5.6", 5.7" or 6.5" TFT color LCD with VGA (640 x 480) resolution. The key features of the kit include:

- CRT Display intensities are mapped to colors. The EL display replacement is yellow-only.
- LCD panel size and mounting hardware are optimized for the original test equipment
- On-board analog VGA output signals are available to drive an external VGA monitor. Cabling and output connector are to be supplied by the customer.
- The LCD kit is powered from the regulated +12V used for the original CRT display in the system
- The LCD display is pre-assembled and tested for easy installation

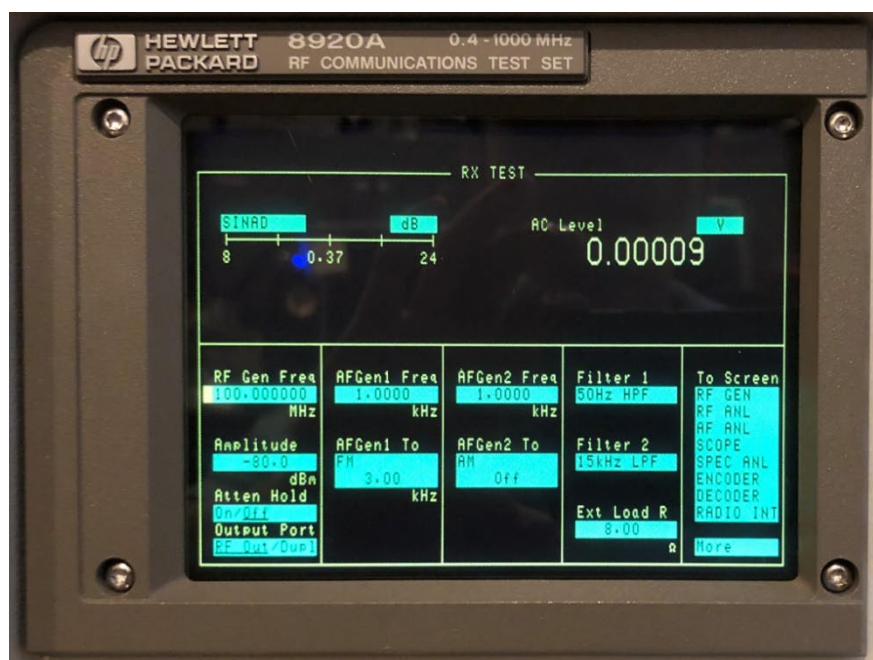

Figure 1 NewScope-0Jr LCD kit on the 8920A

1.1 Kit configurations

Kit Model #	LCD Panel	Compatible HP Model #	Note
NS0Jr-3561	5.6" VGA	3561A	
NS0Jr-8920	5.6" VGA	8920A, 8920B, 8921A	
NS0Jr-8590A	5.7" VGA	859xA series (old-style bezel ²)	Monochrome only
NS0Jr-8590E	5.7" VGA	859xA/B/C/E/L/Q series (new-style bezel ²)	
NS0Jr-8935	6.5" VGA	E3680A, E6381A, E8285A	Yellow color only

¹ Other test equipment is being added to the NewScope-0Jr compatibility list.

² See section 2.2.4.1 Identify the old-style and new-style bezel on an 859x Spectrum analyzer for details

2 Installation

2.1 Initial Inspection

The kits for different units may have different contents. Please check and make sure the kit you ordered match with the unit you are installing the kit into. Verify that all parts listed in the table corresponding to your kit are present.

Table 1 NewScope-0Jr Kit Content for 3561A units

Item	Qty	Reference	Description	Note
1	1	NewScope-0Jr	Main board, NewScope LCD Kit	1
2	1	18-0001-036	NS0Jr 3561 cable	
3	1	19-0001-026	3561A LCD bracket	1
4	1		LCD Panel, 5.6 Inch	1
5	1		PCB spacer, ¼"	1
6	2		M3 x 6 Pan-head Philips screw with washer	1
7	1		Foam strip with adhesive backing, 10x1mm black	1
8	2		0.1" Jumper blocks	1
9	2	WCL-4	Cable clip with adhesive backing	

Note:

1. Shipped pre-assembled as LCD display assembly.

Table 2 NewScope-0Jr Kit Content for 8920A/B and 8921A

Item	Qty	Reference	Description	Note
1	1	NewScope-0Jr	Main board, NewScope LCD Kit	1
2	1	18-0001-031	NS0Jr Control Pot Cable Extender, 3 Conductor	
3	1	18-0001-032	NS0Jr Display Cable Extender, 5 Conductor	
4	1	19-0001-024	8920A 5.6" bracket	1
5	1		LCD Panel, 5.6 Inch	1
6	6		M3 x 6 Pan-head Philips screw with washer	1
7	9		M2.5 x 5 Pan-head T8 screw	
8	2		M3 x 9 Pan-head T10 screw	
9	2		M3 x 12 Pan-head T10 screw	
10	2		M3 x 7 female-female hex standoff	
11	2		M3 x 6+6 female-male standoff	
12	1		Foam strip with adhesive backing, 10x1mm black	1
13	2		0.1" Jumper blocks	1
14	1		Resistor SMD 1.33k Ohm ±1% 1206	
15	1		Foam strip with adhesive backing, 5x0.5mm black	
16	2	WCL-4	Cable clip with adhesive backing	

Note:

1. Shipped pre-assembled as LCD display assembly.

Table 3 NewScope-0Jr Kit Content for 859x Series (old style bezel)

Item	Qty	Reference	Description	Note
1	1	NewScope-0Jr	Main board, NewScope LCD Kit	1
2	1	18-0001-032	NS0Jr Display Cable Extender, 5 Conductor	
3	1	18-0001-033	NS0Jr Backlight cable for 5.7 inch panel	1
4	1		LCD FFC Cable, 33-conductor	1
5	1	19-0001-025	8590 LCD Bracket for 5.7 inch panel	1
6	1		LCD Panel, 5.7 Inch	1
7	2		M3 x 6 Pan-head Philips screw with washer	1
8	2		PCB spacer, ¼"	1
9	4		#4 x ¼" Pan-head Philips screw, self-tapping	1
10	3		4 x 8 x 0.8 Flat washer	
11	3		M4 x 10 female-female hex standoff	
12	3		M4 x 12 Socket-head screw, black	
13	1		M4 x 6 Small flat-head Philips screw	
14	2		M4 x 16 flat-head Philips screw	
15	2		0.1" Jumper blocks	1
16	1		Resistor Metal Film 392 Ohm ±1% 1/8W	
17	1		Anti-glare acrylic sheet for old-style bezel	
18	2	WCL-4	Cable clip with adhesive backing	

Note:

1. Shipped pre-assembled as LCD display assembly.

Table 4 NewScope-0Jr Kit Content for 859x Series (new style bezel)

Item	Qty	Reference	Description	Note
1	1	NewScope-0Jr	Main board, NewScope LCD Kit	1
2	1	18-0001-032	NS0Jr Display Cable Extender, 5 Conductor	
3	1	18-0001-033	NS0Jr Backlight cable for 5.7 inch panel	1
4	1		LCD FFC Cable, 33-conductor	1
5	1	19-0001-025	8590 LCD Bracket for 5.7 inch panel	1
6	1		LCD Panel, 5.7 Inch	1
7	2		M3 x 6 Pan-head Philips screw with washer	1
8	2		PCB spacer, ¼"	1
9	4		#4 x ¼" Pan-head Philips screw, self-tapping	1
10	3		4 x 8 x 0.8 Flat washer	
11	2		M4 x 8 female-female hex standoff	
12	1		M4 x 10 female-female hex standoff	
13	3		M4 x 12 Socket-head screw, black	
14	1		M4 x 6 Small flat-head Philips screw	
15	2		M4 x 16 flat-head Philips screw	
16	2		0.1" Jumper blocks	1
17	1		Resistor Metal Film 392 Ohm ±1% 1/8W	
18	1		Anti-glare acrylic sheet for new-style bezel	
19	2	WCL-4	Cable clip with adhesive backing	

Note:

1. Shipped pre-assembled as LCD display assembly.

Table 5 NewScope-0Jr Kit Content for 8935 (E6380A, E6381A and E8285A)

Item	Qty	Reference	Description	Note
1	1	NewScope-0Jr	Main board, NewScope LCD Kit	1
2	1	18-0001-034	NS0Jr Backlight cable for 6.5 inch panel	1
3	1	18-0001-035	NS0Jr DF19 LVDS Cable	1
4	1	19-0001-032	8935 LCD Bracket for 6.5 inch Panel	1
5	1		LCD Panel, 6.5 Inch	1
6	2		M3 x 6 Pan-head Philips screw with washer	1
7	4		M2.5 x 6 Pan-head Philips screw with washer	1
8	2		M3 x 5+6 female-male hex standoff	1
9	2		3 x 7 x 0.5 flat washer	1
10	2		M3 x 5 wafer-head Philips screw	1
10	2		M3 KEP nut	1
11	2		0.1" Jumper blocks	1

Note:

1. Shipped pre-assembled as LCD panel assembly.

2.2 Installation of the NewScope-0Jr Kit

Installation should be performed by a qualified technical person who is familiar with the host test equipment. The display functions in the instrument should be in good working condition before the LCD retrofit.

The kit installation time is approximately 1 hour. Please refer to test equipment service manuals for location of the assemblies.

Caution: CRT could have lethal high voltage on the anode. Use proper precautions when handling CRT Assembly.

Note: Dispose of the CRT display within your state's hazardous materials guidelines for CRT's and electronics.

2.2.1 Read before installation

Please treat the parts and assemblies with care during installation. Take the following guidelines when installing the kit:

- 1) Obtain a copy of the factory service manual for the instrument you will be working on. Read through the procedures for replacing major assemblies. Pay attention to the notes and warnings in the factory service manual.
- 2) Take precautions for ESD discharge, high-voltage hazard from the CRT, and use a Ground Fault Interrupter (GFI) protected mains supply for personal safety.

- 3) Do not use power tools to fasten screws. Use a manual screwdriver so that you can see and feel if something is not well aligned. If you meet considerable resistance when fastening a screw, back off and try again.
- 4) The connectors are fragile. If you meet resistance when trying to make a connection, wiggle the connector gently left and right, let it find its way and then gradually plug in. Do the same when disconnecting a cable.
- 5) Do not force anything into position. If something doesn't seem to fit, give it a little wiggle room and it will likely correct itself.
- 6) Before trying to modify some part that doesn't seem to fit, take a short break and read the manual one more time. Chances are some steps in the manual may not be very clear or well understood. Ask questions and we'll get back to you as soon as we can.
- 7) The LCD kit is shipped assembled and tested. Do not disassemble. The assembly information is not included in this manual.
- 8) **NEVER** connect or disconnect any cable to the LCD display or part of the LCD display while the unit is powered on. Doing so will cause permanent damage to the electronics, which is not covered by the warranty.

2.2.2 Installation on a 3561A unit

2.2.2.1 Prepare the unit for installation

Disconnect AC power cord. Remove the top and bottom covers from the instrument. Follow the manufacturer's ESD precaution guidelines in the unit's service manual.

Caution: CRT could have up to 8000V on the anode. Use proper precautions when handling the CRT assembly.



Before removing the CRT you have to discharge it using a flat-blade screwdriver with an insulated handle. While keeping contact to the chassis with the blade, probe under the insulating cap of the anode lead with the tip, and touch the lead's metal conductor to discharge. Repeat several times.



Following the instructions in chapter 7 of the 3561A service manual to remove the front panel with the CRT attached.

Disconnect the green/yellow grounding wire connecting the front panel casting and the instrument's aluminum frame.

Disconnect the anode lead from the CRT by carefully releasing the two hook tips inside the anode connector.



Remove the four screws securing the CRT shield to the front panel casting, two on the top and two on the front below the CRT.

Remove the CRT shield. Save the screws for future use.

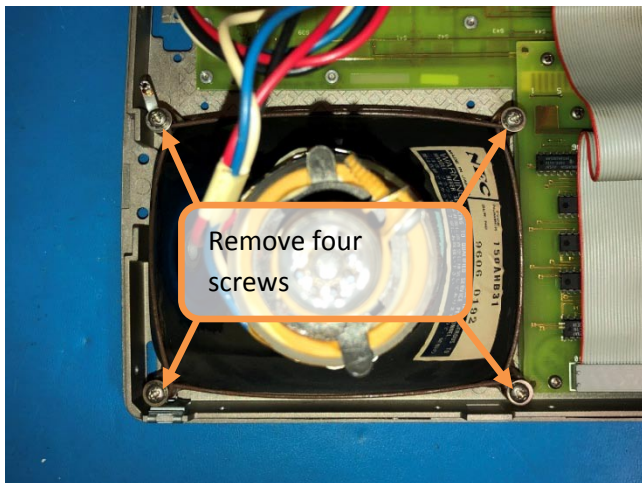

Remove the four screws securing the CRT wire ring retainer to the mounting standoffs.

Remove the wire ring retainer and the CRT. Remove the standoffs and the rubber gasket from the front panel casting.

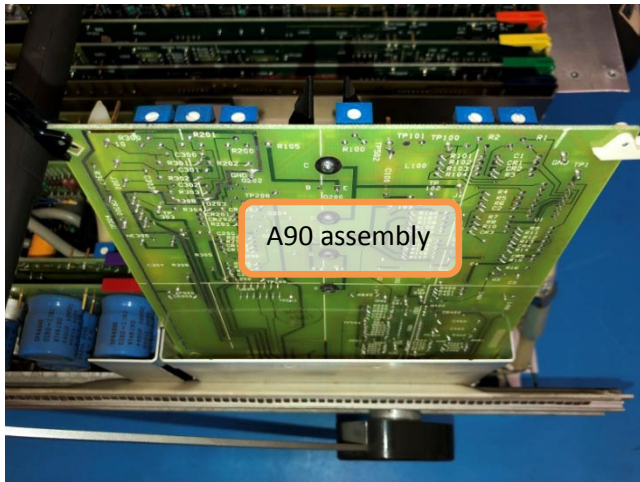

Remove the A90 assembly hold-down cover from the A90 side shield. Remove the A90 assembly.

Once the A90 assembly is removed, the fly-back circuit is disabled and no longer generates high voltage on the CRT anode lead.

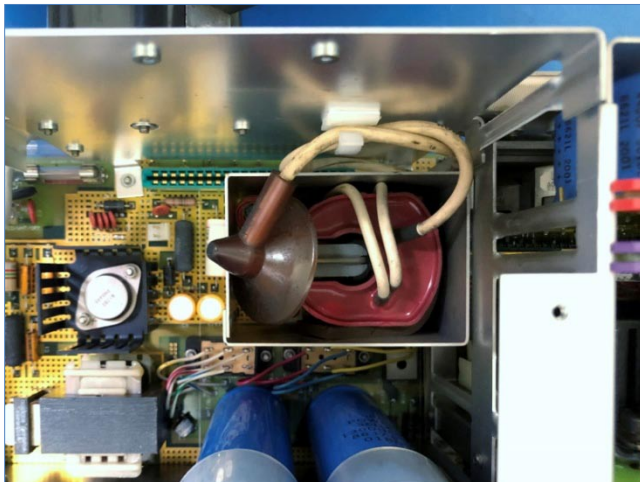

The CRT anode lead may be cut at the fly-back transformer, or form a loop and secured to the A90 side shield with a cable clip, to prevent the metal contact from shorting to other components.

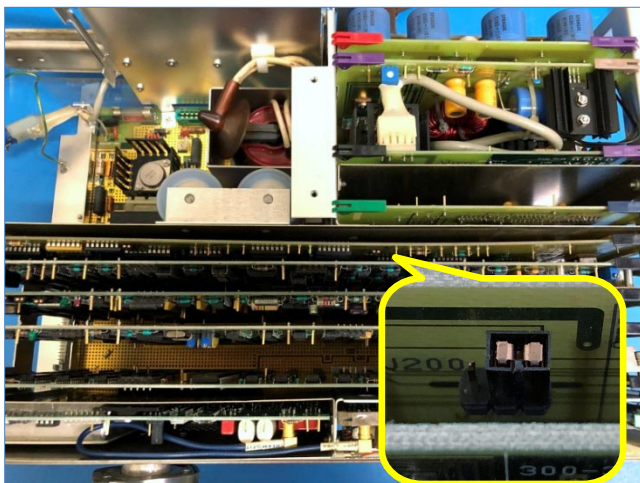

Check and make sure that A60J200 on the digital display driver board is at the '60Hz' position (the rear-side position). The LCD display will not work with the A60J200 at the 'sync' position.

Clean the inside of the front trim bezel. Remove any dust or dirt on the metal shielding mesh. Now the unit is ready for LCD installation.

2.2.2.2 Install the LCD display

The NewScope-0Jr is designed to give better contrast when viewed from 12 o'clock direction (from slightly above the unit). Image gray scale may be reversed when viewed from the 6 o'clock direction.

Caution: The LCD panel is connected to the NewScope-0Jr board with a fragile Flexible PCB (FPC) cable. The FPC cable may tear off if the LCD panel falls out of the bracket and such damage is not repairable. Do not let the LCD panel face-down without proper measures to hold it to the bracket.

Remove the anti-static tape temporarily securing the LCD panel to the bracket during shipping. Remove the protective plastic shipping film from the front of the LCD screen by lifting the tab at the upper left corner. Be careful not to touch the LCD screen.



While holding the LCD display assembly with the LCD panel facing up, move the assembly below the front panel casting, until the mounting holes align with the threaded hardware on the bracket.

Secure the LCD display assembly to the front panel casting using four M3x6 flat-head screws that were used to secure the CRT shield.

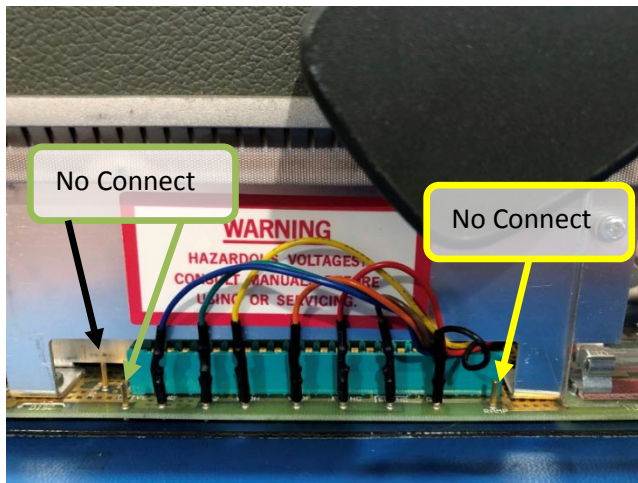

Connect the NS0Jr 3561A cable to the test points on the A99 motherboard (from front to back):

Wire Color	Test Point
Black	GND
Brown	SSYNC
Red	FSYNC
Orange	VDF
Yellow	VDH
Green	+12
Blue	GND

Route the cable to behind the front panel.

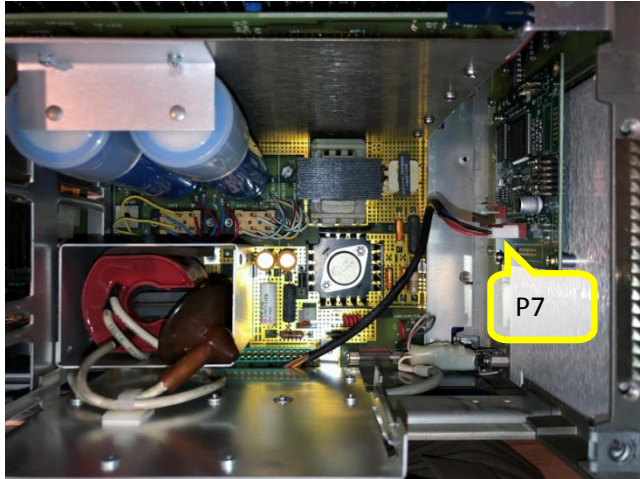

Set the jumpers for intensity and color selections according to section 3 Operations.

Since there is no intensity control on the 3561A front panel, it is recommended to set the intensity to the maximum.

Connect the other end of the NS0Jr 3561A cable to P7 on the NewScope-0Jr board.

Install the front panel casting and front trim bezel back to the unit following the reverse sequence of the removal in section 2.2.2.1.

Replace the instrument covers. The installation is now complete.

2.2.3 Installation on an 8920A/B or 8921A unit

2.2.3.1 Prepare the unit for installation

Remove the external cover.

Remove the A1 front panel, A22 display (CRT) and A20 display processor board following the instructions in the factory Assembly Level Repair manual.

Remove the CRT cable from the display and connect it back to the motherboard.

Clean the inside subpanels of the CRT cavity with isopropyl alcohol and cloth of the high voltage dust residue.

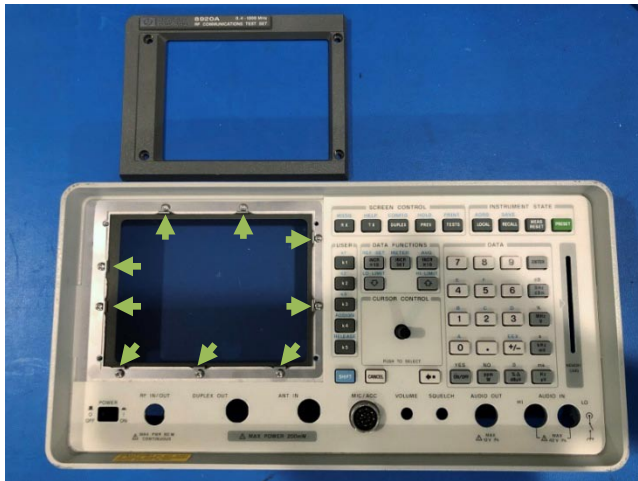

Remove the four M3x10 Torx screws securing the CRT trim bezel to the front panel casting. Remove the CRT trim bezel.

Remove the nine M2.5x6 Torx screws on the window clip. Carefully remove the window clip and the CRT filter window without scratching it. Clean the CRT filter with water and mild soap and let dry.



Remove the old CRT foam gasket and thoroughly clean up the residue with adhesive remover. Wipe clean with isopropyl alcohol.

Replace the CRT filter window and secure the window clip using the provided M2.5x5 screws.

Install the CRT bezel with provided M3x12 screws on the left and M3x9 screws on the right (as seen from the front).

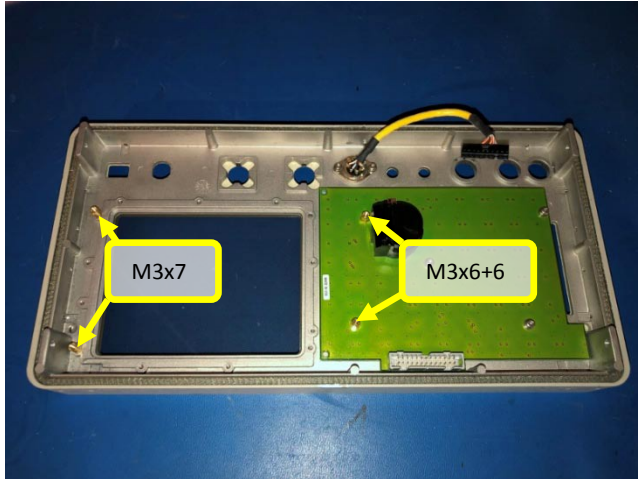

On the back of the front panel assembly, install two M3x7 female-female hex standoffs on the left.

Remove the two M3x6 screws on the A1 keyboard PCB close to the display widow. Install two M3x6+6 female-male hex standoffs at those locations.

2.2.3.2 Install the LCD display

The NewScope-0Jr is designed to give better contrast when viewed from 12 o'clock direction (from slightly above the unit). Image gray scale may be reversed when viewed from the 6 o'clock direction.

Caution: The LCD panel is connected to the NewScope-0Jr board with a fragile Flexible PCB (FPC) cable. The FPC cable may tear off if the LCD panel falls out of the bracket and such damage is not repairable. Do not let the LCD panel face-down without proper measures to hold it to the bracket.

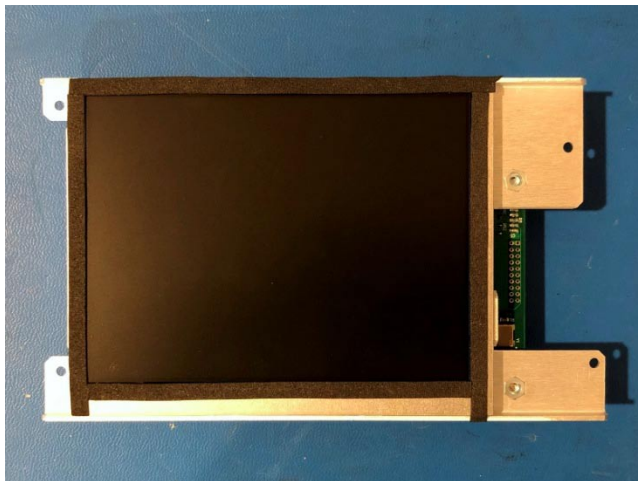

Remove the anti-static tape temporarily holding the LCD panel to the bracket during shipping. Remove the protective plastic shipping film by lifting the tab at the upper left corner. Be careful not to touch the LCD screen.

Cut the foam strip to length, remove the paper backing and apply the foam tape around the edge of the LCD panel active display area. Join the tape sections as seamless as possible without overlapping.

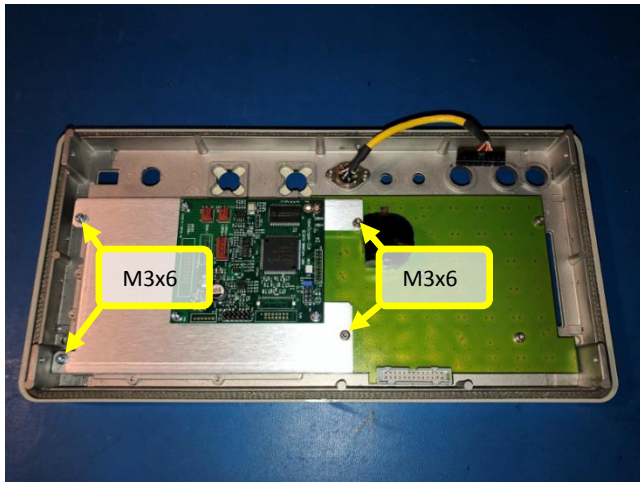

While holding the LCD display assembly with the LCD panel facing up, move the assembly below the front panel casting, until the LCD display area aligns with the viewing window.

Hold the two pieces together and flip over. Secure the LCD display assembly to the front panel casting using two provided M3x6 pan-head screws and two M3x6 screws removed from A1 keyboard PCB in the previous step.

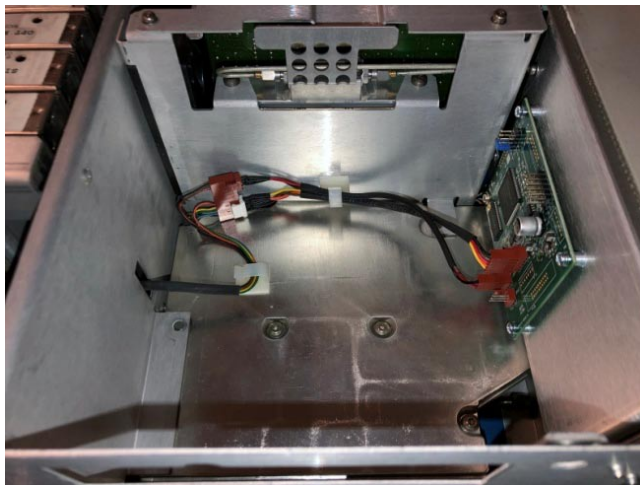

Connect the Control Pot Cable Extender and the Display Cable Extender to the original CRT cable and secure them with cable clips. On the NS-0Jr main board, use P8 and P5 for the original menu-driven intensity control.

To use the intensity menu to switch colors, set the intensity to the maximum and connect the Control Pot Cable Extender to P14, see section 3 Operations for details.

2.2.3.3 Rework the A20 driver board

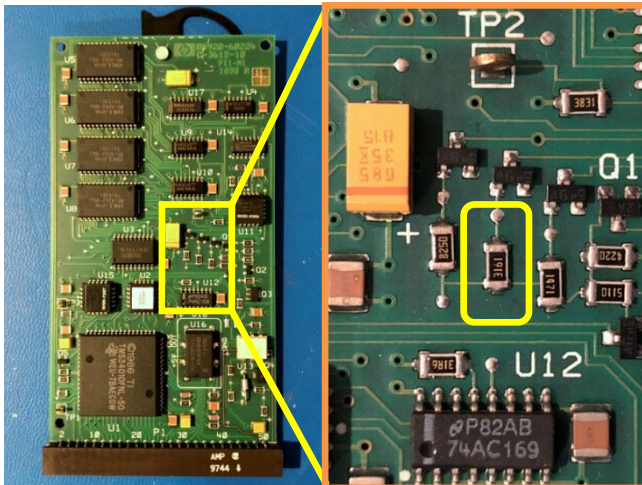

On the A20 board, locate a 3160 Ohm resistor in 1206 package near the center of the board (top marking 3161). Install the provided 1.33k Ohm resistor on top of it, in parallel. This modification shifts the half-brightness video level and is necessary for proper color mapping.

Install the A20 board, the front panel and all necessary brackets removed during the preparation steps.

Secure the cables inside chassis. Replace the instrument cover and bumpers.

The installation is now complete.

2.2.4 Installation on an 859x Spectrum Analyzer

2.2.4.1 Identify the old-style and new-style bezel on an 859x Spectrum analyzer



The old-style bezel is identified by lack of the memory card slot on the front, and the round threaded posts on the inside of bezel mounting screw positions.

The old-style bezel is commonly seen on the early 859xA series spectrum analyzers.

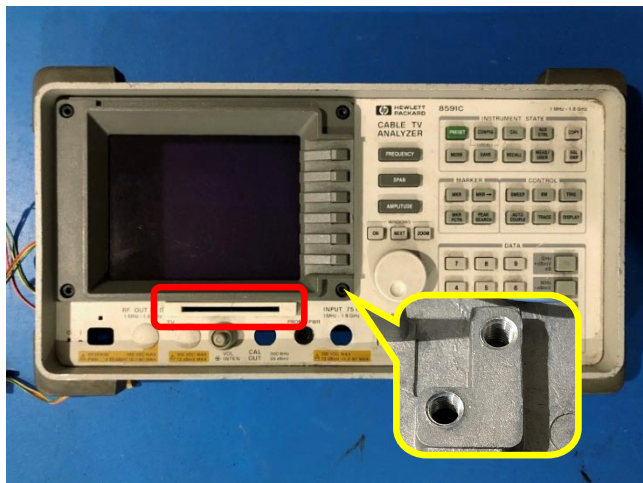

The new-style bezel is identified by the memory card slot on the front (may be covered by a plastic plug if the option is not installed), and the threaded pedestals on the inside of bezel mounting screw positions.

The new-style bezel is commonly seen on the late 895xA, the 859xB/C/E/L/Q spectrum analyzers.

2.2.4.2 859x CRT horizontal position adjustment

IMPORTANT: The 859x spectrum analyzer has a CRT horizontal position adjustment on the second page of the CAL menu. The right half of the adjustment range results in a video timing that is incompatible with NewScope-0Jr, causing no image on the LCD display. Before installation, please **adjust the CRT horizontal position to the left-most position**. The image position on the LCD display may be adjusted again after installation.

What to do if you forgot to adjust the CRT horizontal position before installation and now have no image on the LCD display?

You may access the adjustment by pressing the **CAL** button, then the bottom soft menu key [**MORE 1 of 4**], then the 2nd soft key from the bottom [**CRT HORZ POSITION**], and then turn the rotary encoder **CCW** until the picture appears.

2.2.4.3 Prepare the unit for installation

Caution: A high-voltage potential may remain within the A2 Display assembly for some time after it has been removed from the instrument. Do not attempt to remove the post-accelerator lead from the CRT.

Disconnect the AC power cord. Remove the rear bumpers and the cover. Remove the A2 display unit and the A3 front-frame assembly following the instructions in the factory service manual.

Disconnect the display cables from the CRT unit. Leave the other end of the cables connected, or reconnect after CRT removal.

2.2.4.4 Install the LCD Display

The NewScope-0Jr is designed to give better contrast when viewed from 12 o'clock direction (from slightly above the unit). Image gray scale may be reversed when viewed from the 6 o'clock direction.



Place the front frame assembly on a flat surface with the outside facing up. Remove the four socket cap screws at the corners of the CRT bezel. Remove the bezel and the CRT filter.

Substitute the screws with supplied M4x12mm socket cap screws **except** the one at the top-left corner. Replace the bezel without the CRT filter.

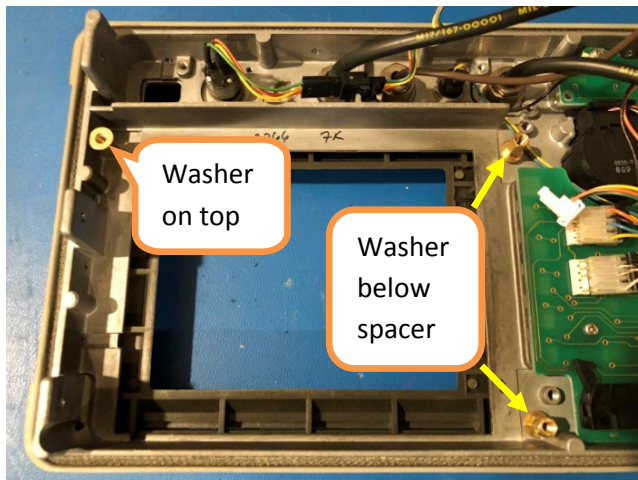

For the old-style bezel:

Turn the front frame over with its inside facing up. Install three provided M4x10 hex spacers on the replaced CRT bezel screws with 0.8mm flat washers. See picture for position of the washers.

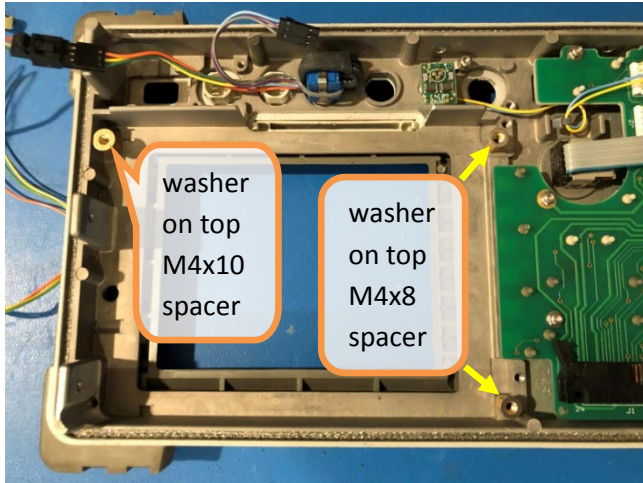

For the new-style bezel:

Turn the front frame over with its inside facing up. Install provided hex spacers on the replaced CRT bezel screws:

- M4x10 hex standoff with 0.8mm flat washer on top at the upper-left location (see picture).
- M4x8 hex standoff with 0.8mm flat washer on top at the other two locations.

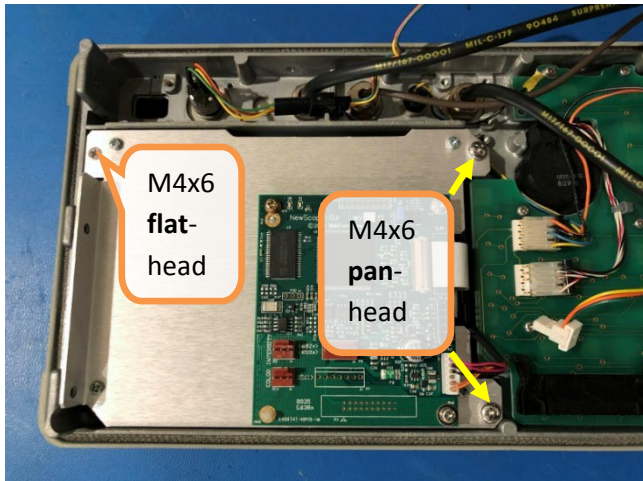

Place the anti-glare acrylic sheet **matte side down** into the viewing window. Remove the protective shipping film from the LCD screen. Place the LCD panel assembly in the front frame. Secure the LCD bracket using supplied screws, **DO NOT OVER-TIGHTEN:**

- M4x6 small flat-head screw at the upper-left location (see picture)
- M4x6 pan-head screws at the other two locations

The acrylic sheet should move freely after installation.

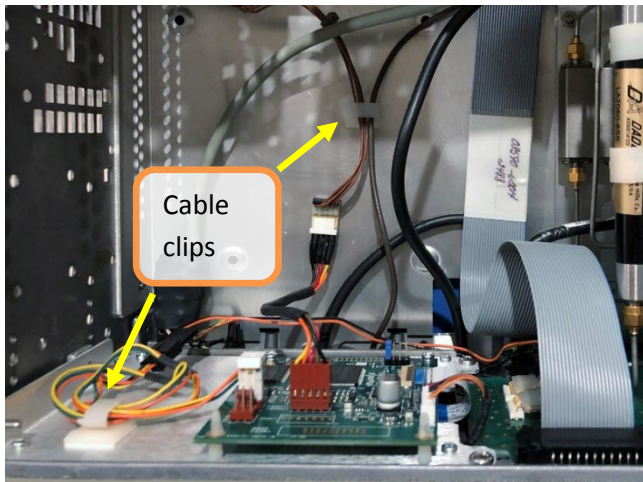

Connect the display cable using the Extender to P8 on the NewScope-0Jr main board, and the intensity pot cable to P5. Set the jumpers on P1 and/or P14 to desired color scheme. Secure the excess cable with cable clips.

Alternatively, set the intensity to maximum and use the intensity pot to change the color scheme. Refer to section 3 Operations for details.

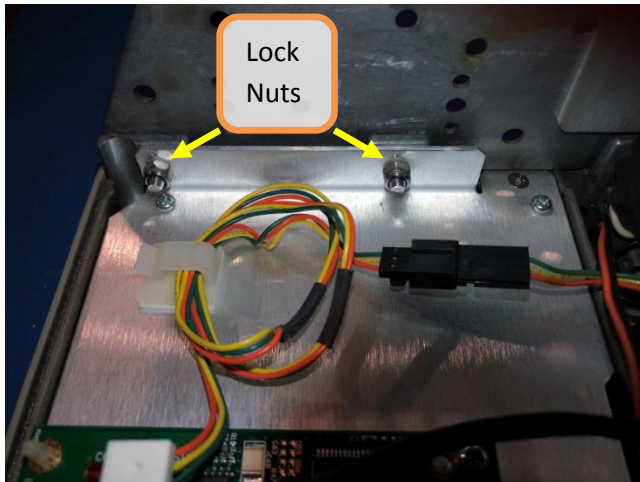

Reinstall the front frame assembly. Use supplied M4 x 16mm Flat-head screws to replace the original ones at the two upper locations when securing the left side panel to the front frame.

After the screws are fastened, add two lock nuts to the extended thread and tighten with an open-ended wrench.

2.2.4.5 Rework the A16 Processor/Video board

This step is not applicable to the earlier 859xA series unit with the older style processor board.

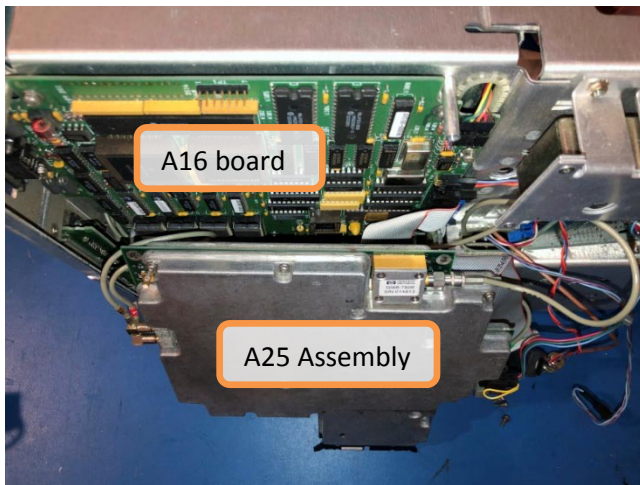

Place the analyzer on the work surface with the bottom side facing you. Remove the A25 assembly to expose upper part of the A16 Processor/Video board. Keep the cables connected to A25 and support it to prevent falling.

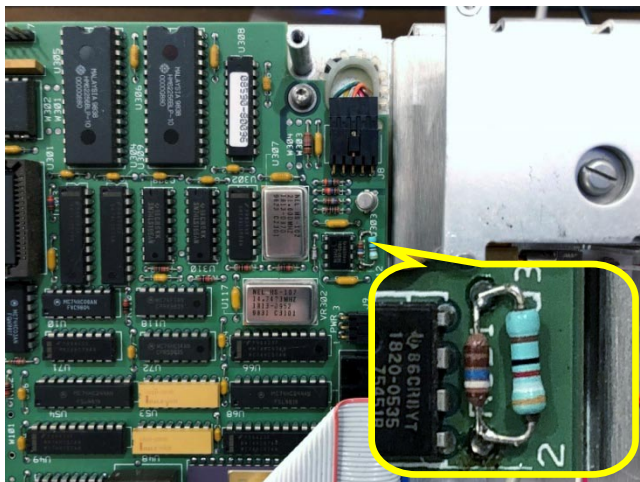

On the Processor/Video board, locate resistor R301 (1960 Ohm) near J8 (the display cable connector). Install the provided 392 Ohm resistor in parallel beside it. This modification shifts the half-brightness video level and is necessary for proper color mapping.

Replace the A25 assembly.

Replace the cover and the rear bumpers. The installation is now complete.

2.2.5 Installation on an 8935 series (E3680A, E3681A or E8285A)

2.2.5.1 Prepare the unit for installation

Caution: The EL Display assembly contains high voltage when operating. Do not touch the circuit components on the back of the EL display.

Disconnect the AC power cord. Remove the rear bumpers and the instrument cover.

Remove the front bezel and front panel assembly. Disconnect the display ribbon cable from the EL display unit and remove the EL display. Remove and clean the amber display filter with water and mild soap and let dry.

2.2.5.2 Install the LCD Display

The NewScope-0Jr is designed to give better contrast when viewed from 12 o'clock direction (from slightly above the unit). Image gray scale may be reversed when viewed from the 6 o'clock direction.



The NewScope-0Jr for 8935 is a drop-in replacement for the EL display. Install the LCD display in place of the EL display and reconnect the ribbon cable. Replace assemblies removed in the preparation steps.

On the E8285A, the rear safety shield for the EL display is no longer needed, and does not need to be installed on the LCD assembly.

The NewScope-0Jr for 8935 supports yellow/amber color only.

3 Operations

3.1 Intensity control

The intensity control is on connector P5. It can be connected to the original intensity pot or the menu-driven intensity control voltage between 0V and 12V. To fix the intensity at the maximum, install a jumper on pin 2-3.

Table 6 Intensity control P5 pin descriptions

Pin Number	Description	Note
1	GND	
2	Intensity Control, 0 to 12V	Recommended pot 5k Ohm or higher
3	+12V	Internally connected to 12V supply via 100 Ohm resistor

Note: A noisy intensity pot may cause surges in the backlight operating current. It should be cleaned or replaced.

3.2 Color control

NewScope-0Jr has four preset color schemes. The color control is through connector P14 or P1 pins 5-6 and 7-8. P14 takes effect if no jumper is installed on P1 pins 5-6 or 7-8. P14 accepts potentiometer or a control voltage between 0V and 12V. Color schemes switch from #0 thru #3 at approximately 4.2V, 7.3V and 10.2V. Color changes via P14 takes effect in real time, while changes via P1 jumpers require power cycling.

Table 7 Color scheme selection

P1 pin 5-6	P1 pin 7-8	Color scheme
OFF	OFF	Controlled via P14. Install jumper on P14 pin 2-3 for fixed color #3
ON	OFF	Fixed at color #1
OFF	ON	Fixed at color #2
ON	ON	Fixed at color #0

Table 8 Color control P14 pin descriptions

Pin Number	Description	Note
1	GND	
2	Color Control, 0 to 12V	Recommended pot 1k Ohm or higher
3	+12V	Internally connected to 12V supply via 100 Ohm resistor

Table 9 3561A color mapping

Display Intensity	Color #0	Color #1	Color #2	Color #3
Background	Black	Black	Black	Black
Half brightness	47% Green	100% Green + 1/3 Blue	47% White	47% White
Full brightness	80% Green	Yellow	Yellow	80% White

Half & Full overlap	100% Green	White	White	White
--------------------------------	------------	-------	-------	-------

Table 10 8920A color mapping

Display Intensity	Color #0	Color #1	Color #2	Color #3
Background	Black	Black	Black	Black
Half brightness	53% Green	100% Green + 1/3 Blue	100% Green + 1/3 Blue	53% White
Full brightness	100% Green	Yellow	White	100% White

Table 11 8590A/E color mapping

Display Intensity	Color #0	Color #1	Color #2	Color #3
Background	Black	Black	Black	Black
Half brightness	53% Green	100% Green + 1/3 Blue	100% Green + 1/3 Blue	53% White
Full brightness	100% Green	Yellow	White	100% White

Note: Earlier 859xA series has only one brightness level and is mapped to full brightness.

8935 EL display has only one brightness level and is mapped to yellow on the LCD.

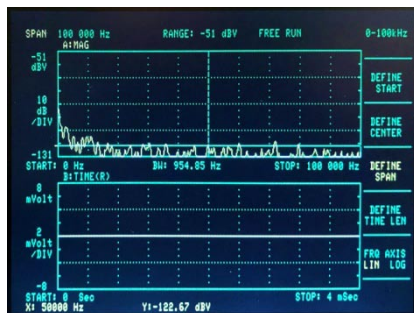

Figure 2 3561A Color Scheme #1



Figure 3 8920A Color Scheme #2

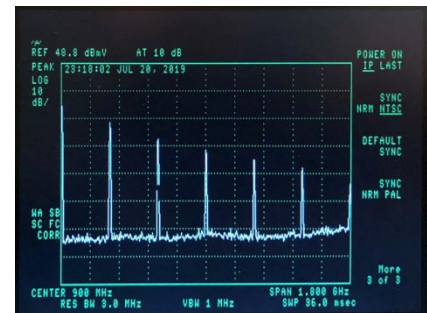

Figure 4 8590E Color Scheme #2

3.3 LEDs

There are two LEDs on the main board, D1 and D5. D1 serves as 'format code' LED. It repeats a group of 8 blinks to display the detected video format for debugging purpose. For the 8 blinks, a bright pulse represents 'high' and a dim one represents 'low'. For example, dim-dim-dim-dim-dim-bright-bright-dim (code 0x06) means video format #6 has been detected.

D5 serves as 'FPGA configuration done', indicating a successful FPGA configuration.

Table 12 NewScope-0Jr LED D1 blink code

Blink Code	Format	Note
0x00	Unstable video	A stable video signal has not been detected
0x01	3561A 60Hz	NewScope-0Jr only operates with 3561A 60Hz 'free run' mode
0x06	8590A	Earlier 859xA series with only one brightness level
0x07	8920A 60Hz	8920A US model with display driver board 08920-60224
0x08	8590E NTSC	The <i>-hp-</i> logo is missing the upper portion. This is normal.

0x09	8590E Normal	
0x0A	8935 (EL display)	
0x0B	8590E PAL	
0x0C	8920A 50Hz	8920A European model with display driver board 08920-60192
0x44	Unknown format	The input video format is not supported

3.4 Jumpers

The usage for jumper P1 on NewScope-0Jr main board is explained in the following table.

Table 13 Jumper Settings

Jumper	Position	Install Jumper Block	Remove Jumper Block	Note
P1	1-2	LCD Up/Down = low	LCD Up/Down = high	Change LCD image scan direction. Jumpers are set at factory for the correct image orientation.
	3-4	LCD Right/Left = low	LCD Right/Left = high	
	5-6	Color Strap 0 = Low	Color Strap 0 = high	Set the color scheme in conjunction with P14. See section 3.2 for details. Power off required for changes to take effect.
	7-8	Color Strap 1 = low	Color Strap 1 = high	

3.5 Other Onboard Connectors

Other onboard connectors are listed in the following tables.

Table 14 P2 LVDS Output (8935 Only)

Pin #	Signal Name	Pin #	Signal Name
1	PWR_PNL (3.3V)	2	PWR_PNL (3.3V)
3	R/L	4	U/D
5	GND	6	LCD_D0_N
7	GND	8	LCD_D0_P
9	LCD_D1_N	10	GND
11	LCD_D1_P	12	LCD_D2_N
13	GND	14	LCD_D2_P
15	LCD_CK_N	16	GND
17	LCD_CK_P	18	LCD_D3_N
19	GND	20	LCD_D3_P

Table 15 P3 8935 EL display input

Pin #	Signal Name	Pin #	Signal Name
1	+12V	2	+12V
3	NC	4	GND
5	5V (not connected to onboard +5V)	6	GND
7	Reserved	8	GND
9	Reserved	10	GND

11	VSYNC	12	GND
13	HSYNC	14	GND
15	CLK	16	GND
17	HB	18	GND
19	FB	20	GND

Table 16 P7 3561A video input

Pin #	Signal Name	Descriptions
1	GND	
2	SSYNC	Slow sync
3	FSYNC	Fast sync
4	VDF	Full-brightness video
5	VDH	Half- brightness video
6	+12V	
7	GND	

Table 17 P8 8920A and 859x video input

Pin #	Signal Name	Note
1	GND	
2	VSYNC	
3	VIDEO	
4	+12V	
5	HSYNC	

Table 18 P12 Backlight output

Pin #	Signal Name	Note
1	+12V	
2	GND	
3	GND	
4	+5V	0: backlight OFF, 5V: backlight ON
5	LED_EN	0: backlight OFF, 3.3V: backlight ON
6	LED_PWM	Default PWM frequency = 200Hz

Table 19 P13 Analog VGA output

Pin #	Signal Name	Pin #	Signal Name
1	5V_VGA	2	GND
3	R	4	GND
5	G	6	GND
7	B	8	GND
9	HSYNC	10	GND
11	VSYNC	12	GND

Note: The VGA output is 640x480 60Hz regardless of the input video format.

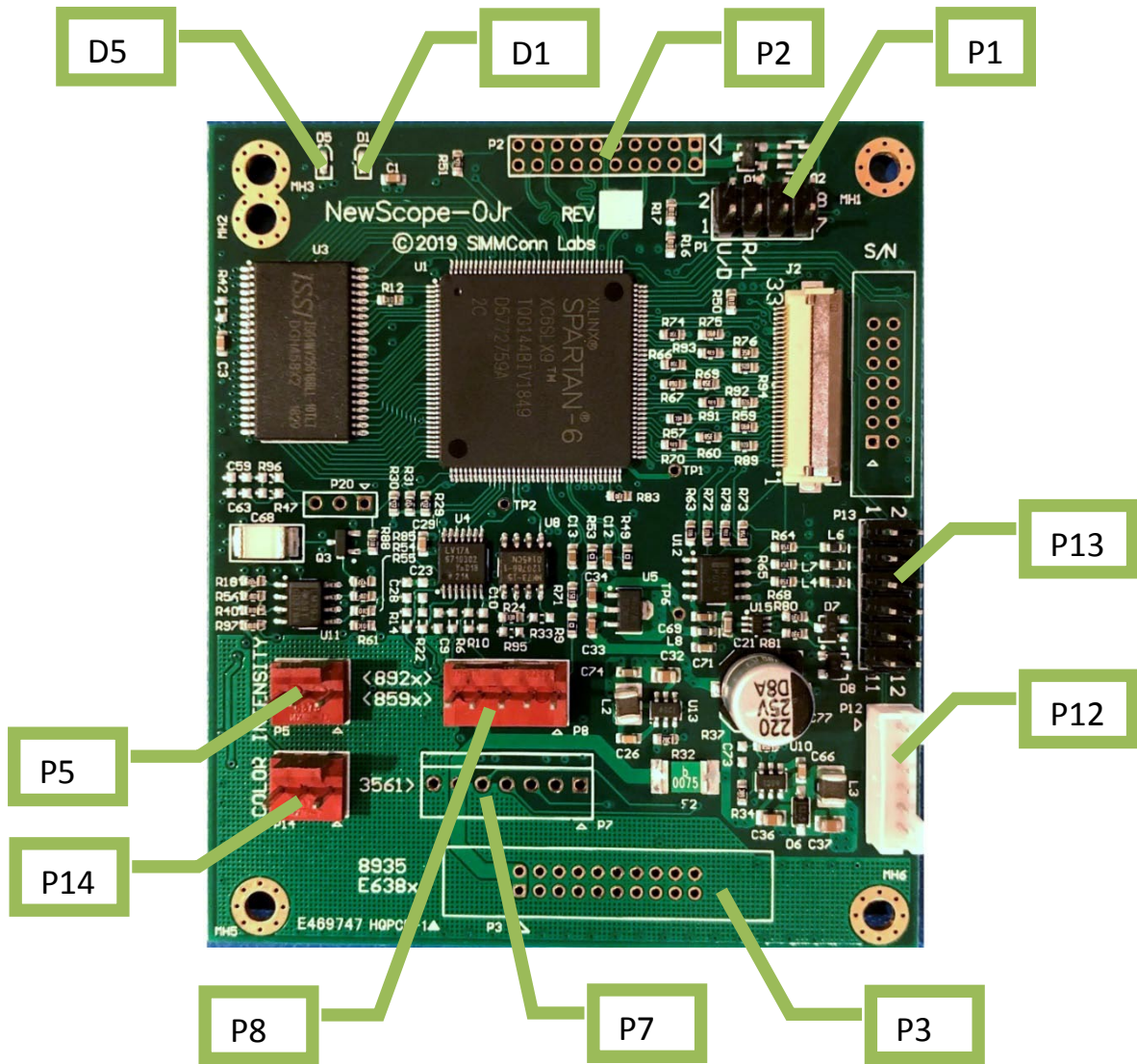

Revision History

Revision	Date	Notes
1.0		Initial revision for serial numbers NS01000 and above
1.1	11/22/2019	Added section 2.2.4.2 859x CRT horizontal position adjustment
1.2	11/29/2019	Changed all washers for 859x new-style bezel to 0.8mm. Added notes not to over-tighten screws.
1.3	6/7/2020	Added E8285A support