

The Portable Dose Rate Meter - PDRM 82

For the past 30 years, the U.K. Civil Defence organisation has been equipped to monitor for radioactive fallout following a nuclear conflict. During the past 10 years maintenance and repair of the instruments has been made increasingly difficult because of obsolete components and the equipment is becoming generally less reliable. The British Government, in collaboration with the Ministry of Defence, specified a replacement unit and Plessey Controls won the contract to develop and manufacture 79,000 portable and 1,050 fixed post instruments.

The new specification requires the instrument to monitor for gamma radiation over the range 0.1 cGy/h to 300 cGy/h (1 cGy = 1 rad).

The unit is expected to operate in extreme conditions and in order to satisfy this requirement has been type tested to the most stringent of specifications. The tests performed include shock and vibration, temperature cycling, immersion, EMC and EMP, the latter being an electromagnetic pulse resulting from the detonation of a nuclear device. The instrument was required to have a long working lifetime with each set of batteries and a period of 400 hours of continuous operation can be expected with standard C cells at nominal dose rate.

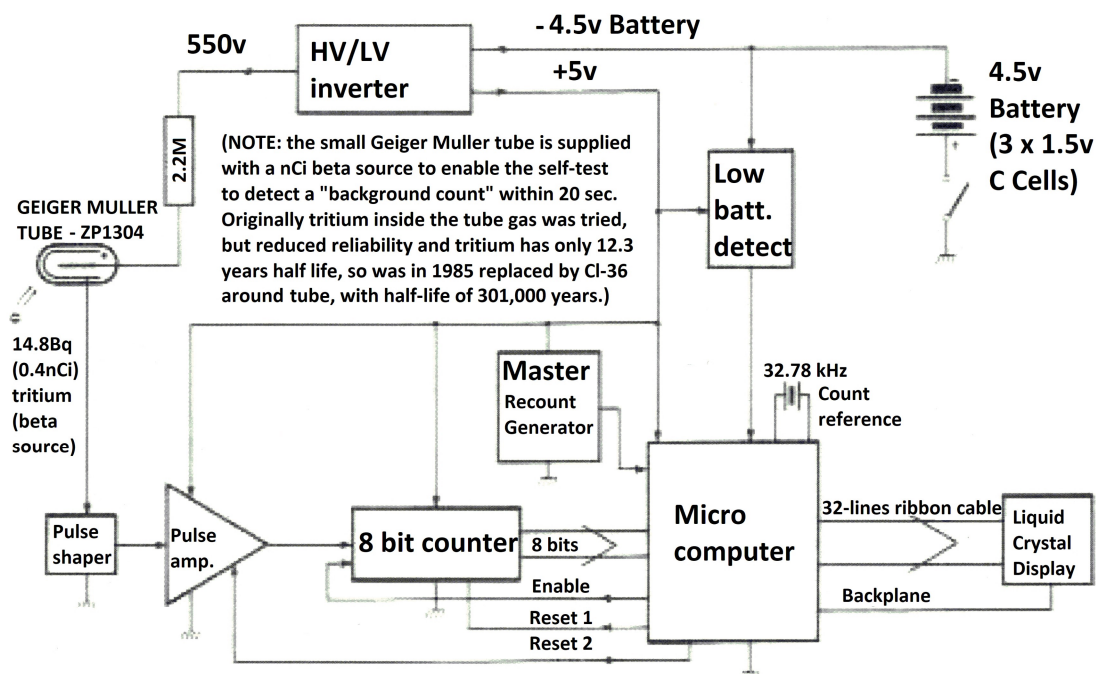

(SOURCE OF DIAGRAM: Civil Defence Operational Radiac Instruments, part 54.)

Block Diagram of the Portable Dose Rate Meter Circuit

G-M TUBE DEAD-TIME CORRECTIONS:
 50,000 c/s = 292 cGy/hr
 20,000 c/s = 75.3 cGy/hr
 1000 c/s = 3.1 cGy/hr
 100 c/s = 0.31 cGy/hr

ORIGINAL PDRM82 GEIGER MULLER TUBE, 7mm ZP1304, gives 340 (counts/sec)/(Cs137 R/hr)

The later PDRM82D for decontamination uses the more sensitive, 20 (c/s)/(mR/hr), Geiger Muller tube ZP1401 or energy compensated ZP1201

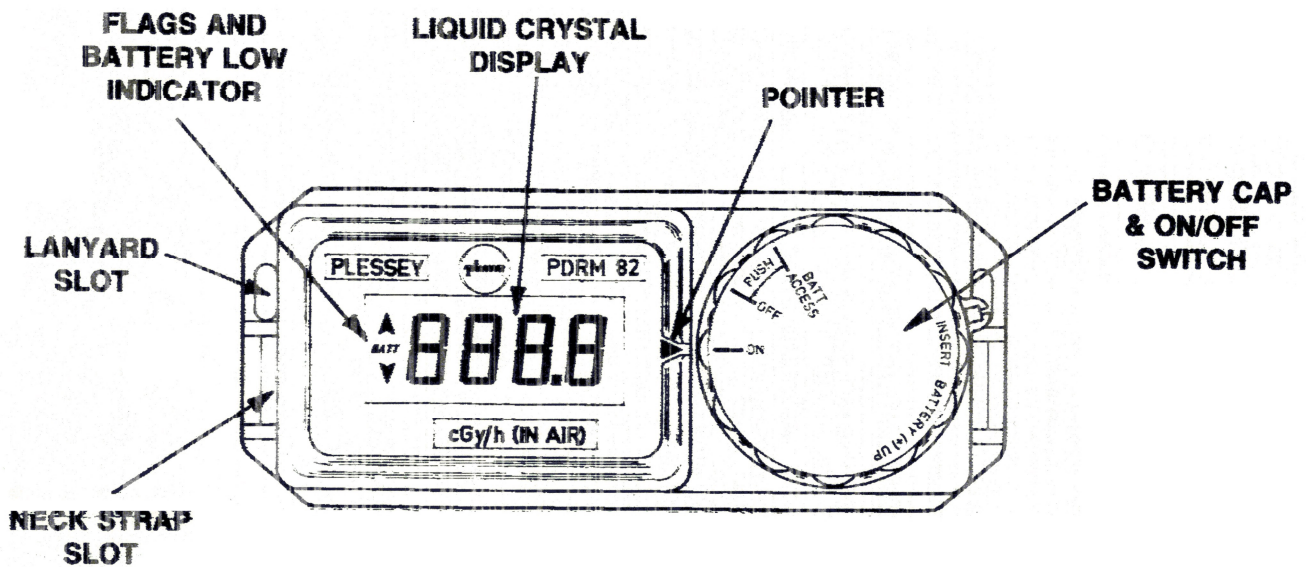

Immediately after switch-on the computer interrogates the electronic circuitry to establish the healthy state of the instrument. During this period the display reads 'TEST'. If a fault exists the LCD is programmed to display 'FAIL'. The function of the G.M. tube is continuously checked by the computer which monitors the background count due to an in-built nano-curie Beta source. This very small source is part of the G.M. tube assembly which includes compensation elements to ensure the correct response throughout the energy spectrum and in addition, corrects the G.M. tube's otherwise unacceptable polar response so that the unit is not directionally sensitive.

When the instrument is being used in an area where the contamination varies significantly, the LCD is made to display either an increasing or decreasing flag on the left side of the display window, if the dose rate varies by more than a preset number of cGy/h per counting period. This facilitates the location of hot-spots in the field or on equipment.

Another element of the LCD display indicates 'BATT' when the batteries need to be changed. There is typically 10 hours life left in the cells at the time when this display is first indicated.

The fixed post monitor is identical to the standard portable unit except for the detecting element which is remotely connected by a coaxial lead with a plug and socket onto the rear of the unit. This enables external conditions to be monitored from within a bunker as with the existing civil defence instruments.

The instrument incorporates components to BS9000 or CECC standards, which results in high reliability. As an example, at 25°C operated as a portable instrument, the calculated MTBF is 24,000 hours. Operating in a fixed position and not suffering the rough handling expected in field use, this figure increases to 90,000 hours. Since the instrument has been designed to meet the requirement of a long shelf life the probability of failure after 20 years storage is predicted to be at the very low rate of 4% or less.

The large number of instruments required by the Home Office has allowed mass-production techniques. This results in an inexpensive high performance instrument which is now available to all emergency monitoring organisations around the world.

3640/FDS/BEH/2
25.5.83.

NOTE: the original PDRM82 was produced by Plessey, but the decontamination meter PDRM82D was made by Siemens PLC from 1995: NATO item Z8/6665-99-193-6937.

RADIOLOGICAL DOSE RATE METERS

PDRM 82 & PDRM 82F

Radiation.

a) Nuclear.

Total dose accumulation of 1500cGy of gamma radiation at a dose rate no greater than 100cGy/h does not affect the instrument.

b) Electromagnetic Pulse (Nuclear).

Exposure to category B exoatmosphere EMP as defined in DEF STAN D7-55 Part 2, Section 5/1 Test E1. Equipment in operational condition during the test.

Electromagnetic susceptibility as defined in NWS 3 Class A.

Emission of Radio Frequency Interference as defined in NWS 3 Class A for frequencies above 150 KHz.

"© The Plessey Company plc 1982

This document and the information contained herein may not be copied, used or disclosed in whole or in part except with the prior written permission of The Plessey Company plc or, if this document has been produced under a contract with another party, as expressly authorised under that contract. It is supplied without liability for errors or omissions."

October 1982

Plessey Controls
Sopers Lane
Poole
Dorset
England BH17 7ER

The design technology used incorporates components mainly to BS 9000 or CECC standards which provides the instrument with a very high reliability. As an example at 25°C, operating in a mobile role, the calculated mean time between failure is 24,000 hours. Operating in a fixed position the figure increases to 90,000 hours. The instrument is designed for a 20 year storage period and the probability of failure during this period is predicted at less than 4% of the total units stored.

(a) Technical characteristics. PDRM 82 Portable Version.

Range: 0 to 300 cGy/h in 0.1 cGy/h increments.
Between 300 cGy/h and 1500 cGy/h instrument displays 300 flashing.

Accuracy: $\pm 20\%$ of true dose rate, 0.1 cGy/h. (in air) in the range zero to 100 cGy/h.
 $\pm 30\%$ of true dose rate (in air). in the range 100 to 300 cGy/h.

Operating Temperature Range: -10°C to + 45°C.

Energy Response: 0.3 MeV to 3 MeV within $\pm 20\%$ (Ra 226).
80 KeV to 300 KeV within $\pm 40\%$ (Ra 226)

Detector: Halogen quenched Geiger Muller tube.

Indication: Four digit 12mm high, liquid crystal with additional indication features of direction change of dose rate and battery low.

Power Supply: Three international standard 1.5 volt C cells. (R14HP)

Case: Waterproof moulded polycarbonate 3mm thick.

Size: 175mm x 135mm x 50mm.

Weight: 560 gms inclusive of batteries.

Carrying Support: Adjustable neckstrap and waist steadying lanyard.

(b) Technical Characteristics. PDRM 82 F Fixed Version.

The characteristics and construction of the fixed post monitor are the same as for the portable version. The physical variations are as listed.

Case: Moulded polycarbonate 3mm thick with screwed co-axial cable connector.

GEIGER COUNTERS PRIMARILY DESIGNED FOR PERSONAL OR CIVIL DEFENCE USE FOLLOWING NUCLEAR ATTACK.

- ★ FULL DOSE RANGE
- ★ SIMPLE ERROR-FREE USE
- ★ ILLUMINATED SCALE
- ★ WATERPROOF
- ★ SHOCK RESISTANT
- ★ WIPE CLEAN
- ★ SELF CONTAINED OR WITH REMOTE PROBES FOR SHELTER USE
- ★ EASILY USED BY UNTRAINED PERSONNEL



In the event of a nuclear explosion, fall-out could kill or maim more people than the direct effects of the bomb. Its arrival could be minutes or days later — from any direction and over any distance — depending on the winds and the weather. Its presence cannot be seen or felt, and can only be detected by suitable instruments. Lives would depend on the reliability, accuracy, storage life and ease of use — probably under adverse conditions — of these instruments.

Autonnic radiation detectors are built, under stringent quality control procedures, to meet and exceed recognised Civil Defence standards, and are housed in impact resistant, waterproof, plastic cases, whose clean lines allow rapid and easy decontamination after each use. Although the instruments are small, light and compact enough to be carried in a pocket, all the controls can be readily operated with a gloved hand.

The range switching is defined by colours corresponding to the scale in use. As a further aid to error-free reading, coloured solid state lamps indicate the range in use.

An audio indicator produces the conventional 'click' with each count. This can be used to check the instruments functioning under normal conditions by detecting the ever-present background count. An increase in the 'click' rate warns of fall-out activity which may then be monitored through the meter.

Model 80 is a self contained, portable, unit with the Geiger Muller detector tube enclosed in the case. The portability makes it most suitable for Civil Defence type use, and for people without an established, purpose-built, fall-out shelter. It is supplied, in a storage case, complete with full operating instructions, probable 'safe-time' calculator and individual radiation dose record cards.

Model 81 is primarily intended for use in fall-out shelters where it is connected to an externally mounted probe (Autonnic Type 811) to allow remote monitoring of outside radiation levels, without leaving the safety of the shelter. A close coupled probe (Autonnic Type 812) will convert Model 81 for portable use when leaving the shelter.

It is supplied with a wall mounting bracket, which can also house the close coupled probe and a spare battery, full operating instructions, probable 'safe-time' calculator and individual radiation dose record cards.

RADIATION METER – MODEL 80

ENERGY RANGE	—	80 kev – 3 Mev.
DOSE RANGE	GREEN	— 0 – 0.5 R/h
	YELLOW	— 0 – 5 R/h
	ORANGE	— 0 – 50 R/h
	RED	— 0 – 500 R/h
DETECTOR	—	GEIGER MULLER TUBE ENERGY COMPENSATED
BATTERY	—	1 – PP3, or PP3P
BATTERY LIFE at 30 mins/day	—	20 DAYS – PP3
	—	30 DAYS – PP3P
BATTERY CHECK	—	METER
SHOCK RESISTANCE	—	1 METRE DROP ON TO A FLAT UNYIELDING SURFACE.
WATERPROOFING	—	10 MINS. AT 30 CMS DEPTH.
TEMPERATURE RANGE	—	–20°C to + 60°C
METER	—	TAUT BAND, SHIELDED, SHOCK RESISTANT RUGGEDISED d'ARSONVAL 100°
	—	MECHANISM TO C39.1 MIL 202C AND GEA MIL T945A
	—	BY 2 LED'S.
METER ILLUMINATION	—	WIPE-CLEAN WITH DAMP CLOTH.
DECONTAMINATION	—	3 TRANSISTORS, 12 DIODES. 2 I.Cs. (1x4+1) ALL RADIATION HARDENED.
SEMI CONDUCTORS	—	PIEZO ELECTRIC CRYSTAL.
AUDIO INDICATOR	—	147 mm x 102 mm x 42 mm.
DIMENSIONS	—	0.4kg.
WEIGHT	—	

RADIATION METER – MODEL 81

All as Model 80, except for the detector and shock resistance. Instrument compensated for separate probes connected through a waterproof T.N.C. socket.

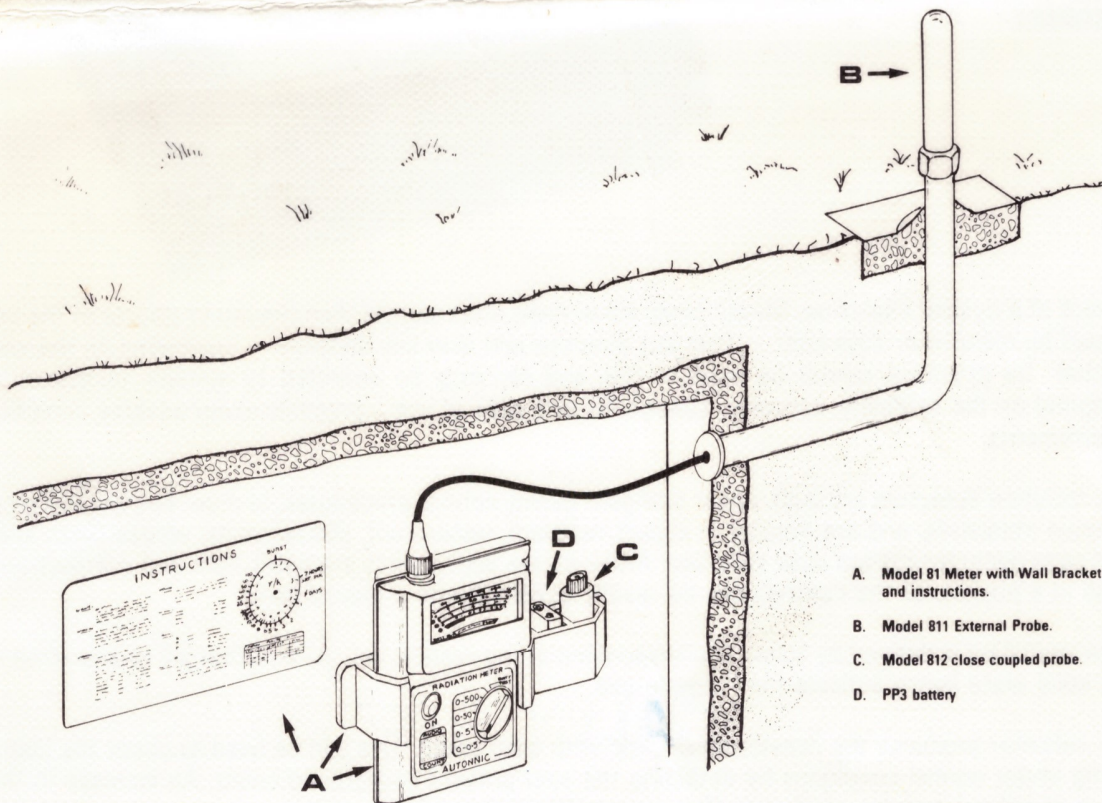

- A. Model 81 Meter with Wall Bracket and instructions.
- B. Model 811 External Probe.
- C. Model 812 close coupled probe.
- D. PP3 battery

EXTERNAL PROBE – TYPE 811

For fixed installations. (Fall-out shelters etc.) Used in conjunction with Model 81 meter.

SPECIFICATION:

PROBE CASE	—	2mm WALL HEAVILY ANODISED ALUMINIUM CASE.
INSTALLATION	—	TO STANDARD 1" GALVANISED PIPE.
HEAT FLASH RESISTANCE	—	1000°C FOR 30 SECONDS.
CONSTRUCTION	—	FULLY SEALED AND WATERPROOFED.
LEAD LENGTH	—	3 METRES.
TERMINATION	—	WATERPROOF T.N.C. PLUG
COUNT & ENERGY PERFORMANCE	—	AS MODEL 80

CLOSE COUPLED PROBE – TYPE 812

For use with Model 81, as a hand-held portable instrument.

CONSTRUCTION –

SEALED WITH FIXED WATERPROOF T.N.C. PLUG TO MOUNT DIRECT TO MODEL 81 METER.

PERFORMANCE –

ALL AS MODEL 80, EXCEPT DROP TEST.

AUTONNIC RESEARCH LTD

39 VICTORIA ESPLANADE
WEST MERSEA ESSEX
CO5 8BH ENGLAND

Telephone: West Mersea (0206) 38 2960

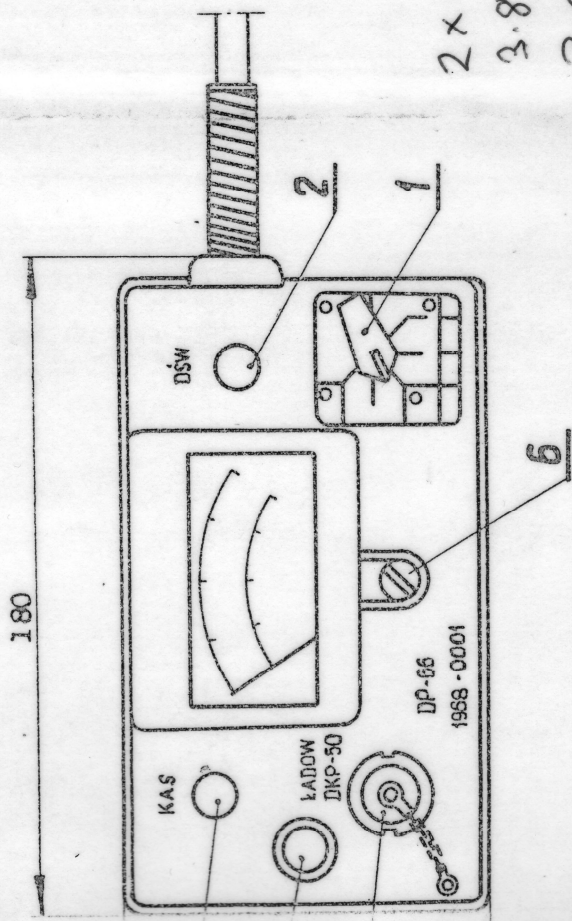
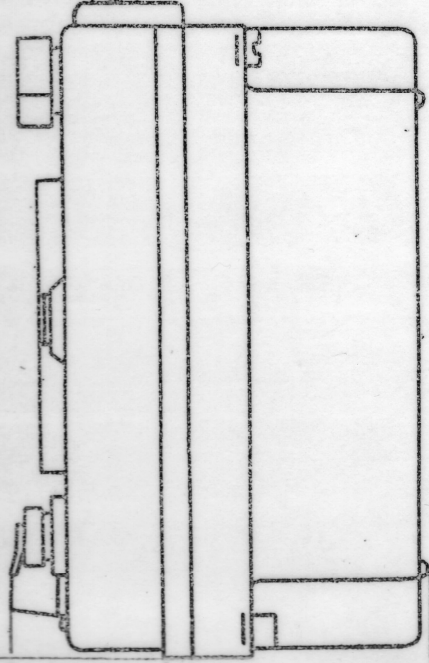
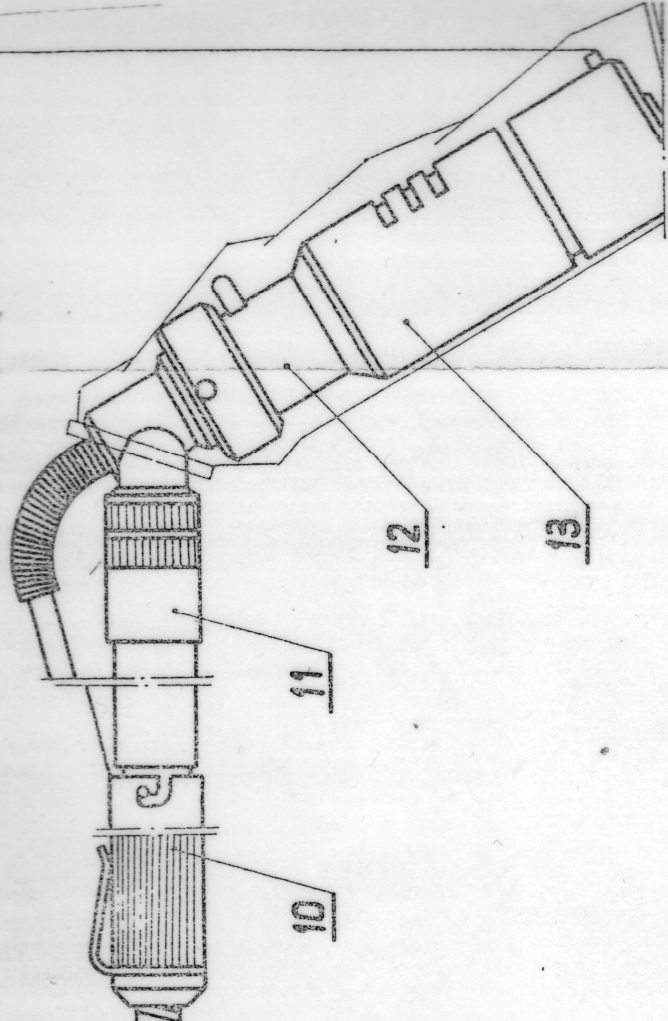

1. Rotary Switch with Voltage Check and Sub-Ranges I-V.
2. Button for Lighting the Scale.
3. Scale Reset Button.
4. Knob for Zeroing Dosimeters.
5. Dosimeter Socket for DKP-50 Optical Dosimeters.
6. Adjustment Screw to Zero the Meter.
7. Battery Compartment w/ Cover
8. Headphone Jack
9. Probe Cable
10. Probe Handle
11. Probe Extension Wand
12. Probe

2 x 1.5v batteries
 3.8 kg inc. probe
 3 GM, Tubes
 (390-490v)

Calibration based on:
 $R/hr = \sqrt{13.5 \times A(mci)}$
 R (cm)

SUPPLIED WITH 10µCi Sr90 source
 1969 POLISH RADAC: DP66



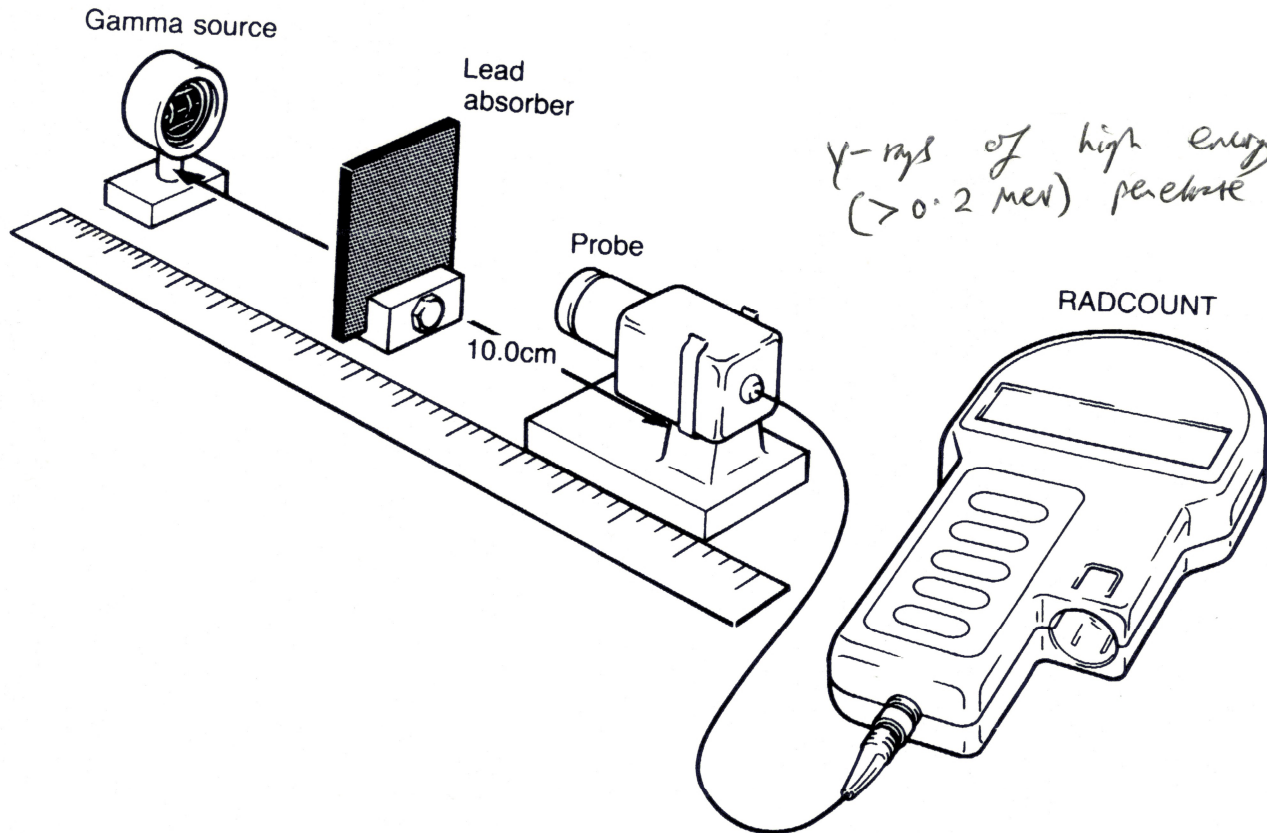
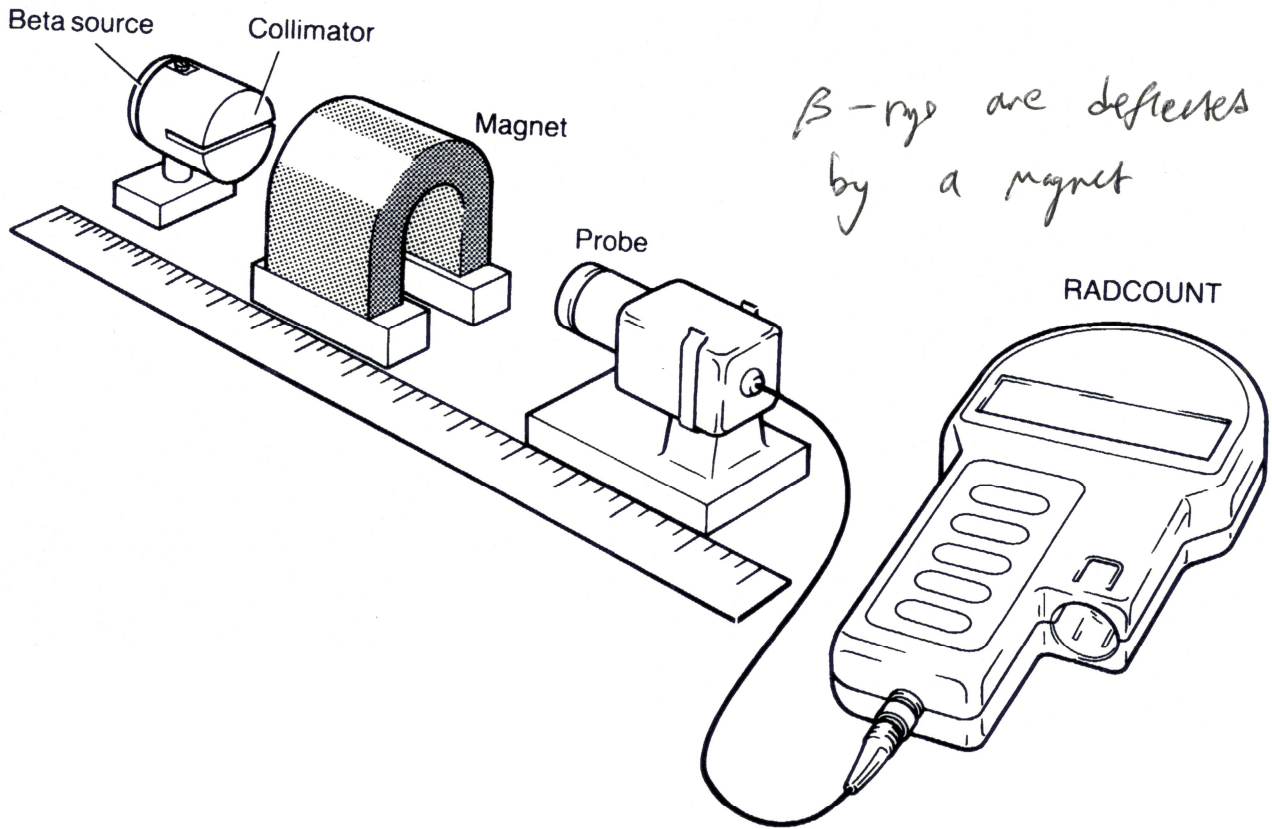

Gas-Filled Detectors

	Ionization Chamber	Proportional counter	Geiger counter
Filled with	Air or inert gas	Inert gas	Inert gas + quenching gas
Radiation detected	α β sometimes γ	α β sometimes γ	α β or γ
Gas multiplication	1	10^4	10^8
Features	Measures mean radiation intensity Measures α particle energies	Counts up to 10^6 per second Discriminates between α and β radiation Measures particle energies	Counts up to 10^4 per second Simple, robust Output pulse independent of radiation type and energy

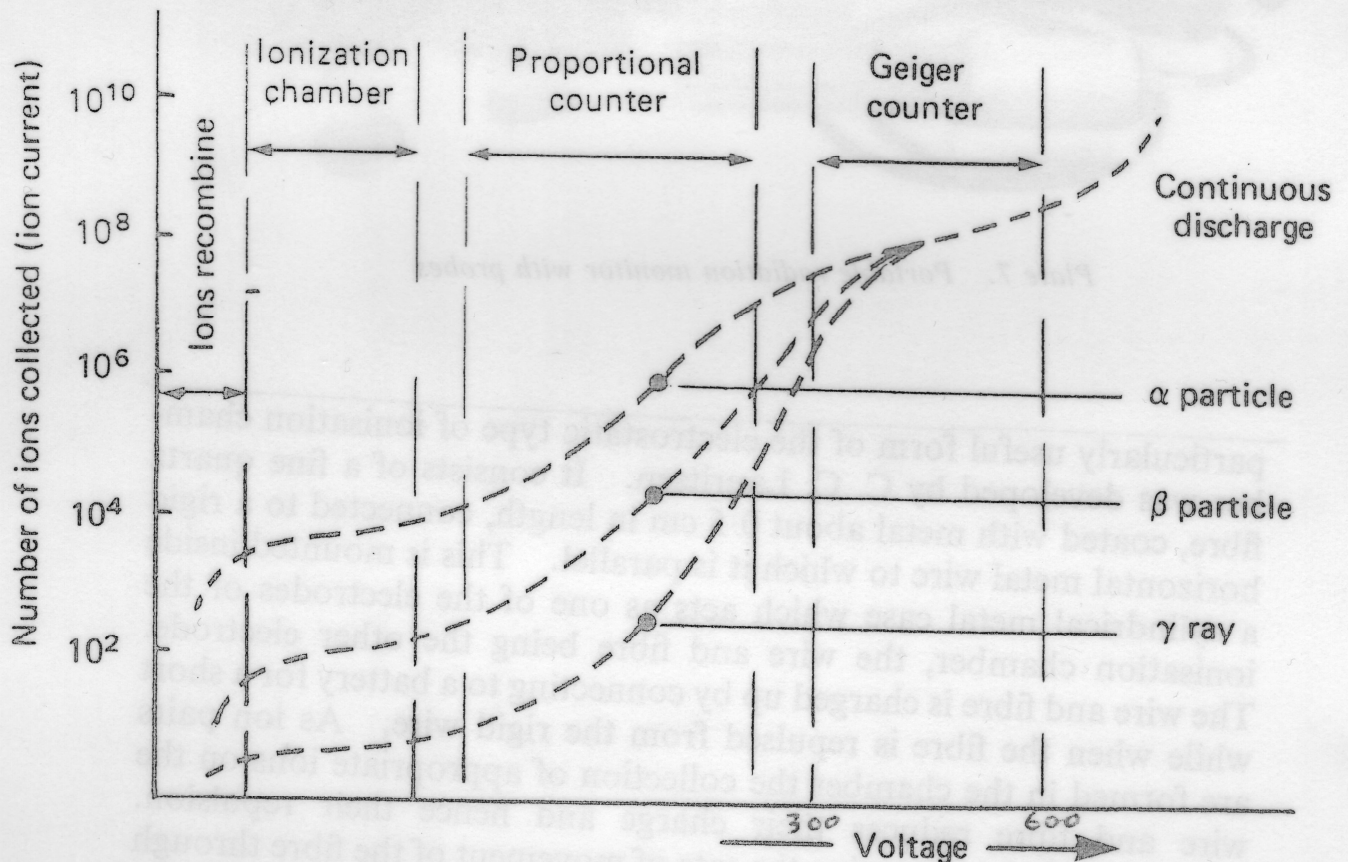

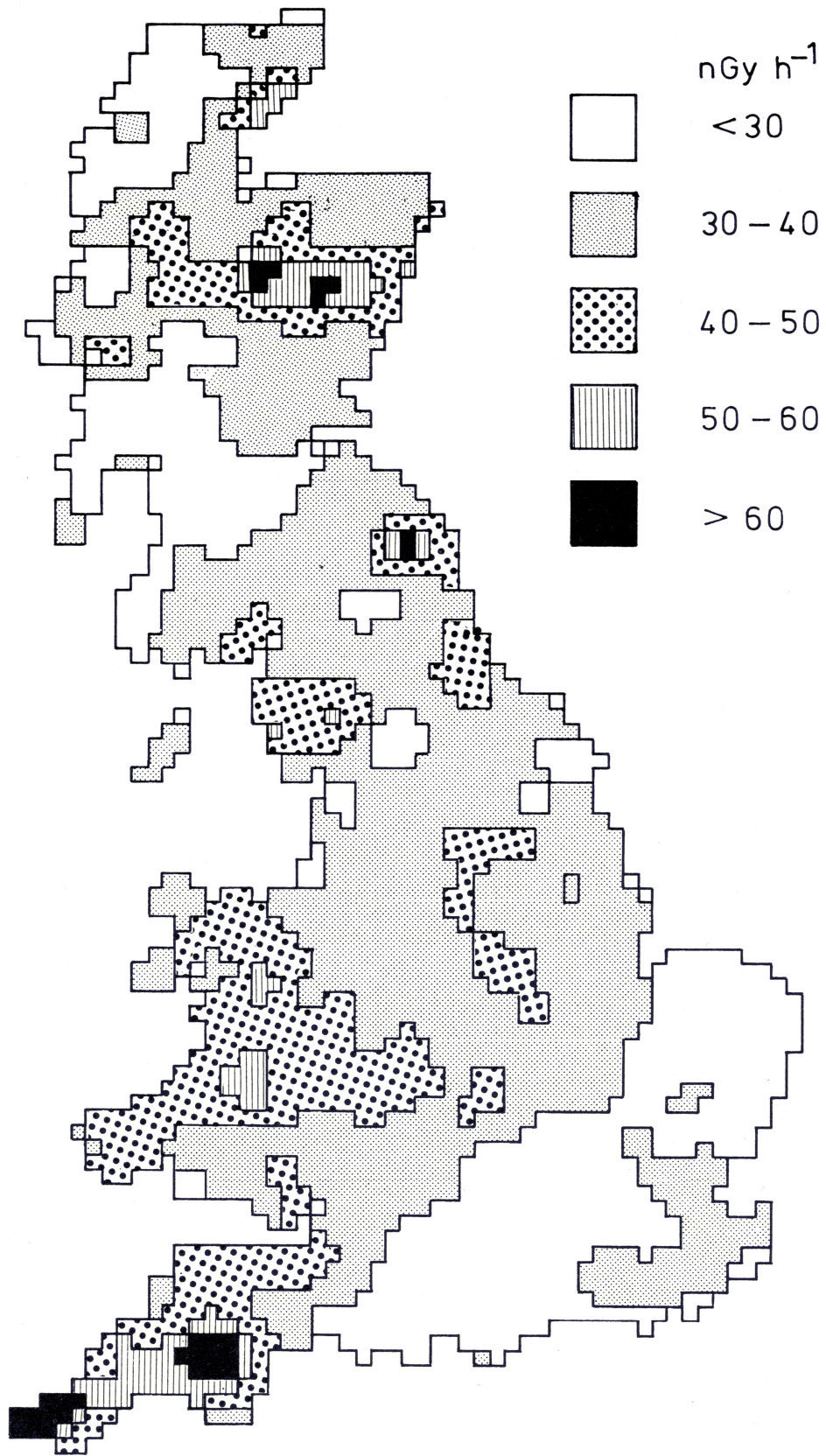

Outdoor gamma-ray dose rates in Great Britain - measurements of absorbed dose in air, with results infilled and doubly smoothed (after NRPB-R191, Figure 4)

FIGURE 4:
THE MAIN SOURCE
OF OUR RADIATION
DOSE

Examples of natural radiation exposure are given here. The information is not comprehensive and is intended merely to indicate the scale of natural radiation exposure. It is another way of looking at the sheer number of natural radioactive events causing irradiation of the body. The relationship to doses is more complicated.

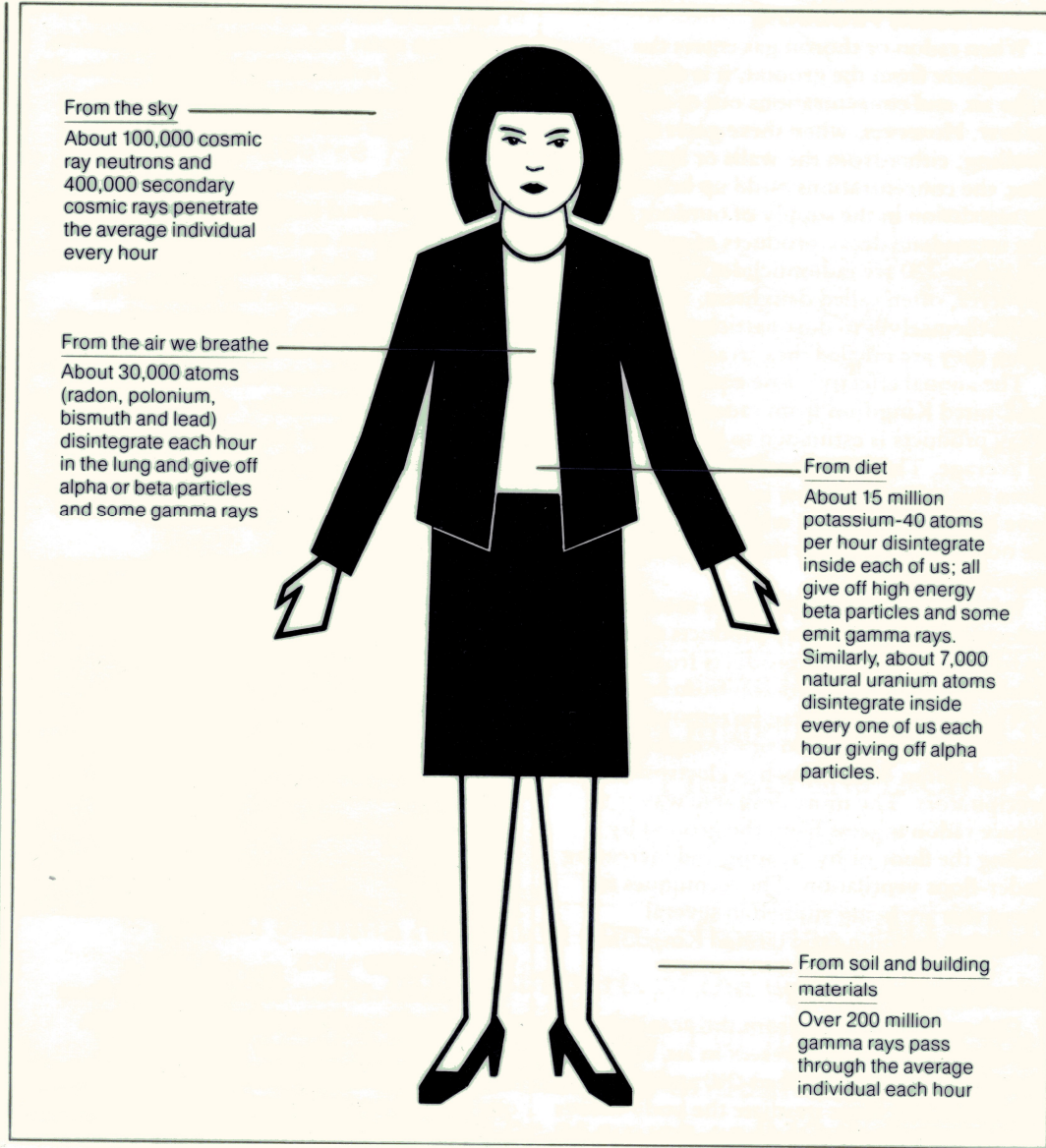

+ All Carbon
contains
220 Bq/kg
of naturally
radioactive
C-14 !!

Typical average annual doses due to natural radiation

Source	Dose ($\mu\text{Sv}/\text{year}$)
Local gamma radiation (includes external K40 and U + Th decay chains)	400
Carbon-14	10
Radon, thoron and decay products (inhalation)	800
Potassium-40 in body	200
Cosmic radiation	300
Uranium and thorium nuclides in body	170
Total:	1880

NOTE: there is a lot of variation from this average. Monazite sand areas of India and Brazil give doses of 0.12 Sv/year, i.e. 120,000 $\mu\text{Sv}/\text{year}$!

1 uCi = 37,000 decays/second = 37,000 Becquerels (Bq). 1 Curie = 3.7×10^{10} Bq.

Unit prefixes

pico (p) 10^{-12}	tera (T) 10^{12}
nano (n) 10^{-9}	giga (G) 10^9
micro (μ) 10^{-6}	mega (M) 10^6
milli (m) 10^{-3}	kilo (k) 10^3

SI units

Old units

1 gray (Gy) =	100 rad
1 sievert (Sv) =	100 rem
1 becquerel (Bq) =	1 disintegration per second
1 Bq =	2.703×10^{-11} Ci
37 GBq =	1 curie (Ci)
1 TBq =	27 Ci

NOTE:

EMERGENCY RESPONSE LIMITS (UK):

- (1) Evacuation IF predicted body dose >100mSv
- (2) Sheltering IF predicted body dose >5mSv
- (3) KI tablets IF predicted thyroid dose >50mSv

NRPB-R182

NRPB EMERGENCY DATA HANDBOOK

I F White

ABSTRACT

The NRPB Emergency Data Handbook is a compilation of useful data on the radiological aspects of civil nuclear emergencies. It is intended to be used by NRPB staff in their advisory role during emergencies (or more probably during emergency exercises), and also as an aid to other UK organisations involved in contingency planning. The radiological data are currently recommended by NRPB for those purposes; non-radiological data have been taken wherever possible from authoritative UK sources. NRPB-R182 contains the same information as the current edition of the NRPB Emergency Data Handbooks which are distributed to official bodies involved in the UK civil nuclear emergency arrangements. Unlike the official user Handbooks, NRPB-R182 cannot be regularly updated in detail, and is intended for general reference only.

National Radiological Protection Board
Chilton
Didcot
Oxon OX11 0RQ

March 1986

HMSO, £6.00

ISBN 0 85951 250 9

Half-life 2.41 E4 years; 7.61 E11 s. $\lambda = 9.11 \text{ E-13 s}^{-1}$

Major emissions and mean energies: alpha 5.24 MeV; 'beta' 7.4 keV;

X-ray 706 eV

Plume exposure

Inhalation dose (lung class Y):

most highly exposed organ (bone surface, adult) 2.5 E-7 Sv per Bq s m⁻³
 effective dose (adult) 2.3 E-8 Sv per Bq s m⁻³

DERLs of time-integrated air concentration:

evacuation upper 5.9 E6 Bq s m⁻³; lower 1.2 E6 Bq s m⁻³
 sheltering upper 9.9 E5 Bq s m⁻³; lower 2.0 E5 Bq s m⁻³

(basis: bone surface dose to adult)

Resuspension of ground contamination

DERLs of ground contamination:

evacuation upper 4.9 E6 Bq m⁻²; lower 9.8 E5 Bq m⁻²

(basis: bone surface dose to adult)

Ingestion pathways Basis: 2.1 E-7 Sv Bq⁻¹ to bone surface of adult
 (1.6 E-8 Sv Bq⁻¹ effective dose to adult)

Pathway	Dose		DERLs		units
			upper	lower	
Green	5.0 E-8	Sv per Bq m ⁻²	1.0 E7	1.0 E6	Bq m ⁻² initial deposit
vegetables	1.7 E-7	Sv per Bq kg ⁻¹	3.0 E6	3.0 E5	Bq kg ⁻¹ fresh weight
Fruit	1.3 E-7	Sv per Bq kg ⁻¹	4.0 E6	4.0 E5	Bq kg ⁻¹ fresh weight

Many types of reactor accident would result in the release of iodine radionuclides, owing to their high fission yields and the volatility of iodine. For many accident sequences, radioiodine will dominate decisions on countermeasures in the initial and intermediate phases. Radioiodine therefore merits separate discussion.

6.1 Estimation of source terms

Even if the radioiodine nuclides were the only ones released, estimation of source terms from environmental measurements is not a simple problem. The main nuclides involved are:

iodine-131	(half-life 8.04 days, mean gamma energy 380 keV)
iodine-132	(half-life 2.30 hours, mean gamma energy 2.28 MeV)
iodine-133	(half-life 20.8 hours, mean gamma energy 607 keV)
iodine-134	(half-life 52.6 mins, mean gamma energy 2.54 MeV)
iodine-135	(half-life 6.61 hours, mean gamma energy 1.57 MeV)

After a few days, the only iodine nuclide of any significance will be iodine-131. However, the shorter-lived nuclides are more significant in the initial phase of a reactor accident, and are all of comparable importance.

At the instant of reactor shutdown, the inventories of all these short-lived iodine radionuclides are in a fixed ratio⁽¹⁾. Since all isotopes of the same element will have the same release fraction, the ratio of ^{131}I : ^{133}I : ^{135}I in the environment will be a simple function of decay time since shutdown.

That is not true for iodine-132 and iodine-134, since they continue to be produced after shutdown by beta decay of tellurium-132 (3.26 days) and tellurium-134 (41.8 mins). So the environmental concentrations of iodine-132 and iodine-134 will partly depend on the ratio between the release fractions of iodine and of tellurium, which in turn depends on the particular accident sequence.

Figure 6.1 shows the iodine-131 fraction of the total radioiodine activity as a function of time after shutdown, either if tellurium is released as efficiently as iodine or if no tellurium is released.

In the early phase of a reactor accident, only a small percentage of the gamma dose rate from deposited iodine activity is due to iodine-131. One hour after shutdown it would be about 3% if the release fractions of iodine and tellurium were equal, or about 4% in the absence of tellurium.

By far the best way to estimate source terms for radioiodine - and all other radionuclides - is by obtaining radionuclide spectra. If no gamma

spectrum is available, it is conservative to assume that 25% of total iodine at shutdown was iodine-131 (Figure 6.1).

6.2 Effectiveness of stable iodine tablets⁽²⁾

After an intake of radioiodine, 50% of the ultimate uptake into the thyroid takes place within about 6 hours, and the remainder within a day. 100 mg of stable iodine administered as iodide or iodate will isotopically dilute radioiodine awaiting uptake, and although the total iodine uptake is little affected, the uptake of radioiodine is effectively 'blocked'.

If stable iodine is administered before the intake of radioiodine, blocking is essentially complete within 30 minutes or less, and would be effective for intakes within the next 24 hours.

Even if it is not possible to anticipate the release of activity, there is still some value in administering stable iodine within the next few hours, because uptake of already inhaled radioiodine by the thyroid will be incomplete. Further uptake can be blocked, though existing uptakes cannot be purged. The approximate effectiveness of delayed administration, in terms of averted thyroid doses from iodine-131, is as follows.

Delay time (hours)	Effectiveness (%)
0	97
2	80
4	60
6	50

It is a matter of judgement whether the administration of stable iodine after a delay of some hours is feasible in any particular situation, or is an effective use of emergency resources. Although stable iodine could also be used to reduce thyroid doses from ingestion of contaminated foodstuffs, especially milk, it is more practical to ban the foodstuffs themselves.

6.3 Milk bans

Owing to the delay between the deposition of radioiodine, its ingestion by cows or goats, and the consumption of the milk by humans, the only iodine radionuclide of relevance in decision making is iodine-131 (though iodine-133 could make a small contribution to doses). The Ministry of Agriculture, Fisheries and Food⁽³⁾ and their counterpart in Scotland have arrangements for sampling and disposal of contaminated milk, which would be collected from regular producers in the normal way, and for notifying other producers and consumers.

While the ultimate criterion for banning milk for human consumption would be the iodine-131 concentration in the milk, this concentration would take some days to develop (Figure 4.1), and the duration of the ban would depend on the peak concentration reached. Also, the necessary administrative arrangements would require time and considerable effort to implement. Thus it is necessary to predict the requirements for a milk ban during the intermediate phase of an accident.

The ground concentration of iodine-131 at any place and time after an accidental release can be estimated using the data in Chapter 5. The effort required to implement a milk ban depends on the total area affected, ie, on the square of the radius affected, so the estimates need to be as accurate as possible.

Theoretical estimates should be backed up as soon as possible by measurements of the iodine-131 ground concentration. At the ground concentration of iodine-131 corresponding to the ERL of dose via milk, the gamma radiation is not measurable over natural background radiation; analysis of grass samples is required.

The peak concentration of iodine-131 in milk corresponding to the relevant ERL of thyroid dose to a 1-year-old infant is 2 kBq l^{-1} (iodine-131 data sheet, Chapter 4). This DERL is predicted⁽⁴⁾ to correspond to a DERL from ground concentration of 13 kBq m^{-2} . The prediction is based on the assumption that cows are fed entirely on contaminated herbage, which is unlikely to be the case in winter when cows may even be fed entirely on artificial foodstuffs. Careful and informed judgement is thus required.

6.4 References and notes

1. At the instant of reactor shutdown, the inventories of any radio-nuclides whose half-lives are short compared with the total irradiation time will be in the fixed ratio of their fission yields. This result is virtually independent of the type of thermal reactor, the fuel rating or the burnup. A different set of fixed ratios would apply for fast reactors.
2. Ramsden, D, Passant, F H, Peabody, C D and Speight, R G, Radioiodine uptakes in the thyroid: studies of the blocking and subsequent recovery of the gland following the administration of stable iodine. Health Phys., 13, 633-646 (1967).
3. Ministry of Agriculture, Fisheries and Food, MAFF Sizewell emergency plan. Sizewell Inquiry document MAFF/S/3(Saf) (1982).
4. Linsley, G S, Crick, M J, Simmonds, J R and Haywood, S M, Derived Emergency Reference Levels for the introduction of countermeasures in the early to intermediate phases of emergencies involving the release of radioactive materials to the atmosphere. Chilton, NRPB-DL10 (1986) (London, HMSO).

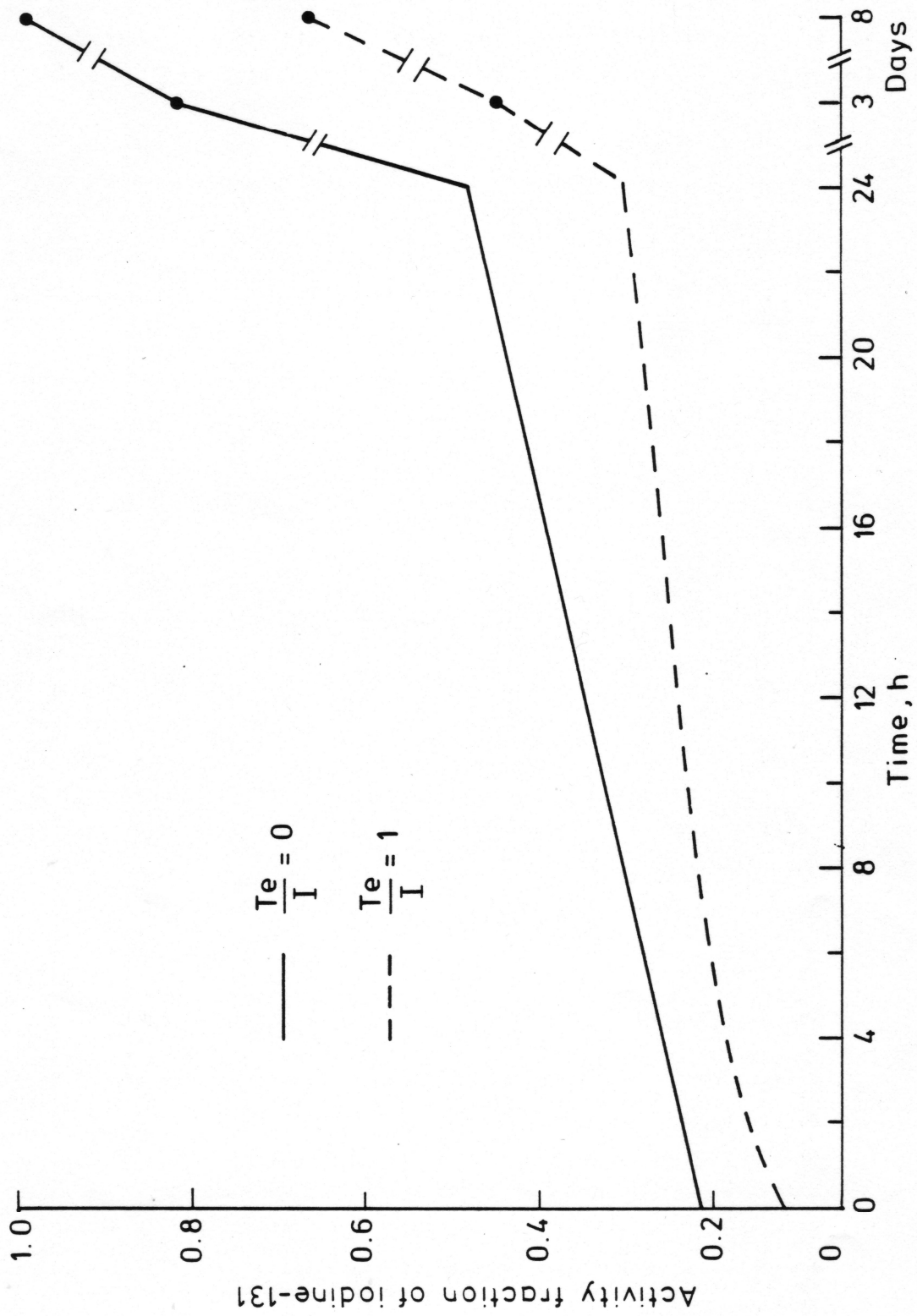

Figure 6.1 Fraction of iodine-131 in total iodine isotopes

METERS, CONTAMINATION, No.1

INTER - SERVICE Catalogue No.5CG 0012

INSTRUCTION MANUAL ISSUE. 1

Published by:

Specifications and Manuals Section, A.E.R.E. Harwell, from whom extra copie

111 x 7 1/2 x 10 1/2
3.91 71
14 1/2
444



HAVERSACK

CONNECTOR

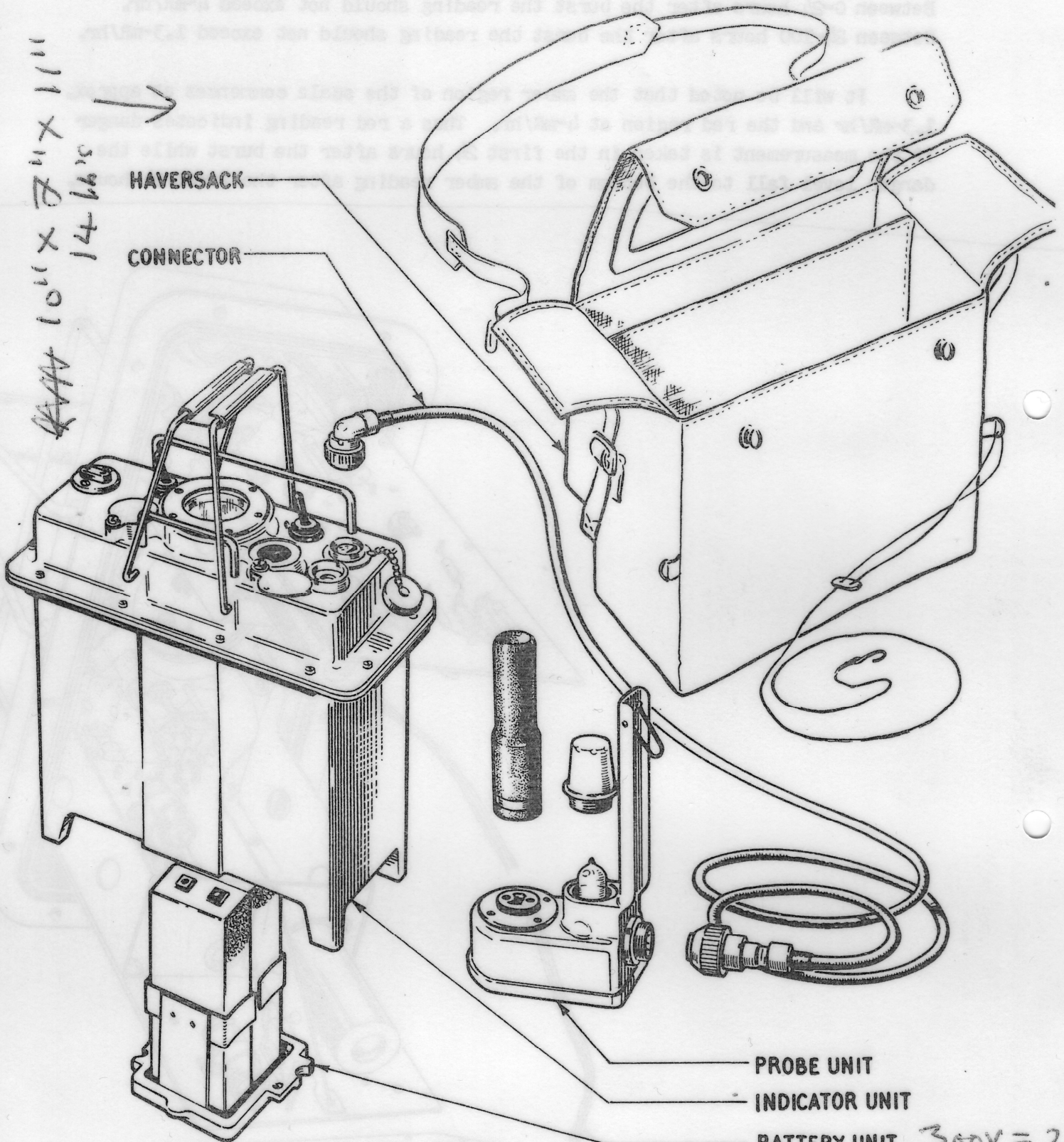

PROBE UNIT

INDICATOR UNIT

BATTERY UNIT

300V = 2
150V (TUBES 2X 150V)
EVERREADY: B.1565.

METER CONTAMINATION No.1.

Between 0-24 hours after the burst the reading should not exceed 4-mR/hr.
Between 24-100 hours after the burst the reading should not exceed 1.3-mR/hr.

It will be noted that the amber region of the scale commences at approx. 1.3-mR/hr and the red region at 4-mR/hr. Thus a red reading indicates danger if the measurement is taken in the first 24 hours after the burst while the danger level fall to the bottom of the amber reading after the first 24 hours.

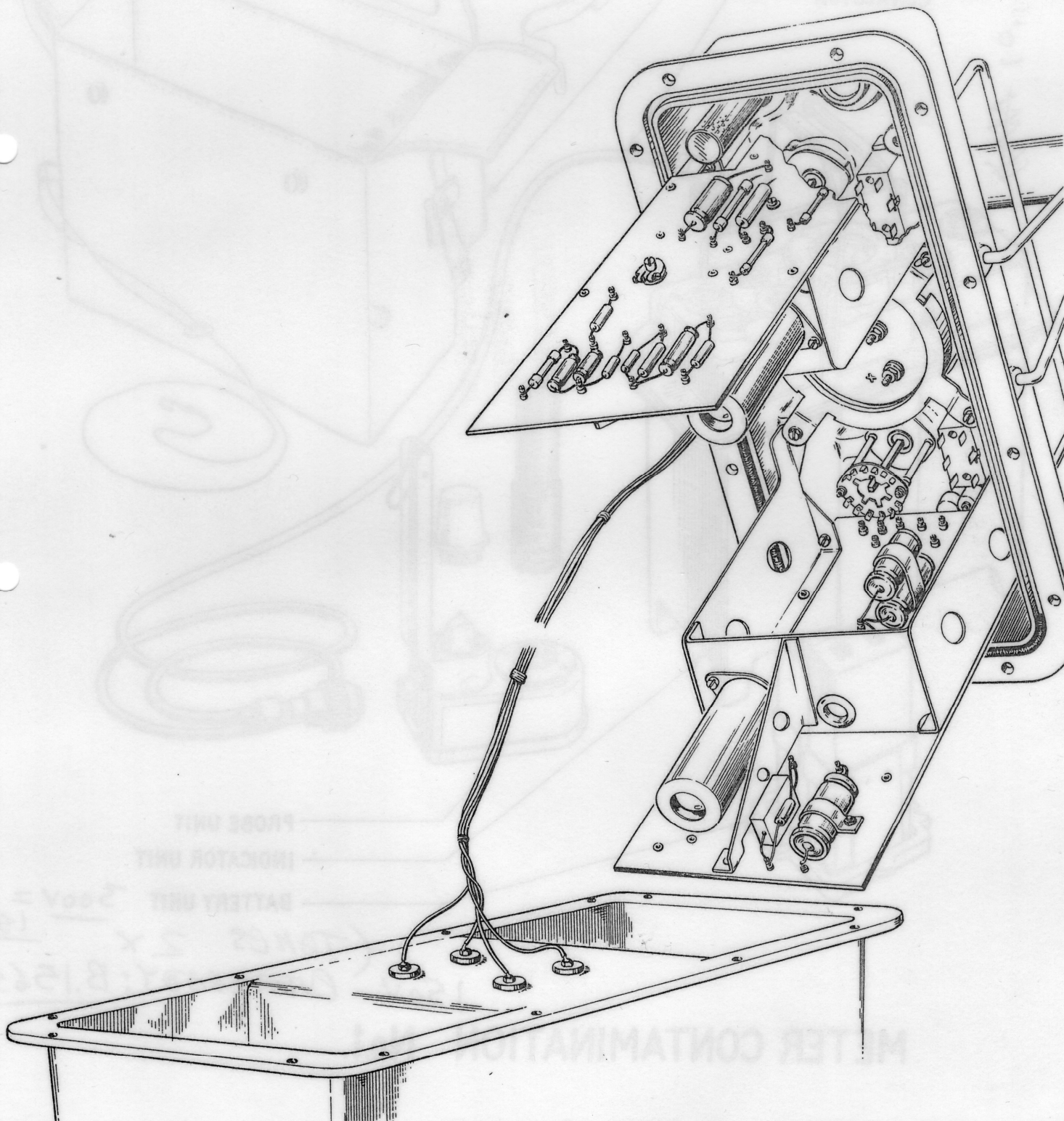

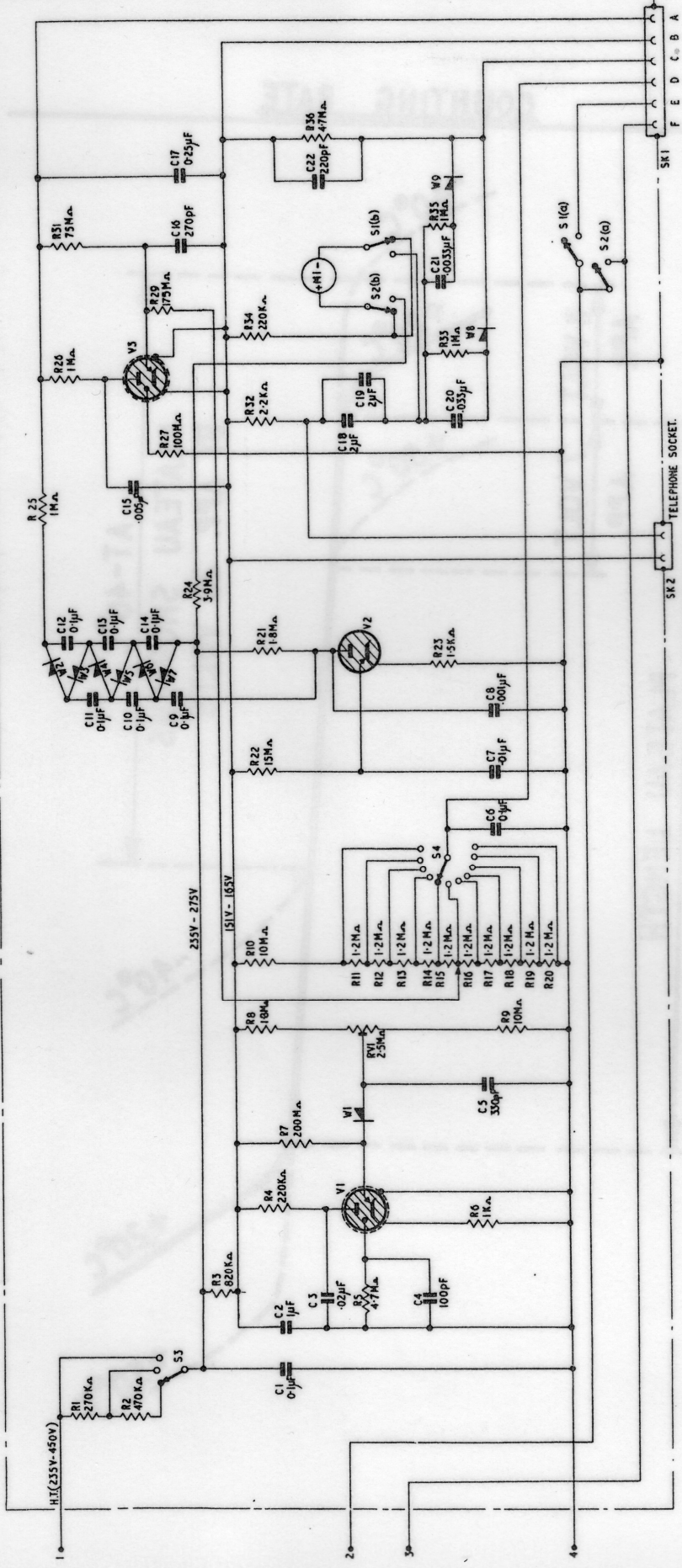

V1 = COLD CATHODE VOLTAGE STABILIZER (160V)
 V2 = COLD CATHODE OSCILLATOR (D.C. → A.C.)
 W2 - W7 = CALIBRATED - WATSON VOLTAGE MULTIPLIER (650 V A.C.)
 V3 = COLD CATHODE VOLTAGE STABILIZER (415 - 420 V OUTPUT)

FIG. 5.

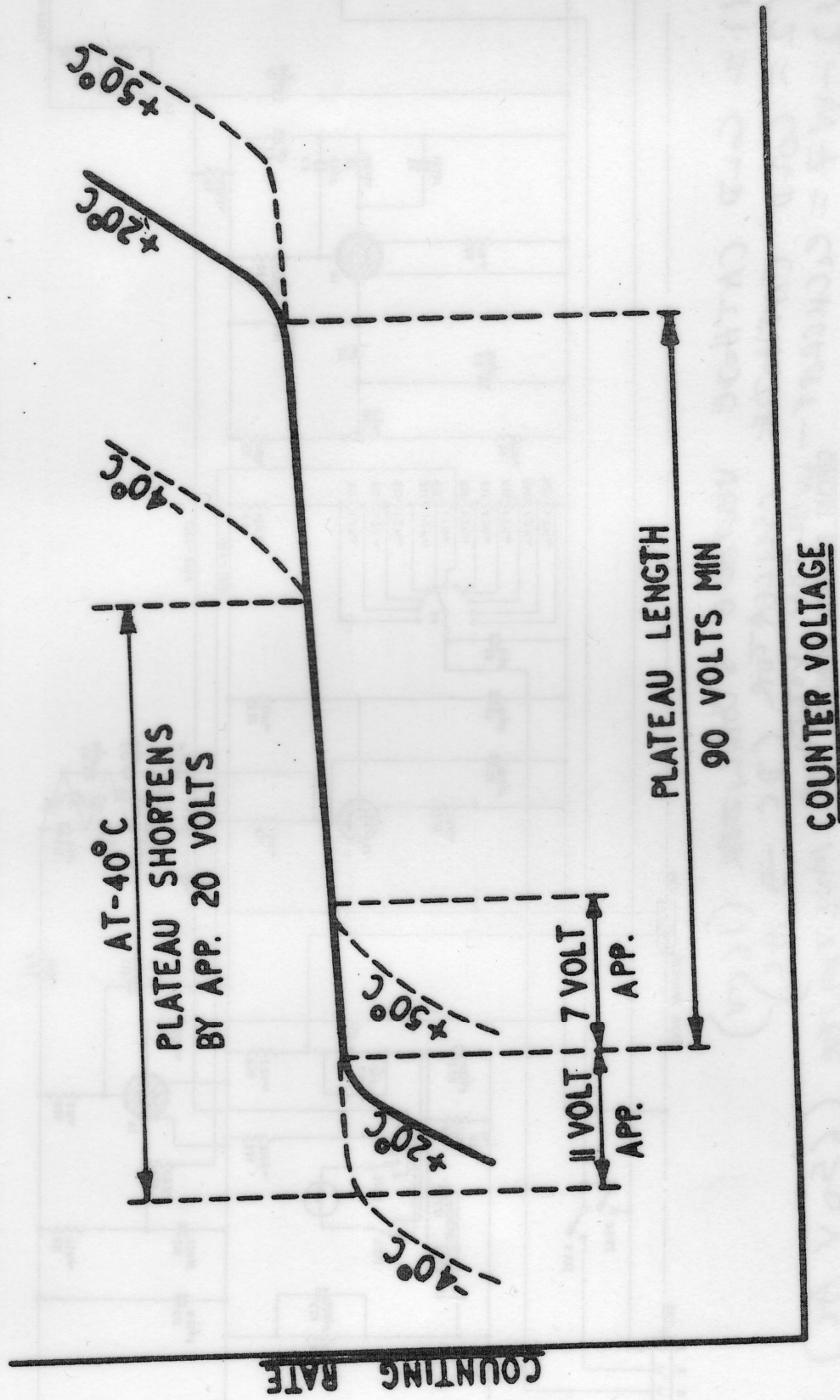

METER CONTAMINATION NO. 1. TYPICAL COUNTER PLATEAU AND TEMPERATURE EFFECT.

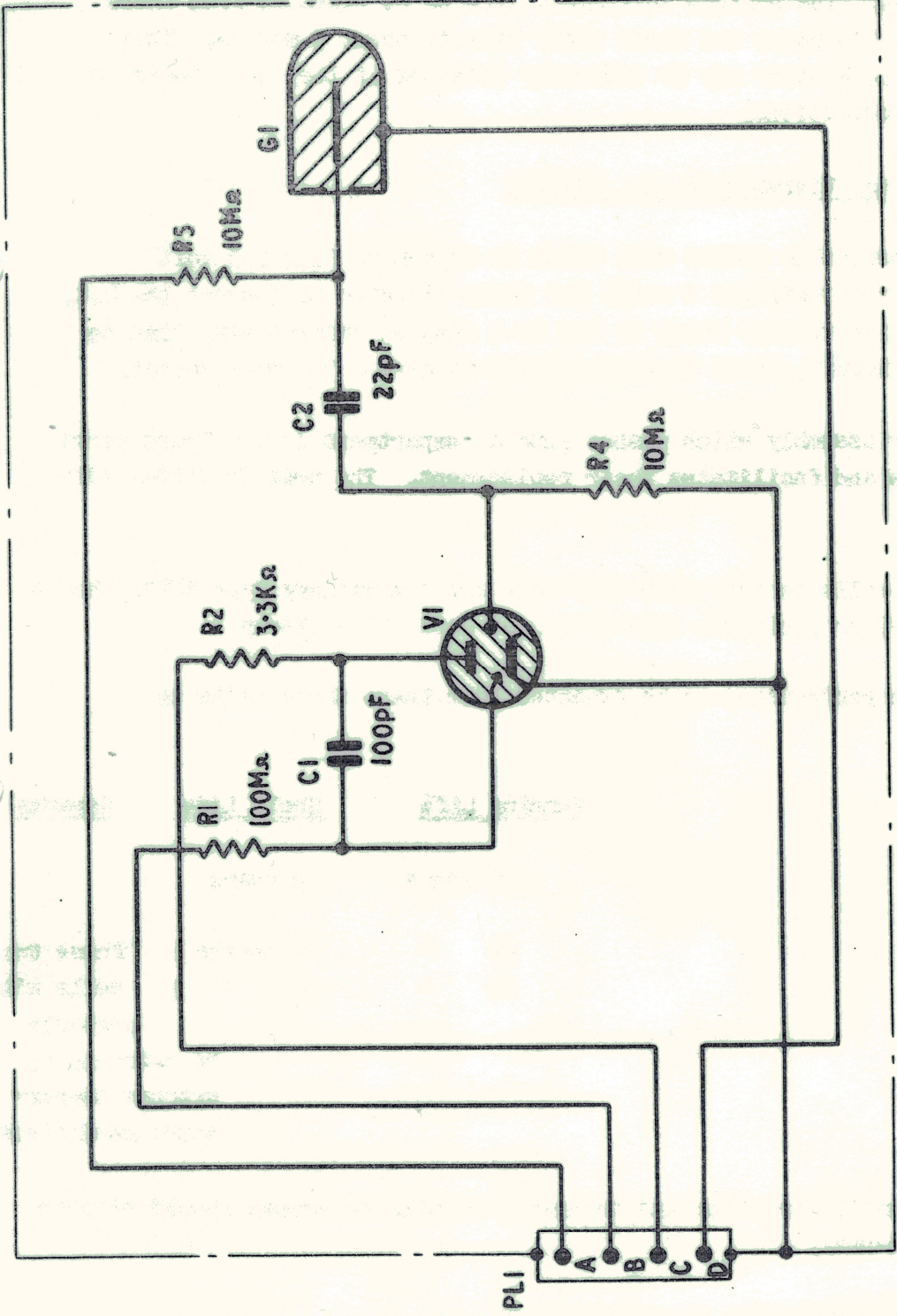

G1 = NEON, ARGON & BROMINE FILLED
 GEIGER - MULLER (LOW-PRESSURE TUBE).

V1 = COLD CATHODE LOGARITHMIC AMPLIFIER.

CIRCUIT DIAGRAM (PROBE) - LOG RATE METER
CIRCUIT

See new diagram,

(a) Battery Unit

This comprises a Battery Holder ref. 5CG0030 plus two 150 volt batteries Ever Ready Type B1565. The average instrument life to be expected from these batteries is approx. 600 hours and their shelf life is about 9 months. Their shelf and running life however may be adversely affected if they are stored in extreme temperature conditions.

(b) Power Units, Vibrator No. 1 5CG0029

This is a hermetically sealed unit which is driven by four 1.3 volt Mallory cells. The unit utilises a small low power vibrator to convert the D.C. input to an alternating voltage which is fed to a step up transformer, then to a voltage doubling circuit, where it is rectified to give a 300 volt output.

A small drawer assembly which pushes into a compartment in the front panel holds the four cells and facilitates their replacement. The unit is fitted with a desiccator.

The preferred cells for use with this unit are the Mallory Type RM12, though the Kalium Type VO107 or Leclanche size U7 can be used if necessary.

Details of the performance to be expected from these three cells is given below.

	<u>Running Life</u>	<u>Shelf Life</u>	<u>Remarks</u>
Mallory Type RM12	120 hours	2 years	
Kalium Type VO107	50 "	9 months)	These two cells will probably be affected by extreme temperature conditions.
Leclanche size U7	20 "	9 ")	

For full circuit description and technical details reference should be made to the appropriate manual.

(c) Power Units Mains No. 1, ref. 5CG0028

This unit is designed where static application of the monitor is required and mains supplies are available.

1954:



“ Hand and foot ” radiation monitors in use.

Another interesting contamination monitor is the hands-and-feet monitor. These are installed in batteries in all the change rooms at Windscale so that on leaving to go to a meal the workers can check that their hands, feet, and clothes are free from contamination. In this monitor particular care is taken with the hands, counters being provided to check alpha and beta-gamma contamination separately. Two probes for checking clothes are also provided, one for alpha and another for beta-gamma; the alpha clothes probe makes use of the scintillation counter described above.

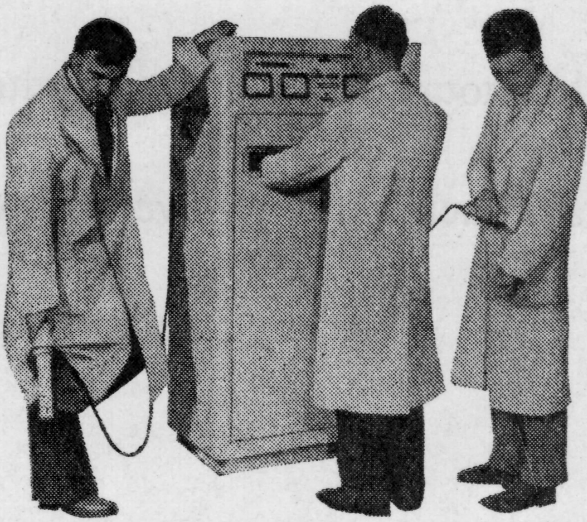

Hand and Clothing Monitor

E.M.I.—THE SPECIALISTS IN NUCLEAR HEALTH MONITORING EQUIPMENT

The Hand and Clothing Monitor has been specially designed to cope with large numbers of staff. Whilst Alpha and Beta contamination are being simultaneously checked on both hands, the footwear and clothing of two other workers are being screened.

The speed, simplicity and safety of E.M.I.'s new Monitor have been recognised by large orders from the U.K.A.E.A. and authorities in many other countries.

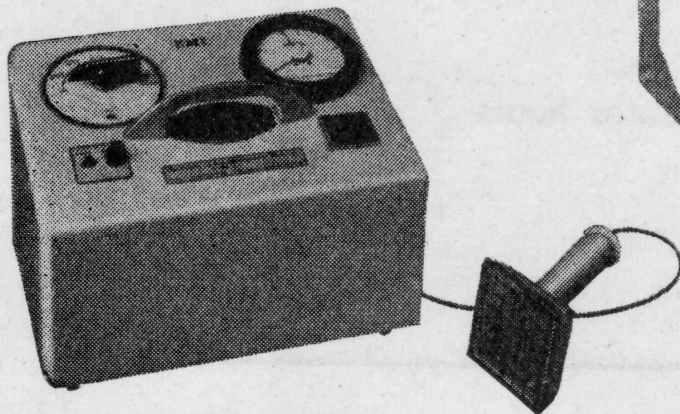

Portable Monitor

The Portable Monitor is the answer where mobility is required. Compactness and high accuracy have been achieved by combining all-transistor circuitry with the E.M.I. dual phosphor technique. This instrument, developed in close collaboration with the U.K.A.E.A., marks a really significant step-forward in radiation detection.



Write or telephone now for a demonstration and full details

E.M.I. ELECTRONICS LTD

**INSTRUMENT DIVISION • HAYES • MIDDLESEX
TELEPHONE: SOUTHALL 2468 • EXT. 2223**

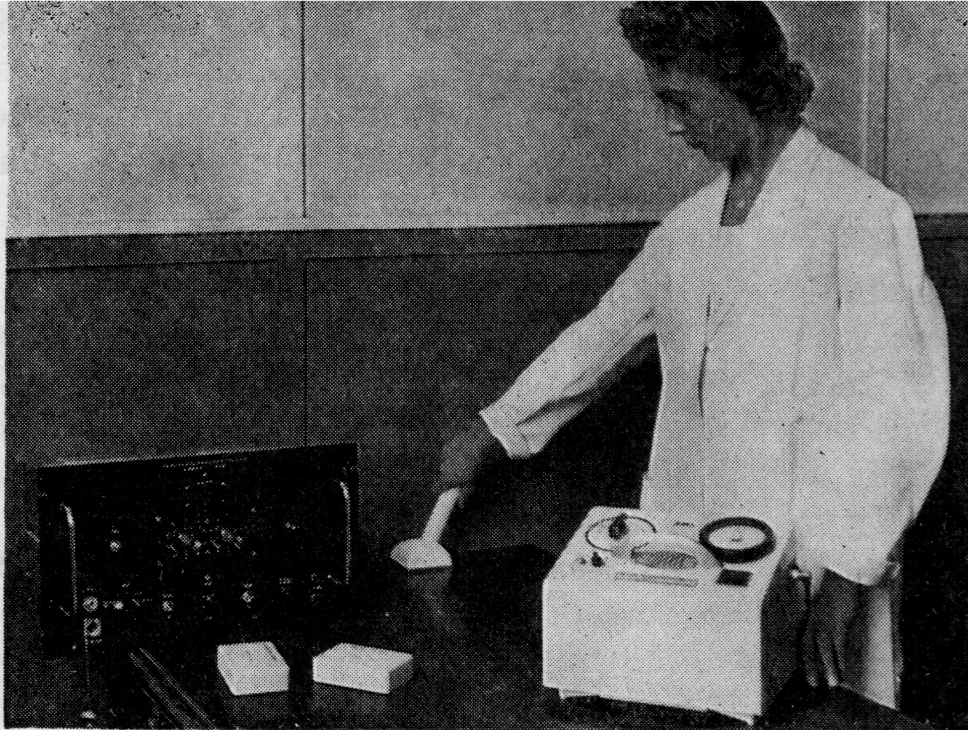

Portable contamination monitor made by EMI Electronics, Ltd. Using dual phosphor techniques with special circuits, it is possible to monitor alpha and beta particles simultaneously

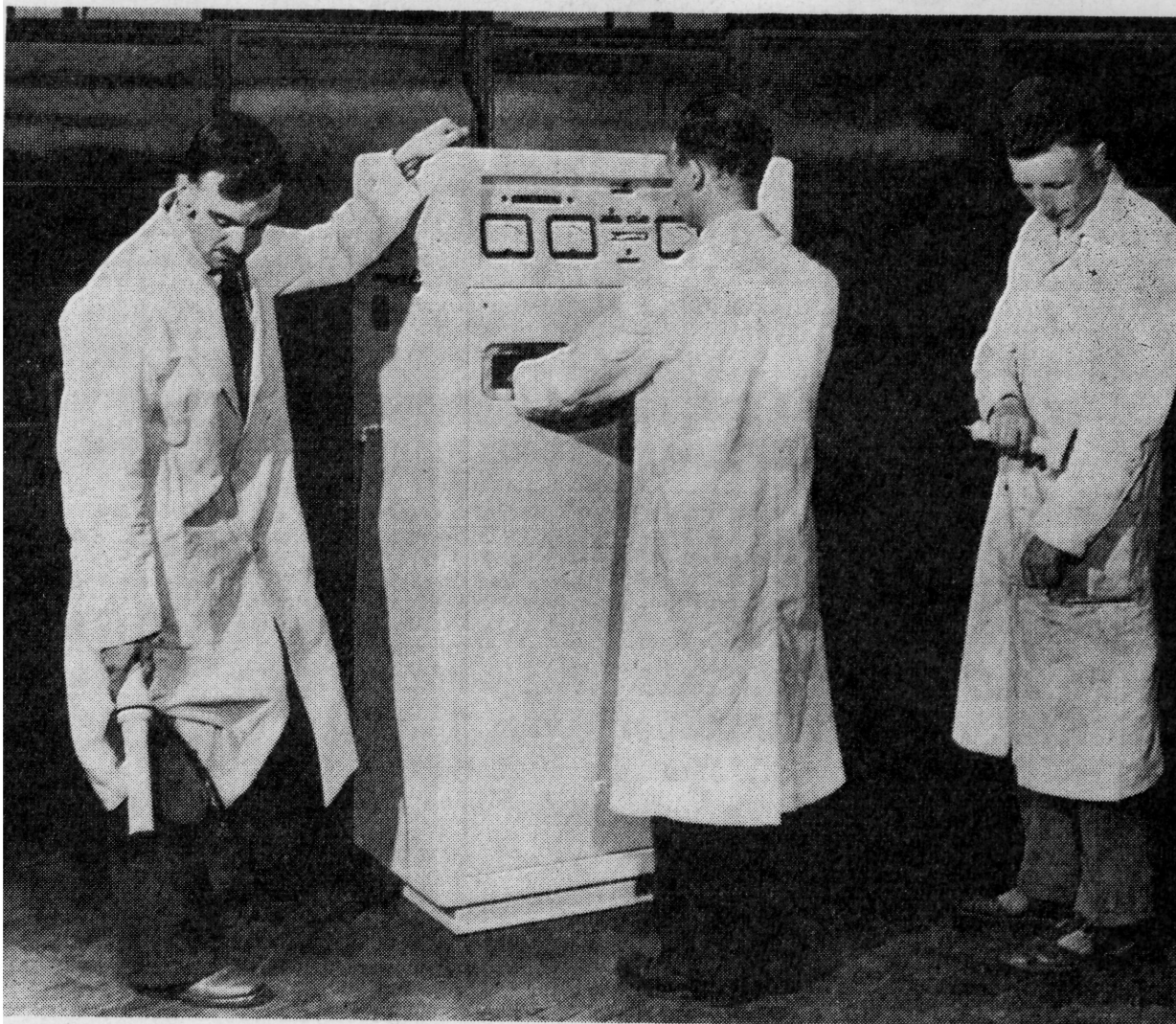

Hand and clothing monitor made by EMI Electronics, Ltd. This instrument can check a person's hands simultaneously for alpha and beta contamination and at the same time monitor the clothing of two other people. Counting time for the hand monitoring is five seconds. Two independent probes are used for monitoring clothing 1960

PANAX Nucleonic Instruments

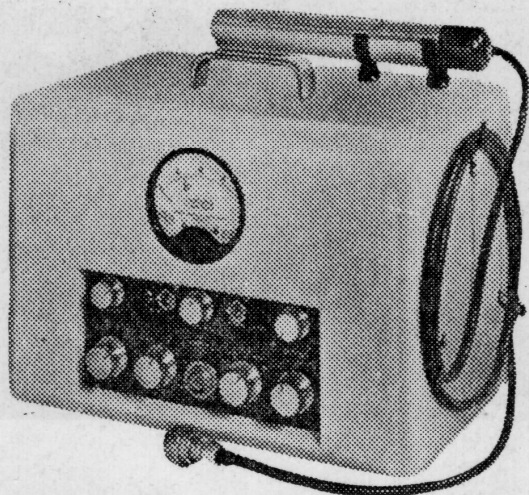

GENERAL PURPOSE RADIATION MONITOR TYPE 5054 Ratemeter ranges 0-400, 0-2,000, 0-10,000 and 0-40,000 cpm. Int. time constants 1-5-25 Sec. Discriminator range 0.1-5v neg. 1-50v pos. Stabilized EHT variable 0-2Kv. Various probes available: Beta, Gamma, large area Alpha.

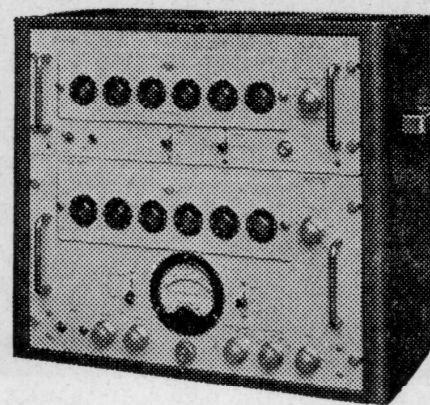

AUTO-SCALER TYPE AC/300/6 Complete automatic counting equipment with preset count and preset time facilities. Stabilized EHT supply 0-2,000v. Accurate metered discriminator 1-50v pos. and 0.1-5v neg.

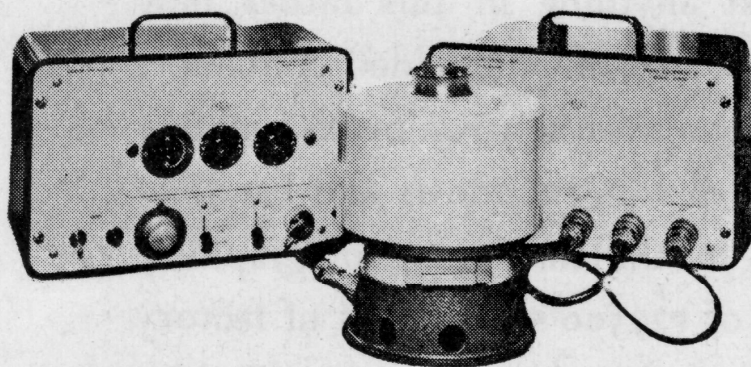

HIGH SENSITIVITY LOW BACKGROUND GEIGER COUNTING EQUIPMENT An anti-coincidence assembly comprising lead castle type LC-5 which houses a Mullard guard counter assembly type MX157, Scaler type SA.102 and anti-coincidence unit type AU460. Typical backgrounds less than 1.5 cpm.

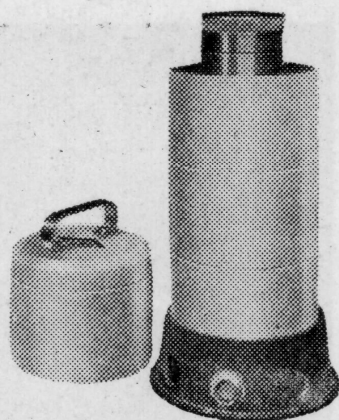

WELL COUNTER TYPE USC-B One of a range of scintillation counters shown assembled in the popular Universal Lead Castle type LC-3. This castle can also be used for liquid and end window geiger counting.

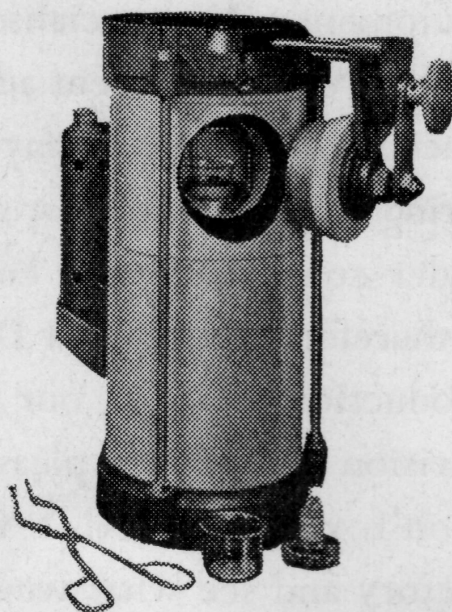

SCINTILLATION COUNTER TYPE SC-LP For the measurement of very weak beta emitters using liquid phosphors. Anthracene crystals. Zinc sulphide screens and sodium iodide crystals can also be accommodated. Cooling coils are fitted and a special refrigerator unit is available for use when the high efficiency counting of ^3H is required under plateau conditions.

PANAX EQUIPMENT LTD
HOLMETHORPE INDUSTRIAL ESTATE
REDHILL, SURREY

Telephone: Redhill 3511 (2 lines)

1960

AIRMEC 1961 MONITOR

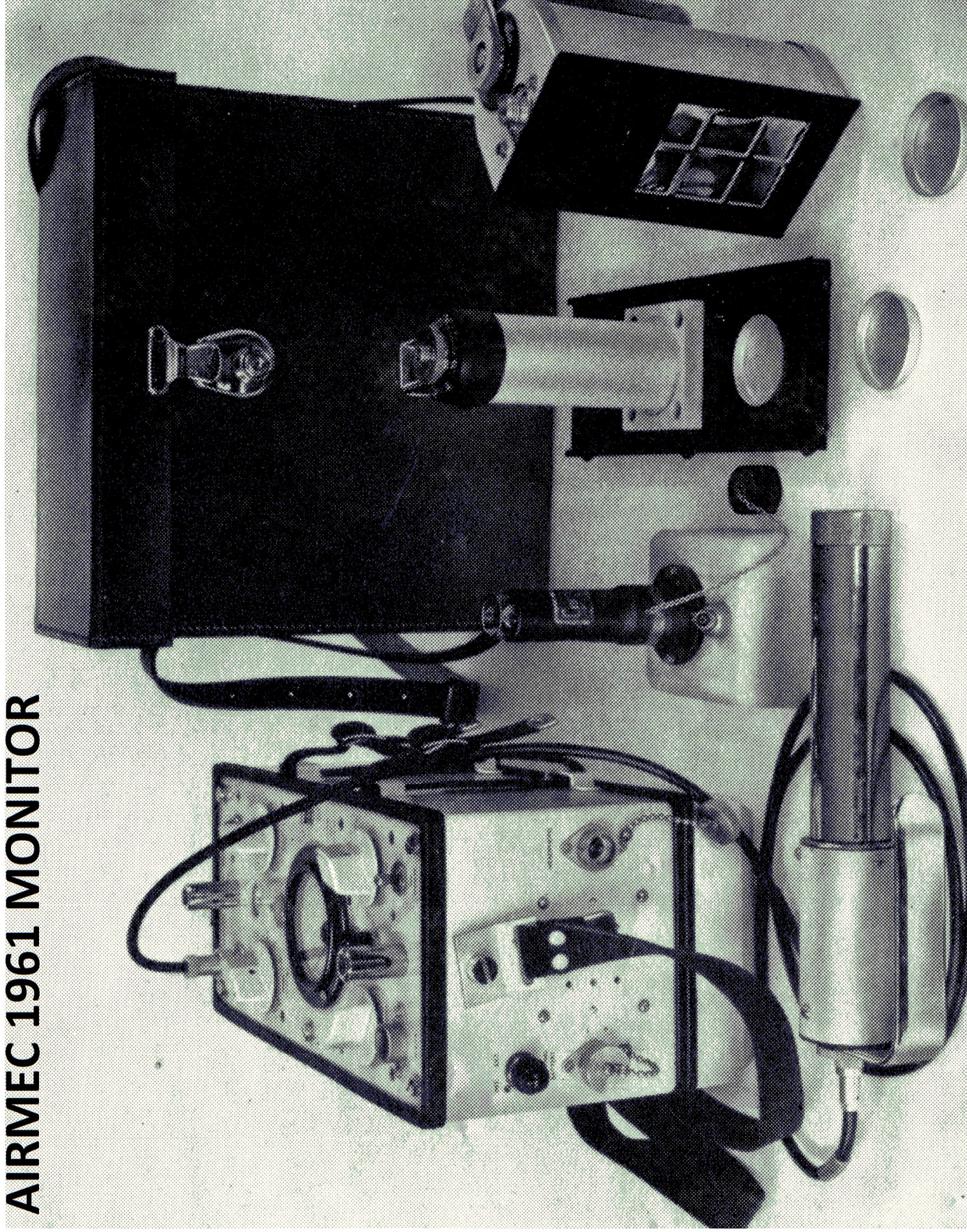

EXAMPLES OF NATURAL RADIOACTIVITY

GAS MANTLE: Fabric impregnated with a thorium salt. On sale in camping and caravanning supply shops. The thorium salt decomposes to thorium oxide when heated in a gas flame and the material then radiates a bright white light instead of the pale yellow light characteristic of a normal gas flame.

LUMINOUS ALARM CLOCK: Painted with radium to glow in the dark. Until the mid 1960's radium paint was often applied to alarm clocks, watches, timing clocks in photographic dark rooms and aircraft instruments.

PITCHBLLENDE: One of the ores of uranium. Technically it is impure uraninite, which itself is uranium oxide. This sample was collected by the geologist Hilary Corke from the St Ives beach in 1969.

SOIL SAMPLE, HARWELL REACTOR SITE: Part of a sample taken by Health Physics personnel downwind, and close to, Dido and Pluto reactors. The two reactors have been working for 30 years.

MUD SAMPLE, RAVENGLASS ESTUARY: Part of a sample taken by EMSc Division personnel from the region of heaviest contamination on the Ravenglass estuary. Ravenglass is to the South of Sellafield and is one of the most heavily contaminated areas from Sellafield in Cumbria.

AUFUNITE ON GRANITE: Autunite is a yellow coloured, complex, secondary mineral containing uranium phosphate. Sample collected by one of our operators from the Merrivale Quarry, near Tavistock, in South Devon. The quarry is currently being worked with the granite mainly being used for funeral masonry!

CORNISH MINE WASTE: Spoil from an old mine tip collected by one of our presenters. Men have been digging up tin in Cornwall since Phoenician times and the unwanted uranium has ended up on old spoil heaps in a number of parts of Cornwall.

MONAZITE CRYSTAL: Monazite occurs in a number of countries, eg. Brazil, India, Norway. It is made of cerium oxide with variable amounts of other rare-earth elements plus some thorium. It is only the thorium that is radioactive.

MONAZITE SAND: This sample comes from China but is typical of material along parts of the Kerala coast in India. Over 70,000 Indians have lived for generations on an island made of this material without any reliable evidence of harmful effects. In Brazil, the locals remove this type of sand from beaches and put it into their sleeping mattresses for its supposed therapeutic effects!

Authorization for the carriage of specimens in this case is covered by Statutory Instruments No 2712 of the 1962 Radioactive Substances (Geological Specimens) Exemption Order 1962.

1954:

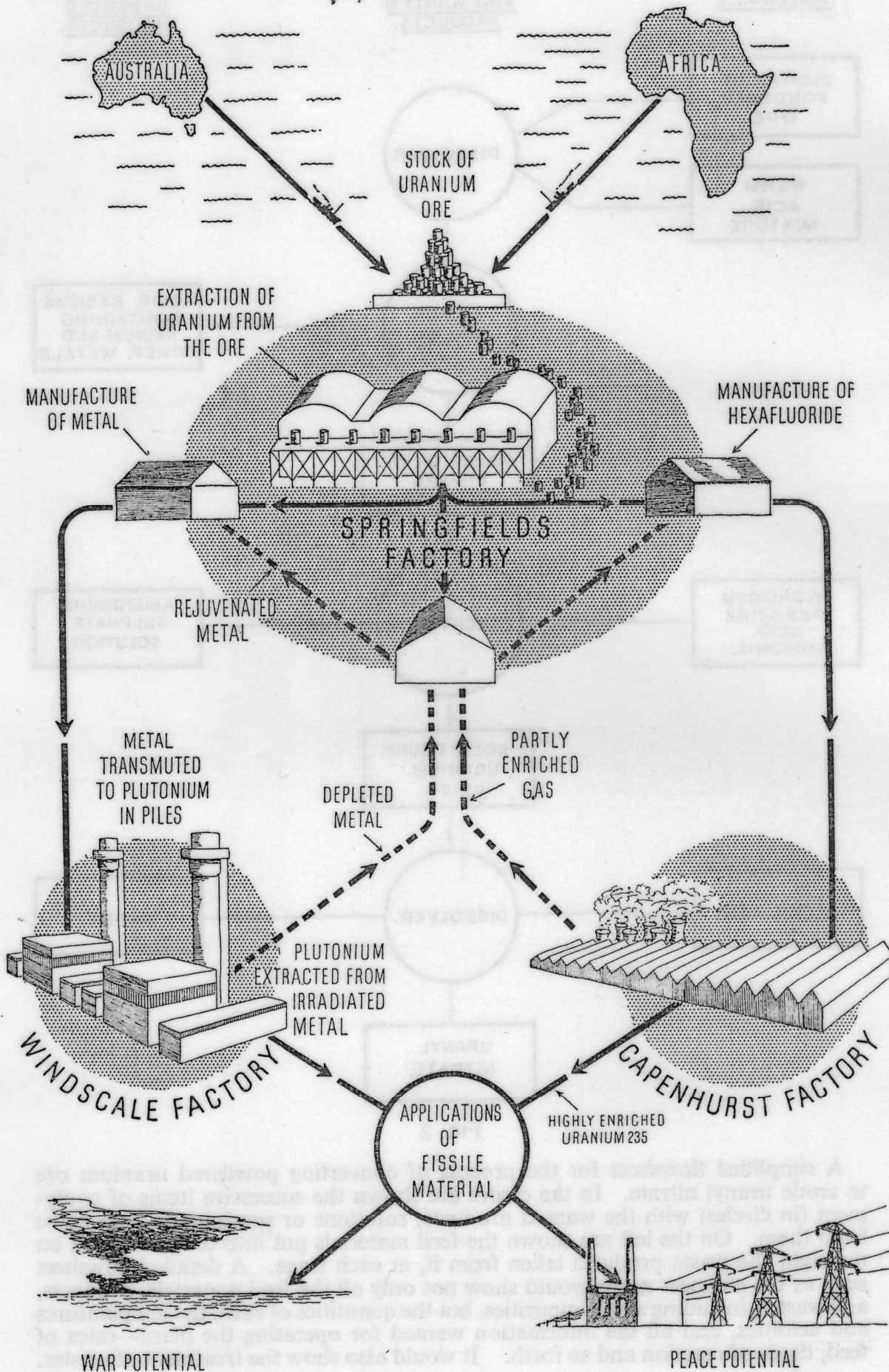

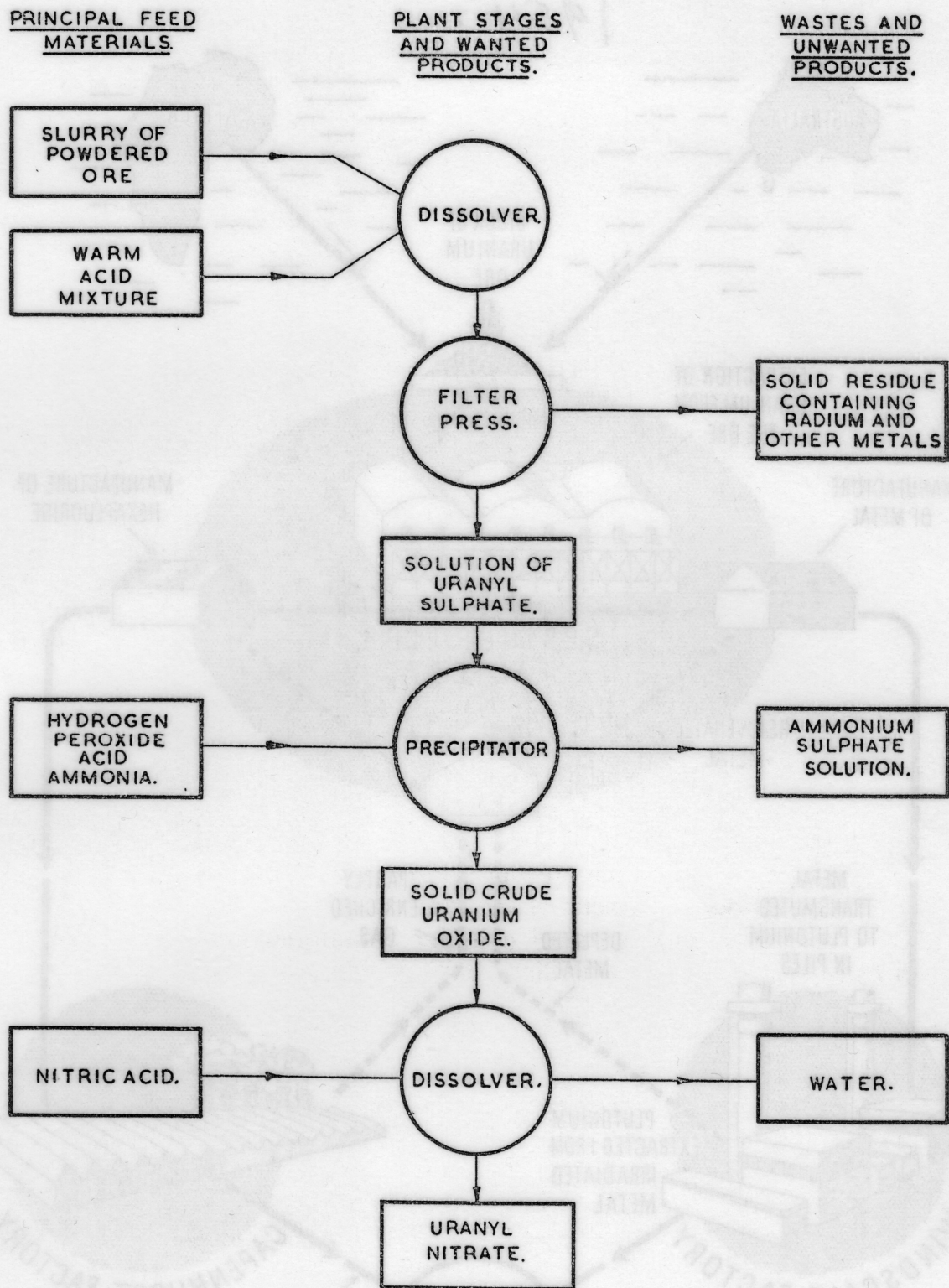

FIG. 2

A simplified flowsheet for the process of converting powdered uranium ore to crude uranyl nitrate. In the centre are shown the successive items of equipment (in circles) with the wanted products, solutions or precipitates, that come from them. On the left are shown the feed materials put into the plant, and on the right the waste products taken from it, at each stage. A detailed flowsheet such as the engineer needs would show not only all the feed materials, products, and wastes, including small impurities, but the quantities of each, the temperatures and acidities, and all the information wanted for operating the plant—rates of feed, times of reaction and so forth. It would also show the treatment of wastes.