

Multi-Wavelength Imaging

Solutions For Simultaneous Capture

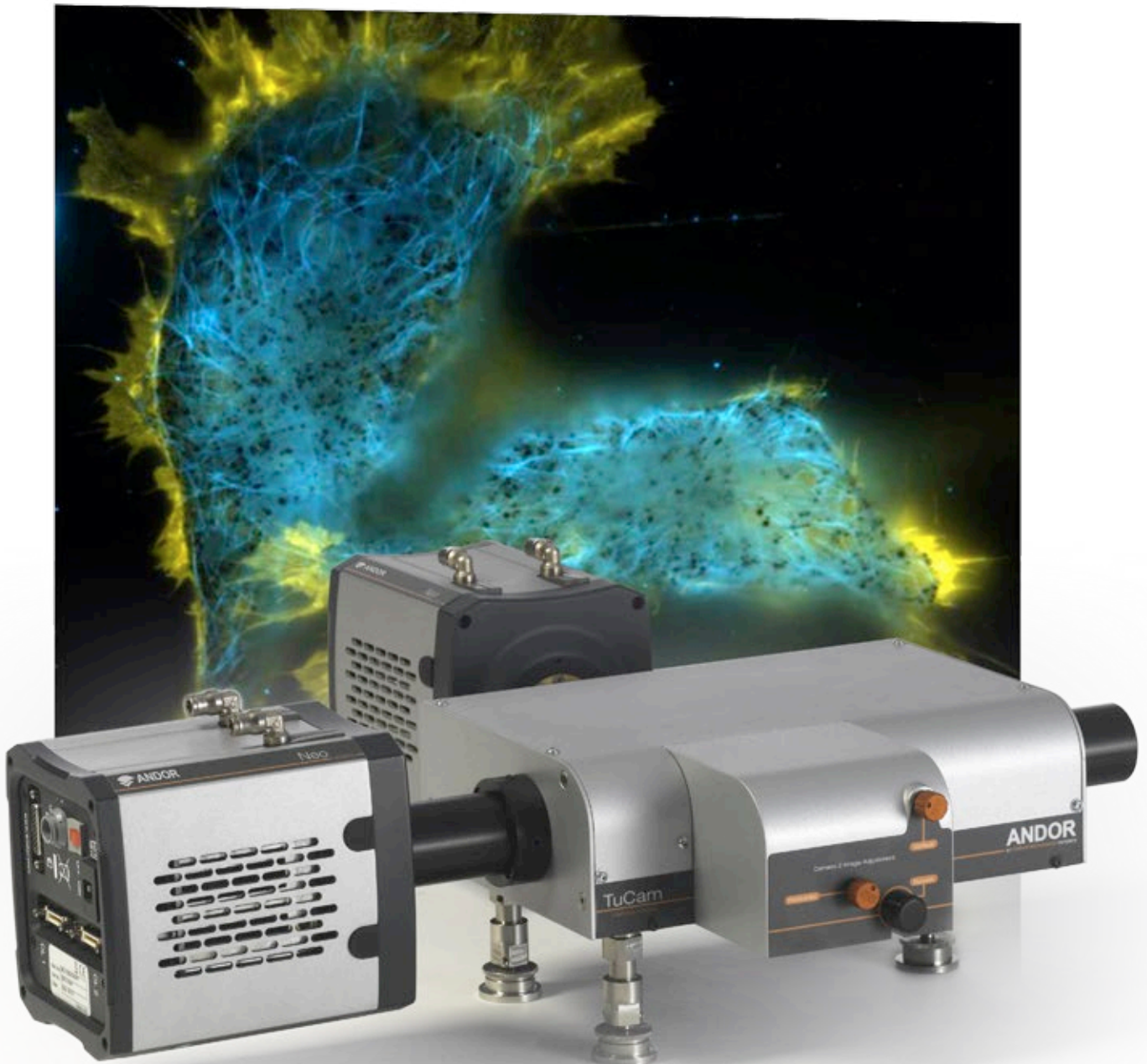

Multi-Wavelength Imaging

Solutions For Simultaneous Capture

The vast majority of fluorescence microscopy applications involve the use of more than one fluorescent probe e.g. FRET, dual color imaging, co-localization studies etc. For simultaneous multi-wavelength imaging Andor offers the most flexible and versatile solutions available, either splitting the wavelengths across two separate cameras or across adjacent sensor halves of a single camera.

TuCam

The TuCam, a new generation two-camera adaptor, for both macro and microscopic applications can be configured for simultaneous imaging from two similar cameras or as a switch between camera models with different imaging capabilities. It is compatible with Andor's complete range of market leading low light imaging cameras including the iXon family of EMCCDs, Clara Interline CCD and the Neo and Zyla range of sCMOS cameras, as well as any detector from a third party supplier. It is an easy to integrate solution for any laboratory or multi-user imaging facility and extremely user friendly.

The TuCam is an "off-the-shelf" solution, pre-aligned to your Andor cameras of choice. Having the largest aperture on the market means that a wide range of sensors from very small to very large can be used effortlessly with the TuCam. Use of two cameras means that dual wavelength imaging can be performed without any sacrifice to the imaged field of view.

Optosplit II

The Optosplit II image splitter is sold by Andor as part of our dual wavelength imaging portfolio. It is a simple device enabling a single camera to record images simultaneously at two different optical wavelengths.

Optosplit III

The Optosplit III, a 3-way image splitter is a simple device for dividing an image into one, two or three separate, spatially equivalent components which can be displayed side by side on a camera sensor, enabling a single camera to record images simultaneously at one, two or three different optical wavelengths.

Key Applications

- Real time multi color imaging
- Co-localization of interacting fluorescently labelled molecules
- Fluorescence Resonance Energy Transfer (FRET)
- Ratiometric imaging
- Super resolution (where simultaneous imaging of two different fluorophores is required)
- Anisotropy imaging including homo-FRET
- Biplane / dual focal plane imaging
- Calcium flux / ion signalling e.g. Fura, Indo-1, Fluo-3 dyes
- Dual wavelength TIRF microscopy
- Dual wavelength real-time confocal microscopy
- Fluorescence In Situ Hybridization (FISH) imaging
- Simultaneous fluorescence / DIC imaging

“ Our main interest is the dynamics of the cytoskeleton. With two Neo sCMOS cameras on the TuCam we can for the first time combine high-resolution, a large field of view and sensitivity whilst simultaneously capturing multiple wavelengths.



Image courtesy of Dr. Ulrike Engel, Nikon Imaging Centre, University of Heidelberg, Germany

”

Recommended Software For Simultaneous Multi-Wavelength Microscopy

The following software packages have been verified under simultaneous dual camera acquisition mode, as well as offering functionality to merge and analyze data from each channel. Please see Application and Technical Notes section for further details.



TuCam

Dual Image Adapter

Andor's TuCam is a new generation two-camera adapter for macro or microscopic imaging applications. Available in C-mount, TuCam's features include large aperture, exceptional transmission, very low distortion and high precision alignment using kinematic cassettes.

The TuCam can be configured for simultaneous imaging from two similar cameras or as a switch between camera models with different imaging capabilities, including CCD, EMCCD, ICCD and sCMOS from Andor, and other third party detectors. Since separate wavelengths can be split across two individual cameras, the field of view is not at all compromised (the primary distinction from a single camera image splitter). A full range of beam splitting optics is available with custom-designed kinematic cassettes for precision alignment. These include wavelength and polarization splitters

of the highest quality, as well as a first surface mirror for switching between cameras.

A variety of camera tubes and lenses are available to provide magnifications of 1.0 x, 1.2 x, 1.5 x and 2.0 x in each arm of the adapter. A filter wheel can also be integrated at the input of the TuCam to enable pre-filtering of the desired emission band.

The TuCam is based around our own unique design to afford the user a diversity of options. The TuCam is pre-aligned and optimized at our factory prior to shipping, so the user will only ever need to adjust the focus and make minor adjustments to the cassette. However, should you wish to disconnect the cameras for use on other set-ups, realignment to the TuCam is relatively simple and full instructions (including video tutorials) are provided.

Key Applications

Dual wavelength super resolution
Dual wavelength TIRF microscopy
Co-localization of two different wavelengths
FRET
Ratio imaging of dual emission dyes, such as INDO-1 or Chameleons
Anisotropy imaging including homo-FRET

Did You Know?

The TuCam can be readily re-aligned by users meaning the cameras can be disconnected and used on other set-ups as required.

Features

Largest aperture available on the market
High quality achromatic lenses
Highest transmission
Very low distortion
Bypass mode
Robust, compact and accurate
Convenient user adjustment
C-mount and CSU versions
Various magnifications
No device drivers required
Microscope and spectrograph compatible

Benefits

Unique 22 mm aperture for larger format sensors e.g. Neo and Zyla sCMOS
Image from 400 - 700 nm with minimal adjustment
Minimal light loss between 400 - 700 nm
Excellent image alignment between the two detectors
Dovetail mount for precise insertion, exchange and bypass of optical elements
Rigid structure provides optical and mechanical stability
User-controls for focus adjustment and 2-axis cassette alignment are accessed via the front porch
Couple directly to filter wheels, microscopes, C-lenses and spinning disk confocal scanners
Match cameras to CSU aperture or control effective pixel size
Operating straight out of the box
Can acquire state of the art imaging and spectral profiles simultaneously

Key Specifications

Wavelength Range	400 - 750 nm
Throughput	96% (425 - 675 nm)
Chromatic aberration (focus shift)	< +/- 0.2 mm (486 - 656 nm)
Distortion	< 0.5 %
Differential Distortion	< 0.5 %
Maximum Sensor Format	22 mm diagonal
Field Uniformity	90%
Chromatic magnification variation	< 25 µm (425 nm - 675 nm)
Camera Field Alignment error	nm) < 32 µm

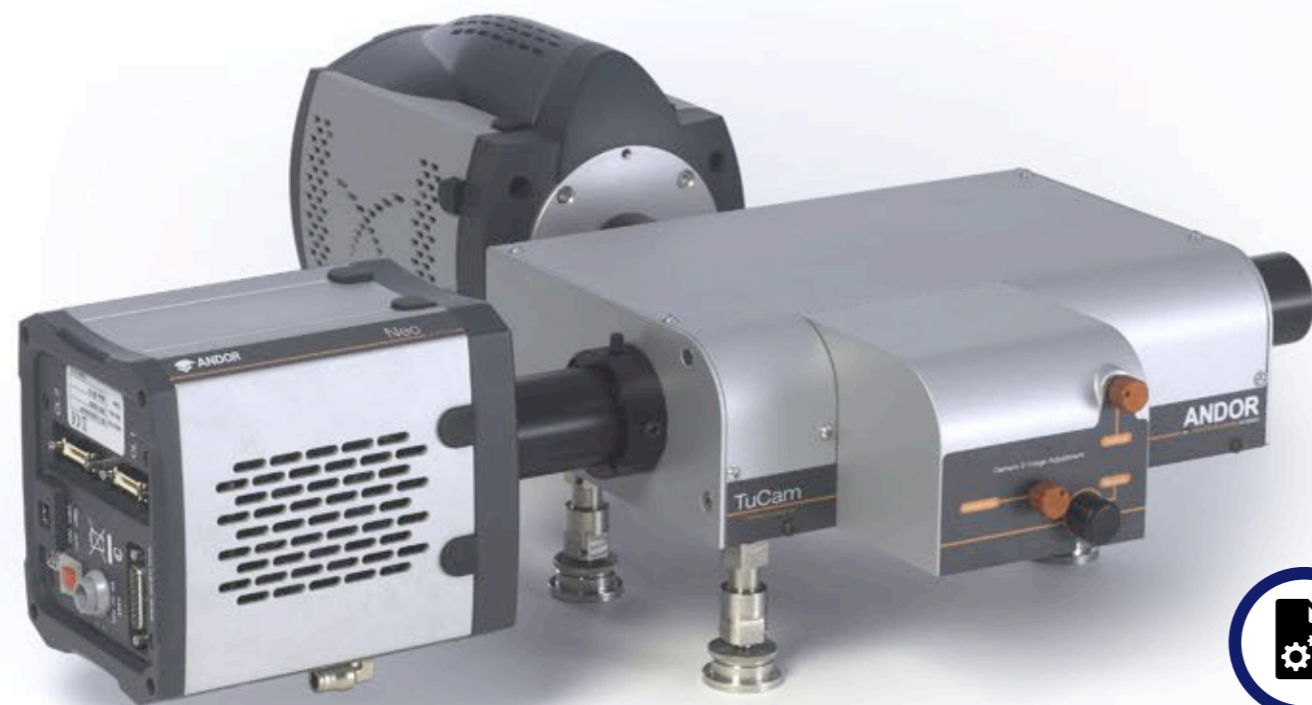

See page 16 for "Dual Wavelength Imaging using TuCam: Software Set-up Focus" Technical Note

“ We use the TuCam adaptor for fast switching between two different acquisition systems. This is a flexible solution for our application as it means we don't have to change or realign the camera. In the future we plan to use this adaptor for simultaneous imaging.



Dr. Francesca Peri and Christian Moritz Ph.D., European Molecular Biology Laboratory (EMBL), Heidelberg, Germany

”

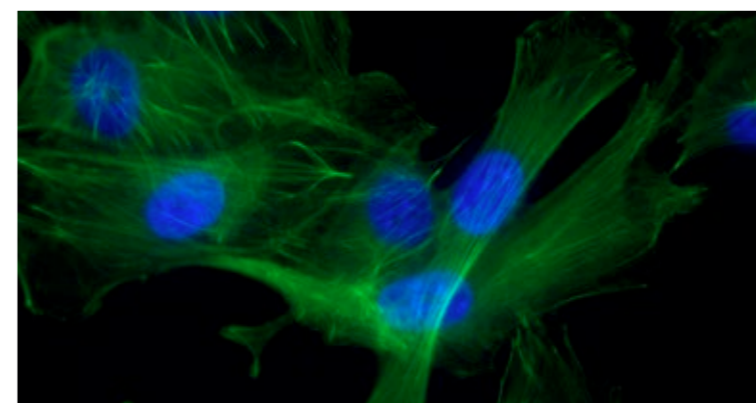

Micrograph showing the location of the nucleus (blue) and the actin cytoskeleton in a human osteosarcoma cell line. Image courtesy of Dr. Ulrike Engel, Nikon Imaging Centre, Heidelberg, Germany.

TuCam

Dual Image Adapter

Principle of Operation

This schematic of the optical path shows the emission beam (yellow) coming from the microscope and entering the TuCam via the C-mount attachment point. When this emission beam enters the filter cassette, which contains a dichroic mirror, the emission light is split. The longer wavelengths are transmitted straight through the dichroic mirror (red beam) and collected by camera one and the shorter wavelengths of light are reflected by the dichroic mirror (green beam) and collected by the second camera.

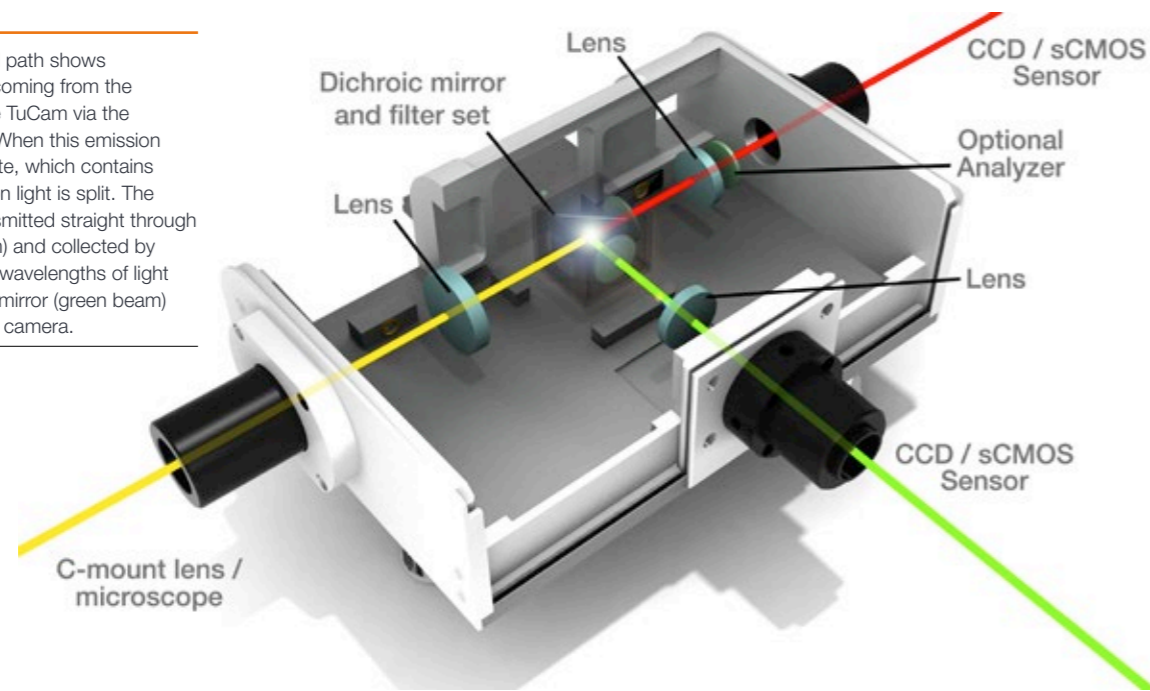

Range of Filters Available

Andor recommend Semrock's range of image splitting dichroic beamsplitter. Extremely flat dichroics which reduce the level of aberrations in the reflected beam path.

Interchangeable Filter Cassettes

Quick and simple exchange. Minimal adjustment required. Accurate alignment achievable.

Bypass Mode

Cassette can be fully retracted. Minimal need for realignment upon return.

Polarization States Separated

An optional Polarizing Beam Splitter (PBS) may also be used to observe separate polarization states. A very high extinction ratio can be achieved.

Versatile

Can use with a standard mirror if direct image overlay not required.

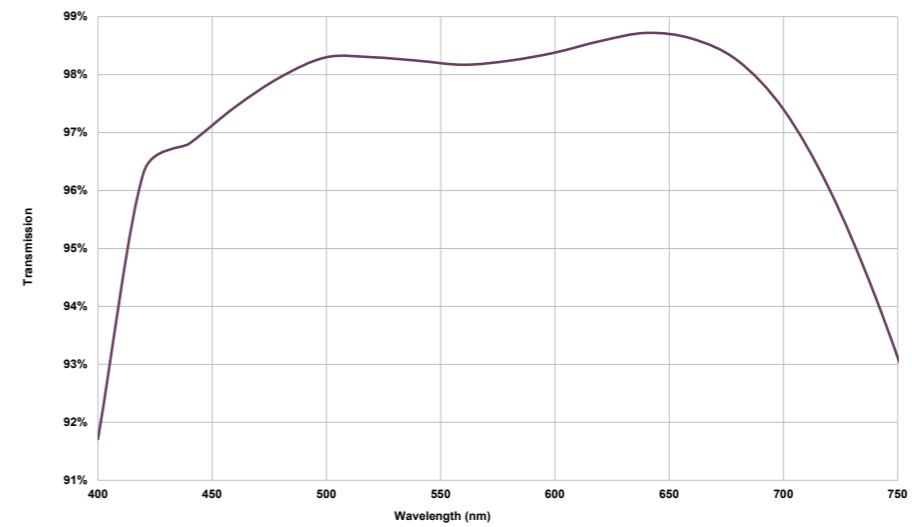

Transmission Curve for C-mount TuCam

Andor's TuCam utilizes lenses with broadband anti-reflection coatings specifically chosen to maximize system throughput in the 400 - 750 nm wavelength band. This is a typical performance for these instruments and may vary slightly between individual units. Beam splitter optics are not included.

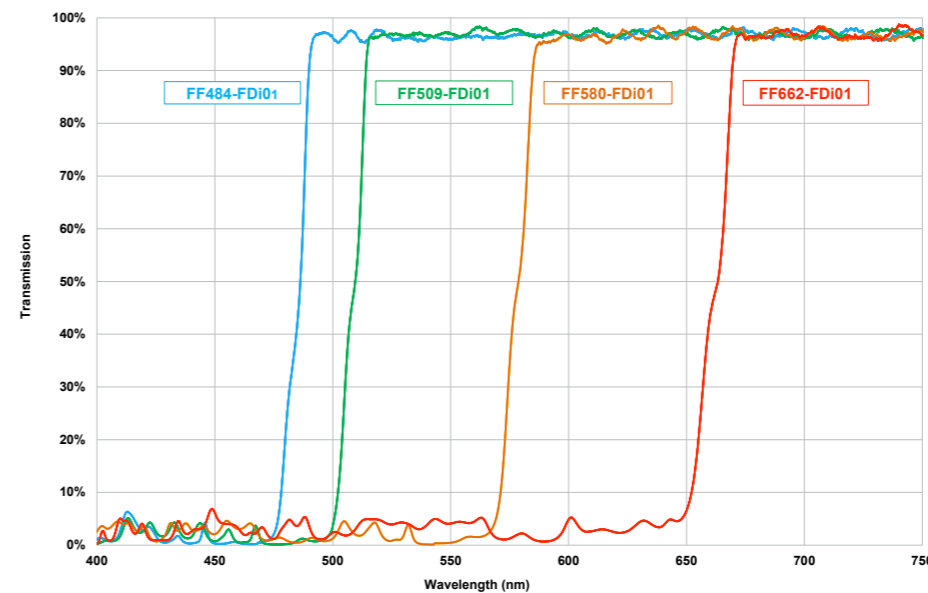

Transmission and reflectance curve for Semrock imaging dichroic beamsplitters

Semrock's beamsplitters efficiently separate multicolored emission signals while maintaining excellent image fidelity. These dichroic beamsplitters are available for many popular fluorophore pairs. Their wide reflection and transmission bands and superb flatness allow for maximum light capture while minimizing image aberrations.

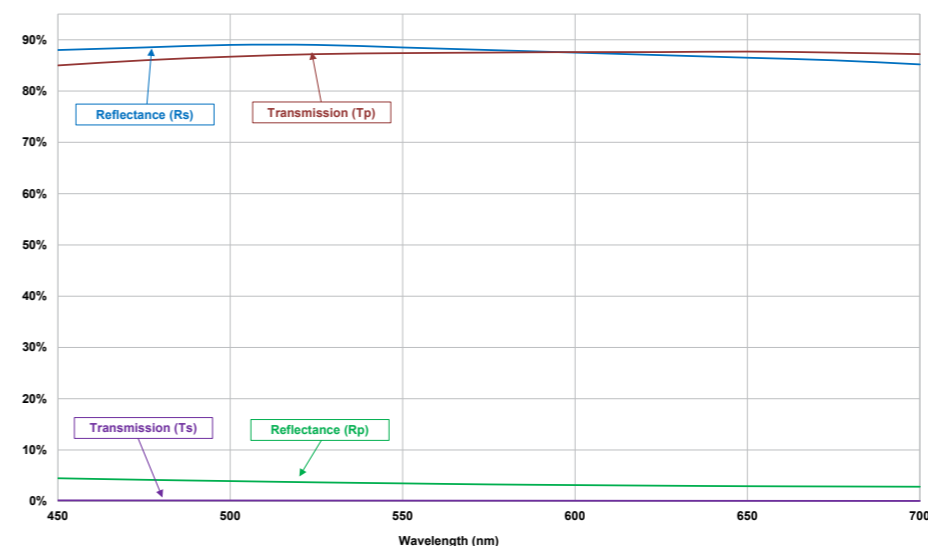

Transmission and reflectance curve for Moxtek polarizing beamsplitters

The Moxtek beam splitters deliver good transmission and excellent contrast. Optically flat polarizing beamsplitters are a specific product engineered for imaging applications. The quality of both the transmitted and reflected wavefront meets the requirements of modern scientific instruments.

Optosplit II

One Camera Solution - Dual Emission Image Splitter

The Optosplit II image splitter is an elegant device that divides the image into two separate, spatially equivalent components that can be displayed side by side on a camera sensor, enabling a single camera to record images simultaneously at two different optical wavelengths.

The Optosplit has been designed as a convenient, inexpensive solution to simultaneous imaging. Splitting is usually performed on a basis of wavelength, allowing applications such as ratiometric ion imaging or FRET, however, polarizing beamsplitters are also supported. It has the unique feature of a rotating mirror cradle, which gives adjustable spatial separation, to facilitate image registration. A rectangular aperture is used to define the region to be imaged, with

a set of simple controls allowing the user to vary the relative positions of the two output images on the camera.

Device drivers are included in several commercial imaging packages to assist registration and to allow real-time and off-line ratioing or fluorescence overlays. Alternatively, the Optosplit can be used with simple image capture software and the processing carried out manually off-line. The simple and accessible design makes the Optosplit an excellent platform for alternative applications, such as dual polarization imaging. Whilst optimized for coupling to a scientific microscope, the Optosplit can also be used with camera lenses or any other system of lenses that produce an image plane of suitable size.

Key Applications

- Ratio calcium and pH imaging
- Dual probe imaging
- Fluorescence Resonance Energy Transfer (FRET)
- Total Internal Reflectance Fluorescence (TIRF)
- Polarization Studies



See page 14 for
“Multi-color direct
STORM with red
emitting carbocyanines”
Application Note

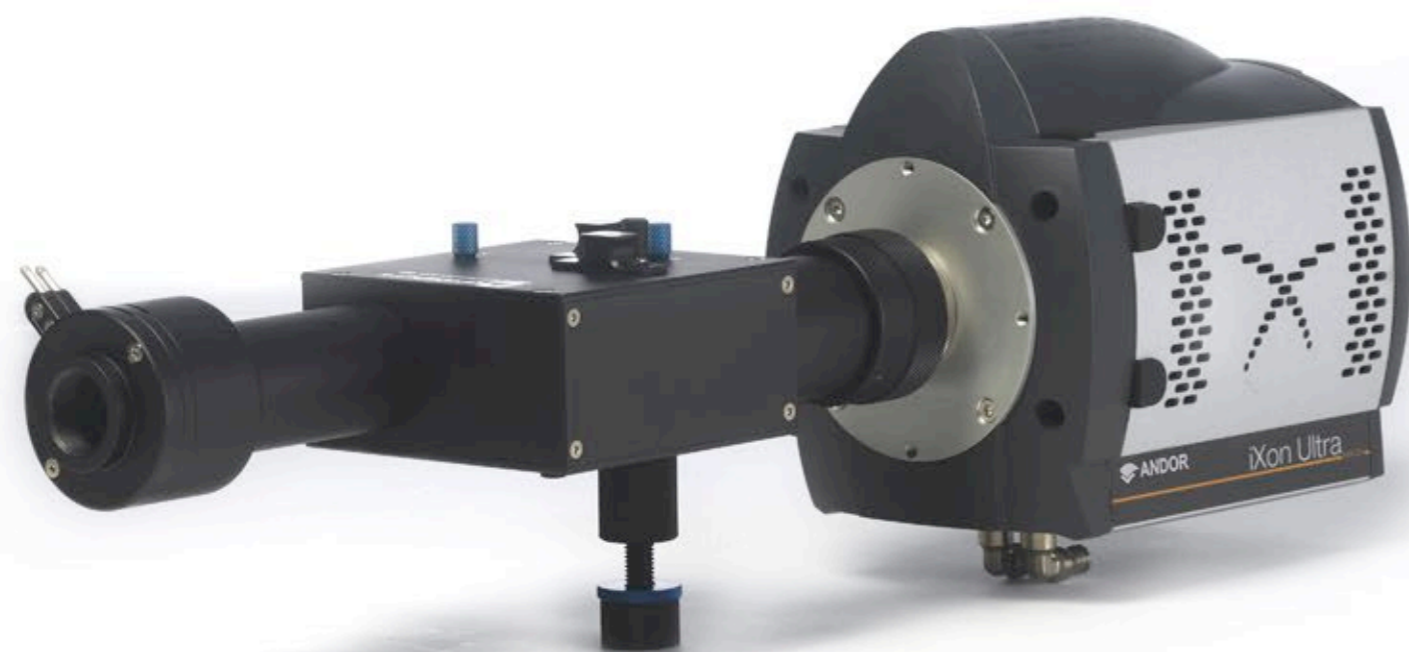

Features

- Single camera
- Variable internal path separation
- Dichroic mirror and emission filters mounted in a readily interchangeable cube
- Variable and locking rectangular diaphragm aperture for defining field size
- Compact design with integral C-mount input and output ports
- Simple and precise controls for image registration
- Interchangeable filter / dichroic holders for dual and single wavelength imaging
- Aperture diaphragms to balance signal levels if appropriate
- Rotating filter mount for polarization studies

Benefits

- A cost effective means to achieve simultaneous dual wavelength imaging with only one camera
- Allows optimization of the internal optics to match the aperture of the optical system, therefore minimizing the introduction of aberrations.
- Allows the user to exchange filter sets both easily and quickly. Some competing products have factory fitted filters.
- Allows the user to define the ROI both horizontally and vertically and set the images to the optimum size for the camera sensor. Once set, the aperture can be locked in position.
- Advantageous where laboratory space is at a premium and the integral C-mounts allow it to be easily attached to a wide variety of standard microscopes and CCD cameras.
- Allow the split images to be accurately and easily centred in the desired field of view, and pixels aligned with respect to each other.
- Flexibility to use multiple wavelengths by simply changing filter and re-sizing the defined field.
- Acts as an adjustable neutral density filter, which can be more convenient than using neutral density filters.
- Accurately orientates the emission polarization to maximize the contrast between the two channels.

Principle of Operation

This schematic of the optical path shows the excitation beam in yellow, while the emission fluorescence beams are shown in green and red to illustrate the different optical paths of the reflected and transmitted signals, respectively. The two signals are combined at the prism and projected onto two halves of the camera.

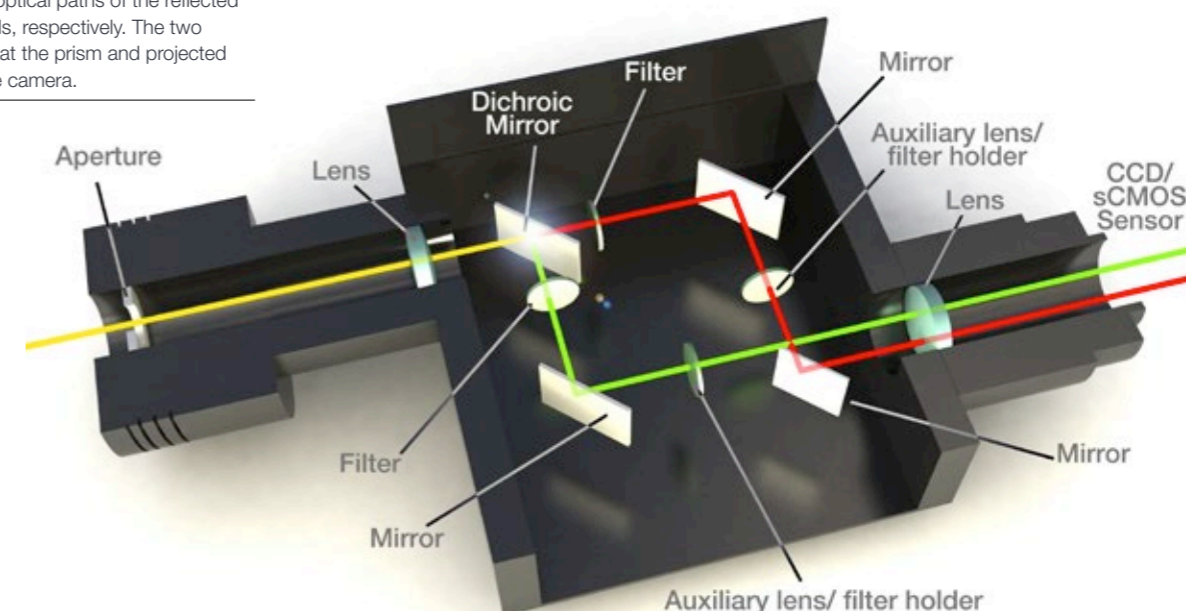

Optosplit III

One Camera Solution - Triple Emission Image Splitter

The Optosplit III, a three-way image splitter, is a simple device for dividing an image into two or three separate, spatially equivalent components. These can be displayed side by side on a camera sensor, enabling a single camera to record images simultaneously at three different optical wavelengths.

The Optosplit III has been designed as a convenient, inexpensive solution for simultaneous imaging. Splitting is usually performed on the basis of wavelength or polarization, allowing applications where there is a requirement for simultaneous or high speed acquisition of multiple emission bands or polarizations states. The simultaneous acquisition of up to three images offers a major benefit over manual or electronic filter changers, as there is no longer a need to

pause acquisition while the filter position is changed. This allows your camera to be operated at the fastest capture rates it is capable of achieving.

The Optosplit III is usually supplied with unity magnification and fitted with a rectangular aperture to define the ROI. It includes controls to allow up to three images to be positioned accurately and conveniently within the camera frame. Device drivers are included in several commercial imaging packages to assist registration and to allow real-time and off-line ratioing or image overlays. Whilst optimized for coupling to a scientific microscope, the Optosplit III can also be used with camera lenses or any other system of lenses that produce an image plane of suitable size.

Key Applications

- Polarization Fluorescence Resonance Energy Transfer
- Ratiometric ion imaging
- Triple fluorescence probe imaging
- Polarization studies
- Simultaneous phase contrast and fluorescence
- Multi-depth imaging

Features

- Single camera
- Variable internal path separation
- Dichroic mirror and emission filters mounted in a readily interchangeable cube
- Variable and locking rectangular diaphragm aperture for defining field size
- Compact design with integral C-mount input and output ports
- Simple and precise controls for image registration
- Interchangeable filter / dichroic holders for dual and single wavelength imaging
- Aperture diaphragms to balance signal levels if appropriate
- Rotating filter mount for polarization studies

Benefits

- A cost effective means to achieve simultaneous triple wavelength imaging with only one camera
- Allows optimization of the internal optics to match the aperture of the optical system, therefore minimizing the introduction of aberrations.
- Allows the user to exchange filter sets both easily and quickly. Some competing products have factory fitted filters.
- Allows the user to define the ROI both horizontally and vertically and set the images to the optimum size for the camera sensor. Once set, the aperture can be locked in position.
- Advantageous where laboratory space is at a premium and the integral C-mounts allow it to be easily attached to a wide variety of standard microscopes and CCD cameras.
- Allow the split images to be accurately and easily centred in the desired field of view, and pixels aligned with respect to each other.
- Flexibility to use multiple wavelengths by simply changing filter and re-sizing the defined field.
- Acts as an adjustable neutral density filter, which can be more convenient than using neutral density filters.
- Accurately orientates the emission polarization to maximize the contrast between the two channels.

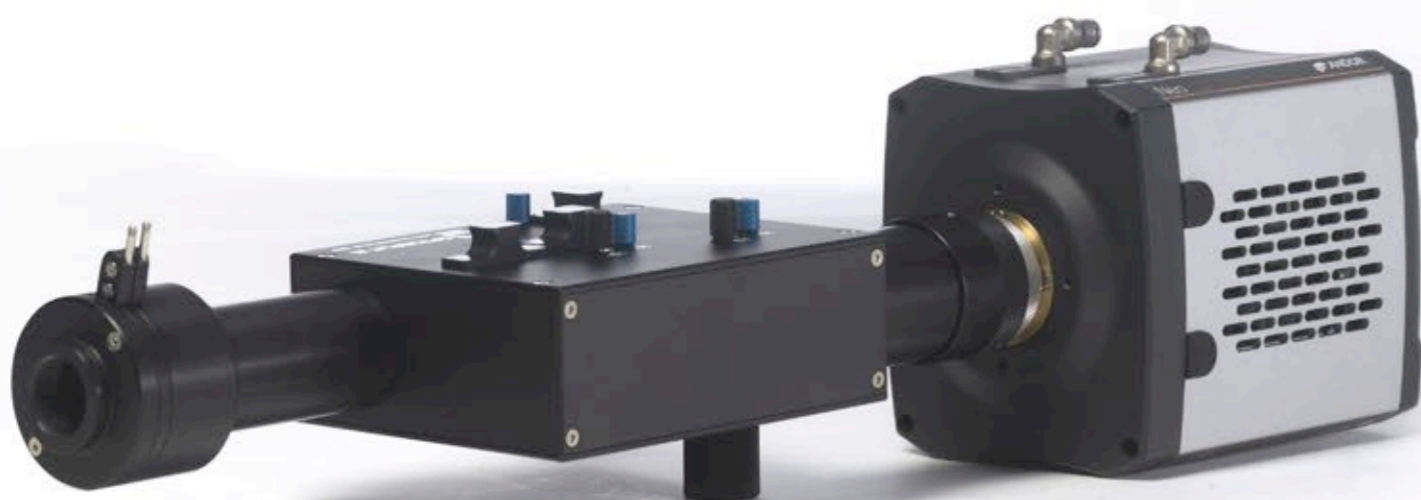

Principle of Operation

This schematic of the optical path shows the excitation beam in yellow, while the emission fluorescence beams are shown in green, red and blue to illustrate the different optical paths of the reflected and transmitted signals, respectively. The three signals are combined at the prism and projected onto the camera.

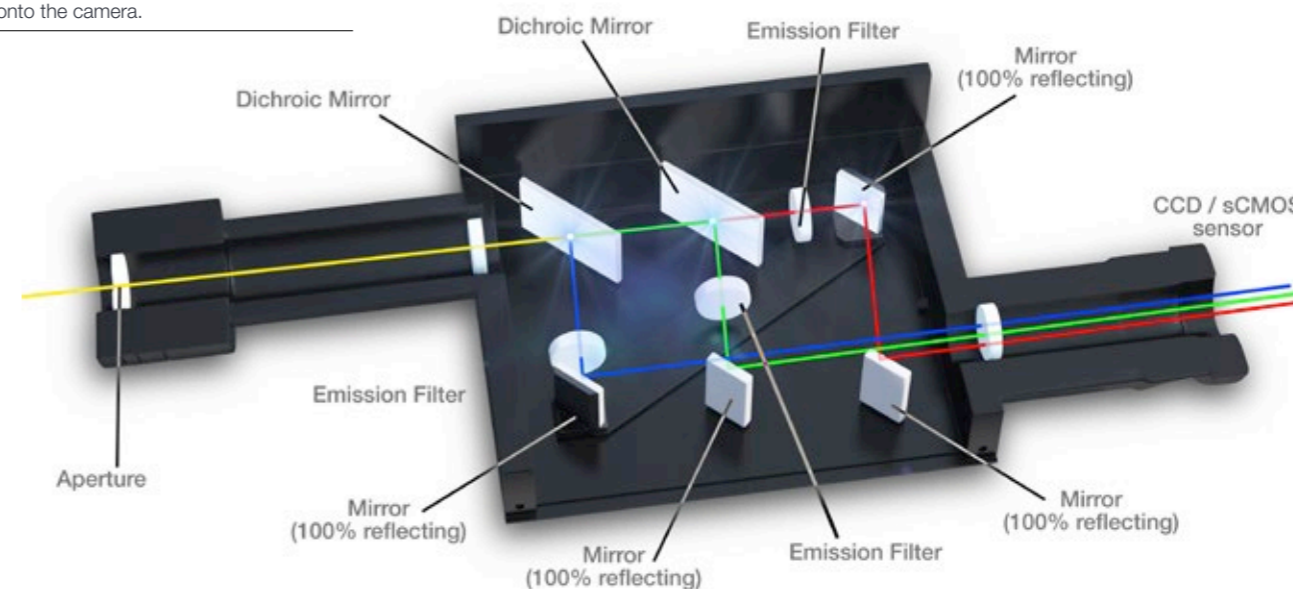

Application and Technical Notes

For multi-wavelength imaging, Andor has the most flexible and versatile solutions available to the researcher.

The following section is dedicated to providing a greater depth of understanding to the functionality of the multi-wavelength imaging products available from Andor. The content in the subsequent pages will illustrate how the TuCam can be used with different detectors in a range of software, making it easy to integrate into any laboratory. In addition, you will read a summarized publication where the Optosplit II, in combination with the iXon3 EMCCD from Andor, was used to perform multi-color *direct* STORM.

- Multi-color *direct* STORM with red emitting carbocyanines
- Dual wavelength imaging using TuCam: Software set-up focus
- Software recommendations for acquisition and analysis of dual wavelength microscopy images

“The compact size and good stability of the Optosplit in combination with the high sensitivity of the Andor iXon EMCCD was crucial in developing SD-dSTORM.”



Dr. Jan Schmoranz and André Lampe Ph.D., Institute of Chemistry and Biology, Free University of Berlin, Germany

”

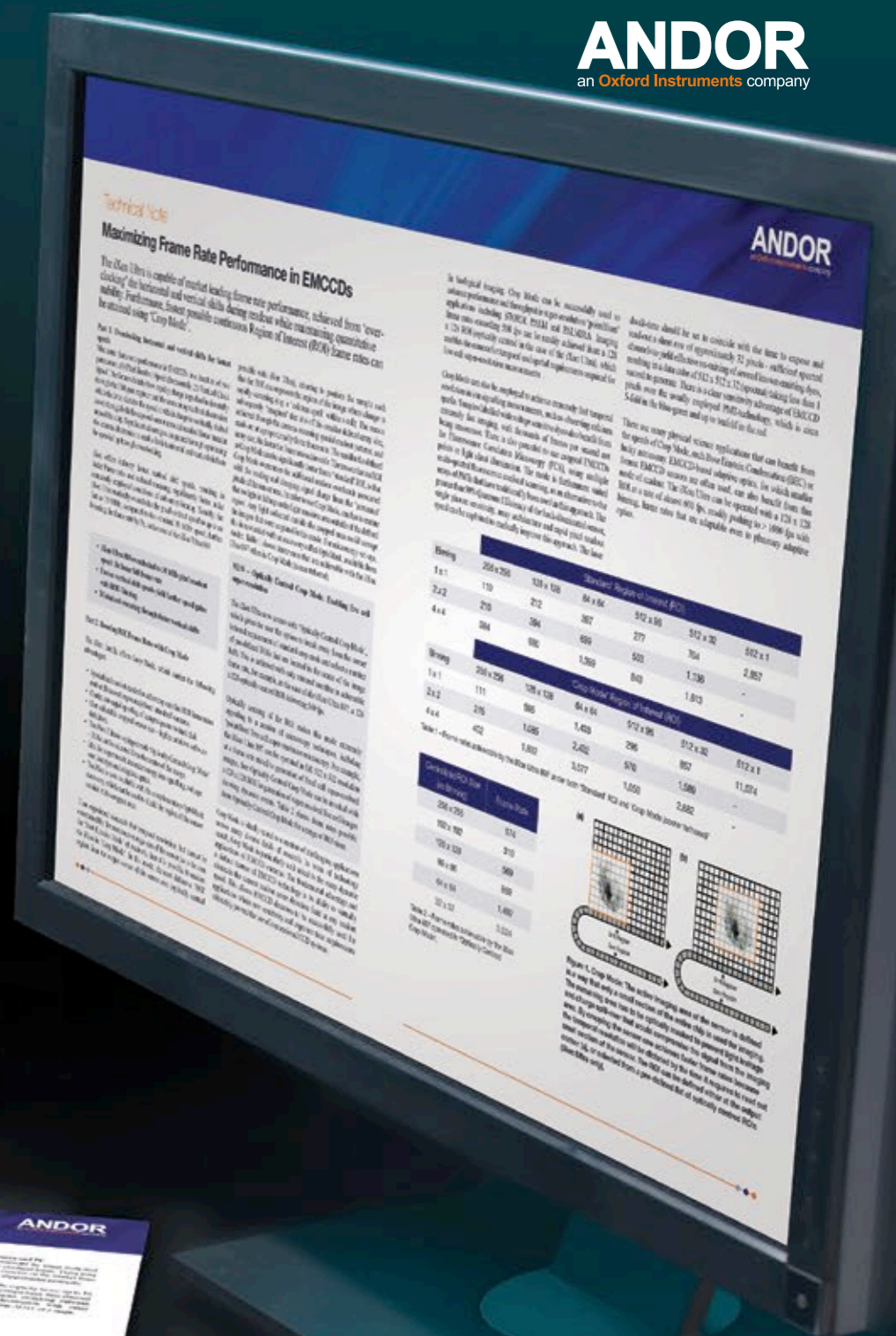

Application Note

Multi-color *direct* STORM with red emitting carbocyanines

Lampe *et al* have developed a novel variant of direct STORM (*d*STORM) termed spectral demixing *d*STORM (SD-*d*STORM) that combines the photochemical advantages of the red emitting carbocyanine dyes with the principle of spectral demixing. Specifically, they use a novel combination of carbocyanine dyes for super resolution, Alexa Fluor 647 and Alexa Fluor 700, which both show the excellent buffer compatible blinking characteristics needed for single molecule localization. SD-*d*STORM requires reduced laser power and fewer imaging frames for faithful super resolved reconstruction of linear and punctuate biological nanostructures compared to other super resolution techniques.

Amongst the currently available organic photoswitches, the carbocyanine dyes Cy5 and Alexa 647 are most efficient for single molecule localization. This is based on their photostability (up to 6,000 photons per ON cycle) and, most importantly, their ability to exhibit a prolonged OFF state in a reducing environment. Lampe *et al* wanted to use Alexa 647 and needed to find a fluorescent partner that was both buffer compatible and one that exhibited a prolonged OFF state. Alexa 700 was chosen as the candidate. It was found that Alexa 700 exhibited the prolonged OFF state when in 100 - 300 mM β -mercaptoethylamine (MEA) and oxygen scavenger, and when excited at 643 nm. To distinguish the overlapping emission spectra of Alexa 647 and 700 the Optosplit II, a dual channel emission splitter from Cairn Research, was employed. The emission wavelengths were split via a dichroic mirror (710 DCXR) and two emission filters, HC 687 / 40 and ET 794 / 160, into short and long wavelength emission, and detected side by side on Andor's iXon 897 EMCCD. The dichroic and bandpass emission filters for each channel were matched to the single laser line (643 nm) and the emission spectra to optimize the cross-talk required for spectral demixing.

To evaluate the quality of the spectral separation of Alexa 647 and Alexa 700, microtubules were labelled in BS-C-1 cells with commercially available secondary antibodies separately for each color, and mounted in *d*STORM buffer (MEA, O₂ scavenger buffer). Before acquisition, the sample was illuminated with 3 - 5 kW/cm² at 643 nm to drive the fluorophores into the OFF state until the microtubule structure dissolved and stochastic blinking of the dyes was observed. Typically, 5,000 - 20,000 frames were acquired with a continuously running EMCCD at the same excitation. After acquisition, the single molecule localizations and their individual intensity values over the whole dual-channel view were determined with the open source software rapidSTORM. Lampe *et al* used their own custom written algorithm to get the fully reconstructed dual-color SD-*d*STORM image.

To determine the experimental optical resolution of the two color SD-*d*STORM system, the scattering of single molecule localizations in SD-*d*STORM was imaged (Figure 1). From this analysis the localization clusters appeared as fully separate spots, demonstrating the low probability of cross-talk between channels. The resolution for both channels, 22 nm for Alexa 647 and 30 nm for Alexa 700, were very similar to previously reported resolution values using Alexa 647 as a fluorophore for localization microscopy.

The applicability of SD-*d*STORM in cell biology was demonstrated

by imaging sub-cellular objects that are known to display distinctive shapes and spatial localization with different secondary antibodies labelled with Alexa 647 and Alexa 700. Focal adhesions, large protein complexes in the cell periphery, and clathrin coated pits, approximately 150 nm sized vesicular objects at the plasma membrane were chosen. Both do not co-localize with each other or with microtubules and should therefore appear as separate sub-cellular structures. Dual-color SD-*d*STORM showed well separated super-resolved microtubules and focal adhesions (Figure 2A) and well separated microtubules and clathrin coated pits (Figure 2C). As a control, microtubules were labelled with both Alexa 647 and Alexa 700 to show the co-localization of the two channels (Figure 2B).

Lampe *et al* have shown a significant advance towards user-friendly multi-color single molecule-based super resolution microscopy; it combines advantages of the red emitting carbocyanine dyes with the principle of spectral demixing to perform efficient, reliable and fast multi-color *d*STORM. On the basis of spectral demixing, SD-*d*STORM offers the possibility of being extended to more than two colors using other related red dyes (i.e. Alexa 750). SD-*d*STORM can be combined with any of the commercially available localization software (i.e. QuickPALM and rapidSTORM). SD-*d*STORM promises to be an advantage for live cell imaging if combined with tag technology.

Research Paper: Multi-color direct STORM with red emitting carbocyanines, *Biology of the Cell* (2012), DOI: 10.1111/boc.201100011.

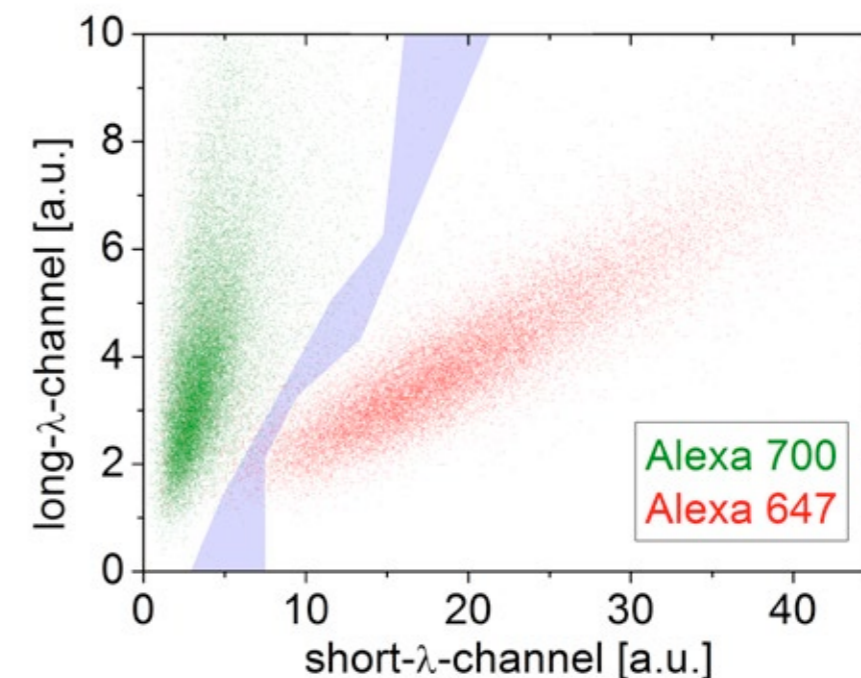

Figure 1. SD-*d*STORM reconstruction of microtubules. Microtubules were stained separately with either Alexa 647 (red) or 700 (green) and imaged with SD-*d*STORM. The intensity values for localization of Alexa 647 (red) and Alexa 700 (green) show different populations in a 2D intensity histogram. The intensity-based color assignment filter discards localizations in the cross-talk region (grey).

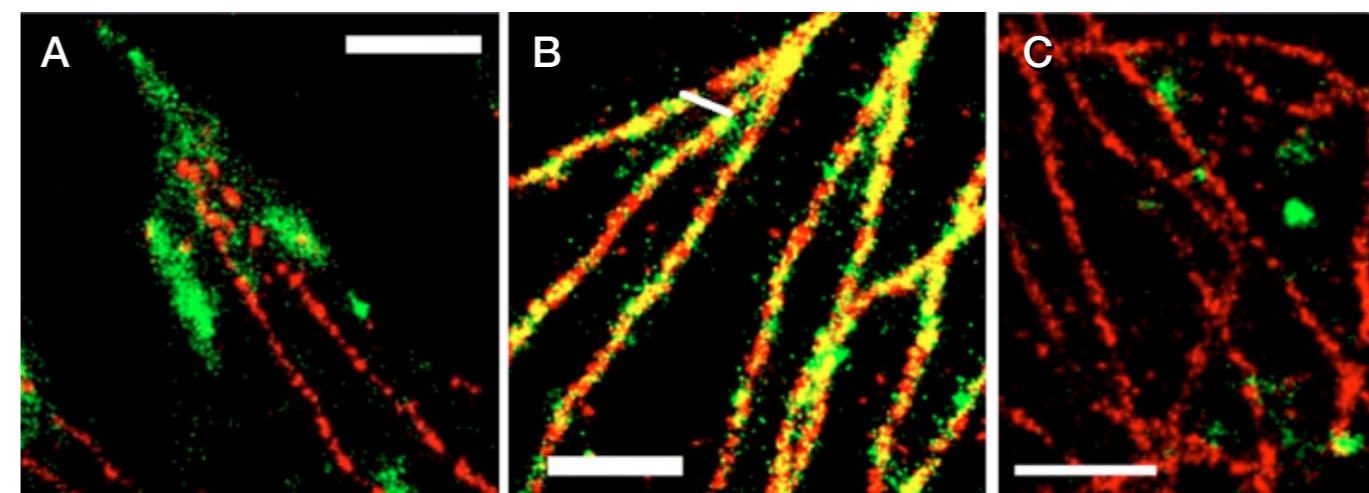

Figure 2. SD-*d*STORM reconstructions of separate and co-localizing structures. SD-*d*STORM of microtubules stained with Alexa 647 (red) and focal adhesion (A) or clathrin heavy chain (C) or microtubules (B, for co-localization test) stained with Alexa 700 (green). Scale bars = 1 μ m.

Technical Note

Dual Wavelength Imaging using TuCam: Software Set-up Focus

This technical note is provided to aid the user in the set-up of their software for use with TuCam. The example softwares covered are Andor Solis, Andor iQ and MetaMorph from Molecular Devices Corporation.

There are a number of key up-front considerations:

1. Does the software support the detectors under consideration?
2. Can the software be set up to acquire images simultaneously from more than one camera?
3. Is the software capable of operating two cameras within one instance of the software, or is it necessary to operate with two instances of the software i.e. one instance for each camera?
4. How are the cameras synchronized? For example is it possible to trigger one camera off the other camera, i.e. a Master and Slave set-up, or can you externally trigger both detectors to acquire frames simultaneously?

Simultaneous Imaging with two detectors using Andor Solis (version 4.21.300006) and Andor iQ (version 2.6)

In order to set up the cameras to acquire simultaneously and synchronously in either Solis or iQ, two instances of the software are required to be open, one for each camera. Each software is capable of synchronizing the cameras under a 'Master and Slave' arrangement or alternatively a simultaneous external trigger can be provided to both cameras. In the acquisition testing (described later), the Master and Slave set-up was employed, whereby camera 1 (Master) will trigger camera 2 (Slave) to acquire images. Camera 1 was attached to the end of the TuCam receiving the longer wavelengths of light (e.g. red) and camera 2 was receiving the reflected or shorter wavelengths of light (e.g. green).

In the software set the trigger of camera 1 to be internal and that of camera 2 to be external (see Figure 1). Using the trigger cables supplied with the camera, attach the 'Fire' cable of camera 1 (master) to the 'External Trigger' cable of camera 2 (slave) via a BNC connector. In this mode camera 2 will wait for camera 1 to trigger it to capture images. The exposure of camera 1 needs to be set marginally longer than the exposure of camera 2. This is important because if the exposure for camera 1 is too short there won't be sufficient pulses available to trigger camera 2 to acquire all of the images in a kinetic series. A general rule of thumb is to set the exposure of camera 1 to be the same or longer than the read-out of the sensor (see Figure 1, the iQ set-up). In order to achieve the fastest possible acquisition speed from both cameras, set the exposure of camera 1 to be the same as the readout, otherwise set the exposure to be longer. In the 'Master - Slave' mode, the exposure for camera 2 does not need to be set as it depends on the pulses from camera 1 to start acquiring images. The exposure setting for camera 2 becomes the delay between camera 1 acquiring its internal trigger and sending a pulse to camera 2 to acquire. This needs to be as close to zero as possible to ensure synchronous acquisition, so ideally input zero here. With this set-up both cameras will run simultaneously with the same frame rate in both Solis and iQ.

As mentioned, the alternative is to use an external trigger on both cameras to achieve simultaneous and synchronous imaging in both Solis and iQ.

Note: If you want to achieve fastest possible acquisition speeds when running two iXon EMCCD cameras in Solis or iQ, ensure that both cameras are set up to operate in frame transfer (overlap) mode.

Simultaneous Imaging with two detectors using MetaMorph software (version 7.7.8)

MetaMorph is capable of operating multiple cameras within one instance of software and is therefore very well suited for use with TuCam. However, be aware that MetaMorph does not have the functionality to set an internal trigger for one camera and an external trigger for the second camera, thus cannot be configured in a 'Master and Slave' arrangement.

Both cameras can be internally triggered by the software or externally triggered by a device trigger (e.g. digital delay generator, light source) to achieve simultaneous and synchronous imaging. The external trigger in MetaMorph is called 'strobed' or 'bulb' trigger mode. Both of these external trigger modes can be used successfully with two iXon EMCCD cameras and two Neo sCMOS cameras to achieve simultaneous and synchronous imaging.

Acquisition Testing

Two iXon Ultra 897 EMCCD's and two Neo 5.5 sCMOS cameras were tested in Solis, iQ and MetaMorph. Frame rates were assessed from both cameras to ensure that each were achieving (a) the same speed as each other and (b) the same speeds as would be achieved when operating only a single camera. Furthermore, a series of acquired images were examined by both cameras to ensure that both cameras were synchronous in their acquisition. All tests proved conclusive for satisfying the above conditions. Tables 1 to 3 show frame rates achieved by two iXon Ultra 897 EMCCD cameras acquiring simultaneously in two instances of Solis software, two instances of iQ software and one instance of MetaMorph software. These frame rates are consistent with that expected for a single camera operating at the maximum 17 MHz readout speed (see iXon Ultra 897 EMCCD specification sheet.)

The PC used in the testing was based on a Dell Precision T5500 with the following specification:

Processor	Intel® Xeon® E5620 2.4 GHz Quad Core
Memory	48 GB RAM
Hard Drives	2 x 600 GB SAS Hard Drives
Operating System	Windows 7 64-Bit Platform

Array			
Bin	512 x 512	256 x 256	128 x 128
1 x 1	57 fps	111 fps	214 fps
2 x 2	111 fps	213 fps	393 fps

Table 1 - Frame rates measured from two iXon Ultra 897 EMCCD cameras operating in Solis (Version 4.21.300006) software.

Array			
Bin	512 x 512	256 x 256	128 x 128
1 x 1	56.5 fps	109 fps	211 fps
2 x 2	110 fps	207 fps	392 fps

Table 2 - Frame rates measured from two iXon Ultra 897 EMCCD cameras operating in iQ (version 2.6) software.

Array			
Bin	512 x 512	256 x 256	128 x 128
1 x 1	56 fps	111 fps	213 fps
2 x 2	111 fps	213 fps	401 fps

Table 3 - Frame rates measured from two iXon Ultra 897 EMCCD cameras operating in MetaMorph (version 7.7.8) software.

Using Multiple USB Devices

The iXon Ultra 897 EMCCD employs a USB 2.0 data interface to PC. It is important to consider that when using rapid readout USB cameras (e.g. iXon Ultra, Luca or Clara cameras from Andor) simultaneously you need to be aware of the mechanism to maximize USB bandwidth, especially when utilizing multiple USB devices. In order to guarantee maximum speed performance of the iXon Ultra 897 it must be connected to an 'Enhanced Host Controller' (EHC) on the PC. The EHC is part of the computer's USB hardware and is required for USB 2.0 connectivity. Most PC's have only 2 EHC's. If the iXon Ultra 897 is connected to a UHC (Universal Host Controller) or if another device is sharing the same EHC with the iXon Ultra 897 the camera may not be able to sustain data transfer at the maximum frame rates possible. This problem can only be overcome if the PC being used has dual USB Enhanced Host Controllers. Generally, there is one EHC on the front of the PC and one on the back. In order to find these enhanced ports, a USB hub finder executable file is available at the following location (andor.com/my > [MyAndor](#) > [Utilities](#).) To ensure maximum data transfer, place only one camera per EHC.

In order to sustain maximum frame rates ensure high bandwidth devices (e.g. another iXon Ultra 897 or Clara) are on separate EHCs. Some devices can limit USB bandwidth simply by being connected, even when not being used. Some USB to RS-232 devices are known to do this. Some BIOS settings will cripple USB bandwidth in favour of power saving. (e.g. C states control must be disabled in Dell T-5500 models)

In an in house test, seven iXon Ultra 897 cameras have been successfully operated simultaneously at maximum frame rate. The PC employed was a pre-release Dell Precision T5600 (Intel Xeon CPU E5-2630 0 @ 2.20GHz (2 processors), 8GB RAM with Windows 7 Professional SP1 64-bit).

These seven cameras were installed as follows:

- Two in the USB2 EHCs (one per EHC)
- One in the USB 3.0 EHC
- Four were connected into the PCIe bus using four StarTech 2 Port PCI Express SuperSpeed USB 3.0 Card Adapters (these can be thought of as providing an additional EHC, so again, although two ports are available per adapter, only one should be used.)

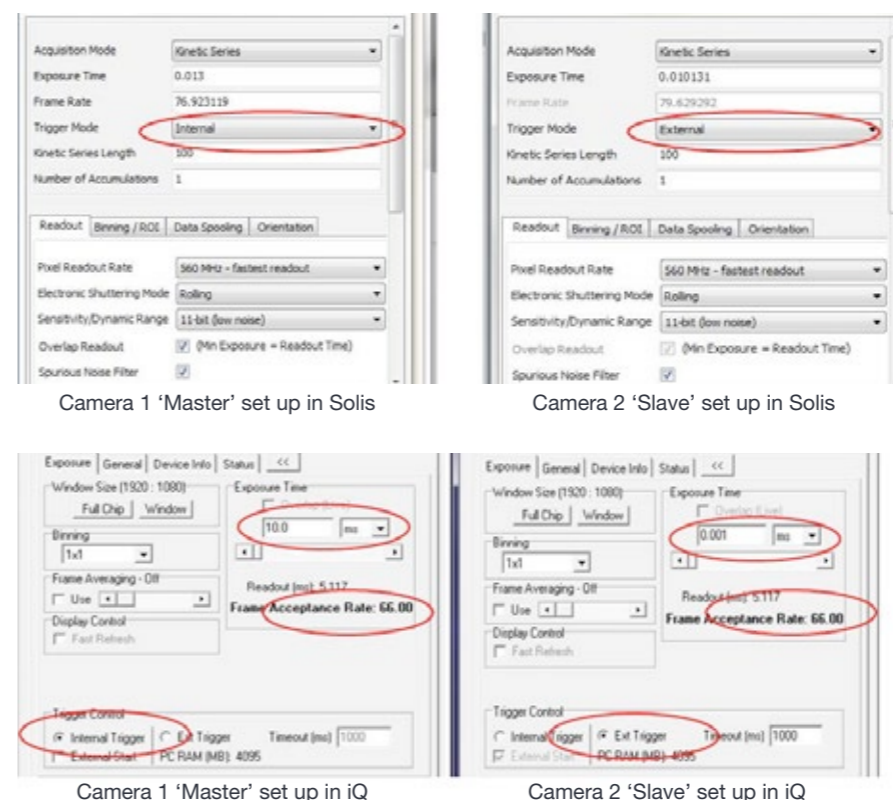

Figure 1. Setting up 'master' and 'slave' configuration in Solis and iQ for simultaneous imaging using two Neo sCMOS cameras.

Technical Note

Software recommendations for acquisition and analysis of dual wavelength microscopy images

Recommended software packages for dual wavelength image acquisition when using two cameras on TuCam

When acquiring two color images with two cameras on TuCam it is essential that the acquisition software is compatible with the detectors used and is capable of acquiring simultaneous image capture from both cameras. This section provides information concerning compatibility of Andor's range of imaging cameras for microscopy with a number of acquisition softwares, covering Andor Solis, Andor iQ, MetaMorph from Molecular Devices Corporation and NIS-Elements from Nikon Instruments Inc.

The following table summarizes the software packages that are compatible with Andor's cameras when operated under simultaneous dual camera acquisition.

Software	Instances of S/W required	2 x Neo 5.5 sCMOS	2 x iXon Ultra 897	2 x iXon 3 897	2 x Luca R	2 x Clara
Solis	2	✓	✓	✓	✓	✓
iQ	2	✓	✓	✓	✓	✓
NIS-Elements	1	✓	✓	✓	✓	x
MetaMorph	1	✓	✓	✓	x	x

All other dual cameras indicated can be run under one instance.

As conveyed, two instances of the imaging software Andor Solis and Andor iQ are required to run Andor's range of imaging cameras as these software packages do not have the dual camera drivers available, which are required to capture simultaneous images from two cameras in one software window. This implies that when using the TuCam with two cameras from the Andor range, each camera will require its own instance of Andor iQ and Andor Solis to achieve simultaneous and synchronous capture.

NIS-Elements and MetaMorph acquisition software packages have dual camera drivers available for the majority of Andor's range of imaging cameras. This indicates that only one instance of the software is required to acquire images simultaneously from both cameras in one window. For dual wavelength imaging, the Master-Slave set-up can be used which is explained in the technical note entitled 'Dual Wavelength Imaging using TuCam: Software Set-up Focus'. When using Andor Solis and Andor iQ for dual wavelength imaging, the Master-Slave set-up can be used which is explained in the technical note entitled 'Dual Wavelength Imaging using TuCam: Software Set-up Focus'.

Merging simultaneous two color images following acquisition with TuCam.

Following acquisition of dual wavelength images with Andor iQ software it is possible to merge these images by bringing both acquired images into one instance of iQ and then merging the two files under the Process Menu-Dual image disk. Assuming the meta data from both files is identical this will be possible i.e. the x,y,z & t dimensions. If Andor Solis is the acquisition software of choice it is possible to open the Solis files in Image J and use the merge tool here. Merging and analysis functionality also exists within MetaMorph and NIS Elements packages.

Merging simultaneous images acquired using the Optosplit II

Following acquisition with Optosplit II, analysis plug-ins are available in iQ, MetaMorph, MetaFluor, Image J and NIS-Elements for image registration and dual wavelength image merging.

Part Numbers

TuCam

Mounting Type

S-CMT	Any C-mount device including microscope or lens
-------	---

Magnification

1x	TR-DCIX-100
1.2x	TR-DCIX-120
1.5x	TR-DCIX-150
2x	TR-DCIX-200

Standard Filter Sets

TR-EMFS-F01	Semrock FF01-520/35-25, FF02-617/73, Dichroic FF580-FDI01-25x36
TR-EMFS-F02	Semrock FF01-475/28, FF550/49-25, Dichroic FF509-FDI01-25x36
TR-EMFS-F03	Moxtek Flat Beam Splitter PBF02C 38x26mm, Moxtek High Contrast PPL04 C 25mm dia.
TR-EMFS-F05	Semrock FF01-483/32-25, FF01-542/27-25, Dichroic FF506-Di02-25x36,
TR-EMFS-F07	Semrock FF01-497/16-25, FF01-550/32, Dichroic FF509-FDI01-25x36
TR-EMFS-F08	Semrock FF01-680/13-25, FF01-732/68-25, Dichroic FF700-Di01-25x36
TR-EMFS-F09	Semrock FF01-579/34-25, FF01-679/41-25, Dichroic FF640-FDI01-25x36
TR-EMFS-F12	Semrock FF01-579/34-25, FF01-692/40-25, Dichroic FF640-FDI01-25x36
TR-EMFS-F13	Semrock FF01-530/43-25, , Chroma HQ615LP, Dichroic FF580-FDI01-25x36
TR-EMFS-F14	Semrock FF02-525/50, FF01-692/40-25, Dichroic FF580-FDI01-25x36
TR-EMFS-F15	Chroma 50/50 beamsplitter,25.2x35.6x1mm laser flat
TR-EMFS-F17	Semrock FF02-525/40-25, FF01-640/40-25, Dichroic FF580-FDI01-25x36
TR-EMFS-F20	Semrock FF01-534/42-25, FF01-655/40-25, Dichroic FF580-FDI01-25x36
TR-EMFS-F21	Semrock FF01-534/42-25, FF01-641/75-25, Dichroic FF580-FDI01-25x36

Accessories

TR-MNT-110	Mounting feet for Clara, iXon3, iXon Ultra, Neo and Zyla cameras
CR-CSUX-MNT-110	CSUX 110 mm Opt Axis Mount Kit
TR-OLIX-MNT-110	Mounting feet for Olympus IX71/81
TR-NKTE-MNT-110	Mounting feet for Nikon TE-2000
TR-NKTI-MNT-110	Mounting feet for Nikon Eclipse Ti-E
TR-ZSAV-MNT-110	Mounting feet for Zeiss Axiovert 200

Optosplit II

Base Unit Configurations

TR-OPTS-20B	Optosplit II - 1.0x magnification
-------------	-----------------------------------

Standard Filter Sets

TR-EMFS-F01	Semrock FF01-520/35-25, FF02-617/73, Dichroic FF580-FDI01-25x36
TR-EMFS-F02	Semrock FF01-475/28, FF550/49-25, Dichroic FF509-FDI01-25x36
TR-EMFS-F03	Moxtek Flat Beam Splitter PBF02C 38x26mm, Moxtek High Contrast PPL04 C 25mm dia. Cairn P290/AUX/012 Holder - 25mm filters
TR-EMFS-F05	Semrock FF01-483/32-25, FF01-542/27-25, Dichroic FF506-Di02-25x36,
TR-EMFS-F07	Semrock FF01-497/16-25, FF01-550/32, Dichroic FF509-FDI01-25x36
TR-EMFS-F08	Semrock FF01-680/13-25, FF01-732/68-25, Dichroic FF700-Di01-25x36
TR-EMFS-F09	Semrock FF01-579/34-25, FF01-679/41-25, Dichroic FF640-FDI01-25x36
TR-EMFS-F12	Semrock FF01-579/34-25, FF01-692/40-25, Dichroic FF640-FDI01-25x36
TR-EMFS-F13	Semrock FF01-530/43-25, , Chroma HQ615LP, Dichroic FF580-FDI01-25x36
TR-EMFS-F14	Semrock FF02-525/50, FF01-692/40-25, Dichroic FF580-FDI01-25x36
TR-EMFS-F15	Chroma 50/50 beamsplitter,25.2x35.6x1mm laser flat
TR-EMFS-F17	Semrock FF02-525/40-25, FF01-640/40-25, Dichroic FF580-FDI01-25x36
TR-EMFS-F20	Semrock FF01-534/42-25, FF01-655/40-25, Dichroic FF580-FDI01-25x36
TR-EMFS-F21	Semrock FF01-534/42-25, FF01-641/75-25, Dichroic FF580-FDI01-25x36

Optosplit III

Base Unit Configurations

TR-OPTS-30B	Optosplit III - 1.0x magnification
-------------	------------------------------------

Standard Filter Sets

TR-OPTS-F10	Polarizing Filter Set
-------------	-----------------------

Optosplit II / III Accessories

TR-OPTS-F00	Optosplit filter cube - Empty filter cube for Optosplit II / III
-------------	--

Customer Support

Andor products are regularly used in critical applications and we can provide a variety of customer support services to maximize the return on your investment and ensure that your product continues to operate at its optimum performance. Andor has customer support teams located across North America, Asia and Europe, allowing us to provide local technical assistance and advice. Requests for support can be made at any time by contacting our technical support team at andor.com/support.

Andor offers a variety of support under the following format:

- On-site product specialists can assist you with the installation and commissioning of your chosen product
- Training services can be provided on-site or remotely via the Internet
- A testing service to confirm the integrity and optimize the performance of existing equipment in the field is also available on request.

A range of extended warranty packages are available for Andor products giving you the flexibility to choose one appropriate for your needs. These warranties allow you to obtain additional levels of service and include both on-site and remote support options, and may be purchased on a multi-year basis allowing users to fix their support costs over the operating life cycle of the products.



Head Office

7 Millennium Way
Springvale Business Park
Belfast BT12 7AL
Northern Ireland
Tel: +44 (0)28 9023 7126
Fax: +44 (0)28 9031 0792

North America

425 Sullivan Avenue
Suite 3
South Windsor, CT 06074
USA
Tel: +1 860-290-9211
Fax: +1 860-290-9566

Japan

4F TK Sarugakucho Building
2-7-6 Sarugaku-Cho
Chiyoda-Ku
Tokyo 101-0064
Japan
Tel: +81 (0)3-3518-6488
Fax: +81 (0)3-3518-6489

China

Room 1213, Building B
Luo Ke Time Square
No. 103 Huizhongli
Chaoyang District
Beijing 100101
China
Tel: +86 (0)10-5129-4977
Fax: +86 (0)10-6445-5401

Find us on

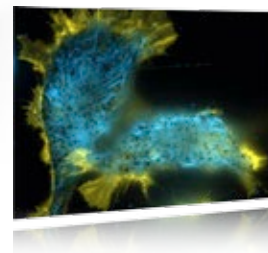

Front Cover Image:

Melanocytes with actin reich periphery (yellow). Black dots are pigment granules. The microtubule scaffold is highlighted in cyan.

Image courtesy of Dr. Ulrike Engel, Nikon Imaging Centre, Heidelberg, Germany.

Some projects part financed by the European Regional Development Fund under the European Sustainable Competitiveness Programme for Northern Ireland. Changes are periodically made to the product and specifications are subject to change without notice. Yokogawa is a registered trademark of Yokogawa Electric Company. Optosplit is a trademark of Cairn Research Ltd.