

# iStar

IsCMOS

Version 1.2 rev 11 Jun 2019



## Hardware Guide

for the iStar Intensified sCMOS camera

## TABLE OF CONTENTS

<b>SECTION 1: INTRODUCTION</b> .....	<b>9</b>
1.1 HELP AND TECHNICAL SUPPORT .....	10
1.2 DISCLAIMER .....	11
1.3 TRADEMARKS AND PATENT INFORMATION.....	11
1.4 SPECIFICATIONS .....	12
1.5 COMPONENTS.....	13
1.5.1 ACCESSORIES.....	14
<b>SECTION 2: PRODUCT OVERVIEW</b> .....	<b>15</b>
2.1 HARDWARE DESCRIPTION .....	15
2.2 POWER AND SIGNAL CONNECTIONS .....	16
2.2.1 CONNECTOR PLATE.....	16
2.2.2 POWER SUPPLY UNIT (PSU) .....	18
<b>SECTION 3: INSTALLATION</b> .....	<b>19</b>
3.1 CONNECTING THE ISTAR SCMOS TO OTHER EQUIPMENT.....	19
3.1.1 ATTACHING TO A SPECTROGRAPH.....	19
3.1.2 ATTACHING TO A LENS SYSTEM .....	20
3.1.3 ATTACHING TO MOUNTING POSTS .....	20
3.1.4 ALTERNATIVE PROTECTIVE EARTH VIA EARTH STUD .....	20
3.1.5 CONNECTING THE ISTAR SCMOS CAMERA TO THE PC.....	21
3.2 COOLING.....	22
3.2.1 IMPORTANT CONSIDERATIONS WHEN USING LIQUID COOLING SYSTEMS .....	22
3.3 COOLING HOSE CONNECTORS.....	22
3.3.1 COOLANT RECOMMENDATIONS.....	22
3.4 CONNECTING THE LIQUID COOLING SYSTEM .....	23
3.4.1 CONNECTING THE COOLANT HOSES .....	23
3.4.2 DISCONNECTING THE COOLANT HOSES .....	23
3.5 INSTALLING SOFTWARE AND USB DRIVERS.....	24
3.5.1 MINIMUM COMPUTER REQUIREMENTS .....	24
3.5.2 INSTALLING SOLIS SOFTWARE AND USB DRIVER.....	24
3.5.3 NEW HARDWARE WIZARD .....	24

<b>SECTION 4: OPERATION</b> .....	<b>25</b>
4.1 EMERGENCY MAINS DISCONNECTION .....	25
4.2 POWER-UP SEQUENCE.....	25
4.3 POWER-DOWN SEQUENCE.....	25
4.4 USING THE ISTAR SCMOS CAMERA .....	25
4.5 PRE-ACQUISITION SETUP.....	26
4.5.1 SETTING THE COOLING TEMPERATURE.....	26
4.5.2 FAN CONTROL .....	26
4.6 SETUP ACQUISITION PANEL.....	27
4.7 ACQUISITION MODES .....	28
4.7.1 SINGLE SCAN.....	28
4.7.2 KINETIC SERIES.....	28
4.7.3 ACCUMULATE .....	28
4.7.4 RUN TILL ABORT ACQUISITION.....	29
4.7.4.1 LIVE MODE.....	29
4.7.5 FAST EXPOSURE SWITCH .....	29
4.7.6 FRAME RATE CONTROL .....	30
4.8 READOUT MODES.....	30
4.8.1 BINNING/ROI .....	31
4.8.2 ORIENTATION.....	32
4.8.3 ACQUISITION AND DATA TYPES SELECTION .....	32
4.8.3.1 DEFINITIONS OF DATA TYPES .....	32
4.8.3.2 DATA DISPLAY AND PROCESSING MODES .....	33
4.8.4 AUTOSCALE ACQUISITION .....	34
4.8.5 DATA FILE HANDLING .....	35
4.8.5.1 SPOOLING (DATA SPOOLING).....	35
4.8.5.2 VIRTUAL MEMORY.....	35
4.8.5.3 AUTO-SAVE .....	36
4.8.6 DATAFLOW MONITOR .....	36

4.9	GATING AND IMAGE INTENSIFIER SETTINGS (GATING) .....	37
4.9.1	GATE MODES.....	37
4.9.2	USING THE GATE MONITOR .....	39
4.9.3	MCP GAIN .....	40
4.9.4	INSERTION DELAY.....	41
4.9.5	INTELLIGATE .....	43
4.9.6	INTEGRATE ON CHIP (IOC) .....	44
4.9.7	DIGITAL DELAY GENERATOR (DDG) STEP (INCLUDING GATE STEP).....	46
4.9.7.1	STEP MODE CONFIGURATION .....	46
4.9.7.2	STEP UPLOAD.....	48
4.10	TRIGGERING MODES .....	49
4.10.1	INTERNAL TRIGGER.....	49
4.10.2	EXTERNAL TRIGGER.....	49
4.10.3	EXTERNAL START.....	50
4.10.4	SOFTWARE TRIGGER.....	50
4.10.5	EXTERNAL EXPOSURE TRIGGER .....	50
4.11	SETTING UP PIV MODE ON ISTAR SCMOS .....	51
4.11.1	SOLIS SETTINGS FOR PIV MODE.....	51
4.11.2	SETTING UP THE EXTERNAL DELAY GENERATOR (DDG) FOR TWO INPUT SIGNALS.....	52
	<b>SECTION 5: MAINTENANCE.....</b>	<b>53</b>
5.1	REGULAR CHECKS .....	53
5.2	ANNUAL ELECTRICAL SAFETY CHECKS .....	53
5.3	FUSE REPLACEMENT .....	53
5.4	COOLING HOSES AND CONNECTIONS.....	53

<b>SECTION 6: TROUBLESHOOTING .....</b>	<b>54</b>
6.1 CAMERA BUZZER DOES NOT SOUND ON START-UP .....	54
6.2 CAMERA IS NOT RECOGNIZED BY PC.....	54
6.3 BUZZER SOUNDS CONTINUOUSLY.....	54
6.4 FAN NOT OPERATING AS EXPECTED.....	54
6.5 CAMERA DOES NOT COOL TO THE REQUIRED TEMPERATURE.....	54
6.6 PREVENTING CONDENSATION .....	54
<b>APPENDIX A: MECHANICAL DRAWINGS .....</b>	<b>56</b>
<b>APPENDIX B: DEW POINT GRAPH .....</b>	<b>57</b>
<b>APPENDIX C: INTENSIFIER INFORMATION .....</b>	<b>58</b>
<b>APPENDIX D: DDG INFORMATION .....</b>	<b>60</b>
<b>APPENDIX E: SCMOS STRUCTURE AND OPERATION .....</b>	<b>63</b>
<b>APPENDIX F: OTHER INFORMATION .....</b>	<b>70</b>

## SAFETY AND WARNING INFORMATION



PLEASE READ THIS INFORMATION FIRST BEFORE USING YOUR iSTAR INTENSIFIED sCMOS CAMERA.

1. To ensure correct and safe operation of this product, please read this guide before use and keep it in a safe place for future reference
2. If equipment is used in a manner not specified by Andor, the protection provided by the equipment may be impaired
3. Before using the system, please follow and adhere to all warnings, safety, manual handling and operating instructions located either on the product or in this manual
4. An integral part of protection against electric shock in the case of a fault is the protective earth provided via the earth conductors in the mains cable. It is therefore vital that the earth system of the building, and in particular the socket, is constructed properly to provide suitable protection when needed.
5. As the main protective earth is also provided via the Andor-supplied External Power Supply, then if this is not used, the alternative Earth Stud must be used instead (see page 20).
6. The Andor iStar sCMOS is a precision scientific instrument containing fragile components. Always handle with care
7. Do not expose the product to extreme hot or cold temperatures
8. Ensure that a minimum clearance of approximately 100mm (4") is maintained in front of all ventilation slots and the fan inlet
9. If using water cooling, ensure that cooling water supply is connected prior to powering the camera.
10. Do not expose the product to open flames
11. Do not allow objects to fall on the product
12. Do not expose the product to moisture, wet or spill liquids on the product. Do not store or place liquids on the product. If a spillage occurs on the product, switch off power immediately, and wipe off with dry, lint-free cloth. If any ingress has occurred or is suspected, unplug the mains cable, do not use, and contact Andor service
13. The product contains components that are extremely sensitive to static electricity and radiated electromagnetic fields, and therefore should not be used, or stored, close to EMI/RFI generators, electrostatic field generators, electromagnetic or radioactive devices, or other similar sources of high energy fields
14. Operation of the system close to intense pulsed sources (e.g. plasma sources, arc welders, radio frequency generators, X-ray instruments, and pulsed discharge optical sources) may compromise performance if shielding of the iStar sCMOS is inadequate
15. This product is not designed to provide protection from ionising radiation. Any customer using this product in such an application should provide their own protection
16. The Andor iStar sCMOS is for use in research laboratories and other controlled scientific environments
17. This equipment has not been designed and manufactured for the medical diagnosis of patients
18. Use only the power supply cord provided with the system for this unit. Should this not be correct for your geographical area contact your local Andor representative
19. Only the correctly specified mains supply and fuse must be used
20. Make sure the electrical cord is located so that it will not be subject to damage
22. There are no user-serviceable parts beyond the specified user accessible areas of the product and the enclosure must not be opened. Only authorised service personnel may service this equipment



23. The above label indicates that this unit contains components which are sensitive to and can be damaged by electrostatic discharge. When working on a unit which is not enclosed, it is necessary to follow anti static precautions to ensure damage does not occur.

## REGULATORY COMPLIANCE



The iStar sCMOS complies with the requirements of the EU EMC and LV Directives through testing to EN 61326-1 and EN 61010-1.



This product requires a DC power supply (refer to **Section 1.6**)

## ADDITIONAL NOTES - AVOIDING DAMAGE TO THE IMAGE INTENSIFIER

An image intensifier is a very sensitive instrument, with care and good working practice, it should last many years.

1. There are two major potential forms of damage to be considered:

- **Bleaching of the photocathode** brought about by over-illumination of this photo-sensitive interface

Bleaching of the photocathode reduces the Quantum Efficiency (QE) response (it can render it completely unresponsive) and may permanently increase the background noise of the Image Intensifier.

- **Ion damage of the cathode** brought about by excessive numbers of photoelectrons in the Multichannel Plate (hereinafter referred to as the MCP). As a general rule of thumb, when the sensor is already saturated, this type of damage is liable to occur.

Excessive numbers of photoelectrons in the MCP brought about by excessive input light levels, or moderate light levels and excessive gain can damage both the photocathode, MCP or the phosphor screen.

If the multichannel plate is overloaded with incoming electrons, it is much more likely for positive ions to be knocked out of the walls of the multichannel plate by the colliding electrons. These ions are accelerated towards the photocathode and can do considerable mechanical damage.

Excessive electrons can also increase the outgassing rate inside the tube to the point where the vacuum is seriously diminished.

The protection circuitry in the iStar sCMOS monitors the current drawn by the phosphor, which is indirectly linked to the incident signal intensity as seen through the MCP gain chain. Above a certain level the high voltage power supply at the MCP shuts down to prevent damage. However, when only a sub-section of the phosphor / photocathode is illuminated, damage can occur without the high voltage supply shutting down. Applications involving focusing of strong spectral line features, or confined bright spots in an imaging scenario must therefore be treated with appropriate caution.

### The following best practices should be observed:

Always maintain the measured signal below the saturation level of the sensor. This should constitute a safe operating condition in most circumstances.

- Do not focus features of  $<50\ \mu\text{m}$  on the photocathode (i.e. stay around the resolution limit of the iStar sCMOS). For example, a  $10\ \mu\text{m}$  feature might be sufficiently intense to damage the photocathode but, when it is smeared out to  $\sim 50\ \mu\text{m}$ , it may not be saturating the sensor and therefore satisfies the general guideline above. This applies to images and to spectra. Be particularly careful with automatic spectrographs that reset themselves with the brighter zero order on the center of the focal plane.
  - Always keep the photocathode covered when the detector is not in use (the photocathode will degrade even when switched off). This can be facilitated by using a mechanical shutter whenever possible.
  - If you are unsure of the signal levels to be detected, one should start with low signal levels and build up. If necessary, use a CCD detector to check the signal level.
  - Protect the iStar sCMOS from mechanical shock both in use, and in transit, as damage to the intensifier tube may result from sharp jolts.
2. To remove dirt or fingerprints on the input window of the image intensifier, please contact your local Andor representative for advice on how to best clean this interface.
  3. Turning off the iStar sCMOS camera through mains or camera On/Off switch during acquisition or cooling may result in damage to the camera. When possible, ensure sensor cooling temperature should be  $> 0^\circ\text{C}$  (after switching Off the cooler) before turning off the camera.
  4. Prior to mounting the camera on an optical system, the black grommet which covers the image intensifier and protects it from unwanted photo-bleaching must be carefully removed without the use of any tools such as screwdrivers.

## REVISION HISTORY

Version	Released	Description
1.0	19 Sep 2016	Initial Release. Limited distribution in compact format.
1.1	06 Apr 2017	Added additional information regarding alternative earthing requirements if the standard supplied power supply is not used with the product.
1.2	11 Jun 2019	Updated USA and Asia-Pacific addresses and updated back panel image.



## SECTION 1: INTRODUCTION

Thank you for choosing the **iStar intensified Scientific CMOS (sCMOS) camera**. You are now in possession of a revolutionary new intensified camera which combines the ultra-fast, gated image intensifier technology of the Andor iStar with the high resolution, dynamic, high speed sCMOS sensor as seen previously in the Andor Zyla and Neo.



Figure 1: The iStar sCMOS Camera

This manual contains useful information and advice to ensure you get the optimum performance from your new system. If you have any questions regarding your iStar sCMOS, camera please feel free to contact Andor directly, or via your local representative or supplier.

## 1.1 HELP AND TECHNICAL SUPPORT

If you have any questions regarding the use of this equipment, please contact the representative\* from whom your system was purchased, or:

### Europe

Andor Technology Ltd.  
7 Millennium Way  
Springvale Business Park  
Belfast  
BT12 7AL  
Northern Ireland  
Tel. +44 (0) 28 9023 7126  
Fax. +44 (0) 28 9031 0792

### USA

Andor Technology  
300 Baker Avenue  
Suite # 150  
Concord  
MA 01742  
USA  
Tel. +1 (860) 290-9211  
Fax. +1 (860) 290-9566

### Asia-Pacific

Andor Technology (Japan)  
5F IS Building  
3-32-42 Higashi-Shinagawa  
Tokyo 140-0002  
Japan  
Tel: +81 3 6732 8968  
Fax: +81 3 6732 8939

### China

Andor Technology  
Unit 1, Building A,  
66 Zhufang Rd, Haidian Dist.  
Beijing 100085  
China  
Tel: +86 (0)10 8271 9066  
Fax. +86(0)10 8271 9055

\* The latest contact details for your local representative can be found on the [Contact and Support](#) page of our website.

## 1.2 DISCLAIMER

THE INFORMATION CONTAINED HEREIN IS PROVIDED "AS IS" WITHOUT WARRANTY, CONDITION OR REPRESENTATION OF ANY KIND, EITHER EXPRESS, IMPLIED, STATUTORY OR OTHERWISE, INCLUDING BUT NOT LIMITED TO, ANY WARRANTY OF MERCHANTABILITY, NON-INFRINGEMENT OR FITNESS FOR A PARTICULAR PURPOSE.

IN NO EVENT SHALL ANDOR BE LIABLE FOR ANY LOSS OR DAMAGE, WHETHER DIRECT, INDIRECT, SPECIAL, INCIDENTAL, CONSEQUENTIAL OR OTHERWISE HOWSOEVER CAUSED WHETHER ARISING IN CONTRACT, TORT OR OTHERWISE, ARISING OUT OF OR IN CONNECTION WITH THE USE OF THE INFORMATION PROVIDED HEREIN.

### **COPYRIGHT AND PROTECTIVE NOTICES:**

The copyright in this document and the associated drawings are the property of Andor Technology Ltd. and all rights are reserved. This document and the associated drawings are issued on condition that they are not copied, reprinted or reproduced, nor their contents disclosed.

The publication of information in this documentation does not imply freedom from any patent or proprietary right of Andor Technology Ltd. or any third party.

## 1.3 TRADEMARKS AND PATENT INFORMATION

Andor, the Andor logo, iStar and Solis are trademarks of Andor Technology Ltd. Andor Technology Ltd is an Oxford Instruments company. All other marks are property of their owners.

Changes are periodically made to the product and these will be incorporated into new editions of the manual. New releases of the manual are available through MyAndor: <https://my.andor.com/login.aspx>.

## 1.4 SPECIFICATIONS

**Table 1: Technical Specifications of the iStar sCMOS Camera**

Parameter	Specification						
Sensor Type	Front-illuminated Scientific CMOS						
Sensor Matrix	2560 x 2160 pixels (W x H), 6.5 µm pixel size 						
Sensor Size	16.6 x 14.0 mm 21.8 mm diagonal						
Pixel Well Depth (e <sup>-</sup> )	30,000						
Read Noise (e <sup>-</sup> ) Median [RMS] at available readout rates	@200 MHz 2.4 [2.7] @560 MHz 2.6 [2.9]						
Minimum Cooling Temperature [dark current, e <sup>-</sup> /pixel/s] air cooled liquid cooled	<table border="1"> <thead> <tr> <th>Ø18 mm photocathode</th> <th>Ø25 mm photocathode</th> </tr> </thead> <tbody> <tr> <td>0°C [0.18]</td> <td>0°C [0.18]</td> </tr> <tr> <td>0°C [0.18]</td> <td>0°C [0.18]</td> </tr> </tbody> </table>	Ø18 mm photocathode	Ø25 mm photocathode	0°C [0.18]	0°C [0.18]	0°C [0.18]	0°C [0.18]
Ø18 mm photocathode	Ø25 mm photocathode						
0°C [0.18]	0°C [0.18]						
0°C [0.18]	0°C [0.18]						
Sensor Linearity (% maximum)	Better than 99.8%						
Data Range	12-bit (fastest speed) and 16-bit maximum dynamic range)						
Pixel Binning	On-head, pre-defined options 2x2, 4x4... or flexible configuration setup						
Region of Interest	Minimum channel height of 8 rows						
Interface Option	USB 3.0						
Internal Memory	1GB						
AC/DC Power supply ratings	100 - 240 VAC, 43 - 67 Hz						
External PSU Specifications	12 V, 9 A output max Connector: 3-pin Redel <i>Refer to Section 2.2.2 for detailed specifications</i>						
Power Consumption	Camera + External Power Supply (Typ./ Max.): 69 W/ 124 W Camera Only (Typ./ Max.): 60 W/ 108 W						
Location to be used	Indoor use only						
Altitude	Up to 2000 m						
Ambient Operating Temperature range	0°C to 40°C						
Storage temperature	-20°C to +55°C						
Operating relative humidity	< 70% non-condensing						
Overvoltage category	CAT II AC/DC, CAT I Camera						
Pollution degree	Pollution degree 2. Normally only non-conductive pollution occurs. Occasionally, however, a temporary conductivity caused by condensation must be expected.						
Ingress protection rating	IP20						
Electromagnetic compatibility	This is a Class A product. In a domestic environment this product may cause electromagnetic interference, in which case the user may be required to take adequate measures						
Cooling vent clearance	100 mm minimum						
Dimensions (LxWxH)	231.0 [9.09] x 110.7 [4.36] x 137.2 [5.40] mm [inches] Water connectors add 23.3 [0.92] length.						
Weight	4.5 kg [9 lb 15 oz]						







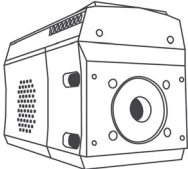

Note: for QE curve information please refer to Appendix C

## 1.5 COMPONENTS

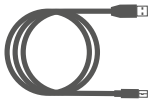
The standard components supplied with the iStar sCMOS are shown in **Table 2**. Note that the iStar sCMOS camera requires camera control software e.g. Solis, supplied separately.

**Table 2: Standard Components supplied with the iStar sCMOS**

	Description	Quantity
	iStar Intensified sCMOS Camera	1

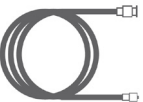
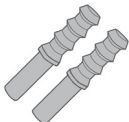
Description	Quantity	Description	Quantity
	1		1
	1 x 3 m		4
	1		1
	2 x 3 m		1
	1		2

\* Note: please check MyAndor for the latest product documentation.

### 1.5.1 ACCESSORIES

There is a range of optional and additional accessories available for your iStar sCMOS camera including:

- C-Mount Lens Adaptor Kit (P/N LM-C), comprising C-mount adaptor, spacer tubes, screws & allen key.
- Nikon F-Mount Lens Adaptor (P/N LM-NIKON-F).
- Nikon F-Mount adaptor with shutter (P/N LMS-NIKON-F-NS25B).

**Note: The use of a mechanical shutter is recommended. Although Image Intensifiers act as efficient optical shutters, the use of a mechanical shutter is recommended when the camera is not used to protect the photocathode from “passive” photo-bleaching.**

## SECTION 2: PRODUCT OVERVIEW

### 2.1 HARDWARE DESCRIPTION

This section provides an overview of the external and other features of the iStar sCMOS camera.

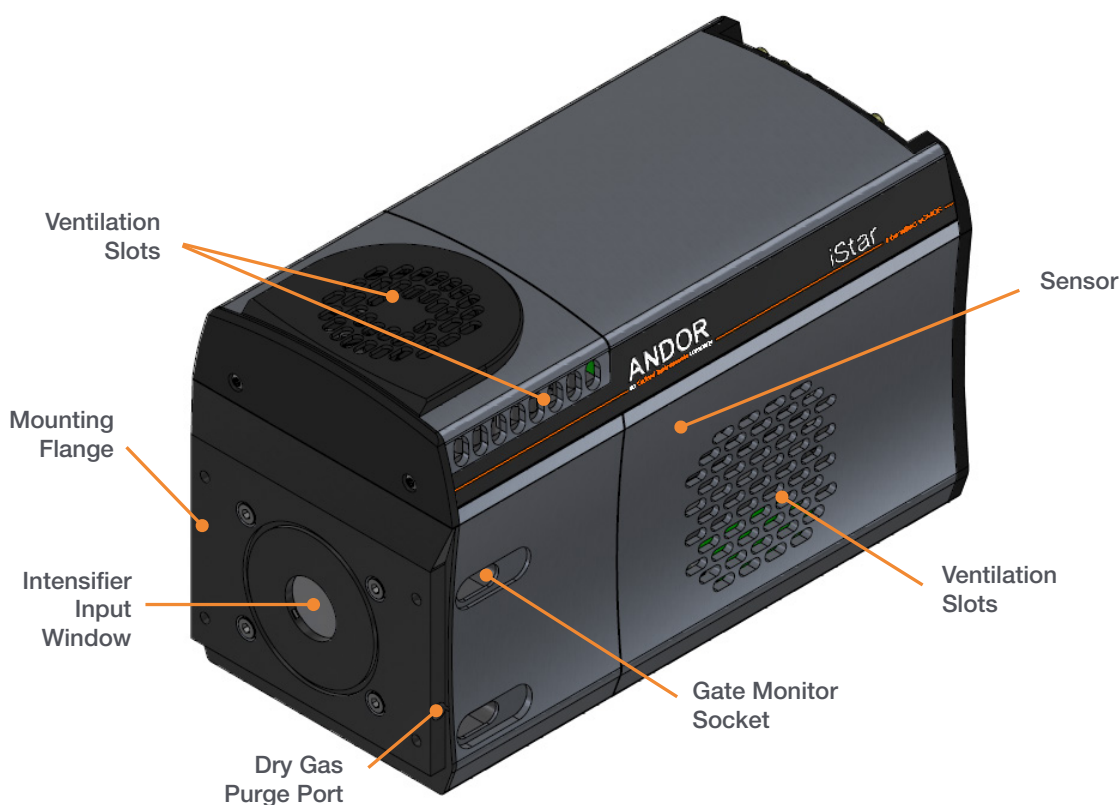

Figure 2: External features of the iStar sCMOS Camera

#### Intensifier Input Window

The input window protects the intensifier and internal optical components from exposure to contaminants and moisture that would otherwise impact performance.

#### Mounting Flange

The mounting flange enables the iStar sCMOS to be mounted to a wide range of optical components. Refer to mechanical drawings in Appendix A.

#### Sensor

The iStar sCMOS features a scientific sCMOS sensor.

#### Gate Monitor Socket

The gate monitor socket is located behind the grommet.

#### Ventilation Slots

There are two sets of ventilation slots. At the top of the camera, air is taken in through the top grill and passed out through the side grills. At the side of the camera, air is taken through the side shown above, and passed out through the opposite side. Ensure that there is sufficient space (>100 mm) to enable adequate ventilation.

#### Dry Gas Purge Port

Dry gas purge for intensifier input window, push fit for 6.0 mm [0.24] O.D. plastic hose (vent on opposite side).

## 2.2 POWER AND SIGNAL CONNECTIONS

### 2.2.1 CONNECTOR PLATE

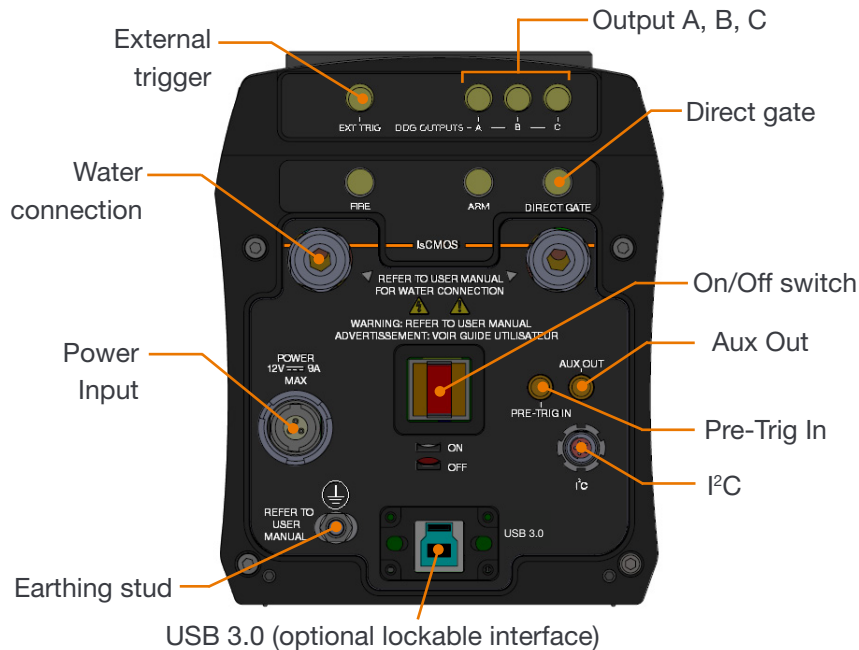

Figure 3: iStar Connections

#### Power Input

For connection to the external PSU (refer to Section 2.2.2). An On/Off switch is also present (shown above).

#### USB

A USB 3.0 compatible cable can be connected between the USB socket and a PC. An optional locking interface is also available.

#### Direct gate

TTL compatible input used to directly gate the photocathode of the image intensifier tube, i.e. switch it On and Off. The photocathode is On when the input is high. User should provide (electrical) pulse width and appropriate gate pulse delay

#### Logic Input / Output (SMA) Connections

The user can synchronize the readout of the iStar sCMOS camera to external events / equipment by means of the SMA connections. The functions of each are detailed below:

- **Ext Trig (External Trigger):** TTL compatible input which is used to initiate data acquisition by the camera
- **Digital Delay Generator Outputs A, B & C:** Programmable 5V CMOS level outputs used to synchronize external events / equipment with operation of the iStar sCMOS
- **Fire:** 5V CMOS level reference signal relating to the sensor exposure time. This output remains high during the charge / signal accumulation period, i.e. the time during which charge from the image area is not being read-out
- **Arm:** 5V CMOS level reference signal to indicate when system is ready to accept external triggers. Signal goes high when system is ready to accept external triggers after a readout sequence has finished.
- **Aux Out** (external mechanical shutter output) Configured by default to a 5V CMOS level with 50  $\Omega$



impedance shutter output for controlling Andor Shamrock spectrograph mechanical shutters.

- **Pre-Trig In** Controls the sensor exposure in 'external exposure mode'. Also available in 'external trigger mode' as a optional exclusive trigger to the sensor.

## I<sup>2</sup>C

Compatible with Fischer SC102A054-130, pin-outs as follow: 1 = Shutter (5V CMOS level with 50 Ω impedance), 2 = I<sup>2</sup>C Clock (5V), 3 = I<sup>2</sup>C Data (5V), 4 = +5 Vdc, 5 = Ground. The pin-outs of this connector are shown below:

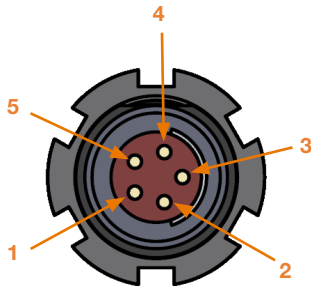

Pin	Function
1	SHUTTER (TTL)
2	I <sup>2</sup> C CLOCK
3	I <sup>2</sup> C DATA
4	+5 V
5	GROUND

Figure 4: Pin outs of the I<sup>2</sup>C connector

## Earthing Stud

Enables the iStar sCMOS to be connected to an external earthing point to maintain low noise and/or is used as an alternative Protective Earth Connector Terminal in the event that the Andor-supplied External Power Supply is not used, e.g. by an OEM (see page 20).

## Water/Liquid Cooling Connections

Refer to Section 3.2 for information on the use of water/liquid cooling.

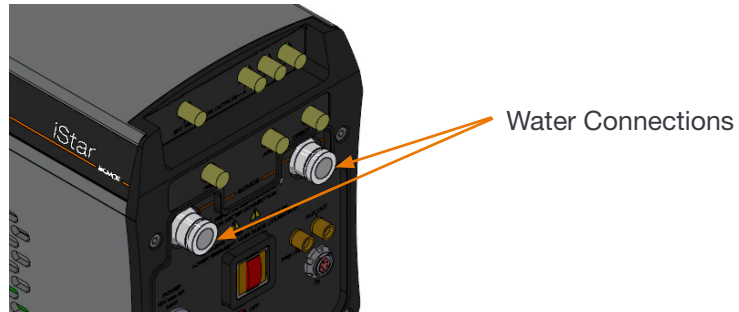

## Gate Monitor

Enables user to monitor the accurate, actual On and Off switching of the photocathode (located as shown below).

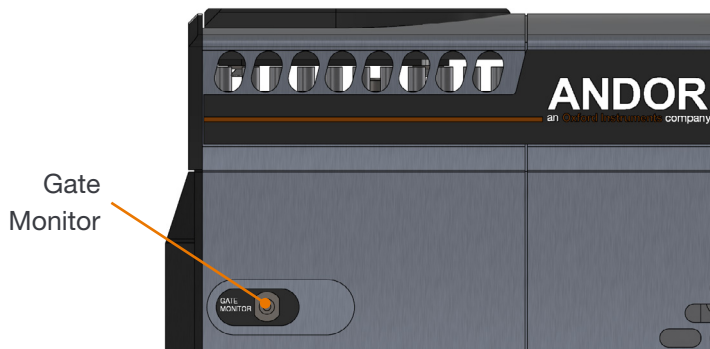

## 2.2.2 POWER SUPPLY UNIT (PSU)

### Camera Power Input (12 V DC)

The iStar sCMOS camera is powered by an external 12 V DC Power Supply Unit (PSU). The iStar sCMOS camera is connected to the PSU via a 3-pin Redel cable plug (Part No. PAH.N0.3GL.LC65G).

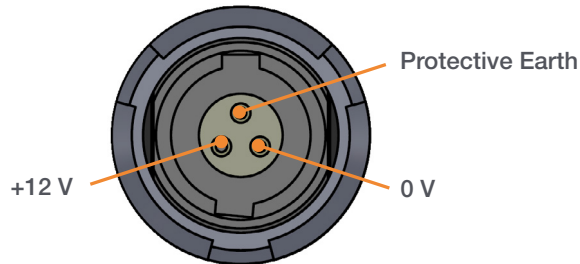

Figure 5: 3-pin Power Connection pin outs

Ensure that the power connector is inserted correctly. Never forcibly insert the connector otherwise damage to the equipment may occur.

 The iStar sCMOS requires a Direct Current (DC) supply.

### External Power Supply (PSU)

Parameter	Specification
Input Characteristics	100 - 240 VAC, 43 - 67 Hz
Output	Low Voltage Output: 12 V d.c. $\pm$ 5% Low Voltage Output Ripple: 120 mV max. Steady State Current Output: 9 A min. In-rush current from a non-current limited power source with a 0.1 $\Omega$ source resistance is 50 A peak with a half-height pulse width of 15 $\mu$ S



Figure 6: External Power Supply Unit

#### NOTES:

1. The electrical mains lead should be certified for use in your country and in applicable countries the plug must be fitted with a 240V 5A fuse.
2. If users use any other power supply, they do so at their own risk.

## SECTION 3: INSTALLATION

**WARNING:** Prior to commencing installation, the user should refer to the safety and warning information at the beginning of this manual.

### 3.1 CONNECTING THE ISTAR sCMOS TO OTHER EQUIPMENT

#### 3.1.1 ATTACHING TO A SPECTROGRAPH

The iStar sCMOS can be easily connected to an Andor **spectrograph**. If the iStar sCMOS and Andor's spectrograph have been ordered at the same time, the system will arrive already pre-aligned and integrated. If this is not the case, such as matching the iStar sCMOS to an existing, or third-party spectrograph - the following general guidelines should be observed. Refer also to the instructions supplied with other system components for mounting cameras and detectors.



1. Bolt the **detector** to the **camera mounting flange**, ensuring that the head is correctly orientated and that the appropriate **O-ring** is inserted at the front of the detector head.
2. Attach the **camera mounting flange** to the spectrograph, ensuring that the appropriate **O-ring** is in place between both detector flange and spectrograph flange.
3. Secure all four attachment screws so that the detector head, the flanges and the spectrograph are fitted together securely in order to allow correct grounding through the connector cable. Good grounding maintains the low noise performance of the detector, and in severe environments may prevent the instrument from damage.

### 3.1.2 ATTACHING TO A LENS SYSTEM

The iStar sCMOS can also be easily connected to a **lens system** for imaging purposes. Your local Andor representative can supply details of the available adaptors for connecting the **iStar sCMOS** to various manufacturers' lenses. The following general instructions should be followed:



1. When attaching the iStar sCMOS to a **lens adaptor** (C-Mount or F-Mount for example), ensure first that the adaptor is correctly orientated and aligned. Ensure that the appropriate **O-ring** is inserted between the camera front plate and the **lens adaptor** plate. In the case of the C-Mount, place the side of the adaptor that is flush with the metal insert towards the iStar sCMOS front plate. Ensure that all four attachment screws are secured to the adaptor.
2. Attach the appropriate lens into the metal insert (C-Mount) or bayonet interface (F-Mount) of the lens adaptor.

### 3.1.3 ATTACHING TO MOUNTING POSTS

Three ¼ -20 UNC threaded holes are located on the underside of the camera as shown below. For further information, refer to the mechanical drawings in **Appendix A**.

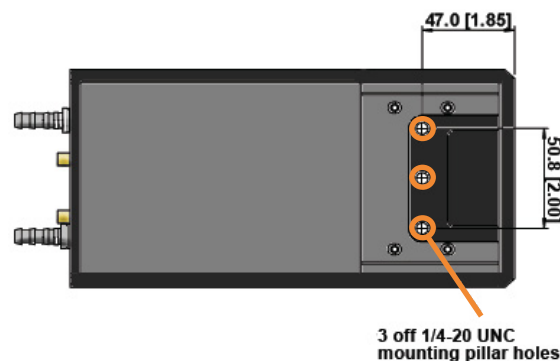

### 3.1.4 ALTERNATIVE PROTECTIVE EARTH VIA EARTH STUD

As the main Protective Earth is provided via the Andor-supplied External Power Supply, then if this is not used, the alternative Earth Stud (see section 2.2.1) must be used instead as follows:

- A double-crimped, M4 Ring Terminal with 10AWG (6 mm<sup>2</sup>) or larger, green and yellow striped, insulated wire must be connected and it is the responsibility of the customer that it is suitably and reliably connected at the other end to the building's protective earth system.

## 3.1.5 CONNECTING THE ISTAR sCMOS CAMERA TO THE PC

Connect the USB 3.0 cable from the iStar sCMOS Camera to a suitable USB 3.0 slot on the control PC



USB 3.0 connection between camera and PC

## 3.2 COOLING



The iStar sCMOS can use either air cooling, or optional water/liquid cooling.

### 3.2.1 IMPORTANT CONSIDERATIONS WHEN USING LIQUID COOLING SYSTEMS

- Before attempting to insert or remove the coolant hose connections, ensure that all coolant has been drained from the hoses and integral coolant channel within the camera head.
- Care must be taken to avoid permanent damage to the camera system resulting from either leakage of coolant during connection / removal of hoses or spillage of any residual coolant contained within the camera head once the hoses have been removed.
- Always ensure that the temperature of the liquid coolant circulated through the camera head is above the dew point of the camera ambient temperature and humidity conditions. Refer to the Dew Point graph in **Appendix B** for guidance.
- Use of coolant at or below the dew point can result in permanent damage to the camera head, due to formation of condensation on internal components.
- Never use damaged, split or worn hoses.
- In the event that replacement hose inserts / barbs are required, please contact your local Andor representative

## 3.3 COOLING HOSE CONNECTORS

There are two connectors to allow connection of the iStar sCMOS to a water cooler, or re-circulator. Hose inserts are provided to enable connection to coolant hoses.

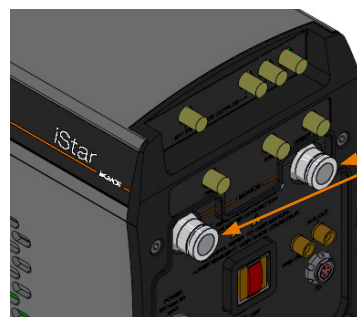

Water Connections  
on rear panel

**Coolant Hose Connectors:** Two barbed coolant hose inserts are supplied as standard, suitable for connection to 6 mm (0.25”) internal diameter soft PVC tubing / hose.

**Recommended tubing:** 10 mm (0.4”) outside diameter, i.e. a wall thickness of 2 mm (0.08”). Alternative hose dimensions and materials should be thoroughly tested to ensure a leak tight seal is achieved with the barbed inserts.

### 3.3.1 COOLANT RECOMMENDATIONS

It is recommended that de-ionized water (without additives) is used as the coolant to prevent deposits forming. Some mains supply water is heavily mineralized (i.e. “Hard”) which could cause deposits in the water circuit inside the camera. This can reduce the flow-rate and cooling efficiency.

The specified cooling performance of the camera can be achieved with coolant flow rates of 2 litres per minute, the maximum recommended pressure of coolant circulating through the camera head is 2 bar (30 PSI).

In the event that replacement hose inserts / barbs are required, please contact your local Andor representative.

## 3.4 CONNECTING THE LIQUID COOLING SYSTEM

An overview for connecting an liquid cooling system is outlined below- please refer to the information supplied with your cooling system for information specific to its operation.

### 3.4.1 CONNECTING THE COOLANT HOSES

1. Press the hose insert into the coolant hose, and repeat for the second hose.



2. Press the hose connectors into the connections on the camera head, ensure they click into place.



3. Confirm the hoses are connected securely by applying pressure on the front of the camera body and pulling backwards on each hose.
4. Connect the other ends of the coolant hoses to the cooling system- refer to the cooling system manual.

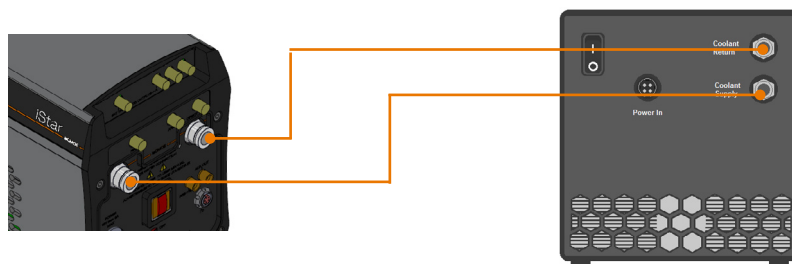

### 3.4.2 DISCONNECTING THE COOLANT HOSES

1. Press the latch on the camera hose connection away from the hose.



2. Hold the latch in and pull the hose backwards.
3. The hose should release from the camera connection with little resistance.

**NOTE:** If the hose does not release, ensure that the latch on the camera connection is pressed in fully as shown above.

## 3.5 INSTALLING SOFTWARE AND USB DRIVERS

### 3.5.1 MINIMUM COMPUTER REQUIREMENTS

- 3 GHz Quad Core or 2.4 GHz multi core processor
- 4 GB RAM
- Hard drive capable of sustained rate of 450 MB/s
- USB 3.0 High Speed Host Controller
- Windows (7, 8 or 10) or Linux

### 3.5.2 INSTALLING SOLIS SOFTWARE AND USB DRIVER

1. Terminate & exit any applications which are running on the PC.
2. Insert the Andor Solis CD. The InstallShield Wizard should now start. If it does not start automatically, run the file setup.exe directly from the CD.
3. Select appropriate location for installation of software and drivers on your computer / network.
4. When prompted, select iStar sCMOS.
5. Continue installation and restart your computer - when prompted - to successfully complete the installation.
6. The shortcut icon for Solis will appear on the desktop on re-start.
7. The iStar sCMOS is now ready to be connected to a PC / laptop and powered on.

### 3.5.3 NEW HARDWARE WIZARD

When the iStar sCMOS camera is connected to a PC for the first time, the **New Hardware Wizard** screen will appear.

1. Select the '**No, not this time only**' option then click **Next>**.
2. Select the '**Install from a list or specified location (Advanced)**' option then click **Next>**.
3. Navigate to the directory where the Andor Solis software was installed to on the PC, then click **Next>** so that **the Installation Wizard can start**.
4. Click the **Finish** button to complete the installation.

**Note: If the camera is connected to a different USB port, steps 1 – 4 will have to be repeated on the first connection only.**

5. A system message will appear to indicate that the device has been successfully installed.

Note: You can check that the iStar sCMOS is correctly recognized and installed by opening the Device Manager (Devices and printers) in Windows, Control Panels. The iStar sCMOS will show under the Devices list.



## SECTION 4: OPERATION

### WARNINGS:

- **IF THE EQUIPMENT IS USED IN A MANNER NOT SPECIFIED BY ANDOR OR ITS DISTRIBUTORS, THE PROTECTION PROVIDED BY THE EQUIPMENT MAY BE IMPAIRED.**
- **PLEASE READ THE USER GUIDES SUPPLIED WITH YOUR SYSTEM COMPONENTS AND SOFTWARE PRIOR TO USE**

### 4.1 EMERGENCY MAINS DISCONNECTION

In case of emergency, the disconnecting point of the equipment is the mains power cord connected to the external power supply, or the mains socket switch.

**WARNING: SWITCH OFF THE POWER AT THE MAINS SOCKET AND REMOVE THE MAINS LEAD FROM THE EXTERNAL POWER SUPPLY.**

### 4.2 POWER-UP SEQUENCE

1. Ensure that the camera is powered on at the mains power supply.
2. Ensure that the USB 3 cable is connected between the camera and the PC.
3. Start up the PC.
4. Ensure the On/Off switch on the camera is set to On.
5. Launch your camera control software e.g. Solis or SDK.
6. The camera will now start up under control of the software and you are ready to use the camera.
7. Refer to your software manual for set-up and image acquisition information.

### 4.3 POWER-DOWN SEQUENCE

1. Exit the camera control software.
2. The camera will automatically turn off.
3. Switch off power to the camera at the mains power socket.

### 4.4 USING THE ISTAR sCMOS CAMERA

This section provides an overview of how to set up and use the basic functions of the iStar sCMOS camera in Solis. On-line help is built into Solis and available through the Solis Help Menu. This provides a full description of the features available. For other software, please refer to the software guide provided with your software.

## 4.5 PRE-ACQUISITION SETUP

### 4.5.1 SETTING THE COOLING TEMPERATURE

The iStar sCMOS has a default cooling temperature set at 0°C.

### 4.5.2 FAN CONTROL

The cooling fan can also be turned Off or On in the software.

1. Select Fan Control from the Hardware drop-down menu.
2. Select whether fans should be activated, or deactivated during cooling and/or acquisition.

## 4.6 SETUP ACQUISITION PANEL

The Setup Acquisition Panel (shown below) covers a range of set-up options for the camera- these functions and settings are detailed in the following sections.

The Setup Acquisition Panel is a software interface for configuring camera settings. It is organized into several sections:

- Acquisition Mode:** Kinetic Series (dropdown)
- Exposure Time:** 0.010099 (text input)
- Frame Rate:** 49.48694 (text input)
- Trigger Mode:** External (dropdown)
- Kinetic Series Length:** 40 (text input)
- Number of Accumulations:** 1 (text input)

Below these are three tabs: **Readout**, **Binning / ROI**, and **Data Spooling**. The **Readout** tab is active, showing:

- Gating:** Gate Mode: DDG (dropdown)
- MCP Gain:** A slider set to 0.
- Insertion Delay:** Fast (dropdown), with an  for **Intelligate (MCP gating)**.

The **DDG** section includes a table for configuring delay and width for different outputs:

	Delay	Unit	Width	Unit	Polarity	Step
<input checked="" type="checkbox"/> Gater	0	us	0	ns		<input type="checkbox"/>
<input type="checkbox"/> Output A	0		2		pos	<input type="checkbox"/>
<input type="checkbox"/> Output B	0		2		pos	<input type="checkbox"/>
<input type="checkbox"/> Output C	0		2		pos	<input type="checkbox"/>

Below the table are options for **Optical Gate Width** (unchecked), **DDG Step** (Delay: Off, Width: Off), and **Integrate On Chip** (unchecked). An **Upload** button is located at the bottom right of the DDG section.

## 4.7 ACQUISITION MODES

The following acquisition modes can be supported:

- Single Scan
- Kinetic Series
- Accumulate
- Run Till Abort

### NOTES:

1. The term 'User Frame', in this section refers to a reference/image frame pair.
2. The term 'valid trigger' refers to a trigger that is applied when the camera is ready to accept it.

The screenshot shows a software interface for configuring acquisition modes. It features several controls:

- Acquisition Mode:** A dropdown menu currently set to 'Single Scan'. A list is open showing options: 'Single Scan', 'Kinetic Series', and 'Accumulate'.
- Exposure Time:** A text input field.
- Frame Rate:** A text input field.
- Trigger Mode:** A dropdown menu currently set to 'External'.
- Kinetic Series Length:** A text input field containing the value '1'.
- Number of Accumulations:** A text input field containing the value '1'.

### 4.7.1 SINGLE SCAN

**Single Scan** refers to an acquisition in which only one user frame is transmitted from the camera.

A user frame is output from the sensor on receipt of a valid trigger of the selected type and then transmitted from the camera. Note that any subsequent triggers within the same acquisition are ignored.

### 4.7.2 KINETIC SERIES

**Kinetic Series** refers to an acquisition in which a finite number of user frames are transmitted from the camera. The number of frames in a Kinetic Series is defined by the user. One user frame is output from the sensor on receipt of each valid trigger of the selected type. Valid triggers continue to output user frames from the sensor until the defined number of user frames has been reached. Note that after the required number of valid triggers has been received, any subsequent triggers within the same acquisition are ignored.

### 4.7.3 ACCUMULATE

**Accumulate** refers to an acquisition in which a number of frames in a series are accumulated together into a single image. This accumulation of user frames is performed off-camera. Either all the user frames in a series are accumulated to give a single accumulated image or a smaller number of user frames in the series are accumulated to give a series of accumulated images.

## 4.7.4 RUN TILL ABORT ACQUISITION

**Run Till Abort** refers to an acquisition in which an infinite number of user frames can be transmitted from the camera and the acquisition will continue to run until it is aborted.

One user frame will be output from the sensor on receipt of each valid trigger of the selected type. All valid triggers will output another user frame from the sensor. Frames are transmitted from the camera in as quick succession as possible.

### 4.7.4.1 LIVE MODE

**Live Mode** refers to a version of **Run Till Abort** in which each user frame will be the latest frame output by the sensor and will have the minimum amount of latency through the camera as possible.

Live mode requires the use of SW Trigger. In order to ensure that frames are buffered in the on-camera memory for the shortest possible time, the next SW trigger must not be sent until the user frame has been transmitted from the camera. This ensures that the on-camera memory only stores a single user frame at a time and no additional latency builds up.

**NOTE: The frame rate achievable in Live Mode is dependent on the performance of the system that the camera is attached to.**

## 4.7.5 FAST EXPOSURE SWITCH

During an acquisition the user can change the exposure time, within allowable limits. Once a new exposure value has been written, it will be applied to the next user frame after the current frame exposure has completed. The exposure time can be changed any number of times before the acquisition finishes

## 4.7.6 FRAME RATE CONTROL

If Internal Trigger is being used, the camera will trigger the sensor at the fastest possible rate by default. The user can reduce this trigger rate by defining a Frame Rate that is less than the maximum possible rate. Frame Rate must be set before the acquisition starts.

**Note: This is currently only applicable to 'long exposures'.**

## 4.8 READOUT MODES

The signal captured by a 2D sensor can be read in several different ways, adapted to specific experimental configurations.

A typical set-up for the iStar sCMOS is as shown below:

**Pixel Readout Rate:** 560Mhz - fastest readout

**Sensitivity / Dynamic Range:** 16-bit (low noise & high well capacity)

Gating	Orientation	Dataflow Monitor
Readout	Binning / ROI	Data Spooling
Pixel Readout Rate	560 MHz - fastest readout ▼	
Electronic Shuttering Mode	Global ▼	
Sensitivity/Dynamic Range	16-bit (low noise & high well capacity) ▼	
Overlap Readout	<input type="checkbox"/>	

## 4.8.1 BINNING/ROI

**Binning** is the procedure of combining the signal from a number of adjacent pixels into an output for a single pixel (super-pixel). For 2x2 binning, an array of 4 pixels becomes a single larger pixel, reducing the overall number of pixels that need to be readout and also reducing the resolution available.

Gating	Orientation	Dataflow Monitor
Readout	Binning / ROI	Data Spooling
Pixel Binning	1x1	
Image Area	Full Image	
Auto Vertical Centring	<input type="checkbox"/>	
Height	2160	
Vertical Bin	1	
Bottom	1	
Width	2560	
Horizontal Bin	1	
Left	1	
Fill Display Window	<input type="checkbox"/>	

By combining the charge from 4 pixels into one super-pixel, the number of read events is reduced, therefore resulting in a lower read noise. Consequently, it is possible to use binning to increase the signal to noise ratio at the expense of lower resolution. The binning process for sCMOS differs to that of CCD due to the technical differences between the two sensor technologies.

For more information on binning with sCMOS sensors, please refer to the Technical Note "[Binning in the Neo and Zyla sCMOS cameras](#)".

## 4.8.2 ORIENTATION

The orientation tab provides options to rotate or flip the image:

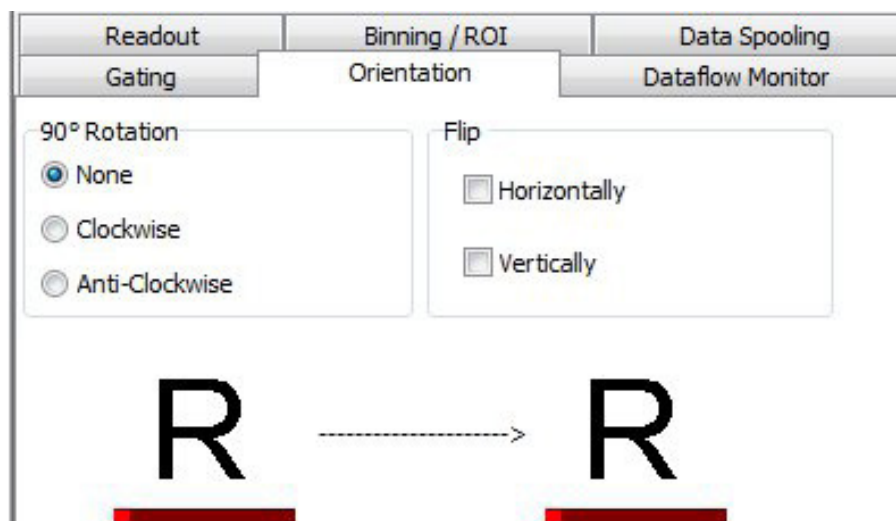

## 4.8.3 ACQUISITION AND DATA TYPES SELECTION

Some acquisitions, such as quantitative measurements or absorption / transmission / reflection require a degree of data processing which can be executed and displayed seamlessly in Solis.

### 4.8.3.1 DEFINITIONS OF DATA TYPES

Data processing and display involves the following baseline information:

- **Signal:** Uncorrected raw data acquired via **Take Signal**. 'Signal', as used in the definitions of the calculations, refers to 'raw' data from the detector and should not be confused with the possibly 'processed' data to be found under the **Sig** tab of the **Data** window.
- **Background:** Data in uncorrected counts, acquired in darkness
- **Reference:** Background corrected data. Reference data is normally acquired from the light source, without the light having been reflected from or having passed through the material being studied



### 4.8.3.2 DATA DISPLAY AND PROCESSING MODES

The data processing and display formats can be selected from the **Acquisition** drop down menu under **Setup Data Type**, e.g.:

OPTION	FUNCTION
Counts (per second)	Counts ÷ Exposure Time.
Count (Bg corrected per second)	Counts (Bg corrected) ÷ Exposure Time.
%Absorbance	Represents the light absorbed by an object. If Reference is the background corrected incident intensity, and Signal - Background the transmitted intensity (i.e. the intensity of light which has passed through the material being examined), then: % Absorbance = $100 \times (1 - (\text{Signal} - \text{Background}) / \text{Reference})$
%Reflectance	Represents the light reflected by an object. If Reference is the background corrected incident intensity, and Signal - Background the reflected intensity (i.e. the intensity of light which has been reflected from the material being examined), then: % Reflectance = $100 \times (\text{Signal} - \text{Background}) / \text{Reference}$
%Transmittance	Represents the light transmitted by an object. If Reference is the background corrected incident intensity, and Signal - Background the transmitted intensity (i.e. the intensity of light which has been transmitted through the material being examined), then: % Transmittance = $100 \times (\text{Signal} - \text{Background}) / \text{Reference}$
Flatfield	Flatfield is used to remove any pixel-to-pixel variations that are inherent in the ICCD sensor. If Reference is the background corrected incident intensity, the Signal is divided by the Reference so: Flatfield = $M \times \text{Signal} / \text{Reference}$ Where M is the Mean of Reference.
Absorbance units	A measure of light absorbed by an object (i.e. they represent the object's Optical Density - OD). If Reference is the background corrected incident intensity, and Signal - Background the transmitted intensity (i.e. the intensity of light which has passed through the material being examined), then Transmission = $(\text{Signal} - \text{Background}) / \text{Reference}$ . Absorbance Units are defined as $\text{Log}_{10}(1 / \text{Transmission})$ . Therefore: Absorbance Units = $\text{Log}_{10}(\text{Reference} / (\text{Signal} - \text{Background}))$ .
Absorption Coefficient (/m)	Indicates the internal absorbance of a material per unit distance (m). It is calculated as $-\text{loge } t$ , where t is the unit transmission of the material and loge is the natural logarithm. If Reference is the background corrected incident intensity, and Signal - Background the transmitted intensity (i.e. the intensity of light which has passed through the material being examined), then: Transmission = $(\text{Signal} - \text{Background}) / \text{Reference}$ and: Absorption Coefficient = $-\text{loge}((\text{Signal} - \text{Background}) / \text{Reference})$
Attenuation	A measurement, in decibels, of light absorbed due to transmission through a material - decibels are often used to indicate light loss in fiber optic cables, for instance. If Reference is the background corrected incident intensity, and Signal - Background the transmitted intensity (i.e. the intensity of light which has passed through the material being examined), then: Attenuation = $10 \times \text{log}_{10}((\text{Signal} - \text{Background}) / \text{Reference})$
Data*Ref	Allows you to 'custom modify' the background corrected signal: Data x Ref = $(\text{Signal} - \text{Background}) \times \text{Reference Store Value}$ See the Andor Basic Programming Manual for similar operations.
Log 10	Calculates the logarithm to the base 10 of the background corrected signal counts. Log Base 10 = $\text{log}_{10}(\text{Signal} - \text{Background})$
Radiometry (Optional extra)	Allows you to calculate values for radiance or irradiance. The system requires that you supply calibration details. This option must be ordered separately. <sup>o</sup>

The illustration below shows a typical use of Background, Reference and Signal for computations such as %Absorbance or %Transmittance:

For example, the % Absorption will be computed as:



$$100 \times (1 - (\text{Signal} - \text{Background}) / \text{Reference})$$

The default data type (used when capturing data and having not explicitly made a selection from the **Data Type** dialog box) is **counts**.

If any data type other than counts or counts (Bg Corrected) are selected, user will have to perform **Take Background** and **Take Reference** (in that order) before performing **Take Signal**.

#### 4.8.4 AUTOSCALE ACQUISITION

Prior to the **Take Signal** function being activated, autoscale acquisition can be selected from the **Acquisition** drop-down menu as shown below (or F6 on the keyboard):

- With autoscale acquisition deselected, the display will remain the same size regardless of brightness settings, etc. When not selected, the  button appears.
- With autoscale acquisition selected, the system will configure the acquisition window (if necessary adjusting its scales in real time) so that all data values are displayed as they are acquired. The  button appears when selected on. The data are displayed in accordance with the selection made on the **Rescale Data Mode** on the **Display Menu**:

Different scaling modes are available as follows:

- Minimum & maximum (**Min..Max**)
- Zero & maximum (**0..Max**)
- Zero & 16383 (**0..16383**)
- Minimum & 16383 (**Min..16383**)
- Zero & 65535 (**0..65535**)
- Minimum & 65535 (**Min..65535**)
- Custom setting as required - user selectable min and max display range

**Note:** The histogram icon  can be used to adjust conveniently and in real time signal display scaling.

## 4.8.5 DATA FILE HANDLING

### 4.8.5.1 SPOOLING (DATA SPOOLING)

Andor Solis software has an extensive range of options that allows user to spool acquisition data direct to the hard disk of your PC. This is particularly useful when acquiring a series of many images. The amount of data generated by a kinetic series of, for example 1,000 acquisitions, is huge and more than most PC RAM can handle.

To select click on the **Data Spooling tab** and the **Spooling** dialog box appears.

With the spooling function enabled, data is written directly to the hard disk of you PC, as it is being acquired. The **Enable Spooling** function should be selected as shown below, and user should enter the relevant stem name and location root.

**Note: Andor recommends only very high-speed hard disk drives be used for this type of operation and these need to be dedicated for spooling.**

### 4.8.5.2 VIRTUAL MEMORY

In addition to the spooling function, it can also be useful to have the Virtual Memory (VM) function enabled. This will speed up the retrieval of large data sets and allow larger data sets to be acquired. This works by buffering data in the hard drive of the PC. The **Virtual Memory...** option is selected from the **File** menu.

This will open the **Virtual Memory** dialog box.

User should select the **Enable** box and the required **Threshold** level. The data is normally saved to the default directory shown in the **Location** field. Alternatively, user can click on the  button and choose a different area to save the data.

**Note: It is recommended to have the option activated for images > 50 MB.**

### 4.8.5.3 AUTO-SAVE

**Auto-Save** allows user to set parameters and controls for the auto saving of acquisition files thus removing the worry of lost data and files. Selection of this mode is accessible under the **Auto-Save** tab on the **Setup Acquisition** dialog box. The **Auto-Save** dialog box appears.

If selected, acquisitions will be saved automatically after each individual one is completed. Each subsequent auto-saved file will over-write the previously auto-saved one.

In the Auto-Save dialog box, a **Stem Name** may be entered. This is the main root of the name that the acquisition is to be saved as.

The Stem Name can be appended with a number of details, e.g.:

- Operator name (supplied by user)
- Computer name
- Camera type
- Date
- Time

An auto-increment On/Off tick box allows a number to also be entered to the main stem name. This number is automatically incremented each time a file is saved.

Any combination of these may be selected by activating the relevant tick box.

**Note: This function will only auto-save single scan, kinetic series or accumulated images.**

### 4.8.6 DATAFLOW MONITOR

Use the **Dataflow Monitor** to keep track of system resource usage. Further information on PC and dataflow considerations for sCMOS based cameras is available in the Technical Article "[PC Recommendations](#)".

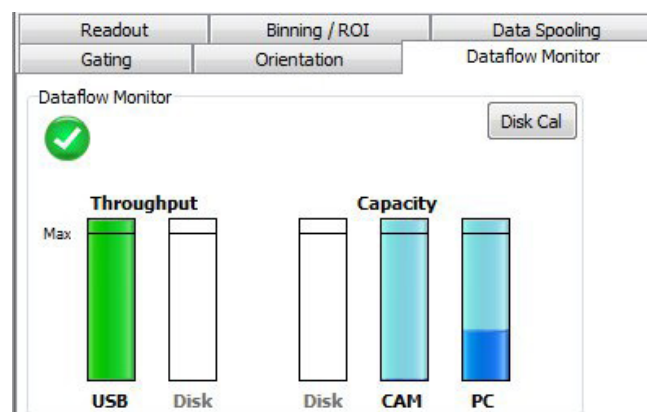

## 4.9 GATING AND IMAGE INTENSIFIER SETTINGS (GATING)

This section details the different image intensifier modes of operation relative to 'gating' and signal amplification that are found under the Gating tab.

### 4.9.1 GATE MODES

In the Acquisition Setup interface, under the Gating tab, a drop-down menu allows the user to select the gate mode:

The screenshot shows the 'Gating' tab in the Acquisition Setup interface. The 'Gate Mode' is set to 'DDG'. Below this, there is a slider for 'MCP Gain' set to 0. The 'Insertion Delay' is set to 'Fast', and the 'Intelligate (MCP gating)' checkbox is unchecked. The 'DDG' section contains a table of settings:

	Delay	Unit	Width	Unit	Polarity	Step
<input checked="" type="checkbox"/> Gater	0	us	0	ns		<input type="checkbox"/>
<input type="checkbox"/> Output A	0		2		pos	<input type="checkbox"/>
<input type="checkbox"/> Output B	0		2		pos	<input type="checkbox"/>
<input type="checkbox"/> Output C	0		2		pos	<input type="checkbox"/>

Below the table, there are checkboxes for 'Optical Gate Width' and 'Integrate On Chip'. The 'DDG Step' section has 'Delay' and 'Width' both set to 'Off'. An 'Upload' button is located at the bottom right of the DDG Step section.

Valid options are:

GATE MODE	DESCRIPTION
<i>CW On</i>	<i>The photocathode is continuously in the ON state</i>
<i>CW Off</i>	<i>The photocathode is continuously in the OFF state.</i>
<i>Fire only</i>	<i>Photocathode is switched on only when the Fire pulse is high.</i>
<i>Gate only</i>	<i>Photocathode is switched on only when the Direct Gate input is high.</i>
<i>Fire and Gate</i>	<i>Photocathode is switched on only when both the Fire &amp; Direct Gate input are high.</i>
<i>DDG</i>	<i>The photocathode is switched on only when the Gate pulse from the DDG is high.</i>

**Note:** For direct gate input, the maximum safe levels are -0.5 to +5.75 V. The input impedance is 50  $\Omega$  termination to ground. The minimum high logic level is 1.7 V and maximum low logic level is 0.8 V.

## 4.9.2 USING THE GATE MONITOR

The gate monitor connection, on the side of the main block of the iStar sCMOS enables the temporal position of the photocathode switching On (negative spike) and Off (positive spike) to be monitored. A cable is supplied with the iStar sCMOS, which has a BNC connector on one end for attaching to an oscilloscope.

When Intelligate is selected an additional gate monitor spike precedes the spike from the photocathode. This spike corresponds to the MCP switching on.

The oscilloscope should be set to trigger on the steepest part of Output A, this is typically  $\frac{1}{2}$  of the peak amplitude. The Fire pulse may also be used, but its jitter performance with respect to the gate pulse will not be as good.

The following plots show the preferred oscilloscope settings for working with short and long gate widths.

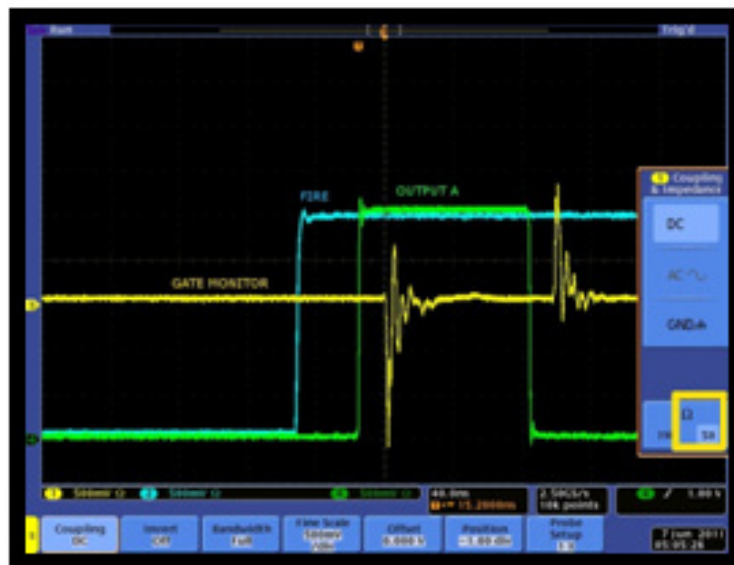

### Short Gate Widths (<1 us)

For example: 100 ns gate width:

Set input impedance on oscilloscope to 50  $\Omega$ .

Set Voltage amplitude to 500 mV

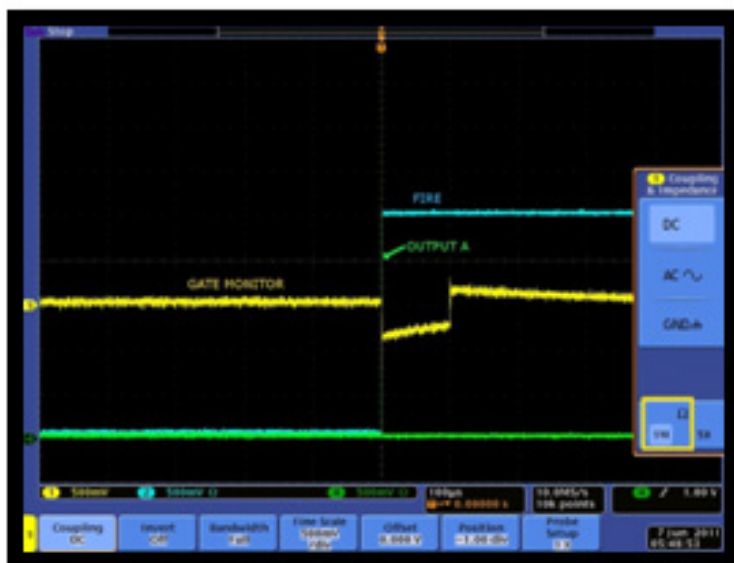

**Long Gate Widths (>1 us)**

For example: 100 us gate width:

Set input impedance on oscilloscope to **1 MΩ**.

Set Voltage amplitude to 500 mV

**4.9.3 MCP GAIN**

The gain of the Micro-Channel Plate (MCP) in the image intensifier can be varied through software from a setting of 0 to 4,095. By increasing the gain, the voltage across the MCP is increased and hence the signal reaching the sensor is amplified. The value can be entered in the MCP Gain text box of the 'Gating' tab of the Acquisition Setup interface. It can also be controlled by the slider.

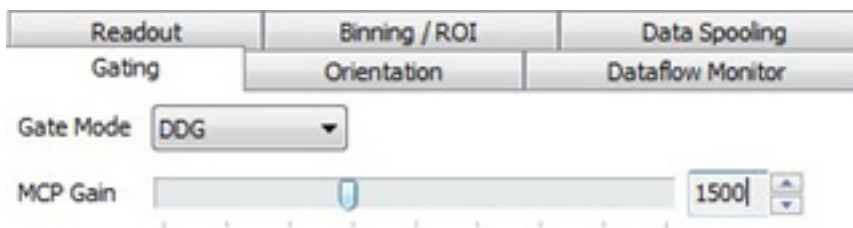



#### 4.9.4 INSERTION DELAY

Insertion delay refers to the propagation delay of a trigger source (External Trigger, Internal Trigger (Fire pulse) or Direct Gate) to travel through the electronics and open the image intensifier. A radio button allows the user to select between 'Normal' and 'Ultra Fast' options. Switching from 'Ultra Fast' to 'Normal' adds 100 ns delay to the gate pulse. This allows the MCP voltage to rise and settle when using Intelligate before opening the photocathode. Intelligate is not available when using 'Ultra Fast' insertion delay.

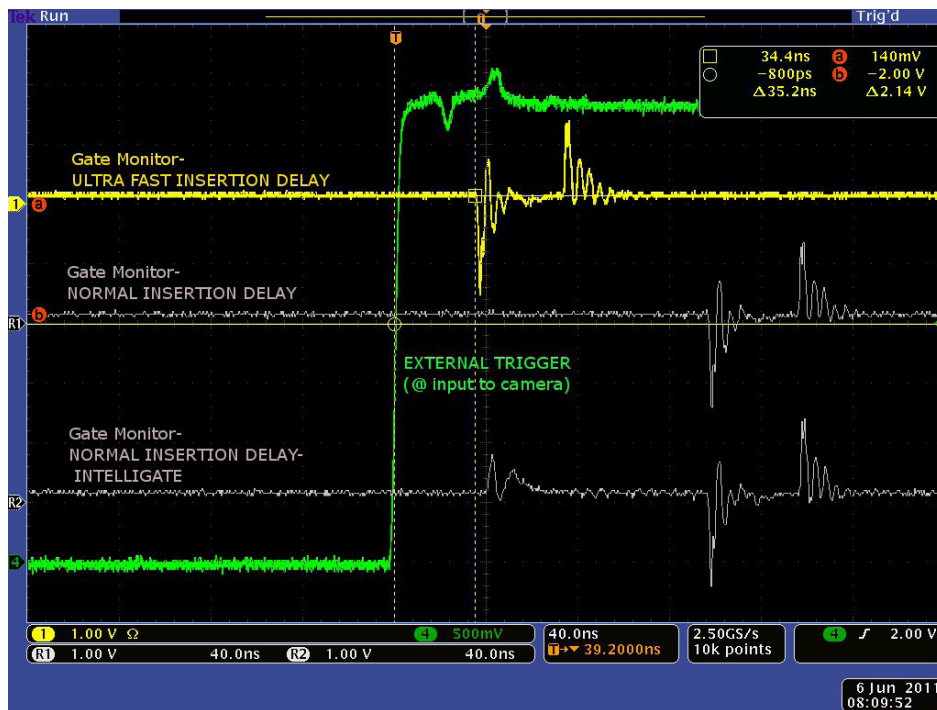

External Trigger to intensifier opening using DDG

Ultra Fast  $\approx$  35 ns

Normal  $\approx$  135 ns



Fire pulse to intensifier opening using DDG

Ultra Fast  $\approx 50$  ns

Normal  $\approx 150$  ns

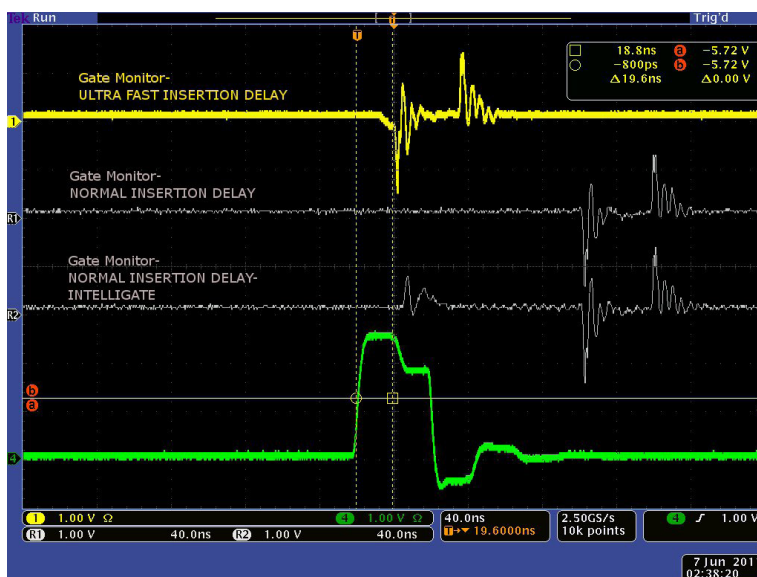

Direct Gate to intensifier opening

Ultra Fast  $\approx 20$  ns

Normal  $\approx 120$  ns

#### 4.9.5 INTELLIGATE

With traditional Image Intensifier gating the photocathode of the tube is switched on and off. But even when the photocathode is switched off, some photons can still pass through it and reach the Microchannel Plate (MCP). UV photons can be energetic enough to be converted into photoelectrons that are amplified by the MCP in the normal way, and are then detected by the sensor. The ability of the Image Intensifier to reject photons when it is switched off becomes worse in the UV, so the On/Off ratio of the tube is compromised. The solution to this, as utilized by Andor's Intelligate™ function, is to gate the MCP as well as the photocathode.

A checkbox is accessible under the 'Gating' tab of the Acquisition Setup interface allows the user to apply the Intelligate function.

The gating electronics will output a fast rising edge that is sent to the MCP. After a 100 ns delay, which allows the MCP voltage to rise and settle, the photocathode will open. The MCP will remain at the gain value (as set by the user in the software) for the duration of the gate width, and then the MCP will decay rapidly. This method of gating eliminates the need for a pre-pulse or anticipator circuit and results in photoelectron rejection of better than  $10^7:1$ , below 200 nm.

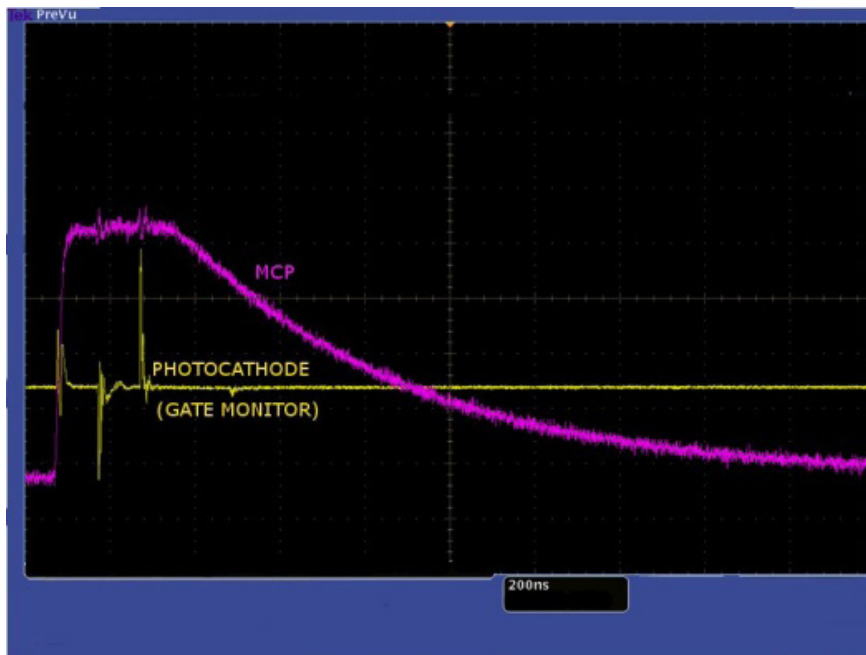

MCP Gating in practice

### 4.9.6 INTEGRATE ON CHIP (IOC)

IOC is a function that enables the image intensifier to be opened and closed a number of times while the sensor makes a single acquisition. Light signal passes through the intensifier while it is open (or switched on) and reaches the sensor. The sensor accepts the light continuously for the entire duration of the acquisition while the intensifier is opening and closing. Charges are built up on the sensor or 'integrated' until the acquisition is complete. Then all the charges that have been built up are read out in the normal way.

IOC greatly improves the signal-to-noise ratio achievable, since the signal is being integrated on the sensor itself while being read out once. Hence noise will only be generated from a single readout. The signal-to-noise ratio achieved while operating the iStar's sCMOS IOC function is better than that obtained while operating the system in accumulate acquisition Mode. This is because during accumulate mode, the sensor is read out a number of times and accumulated in the computers memory. So the signal-to-noise ratio in this case will include noise generated from each read out that occurs.

This mode also minimizes the dark current contribution by filling up the exposure time with multiple useful signal contributions, further enhancing the overall signal-to-noise performance.

A checkbox, accessible on the 'Gating' tab of the Acquisition Setup interface, allows the user to apply the Integrate On Chip function and is only available in DDG gate mode.

Integrate On Chip

Number of Pulses   Fit To Exposure

Period

Frequency

IOC allows several gate pulses, as well as outputs A/B/C synchronization signals, to be generated within the exposure. When outputs A, B, or C are enabled, the first set of pulses is determined by the delay and width of these outputs as set by the user. The delay applies from the rising edge of the Fire pulse for internal trigger or rising/falling edge (user selected) for external trigger. This delay is in addition to the inherent insertion delay.

Once the first set of pulses is finished, subsequent sets are spaced out by the period/frequency pre-set in the IOC section. Since subsequent sets cannot start before the first set is finished, the software automatically adjusts the period/frequency according to the time from the start of the first pulse to the end of the last pulse. The start of the first pulse could be the delay value in gater or output A/B/C, and the end of the last pulse could be the delay plus width of gater or output A/B/C.

Please refer to the following page for detailed setting of these modes under different trigger conditions.

## INTERNAL TRIGGER

IOC OPTIONS	DESCRIPTION
Fit to Exposure	Software calculates the maximum number of pulses that can fit into the exposure. The Fire pulse generates the first pulse determined by the delay and width fields, subsequent pulses are generated internally in the DDG by a user defined period/ frequency.
Number of Pulses	Same as "Fit to Exposure" but the user can chose the number of gate pulses per exposure.

**Note:** A default minimum of 20 ns delay applies when Integrate on Chip is selected and when the DDG generates the pulse train internally by a user-defined frequency or period. This is a characteristic of the DDG and it is related to its ability to set the period between pulses in 20 ns intervals. This delay is in addition to the inherent insertion delay.

## EXTERNAL TRIGGER

IOC OPTIONS	DESCRIPTION
Number of Pulses = 1	Every external trigger within the exposure will generate only one gate pulse.

### 4.9.7 DIGITAL DELAY GENERATOR (DDG) STEP (INCLUDING GATE STEP)

The DDG Step feature is available for use with the kinetic series acquisition mode. A check box under the heading “Step” is used to determine which signals (Gater and/or Output A/B/C) use the DDG step feature.

DDG		Delay <span>ps</span>	Width <span>ns</span>	Polarity	Step
<input checked="" type="checkbox"/>	Gater	10000	1.9		<input checked="" type="checkbox"/>
<input checked="" type="checkbox"/>	Output A	5000	2	pos	<input type="checkbox"/>
<input type="checkbox"/>	Output B	0	2	pos	<input type="checkbox"/>
<input type="checkbox"/>	Output C	0	2	pos	<input type="checkbox"/>

The first exposure in a kinetic series will use the delay/width specified for the Gater and/or Output A/B/C. For every successive exposure in the series, the delay/width applied is adjusted by the DDG step value determined by the corresponding DDG step mode selected. If the Gater DDG step delay is enabled this will cause the image intensifier to be ‘gated on’ progressively later (or earlier, if a negative DDG Step is configured) for each acquisition in the series.

#### 4.9.7.1 STEP MODE CONFIGURATION

Three step modes can be independently applied to the delay/width values.

DDG Step

Delay Off

Width Constant

Exponential

Logarithmic

Based on the step mode selected one or two coefficients can be used to configure the mode.

DDG Step

Delay Constant 500 ps

Width Exponential 100 exp ( 0.694 x )

The user can enter a time which is added (or subtracted) incrementally to the delay/width during a series of acquisitions.

If, for example, the user sets up a Kinetic Series to acquire five scans with an initial gate delay of 1000 ps and width of 2000 ps and with DDG step enabled for the Gater and configured as shown above, then:

The **gate delay** will be stepped by a constant 500 ps i.e. the first frame will have a step value of 0 and frames two to five will have a step value of  $(\text{frame number} - 1) \times 500$  ps, therefore the gate delay values for each frame will be:

Frame Number	Step Value (ps)	Gate Delay (ps)
1	0	1000
2	500	1500
3	1000	2000
4	1500	2500
5	2000	3000

The **gate width** will be stepped exponentially i.e. the first frame will have a step value of 0 and frames two to five will have a step value of  $100 \times \exp(0.694 \times (\text{frame number} - 1))$  ps, therefore the gate width values for each frame will be:

Frame Number	Step Value (ps)	Gate Width (ps)
1	0	2000
2	200	2200
3	400	2400
4	800	2800
5	1600	3600

#### 4.9.7.2 STEP UPLOAD

The stepped delay/width values for each frame of the kinetic series have to be uploaded to the camera before an acquisition can be performed. This is done automatically when the start acquisition is pressed. However, this can be a slow process therefore a DDG step upload button is provided to allow these values to be uploaded prior to starting an acquisition. If any changes are made to the DDG configuration, after they have been uploaded, that affect the stepped values, then they will need to be uploaded again. This will be indicated by the “Upload” button becoming enabled.

**Note: In fluorescence lifetime measurements, gate delay and gate step parameters can be set to allow a series of decay curves to be built up automatically.**

**Note: The Andor Basic command ‘KineticSlice’ allows the extraction of pixel/column signal intensity throughout a kinetic series, and plots this intensity versus time in a separate display window.**



## 4.10 TRIGGERING MODES

The triggering modes are selected from a drop-down list on the **Setup Acquisition** dialog box.

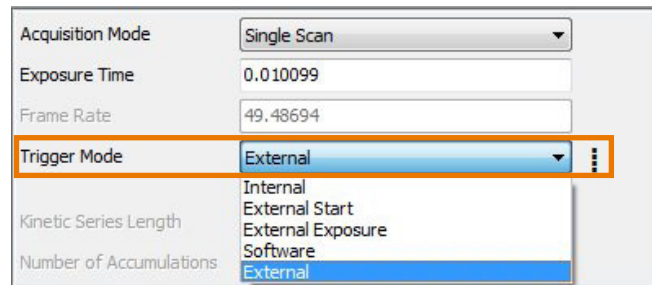

### 4.10.1 INTERNAL TRIGGER

Camera acts as a timing master for any external device, and also triggers both the sensor and the intensifier. The camera determines the exact time when an exposure happens, based on the acquisition settings entered by the user.

To control an external device in time (e.g. a laser) output A, B or C from the DDG should be used.

### 4.10.2 EXTERNAL TRIGGER

Camera waits for a trigger from an external device to perform the acquisition sequence, hence acting as a timing slave; both sensor and intensifiers are triggered simultaneously. The exact nature of the acquisition will depend on the user settings and is explained in more detail in a subsequent section. The external trigger is fed via the Ext Trig input on the camera head.

The maximum safe input levels are -0.3 to +5.0 V. The user can configure the following settings under the **Trigger** settings tab:

**Termination:** The input impedance can be change between High Impedance and 50  $\Omega$ .

**Rising or Falling Edge Triggered:** The system can be set to respond to rising edge or falling edge triggers.

**Threshold Level:** The trigger threshold can be programmed from +0.25 to +3.3 V.

When using external trigger the user may find it useful to monitor the Arm output at back of the detector head. When the Arm is high the system will accept external triggers.

For lowest jitter, the user may need to adjust the input impedance and/or trigger threshold to set the trigger level to the steepest part the input edge, typically 1/3 to 1/2 of the peak amplitude.

**Note: The sCMOS sensor takes about 300ns from getting a trigger to be fully open.**

So when operating in External Trigger mode the intensifier will open before the sCMOS is fully open. Depending on the insertion delay setting, the intensifier will open 35ns or 135ns after external trigger input. This same external trigger input will trigger the sCMOS sensor, which will be fully ready after 300ns. So the user will need to increase the delay of the gate pulse by a few hundred nanoseconds via the DDG to make sure the intensifier opens after the sCMOS.

Alternatively, if the user wants a short delay between the External Trigger and Gate pulse, then the Pre-Trigger could be use to trigger the sCMOS sensor before the External Trigger.

### 4.10.3 EXTERNAL START

**External Start** is a mixture of External and Internal Trigger. In this mode the camera will wait for one external trigger event to occur. Once this external trigger event has occurred the camera will switch to internal trigger and the acquisition will progress as if the camera was in internal trigger mode.

### 4.10.4 SOFTWARE TRIGGER

**Software Trigger** works in the a similar manner to External Trigger mode whereby the camera and software are in a high state of readiness and can react extremely quickly to a trigger event issued via software. This mode is particularly useful when the user needs to control other equipment between each exposure and does not know in advance how long such control will take or if the time taken changes randomly.

### 4.10.5 EXTERNAL EXPOSURE TRIGGER

**External Exposure Trigger** is a mode of operation where the exposure time and cycle time are controlled by the **Pre-Trigger input**. There are two options:

**Non-Overlap:** The width of the Pre-Trigger determines the exposure time.

**Overlap:** The period of the Pre-Trigger determines the exposure time.

## 4.11 SETTING UP PIV MODE ON ISTAR sCMOS

### 4.11.1 SOLIS SETTINGS FOR PIV MODE

Select the following settings in Solis:

1. Select **External Exposure** Trigger Mode, with **Overlap Enabled**.
2. Select **PIV Mode** from the submenu.

Acquisition Mode: Kinetic Series

Exposure Time: 0.000249

Frame Rate: 3865.418

Trigger Mode: External Exposure

Kinetic Series Length: 6

Number of Accumulations: 1

Readout | Binning / ROI | Data Spooling | Gating | Orientation

Pixel Readout Rate: 560 MHz - fastest readout

Electronic Shuttering Mode: Global

Sensitivity/Dynamic Range: 16-bit (low noise & high well capacity)

Overlap Readout:  (Min Exposure = Readout Time)

Spurious Noise Filter:

**External Exposure** submenu:

- PIV Mode**  
Particle image velocimetry (PIV) mode, facilitates flow visualisation in fluids by allowing two successive exposures to occur close together. Only available in External Exposure trigger mode with Overlap enabled.
- Pre-trigger**  
When pre-trigger is enabled, the exposure of the sensor is triggered from the pre-trigger input connector, independently of the DDG external trigger. This is required for External Exposure trigger mode.

3. Enter an *even* number for the Kinetic Series length.
4. Enter the required **Gate Width** from the 'Gating' tab e.g 100 ns.

Readout | Binning / ROI | Data Spooling | Gating | Orientation

Gate Mode: DDG

MCP Gain: 0

Insertion Delay: Fast  Intelligate (MCP gating)

DDG

Delay: ns Width: ns Polarity: Step

Gater: 0 100

Output A: 0 2 pos

Output B: 0 2 pos

Output C: 0 2 pos

Optical Gate Width

DDG Step

Delay: Off Width: Off

Upload

Integrate On Chip

### 4.11.2 SETTING UP THE EXTERNAL DELAY GENERATOR (DDG) FOR TWO INPUT SIGNALS

Set up an External Delay Generator to provide two input signals to the camera:

#### Pre-Trigger:

1. The period of this signal determines the sCMOS exposure time.
2. The Fire pulse output indicates the sCMOS exposure time.
3. For a given ROI, the minimum exposure time (maximum frame rate) is displayed in 'Acquisition Setup'.
4. This signal normally consists of a single pulse every period, but can also be a burst of two pulses every period. The second pulse is ignored and makes no difference.

#### External Trigger:

1. The rising edge of this signal triggers the DDG, which in turn triggers the Gater to produce the desired gate width.
2. The ARM pulse output indicates when the camera will accept external triggers.
3. This signal will consist of a burst of two pulses located near the inter-frame gap.

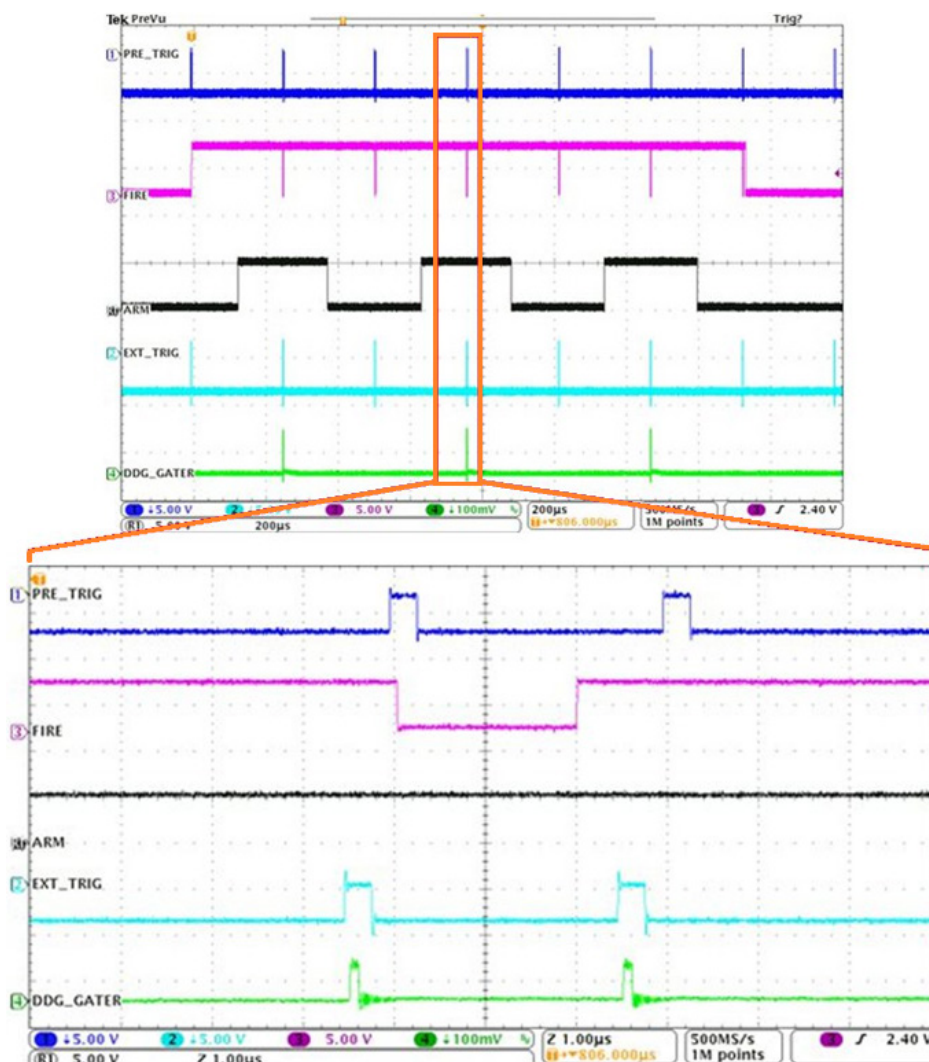

## SECTION 5: MAINTENANCE



THERE ARE NO USER-SERVICEABLE PARTS INSIDE THE CAMERA. DAMAGE CAUSED BY UNAUTHORISED MAINTENANCE OR PROCEDURES WILL INVALIDATE THE WARRANTY.

### 5.1 REGULAR CHECKS

- The state of the product should be checked regularly, especially the integrity of the External Power Supply and the mains cable.
- Do not use equipment that is damaged

### 5.2 ANNUAL ELECTRICAL SAFETY CHECKS

- It is advisable to check the integrity of the insulation and protective earth of the AC/DC converter on an annual basis, e.g. U.K. PAT testing
- Do not use equipment that is damaged

### 5.3 FUSE REPLACEMENT

In the U.K, Ireland and some other countries, the supplied mains cable has a BS 1363 (or Type G) plug that includes an integrated fuse. Only replace with fuse of the same type and rating for continued protection. The characteristics of a replacement fuse are as follows:

- **Rated Current:** 5 A
- **Rated Voltage:** 240 VAC
- **Size:** ¼ × 1" (6.3 × 25.4 mm) cartridge
- **Type:** BS 1362

### 5.4 COOLING HOSES AND CONNECTIONS

The user should routinely check all coolant hoses and connections for signs of leakage, damage or wear. All seals must be intact before powering on camera system and any worn / damaged items must be replaced immediately.

## SECTION 6: TROUBLESHOOTING

This section provides useful information and solutions for some troubleshooting scenarios. If you have an issue that you are unable to rectify using this section, please contact Andor Technical Support for further advice.

### 6.1 CAMERA BUZZER DOES NOT SOUND ON START-UP

1. The camera buzzer should be audible momentarily when the camera is switched on.
2. If this does not occur, ensure that power is connected to the camera and the On/Off switch is set to On

### 6.2 CAMERA IS NOT RECOGNIZED BY PC

1. Ensure the camera is switched on
2. Check the Camera to PC connection.

### 6.3 BUZZER SOUNDS CONTINUOUSLY

This indicates that an “over temperature” condition has occurred within the camera. Follow the instructions below to rectify this situation:

1. Power the camera off and allow it to cool down
2. For air-cooled models, ensure fan vents are not obstructed  
For water-cooled models, ensure that water coolant supply is connected and that chiller/re-circulator is operational
3. Check the camera is operating within the specified environmental conditions (see **Section 1.4**)

### 6.4 FAN NOT OPERATING AS EXPECTED

- To protect the internal electronics, the fan defaults to full speed if the camera heat-sink temperature exceeds 50°C.

**NOTE: The fan will continue to run even if the user has switched it off via software, until the correct heat-sink temperature has been reached.**

### 6.5 CAMERA DOES NOT COOL TO THE REQUIRED TEMPERATURE

1. Check that the operating ambient temperature is within allowable limits (see **Specifications**) when cooling the sensor.
2. Check that the camera vents are not blocked and have sufficient clearance to allow air flow.
3. Check that the fan is switched on (or for water cooled models, the coolant system is operating correctly).

## 6.6 PREVENTING CONDENSATION

**NEVER USE WATER THAT HAS BEEN CHILLED BELOW THE DEW POINT OF THE AMBIENT ENVIRONMENT TO COOL THE CAMERA.**

You may see condensation on the outside of the camera body if the cooling water is at too low a temperature or if the water flow is too high. The first signs of condensation will usually be visible around the connectors where the water tubes are attached. If this occurs carry out the following actions:

1. Switch off the system
2. Wipe the camera with a soft, dry cloth.

**NOTE: It is likely there will already be condensation on the cooling block and cooling fins inside the camera.**

3. Set the camera aside to dry for several hours before you attempt reuse.
4. Before reuse blow dry gas through the cooling slits on the side of the camera to remove any residual moisture.

Use warmer water or reduce the flow of water when you start using the device again.

**NOTE: This is not an issue when using a Re-circulator which eliminates the dew point problem.**

Refer to **Appendix B** for a Dew Point Graph.

# APPENDIX A: MECHANICAL DRAWINGS

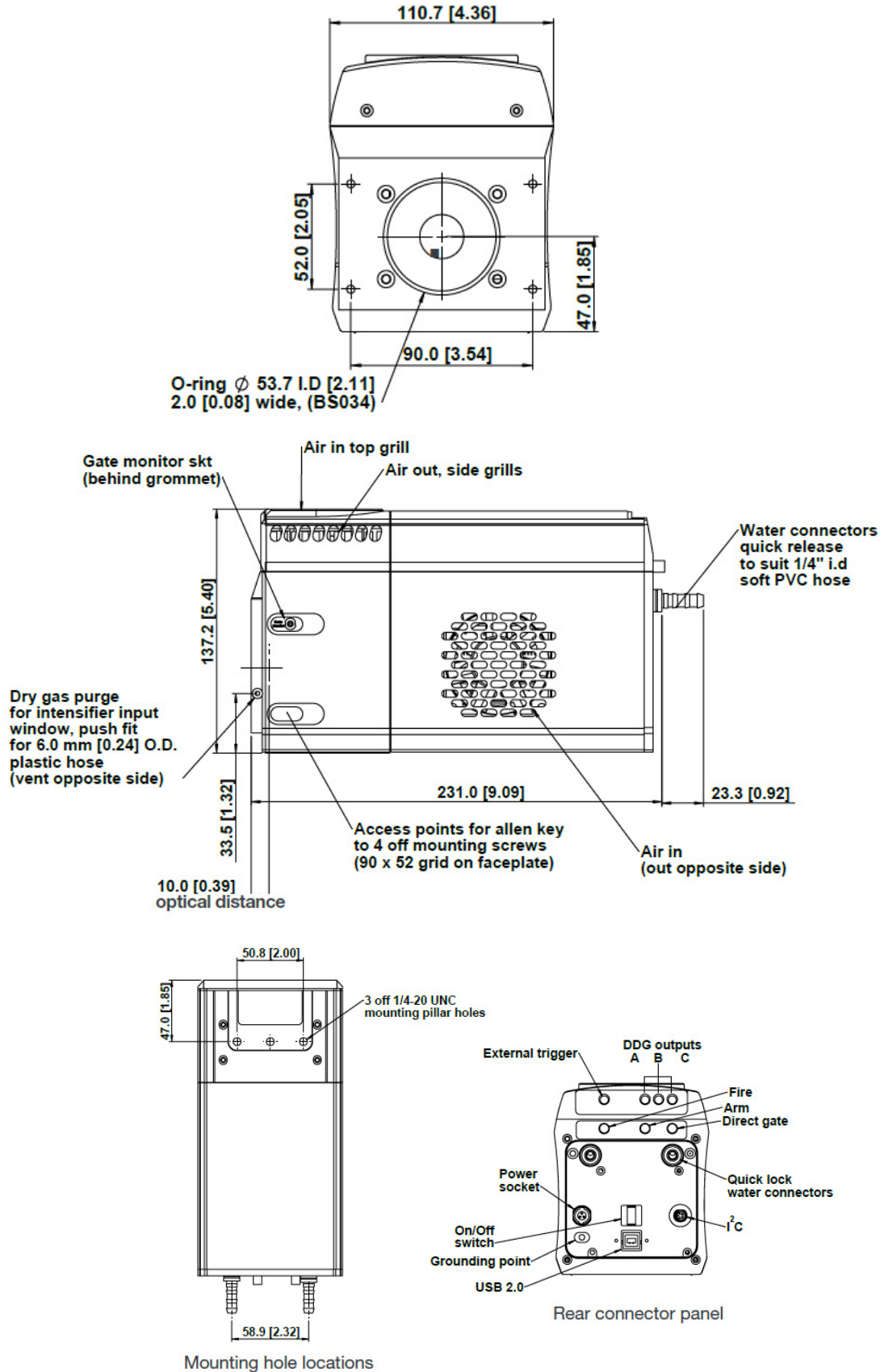



## APPENDIX B: DEW POINT GRAPH

To avoid issues with condensation the coolant temperature must be set above the dewpoint- the temperature at which condensation (dew) will form. In the relatively dry conditions of an air conditioned lab, or a cool dry climate, use of a coolant temperature of 10°C should not cause any problems. As relative humidity or ambient temperature increase however, the dewpoint temperature will also increase so that the minimum coolant temperature that can be used will have to increase accordingly. This will therefore limit the maximum cooling performance that can be achieved.

The first signs that condensation is forming will be on the coolant connections entering and exiting the camera. Use of coolant at or below the dewpoint can result in permanent damage to the camera head due to formation of condensation on internal components. It is therefore very important to ensure that coolant temperature is above the dewpoint. Further guidelines are provided in Section 8.8. The relationship between Relative Humidity and Dew Point at varying Ambient Temperature is shown below. There are also a range of dewpoint calculators on-line that you can enter ambient temperature and relative humidity to calculate the dewpoint for your conditions.

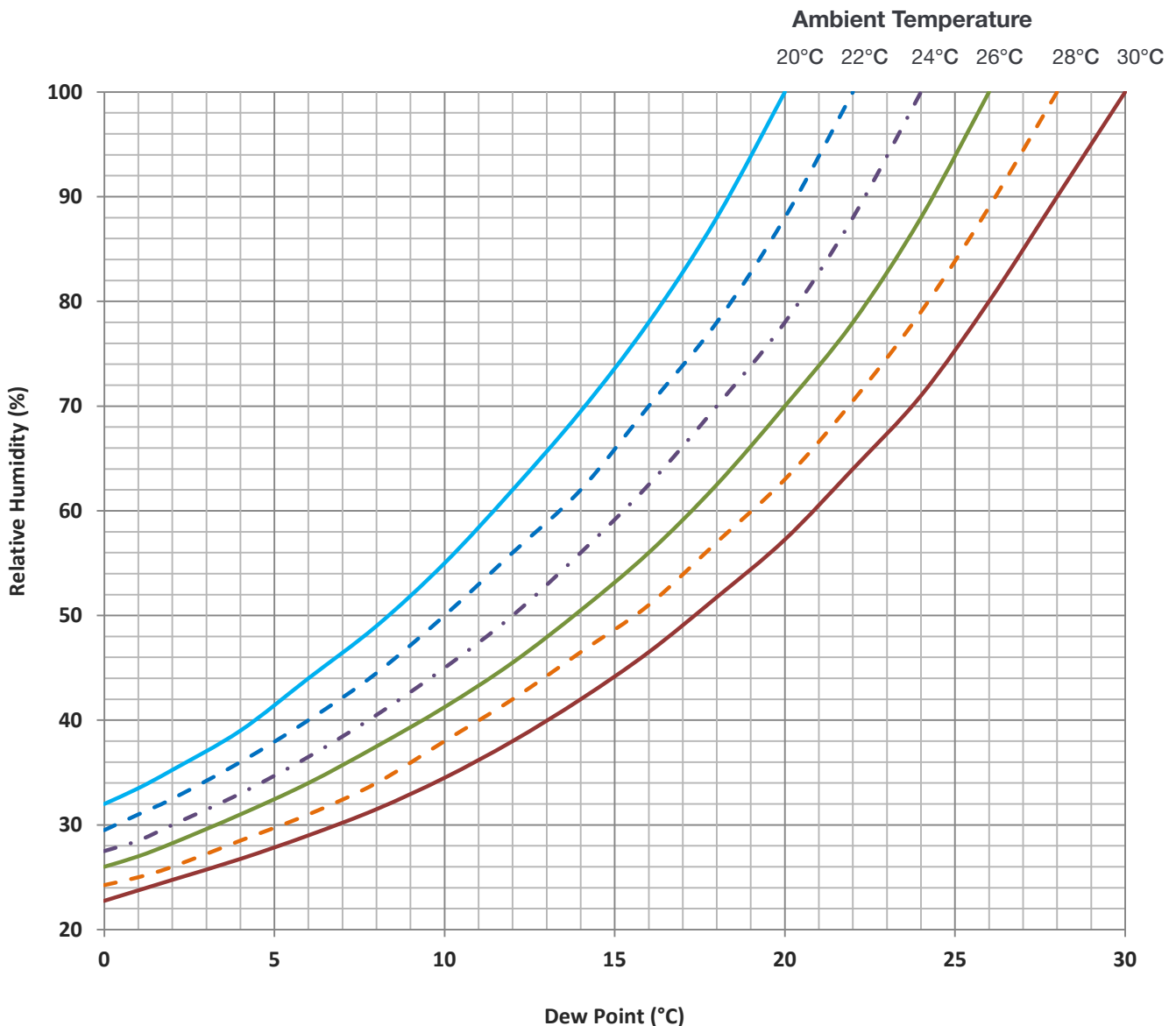

## APPENDIX C: INTENSIFIER INFORMATION

### Gen 2 Image Intensifier Information

Photocathode model	18*-03	18*-04	18*-05 †	18H-13	18H-83	18*-E3*1
<b>Useful aperture</b>	Ø18 mm (Ø25 mm options also available)					
<b>Input window</b>	Quartz	Quartz	MgF <sub>2</sub>	Quartz	Quartz	Quartz
<b>Photocathode type</b>	W-AGT	W-AGT	W-AGT	WR	UW	WE-AGT
<b>Minimum guaranteed peak QE @ room temperature *2</b>	18	18	15	13.5	25	22
<b>Wavelength range</b>	180 - 850 nm	180 - 850 nm	120 - 850 nm	180 - 920 nm	180 - 850 nm	180 - 850 nm
<b>Image intensifier resolution limit *3</b>	25 µm	30 µm	25 µm	25 µm	25 µm	25 µm
<b>Phosphor type [decay time to 10%]</b>	P43 [2 ms]	P46 [200 ns]	P43 [2 ms]	P43 [2 ms]	P43 [2 ms]	P43 [2 ms]
<b>Minimum optical gate width (ns) *4,5</b>						
<b>U (Ultrafast)</b>	< 2	< 2	< 5	-	-	< 2
<b>F (Fast)</b>	< 5	< 5	< 10	-	-	< 5
<b>H (High QE)</b>	-	-	-	< 50	< 100	-
<b>Maximum relative gain *6</b>	> 1000	> 500	> 1000	> 850	> 500	> 300
<b>Maximum photocathode repetition rate (with Intelligate™ OFF)</b>	500 kHz (continuous)					
<b>Maximum photocathode repetition rate (with Intelligate™ ON)</b>	5 kHz (continuous)					
<b>Equivalent Background Illuminance (EBI)</b>	< 0.2 photoe/pix/sec		< 0.4 photoe/pix/sec		< 0.2 photoe/pix/sec	

1. The On/Off ratio for the 'E3' image intensifier in the UV with MCP gating is typically 105.
2. Typical photocathode Quantum Efficiency and input window transmission as measured by the tube manufacturer.
3. Typical resolution of the image intensifier tube only, not the overall resolution of the system. As a rough guide, the smallest resolvable FWHM feature will be approximately 4x the sensor pixel size.
4. Gen 2 High QE (H) option – Photocathode QE is inherently linked to the gating speed of the intensifier. High QE option (H) offers higher peak QE than Ultrafast (U) or Fast (F) intensifiers, while exhibiting minimum gating speed one order of magnitude slower.
5. Actual measured minimum optical gating of the photocathode, reflecting not only the electrical pulse width applied to the photocathode but also its inherent rising time.
6. Gain is software-selectable through a 12-bit DAC and varies exponentially with DAC setting. Value refers to the ratio of max to min intensifier gain as measured for individual cameras. Actual optical gain (counts/ photoe-) for a DAC setting is accessed by the multiplication of the relative gain (at that DAC value) by the minimum system gain (at DAC = 0, sCMOS e-/photoe-) and divided by the sCMOS sensitivity (sCMOS e-/count). Sensitivities are individually measured and reported for each system. All photocathode types can be combined with a fast-decay P46 phosphor. \* Substitute with appropriate gate width option, e.g. 18F-03 † Available with VUV-compatible spectrograph interface.

### QE Data

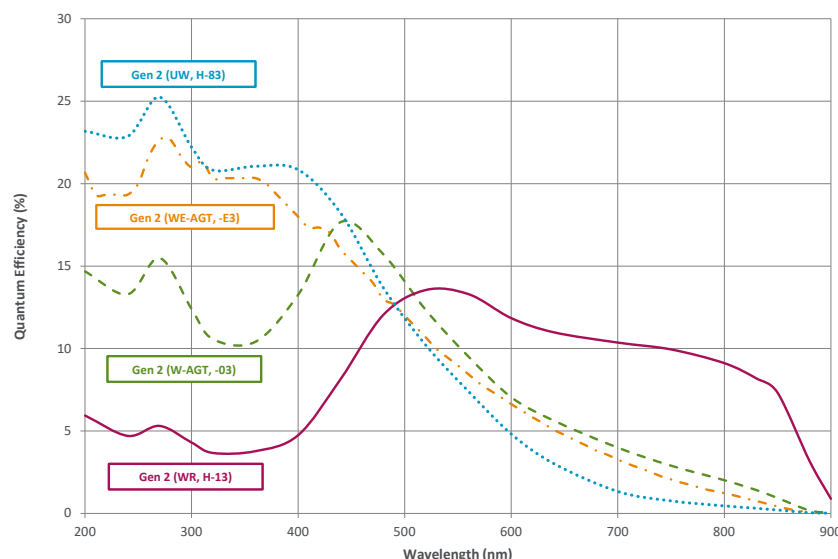

## Gen 3 Image Intensifier Information

Photocathode model	18*-63	18*-73	18*-93	18*-A3	18*-C3 <sup>*5</sup>
<b>Useful aperture</b>	Ø 18 mm (Ø25 mm options also available)				
<b>Input window</b>	Glass	Glass	Glass	Glass	MgF <sub>2</sub> + F/O + Lumogen
<b>Photocathode type</b>	HVS	VIH	NIR	EVS	BGT
<b>Peak QE @ room temperature<sup>*1</sup></b>	> 47.5	> 25.5	> 5	> 40	> 17
<b>Wavelength range</b>	280 - 760 nm	280 - 910 nm	380 - 1090 nm	280 - 810 nm	< 200 - 910 nm
<b>Image intensifier resolution limit<sup>*2</sup></b>	30 µm	30 µm	30 µm	30 µm	40 µm
<b>Phosphor type [decay time to 10%]</b>	P43 [2 ms]				
<b>Minimum optical gate width (ns)<sup>*3</sup></b>					
<b>U (Ultrafast)</b>	< 2	< 2	< 3	< 2	< 3
<b>F (Fast)</b>	< 5	< 5	< 5	< 5	< 5
<b>Maximum relative gain<sup>*4</sup></b>	> 200				
<b>Maximum photocathode repetition rate (with Intelligate™ OFF)</b>	500 kHz (continuous)				
<b>Maximum photocathode repetition rate (with Intelligate™ ON)</b>	5 kHz (continuous)				
<b>Equivalent Background Illuminance (EBI)</b>	< 0.1 photoe/pix/sec	< 0.3 photoe/pix/sec	< 2 photoe/pix/sec	< 0.2 photoe/pix/sec	< 0.3 photoe/pix/sec

1. Typical photocathode Quantum Efficiency and input window transmission as measured by the tube manufacturer.
2. Typical resolution of the image intensifier tube only, not the overall resolution of the system. As a rough guide, the smallest resolvable FWHM feature will be approximately 4x the sensor pixel size.
3. Actual measured minimum optical gating of the photocathode, reflecting not only the electrical pulse width applied to the photocathode but also its inherent iris time.
4. Gain is software-selectable through a 12-bit DAC and varies exponentially with DAC setting. Value refers to the ratio of max to min intensifier gain as measured for individual cameras. Actual optical gain (counts/ photoe-) for a DAC setting is accessed by the multiplication of the relative gain (at that DAC value) by the minimum system gain (at DAC = 0, sCMOS e-/photoe-) and divided by the sCMOS sensitivity (sCMOS e-/count). Sensitivities are individually measured and reported for each system.
5. Combination of -73 GaAsP photocathode with a lumogen-coated fibre-optic plate and protective MgF<sub>2</sub> window. The latter additional optical interfaces are the reason for the lowered QE in the visible NIR region, for the -C3 model. Note that spectral resolution will be degraded < 450 nm.

All photocathode types can be combined with a fast-decay P46 phosphor.\* Substitute with appropriate gate width option, e.g. 18U-63

## QE Data

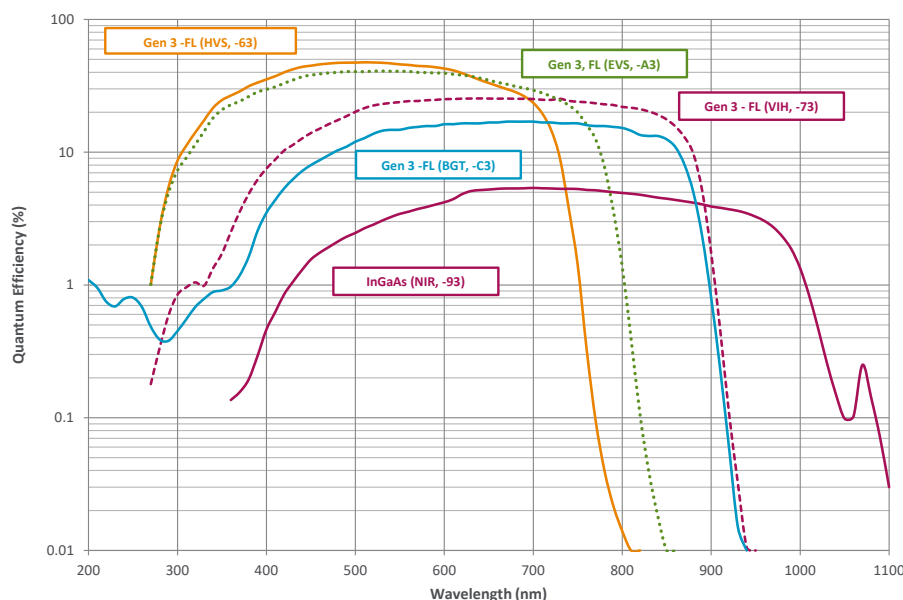

## APPENDIX D: DDG INFORMATION

The iStar sCMOS holds a fully integrated software-controlled digital delay generator (DDG) with the following specifications:

Gate pulse delay & width	<ul style="list-style-type: none"> <li>Adjustable from 0 ns to 10 s in 10 ps steps</li> <li>Software controlled, pre-programmed or real-time</li> </ul>
<b>TRIGGER OUTPUTS</b>	
Output A, B and C	<ul style="list-style-type: none"> <li>3x output, +5V CMOS level with 50 <math>\Omega</math> source impedance; can drive 5V into a non-terminating load or 2.5V into 50 <math>\Omega</math> load; output synchronized triggers for auxiliary equipment, e.g. lasers, flash lamps, or National Instrument™ hardware</li> <li>Individual delays control from 0 ns to 10 s in 10 ps steps</li> <li>Configurable polarity</li> <li>Software controlled, pre-programmed or real-time</li> </ul>
Fire	<ul style="list-style-type: none"> <li>5V CMOS level reference signal for beginning and end of individual sensor exposure</li> </ul>
Arm monitor	<ul style="list-style-type: none"> <li>5V CMOS level reference signal to indicate when system is ready to accept external triggers. Signal goes high when system is ready to accept external triggers (after a complete readout has finished) including keep clean and goes low when the exposure is finished</li> </ul>
Gate & output A, B and C jitter	<ul style="list-style-type: none"> <li>35 ps rms (relative to external trigger signal)</li> </ul>
<b>TRIGGER INPUTS</b>	
External trigger	<ul style="list-style-type: none"> <li>Trigger input for sensor and Digital Delay Generator</li> <li>Up to 500 kHz for Integrate-On-Chip mode</li> <li>Software-configurable polarity, termination and trigger threshold</li> <li>Fast external software option for most rapid camera response to external trigger (keep clean interruption) – no need for pre-trigger pulse</li> </ul>
Direct gate	<ul style="list-style-type: none"> <li>TTL input for exact external control of photocathode width and timing with smallest insertion delay.</li> </ul>
<b>ADDITIONAL CONTROLS</b>	
Gate monitoring	<ul style="list-style-type: none"> <li>AC coupling from photocathode to monitor exact photocathode On/Off switching and timings</li> </ul>
Insertion delay	<ul style="list-style-type: none"> <li>&lt; 19 ns in direct gate operation</li> </ul>

## D.1 IMAGE INTENSIFIERS

An Image intensifier is an evacuated, proximity-focus device that amplifies the intensity of an incoming signal. The device is small, typically 1-2 inches in diameter and 1 inch thick. As well as amplifying incoming signal, an image intensifier can rapidly be switched on and off, allowing it to be used as a very fast optical shutter in the nanosecond time regime. The image intensifier used in the system can either be of 2nd generation ('Gen 2') or 3rd generation ('Gen 3').

There are three major elements in an image intensifier :

- The photocathode
- The Micro-Channel Plate (MCP)
- The output Phosphor screen

### D.1 PHOTOCATHODES AND WINDOWS

The photocathode is coated on the inside surface of an input window, typically made of silica, MgF<sub>2</sub>, Borosilicate glass or fibre-optic plate. The input window typically sets the lower detection limit, while the photocathode sets the upper detection wavelength.

When an incoming photon strikes the photocathode, a photoelectron may be emitted, depending on the QE of the photocathode. This photoelectron is drawn across a small gap towards the MCP by an electric field.

'**Gen 2**' refers to multi-alkali based photocathodes that present a wide wavelength coverage from UV up to ~ 900 nm, with moderate peak QE up to ~25-30%. The lower detection limit is set by the photocathode substrate, typically Silica or Magnesium Fluoride (MgF<sub>2</sub>). These photocathodes are quite resistive, and require a metallic underlay (full or grid-type) to achieve nanosecond gating times (at the expense of a few percent QE).

'**Gen 3**' refers to Gallium-Arsenide (GaAs) – based photocathodes. These are typically deposited on glass - which sets the lowest detection limit at ~ 350 nm, and are sensitive up to ~900 nm. They present peak QE up to 50%.

**Gating** - The voltage on the photocathode in relation to the input of the MCP can be rapidly toggled between 2 levels. If the voltage of the photocathode is made positive relative to the input of the MCP, then the photoelectrons will not have sufficient energy to leave the photocathode and the image intensifier will effectively be OFF. By switching the voltage the intensifier can be turned ON and OFF. This process is referred to as "Gating". Gating periods in the nanosecond scale (billionth of a second) can be readily achieved, making the image intensifier, one of the fastest optical shutters available.

### D.2 INTERNAL REFLECTION IN THE INPUT WINDOW

Data acquired with a 25 mm intensifier tube may exhibit an artifact due to light that has entered the camera obliquely and has been internally reflected in the input window. The effect is generally not significant, but a brief explanation may be appropriate nonetheless.

At the center of the photocathode the internally reflected rays may coincide with each other and with light falling on the photocathode directly. The result is a signal around 5% higher than average at the center of the photocathode. The phenomenon appears as a slight peak in the middle of a 2D trace, or as a slight cone in the middle of an image.

The aperture in the faceplate is left deliberately large to fully accommodate the light cone from lenses and spectrographs. If an aperture of 25-26 mm diameter is placed in front of the input window, the range of angles at which light can enter is reduced and the peak or cone effect disappears. There may then, however, be a vignette effect as light from the outside of the light cone emerging from lenses or spectrographs is blocked.

### D.3 MICRO CHANNEL PLATE (MCP)

The MCP is a thin disk (~1mm) of honeycomb glass. Each of the ~10 µm honeycomb channels is coated with a resistive material.

The MCP plate has a high potential across it (500V to 1kV) so that an incoming photoelectron will cascade down the channel, producing secondary electrons by impact ionization. Typical gain for single stage MCP can be as high as 10<sup>4</sup> – gain can be adjusted by varying the voltage potential across the MCP. This is typically achieved through a software-controlled DAC in research-grade Intensified CCDs, and now Intensified sCMOS in the iStar sCMOS.

### D.4 PHOSPHORS

The function of the Phosphor on the inside of the intensifier's fiber optic exit window is to convert the incident electron pattern into a visible light pattern that can be detected by the sensor. For best efficiency, it is important that the emission of the phosphor is matched to the response of the sensor.

Phosphor type	Color	Emission peak (nm)	Decay time (to 10%)	Composition	Relative light output
P46	Yellow/Green	530	200 ns	Y <sub>3</sub> Al <sub>5</sub> O <sub>12</sub> :Ce	10
P43	Yellow/Green	545	2 ms	Gd <sub>2</sub> O <sub>2</sub> S:Tb	100

Our systems use either **P46** or **P43** Phosphor as standard (details are shown in the table above). P46 is used for applications requiring fast scan rates (> 100 Hz). If these speeds are not required then the more efficient P43 is preferable. P43 is used in preference to the more commonly used P20 because of superior linearity. See the specification supplied with your system for more details.

### D.5 COUPLING TO THE SENSOR

The **output** of the image intensifier is coupled to a **sensor** via either a lens - with possible vignetting and lower throughput, or a fibre-optic plate for low distortion and maximum throughput. The high efficiency fibre optic coupling is important because it means that the image intensifier can be operated at lower gains, which results in better dynamic range and linearity. This is why **ICCDs** replaced **Intensified Photodiode Arrays (IPDAs)** as the detector of choice. iStar sCMOS now further extends sensitivity through the use of a sCMOS detector. This enables higher speeds at high resolution and with high dynamic range capacity.

## APPENDIX E: sCMOS STRUCTURE AND OPERATION

### E.1 AN INTRODUCTION TO sCMOS

sCMOS technology has been developed specifically to overcome many of the limitations that have marred other scientific detector technologies, resulting in an imaging detector that provides exceptional performance for many applications. This technology previously used in the Andor Zyla and Neo is now utilised in the iStar sCMOS.

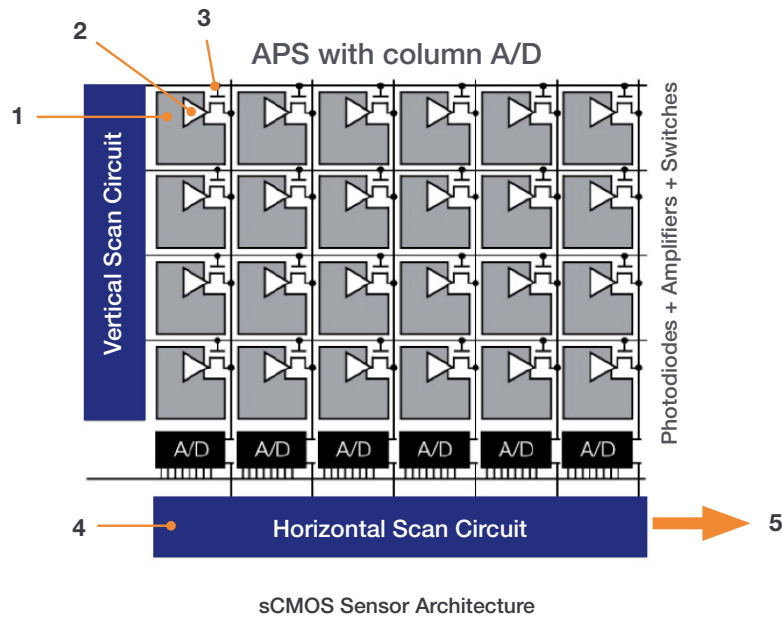

As illustrated above, the CMOS sensor is an “Active Pixel Sensor” (APS) whereby each pixel has its own integral amplifier and the sequence of operation is as follows:

1. Light hits sensor and generates charge
2. The photo-generated charge is converted to an analog voltage inside each pixel amplifier
3. Pixel voltage is transferred to the column bus via a row select signal
4. The analog voltage is then converted to a digital signal via columns of A/D (analog to digital) converters.
5. The final digitized signals are then read out sequentially at a pixel readout speed of up to 280 MHz (in x2 halves).

#### NOTES:

The diagram, above is representative- the light sensitive area is contiguous as the photodiodes for each pixel are buried within the sensor. Each Pixel also has a microlens to maximize sensitivity to light.

## E.2 UNDERSTANDING READ NOISE IN sCMOS

sCMOS technology boasts an ultra-low read noise floor that is significantly that of even the best CCDs, and at several orders of magnitude faster pixel readout speeds. For those more accustomed to dealing with CCDs, it is useful to gain an understanding of the nature of read noise distribution in CMOS imaging sensors.

CCD architecture is such that the charge from each pixel is transferred through a common readout structure, at least in single output port CCDs, where charge is converted to voltage and amplified prior to digitization in the Analog to Digital Converter (ADC) of the camera. This results in each pixel being subject to the same readout noise. However, CMOS technology differs in that each individual pixel possesses its own readout structure for converting charge to voltage. In the sCMOS sensor, each column possesses dual amplifiers and ADCs at both top and bottom (facilitating the split sensor readout). During readout, voltage information from each pixel is fed directly to the appropriate amplifier/ADC, a row of pixels at a time (see Technical Note on Rolling and Global Shutter modes).

As a consequence of each pixel having its own individual readout structure, the overall readout noise in CMOS sensors is described as a distribution, as exemplified in **Figure 10** below, which is a representative noise histogram from a sensor at the fastest readout speed of 560 MHz (or 280 MHz x 2 halves). It is standard to describe noise in CMOS technology by citing the median value of the distribution. In the data presented, the median value is 1.38 electron RMS. This means that 50% of pixels have a noise less than 1.38 electrons, and 50% have noise greater than 1.38 electrons. While there will be a small percentage of pixels with noise greater than 2 or 3 electrons, observable as the low level tail towards the higher noise side of the histogram, it must be remembered that a CCD Interline camera reading out at 20 MHz would have 100% of its pixels reading out with read noise typically ranging between 6 and 10 electrons RMS (depending on camera design).

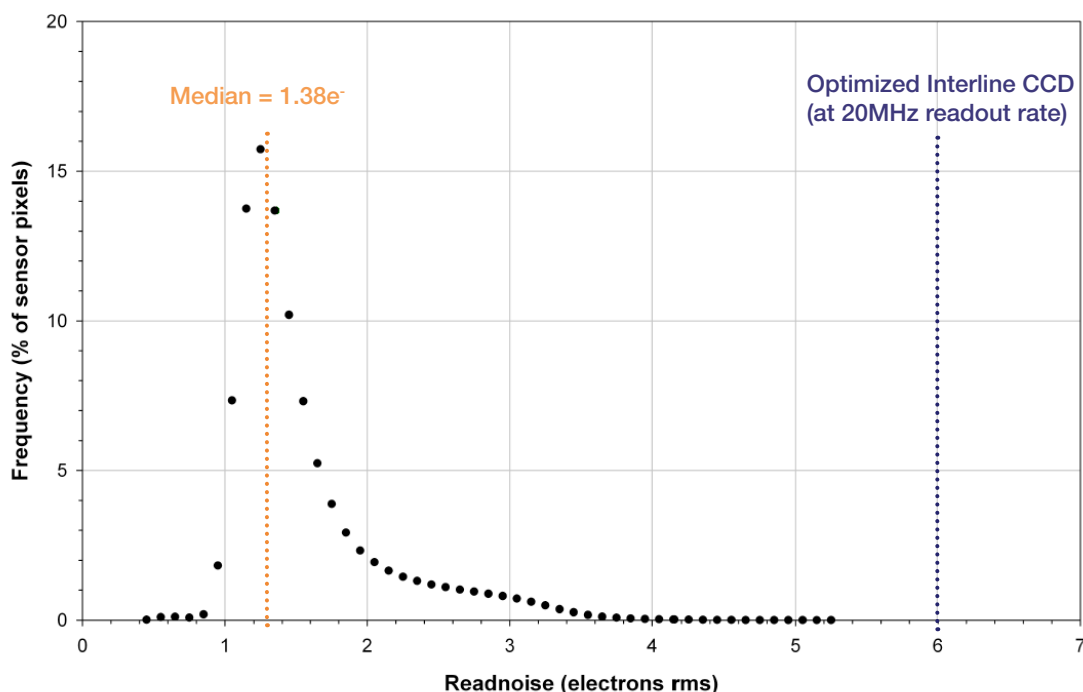

Representative histogram showing read noise distribution at fastest readout speed, 560 MHz (280 MHz x2). The median value of 1.38 e<sup>-</sup> means 50% pixels have read noise less than 1.38 e<sup>-</sup> and 50% have greater than 1.38 e<sup>-</sup>. The line at 6 e<sup>-</sup> represents a typical read noise value from a well-optimized Interline CCD – all pixels in a CCD essentially share the same noise value



### E.3 SPURIOUS NOISE FILTER

The **Spurious Noise** filter corrects for pixels that would otherwise appear as spurious ‘salt and pepper’ noise spikes in the image. The appearance of such noisy pixels is analogous to the situation of Clock Induced Charge (CIC) noise spikes in EMCCD cameras, in that the overall noise of the sensor has been reduced to such a low level, that the remaining small percentage of spurious, high noise pixels can become an aesthetic issue. The filter actively corrects such high noise pixels, replacing them with the mean value of the neighbouring pixels. The filter can be switched on and off by the user prior to data acquisition.

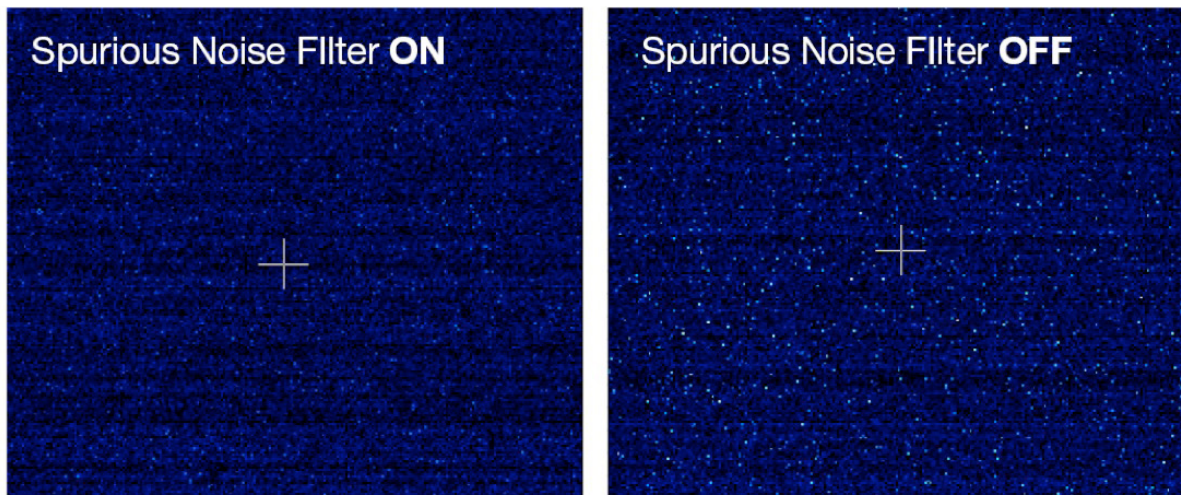

Demonstration of Spurious Noise Filter (Filter On left, Filter Off, Right) on a dark image, 20 ms exposure time, 200 MHz (x2 halves) readout speed

### E.4 BLEMISH CORRECTION

This **Blemish Correction** filter identifies and compensates for three types of blemishes during the FPGA processing step:

1. Hot Pixel's
2. Noisy Pixel's
3. Unresponsive Pixel's

sCMOS sensors are particularly susceptible to hot pixel blemishes. These are spurious noise pixels that have significantly higher dark current than the average. Through deep TE cooling of the sensor (e.g. -30°C in the Neo), it is possible to dramatically minimize the occurrence of such hot pixels within the sensor, meaning that these pixels can still be used for useful quantitative imaging. However, if deep cooling cannot be achieved it is necessary to use interpolative filters to minimize the hot pixel blemishes. These filters work by taking the mean of the surrounding 8 pixel values and replacing this hot pixel blemish with this mean value. Such interpolation over pixel blemishes can be detrimental in some applications that depend on total quantitative integrity over a limited set of pixels, for example in localization based super-resolution microscopy (such as PALM and STORM techniques) and astronomy. In these applications it is essential for the user to be able to switch off interpolative corrections.

Furthermore, having access to the location of these blemishes allows an accurate map of ‘good’ pixels to be determined by the user. A new service allows the end user to request a ‘hot pixel map’ of their sCMOS sensor from Andor. This map will be generated based on the experimental conditions outlined by the end user.

From the Andor SDK3 (version 3.7.30004) and Solis (version 4.24.30004) onwards blemish correction can be switched on and off by the user. Refer to the SDK and Solis User Guide and help information for instructions.

## E.5 DUAL AMPLIFIER DYNAMIC RANGE

The Dual Amplifier architecture of the sCMOS sensor eliminates the need to choose between low noise or high capacity, in that signal can be sampled simultaneously by both high gain and low gain amplifiers. As such, the lowest noise of the sensor can be harnessed alongside the maximum well depth, affording the widest possible dynamic range. Traditionally, scientific sensors including CCD, EMCCD, ICCD and CMOS, demand that the user must select 'upfront' between high or low amplifier gain (i.e. sensitivity) settings, depending on whether they want to optimise for low noise or maximum well depth. Since the true dynamic range of a sensor is determined by the ratio of well depth divided by the noise floor detection limit, then choosing either high or low gain settings will restrict dynamic range by limiting the effective well depth or noise floor, respectively.

For example, consider a large pixel CCD, with 16-bit Analog to Digital Converter (ADC), offering a full well depth of 150,000 e<sup>-</sup> and lowest read noise floor of 3 e<sup>-</sup>. The gain sensitivity required to give lowest noise is 1 e<sup>-</sup>/ADU (or 'count') and the gain sensitivity required to harness the full well depth is 2.3 e<sup>-</sup>/ADU, but with a higher read noise of 5 e<sup>-</sup>. Therefore, it does not automatically follow that the available dynamic range of this sensor is given by 150,000/3 = 50,000:1. This is because the high sensitivity gain of 1e<sup>-</sup>/ADU that is used to reach 3 e<sup>-</sup> noise means that the 16-bit ADC will top out at 65,536 e<sup>-</sup>, well short of the 150,000 e<sup>-</sup> available from the pixel. Therefore, the actual dynamic range available in 'low noise mode' is 65,536/3 = 21,843:1. Conversely, the lower sensitivity gain setting means that the ADC will top out at ~ 150,000 e<sup>-</sup>, but the higher read noise of 5 e<sup>-</sup> will still limit the dynamic range to 150,000/5 = 30,000:1 in this 'high well depth mode'. The sCMOS sensor offers a unique dual amplifier architecture, meaning that signal from each pixel can be sampled simultaneously by both high and low gain amplifiers. The sensor also features a split readout scheme in which the top and bottom halves of the sensor are read out independently. Each column within each half of the sensor is equipped with dual column level amplifiers and dual analog-to-digital converters, represented by the block diagram below:

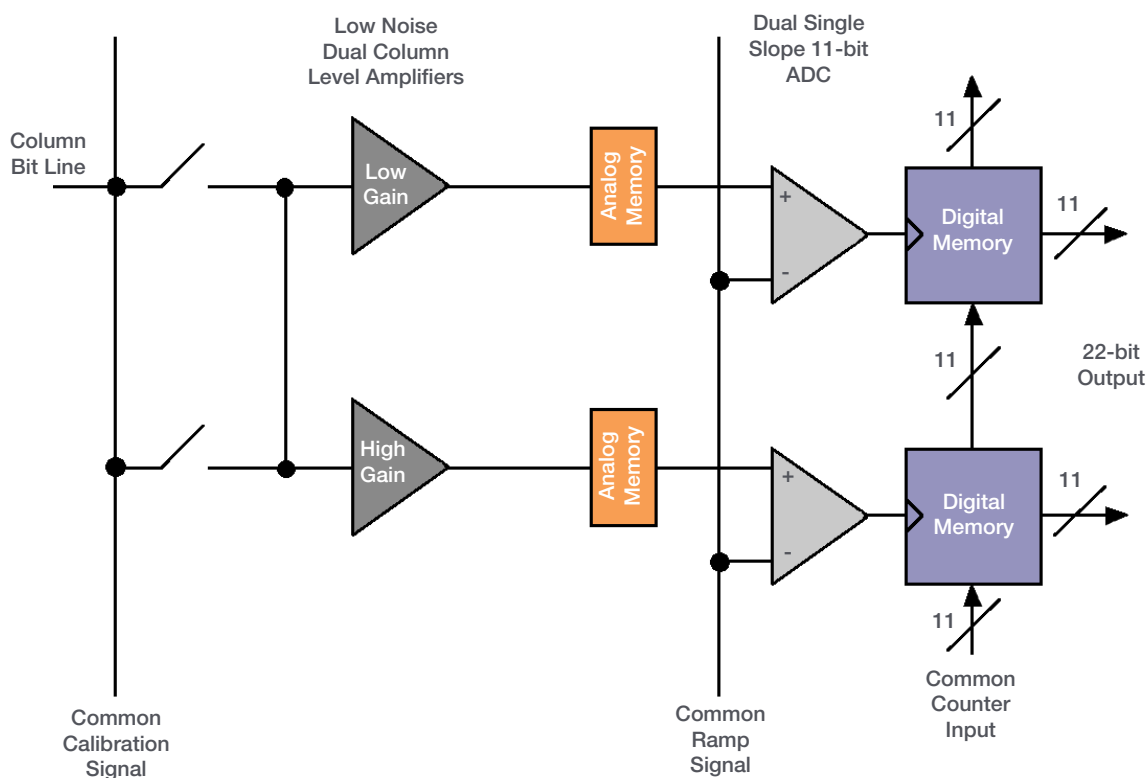

Amplifiers and ADC of the sCMOS Sensor

The dual column level amplifier/ADC pairs have independent gain settings, and the final image (see Figure 13) is reconstructed by combining pixel readings from both the high gain and low gain readout channels to achieve a wide intra-scene dynamic range, uniquely so considering the relatively small 6.5 μm pixel pitch.

The method of combining signals from two 11-bit ADCs can be divided into four basic steps.

1. At the end of the analog chain the “Signal” voltage is applied to two independent amplifiers: the high gain amplifier and the low gain amplifier. This results in two separate digital data streams from the sensor
2. The camera selects which data stream to use on a pixel per pixel, frame by frame basis using a threshold method
3. The data is then compensated for DC offset and gain. Again, this is done on a pixel by pixel basis using the compensation data associated with the data stream. The gain corrects for pixel to pixel relative sensitivity, pixel node amplifier and the high and low amplifier relative gains
4. The pixels are then combined into a single 16-bit image for transfer to the PC

The user maintains the choice of opting to stay with 12-bit single gain channel data if dynamic range is not critical, resulting in smaller file sizes. This in turn offers faster frame rates when continuously spooling through the USB 3 interface and writing to hard disk.

Typical performance of supported gain settings

Amplifier Gain (Current Andor SDK / Solis description)	Mode	Sensitivity e-/ ADU (typical)	Data Range	Effective pixel saturation limit / e-	Spooling File Size (per frame)
12-bit (high well capacity)	GS/RS	7.5	12-bit	30,000	8 Mb
12-bit (low noise)	GS	0.42	12-bit	1,700	8 Mb
12-bit (low noise)	RS	0.28	12-bit	1,100	8 Mb
16-bit (low noise and high well capacity)	GS	0.45	16-bit	30,000	10.5 Mb
16-bit (low noise and high well capacity)	RS	0.45	16-bit	30,000	10.5 Mb

## E.6 SENSOR READOUT OPTIMIZATION

To allow the camera to be optimized for the widest range of applications it is important to have flexibility in the readout options available, some of these include the following:

- Gain Channel Control
- Pixel Readout Rate
- ROI sub image settings
- Triggering / Synchronization options

## E.7 GAIN CHANNEL CONTROL

The iStar sCMOS offers the user a choice of two 12-bit gain channels (i.e. high or low gain) or a combined '16-bit' setting. The user can choose to stay with 12-bit single gain channel data if dynamic range is not critical, resulting in smaller file sizes. This in turn offers faster frame rates when continuously spooling through the USB 3 interface and writing to hard disk. The 16-bit dual gain channel should be chosen if dynamic range is more important than having the fastest frame rates.

## E.8 PIXEL READOUT RATE

The Pixel Readout Rate defines the rate at which pixels are read from the sensor. The faster the readout rate the higher the frame rate that can be achieved. The ability to change the pixel readout rate is important to achieve the maximum flexibility of camera operation.

Slower readout typically allows lower read noise but at the expense of slower frame rates. The following readout rates are available (**Table 8** below shows the typical read noise at each readout rate):

- 200 MHz (100 MHz x 2 halves) and 560 MHz (280 MHz x 2 halves)

**Table 1: Typical Read Noise**

Rate	Read noise (e-) Global Shutter (typical)
200 MHz	2.6
560 MHz	2.6

Please refer to **Section 2.3** for more information on read noise and the camera performance sheet for read noise values at the various readout speeds.

## E.9 ROI SUB-IMAGE SETTINGS

**ROI Sub Image** allows for readout of a particular sub-area of the sensor. When a sub image has been defined, only data from the selected rows will be digitized.

Selecting a sub image increases the frame readout rate and reduces image storage requirements. Examples of sub-image selection and spooling rates are shown in **Table 7**.

It should be noted that for small ROIs (e.g. < 512 x 512 pixels), the achievable frame rate for 3-tap and 10-tap becomes identical. This is due to the fact that the amount of data transmitted across the USB 3 interface for these ROIs is relatively small and the limiting factor becomes the rate at which data can be read off the sensor.

It should also be noted that while ROIs can also be set up for any area of the sensor, those which are vertically centred on the sensor mid line will result in the maximum frame rates.

## E.10 GLOBAL SHUTTER

Global shutter mode, which can also be thought of as a ‘snapshot’ exposure mode, means that all pixels of the array are exposed simultaneously. In most respects, global shutter can be thought of as behaving like an Interline CCD sensor. Before the exposure begins, all pixels in the array will be held in a ‘keep clean state’, during which charge is drained into the anti-bloom structure of each pixel. At the start of the exposure each pixel simultaneously begins to collect charge and is allowed to do so for the duration of the exposure time. At the end of exposure each pixel transfers charge simultaneously to its readout node. Importantly, global shutter can be configured to operate in a continuous ‘overlap’ mode (analogous to Interline CCD), whereby an exposure can proceed while the previous exposure is being readout out from the readout nodes of each pixel. In this mode, the sensor has a 100% duty cycle, again resulting in optimal time resolution and photon collection efficiency.

However, the mechanism of global shutter mode demands that a reference readout is performed ‘behind the scenes’, in addition to the actual readout of charge from each pixel. Due to this additional reference readout, global shutter mode carries the trade-off of halving the maximum frame rate that would otherwise have been achieved in rolling shutter mode (refer to our website for further information on Rolling and Global Shutter modes of sCMOS technology). In addition, global shutter also increases the RMS read noise by a factor of 1.41 over rolling shutter readout. The figure below shows a simplified illustration showing sequence of events in global shutter mode for an image for Zyla sCMOS:

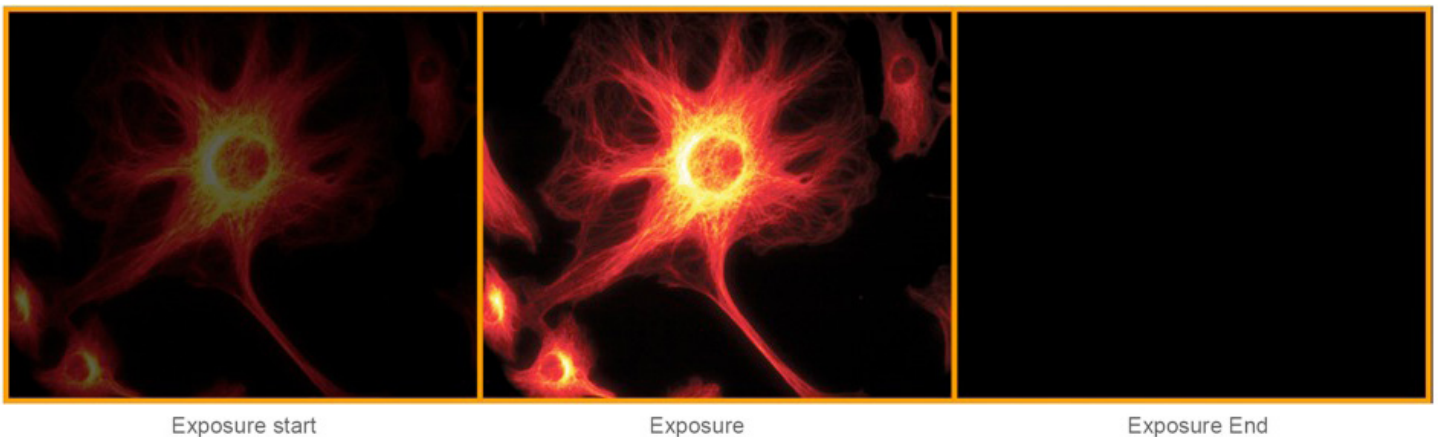

Global Shutter Exposure and Readout

## APPENDIX F: OTHER INFORMATION

### Terms and Conditions of Sale and Warranty Information

The terms and conditions of sale, including warranty conditions, will have been made available during the ordering process. The current version may be viewed at: [http://www.andor.com/pdfs/literature/Andor\\_Standard\\_Warranty.pdf](http://www.andor.com/pdfs/literature/Andor_Standard_Warranty.pdf)

### Waste Electronic and Electrical Equipment Regulations 2006 (WEEE)

The company's statement on the disposal of WEEE can be found in the Terms and Conditions.

