

Balor-X sCMOS

Solutions for High Energy Physics

Key Specifications

- ✓ 16.9 MP – very large field of view
- ✓ Up to 54 fps, 18.5 ms readout
- ✓ Low noise sCMOS – high dynamic range
- ✓ 12 μm pixels – high resolution & well depth
- ✓ Ultravac™ – maintenance-free
- ✓ Extended dynamic range
- ✓ > 99.7% Linearity

Key Applications

- ✓ Hard x-ray & neutron tomography
- ✓ Hard x-ray microscopy
- ✓ X-ray diffraction & crystallography
- ✓ X-ray scattering - SAXS & WAXS
- ✓ Engineered material science
- ✓ Fuel cells
- ✓ Geological & archaeological artefacts

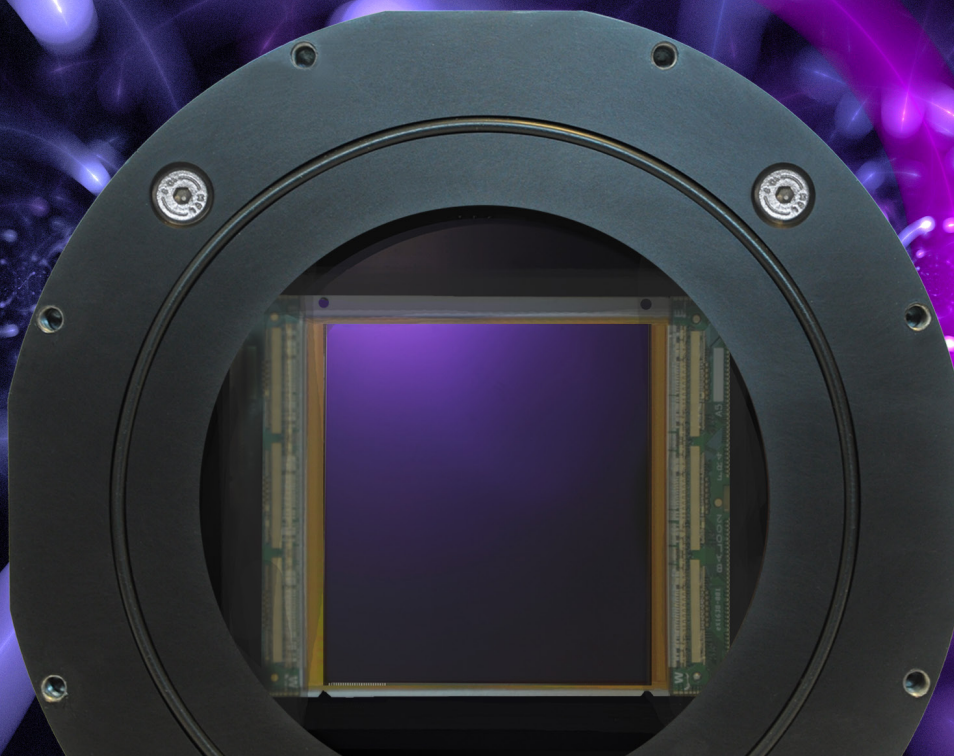

Introducing Balor-X

For X-ray and Neutron “indirect” Detection



Many challenges in modern X-ray and neutron detection require not only high resolution, large field of view and superb sensitivity, but also to capture high quality data faster and make the best use of valuable experimental / beam time. However, large area CCD technology is performance-limited in this regard. Even the fastest CCDs lack frame rates required for fast radiographic imaging applications including computed tomography or dynamic *in situ*, in operando processes.

The **NEW Balor sCMOS platform** is the perfect instrument to address this fundamental challenge!

Exceptionally fast 54 fps at full frame with a 16.9 Megapixel camera. Acquire complex datasets and advance your research!

A revolutionary, very large field of view, fast readout sCMOS detector for indirect X-ray and neutron detection. Balor-X, utilizes a sensor that is unique to Andor and is capable of ripping along at up to 54 frames per second at full 16.9 MP resolution, whilst remarkably, maintaining an exceptionally low < 3 electrons read noise. The 12 μm pixels offer deep well depth and an on-chip multi-amplifier design means a large 16 bit dynamic range can be captured within a single image, ideal for analyzing high-intensity signals and/or samples with wide range absorbances.

With a 70 mm sensor diagonal, Balor-X is the largest commercially available sCMOS camera for indirect neutron & hard X-ray applications including radiographic imaging and computed tomography, scattering (SAXS, WAXS) and diffraction (X-ray crystallography) imaging. It enables the rapid acquisition of high contrast imaging of larger samples in the field of material science, structural engineering, biology, energy research, fluid dynamics, archaeology and mineralogy.

Balor-X is the perfect solution for imaging large samples, complex inner structures and dynamic behaviour at high speeds. Its fast 54 fps can be cropped to further increase frame rate. A 0.5 Megapixel image can be captured at 1,600 Hz!



Balor in Irish Mythology

Long ago, in ancient times, supernatural beings called the Fomorians ruled over Ireland. Balor, the deadliest and most feared of the Fomorian kings, wreaked destruction on anything that dared to cross his deadly gaze. But in the battle of Mag Tuired, Balor fell when a spear was cast through his eye. Face down, his body burned a hole in the earth, which filled with water to become Loch na Súil: The lake of the eye.



As a new day dawns, the great Balor has been resurrected to help physicists fight a different battle. A battle of exploration beyond the boundaries of the frontiers of science. [Find out more here.](#)

Features & Benefits Summary

Feature	Benefit
49.5 x 49.2 mm sensor	Very large field of view from 16.9 Megapixel, 12 mm pixel pitch sensor.
18.5 millisecond readout	Readout a 4k x 4k sensor 2,500x faster than a CCD. More data throughput less downtime!!
Up to 54 fps	Unique solution for a range of high time-resolution observing challenges, without compromising noise or FOV.
Extended Dynamic Range and > 99.7% Linearity	Superb quantitative accuracy across a wide range of magnitudes within a single image.
Readout noise ~ 2.9 e-	Exceptionally low noise, even at max frame rate, suited to short exposure, low light observational challenges.
No inter-pixel "dead area"	No discontinuities in images that could contribute to loss of information.
80 000 e- well depth	Deep well depth, provides high dynamic range (high contrast) images thanks to sCMOS low noise floor. Enables the acquisition of long images without oversaturation of the pixels to record even the weakest signals.
UltraVac™•1	Critical for sustained vacuum integrity and to maintain unequalled cooling and QE performance, year after year.
CoaXPress as standard	4 Lane CXP-6 interface enabling the highest frame rates over distances up to 30 m.
Rolling and Global shutter supported	Maximum exposure and readout flexibility across all applications. Global Shutter for snapshot capture of fast moving/changing events.

Key Features

Very Large Field of View

70 mm sensor diagonal enables larger sample imaging at higher resolutions and magnifications whilst improving data contrast and resolution.

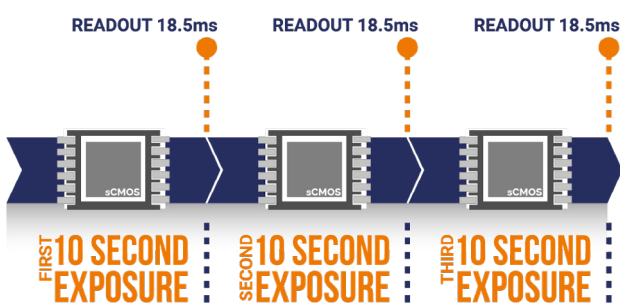

Fast Sensor Readout

Taking only 18.5 milliseconds per full frame readout, Balor-X can rapidly obtain data across small time scales, including ultra-fast computed tomography and in situ studies of rapidly evolving transient environments. It is also possible to minimise signal to noise by using longer exposures (10 - 60 s) and still achieve frame cycle times much faster than CCDs - ideal for low intensity imaging applications such as laboratory-based X-ray sources!

Extended Dynamic Range

Large pixel well-depth and an on-chip multi-amplifier design means a wide range of absorption and phase intensities can be collected, from the noise floor up to the saturation limit, within one image. The wide dynamic range is complemented by enhanced on-head intelligence to deliver linearity > 99.7%, for unparalleled quantitative accuracy of measurement across the full signal range ideal for determining scattering and diffraction intensities of single crystal and powdered samples.

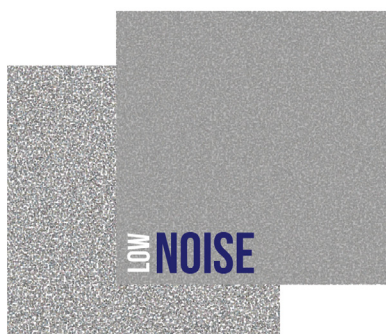

Low Noise

The parallel readout architecture and innovative pixel design enables Balor to drive very low read noise performance, < 3 e-, while still achieving maximum readout speed. Ideal for detecting weak signal from low intensity applications such as X-ray and neutron scattering and diffraction.

Key Features

Vacuum Sensor Enclosure

sCMOS cameras from other manufacturers use O-ring sealed, back-filled sensor enclosures, susceptible to moisture ingress and routine factory maintenance. Andor is the only manufacturer of vacuum enclosed sCMOS cameras, based on our proven UltraVac™ process, offering superior cooling and ultimate sensor protection. Expect the vacuum to hold firm, year after year.

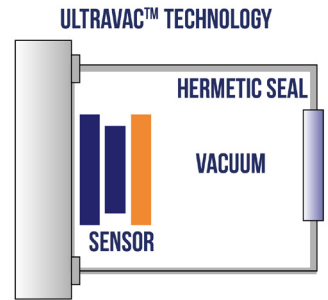

No Mechanical Shutter

Applications that involve frequent cycling of mechanical shutters, such as tomography studies, require routine shutter replacements and lead to unproductive periods of down time. Balor offers on-sensor Rolling and Global Shutter options, thus, overcomes the need for mechanical shutters. Furthermore, this avoids the exposure gradient effects also associated with mechanical shutters.

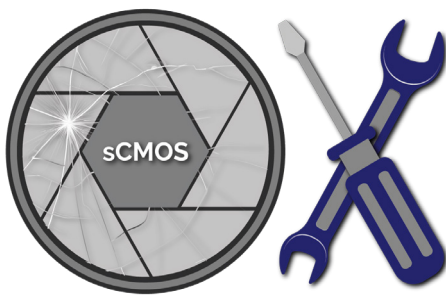

High Resolution Images

Balor-X's 12 μm pixels, coupled to appropriate scintillators, provide superior image resolution compared to direct hard X-ray detectors with pixels 10's of microns large. Unlike these detectors, Balor's pixel configuration also leads to images with no discontinuities, capturing more information from samples with minimum image artefacts and need for intensive post processing.

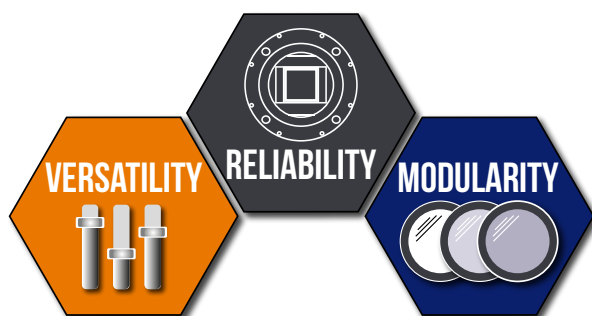
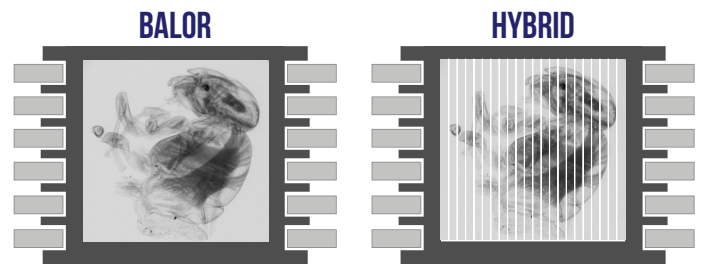

Versatility and Modularity

The Balor-X accommodates a large range of lens-coupling and scintillator configurations:

- ✓ Provide detection capabilities up to 100's of keV.
- ✓ Allow optimisation of spatial resolution for a given energy range.
- ✓ Offers the best detector lifetime - achieve consistent results year after year!

Application Focus

Neutron & X-ray Radiography

Balor's low noise and high dynamic range allow it to capture the finest sample details in high and low flux environments at both short and long exposure times. Furthermore, the 70 mm, 16.9 MP sensor enables it to capture a large field of view making it not only a great choice for large samples X-ray and Neutron Absorption and Phase Contrast Imaging, but also for various other X-ray microscopy applications such as full-field X-ray Diffraction and Ptychography.

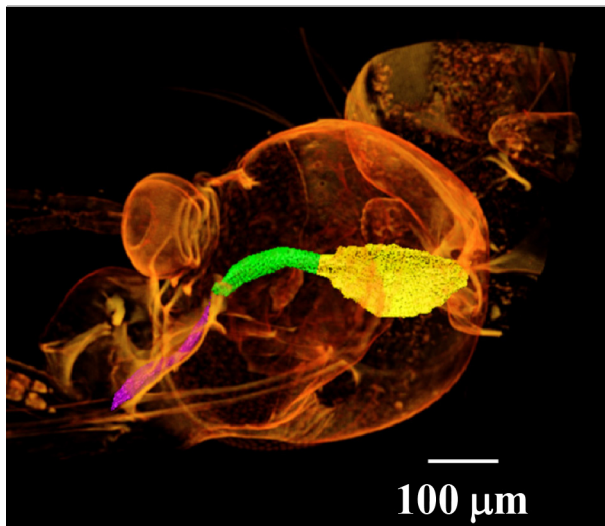
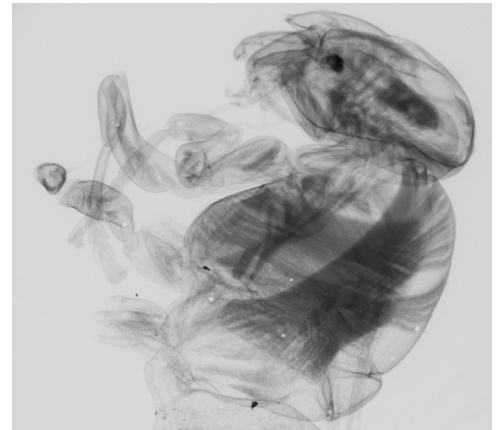

Image courtesy of Prof. S.J. Lee & Dr. Ha, Pohang University of Science and Technology (POSTECH), Republic of Korea.

Computed Tomography (CT)

The significantly faster read speeds of the Balor-X compared to traditional CCD cameras (x2500 faster) and extremely fast frame rates (54 fps at a full 16.9 MP frames) allows it to capture extensive datasets and better sample dynamic phenomena in time. Coupled with low read noise and dark current, the Balor's high sensitivity makes it ideal for rapid tomography in low flux laboratory-based environments. The high dynamic range and pixel well depth of the Balor also enables it to capitalise on high flux environments such as beamline applications to maximise data collection rates and maximise beamline usage efficiency.

Scattering & Diffraction

Balor's high sensitivity, low read and dark noise floor allows to resolve weak scattering signals. Its compact design and small pixels enable it to get closer to samples increasing resolution, and substantially reducing experimental setup size. Furthermore, it provides no discontinuity in the acquired image (no potential loss of critical information) for applications based on SAXS, WAXS or X-ray crystallography. The high frame rate of the Balor and the ability to crop and bin pixels allows to better address time resolved crystallography or *in situ* X-ray powder diffraction challenges.

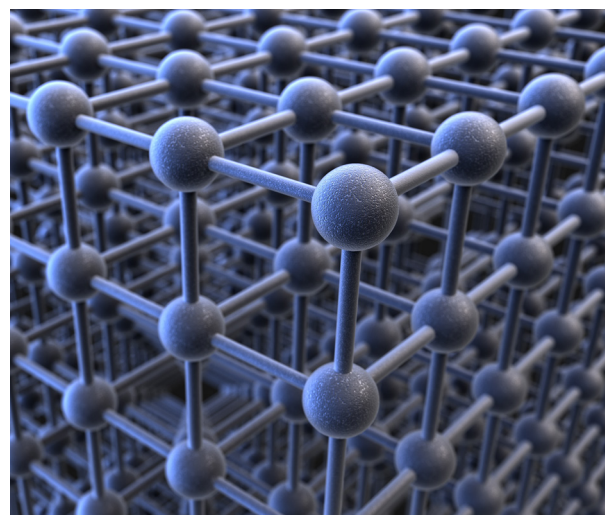

Application Focus

In situ dynamic X-ray & Neutron Imaging

The high frame rate of the Balor makes it ideal for *in situ* neutron and X-ray imaging applications. Its large 16.9 MP sCMOS sensor and high sensitivity enables it to resolve even the finest compositional and microstructural changes within a material at extremely fast frame rates. The Balor's binning modes can also be utilized to meet particularly high frame rate requirements in experiments. Additionally, pixel binning, can be used to increase image intensity without sacrificing acquisition rate.

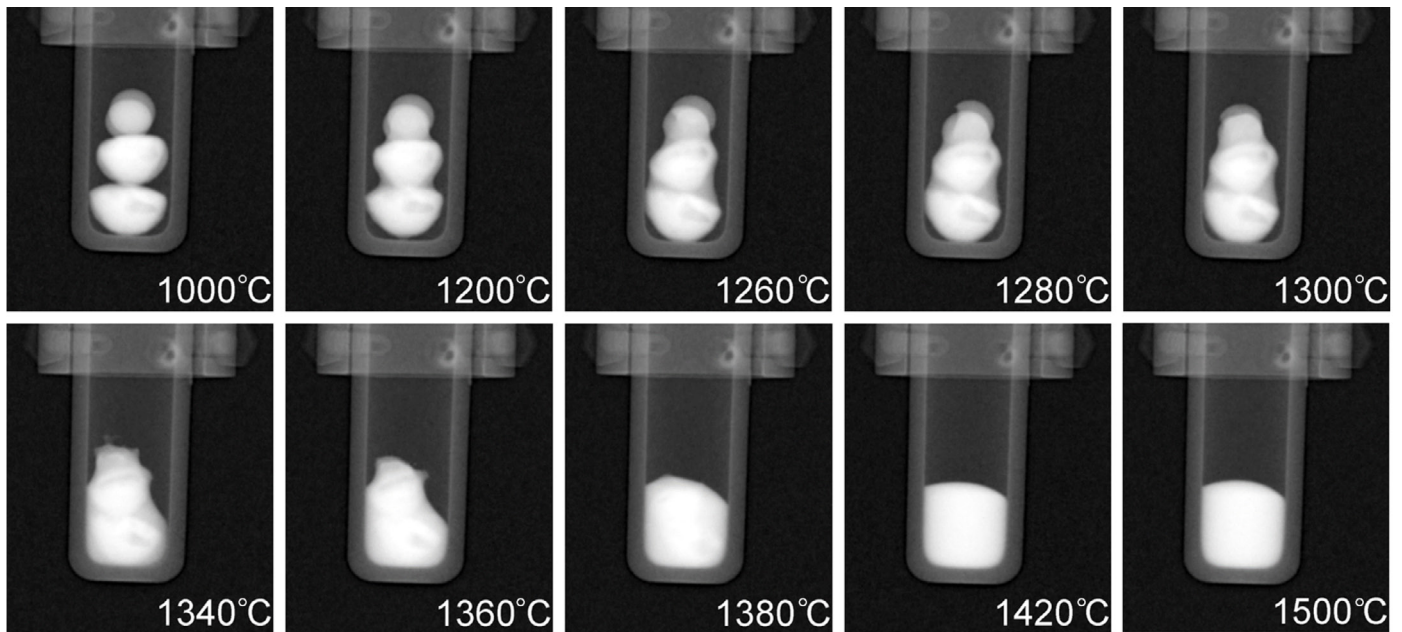

In situ neutron radiography of high entropy alloy mixing at increasing temperatures. Image reproduced from, Derimow, N.; Santodonato, L.J.; MacDonald, B.E.; Le, B.; Lavernia, E.J.; Abbaschian, R. In-Situ Imaging of Molten High-Entropy Alloys Using Cold Neutrons. *J. Imaging* 2019, 5, 29.

Technical Data

System Specifications •²

Sensor Type	Large area, Front-illuminated sCMOS
Array Size	4128 (W) x 4104 (H)
Pixel Size	12 x 12 μm
Image Area	49.5 mm x 49.2 mm (69.9 mm diagonal)
Readout Modes	Rolling Shutter and Global Shutter
System window type	AR coated UV grade fused silica window (>98% transmission)
Interface	CoaXPress (4 Lane CXP-6)
I/O	Fire Row1, Fire Row N, Fire All, Fire Any, Arm, Shutter, Ext Trigger
Trigger Modes	Internal, External, External Start, External Exposure, Software

Advanced Performance Specifications •²

	Rolling Shutter	Global Shutter
Dark Current • ⁴	0.35 e ⁻ /pix/sec (@ 0°C) 0.08 e ⁻ /pix/sec (@ -10°C) 0.03 e ⁻ /pix/sec (@ -30°C)	0.5 e ⁻ /pix/sec (@ 0°C) 0.15 e ⁻ /pix/sec (@ -10°C) 0.065 e ⁻ /pix/sec (@ -30°C)
Read Noise (e ⁻) median	2.9 e ⁻	4.3 e ⁻
Active area pixel well depth	80 000 e ⁻	
Peak QE • ⁵	61% (@ ~ 600 nm)	
Photon response non-uniformity (PRNU)	< 0.5% (@ half well depth)	
Region of Interest	User-definable, 1 pixel granularity	
Linearity • ⁶	> 99.7%	
Data Range	16-bit	
f-number	0.35 (Cone Angle 110°)	

Cooling Options and Specifications •³

Balor-X is available as a Flexi Cooled model. Flexi offers both air and liquid cooling capability, with a liquid cooling temperature of -30°C. During air cooling, the user must be aware of the ambient air temperature and altitude at which the camera is operated as both will have an impact on the extent of sensor cooling. The table below offers a guide to selecting the available sensor cooling set points under different environmental conditions. The table also shows the recommended liquid temperature with minimum flow rate of 2 L·min⁻¹ in order to achieve -30°C sensor temperature.

Sensor Temperature (Cooling Method)		
-30°C (Liquid)	-10°C (Air)	0°C (Air)
Liquid cooling (recommended coolant temperature)	Air Cooling (maximum ambient air temperature)	
16°C	25°C	30°C

QE Curve and Scintillator Peak Emission

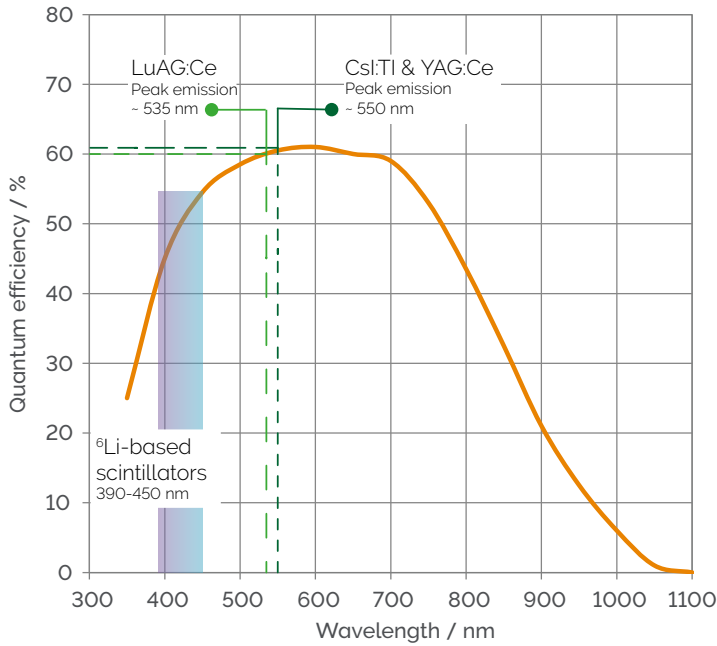

Frame Rates

Imaging ROI: Rolling Shutter [Global Shutter]

ROI Size (W x H)	Max Frame Rate (fps)	
	16-bit (100% Duty Cycle*)	16-bit
4128 x 4104	54 [34]	44 [34]
2048 x 2048	108 [68]	88 [68]
1920 x 1080	205 [126]	167 [127]
1024 x 1024	216 [132]	176 [134]
512 x 512	431 [252]	350 [258]
128 x 128	1684 [785]	1337 [840]

Flexible Connectivity

- 1 CoaXPress**
CoaXPress (4 lane) offers the highest speed data interface
- 2 I/O (TTL / Logic)**
Connector type: D-type, provided with SMB - BNC cable
Fire (Output), External Trigger (Input), Shutter (Output), Aux Out 1*,
Aux Out 2* and ARM*. * Requires optional 7-way cable.
- W Water Cooling**
Connection to recirculator or other water/liquid cooling system
- P Power**
Connection to PSUs refer to power requirements on page 12

Notes: Ensure 100 mm clearance around camera vents (Flexi model only) and power supply vents.

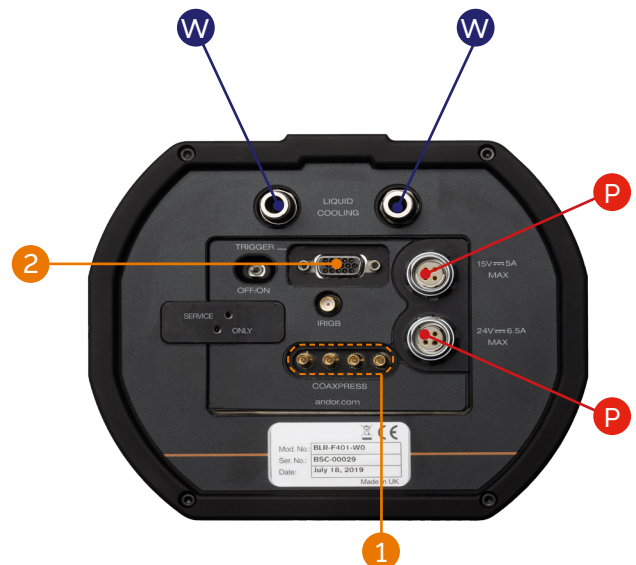

Creating the Optimum Product for You



BLR- F401 - F

Step 1. Choose the sensor type option

There is one sensor type available for the Balor-X 17F-12:

Description	Code
16.9 Megapixel Front-illuminated sCMOS camera	F401

Step 2. Choose the cooling option

Description	Code
Flexi Cooling model (liquid or air) (cooling -30°C with liquid coolant; cooling -10°C with air cooling)	F

Step 3. Select the required software

Balor-X 17F-12 requires at least one of the following software options:

- Solis for Imaging** 64-bit enabled application for Windows (8, 8.1 and 10), offering complete functionality for data acquisition and processing. AndorBasic provides macro language control of data acquisition, processing, display and export.
- Andor SDK Andor SDK3** A software development kit that allows you to control the Andor sCMOS cameras from your own application. Available as 64-bit libraries for Windows (8, 8.1 and 10) and Linux. Compatible with C/C++, LabView and Matlab.
- Linux:** Linux CentOS 7.5 64-bit (with kernel version no higher than 4.6)

Step 4. Select accessories

Description	Order Code
*Trigger cable, D-type to BNC, 7-way multi I/O timing interface cable gives access to all I/O functions.	ACC-ACZ-05612
*CoaXPress cable: 25 m (4x cable composite)	ACC-ASE-14327
*CoaXPress cables: 30 m cables (set of 4x individual cables supplied)	ACC-ASE-14330

CSR *Please contact your local sales representative regarding other options such as different cable lengths, mounting types, camera window options or other customizations you may require for system integration or your specific application.

Have you found what you are looking for?

Need more sensitivity? (a) Back-illuminated CCD iKon-L or large area iKon-XL offer large field of view, 95% QE at ~550 nm and low read noise ideal for maximising signal-to-noise in low photon fluxes scenarios. (b) The [Marana 4.2-11](#) back-illuminated sCMOS also provides 95% QE at ~550 nm and low read noise but is better suited to faster transient phenomena or tomography analysis.

Need a larger dynamic range? (a) The [iKon-XL 231](#) with CCD 231-84 sensor offers down to 2 e- read noise and 350,000 e- well depth. (b) For high dynamic range at faster frame rates, the Marana sCMOS can measure small image contrasts across a wide range of signal magnitude typically found in Absorption Imaging.

Need higher spatial resolution? The [Neo](#) and [Zyla](#) sCMOS cameras offer sensors with 6.5 µm pixel pitch.



Mechanical Drawings

Dimensions in mm [inches]

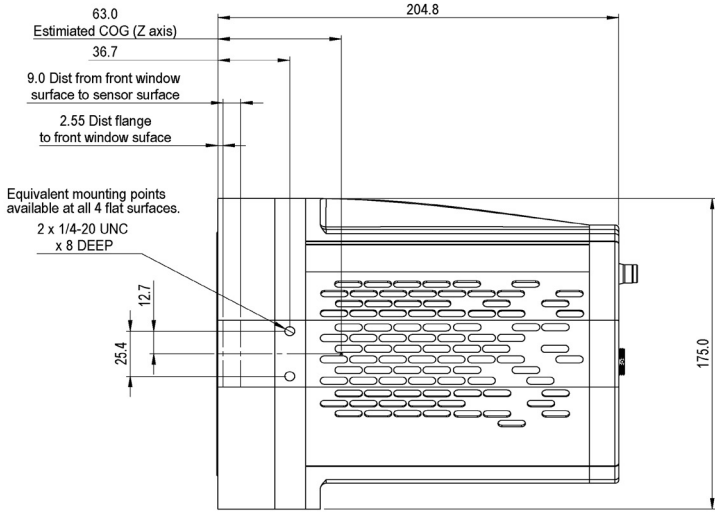
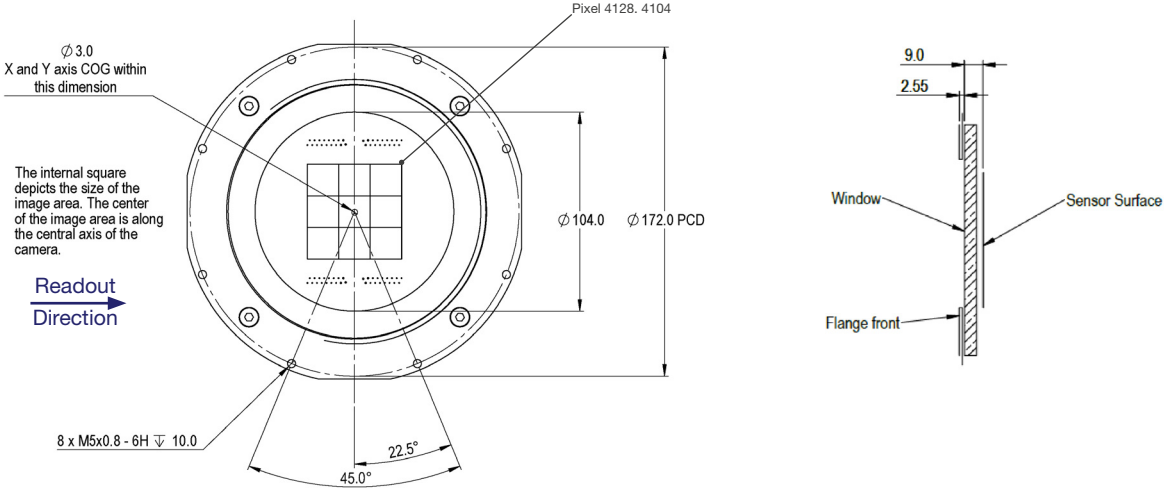

Weight (approx):
Flexi Cooled: ~9 kg

Abbreviation	Meaning
COG	Centre of Gravity
PCD	Pitch Circle Diameter
UNC	Unified National Coarse Thread Standard

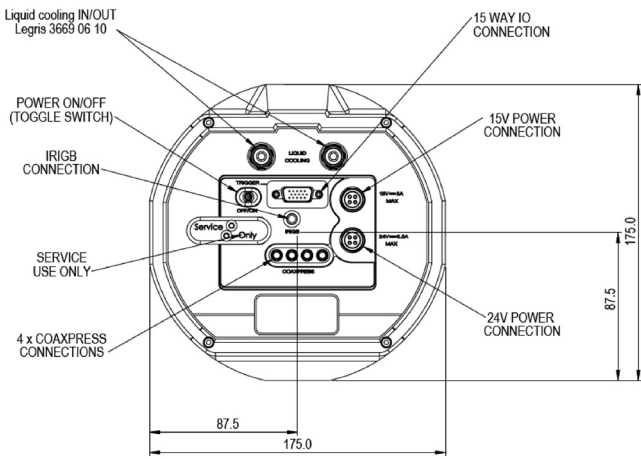

Order Today

Need more information? At Andor we are committed to finding the correct solution for you. With a dedicated team of technical advisors, we are able to offer you one-to-one guidance and technical support on all Andor products.

For a full listing of our local sales offices, please see: andor.com/contact

Our regional headquarters are:

Europe

Belfast, Northern Ireland
Phone +44 (28) 9023 7126
Fax +44 (28) 9031 0792

Japan

Tokyo
Phone +81 (3) 6732 8968
Fax +81 (3) 6732 8939

North America

Concord, MA, USA
Phone +1 (860) 290 9211
Fax +1 (860) 290 9566

China

Beijing
Phone +86 (10) 5884 7900
Fax +86 (10) 5884 7901

Items shipped with your camera

- 1x Cyton-CXP card
- 1x CoaXPress cable (3 m)
- 1x Trigger cable (BNC to SMB: 2 m)
- 1x Trigger cable (3-way, D-type to BNC: 1.5 m)
- 2x Country specific power cords
- 2x PSU (15 V: 1.5 m, 24 V: 1.2 m)
- 1x User manuals in electronic format
- 1x Quickstart guide
- 1x Individual system performance booklet

Footnotes

1. Assembled in a state-of-the-art facility, Andor's UltraVac™ vacuum process combines a permanent hermetic vacuum seal (no O-rings), with a stringent protocol and proprietary materials to minimize outgassing. Outgassing is the release of trapped gases that would otherwise degrade cooling performance and potentially cause sensor failure.
2. Figures are typical and target specifications and therefore subject to change.
3. Specified minimum temperature with coolant assumes coolant temperature of 16°C at a flow rate of 2 litres per minute, measured at the camera head. Air cooling performance is at the ambient temperature listed. Note that cooling performance may be affected by the distance between camera head and coolant system.
4. Dark current are typical median values, measurement is averaged over the sensor area excluding any regions of blemishes.
5. Quantum efficiency as supplied by the sensor manufacturer.
6. Linearity is measured from a plot of Signal vs. Exposure Time as per EMVA 3.0.
7. 100% duty cycle, after each row is read out, the next exposure is immediate.

andor.com

Minimum Computer Requirements:

- 3.0 GHz quad core processor or equivalent
- 16 GB RAM
- Hard drive: 3 GB/sec or greater write speed recommended for the data rate associated with the max. frame rates. 200 MB free hard disc to install software
- x8 PCIe Gen 2 slot
- Windows (8, 8.1 and 10) or Linux 64-bit OS

Operating & Storage Conditions:

- Operating Temperature: -30°C to +30°C ambient
- Operating Altitude: up to 6000 m
- Relative Humidity: <70% (non-condensing)
- Storage Temperature: -30°C to 50°C

Power Requirements:

- 100 - 240 VAC, 50 - 60 Hz
- Power Consumption: 236 W max

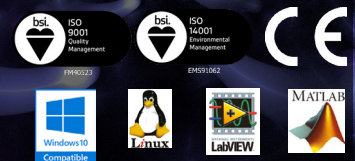

Windows is a registered trademark of Microsoft Corporation.
Labview is a registered trademark of National Instruments.
Matlab is a registered trademark of The MathWorks Inc.