

Vision Measuring Machine with Micro-Form Scanning Probe MiSCAN Vision System



A multiple sensor microscopic-form measurement system, using combined technologies of coordinate and vision measurement system technology.

MiSCAN Vision System



Highly accurate autonomous scanning covering micro-form to large workpieces

The newly developed MPP-NANO probe can use styli as small as 125 μm diameter to achieve measurement of microscopic workpieces. Using the observation camera, setup of measurement can be easily achieved while also checking for dirt and scratches on the workpiece. The highly proven SP25M scanning probe is also supported to allow small- and large-sized workpieces and features to be measured.

Vision measurement functions provide high-level performance

The system utilizes the same image head as the Quick Vision series, Mitutoyo's best-selling vision measuring system. The Quick Vision Apex lighting system is also incorporated, providing multiple lighting functions and excellent evaluation software to provide high performance.



Vision Measuring Machine with Micro-Form Scanning Probe
MiSCAN Vision System

The MiSCAN is well suited for micro-form measurement

The MiSCAN system is the ideal hybrid measuring machine with vision head and scanning probe (MPP-NANO, SP25M). The image head enables precise positioning and targeting measurement even in locations where visual checking is difficult.

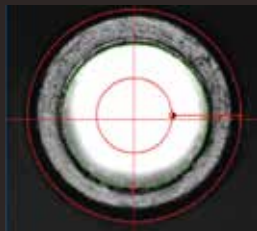

Precise positioning by monitoring the image

Measurement using MPP-NANO stylus

With the **MPP-NANO** stylus, an observation unit is included. When using the extra small 0.125mm diameter stylus, checking on the monitor provides the operator a safe approach to the targeted measuring area.

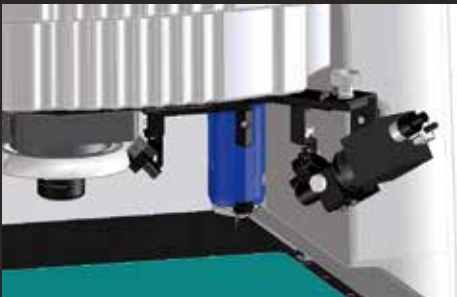

A magnetic kinematic joint connection enables easy stylus replacement. **MPP-NANO** stylus replacement tools are included as standard equipment.

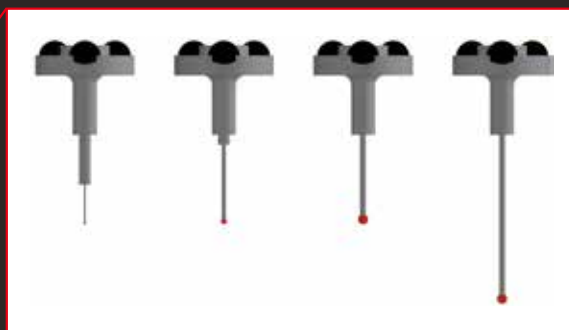

In recent years, the need for fine-detail processing technology has been rapidly increasing, including measurement of the sensing technology essential for vehicle motorization and autonomous driving. Simultaneously, enabling high-accuracy, high-throughput measurement of microscopic form is required. Mitutoyo has responded quickly to these needs, and started selling the Micro Form Measuring System UMAP Vision System some time ago. According to the current need for improving productivity, we have developed the **MiSCAN Vision System**, a measuring system capable of measuring micro form with the **MPP-NANO**, a small diameter scanning probe.

Examples of micro-form measurement achieved with the MiSCAN Vision System and MPP-NANO

Microscopic gear teeth

Conventionally, highly efficient scanning of microscopic gear teeth has been difficult. However, using the **MiSCAN Vision System** together with the **MPP-NANO** we can provide this functionality. Simply enter each nominal using **GEARPAK**, Mitutoyo's gear teeth evaluation software, to easily evaluate the tooth profile error and tooth trace error.



Module 0.8 master gear measurement

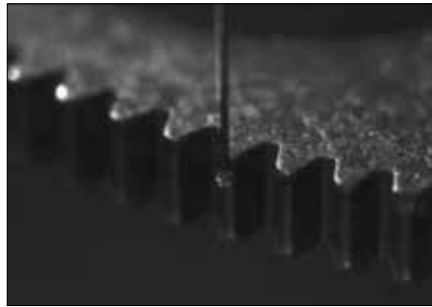

Measurement using the **MPP-NANO**
0.125-mm-diameter stylus

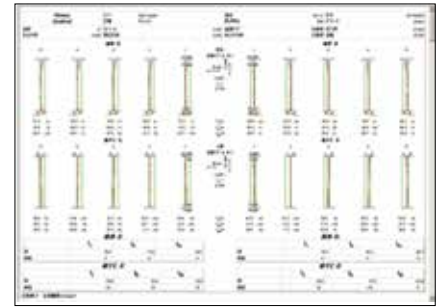

GEARPAK-Cylindrical analysis

Lenses and optical tubes

The **MiSCAN Vision System** and **MPP-NANO** enables high-accuracy, highly efficient measurement of miniature optical Tubes used in micro camera arrays. The **MPP-NANO** can also measure the contour of high degree aspheric lenses used in the vehicle-mounted camera with high accuracy.

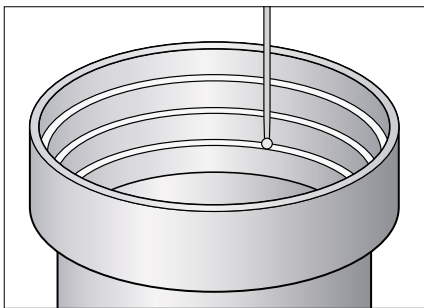

Optical tube



Aspheric-form **MPP-NANO** measurement



SCANPAK form analysis example

Precision molds

The **MiSCAN Vision System** and **MPP-NANO** enable scanning measurement of microscopic feature detail, such as precision punches and dies, using extra-small-diameter styli, which are available with diameters as small as 0.125 mm.

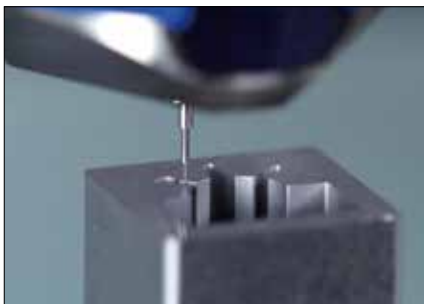

MPP-NANO mold scanning

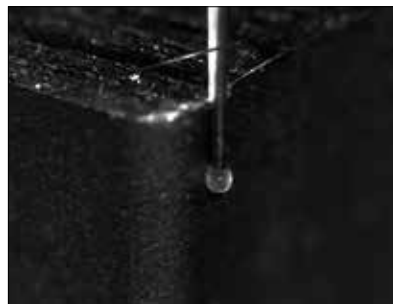

Image seen using the stylus observation
camera unit



SCANPAK form-analysis example



Precision mechanical parts

The **MiSCAN Vision System** and **MPP-NANO** enable highly efficient, high-accuracy measurement of miniature mechanical parts that improve precision in industrial machinery.



Precision mechanical parts (linear guide)

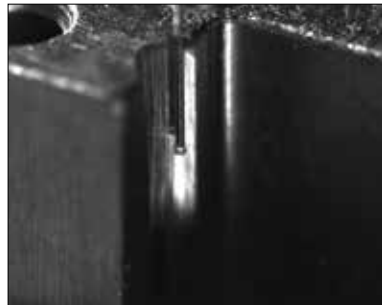

Image seen using the stylus observation camera unit



SCANPAK form analysis example

Micro-hole measurement

Conventionally, only destructive measurement was possible for the inner diameter of nozzles and draw dies. However, the **MiSCAN Vision System** and **MPP-NANO** now enables scanning measurement using the stylus on holes with a maximum aspect ratio of 17:1.

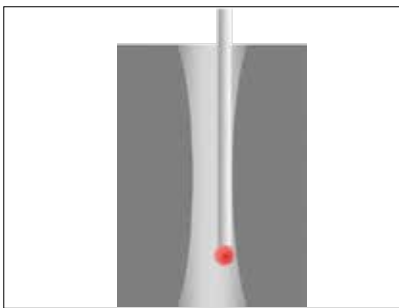

Maximum aspect ratio: 17:1 (for R500-125-85)



MPP-NANO micro-hole measurement

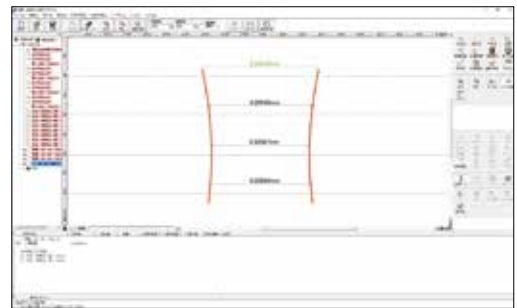

FORMTRACEPAK-AP analysis results

Fine detail contour analysis

Optional CAT1000S software enables nominal scanning measurement and form evaluation of micro V-grooves and rectangular grooves.

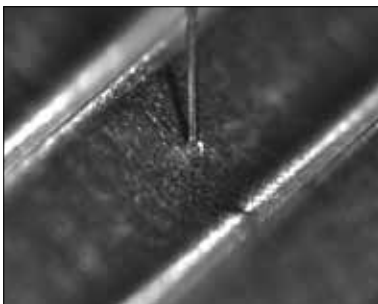

Micro V-groove

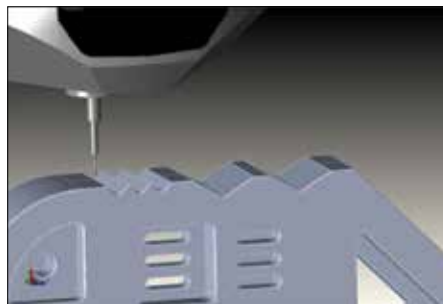

Creating nominal sections from CAD data (CAT1000S)

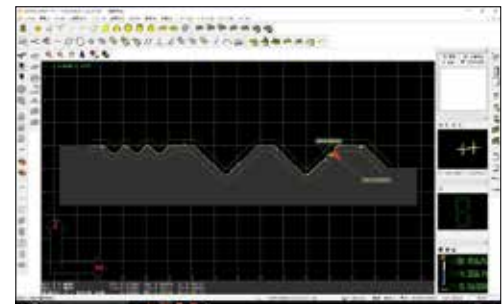

SCANPAK design value verification

MiSCAN Vision System



Specifications

Model		MVS Hyper 302	MVS Hyper 404	MVS 404 Apex
Measuring range	Image	11.8x7.9x7.9" / 300x200x200 mm	15.7x15.7x9.8" / 400x400x250 mm	
	MPP-NANO/SP25M	6.9x7.9x7.9" / 175x200x200 mm	10.8x15.7x9.8" / 275x400x250 mm	
Minimum reading/Scale unit		0.02 μm/Linear encoder		0.1 μm/Linear encoder
Image sensor		B&W CCD camera		
Observation unit		Power turret (1X-2X-6X)		
Illumination unit		Co-axial light, transmitted light, PRL (programmable ring light)		
Contact type probe		MPP-NANO/SP25M	Only SP25M	
Measurement accuracy* ¹ [μm]	Image* ²	E1x, E1y	0.8+2L/1000	
		E1z	1.5+2L/1000	
		E2xy	1.4+3L/1000	
	MPP-NANO	E _{OMPE}	1.9+4L/1000	—
	SP25M	E _{OMPE}	1.9+4L/1000	2.5+6L/1000
Scanning accuracy [μm]	MPP-NANO	0.6	—	
	SP25M	MPE _{THP}	2.5	2.7
Probing accuracy [μm]	MPP-NANO	0.6	—	
	SP25	P _{FTU, MPE}	1.9	2.2
Repetitive accuracy [μm]	MPP-NANO	0.05	—	
Accuracy guaranteed temperature	Ambient temperature	18 - 23 °C		
	Temperature variation	0.5 °C/1 H and 1 °C/24 H		
Size of stage glass		15.7x10.7" / 399x271 mm	19.4x21.7" / 493x551 mm	
Max. mass of workpiece* ³		33lbs / 15 kg	66lbs / 30 kg	88.2lbs / 40 kg
Dimensions		33.8x37.4x63.3" / 859x951x1609 mm	40.4x55.4x70" / 1027x1407x1778 mm	
Mass (Including machine stand)		793.7lbs / 360 kg	1,276.5lbs / 579 kg	

*1 Accuracy-guaranteed machines conforming to ISO10360-7:2011 are also supported.

*2 Image accuracy using a QV-HR 2.5X objective and 2X tube lens.

*3 Except at limits of stage displacement or concentrated loading.

Note: CNC Vision Measuring Systems in this brochure incorporate a main startup system (relocation detection system) that disables operation when an unexpected vibration occurs or the machine is relocated. Be sure to contact your nearest Mitutoyo Sales Office prior to relocating your machine after initial installation.

MPP-NANO For MVS-H302

The world's most compact and accurate scanning probe

- Styli as small as a 0.125 mm-diameter are available for scanning measurement of fine-detailed features.
- Deep grooves and deep holes can be measured at the maximum aspect ratio of 17:1 (ø500L8.5).
- High accuracy form measurement is enabled by achieving high repeatability: $\leq 0.05 \mu\text{m}$ (**MVS-H302**).
- The measuring force is as low as approximately 1 mN. Therefore, it will not scratch or deform the workpiece.
- The stylus can easily be replaced thanks to the magnetic joint connection.
- The stylus observation unit (optional) enables easy positioning of the stylus tip.

Specifications				
Item name	MPP-NANO stylus, ø125L2	MPP-NANO stylus, ø300L4	MPP-NANO stylus, ø500L4.5	MPP-NANO stylus, ø500L8.5
Model	R125-85-20	R300-85-40	R500-85-45	R500-125-85
Nominal tip diameter	125 μm	300 μm	500 μm	500 μm
Nominal stylus length	2 mm	4 mm	4.5 mm	8.5 mm
Stem diameter	0.08 mm	0.2 mm	0.3 mm	0.3 mm
Aspect ratio	16	13.3	9	17
Tip material	Ruby	Ruby	Ruby	Ruby

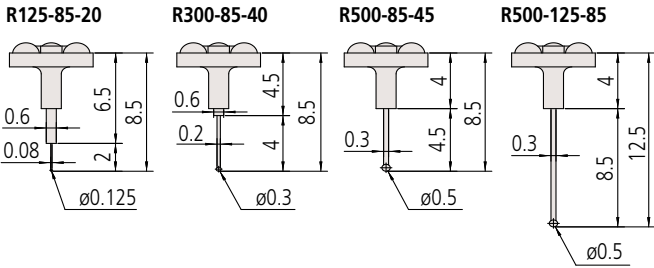

SP25M

Compact, high accuracy scanning probe

- The highly proven SP25 scanning probe used with 3D measuring machines can be used on the MiSCAN.
- Stylus changer FCR25 (optional) handles multiple styli, including one in the horizontal position, and enables automatic stylus changes.
- Captures the target point in high-accuracy point measurement and centripetal aligning point measurement (optional).

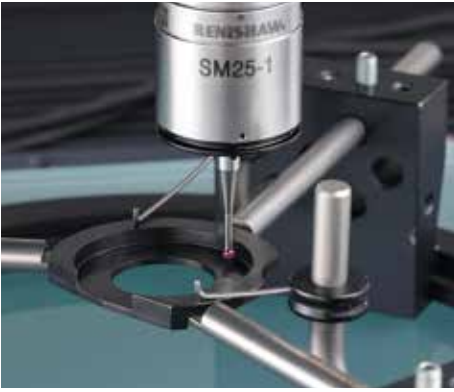

Non-contact measurement (vision measurement)

The **MiSCAN Vision System** is equipped with an optical observation system and an illumination unit of the **QUICK VISION** measuring system. It can perform as a high-level vision measuring system.



VISIONPAK-PRO

High-level vision measurement functions are equipped, including a one-click tool that enables easy edge detection; a dual-area contrast tool that automatically recognizes optimal illumination; and filters (morphology filter) that enable highly accurate edge detection.

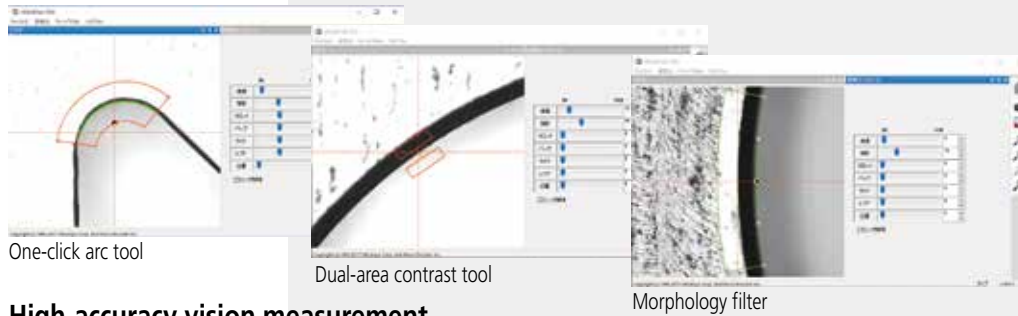

High-accuracy vision measurement

High-accuracy edge detection is performed using the image obtained by the image sensor.

Programmable power turret

The observation unit uses a high-resolution programmable power turret with high magnification repeatability.

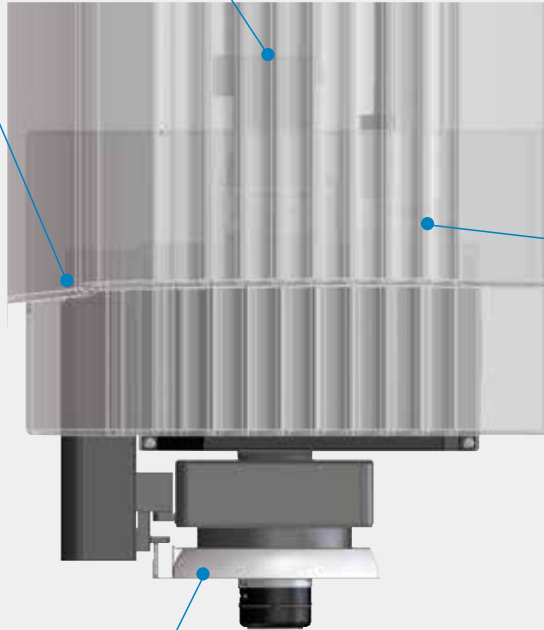
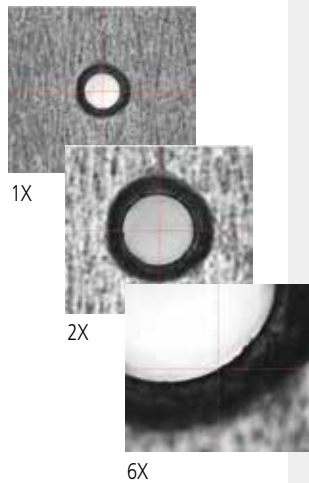
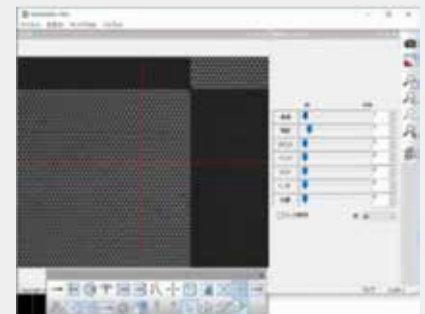

Image auto focus

The auto focus enables non-contact high-accuracy height measurement. Pattern focus enabling focusing on transparent and mirror objects is also equipped.



Programmable ring illuminator

A high-function programmable ring illuminator that has the ability to control the irradiation angle and direction is equipped as standard.

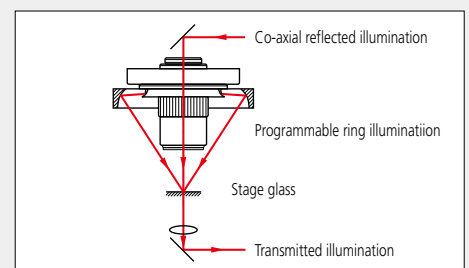
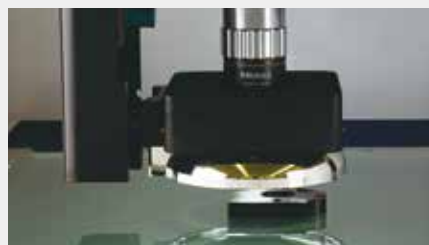
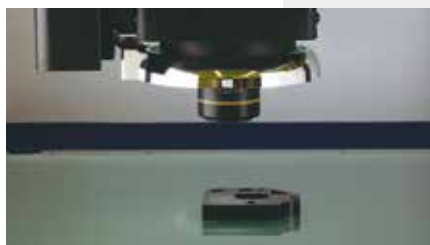



Contact measurement/ Scanning measurement

The **MiSCAN Vision System** uses the main unit controller and software that have long been used in 3D measurement and provides high-level coordinate measurement technology.

MCOSMOS

MCOSMOS has long been used in 3D measurement; in addition to size measurement, it offers very powerful geometric tolerancing functions such as linear contour and plane contour evaluations.

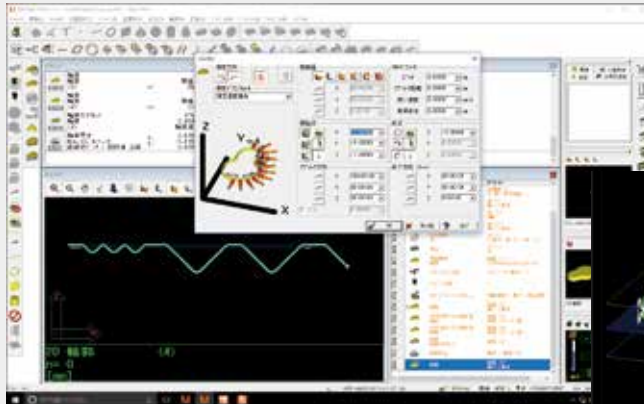

MCOSMOS

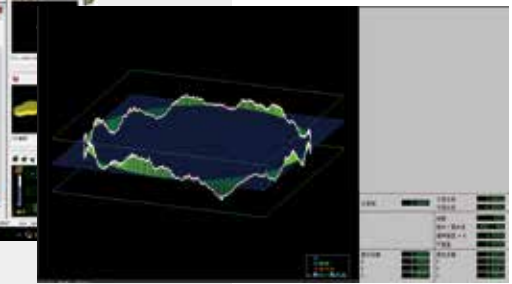

MCOSMOS flatness drawing

SCANPAK

Using contour data obtained by the **MiSCAN Vision System**, nominal verification, best-fit contour construction and more are available in addition to element calculation.

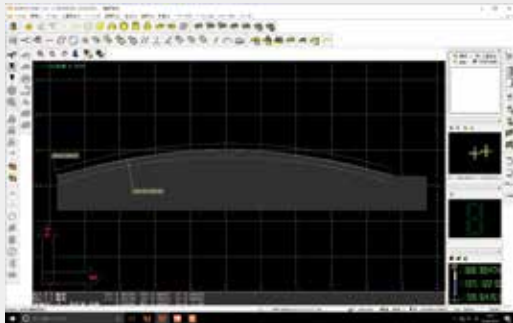

CAT1000S (optional)

Using 3D CAD data, section extraction in the nominal scanning or linear and plane contour evaluations are available.

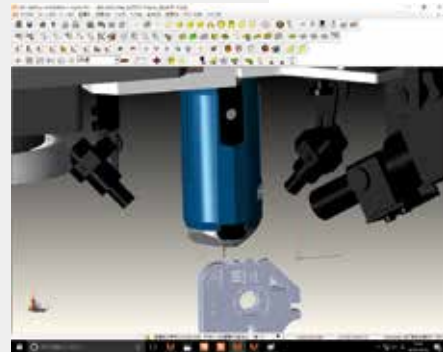

FORMTRACEPAK-AP (optional)

Using data obtained by the **MiSCAN Vision System** enables highly sophisticated analysis including nominal verification, over-pin diameter measurement and arbitrary depth measurement.

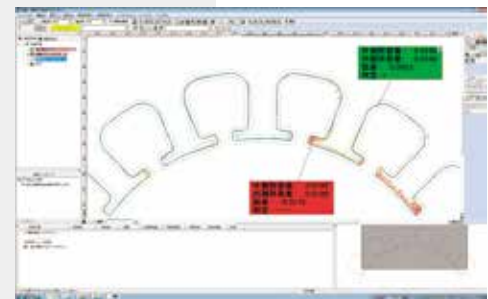
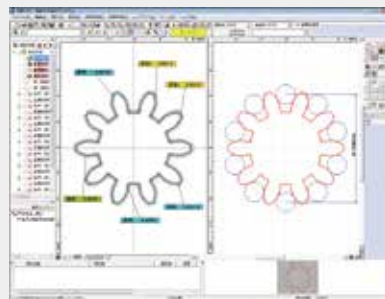
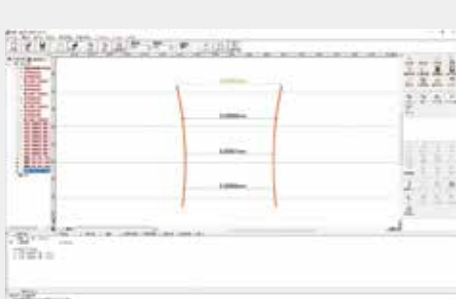

Main options

Objective lens



Objective lens	QV-SL0.5X*	QV-HR1X	QV-SL1X	QV-HR2.5X	QV-SL2.5X	QV-HR5x	QV-HR10X*	QV-10X*	QV-25X*
Order No.	02AKT199	02AKT250	02ALA150	02AKT300	02ALA170	02AWD010	02AKT650	02ALG010	02ALG020
Working distance	30.5 mm	40.6 mm	52.5 mm	40.6 mm	60 mm	20 mm	20 mm	30.5 mm	13 mm
PRO model imaging area [(H5) mm × (V5) mm]	Turret 1X	12.54×9.4	6.27×4.7	2.49×1.86	1.42×0.93	0.62×0.47	0.62×0.47	0.31×0.23	0.25×0.18
	Turret 2X	6.27×4.7	3.13×2.3	1.24×0.93	0.62×0.47	0.31×0.23	0.10×0.07	0.04×0.03	
	Turret 6X	2.09×1.56	1.04×0.78	0.41×0.31	0.20×0.15	0.10×0.07			

* When using a QV-SL0.5X, QV-HR10X, QV-10X or QV-25X objective, partial functional limitations such as insufficient light intensity may occur depending on the target workpiece.

Stylus observation camera unit
For **MPP-NANO**, Order No. 02ATX846A

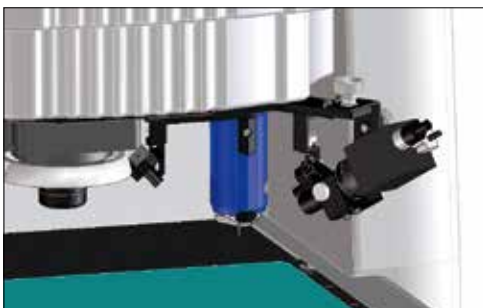

For **FCR25 SP25M**
Order No. 02ATV887



Master ball (ø4) for **MPP-NANO**
Order No. 02ATY823

Master ball (ø16) for **SP25M**
Order No. 02ATY790

Calibration gauge for **MPP-NANO**
Order No. 02ATV821

Calibration gauge for **SP25M**
Order No. 02ATV882

External dimensions and measuring ranges

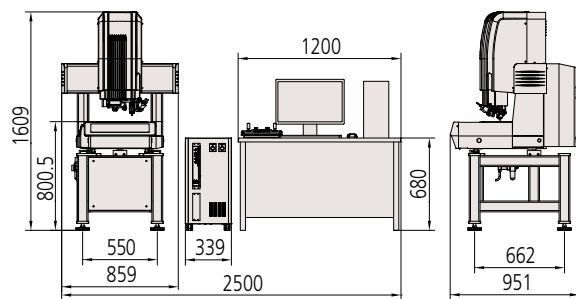

MVS-H302

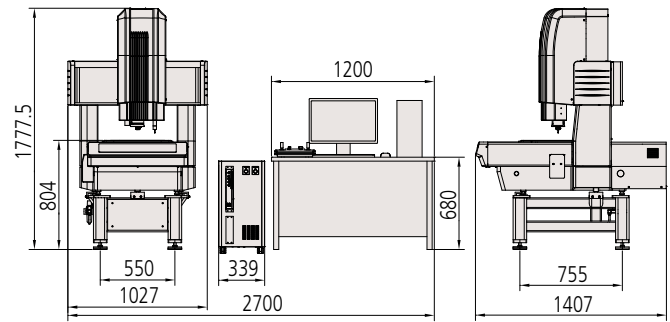

MVS-X404/MVS-X302

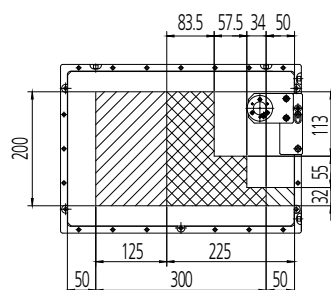

- Common measuring range of image and contact probe
- Contact probe measuring range
- Image measuring range

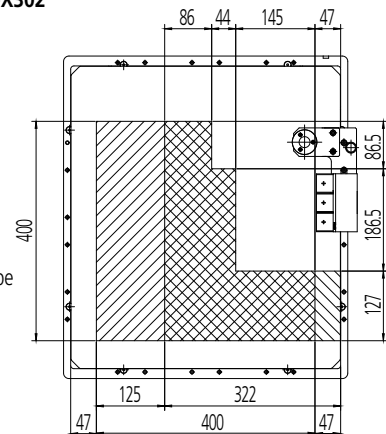

Stage size: **MVS-H302** Contact probe (**MPP-NANO/SP-25M**)

Stage size: **MVS-X404** Contact probe (**SP-25M**)

Excellent reliability

Traceability to national standards

Mitutoyo's calibration artifacts and instruments that are used to establish machine accuracy specifications are maintained in a continuous chain of traceability to national dimensional standards. This is our customers' assurance of reliable measurement.

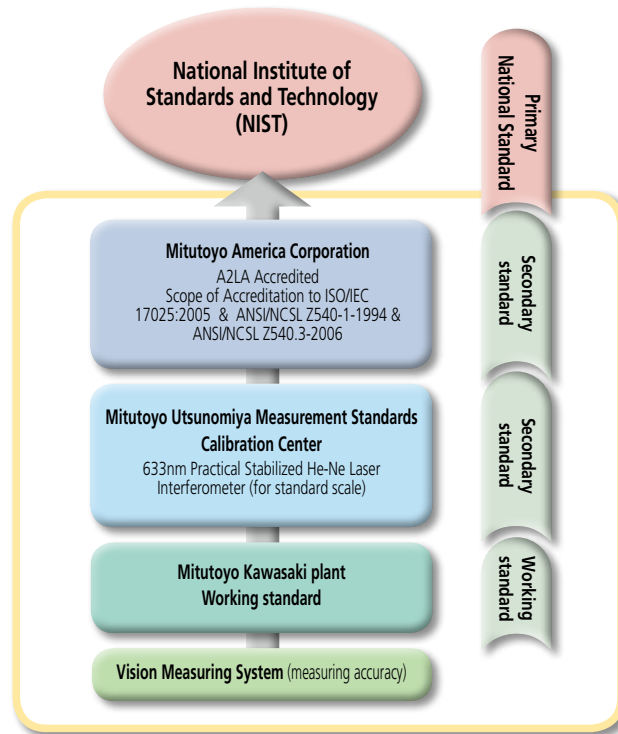

A Global Market Leader

World's top level of global network

Mitutoyo has expanded its market all over the world since the establishment of the first overseas sales company, MTI Corporation (currently Mitutoyo America Corporation) in the USA in 1963. At present, we have R&D, manufacturing, sales, and technical service bases in 29 countries with an agency network connecting over 80 countries.



Company Headquarters in Kawasaki, Japan



Mitutoyo Europe GmbH



Mitutoyo (UK) Ltd.



Mitutoyo France S.A.R.L.



Mitutoyo America Corporation Head Office



Mitutoyo Italiana S.R.L.



Mitutoyo Asia Pacific Pte. Ltd. Regional Headquarters



Mitutoyo Measuring Instruments (Suzhou) Co., Ltd.



MITUTOYO SUL AMERICANA Ltda. Factory (Suzano)



Whatever your challenges are, Mitutoyo supports you from start to finish.

Mitutoyo is not only a manufacturer of top quality measuring products but one that also offers qualified support for the lifetime of the equipment, backed by comprehensive services that ensure your staff can make the very best use of the investment.

Apart from the basics of calibration and repair, Mitutoyo offers product and metrology training, as well as IT support for the sophisticated software used in modern measuring technology. We can also design, build, test and deliver measuring solutions and even, if deemed cost-effective, take your critical measurement challenges in-house on a sub-contract basis.



Find additional product literature
and our product catalog

www.mitutoyo.com

Note: All information regarding our products, and in particular the illustrations, drawings, dimensional and performance data contained in this printed matter as well as other technical data are to be regarded as approximate average values. We therefore reserve the right to make changes to the corresponding designs. The stated standards, similar technical regulations, descriptions and illustrations of the products were valid at the time of printing. In addition, the latest applicable version of our General Trading Conditions will apply. Only quotations submitted by ourselves may be regarded as definitive. Specifications are subject to change without notice.

Mitutoyo products are subject to US Export Administration Regulations (EAR). Re-export or relocation of our products may require prior approval by an appropriate governing authority.

Trademarks and Registrations

Designations used by companies to distinguish their products are often claimed as trademarks. In all instances where Mitutoyo America Corporation is aware of a claim, the product names appear in initial capital or all capital letters. The appropriate companies should be contacted for more complete trademark and registration information.

Mitutoyo

Mitutoyo America Corporation

www.mitutoyo.com

One Number to Serve You Better

1-888-MITUTOYO (1-888-648-8869)

M³ Solution Centers:

Aurora, Illinois (Headquarters)

Boston, Massachusetts

Charlotte, North Carolina

Cincinnati, Ohio

Detroit, Michigan

Los Angeles, California

Birmingham, Alabama

Seattle, Washington

Houston, Texas