

## CNC Vision Measuring System QUICK VISION Pro Series QUICK VISION Series

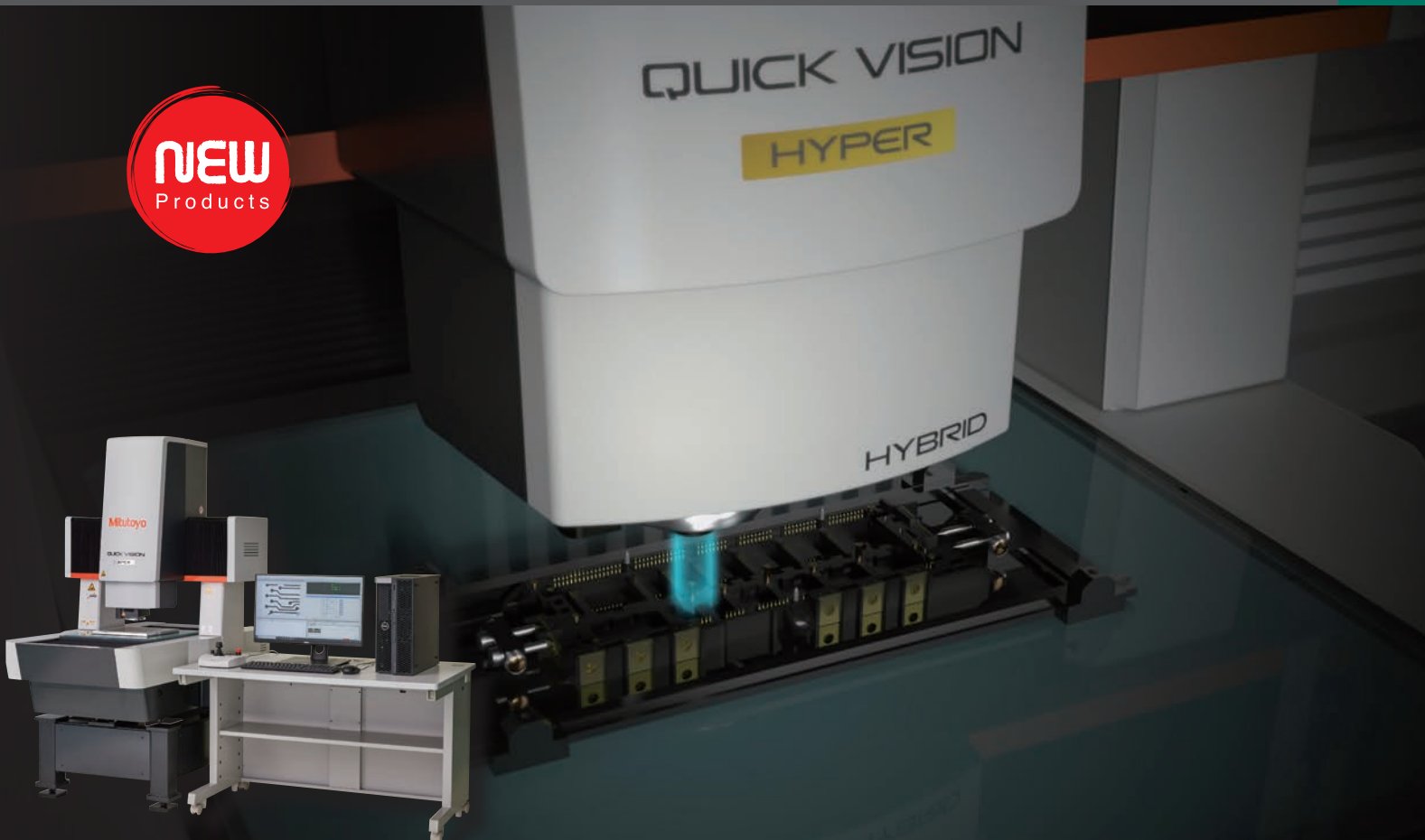

# *Evolutionary Advancement*

## Highly Advanced Non-contact Measurement Technologies

Well-designed main unit structured for high-accuracy measurement and auto focus.

Integration of these high-performance technologies has made 3D non-contact measurement a reality.

The QUICK VISION Pro, our CNC vision measuring machine family, never stops evolving.

## Enables high-throughput measurements required for vision measuring systems

In recent years, the technology surrounding our lives has entered a period of substantial change. Daily updates and technological innovations in motorized vehicles, 5G communications, and IoT technologies are evolving with unprecedented speed.

The QUICK VISION Pro was developed to keep pace with these technological innovations and industrial challenges.

Experience the high-throughput non-contact measurement that Mitutoyo offers.

# MEDICAL

— Three unique Mitutoyo features supporting high reliability 《Medical》

## Ultra-small

### Medical devices requiring high accuracy

Medical devices directly affect people's health and life. Therefore, every part requires strict adherence to demanding accuracy specifications. The lens and forceps of an endoscope, for example, are installed in a tip with a minimum diameter of 3 mm. With a maximum of 4,300X magnification, various types of auto focus, and high resolution edge detection, the QUICK VISION Pro allows you to measure objects without making contact for applications that require accuracy at the most minute level. Its improved repeatability and enhanced technical measurement capabilities adhere to the most stringent global standards.

To respond to the demands of emergency medical care, medical devices need to sustain more requirements. Through improving our measurement technologies in the manufacture of medical devices, Mitutoyo is committed to contributing to the advancement of medical technology.

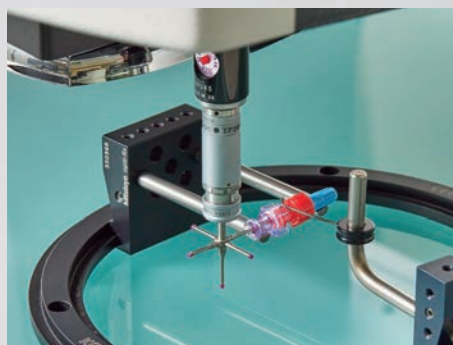

Example of measuring a valve used in medical equipment





### Optimized optical system for ultra-small dimensional measurement

By combining ten different objective lenses with a built-in imaging lens, a maximum of 150X optical magnification (4,300X total on-monitor magnification) can be achieved. This enables measurement of ultra-small parts, such as medical device components.

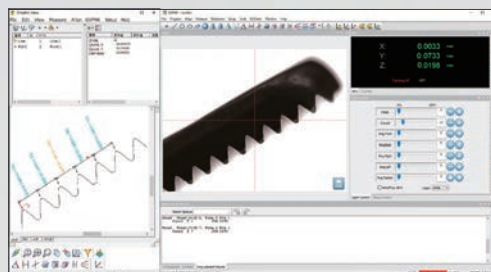

Example of image measurement of medical forceps

### High-accuracy 3D measurement

High-accuracy height measurement using single-focus high-resolution images and PFF (Points From Focus) enable 3D capturing of the object shapes, thereby expanding the scope of measurement.

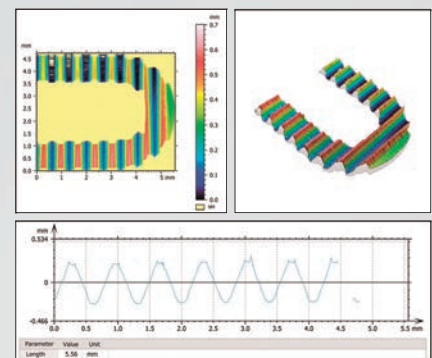

3D analysis of the shape captured by PFF and analyzed with MCubeMap

# AUTOMOTIVE

— Three unique Mitutoyo features supporting high reliability 《Automotive》

## Cutting-edge

### Flexible measurement of new parts for electric vehicles

With increasing demand for reducing greenhouse gas emissions, automobile production is transitioning from gas and diesel vehicles to electric vehicles, shifting the key automotive parts to now change to motors, batteries and semiconductors at an increasingly rapid rate.

The QUICK VISION Pro is optimal for use in the manufacturing processes of, for example, pre-stacking motor core parts that are thin and difficult to touch for measurement, fuel cell separators that have minute surface irregularities and require precise measurement, and semiconductor parts of inverters that require high-speed measurement of microscopic features.

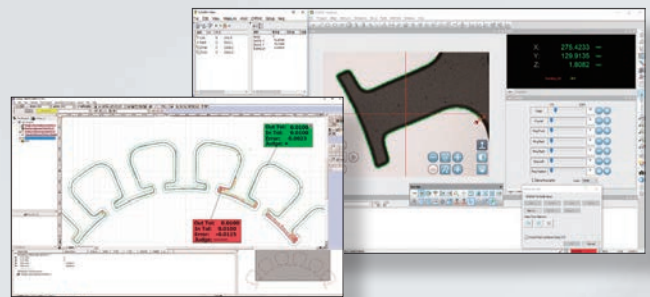

Tolerancing example

### Meeting the rigorous quality control standards of the automobile industry

The introduction of CASE technologies will drive demand for electronic and semiconductor parts in the automotive industry. QUICK VISION Pro offers quality control within the automobile industry by providing both contact and non-contact technologies.



Example of measuring an engine control unit

### Enabling online programming using 3D CAD models

In addition to online programming using 3D CAD models, an offline program can be created from an image or with a touch probe. This makes it possible to increase up-time of the QUICK VISION Pro main unit, thereby shortening production lead times.

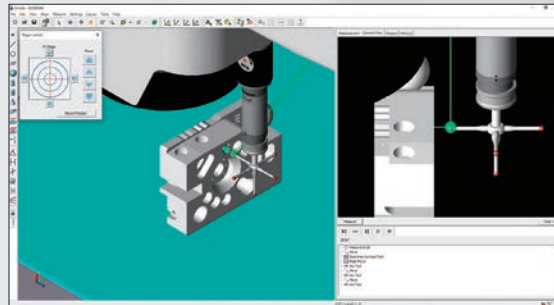

Online programming using 3D CAD models

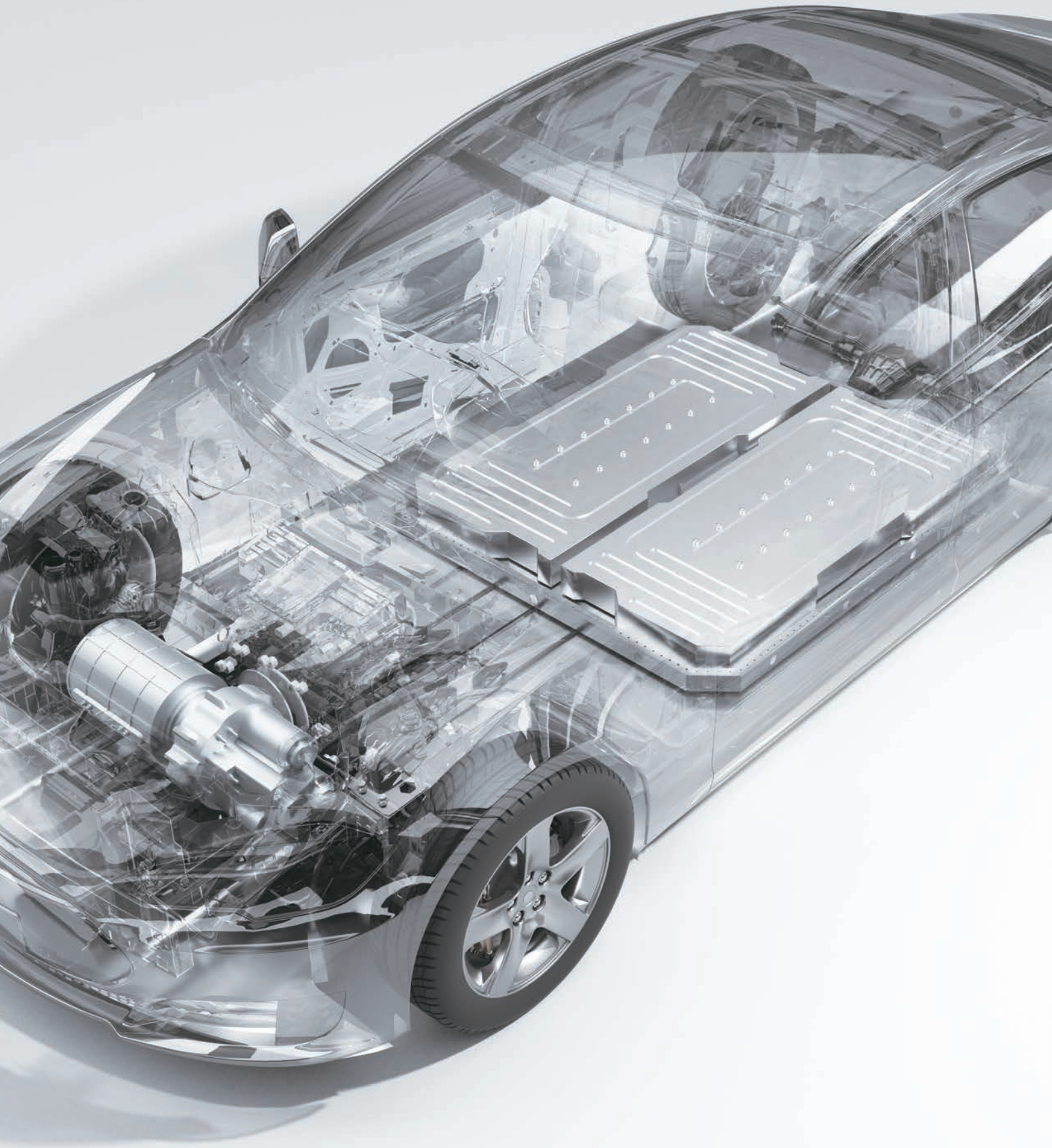

# SEMICONDUCTOR



— Three unique Mitutoyo features supporting high reliability 《Semiconductor》

## Full automation

### Continuous measurement during mass production

The shift of production to electric vehicles, expansion of services promoted by commercialized 5G, and recovery of capital investment in data centers are all growing signs of recovery in the semiconductor market. The market is expected to show more growth and will be prepared for mass production to meet increasing demand. QUICK VISION Pro synchronizes main unit operation with the strobe of the camera used for measuring, therefore providing high-speed measurements to enhance the productivity of semiconductor manufacturing. For example, the stage keeps moving without stopping while the system measures many features on the shower head to check for dimensional errors or foreign substances, which can significantly reduce the cycle time.

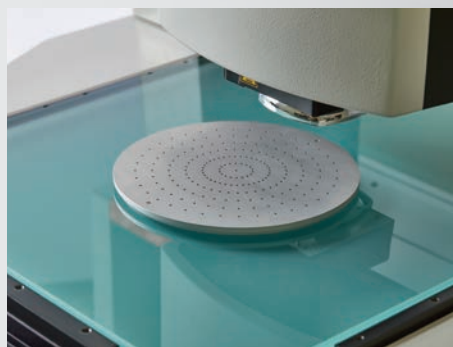

See video from here



### Preventing nonconformities during mass production

Continuous measurement by STREAM and quick focusing by TAF can deliver high-speed measurements. This prevents non-conforming final products by increasing the number of features measured.



### 3D measurement with multiple sensors

Surface texture and cross-section texture can be analyzed by combining vision measurement, the non-contact displacement sensor (laser or chromatic position sensor), PFF (Points From Focus), and WLI (White Light Interferometer).

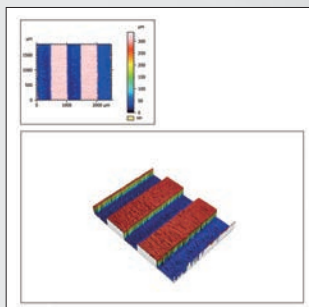

### Flaw Inspection Software DDPAK-QV

DDPAK-QV, defect detection software, allows for detection of contaminants, burrs, cracks, etc., in addition to dimensional measurement. Flaws can be found that cannot be detected by typical dimension measurement.

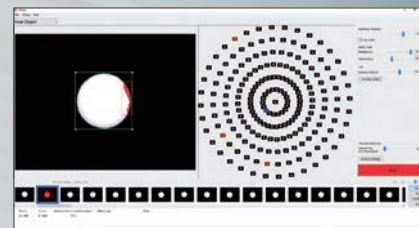

Inspection for foreign substances in shower head diameters



QUICK VISION

HYPER

HYBRID

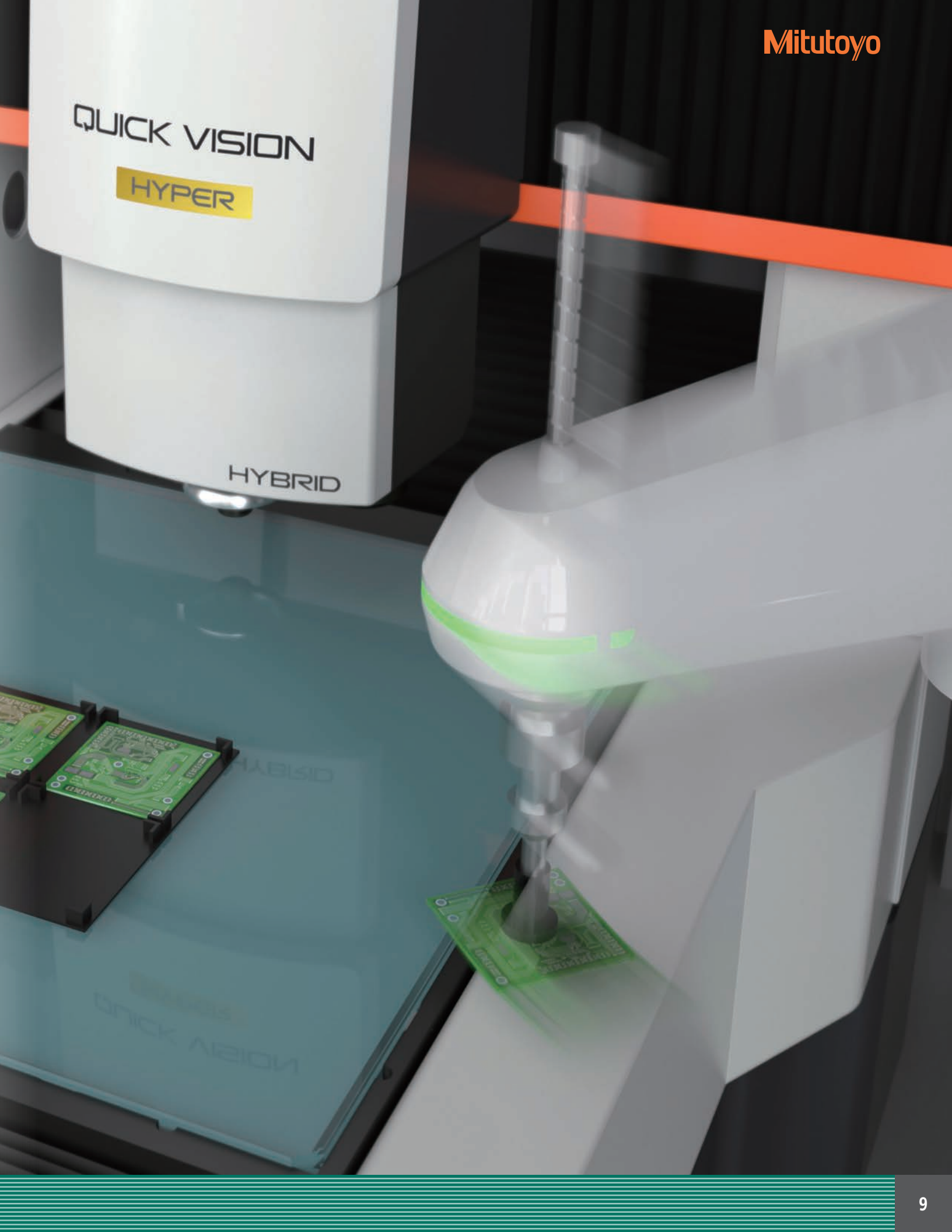

# APPLICATION

## Example of non-stop measurement by STREAM

The high-throughput measurement of QUICK VISION Pro is suitable for measuring position information in the RDL process for semiconductor package FO-PLP. Moreover, rich IO software (optional) means you can easily incorporate automation, such as automatic transfer of workpieces with a SCARA robot, etc.

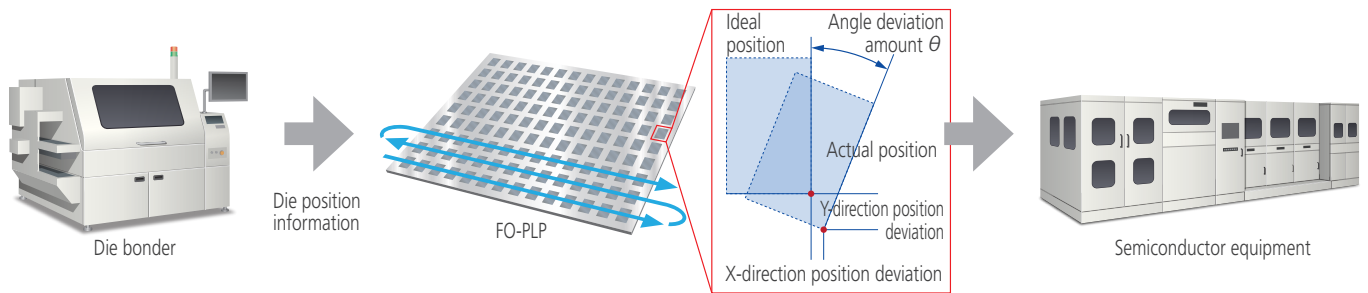
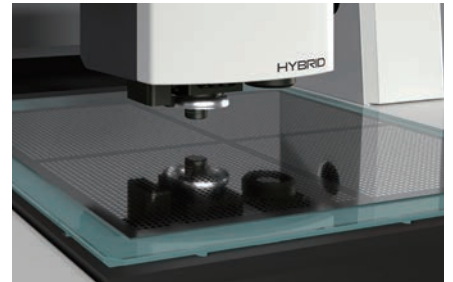

## Example of Z-axis tracking high-throughput measurement

QUICK VISION Pro can deliver high-speed and high-efficiency edge detection, due to the newly developed StrobeSnap function. By utilizing the TAF (Tracking Auto Focus), it can deliver high-speed measurement of an edge that fluctuates in the vertical direction, by tracking the edge automatically.

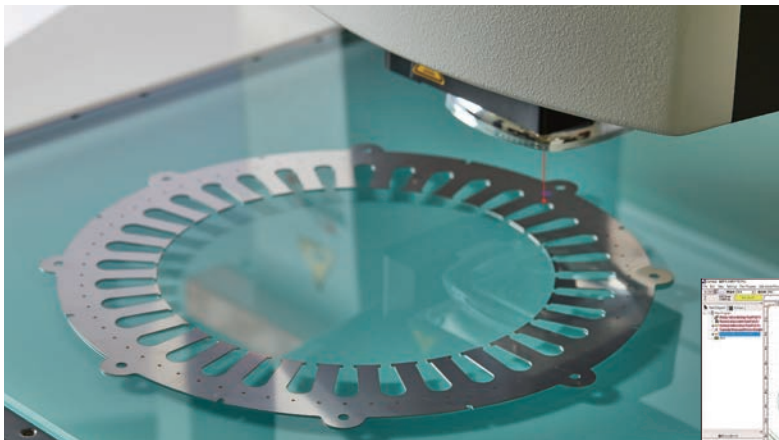

Contour measurement of motor cores for EV

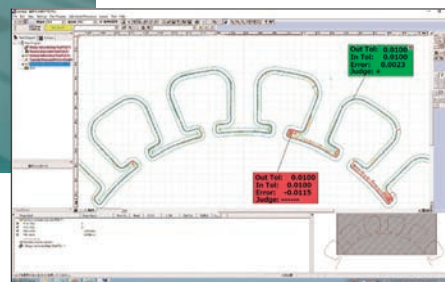
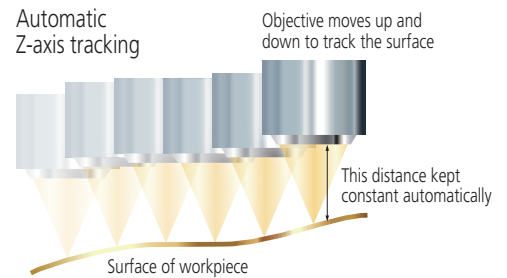

See video from here

## Example of ultra-small 3D shape dimension measurement

QUICK VISION can obtain ultra-small shape dimensions in 2D/3D, due to a wide variety of sensing technologies, such as PFF, WLI, and CPS. For example, when measuring the features of a multilayer board, including wiring line & space, via diameter, and surface roughness measurement, QUICK VISION can take measurements and analyze 3D shapes by using the white light interferometer WLI.

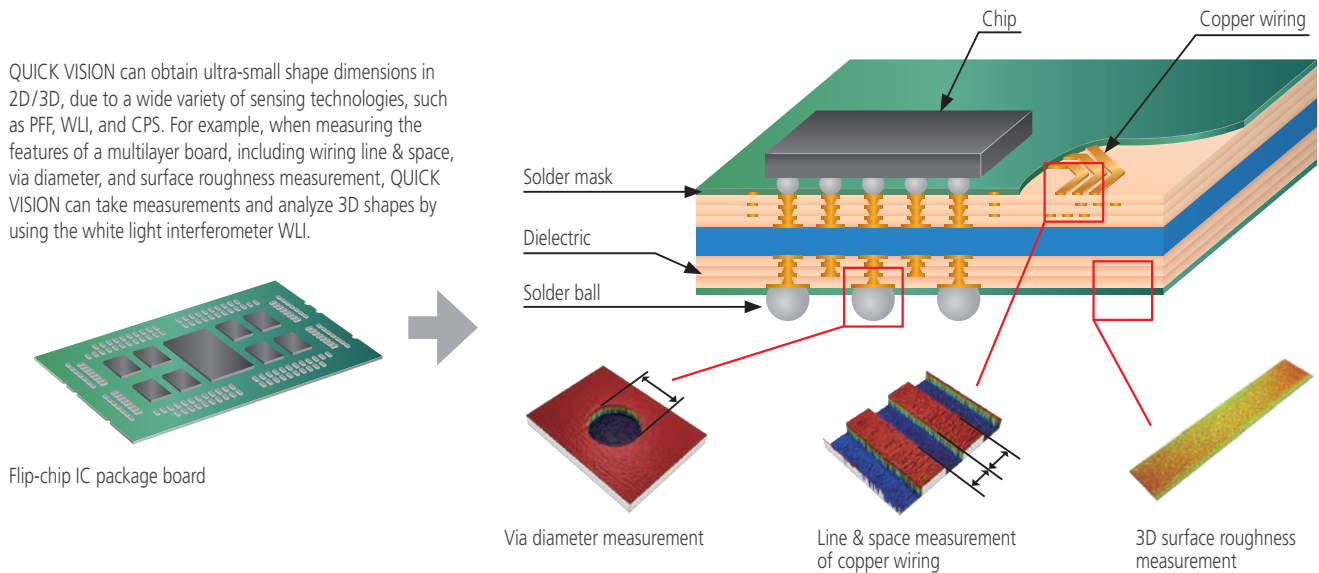

Flip-chip IC package board

## Example of measuring medical device components

When measuring "Medical" components of ultra-small dimensions requiring high "reliability" QUICK VISION Pro is effective in ultra-small workpieces, due to a wide variety of objective lenses. Therefore, even a fine contour that is difficult for conventional contact-type measuring instruments can be measured by PFF, which performs 3D measurement based on image contrasts, and CPS (non-contact displacement sensor).

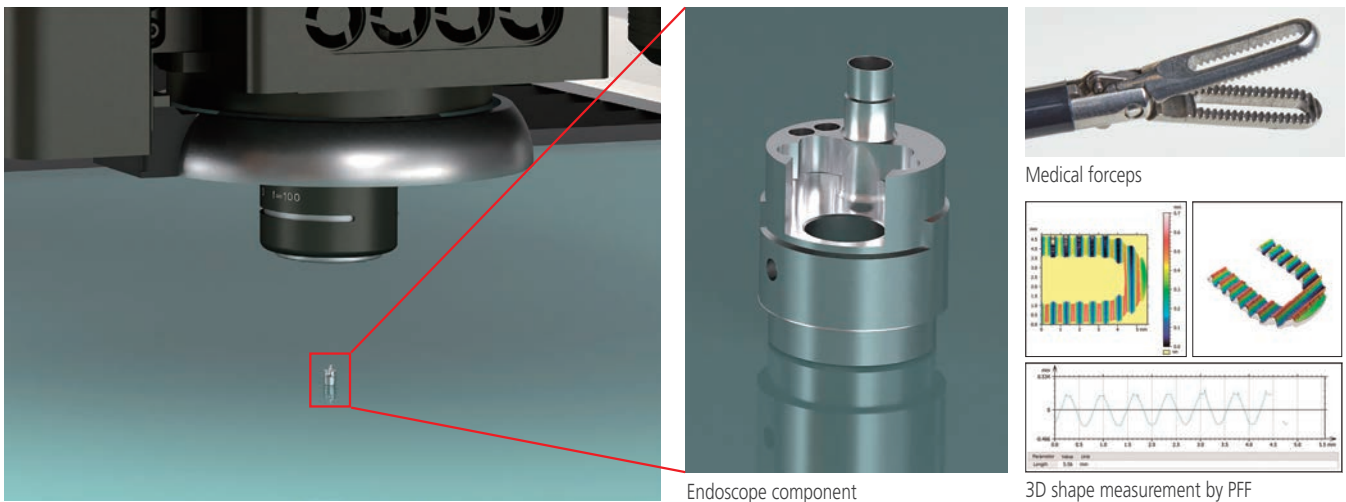

Endoscope component

Medical forceps

3D shape measurement by PFF

# TECHNOLOGY

## Rich functionality supporting various kinds of measurement

The QUICK VISION Pro achieves the high-level integration of the measurement technologies that Mitutoyo has developed over the years. By combining standard objective lenses, special software (QVPAK), and various optional sensors, the QUICK VISION Pro provides a wide range of functions to support various kinds of measurement. While meeting the growing requirements of measurement environments, the QV Pro continues to improve these functions to strongly support solving any challenges.

### 1 StrobeSnap

A magnified image captured through the optical lens is displayed on a PC screen. Various functions including edge detection and auto focus can be used for dimensional measurement (common to all models).

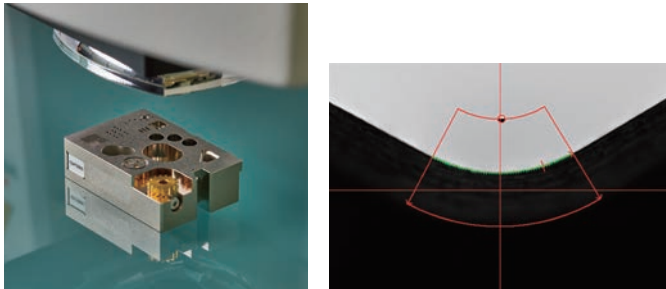

### 2 Measuring a 3D object without repositioning Touch Trigger Probe

By also using the touch trigger probe, the system can capture a 3D object by measuring its sides at a given height without rotating it, something that is difficult with the camera alone.

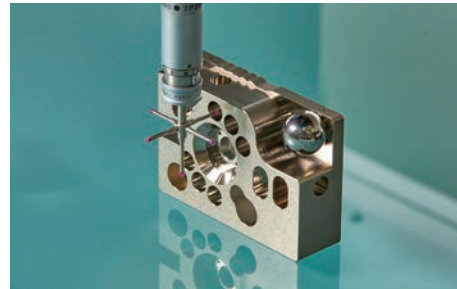

### 3 Non-contact measurement of steep angle surfaces and transparent objects CPS Probe

Differences in the focal length of the white light source are used to measure an angled surface. Additionally, thickness of a thin, transparent object is measured by simultaneous detection of surface heights at two points on the object.

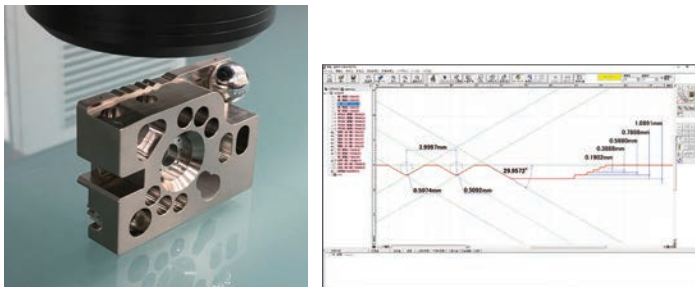

### 4 Capturing microscopic features of a 3D object using white light interference White Light Interferometer

Using the white light interference that occurs between the system and the object, the system performs high-accuracy 3D measurement for surface texture analysis (roughness, etc.) and shape measurement (irregularities of several  $\mu\text{m}$ ) in a minute area.

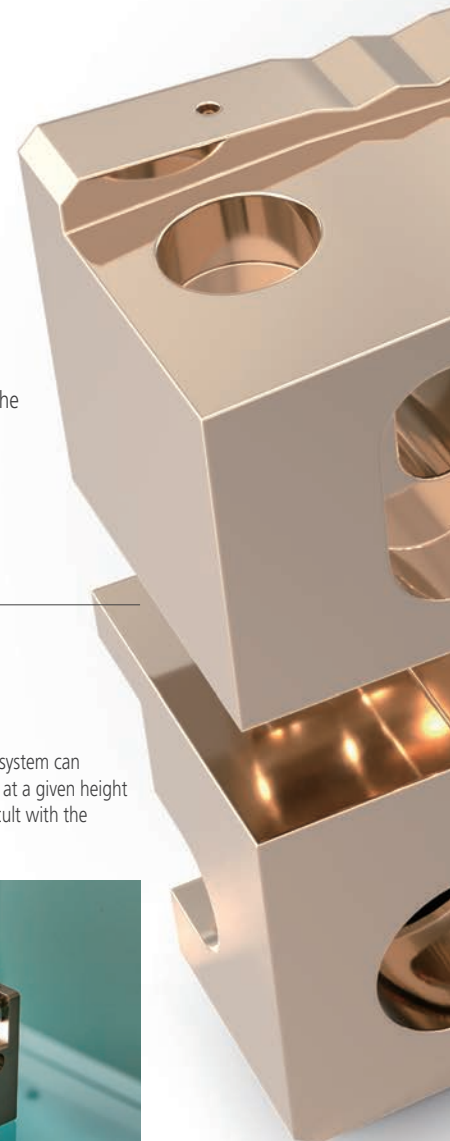
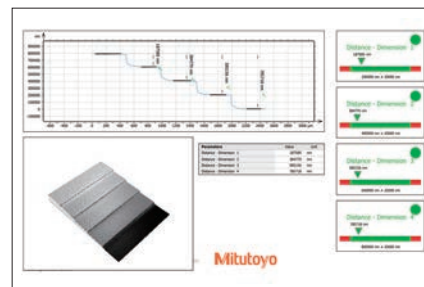

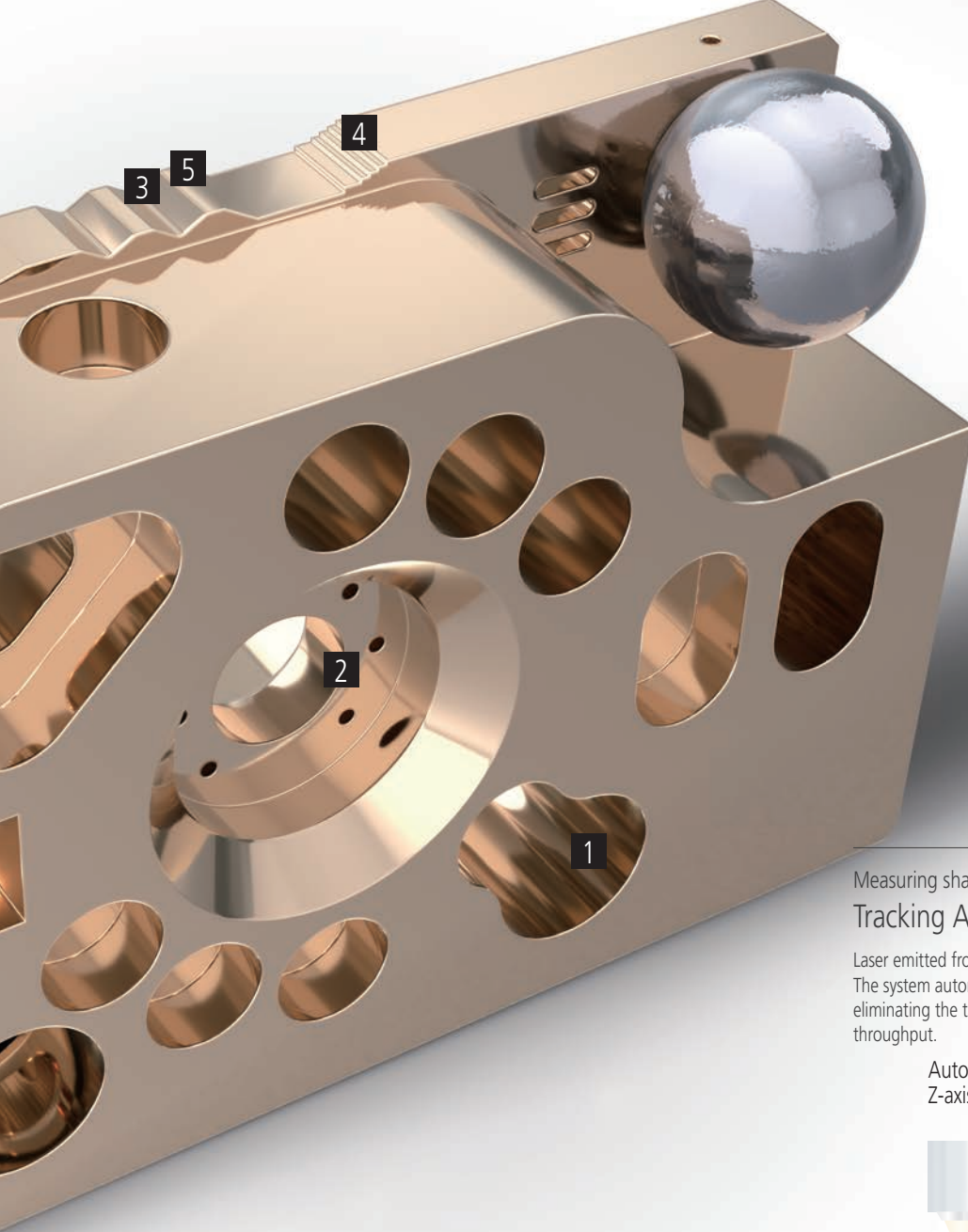

Measuring shapes of all kinds of objects  
Tracking Auto Focus (TAF)

Laser emitted from the objective lens enables automatic focusing. The system automatically keeps the object in focus according to its shape, eliminating the task of focus adjustment and increasing measurement throughput.

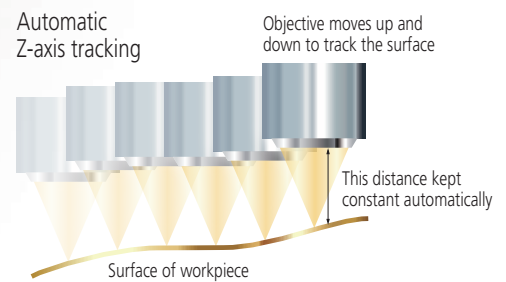

**5** 3D measurement with multiple cross-section images  
PFF (Points From Focus)

Scanning the object by auto focusing the objective lens can capture multiple cross-section images (image contrasts) at different heights. Thus obtaining 3D shape data from such images.

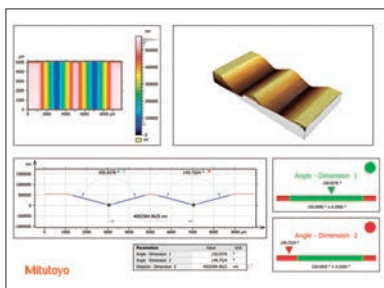

High-speed non-contact measurement of minute height difference and curved shape  
Laser Probe

The laser confocal sensor, less affected by the color of the object, can scan surfaces. The sensor scans the object to capture the surface shape data in a non-contact manner.



Simple measurement procedure  
QV Index

The indexing table turns the object to enable automatic measurement of multiple surfaces in a single setup.



## QUICK VISION Pro Core functions providing high-throughput measurement

The observation unit and the lighting unit of QUICK VISION Pro have been updated, increasing the measurement throughput by about 40% compared with conventional models. Furthermore, measurement programming in two modes has made it possible to conduct high-throughput measurement of any measurement sample. TAF and high-speed auto-focus provide amazingly high throughput even for measurement samples of varying height.

### StrobeSnap

All the QUICK VISION Pro models are equipped with a strobe light, and the newly developed vision measuring function "StrobeSnap" delivers measurements with both high throughput and high accuracy. Regardless of the continuity of measuring positions, measuring time can be shortened by about 35 to 45% for most measurement samples. Due to the excellent compatibility with part programs, StrobeSnap allows a part program to be created for high-speed measurement with ease.



See video from here

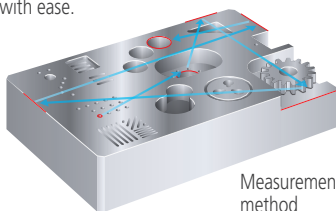

Measurement method

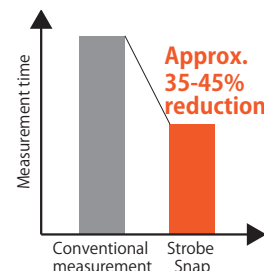

Note: Comparison with old specifications using our demo sample

### STREAM function (optional)

The STREAM function provides an amazingly high throughput, due to the non-stop measurement where the camera motion and the strobe light are synchronized.

It can shorten measuring time more than StrobeSnap on account of continuous element measurement as shown in the following conceptual image of measurement.

The STREAM function of QUICK VISION Pro, including the HYPER model, can be upgraded as an option.



See video from here



XY=0.2 mm pitch, 626  
Measured with a field of view of 0.62x0.47 mm  
STREAM measurement 36 sec.

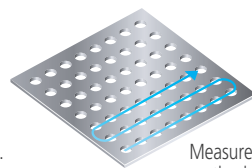

Measurement method

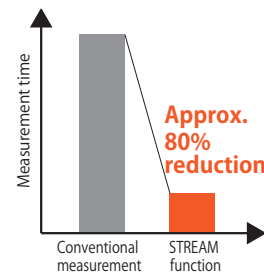

Note: Comparison with old specifications using our demo sample

### Tracking Auto Focus (TAF), optional

Height change in a workpiece can be tracked in the Z-axis direction quickly by laser. StrobeSnap and STREAM allow it to perform effectively, resulting in a significant increase of measurement throughput.



See video from here

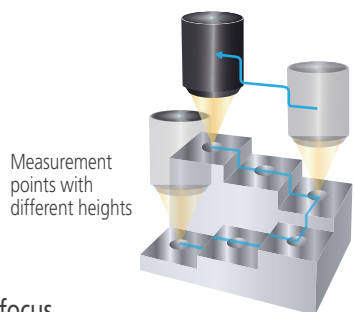

Measurement points with different heights

Measurement method

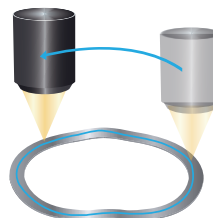

Thin shapes prone to deformation

### High-performance image auto focus

The image auto focus of QUICK VISION Pro can measure the height of surfaces from mirror-finished to rough, such as machined surfaces and plastic molded parts, with high accuracy and at high speed under any conditions. Image auto focus speed has been improved by about 30% compared with conventional models.

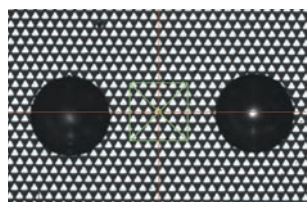

IC package

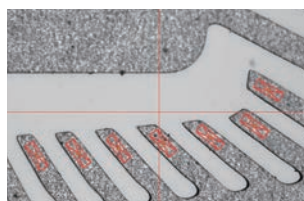

#### Pattern focus

By projecting a pattern through the optical path, auto focus can be applied to even surfaces on which it is difficult to obtain contrast, such as glass surfaces, film surfaces, and mirror-finished surfaces used widely for semiconductor parts.

#### Multi-point auto focus

Multi-point auto focus can be used to set multiple focus positions, sizes, and angles to independent locations. This tool can be used to obtain multiple sets of height information with a single focus operation, which makes it possible to perform highly efficient height and flatness measurements.

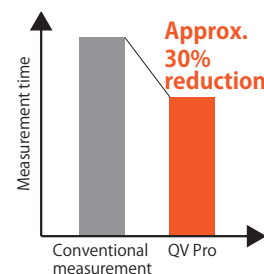

Note: Comparison with old specifications using our demo sample

## Highly Functional Illumination Unit

- QUICK VISION Pro uses LEDs\* for all of their light sources: contour, surface, and programmable ring light.
- Lighting uniformity has been achieved at a high level, which leads to excellent part program compatibility between multiple QUICK VISION machines.
- LED light sources have excellent responsiveness, which improves measurement throughput.
- LED light sources have longer life spans than halogen types, which reduces illumination fluctuations and thereby minimizes any errors caused by changes in light intensity.

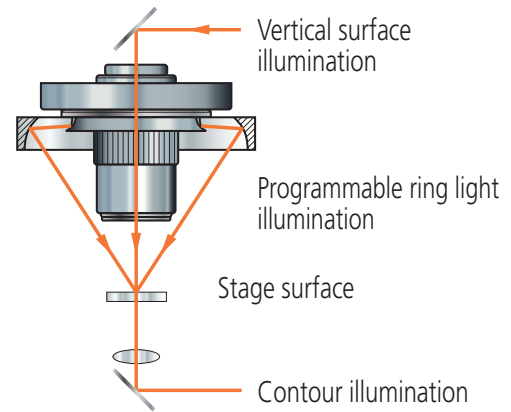

Surface illumination      Programmable ring light illumination      Contour illumination

### Programmable Ring Light (PRL)

Changing the positions of the two curved mirrors sets the ring light's direction to any chosen value between 30° and 80°. This is effective for enhancing the edges of inclined surfaces or very small steps. Furthermore, the PRL's light illumination can be controlled independently in every direction, front and back, right and left. This makes it possible to configure highly variable lighting settings to match measurement locations.

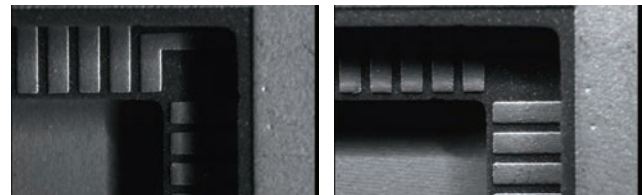

### White LED illumination/Color LED illumination

With QUICK VISION Pro, white LED lighting is standard with optional colored surface and ring light LED lighting available. The colored LED model can emphasize edge contrast by changing the emitted light color.

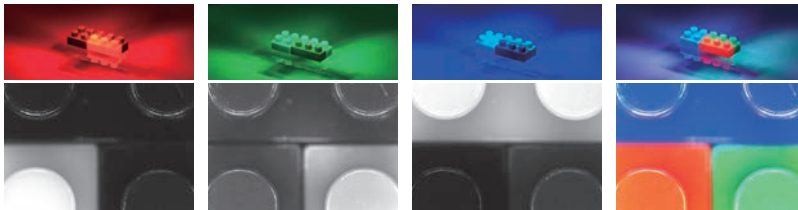

Using the pseudo-color image display function generates a color observation image with high color reproducibility from each of the RGB-irradiated images.

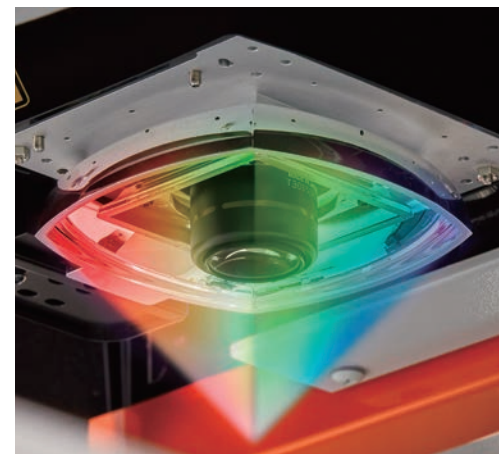

Note: This is a conceptual image of the colored LED illumination model.



See video from here

### Programmable Power Turret

QUICK VISION Pro's programmable power turret has excellent magnification repeatability which makes it suited for highly accurate measurements. The standard specification provides three steps of magnification: 1X, 2X and 6X\*.

The rich lineup of objectives includes lenses with magnifications ranging from 0.5X to 25X, which makes it possible to select the optimal optical system to match the measurement target.

Additional objective lenses can always be purchased after the purchase of the main unit.

\* Also available as special options: three or four steps of magnification: 1X, 2X and 4X; or 1X, 2X, 4X and 6X.

#### When using QV-HR1X

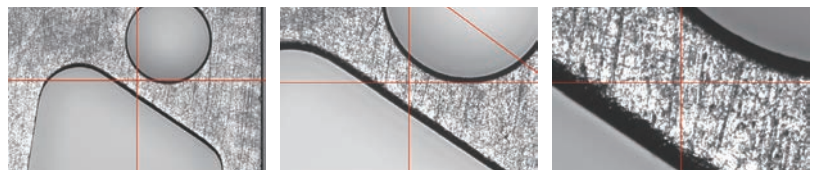

Turret 1X Field of view: 6.27×4.70 mm      Turret 2X Field of view: 3.13×2.35 mm      Turret 6X Field of view: 1.04×0.78 mm

#### When using QV-HR10X



## Well-designed structure for high-accuracy measurement

The main unit utilizes a moving Y axis table with a fixed bridge. Structural deformation caused by movement along each axis has been minimized, which ensures that the QUICK VISION Series can be used to perform highly accurate measurements with minimal spatial coordinate distortions. (Excludes ACCEL)

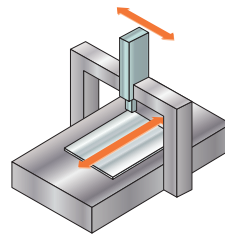

## Equipped with thermal compensation function

All the models of QUICK VISION Pro are equipped with a thermal compensation function.

- APEX Manual Input from software
- HYPER Automatic Real-time automatic input from X/Y/Z-axis scale and workpiece temperature sensor

Accuracy guaranteed temperature (1) 20±2 °C (2) 19 to 24 °C As seen in (1) and (2), accuracy can be guaranteed across a wide range of temperature conditions.

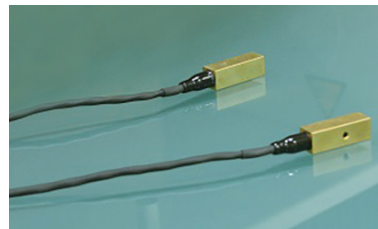

Temperature compensation sensor

## Accuracy-guaranteed performance, complying with maximum permissible error (MPE) of ISO 10360.

- QV APEX Pro/QV HYPER Pro
- QVTP APEX Pro/QVTP HYPER Pro
- QVH4 APEX Pro/QVH4 HYPER Pro

## Also complies with ISO10360-7: 2011/JIS B 7440-7: 2015 (optional)

The unit complies with the accuracy guarantee of ISO10360-7/JIS B 7440-7. Whether performing vision measurement or touch probe measurement, you can measure even spatial position dimensions (including height) with no issues. For applicable models, see the specs of each model on pages 18 to 22.

## Accuracy guarantee items

- Length measurement error  $E_{U, MPE}$
- Probing error  $P_{F2D, MPE}$

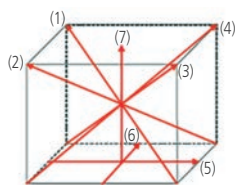

Length measurement error  $E_{U, MPE}$

## Traceability to national standards

Mitutoyo's calibration artifacts and instruments that are used to establish machine accuracy specifications are maintained in a continuous chain of traceability to national dimensional standards. This is our customers' assurance of reliable measurement.

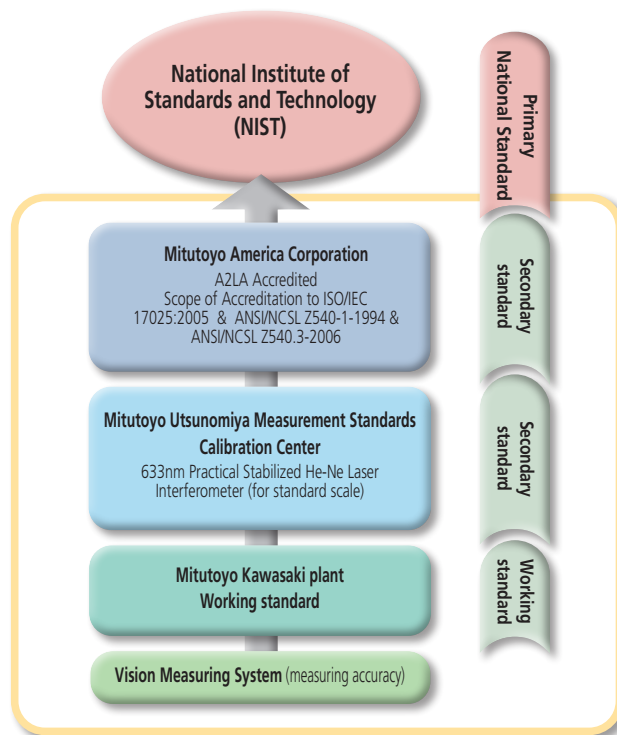



# LINE-UP

A wide array of variations and systems available to broaden measurement applications and improve quality control.

The QUICK VISION Pro offers a rich lineup with a wide array of measurement ranges and accuracies useful for implementing quality control in all industries, including medical, automotive, electronics, and semiconductors. It expands measurement applications by combining a vision measuring system that optically magnifies an object image with multiple sensors, including non-contact probes, touch probes and a white light interferometer.

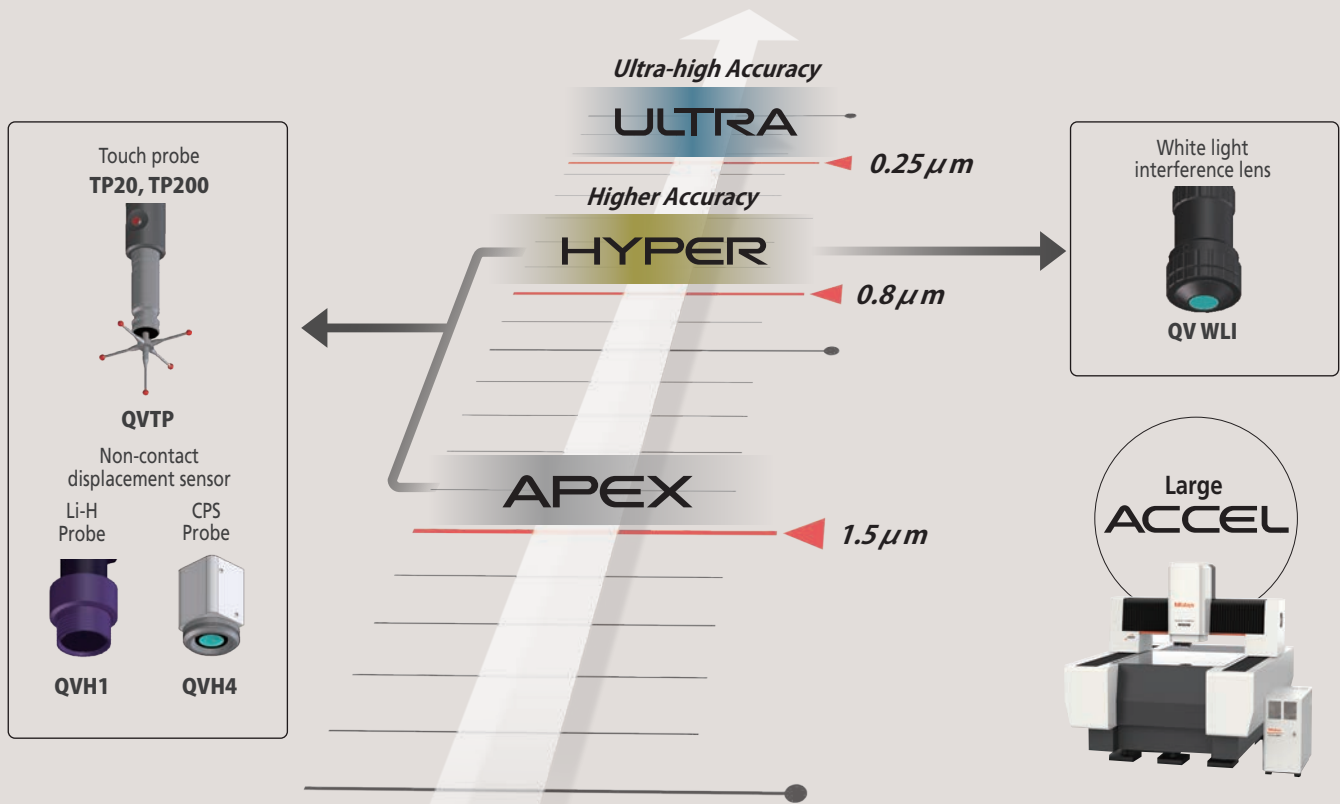



# QV APEX Pro

## CNC Vision Measuring System



- This is a superior model of QUICK VISION, which is equipped with the StrobeSnap function as standard, enabling high-speed measurement.
- We offer a model with tracking auto focus (TAF) that quickly focuses on the object, improving throughput significantly.

- The camera motion and the strobe light are synchronized to make non-stop vision measurements without stopping the stage. This makes it possible to use STREAM to shorten measuring time dramatically.



QV APEX 302 Pro

Model	QV APEX 302 Pro				QV APEX 404 Pro				QV APEX 606 Pro			
Order No.	363-601	363-603	363-602	363-604	363-611	363-613	363-612	363-614	363-621	363-623	363-622	363-624
	QV-X302P1L-E	QV-X302T1L-E	QV-X302P1C-E	QV-X302T1C-E	QV-X404P1L-E	QV-X404T1L-E	QV-X404P1C-E	QV-X404T1C-E	QV-X606P1L-E	QV-X606T1L-E	QV-X606P1C-E	QV-X606T1C-E
Measuring range [mm]	12x8x8" (300×200×200)				16x16x10" (400×400×250)				24x26x10" (600×650×250)			
Observation unit*	Programmable power turret 1X-2X-6X											
Tracking Auto Focus device	—	✓	—	✓	—	✓	—	✓	—	✓	—	✓
Illumination unit	Contour illumination	White LED										
	Surface illumination	White LED	Color LED	White LED	Color LED	White LED	Color LED	White LED	Color LED			
	PRL	White LED	Color LED	White LED	Color LED	White LED	Color LED	White LED	Color LED			
Resolution of scale [μm]	0.1											
Vision measuring accuracy [μm]	E <sub>UX</sub> /E <sub>UY</sub> , MPE	(1.5 + 3L/1000)										
	E <sub>UXY</sub> , MPE	(2.0 + 4L/1000)										
	E <sub>UZ</sub> , MPE	(1.5 + 4L/1000)										
LAF Repeatability [μm]	—	σ ≤0.8	—	σ ≤0.8	—	σ ≤0.8	—	σ ≤0.8	—	σ ≤0.8	—	σ ≤0.8
Temperature compensation function	Manual											

\* Programmable power turret 1X-2X-4X model and 1X-2X-4X-6X model are available to special order.

# QV HYPER Pro

## High-accuracy CNC Vision Measuring System



- The QV HYPER Pro is a highly accurate model that is equipped with a high-resolution/accuracy scale.
- We offer a model with tracking auto focus (TAF) that quickly focuses on the object improving throughput significantly.
- The camera motion and the strobe light are synchronized to make non-stop vision measurements without stopping the stage. This makes it possible to use STREAM to shorten measuring time dramatically.

- There is a general-purpose model with white LED light and an enhanced edge detection model with RGB color LEDs.
- This model is standard-equipped with automatic temperature compensation that uses a temperature sensor on the main unit of the measuring machine and a temperature sensor for the workpiece.



QV HYPER 302 Pro

Model	QV HYPER 302 Pro				QV HYPER 404 Pro				QV HYPER 606 Pro			
Order No.	363-605	363-607	363-606	363-608	363-615	363-617	363-616	363-618	363-625	363-627	363-626	363-628
	QV-H302P1L-E	QV-H302T1L-E	QV-H302P1C-E	QV-H302T1C-E	QV-H404P1L-E	QV-H404T1L-E	QV-H404P1C-E	QV-H404T1C-E	QV-H606P1L-E	QV-H606T1L-E	QV-H606P1C-E	QV-H606T1C-E
Measuring range [mm]	12x8x8" (300×200×200)				16x16x10" (400×400×250)				24x26x10" (600×650×250)			
Observation unit*	Programmable power turret 1X-2X-6X											
Tracking Auto Focus device	—	✓	—	✓	—	✓	—	✓	—	✓	—	✓
Illumination unit	Contour illumination	White LED										
	Surface illumination	White LED	Color LED	White LED	Color LED	White LED	Color LED	White LED	Color LED			
	PRL	White LED	Color LED	White LED	Color LED	White LED	Color LED	White LED	Color LED			
Resolution of scale [μm]	0.02											
Vision measuring accuracy [μm]	E <sub>UX</sub> /E <sub>UY</sub> , MPE	(0.8 + 2L/1000)										
	E <sub>UXY</sub> , MPE	(1.4 + 3L/1000)										
	E <sub>UZ</sub> , MPE	(1.5 + 2L/1000)										
LAF Repeatability [μm]	—	σ ≤0.8	—	σ ≤0.8	—	σ ≤0.8	—	σ ≤0.8	—	σ ≤0.8	—	σ ≤0.8
Temperature compensation function	Automatic											

\* Programmable power turret 1X-2X-4X model and 1X-2X-4X-6X model are available to special order.

# QVTP Pro

CNC Vision Measuring System Equipped with a Touch Trigger Probe



- Non-contact measurement and contact measurement can be done solely by one unit. QVTP Pro can perform contact measurement by using the vision measuring function and the touch trigger probe.
- Three-dimensional workpiece measurements can be performed. Enables 3D measurement of workpieces such as press-molded products, plastic-molded products, and cut products, which until now could not be measured with image processing alone.
- Using the probe module change rack allows switching between vision measurement and touch trigger probe measurement during an automatic measuring sequence.



QVTP HYPER 404 Pro

Model	QVTP APEX 302 Pro				QVTP APEX 404 Pro				QVTP APEX 606 Pro			
Order No.	364-601 QVT1-X302P1L-E	364-603 QVT1-X302T1L-E	364-602 QVT1-X302P1C-E	364-604 QVT1-X302T1C-E	364-611 QVT1-X404P1L-E	364-613 QVT1-X404T1L-E	364-612 QVT1-X404P1C-E	364-614 QVT1-X404T1C-E	364-621 QVT1-X606P1L-E	364-623 QVT1-X606T1L-E	364-622 QVT1-X606P1C-E	364-624 QVT1-X606T1C-E
Measuring range [mm]	Vision 12x8x8" (300×200×200)				16x16x10" (400×400×250)				24x26x10" (600×650×250)			
	Common to vision touch probe 9x8x8" (234×200×200)				13x16x10" (334×400×250)				21x26x10" (534×650×250)			
Observation unit*	Programmable power turret 1X-2X-6X											
Tracking Auto Focus device	—	✓	—	✓	—	✓	—	✓	—	✓	—	✓
Illumination unit	Contour illumination White LED											
	Surface illumination White LED			Color LED			White LED			Color LED		
	PRL White LED			Color LED			White LED			Color LED		
Resolution of scale [μm]	0.1											
Vision measuring accuracy [μm]	Eux / Euy, MPE (1.5 + 3L/1000)											
	Euxy, MPE (2.0 + 4L/1000)											
	Euz, MPE (1.5 + 4L/1000)											
TP measuring accuracy [μm]	Ex, MPE / Ey, MPE / Ez, MPE (1.8 + 3L/1000)											
LAF Repeatability [μm]	—	σ ≤0.8	—	σ ≤0.8	—	σ ≤0.8	—	σ ≤0.8	—	σ ≤0.8	—	σ ≤0.8
Temperature compensation function	Manual											

\* Programmable power turret 1X-2X-4X model and 1X-2X-4X-6X model are available to special order.

Model	QVTP HYPER 302 Pro				QVTP HYPER 404 Pro				QVTP HYPER 606 Pro			
Order No.	364-605 QVT1-H302P1L-E	364-607 QVT1-H302T1L-E	364-606 QVT1-H302P1C-E	364-608 QVT1-H302T1C-E	364-615 QVT1-H404P1L-E	364-617 QVT1-H404T1L-E	364-616 QVT1-H404P1C-E	364-618 QVT1-H404T1C-E	364-625 QVT1-H606P1L-E	364-627 QVT1-H606T1L-E	364-626 QVT1-H606P1C-E	364-628 QVT1-H606T1C-E
Tracking Auto Focus device	—	✓	—	✓	—	✓	—	✓	—	✓	—	✓
Resolution of scale [μm]	0.02											
Vision measuring accuracy [μm]	Eux / Euy, MPE (0.8 + 2L/1000)											
	Euxy, MPE (1.4 + 3L/1000)											
	Euz, MPE (1.5 + 2L/1000)											
TP measuring accuracy [μm]	Ex, MPE / Ey, MPE / Ez, MPE (1.7 + 3L/1000)											
LAF Repeatability [μm]	—	σ ≤0.8	—	σ ≤0.8	—	σ ≤0.8	—	σ ≤0.8	—	σ ≤0.8	—	σ ≤0.8
Temperature compensation function	Automatic											

The other specifications are the same as those of QVTP APEX Pro.

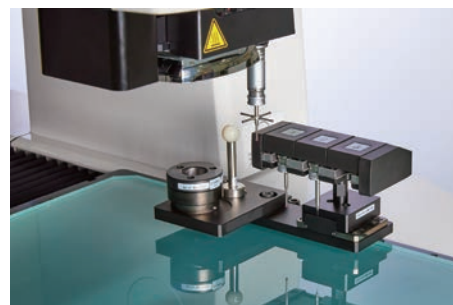

# QVH4 Pro

Non-contact Displacement Sensor-equipped CNC Vision Measuring System



- This dual system with a non-contact displacement sensor has a scanning function that enables measurement of minute height differences and 3D shapes.
- The non-contact displacement sensor (CPS probe) uses the wavelength confocal method.
- The LED used as the light source of the displacement sensor has an auto-brightness control function that enables seamless measurement of materials with different reflectivity.

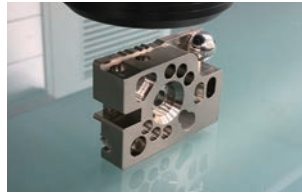

QVH4 HYPER 606 Pro

Model	QVH4 APEX 302 Pro	QVH4 APEX 404 Pro	QVH4 APEX 606 Pro
Order No.	365-601 QVH4A-X302P1L-E	365-611 QVH4A-X404P1L-E	365-621 QVH4A-X606P1L-E
Main unit Size, mass	Programmable power turret 1X-2X-6X		
Measuring range [mm]	Vision	12x8x8* (300×200×200)	16x16x10* (400×400×250)
	Common to vision non-contact displacement sensor	7x8x8* (176×200×200)	11x16x10* (276×400×250)
Observation unit*1	Contour illumination	White LED	
	Surface illumination	White LED	
	PRL	White LED	
Resolution of scale [μm]	0.1		
Vision measuring accuracy [μm]	E <sub>UX</sub> / E <sub>UV</sub> , MPE	(1.5 + 3L/1000)	
	E <sub>UXY</sub> , MPE	(2.0 + 4L/1000)	
	E <sub>UZ</sub> , MPE	(1.5 + 4L/1000)	
Displacement sensor measuring accuracy [μm]*2	E <sub>1z</sub>	(1.5 + 4L/1000)	
Temperature compensation function	Manual		

\*1 Programmable power turret 1X-2X-4X model and 1X-2X-4X-6X model are available to special order. \*2 Determined by Mitutoyo's inspection method.

Model	QVH4 HYPER 302 Pro	QVH4 HYPER 404 Pro	QVH4 HYPER 606 Pro
Order No.	365-605 QVH4A-H302P1L-E	365-615 QVH4A-H404P1L-E	365-625 QVH4A-H606P1L-E
Resolution of scale [μm]	0.02		
Vision measuring accuracy [μm]	E <sub>UX</sub> / E <sub>UV</sub> , MPE	(0.8 + 2L/1000)	
	E <sub>UXY</sub> , MPE	(1.4 + 3L/1000)	
	E <sub>UZ</sub> , MPE	(1.5 + 2L/1000)	
Displacement sensor measuring accuracy [μm]*	E <sub>1z</sub>	(1.5 + 2L/1000)	
Temperature compensation function	Automatic		

The other specifications are the same as those of QVH4 APEX Pro.

\* Determined by Mitutoyo's inspection method.

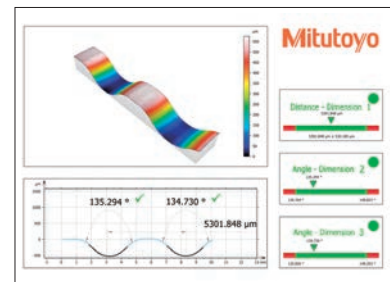
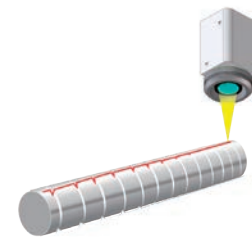
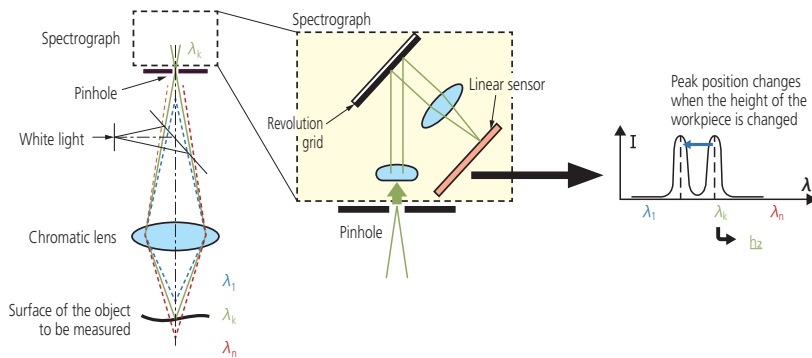

# QV HYBRID TYPE1

Non-contact Laser-equipped CNC Vision Measuring System



- This dual system with a non-contact displacement sensor has a scanning function that enables measurement of minute height differences and 3D shapes.
- The double-pinhole technique is used as the detection method of the displacement sensor. It is less directional compared with the knife-edge and triangulation techniques.
- The small laser spot with diameter of about 2 μm makes it possible to measure minute shapes.

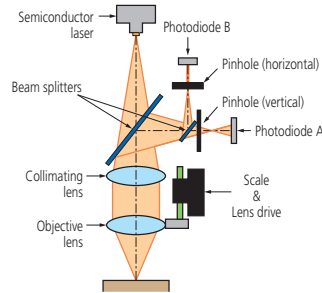
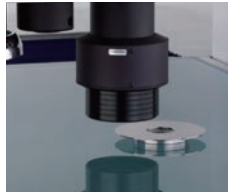

QV Hybrid Type1 Apex 404

Model	QVH1 302			QVH1 404			QVH1 606			
	Apex						Hyper			
Standard	QVH1-X302P1L-D			QVH1-X404P1L-D			QVH1-H302P1L-D			
Measuring range [mm]	Vision	12x8x8" (300×200×200)			16x16x10" (400×400×250)			24x26x10" (600×650×250)		
	Common to vision displacement sensor	7x8x8" (180×200×200)			11x16x10" (280×400×250)			19x26x10" (480×650×250)		
Observation unit*1	Programmable power turret 1X-2X-6X									
Illumination unit	Contour illumination	White LED								
	Surface illumination	White LED								
	PRL	White LED								
Resolution of scale [μm]	0.1						0.02			
Vision measuring accuracy [μm]*2	E <sub>1x</sub> , E <sub>1y</sub>	(1.5 + 3L/1000)						(0.8 + 2L/1000)		
	E <sub>1z</sub>	(1.5 + 4L/1000)						(1.5 + 2L/1000)		
	E <sub>2xy</sub>	(2.0 + 4L/1000)						(1.4 + 3L/1000)		
Displacement sensor measuring accuracy [μm]	E <sub>1z</sub>	(1.5 + 4L/1000)						(1.5 + 2L/1000)		

\*1 Programmable power turret 1X-2X-4X model and 1X-2X-4X-6X model are available to special order. \*2 Determined by Mitutoyo's inspection method.

# Hyper QVWLI

Non-contact 3D Measuring System



- Hyper QVWLI is a high-accuracy dual 3D measurement system consisting of QV and a white light interferometer.
- You can perform 3D surface texture analysis and 3D roughness analysis from 3D data captured by the WLI optical system. You can also perform dimension measurement and cross-section measurement at a specific height using the 3D data.

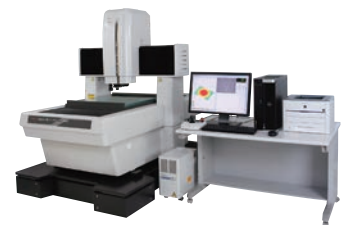
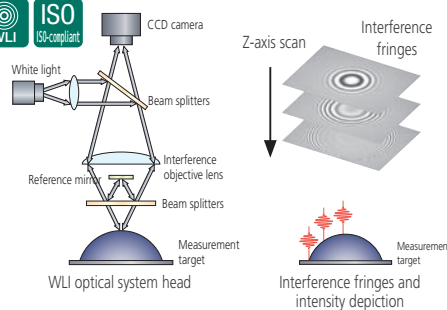

Hyper QVWLI 606

Model	Hyper QVWLI 302		Hyper QVWLI 404		Hyper QVWLI 606		
	Standard						
Standard	QVW-H302P1L-D		QVW-H404P1L-D		QVW-H606P1L-D		
Measuring range [mm]	Vision measurement	12x8x8" (300×200×190)		16x16x10" (400×400×240)		24x26x10" (600×650×220)	
	WLI measurement	8.5x8x8" (215×200×190)		12.5x16x10" (15×400×240)		20x26x10" (515×650×220)	
Observation unit*1	Programmable power turret 1X-2X-6X						
Illumination unit	Contour illumination	White LED					
	Surface illumination	White LED					
	PRL	White LED					
	WLI optical head	Halogen					
Resolution of scale [μm]	0.01						
Vision measuring accuracy [μm]*2	E <sub>1x</sub> , E <sub>1y</sub>	(0.8 + 2L/1000)					
	E <sub>1z</sub>	(1.5 + 2L/1000)					
	E <sub>2xy</sub>	(1.4 + 3L/1000)					
	Accuracy guaranteed with optics specified	2.5X objective (QV-HR2.5X or QV-SL2.5X) and middle magnification tube lens					
WLI Z-axis scanning range (max.)	QVWLI A-5X, QVWLI A-10X: 6.3 mm, QVWLI A-25X: 3.2 mm, QVWLI A-50X: 1.0 mm						
WLI Z-axis repeatability [μm]*2	2σ ≤ 0.08						

\*1 Programmable power turret 1X-2X-4X model and 1X-2X-4X-6X model are available to special order. \*2 Determined by Mitutoyo's inspection method.

# QV ACCEL

## CNC Vision Measuring System



- This is a vision measuring machine with moving-bridge type main unit structure suitable for measuring large objects.
- As the stage is fixed on the moving-bridge structure, you can use a simple method to fixture a workpiece, which is suitable for measuring small, thin objects.
- QV ACCEL 1212 (range: 1250×1250×100 mm) and QV ACCEL 1517 (range: 1500×1750×100 mm) are available to special order.



QV ACCEL 808

Model	QV ACCEL 808		QV ACCEL 1010
Standard	QV-A808P1L-D		QV-A1010P1L-D
Measuring range [mm]	31.5x31.5x6" (800×800×150)		39x39x6" (1000×1000×150)
Observation unit*1	Programmable power turret 1X-2X-6X		
Illumination unit	Contour illumination		White LED
	Surface illumination		White LED
	PRL		White LED
Resolution of scale [μm]	0.1		
Vision measuring accuracy [μm]*2	E <sub>1x</sub> , E <sub>1y</sub>		(1.5 + 3L/1000)
	E <sub>1z</sub>		(1.5 + 4L/1000)
	E <sub>2xy</sub>		(2.5 + 4L/1000)
Repeatability [μm]*2	Short dimension	X, Y axis	3σ ≤ 0.2
	Long dimension		3σ ≤ 0.7

\*1 Programmable power turret 1X-2X-4X model and 1X-2X-4X-6X model are available to special order.

\*2 Determined by Mitutoyo's inspection method. Short dimension = Repeatability within a single screen; Long dimension = Repeatability over several screen movements.

# ULTRA QV

## Ultra-high Accuracy CNC Vision Measuring System



- Ultra-high accuracy CNC vision measuring machine with measuring accuracy of E<sub>1xy</sub> (0.25 + L/1000) μm.
- Our proprietary high-resolution (0.01 μm) and high-accuracy low-expansion glass scales are used on the X, Y and Z axes.
- The main unit utilizes a highly rigid moving Y axis table with a fixed bridge. The base is made of high-stability granite.



ULTRA QV 404

Model	ULTRA QV 404	
Standard	QV-U404P1N-D	QV-U404T1N-D
Measuring range [mm]	16x16x8" (400×400×200)	
Observation unit*1	Programmable power turret 1X-2X-6X	
Tracking Auto Focus device	—	✓
Illumination unit	Contour illumination	
	Surface illumination	
	PRL	
Resolution of scale [μm]	0.01	
Vision measuring accuracy [μm]*2	E <sub>1x</sub> , E <sub>1y</sub>	
	E <sub>1z</sub> (50 mm stroke)	
	E <sub>1z</sub> (Full stroke)	
	E <sub>2xy</sub>	
LAF Repeatability [μm]	—	σ ≤ 0.8

\*1 Programmable power turret 1X-2X-4X model and 1X-2X-4X-6X model are available to special order. \*2 Determined by Mitutoyo's inspection method.

# OPTIONS



## QV Objectives

Objective	QV-SL0.5X*	QV-HR1X	QV-SL1X	QV-HR2.5X	QV-SL2.5X	QV-HR5X	QV-5X	QV-HR10X*	QV-10X*	QV-25X*	
Order No.	02AKT199	02AKT250	02ALA150	02AKT300	02ALA170	02AWD010	02ALA420	02AKT650	02ALG010	02ALG020	
Set of objectives that support PFF	—	—	—	02AKX895B	—	02AXA915B	02AKX900B	02AKX905B	—	02AKX910B	
Working distance [mm]	30.5	40.6	52.5	40.6	60.0	20.0	33.5	20.0	30.5	13.0	
Field of view (H)×(V) mm	Turret 1X	12.54×9.4	6.27×4.7		2.49×1.86		1.24×0.93		0.62×0.47		0.25×0.18
	Turret 2X	6.27×4.7	3.13×2.35		1.24×0.93		0.62×0.47		0.31×0.23		0.12×0.09
	Turret 6X	2.09×1.56	1.04×0.78		0.41×0.31		0.20×0.15		0.10×0.07		0.04×0.03

\* When the QV-SL0.5X, QV-HR10X, QV-10X, or QV-25X objective is used, some limitations, such as the illumination being insufficient depending on the workpiece, may occur.

Monitor magnification*1	15X	29X	58X	72X	87X	144X	173X	290X	430X	580X	720X	870X	1440X	1730X	4300X
Field of view [mm]	12.54×9.40	6.27×4.70	3.13×2.35	2.49×1.86	2.09×1.56	1.24×0.93	1.04×0.78	0.62×0.47	0.41×0.31	0.31×0.23	0.25×0.18	0.20×0.15	0.12×0.09	0.10×0.07	0.04×0.03
0.5X objective	●	●			●										
1X objective		●	●			●									
2.5X objective				●		●		●							
5X objective							●	●				●			
10X objective*2									●		●			●	
25X objective*2												●	●		●

\*1 The monitor magnification is a reference value when an image is displayed at 1X screen magnification on a 22-inch wide LCD monitor. QVPAK version 10 or later supports changing of video window size.

\*2 When using a 10X or 25X objective lens in conjunction with a 2X or 6X power turret, brightness illumination may be insufficient depending on the workpiece.

## Calibration Chart and QV Compensation Chart

### Calibration chart

A calibration chart is used to compensate for the pixel size of the camera imaging chip and for the auto focus accuracy and optical axis offset at each magnification of the variable magnification unit (PPT).

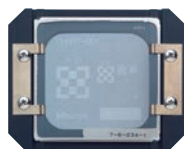

Note: There are limitations on the function, depending on the lens. For details, contact your Mitutoyo sales office.

### QV compensation chart

This glass chart is used to perform compensation for distortions within the screen caused by the optical system, and auto focus compensation, which reduces auto focus variations that are caused by differences between the workpiece pattern and texture.



Note: There are limitations on the function, depending on the lens. For details, contact your Mitutoyo sales office.

# SOFTWARE

Application software that offers both functionality and operability

In addition to high-performance vision measuring functions, we offer a wide range of software applications such as shape analysis using a non-contact displacement sensor and automatic creation of measurement programs. From simple to complex measurements, our lineup can resolve any measurement issues that our customers may encounter.

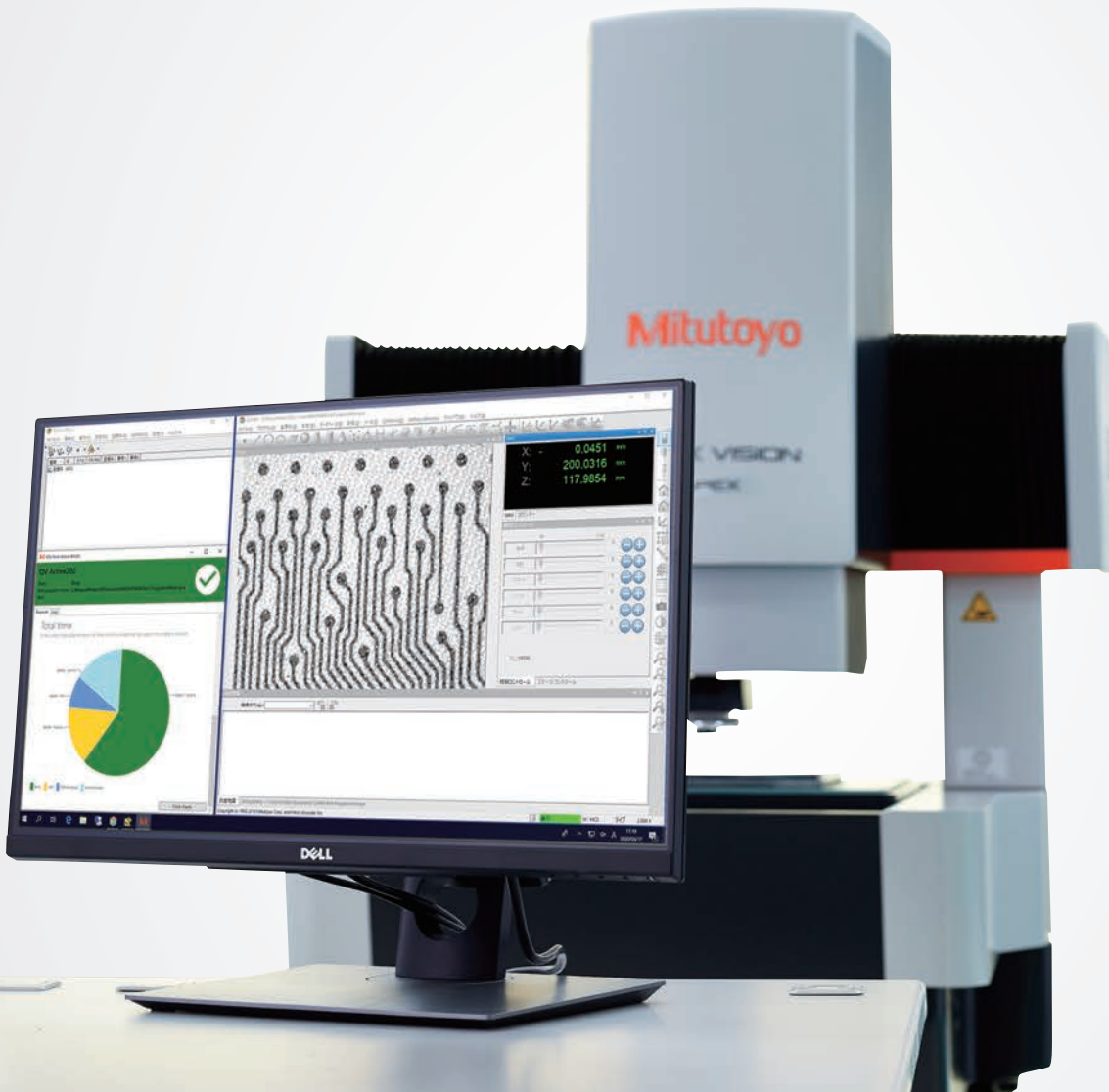



# A rich choice of measuring functions

## 1 One-click Tool

Whatever your proficiency level, this function enables you to perform high-accuracy measurements by simply selecting the measurement item (circle, line, etc.) and clicking the edge to measure once. The outlier removal function automatically removes traces of burrs and contaminants.

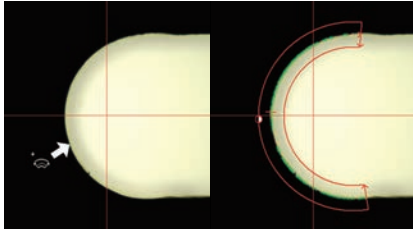

## 2 AI Illumination Tools

There are two tools: the dual area contrast tool, which can adjust the light intensity to the optimal value at procedure creation time, and the brightness tool, which automatically compensates the light intensity at program creation time. These tools stabilize the light intensity during repeat measurements, which increases edge detection repeatability and reduces the occurrence of edge detection errors caused by light intensity fluctuations.

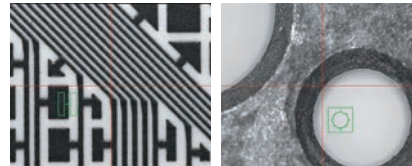

Dual Area Contrast Tool    Brightness Tool

## 3 Multi-point Auto Focus

You can subdivide an auto focus tool or set up multiple auto focus tools at desired sizes, positions and angles.

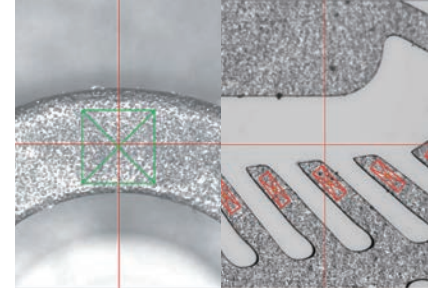

## 4 QV Graphics NEW

Not only can this feature be used for reports of measurement results, but also high-level calculations, such as calculations between elements, and PCD measurements can be performed by selecting diagrams with the mouse. In addition, effective use of the graphics function makes it possible to easily edit part programs and is also useful in checking the coordinate system of the current workpiece and in checking for any forgotten measurements.

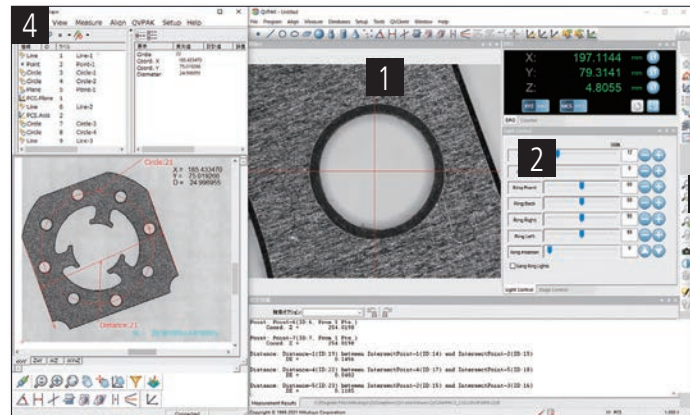
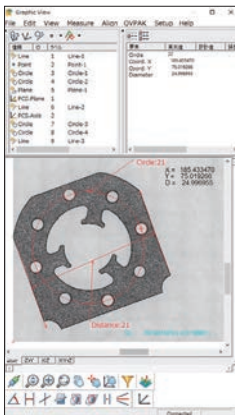

## 5 QV EasyEditor

QV EasyEditor records and allows you to easily edit the details of the operator's operation. The program list displays error icons for you to quickly find the parts to correct.

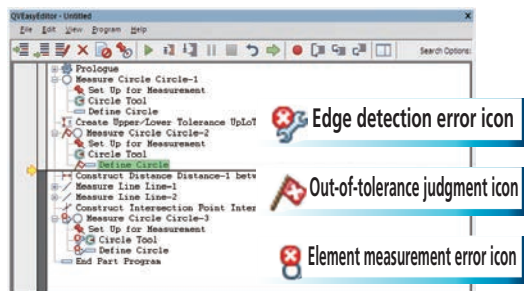

## 6 MiCAT Reporter NEW

MiCAT Reporter is equipped as standard with a purpose to create reports from the QVPAK measurement results. The software can output data into PDF directly, allowing you to create medical component reports and other reports requiring reliability.

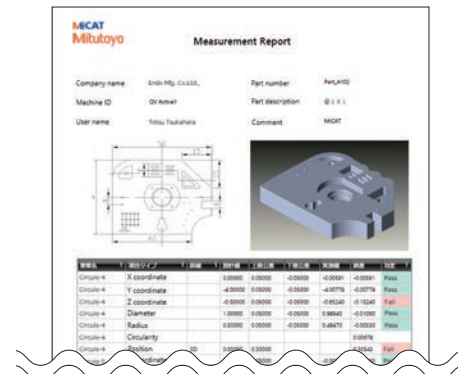

## OPTIONAL SOFTWARE

### FORMTRACEPAK-AP

Form Evaluation and Analysis Software

FORMTRACEPAK-AP performs tolerancing and form analysis from data obtained with the QV's auto trace tool, non-contact displacement sensor, WLI, and PFF.

#### Contour Tolerancing Function

- Design data creation
  - CAD data conversion, master workpiece conversion, function specification, text file conversion, and aspherical surface design value creation
- Tolerancing
  - Normal vector direction tolerancing, axial direction tolerancing, and best-fit tolerancing

#### Microscopic Form Analysis

- Analyzed items: point measurement, line measurement, circle measurement, distance measurement, intersection measurement, angle measurement, origin setting, and axial rotation
- Calculated items: maximum, minimum, average, standard deviation, and area

#### Report Creation Function

- Measurement result, error graph, and error developed view

#### Other Functions

- Recording and executing analysis procedures
- External output function:
  - CSV, text or DXF/IGES format output

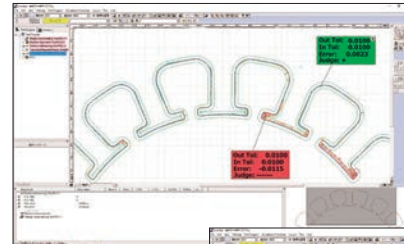

Tolerancing example

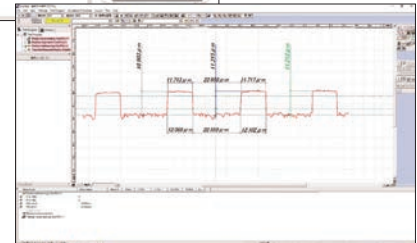

Example of using WLI to perform line, space and conductor thickness measurements on a printed circuit board

### MCubeMap

3D Surface Property Analyzing Software

3D data captured by WLI can be analyzed according to parameters compliant with ISO25178-6: 2010, including Sa, Sq and other height parameters and 3D roughness parameters related to space, complexity and functionality.

You can also analyze 2D shapes and measure volumes from the 3D data captured by PFF or QV Hybrid.

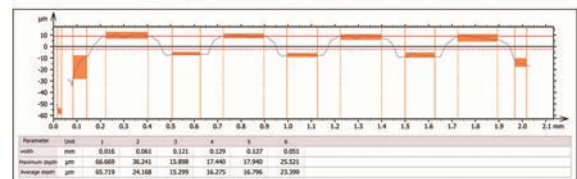
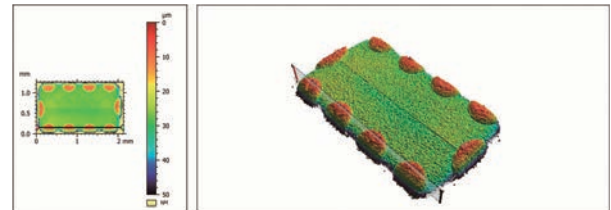

Example of SMD terminal height measurement by PFF

### FORMTRACEPAK-PRO

Form Evaluation and Analysis Software

3D data captured by WLI can be analyzed for 3D surface roughness and surface texture. You can also analyze the displayed 3D shape information captured by the non-contact displacement sensor of PFF or QV Hybrid.

#### Main Functions

- 3D display
  - Wire frame, shading, contour line, contour line filling
- Trend compensation and filter processing
  - Trend compensation using flat surfaces, spherical surfaces, cylindrical surfaces, and polyhedrons
  - 1D and 2D digital filters for each profile
- Digitization of a rich variety of surface textures
  - Relative load curves and area distribution curves can be used to evaluate wear and oil accumulation areas.
  - Spectral analysis, cutoff area and volume analysis, angle of inclination calculations at peaks and valleys, and histogram calculations of numbers of valleys can be performed.
- Function for extracting features from measurement data
  - Extraction of a chosen cross section, slope enhancement, and simultaneous analysis of the peaks and valleys of the cutoff surface can be performed.

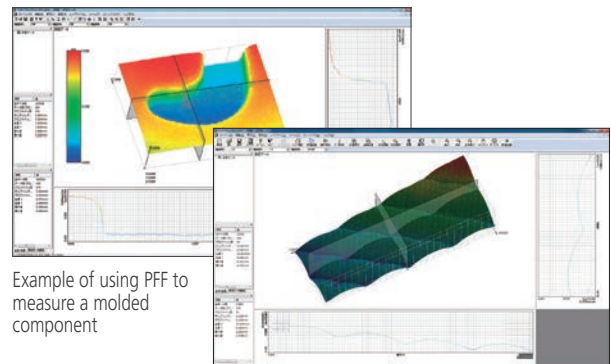

Example of using PFF to measure a molded component

Example of using CPS to perform acrylic lens array measurements

## EASYPAG-PRO

Offline Teaching Software

DXF IGES GERBER data

EASYPAG-PRO can use 2D CAD model to create QVPAK part programs offline. This reduces the number of man-hours required to create part programs, which results in a decrease in programming time.

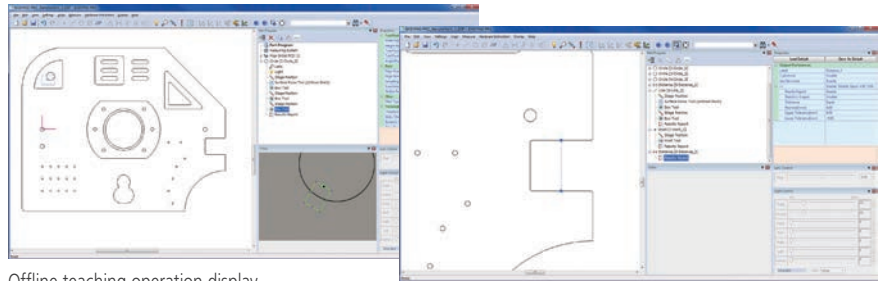

Offline teaching operation display

Line-to-arbitrary point distance measurement

## QV3DCAD

QV3DCAD creates a QVPAK part program from a 3D CAD model. The current version supports two modes: the online mode that allows you to teach while monitoring the actual workpiece by synchronizing the software with the QV system, and the offline mode that allows you to create a part program on a PC not connected to the main unit.

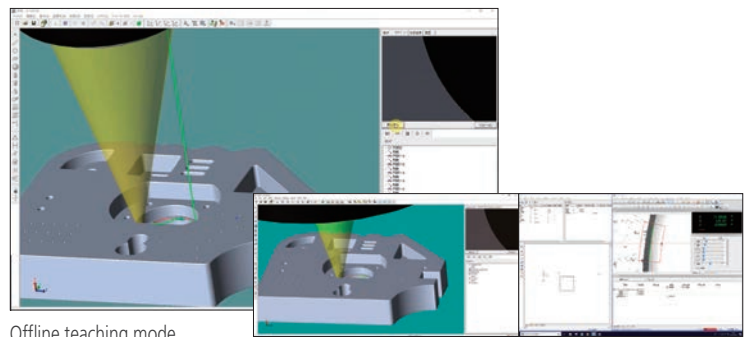

Offline teaching mode

Online teaching mode

## MSURF-I

Compares the 3D data captured by CPS, laser, WLI and PFF with the design data of the 3D CAD model, etc.

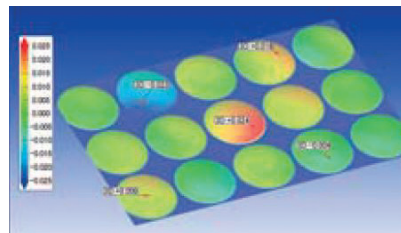

## QV3DPAK

QV3DPAK is a software application that composes 3D forms from PFF (Point From Focus) or WLI (White Light Interferometer) data.

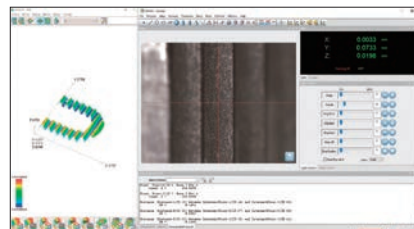

# SMART FACTORY

From status management to preventative maintenance.  
Kickstart your smart factory through visualization.

Mitutoyo has developed new features that use a network to centrally manage manufacturing process information. The MeasurLink<sup>®</sup> software package helps prevent defective parts by collecting and analyzing measurement data in real time. The status monitor (SMS: Smart Measuring System) shows the operating status of the measuring machine and helps improve productivity.



## QVEio

IO application making the smart factory real

QVEio-PLC supported example

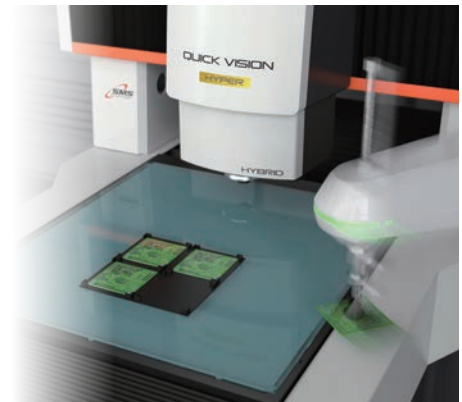
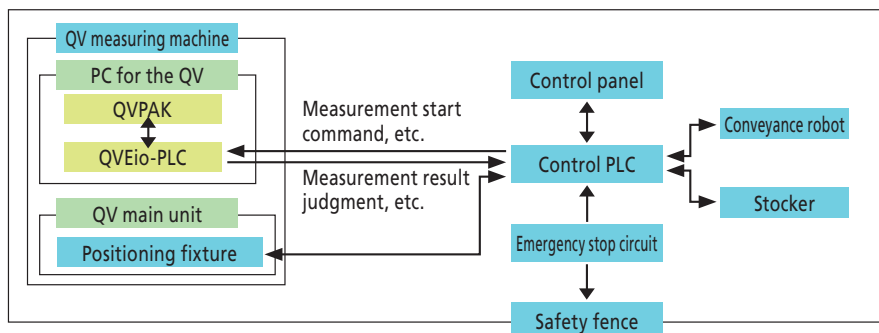



## Status Monitor

Can remotely monitor measuring machines



MTConnect®



Server

- Collects and visualizes operational status data
- Supports MT Connect communication



## MeasurLink®

Reduces defective products by visualizing quality

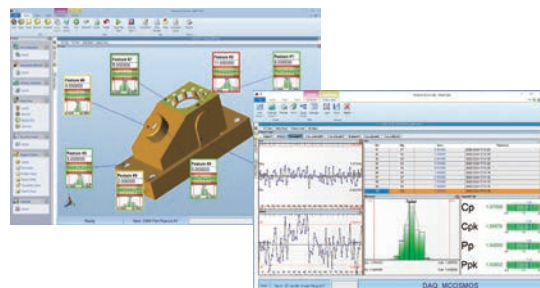

Note: MeasurLink® is a registered trademark of Mitutoyo Corporation in Japan and Mitutoyo America Corporation in the United States.

# INSPECTION

"DDPAK-QV" - software for the QUICK VISION Series that enables both flaw inspection and high-accuracy measurement

DDPAK-QV is a flaw inspection software for QUICK VISION. Utilized during measurement to inspect for flaws such as contaminants, burrs and cracks while performing high-accuracy non-contact measurement at the same time.

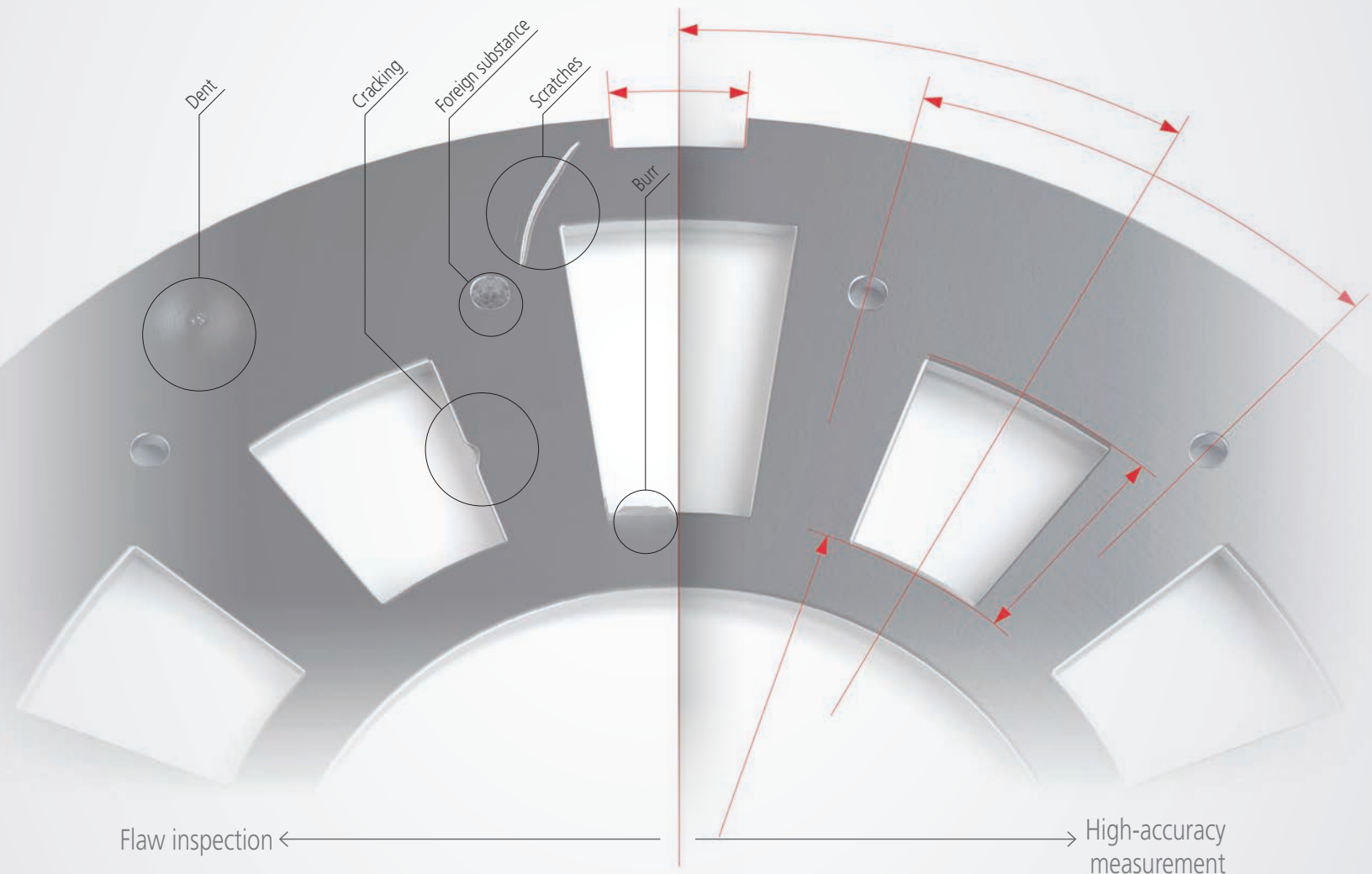

## DDPAK-QV

Flaw Inspection Software dedicated for CNC Vision Measuring System QUICK VISION

### Features

- Creates a seamless flaw inspection system that transfers the image data captured by the QUICK VISION Series to DDPK-QV, outputs the flaw coordinates and automatically saves the image.
- Measures the dimensions of a flaw and analyzes its shape. Analyzing the coordinate, size, depth, height and other statistics of a flaw can help analyze the cause, prevent recurrence, and improve the production process.
- You can add DDPK-QV, the flaw inspection software, to your QUICK VISION. Add the inspection feature to expand the applications of your QUICK VISION.

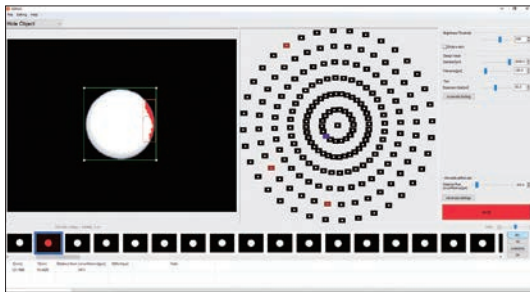

Inspection for foreign substances in shower head diameters



The image of the detected flaw turns red



Chipped blade

### Flaw detection example

Chip on glass



Cracked glass



Print blurring on an electronic part

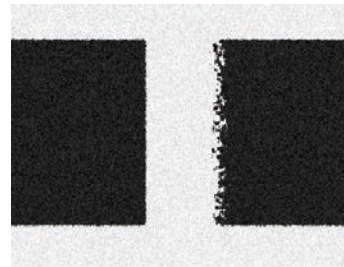

Foreign substance in a hole

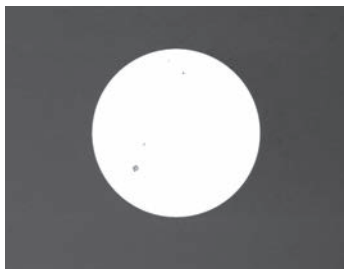

Scratched mirror-finished surface



Note: DDPK-QV is available to special order. For details on supported workpieces and flaws, contact your local Mitutoyo sales office.



**Whatever your challenges are, Mitutoyo supports you from start to finish.**

Mitutoyo is not only a manufacturer of top quality measuring products but one that also offers qualified support for the lifetime of the equipment, backed by comprehensive services that ensure your staff can make the very best use of the investment.

Apart from the basics of calibration and repair, Mitutoyo offers product and metrology training, as well as IT support for the sophisticated software used in modern measuring technology. We can also design, build, test and deliver measuring solutions and even, if deemed cost-effective, take your critical measurement challenges in-house on a sub-contract basis.



**Find additional product literature and our product catalog**  
[www.mitutoyo.com](http://www.mitutoyo.com)

**Note:** All information regarding our products, and in particular the illustrations, drawings, dimensional and performance data contained in this printed matter as well as other technical data are to be regarded as approximate average values. We therefore reserve the right to make changes to the corresponding designs. The stated standards, similar technical regulations, descriptions and illustrations of the products were valid at the time of printing. In addition, the latest applicable version of our General Trading Conditions will apply. Only quotations submitted by ourselves may be regarded as definitive. Specifications are subject to change without notice.

Mitutoyo products are subject to US Export Administration Regulations (EAR). Re-export or relocation of our products may require prior approval by an appropriate governing authority.

**Trademarks and Registrations**  
 Designations used by companies to distinguish their products are often claimed as trademarks. In all instances where Mitutoyo America Corporation is aware of a claim, the product names appear in initial capital or all capital letters. The appropriate companies should be contacted for more complete trademark and registration information.

# Mitutoyo

**Mitutoyo America Corporation**  
[www.mitutoyo.com](http://www.mitutoyo.com)  
 One Number to Serve You Better  
 1-888-MITUTOYO (1-888-648-8869)

- Mi<sup>3</sup> Solution Centers:**
- Aurora, Illinois (Headquarters)
  - Boston, Massachusetts
  - Charlotte, North Carolina
  - Cincinnati, Ohio
  - Detroit, Michigan
  - Los Angeles, California
  - Seattle, Washington
  - Houston, Texas