

LEITZ ORTHOPLAN[®]

Universal Widefield Microscope
to customers' specifications

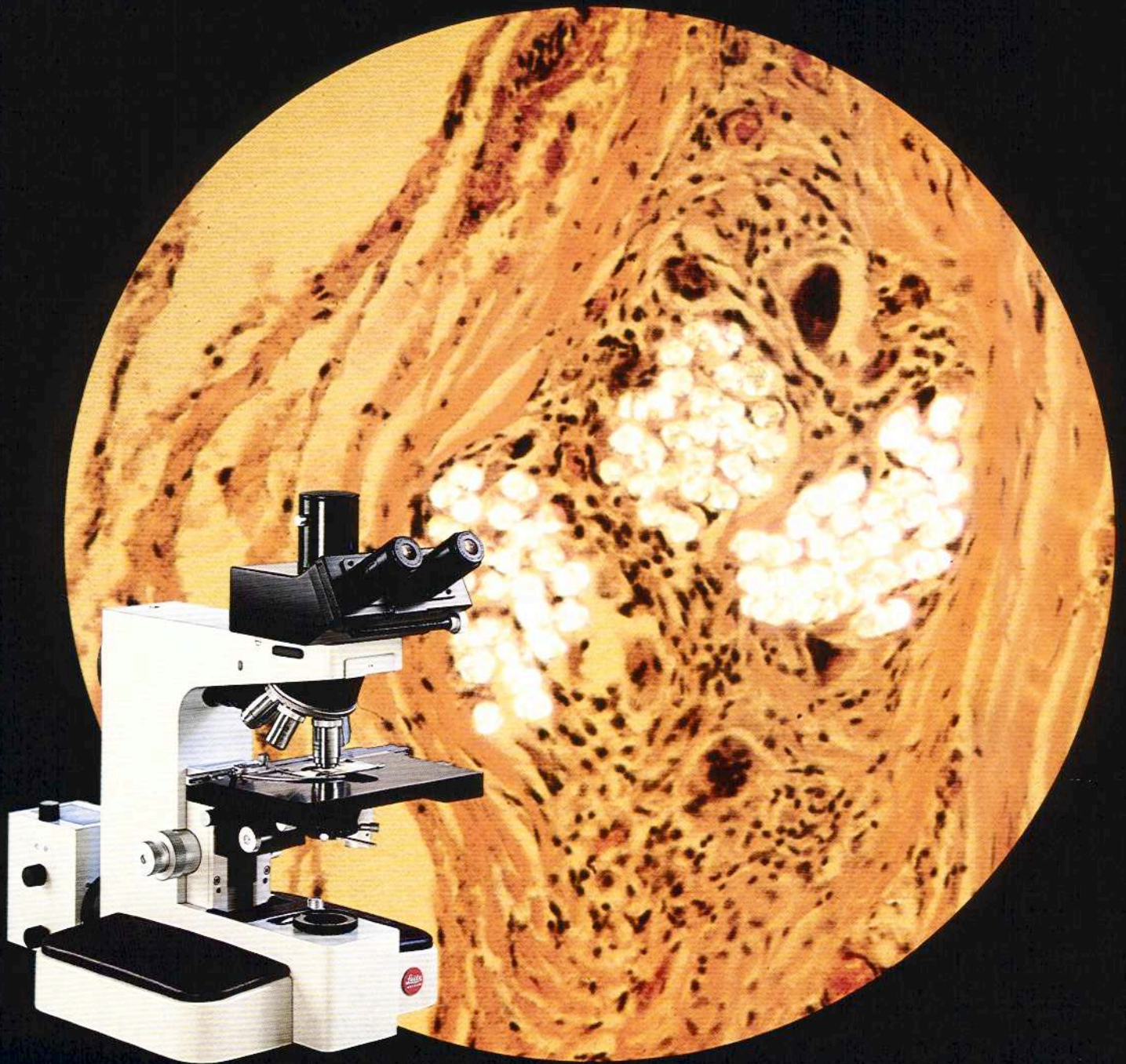



LEITZ ORTHOPLAN

Widefield microscopy

LEITZ plan-apochromats for fields of view of up to 28 mm dia., flat right up to the periphery.

Binocular photo tube for widefield eyepieces of 30mm dia., i. e. utilization of the objective performance up to field-of-view index 28.

This ensures considerable gain in information.

In this context, outstanding optical performance means added image detail and improved identification of features

Nucleus of a complete system of optical microscopy

Central component for all methods of microscope illumination and observation in transmitted and in incident light:

brightfield, darkground, phase contrast, interference contrast, polarized light, fluorescence microscopy, micro-interferometry.

Light sources, condensers, object stages, objective carriers and tubes can be interchanged with a few manipulations.

All microscope attachment cameras of the Wild and Leitz range can be used.

It is also available as LEITZ METALLOPLAN version for the examination of plane and polished sections of solids (see List No. 560-24).

as LEITZ ORTHOPLAN-POL version for observation and measurement in polarized transmitted and incident light, (see List No. 550-53).

as optical unit for quantitative microscopy with the LEITZ MPV microscope photometer system and for electronic image analysis, (see Lists No. 620-20 and No. 621-042).

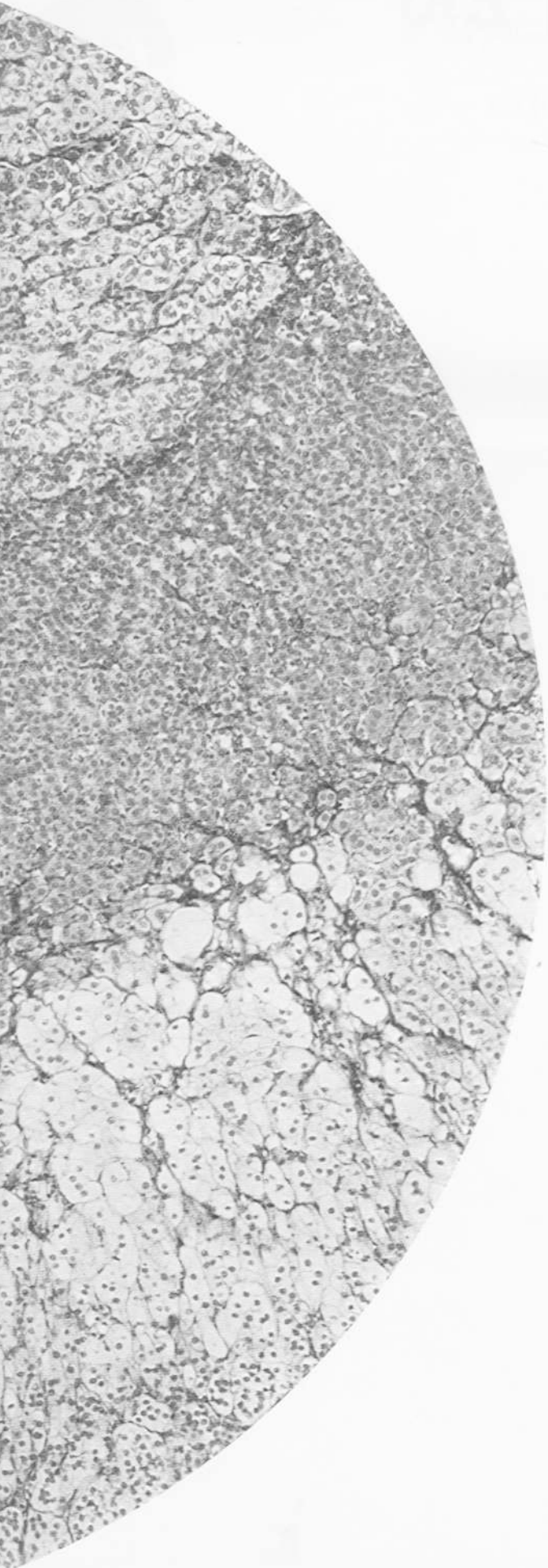

The LEITZ ORTHOPLAN

has the structural characteristics that make it optically and mechanically a widefield microscope.

The high field-of-view indices of up to 28 are the result of its equipment with new

- plano objectives (apochromats) corrected for optimum sharpness right to the periphery of the image, maximum definition, and contrast
- widefield eyepieces of 30mm diameter
- widefield observation tubes and suitably dimensioned illuminators

The Result

is evident from this comparison of the field of view of a microscope of field-of-view index 18 (right) with that of the LEITZ ORTHOPLAN of field-of-view index 28. This means an increase of up to 2.4x of the object area at the same reproduction ratio.

Comparison of the fields of view

Eyepiece	Eyepiece diameter	Field-of-view index	Field of view in %
PERIPLAN® GF 10x	23.2 mm	18	100
PERIPLAN GW 10x	24 mm	24	173
PERIPLAN GW 8x	30 mm	28	242
PERIPLAN GW 6,3x	30 mm	28	242

Photographs: R. Baensch, Applied Microscopy Laboratory, LEITZ Works
Specimen: J. Lieder, Ludwigsburg

Why do you see more detail and identify features more clearly in the LEITZ ORTHOPLAN?

How much you can see in a microscope without moving the specimen depends on the field-of-view index of the eyepiece.

How clearly you can identify the information offered by the specimen depends on the state of correction of the objective. Image quality of classical micro-optical systems decreases towards the periphery of the field of view so that it would not be worthwhile to present fields of view of diameters larger than 18mm, although with binocular observation a field of view up to 28mm would be acceptable.

In the entire magnification range, including oil immersion, of the Leitz plano objectives the complete flattening of the intermediate image provides, for the first time, optimum physiological viewing conditions. In addition, the apochromatic correction of this series has reached the ultimate limits of detail resolution, definition, colour purity, and contrast in optical microscopy.

This accounts for the large binocular tube of the ORTHOPLAN and the GW eyepieces of 30mm diameter!

Method of investigation	Recommended objectives	Recommended eyepieces
Transmitted light:		
Brightfield	Plan-apochromats	GW
Darkground	Plan-apochromats NPL FLUOTAR	GW (GF)
Phase contrast	Plan-apochromats NPL FLUOTAR	GW GF
Fluorescence	Plan-apochromats NPL FLUOTAR	GW
Interference contrast	NPL achromats (interference contrast)	GF
Polarized light (qualitative investigations)	Plan-apochromats NPL FLUOTAR	GW
Incident light:		
Darkground (ULTROPAK)	UO objectives	GF
Fluorescence	NPL FLUOTAR	GW
	Special oil and water immersion objectives	GW GF

The microscope stand

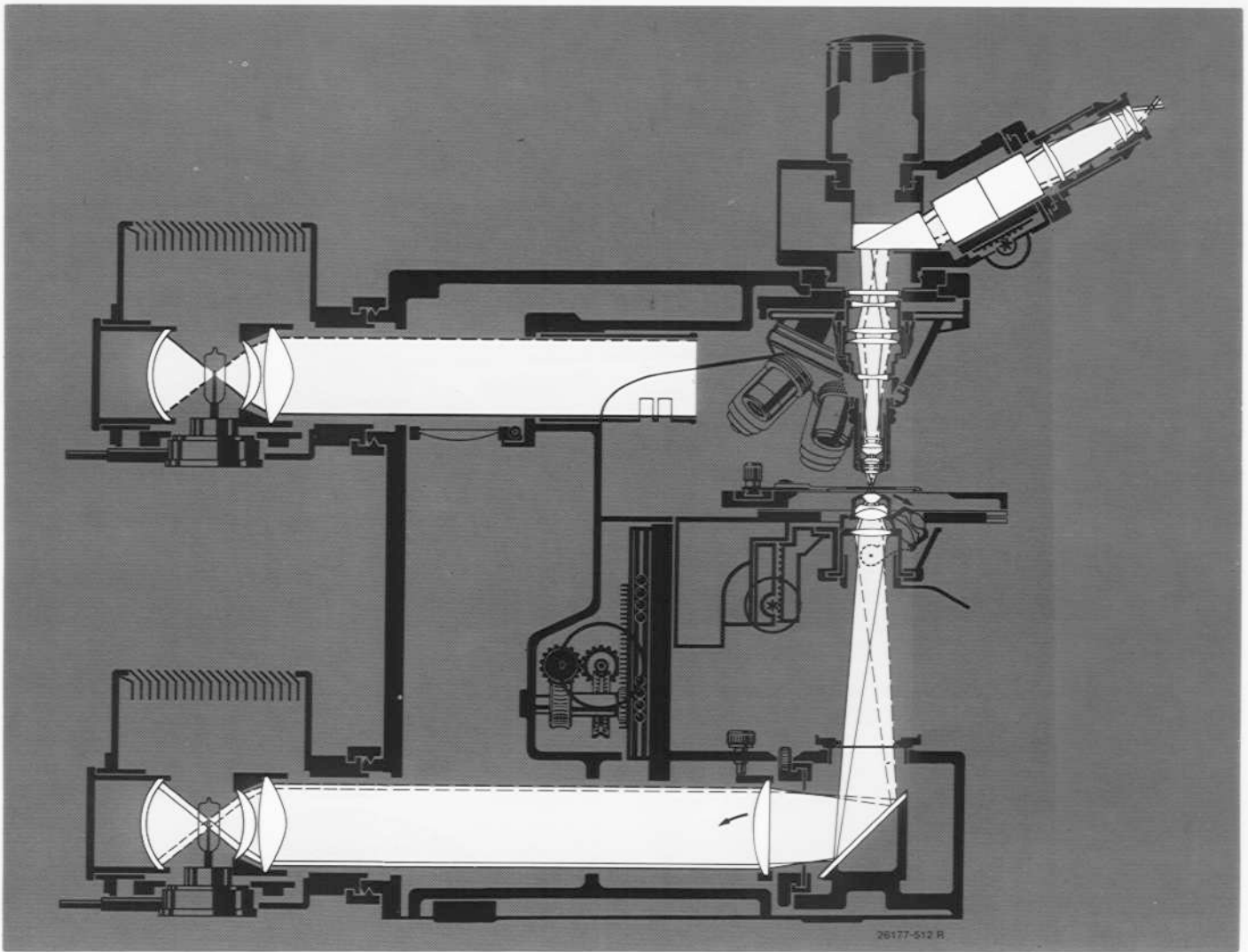

Compact design, vibration damping support of the 30x30 cm foot and high mechanical rigidity meet all requirements of effective protection from shock and of the steadiness of the settings.

Coarse and fine adjustment are incorporated in a dustproof casing in the microscope and actuate the object stage. The fine adjustment acts continuously within the entire 40mm range of travel. The controls are co-axial and arranged conveniently above the hand rests on the foot of the stand.

One interval on the drum of the fine adjustment corresponds to a travel of $1\mu\text{m}$.

A swing-out illuminating lens, a field diaphragm and the reflecting mirror are built into the foot of the stand. A filter slot in the upper part of the stand accommodates slides with light or polarizing filters of 25mm diameter. Two bayonet fittings for the attachment of the lamp housings for transmitted light and/or incident light illumination are mounted in the back of the stand.

The FSA-GW binocular photo tube

The FSA-GW tube supports the GW eyepieces of 30mm diameter and combines the properties of an observation and of a photo tube.

This means that with the adjustment of the observation eyepieces for the individual interpupillary distance the mechanical tube length does not change. As a result, sharpness is identical both in the observation and film plane for any interpupillary distance set and is determined in the binocular tube also for photomicrography. This obviates additional focusing of the image in a special focusing telescope with the Leitz and Wild attachment cameras of fixed extension.

Another interesting feature: a beam splitter built into the tube transmits 20% of the light to the eyepieces even during the actual exposure, ensuring uninterrupted observation during photography (it is not even disturbed by the shutter bounce, because the shutters of the Leitz attachment cameras are vibration-damped).

In very critical cases the beam splitter (80% of the total light flux for photography and 20% for observation) can of course be disengaged to permit the entire light flux to reach the eyepieces (e. g. for the observation of very weak fluorescence).

Besides the binocular photo tube a monocular version (FP-GW) can be supplied for the LEITZ ORTHOPLAN.

The vario tube

The vario tube serves for the continuous variation of the final magnification from 1x to 3.2x during visual observation and photomicrography.

It can be inserted between the stand and the binocular tube of the LEITZ ORTHOPLAN. The lateral control has a scale indicating the magnification factor set. Once the image is focused it remains sharp within the entire adjustment range.

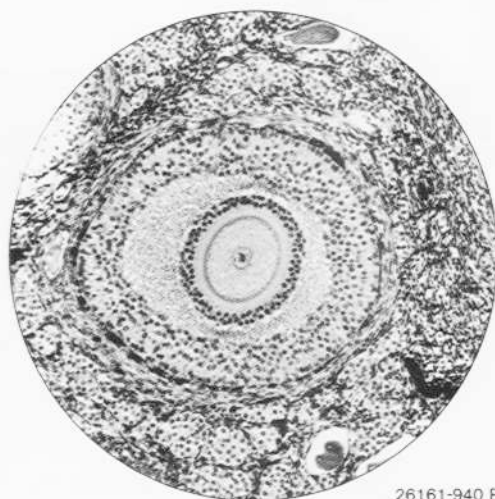

Factor 1

26161-940 R



Factor 2.9

26162-940 R

The revolving nosepiece

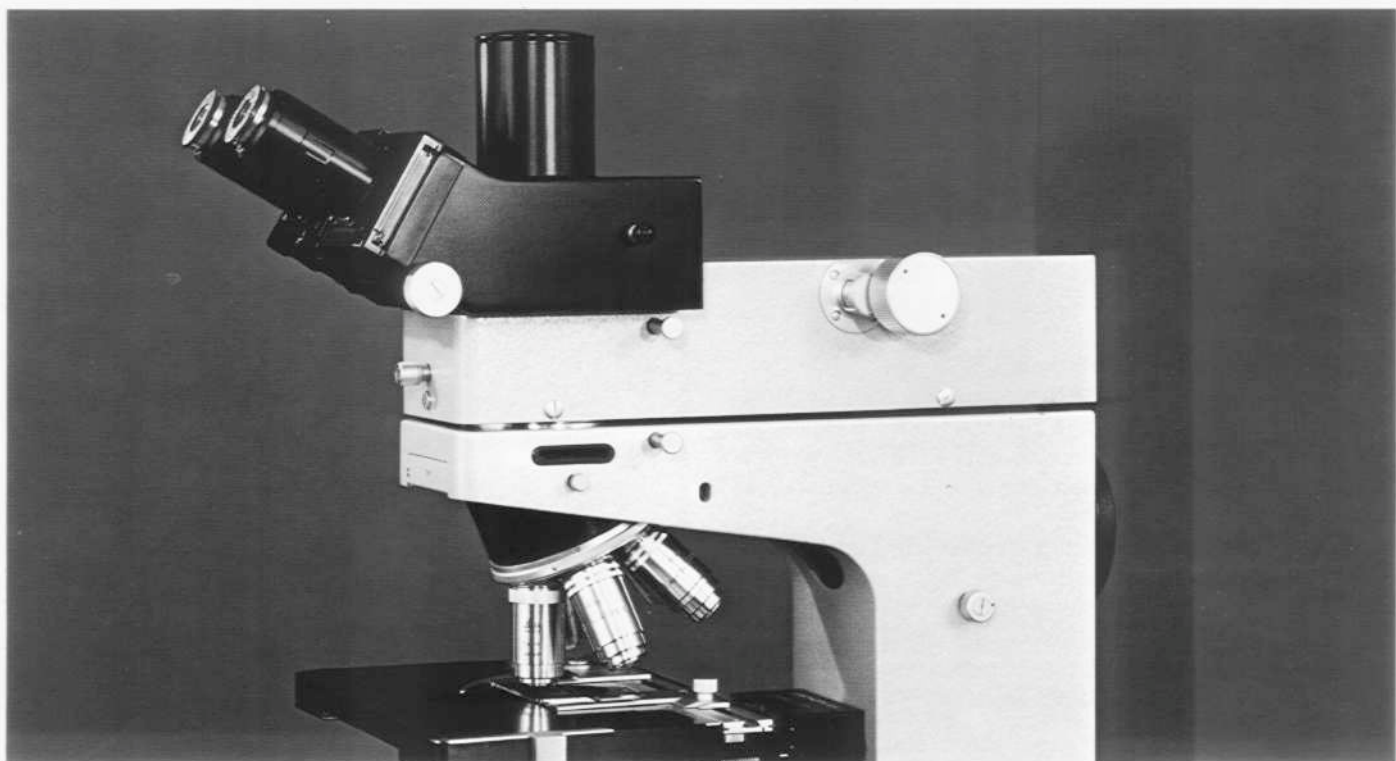

A slide with rotary knob on the front of the vario tube serves for the insertion in the beam and for the focusing of an auxiliary lens for the precision centration of the phase contrast device.

Code No. 512 307

The revolving nosepiece accepts five objectives. It runs on ball bearings and has internal click stops so that the centre of the image set remains in almost the same place after each magnification change. The revolving nosepiece is changed by insertion in a horizontal dovetail guide.

This nosepiece is available in two versions:

1. With tube lens 1x for PL APO plano objectives and eyepieces of field-of-view indices of up to 28.

Code No. 512 169

2. With tube lens 1.25x for NPL FLUOTAR objectives and eyepieces of field-of-view indices of up to 24 and for objectives and eyepieces of field-of-view indices of up to 18 (with eyepiece collars)

Code No. 512 170

Eyepieces		Magnifications
GW 6.3x		6.3x-20x
GW 8x	+ vario tube	8x-25x
GW 10x		10x-32x

The object stages

Part of the standard outfit of the LEITZ ORTHOPLAN is the oblong Mechanical Stage No. 660, running on ball bearings and with low-set co-axial controls for the x and y movement, conveniently sited above the hand rest on the foot of the stand.

Stage area: 210mm x 150mm

Scanning area: 76mm x 50mm

Vernier reading of the stage adjustment in both directions; accuracy 0.1mm

Code No. 512 460

On request:

Circular rotating object stage No. 963

Diameter 150mm. The stage top can be centred, detached, and interchanged against the Heating Stage 80 (see page 13). The centring device enables adjustment of the object in any desired position within limits. Code No. 512 368

Circular rotating and centring mechanical stage No. 930

Diameter 150mm, rotation through 360°, centrable. Mechanical adjustment with detachable object guide, scanning area 76mm x 26mm, vernier reading of the object position, accuracy 0.1mm, rotation and Y-movement can be clamped in any desired position.

The rotating and centring mechanical stage permits the use of the Leitz microscope Heating Stages 350, 1350, and 1750 (see p. 13) Code No. 512 454

Other object stages of special design, e. g. for investigations in semiconductor manufacture or for electronically-controlled microscopic scanning methods, are available on request.

All stages can be vertically adjusted in a dovetail guide and interchanged, irrespective of the coarse and fine adjustment for object alignment.



13801-513 R

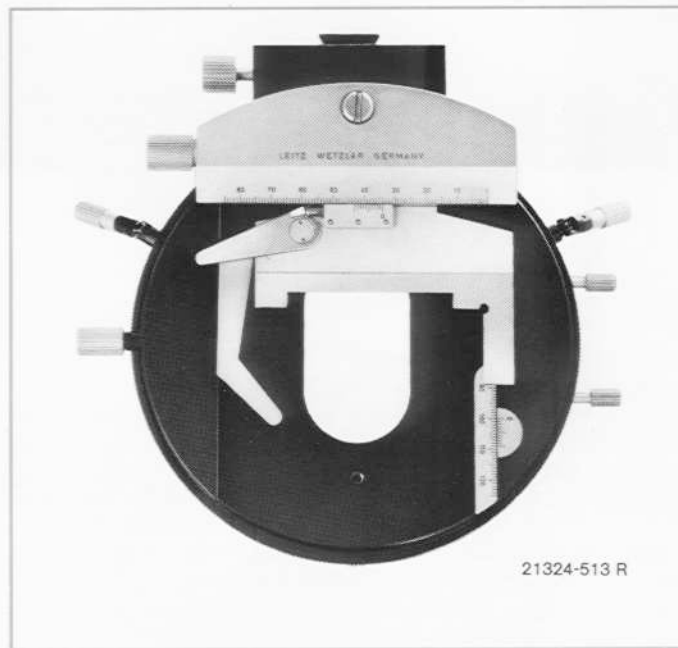

21324-513 R

The condenser system



System condensers

Transmitted-light brightfield

Ref. No. Code No.	Description	Use
600 512 081	Condenser bottom part, A 0.25, with aperture diaphragm, condenser for low powers	For objectives of up to A 0.25. Large fields at low magnification can be illuminated
002 512 083	and 3-lens condenser top Achr. 0.90 produces	
602 512 086	achromatic system condenser Achr. 0.90	For all objectives and routine work in brightfield.
003 512 084	or 4-lens condenser top Apl Oil 1.25 produces	
603 512 087	achromatic-aplanatic system condenser Apl. Oil 1.25 , state of correction similar to that of the condenser 602 at large aperture	Mainly for work with highly corrected oil immersion objectives. Not suitable for fluorescence.

Investigations in transmitted light can be carried out with the LEITZ ORTHOPLAN widefield microscope with condensers for brightfield, darkground, phase contrast and interference contrast and in combination with all the Leitz objectives provided for the relevant type of illumination. All condensers can be interchanged on a horizontal dovetail guide and are vertically adjustable by rack and pinion.

The achromatic system condenser No. 602 with swing-out condenser top, aperture 0.90 is part of the basic optical outfit of the microscope. Because of its good optical properties it is suitable for all investigations and photomicrography in brightfield. The 3-lens condenser top can be replaced, especially for investigations of objects of considerable thickness, with condenser tops of long intercept distances (see table).

With the observation of the finest object details and photomicrography with apochromatic oil immersion objectives (e. g. PL APO 100/1.32 OEL) optimum results can be achieved with the use of the aplanatic condenser top, aperture 1.25 (oil immersion).

For long intercept distances

Ref. No. Code No.	Description	Working distance	Corrected for
605 512 311	Achromatic condenser No. 605, A 0.70, consisting of bottom part 600 and condenser top 005, engraved achr. 0.70/L4	4mm	4mm glass, water, agar-agar, etc.,
606 512 312	Non-achromatized condenser No. 606, A 0.60, consisting of bottom part 600 and condenser top 006, engraved 0.60/L 11	11mm	11mm, of which about 6mm glass etc.
607 512 533	Non-achromatized condenser No. 607, A 0.45, consisting of bottom part 600 and condenser top 007, engraved 0.45/L 20	20mm	20mm, of which about 6mm glass etc.

The condenser system

For transmitted-light darkground observation

Dry darkground condenser	D 0.80-0.95 Code No. 513 356
Immersion darkground condenser	D 1.20-1.40 Code No. 513 355

Suitable for conventional objectives up to oil immersion (with funnel stop or iris diaphragm and for plano objectives of up to 0.75 aperture.

Widefield phase contrast

For investigations in phase contrast, brightfield, and dry darkground. Condenser with annular-diaphragm turret for phase contrast objectives of 10x to 100x primary magnification.

6 click-stop positions:

- H = brightfield
- 1, 2, 3, 4 = light rings for phase contrast objectives of the various magnification stages
- 5 = darkground

With this equipment the halo phenomenon apparent with all phase contrast optical systems in the microscopic image is so negligible that even routine investigations of thick sections are possible without difficulty. Above all, however, the new PHACO PL APO objectives allow phase contrast investigation of the most minute object detail up to maximum magnification at full utilization of the extremely large fields of view of the LEITZ ORTHOPLAN.

Details see p. 21.

Phase contrast photograph (black and white)

Candida albicans in urinary deposit
PL APO 40/0.75 PHACO 2
Eyepiece: ORTHOMAT-W setting 3.2x
128mm x on 35mm negative

Interference contrast photomicrograph (colour)

Triple phosphates in urinary deposit
NPL P 16/0.40
PERIPLAN 6.3x
100x on 9cm x 12cm transparency

Photographs by E. Hohn, Applied Microscopy Laboratory

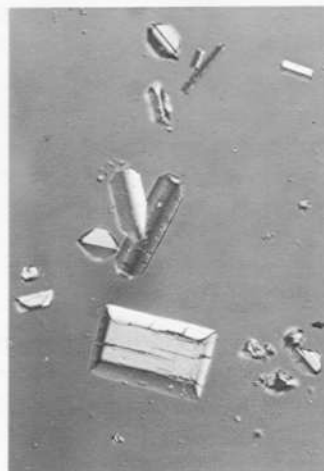
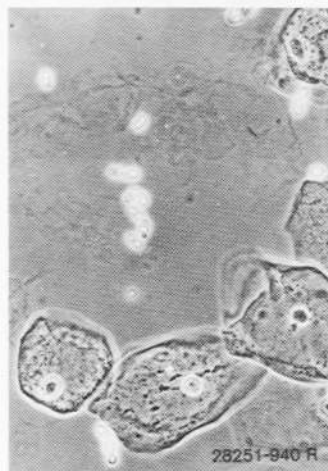
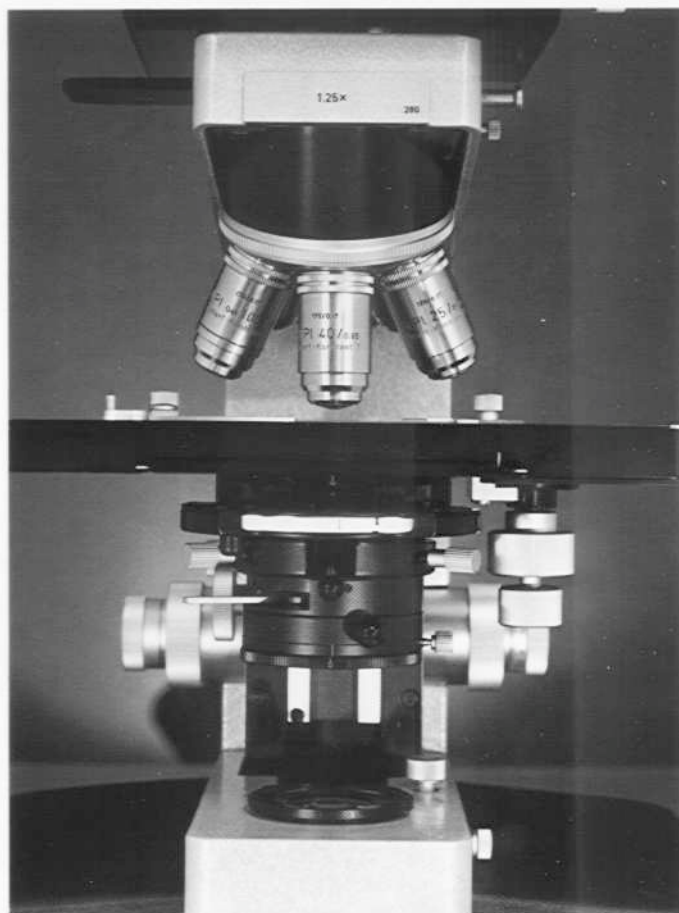

Interference Contrast Device T

For the contrasty, relief-like and halo-free rendering of finest structures in transmitted light according to the principle of two-beam interference. The special optical conditions on which this type of observation is based prevent the achievement of the extreme flatfield performance of the objective. They should therefore be employed only with eyepieces of field-of-view index 18.

The NPL 16/0.40 or NPL 25/0.50, NPL 40/0.65 and NPL OEL 100/1.30 interference contrast objectives are permanently mounted on the quintuple objective revolving nosepiece with 1.25x intermediate optical system. The two remaining empty positions are provided for plano objectives for the alternative observation in phase contrast or in ordinary brightfield.

The condenser, equipped with a pre-polarizer, incorporates a rotating turret with 6 positions, 3 of which contain the Wollaston prisms associated with the interference contrast objectives. The others include a light ring for the phase contrast objectives 10:1 and 16:1 and two empty positions for brightfield and phase contrast respectively.

For details see p. 21 and List No. 550-39.

The ULTROPAK® incident-light illuminator

allows investigations of the surface of opaque objects such as fresh tissue specimens, bone, grain and powder samples, wood, textiles etc. A permanently built-in annular mirror in conjunction with the annular condenser of the interchangeable UO objectives produces a concentric illumination of the object (incident-light darkground) independent of the observation beam. This gives irregularities in the surfaces to be investigated a plastic and contrasty appearance. Special immersion attachments permit the observation of objects in liquids.

Primary magnification of the UO objectives from 4:1 to 60:1. UO objectives of higher magnification on request.

Recommended eyepieces: field-of-view index of up to 18. For details see List No. 513-146.

Investigations in polarized transmitted light

can be carried out with the aid of two polarizing filters on the LEITZ ORTHOPLAN for the localization of birefringent components of transparent objects. For this purpose the rotating polarizer is attached below the condenser, and the analyser inserted in the filter slot below the observation tube.

Code No. 513 201

A rotating stage attachable to the mechanical stage facilitates these investigations

Code No. 512 014

For precise polarized-light determinations and measurements in transmitted and incident light the special LEITZ ORTHOPLAN-POL outfit is available.

For details see List No. 550-053.

Microscope heating stages

All Leitz microscope heating stages can be used on the LEITZ ORTHOPLAN for the study of temperature-dependent reactions in organic or inorganic objects.

The Microscope Heating Stage 80

is equipped with an automatic temperature regulator especially for biological investigations. It is provided for temperatures from -20 to 80° C and is eminently suitable, for instance, for the culture and observation in vivo of micro-organisms.

For details see List No. 515-008

The Microscope Heating Stage 350

serves for the observation of thermal reactions in transmitted and incident light at temperatures from -30 to 350° C.

For details see List No. 515-033

The Microscope Heating Stage 1350

permits investigations in transmitted and incident light at temperatures of up to 1350° C.

For details see List No. 515-073.

The Microscope Heating Stage 1750

is provided for high-temperature investigations of solids (metals, ores, ceramic substances etc.) in incident light. This places it mainly in the field of applications of the LEITZ METALLOPLAN widefield microscope.

For details see List No. 560-024 and 515-063.

The LEITZ ORTHOPLAN as fluorescence microscope

Trypanosomes, Morin, PL APO 25/0.65 GW 10x

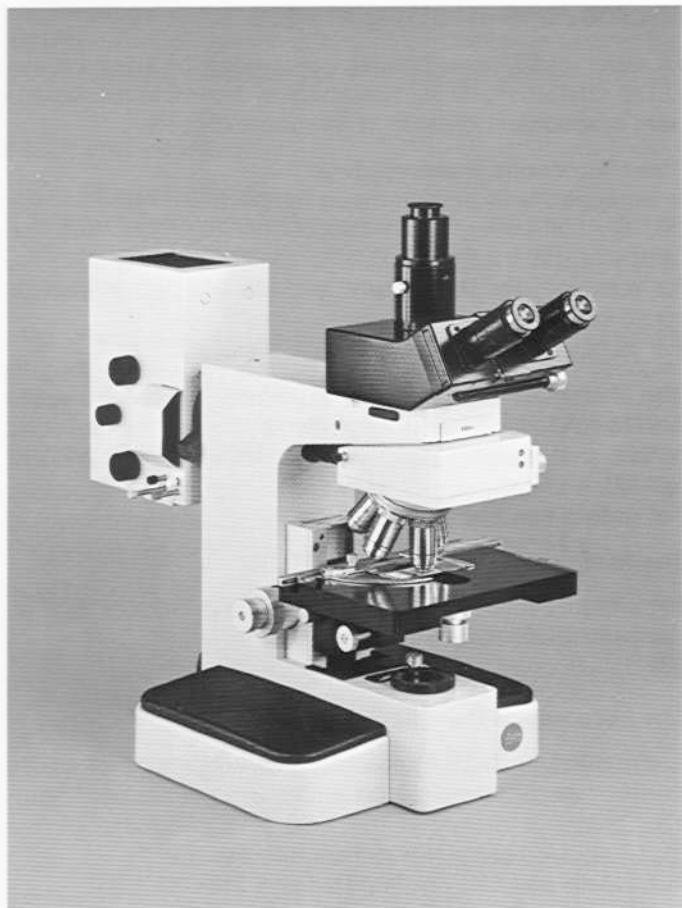
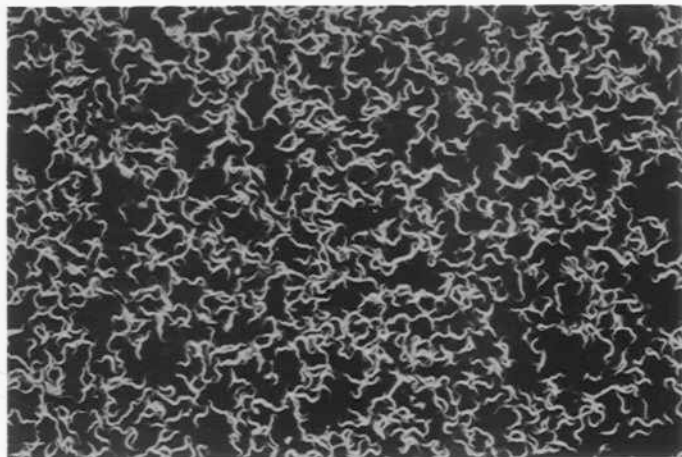

Transmitted-light excitation

of fluorescence is generally produced by UV or blue light through a darkground condenser of large aperture. See p. 12. In the simplest case a 50W ultra-high-pressure mercury lamp, an exciting filter, and a suppression filter will be adequate (FITC routine fluorescence).

The Leitz transmitted-light fluorescence device with fluorescence filter turret

The transmitted-light fluorescence equipment allows the use of the modern methods of immuno fluorescence side by side with the classical methods. This includes the application of multi-wave-length methods as an alternative proof of different fluorochromes. The equipment consists of a revolving turret for 3 filter systems and 1 free position for the application of all other transmitted-light methods as well as of a slide with 4 suppression filters.

The filter systems are built up to meet the specific excitation characteristics.

Revolving disc for 3 filter systems Code No. 513 456

The LEITZ PLOEMOPAK® 2.1 fluorescence vertical illuminator

Incident-light excitation is considerably more effective especially at medium to high magnifications, because unlike in transmitted-light fluorescence, the exciting light is not attenuated by the thickness of the object. Moreover, its intensity increases with increasing aperture.

A changing device for three filter blocks is built into the LEITZ PLOEMOPAK 2.1. It permits the instant change of the spectral region of the excitation. In addition, each filter block can be conveniently interchanged and therefore freely selected. It consists of the exciting filter, the dichroic beam splitter, and the suppression filter on a common filter seating. The new filter block will be automatically aligned in the optical path of the microscope. A special clamping device in the filter changer allows the change-over between two neighbouring filterblocks at will. This possibility is used particularly when the specimen under investigation has been treated with two fluorochromes which have to be excited with different light wave lengths.

For details see Lists No. 512-125 and 513-159.

The light sources

The Lamp Housing 100

with 12v 100W tungsten halogen lamp belongs to the basic outfit of the ORTHOPLAN widefield microscope and is a suitable light source for observation and photomicrography in brightfield, darkground, phase and interference contrast.

The 100Z version

has an externally operated centring device for all the elements of illumination. This makes it particularly well suited for gas discharge lamps of up to 100W and for use in fluorescence microscopy und microscope photometry.

Depending on their position on the microscope both versions serve as transmitted or incident-light illuminators. In conjunction with the Mirror Housing 250S two Lamp Housings 100 (Z) with various light sources can be attached at the same time.

The Lamp Housing 500 with Mirror Housing 500

serves for incident- or transmitted-light illumination with light sources from 150 to 450W. The change-over from one type of illumination to the other is very simple with a hinged mirror.

Light sources	xenon lamp	150W
	mercury lamp	200W
	halogen arc lamp	250W
	xenon lamp	450W

For all work that does not call for such high light output and for observation through the binocular tube the Mirror Housing 500 is additionally fitted with a Lamp Housing 100. It can be used for mixed-light illumination simultaneously with the Lamp Housing 500.

The Lamp Housing 250

can be attached for transmitted- or incident-light illumination together with the Mirror Housing 250S or Mirror Housing 500 to the ORTHOPLAN stand. Suitable light sources:

Mercury lamps up to 200W	For qualitative and quantitative fluorescence microscopy.
Xenon lamps up to 150W	For photomicrography and cinemicrography, microscope photometry, microprojection
Arc halogen lamp 250W	For micro-projection, photomicrography, cinemicrography

Spectrum lamps

The Mirror Housing 250S permits the simultaneous attachment of a Lamp Housing 100 or 100Z for the alternative use through operation with a hinged mirror.

LEITZ ORTHOPLAN widefield microscope with Lamp Housing 500 and 450W xenon lamp.

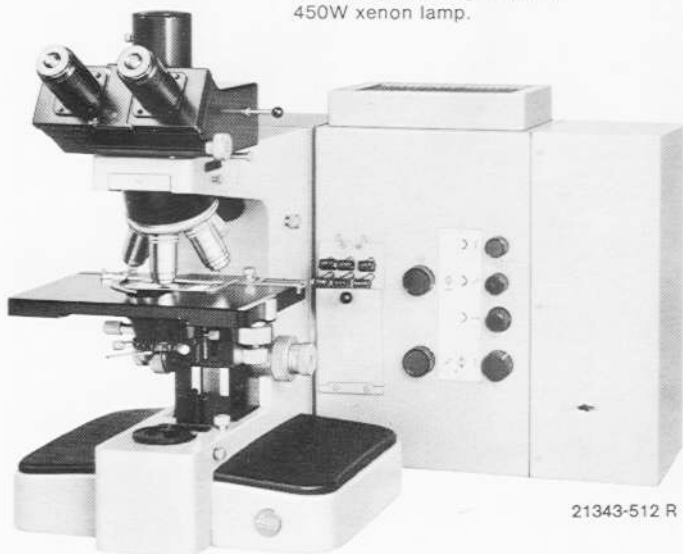

21343-512 R

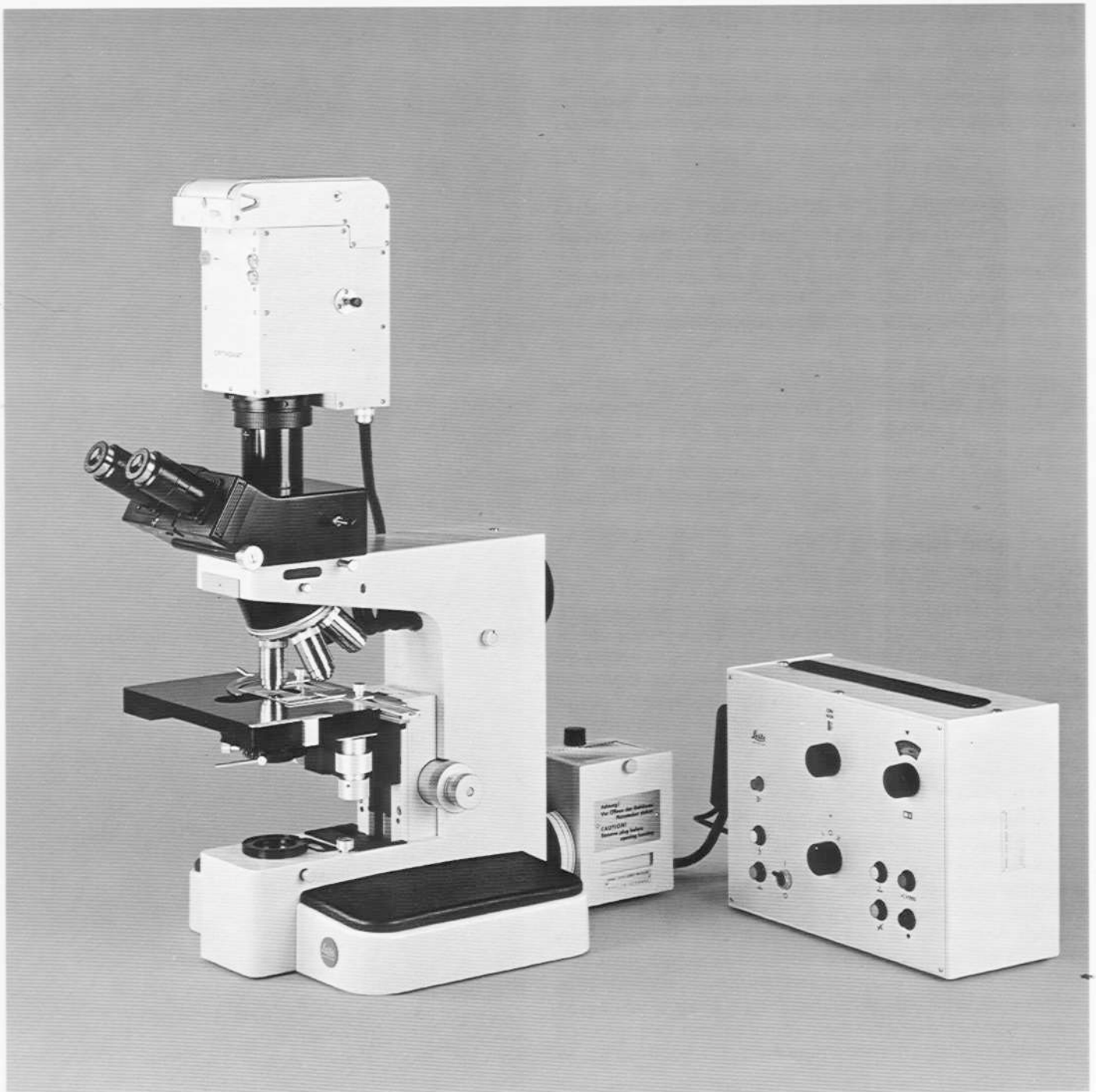

Photomicrography

All the photomicrographic attachments of the Wild and Leitz production programme can be used on the ORTHOPLAN.

In this context of automatic microscope cameras, however, the ORTHOMAT-W, the COMBIPHOT-AUTOMATIC attachment camera, and the large-format camera with automatic exposure control must be mentioned. With their attachment the ORTHOPLAN becomes a photomicroscope of outstanding performance.

LEITZ ORTHOMAT®-W

Fully transistorized microscope camera for the 35mm format.

Automatic exposure measurement by photomultiplier, integrating the entire field covered by the format, or detail measurement of a portion of the image essential to the subject of the photomicrograph (darkground, fluorescence).

Automatic film transport after each exposure. Magnifications of camera factors 2:1, 2,5:1, 3,2:1 can be set with continuous transition. This ensures optimum utilization of the size of the negative (corresponding to field-of-view indices up to 22).

Setting up and focusing the image in the binocular tube. (Field-of-view indices up to 28).

Exposures from 1/200sec up to unlimited exposure times.

The LEITZ ORTHOMAT-W is an independent modular unit and can be used also on the binocular photo tube of other Leitz microscopes at any time.

For details see List No. 540-039.

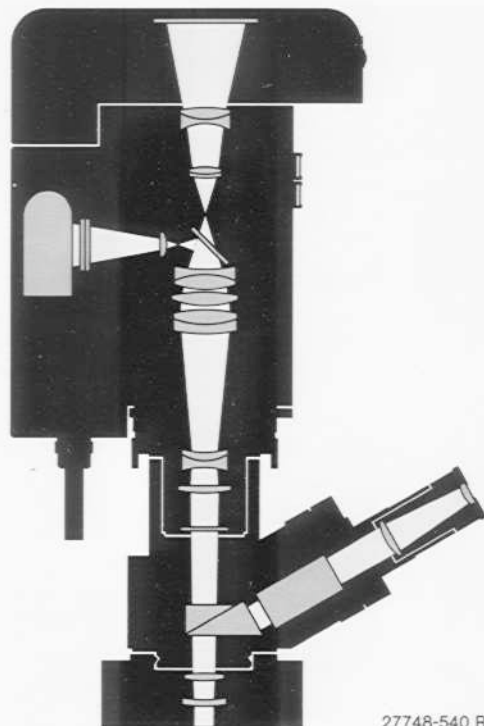

LEITZ ORTHOMAT-W Diagram of the optical path

27748-540 R

LEITZ ORTHOMAT-W Electronic switch unit

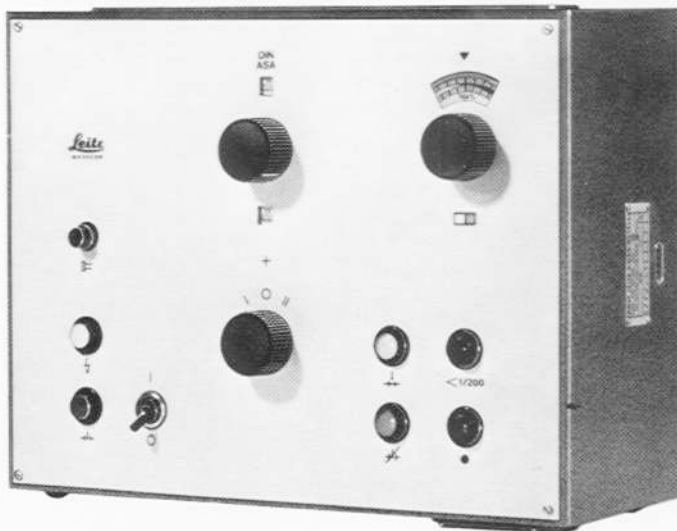

26370-540 R

Photomicrography

LEITZ COMBIPHOT-AUTOMATIC (right)

Attachment camera with automatic exposure control. Interchangeable camera bodies for the 24mm x 36mm, POLAROID 3 1/4in x 4 1/4in and 9cm x 12cm (4in x 5in) formats at the best utilization of the size of the negative (corresponding to field-of-view indices of up to 22). In conjunction with the vario tube (see p. 8) continuous adjustment of the final magnification and format-filling image.

Setting up and focusing of the image in the binocular tube (field-of-view indices up to 28).

Exposure times from 1/125sec to 5min at 18 DIN (50 ASA). Attachable to all Leitz microscopes with binocular photo tube FSA.

For details see List No. 540-37.

9cm x 12cm (4in x 5in) automatic large-format camera (left)

Bellows camera with automatic exposure control by photo-multiplier at any extension.

Fully transistorized electronics and electro-mechanical central shutter.

Rotating mirror-reflex attachment with international back for sheet film, plate, and POLAROID darkslides.

Practically unlimited exposure range.

Setting up and focusing of the image on the groundglass screen with clear-glass diagonals.

The camera carrier is required for the use of this camera on the LEITZ ORTHOPLAN largefield camera. It can be quickly attached to the lamp house fittings of the stand.

For details see List No. 540-028



21345-540 R

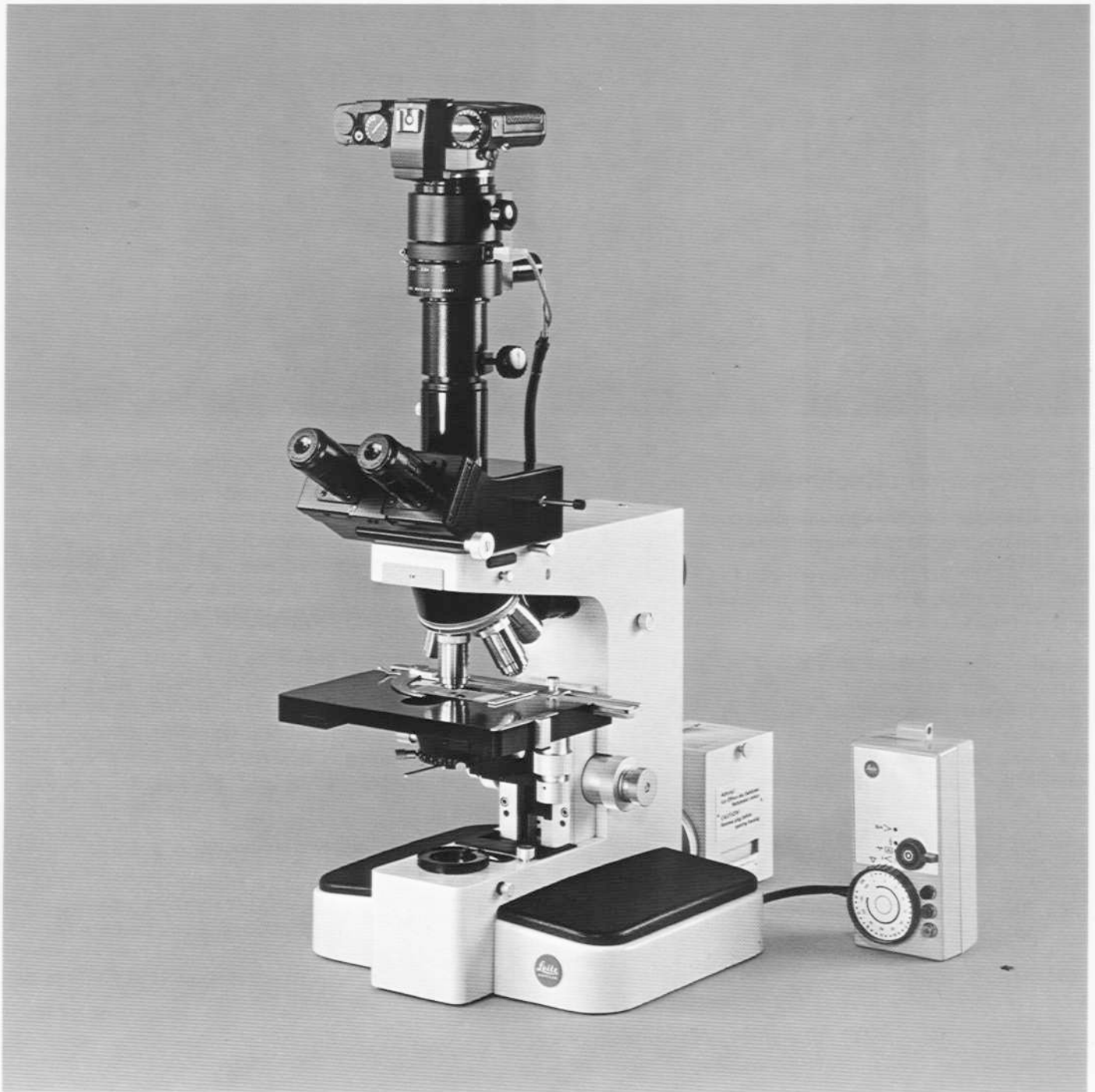

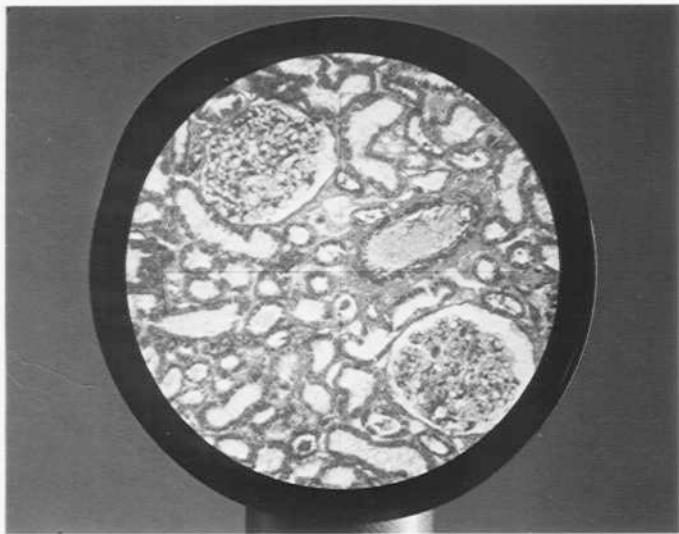

The projection attachment

For the rapid and convenient scanning of series of sections and demonstrations to a few persons:

Built-in PERIPLAN GF 10x eyepiece. The position of the image is identical with that in the binocular tube. Diameter of the groundglass screen 155mm. Code No. 513 138

Recommended light sources:
Lamp Housing 100 with 12v/
100W tungsten halogen lamp
or
Lamp Housing 250 with 250W
halogen arc lamp



21344-512 R

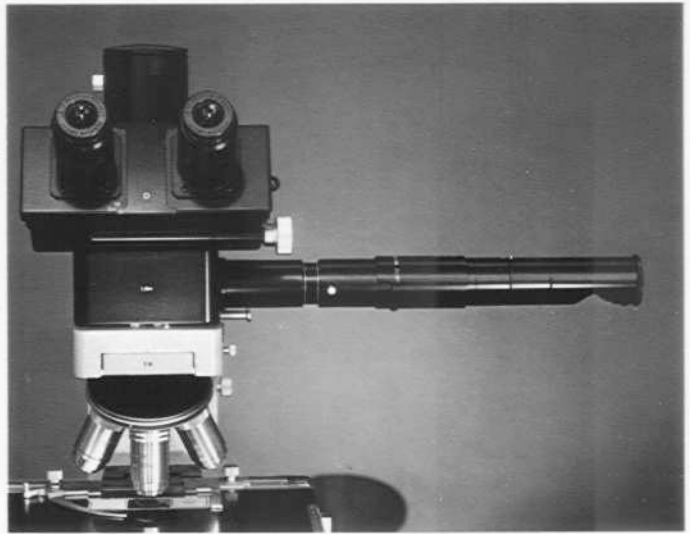

The tracing device

is mounted between the stand and the binocular tube. The image of the drawing surface illuminated by a table lamp is formed in the eyepiece plane via a beam splitter simultaneously with that of the object (coincident image method). The image can be magnified on the tracing surface up to a factor of 2. Code No. 513 325

The discussion tube

serves for the simultaneous observation of the microscopic image by three persons. An externally controlled arrow can be directed at any point of the field of view. Code No. 513 452

The device requires two additional observation tubes:
Binocular tube S Code No. 512 348

Outfits

ORTHOPLAN stand, quintuple revolving nosepiece, rack-and-pinion movement with dovetail changer for the condenser, FSA-GW photo tube, mechanical stage No. 660, Lamp Housing 100 with 12v 100W halogen filament lamp and filter set F (conversion filter CB12, diffusion disc, and green filter), condenser No. 602, storage case for accessories, dust cover. Code No. 512 624

Optical outfit

Objectives	
PL APO 6.3/0.20	519 592
PL APO 16/0.40	519 299
PL APO 25/0.65	519 527
PL APO 40/0.75	519 548
PL APO 100/1.32 OEL	519 383
10ml immersion oil	513 363
Pair of GW 10x M eyepieces	519 235

(Range of magnifications: 63-1000x)

Complete outfit, without mains unit 510 298

Mains unit with ammeter
for: 120-240v/50 and 60Hz 500 248

Accessories for phase contrast

Phase contrast condenser according to Zernike, with swing-out condenser top Achr. 0.90, built-in light rings and central diaphragm for darkground, individually centrable, aperture iris diaphragm, centring device in dovetail mount Code No. 513 140

Quintuple revolving nosepiece with tube lens 1x and dovetail changer 512 169

Objectives	
PL APO 16/0.40 PHACO 1	519 300
PL APO 25/0.65 PHACO 2	519 561
PL APO 40/0.75 PHACO 2	519 562
PL APO 100/1.32 OEL PHACO 3	519 678
10ml immersion oil	513 363
Pair of GW 10x M eyepieces	519 235
Focusing telescope	513 468

Accessories for interference contrast T

Interference contrast condenser with prepolarizer, quintuple revolving nosepiece with dovetail changer and the objectives NPL 25/0.50 P interference contrast T, NPL 40/0.65 P interference contrast T, NPL 100/1.30 OEL P interference contrast T

Complete outfit 553 273

Accessories for fluorescence investigations with incident-light excitation

PLOEMOPAK 2.1 multi-wave-length fluorescence vertical illuminator (without filter systems) 513 509

Grey filter 0.2% 514 031

Objectives	
25/0.60 W	519 578
50/1.20 W	519 376
100/1.20 W	519 649

or	
10/0.45 OEL	519 433
25/0.75 OEL	519 646
FL 40/1.30 OEL	519 473
63/1.30 OEL	519 532
100/1.25 OEL	519 618

10ml immersion oil 513 523

Pair of PERIPLAN GW 6.3x M eyepieces 519 596

or

Pair of PERIPLAN GW 4x \times eyepieces 519 486

Pair of PERIPLAN 6,3x M eyepieces 519 187

Pair of eyepiece adaptors 513 256

Lamp Housing 100Z with 100W Hg 514 237

Power unit 500 222

The following can be used instead of the Lamp Housing 100 Z with 100W Hg lamp:

Lamp Housing 250 with 200W Hg 514 148

Power unit for 220/240v, 50/60Hz 500 235

or

Lamp Housing 100Z with 50W Hg 514 236

Power unit 500 152

The following must be added to the Lamp Housing 250 with Hg 200W:

2 mm KG 1 heat filter 514 027



**Leitz means Precision.
World-wide.**

ERNST LEITZ WETZLAR GMBH

6330 Wetzlar, Tel. (06441) 29-1, Telex 483 849 leiz d
Subsidiary: Ernst Leitz (Canada) Ltd., Midland, Ontario

* = Registered Trademark
Design subject to alteration without notice

Cover picture:
Plastic surgery of the breast, foreign-body reaction

Bottom:
Cancer of the human thyroid, Ag.
Specimens and photomicrographs by Prof. Kracht, Dept. of Pathology,
Justus Liebig University, Giessen

