

HMI User Manual

TABLE OF CONTENTS

1.	GENERAL	8
1.1	INSTRUCTIONS.....	8
1.2	STANDARDS, CERTIFICATES AND APPROVALS	10
1.3	BASE STANDARDS FOR EMC & SAFETY	10
1.4	PROTECTIVE CLASS.....	10
1.5	TRANSPORT & STORAGE CONDITIONS	11
1.6	OPERATING CONDITIONS.....	11
1.7	LCD SPECIFICATIONS.....	12
1.8	PACKAGE CHECK LIST	12
2.	PRODUCTS OVERVIEW	13
2.1.1	Technical Specifications	13
2.1.2	Serial drivers (COM1/COM2).....	15
2.1.3	Ethernet drivers (RJ45).....	16
3.	ORDERING CODE	18
3.1	HMI ORDERING CODE	18
3.2	HMI SPARES PART LIST.....	19
3.2.1	HMI 4.3"	19
3.2.2	HMI 7" (Low cost).....	19
3.2.3	HMI 7" (High Performance).....	19
3.2.4	HMI 10"	20
3.2.5	HMI 15"	20
3.3	NETWORK OPTION MODULE PART NUMBERS	21
3.4	ACCESSORIES PART NUMBERS.....	21
3.5	PLC CABLES PART NUMBERS	21
4.	INSTALLATION.....	22
4.1	INSTALLATION	22
4.2	DIMENSIONAL DRAWINGS.....	23
4.2.1	Dimensional drawings of the HMI 4.3"	23
4.2.2	Dimensional drawings of the HMI 7"	24
4.2.3	Dimensional drawings of the HMI 10"	25
4.2.4	Dimensional drawings of the HMI 15"	26
4.3	MOUNTING	26
4.4	POWER SUPPLY	28
4.5	INTERFACES.....	30
4.5.1	COM1 port, DB9 male (RS232C).....	30
4.5.2	COM2 port, DB25 Female (RS232C/RS422/RS485)	31
4.5.3	COM3 (Network option card)	32
4.5.4	Ethernet.....	33
4.5.5	USB Host	33
4.5.6	SD slot.....	34
4.5.7	Sound input/Output	34
4.5.8	Digital input/Digital output.....	35
4.6	REAL TIME CLOCK	36
4.7	HMI RESET PROCEDURE	37
5.	SOFTWARE	41
5.1	PC SOFTWARE.....	41
5.1.1	Basic software - HMI Editing Software.....	41
5.1.2	Extensive software - HMI Editing Software Plus	41
5.1.3	Historical viewer	42
5.1.4	System Requirements.....	42
5.1.5	Software Installation.....	43

5.1.6	Accessories.....	43
5.1.7	Quick start.....	43
5.2	HMI FIRMWARE.....	44
5.2.1	HMI startup.....	44
5.2.2	Run.....	45
5.2.3	Project.....	45
5.2.4	Instrument.....	48
5.2.5	Touch Calibrate.....	52
5.2.6	System Info.....	53
5.2.6.1	Firmware update procedure.....	54
6.	HMI EDITING SOFTWARE.....	55
6.1	PROJECT STATUS.....	55
6.2	CREATE NEW PROJECT.....	56
6.3	MENU BAR.....	59
6.3.1	File.....	60
6.3.1.1	Environment.....	62
6.3.2	Edit.....	65
6.3.3	Format.....	65
6.3.4	View.....	68
6.3.5	Objects.....	70
6.3.6	Project.....	71
6.4	STANDARD BAR.....	71
6.5	FORMAT BAR.....	72
6.6	PROJECT EXPLORER.....	73
6.6.1	Setting.....	74
6.6.2	Screen.....	76
6.6.3	Tag.....	80
6.6.4	Connection.....	97
6.6.4.1	OPC server.....	98
6.6.4.2	Other networks (Fieldbus).....	101
6.6.4.3	General.....	102
6.6.5	Scheduler.....	103
6.6.6	Recipe.....	105
6.6.7	Event & Alarm.....	111
6.6.8	Data Logging.....	114
6.6.9	User Script.....	116
6.6.10	Security.....	118
6.6.11	Language.....	122
6.7	TOOL BOX.....	126
6.7.1	Basic Objects.....	126
6.7.1.1	Common Properties.....	129
6.7.1.2	Line.....	131
6.7.1.3	Polygon.....	134
6.7.1.4	Rectangle.....	136
6.7.1.5	Ellipse.....	138
6.7.1.6	Arc.....	141
6.7.1.7	Table.....	142
6.7.1.8	Numeric Up/Down.....	144
6.7.1.9	Digital LED.....	146
6.7.1.10	Digital Box.....	148
6.7.1.11	Text box.....	150
6.7.1.12	Label.....	152
6.7.1.13	Date and time Label.....	154
6.7.1.14	Real time Alarm Box.....	154
6.7.1.15	Historical Alarm Box.....	159
6.7.1.16	Alarm Banner.....	160
6.7.1.17	Alarm Blink.....	161
6.7.1.18	Button.....	162
6.7.1.19	Function editor.....	171
6.7.1.20	Bit lamp.....	193

6.7.1.21	Word lamp	196
6.7.1.22	Check Box	199
6.7.1.23	Combo box	202
6.7.1.24	List box.....	204
6.7.1.25	Recipe View.....	205
6.7.1.26	User View.....	208
6.7.1.27	Language Selector.....	209
6.7.1.28	XY Chart	209
6.7.1.29	Group Panel.....	211
6.7.1.30	Voice Recorder	213
6.7.2	Enhanced Objects.....	214
6.7.2.1	Common Properties.....	214
6.7.2.2	Level	216
6.7.2.3	Meter.....	222
6.7.2.4	Slider.....	227
6.7.2.5	Thermometer.....	232
6.7.2.6	Bar Box	236
6.7.2.7	Scale.....	238
6.7.2.8	Historical Trend Box	238
6.7.2.9	Real Time Trend Box.....	244
6.7.2.10	Picture box.....	245
6.7.3	Graphics.....	248
6.7.4	Symbol Factory	255
6.7.4.1	How break points work	263
6.8	PROJECT TOOLS	266
6.8.1	Build	266
6.8.2	Build & Offline Simulation.....	267
6.8.3	Build & Online Simulation.....	267
6.8.4	Online Simulation.....	268
6.8.5	Stop.....	268
6.8.6	Build & Download.....	268
6.8.7	Download	269
6.8.8	Project status	270
6.8.9	OPC Server tool	271
6.8.10	OPC Client tool	273
6.9	PROJECT BACKUP	275
6.10	PRINT.....	276
6.10.1	USB Printer	276
6.10.2	Network Printer (LPT1).....	278
6.10.3	Alarms Print.....	281
6.10.3.1	Enable Print Events	281
6.10.3.2	Real time alarm print.....	281
6.10.3.3	Historical Alarm Print	282
6.10.3.4	Log & Print operator actions	283
6.10.4	Historical data Print.....	283
6.10.4.1	Enable Print Historical data.....	283
6.10.4.2	Print Historical data.....	284
6.10.5	Print Screen	285
6.11	FDA 21 CFR PART 11 COMPLIANCE.....	286
6.11.1.1	Summary	286
6.11.1.2	Security.....	289
6.11.1.3	Procedure to sign digital records	291
6.11.1.4	Procedure to add Remarks on Digital data.....	293
6.11.1.5	Procedure to Log Operator actions in HMI	295
6.12	HOW TO SEND PROJECT FILES	296
7.	SCRIPTS	298
7.1	SYSTEM FUNCTIONS	306
7.2	MATH FUNCTIONS.....	307
7.2.1	Abs().....	307
7.2.2	ACos().....	307

7.2.3	ASin()	308
7.2.4	Atan()	308
7.2.5	Cos()	309
7.2.6	Exp()	309
7.2.7	Log()	310
7.2.8	Log10()	311
7.2.9	Max()	311
7.2.10	Min()	312
7.2.11	Pow()	312
7.2.12	Round()	313
7.2.13	Sin()	314
7.2.14	Sqrt()	314
7.2.15	Tan()	315
7.3	ARITHMETIC FUNCTIONS	316
7.3.1	ADD	316
7.3.2	SUB	316
7.3.3	MUL	317
7.3.4	DIV	317
7.3.5	Remainder	318
7.4	LOGICAL FUNCTIONS	318
7.4.1	Bitwise And, &	318
7.4.2	Bitwise Or,	319
7.4.3	Bitwise XOR, ^	320
7.4.4	Logical NOT, !	320
7.4.5	Bitwise NOT, ~	321
7.4.6	Logical AND, &&	321
7.4.7	Logical OR,	322
7.4.8	True	323
7.4.9	False	323
7.5	SHIFT FUNCTIONS	324
7.5.1	Shift Left, <<	324
7.5.2	Shift Right, >>	324
7.6	RELATIONAL FUNCTIONS	325
7.6.1	Equal To, ==	325
7.6.2	Not Equal To, !=	326
7.6.3	Less than, <	327
7.6.4	Greater than, >	327
7.6.5	Less than or equal to, <=	328
7.6.6	Greater than or equal to, >=	328
7.7	ASSIGNMENT FUNCTIONS	329
7.7.1	Equal to, =	329
7.8	SELECTION FUNCTIONS	329
7.9	ITERATION FUNCTIONS	330
7.9.1	While	330
7.9.2	For	330
7.10	JUMP FUNCTIONS	331
7.10.1	Break	331
7.10.2	Continue	332
8.	HISTORICAL VIEWER	333
8.1	HUMAN MACHINE INTERFACE (HMI)	333
8.1.1	Preparation of historical data storage in HMI	333
8.1.2	HMI data archive in PC using storage device (USB stick)	334
8.1.3	HMI data archive in PC via Ethernet	337
8.2	RESERVED	342
8.3	TOOLS	342
8.3.1	Tool Bar	342
8.3.2	Menu Bar	343
8.4	IMPORT	345
8.5	EXPORT DATA TO EXCEL	346
8.6	EXPORT DATA TO DATABASE	347

8.7	REMARK	348
8.8	VIEW	350
8.9	DISPLAY	351
8.9.1	Trend view.....	351
8.9.2	Events/Alarm List	353
8.9.3	Reserved.....	353
8.9.4	Value List	353
8.10	PAGE SELECTION	354
8.11	SEARCH	355
8.11.1	By Time.....	356
8.11.2	Period of Time.....	356
8.11.3	By Tag Name	357
8.11.4	By Alarm/Event	357
8.11.5	By Remark	358
8.12	PRINT.....	358
9.	HMI REMOTE VIEWER.....	360
9.1	OVERVIEW	360
9.2	SYSTEM REQUIREMENTS	360
9.3	LIMITATIONS	360
9.4	INSTALLATION	362
9.5	HMI REMOTE VIEWER SESSION.....	363
9.6	VIEW MORE THAN ONE HMI IN ONE SESSION.....	365
9.7	HOW TO DELETE EXISTING HMI PROJECT FROM HMI REMOTE VIEWER	368
10.	FAQ	369

GRAPHIC SYMBOLS



INFORMATION, It helps users with more details about the topic and failure to follow may lead to unpredictable results.



WARNING, Failure to follow may lead to minor injury or damage / malfunctioning of equipment



DANGER, Failure to follow may lead to injury or fatal accident to operating personal or damage/malfunctioning of equipment



CAUTION, Failure to follow may lead to malfunctioning of equipment, damage or repair



Protective Earth



DC Supply

PREFACE

Original equipment manufacturer reserves the right to change information available in this document without notice. Manufacturer is not liable for any damages incurred to equipment/personal during installation or use of equipment as explained in this document. User must acquire sufficient knowledge & skills prior to use the equipment in the application and follow all the local standards & regulations to meet safety requirements

WinCE® is registered trade mark of Microsoft Corporation

Symbol Factory® is registered trade mark of Software tool box

1. General

1.1 Instructions

Read Installation and Operation manuals carefully before installation, repairs, or commissioning of the equipment

Follow all local standards/regulations for using electrical power supply, connection to the equipment, grounding, shielding during installation and commissioning.

Obtain sufficient skills and training before using the equipment.

If any damages are observed in transportation, inform (to) the supplier with supporting information including product details and photographs.

General Precaution

Use Restriction



These products are not authorized for use in life supporting systems, aircraft navigation control systems, military systems and any other application where performance failure could be life threatening or otherwise catastrophic.

Disassembling or Modification



Do not disassemble or modify LCD module. It may damage sensitive parts inside LCD module and may cause scratches or dust on display. Manufacturer does not warrant the module if customers disassemble or modify LCD module.

Breakage of LCD display



If LCD display is broken and liquid crystal spills out, do not ingest or inhale liquid crystal and do not contact liquid crystal with skin.

If liquid crystal comes in contact mouth or eyes, rinse out with water immediately.

If liquid crystal comes in contact with skin or clothes, wash it off immediately with alcohol and rinse thoroughly with water.

Handle carefully any chips of glass it may cause injury, when glass is broken.

Absolute ratings



Do not exceed the absolute maximum rating values such as supply voltage, environment temperature etc, otherwise LCD module might get damaged.

Please do not leave LCD module in the environment of high humidity and high temperature for long time.

It is recommended to employ protection circuit for power supply.

Operation



Do not touch, push or rub the LCD display surface with any thing harder than HB pencil lead.

Use fingerstalls of soft gloves in order to keep clean display quality.

When LCD display surface is dusty, please wipe gently with absorbent cotton or other soft material.

Wipe off saliva or water drops as soon as possible. If saliva or water drops contact with polarizer for a long time, they may cause deformation or color fading.

When cleaning the adhesives, please use absorbent cotton wetted with a little petroleum benzene or other adequate solvent.

Static Electricity



Protection film must remove very slowly from the surface of LCD module to prevent from electrostatic occurrence. Persons handle the LCD display should be grounded through adequate methods.

Strong light exposure



The LCD display shall be not exposed to strong light such as direct sunlight. LCD display characteristics may be changed.

Disposal



When disposing LCD module, obey the local environmental regulations.

1.2 Standards, Certificates and Approvals



The table below shows the approvals that may be available.

Description	Details
UL approval	UL 508 and CSA C22.2 No.142
Low Voltage Directive	2006/95/EC
EMC Directive	2004/108/EC
Requirements for Emission	EN 61000-6-4 :2007
Requirements for Interference Immunity	EN 61000-6-2 :2005
Tick mark for Australia	AS/NZS CISPR 11:2004
FCC	FCC Part 15, Subpart B, Class A

1.3 Base Standards for EMC & Safety

Description	Details
Electrostatic discharge	IEC 61000-4-2: 2008
Radiated radio-frequency electromagnetic fields	IEC 61000-4-3: 2006 + A1:2007 + A2:2010
Electrical fast transient/burst	IEC 61000-4-4: 2004 + A1: 2010
Surge	IEC 61000-4-5: 2005
Conducted disturbances induced by radio-frequency fields	IEC 61000-4-6: 2008
Power frequency magnetic field	IEC 61000-4-8: 2009
Voltage dips, short interruptions and voltage variations	IEC 61000-4-11: 2004
Emission from Electromagnetic fields	CISPR 11:2009 + A1:2010 Class A
Harmonics Current	IEC61000-3-2:2005 + A1:2008 + A2:2009
Voltage Fluctuation and Flicks	IEC61000-3-3:2008
Requirements for Safety	EN61010-1:2001

1.4 Protective class

Description	Details
Standard enclosures	IP 65 (Front), IP20 housing and terminals
Stainless steel front – Option	IP 66K (Front), IP20 housing and terminals

1.5 Transport & Storage conditions



The following specifications apply

Description	Details
Drop with packing conforming to IEC 60068-2-31	10 drops from 60cm on 1 corner, 3 edges, 6 surfaces
Drop with out packing	Nil
Temperature	-20 °C to + 60 °C
Relative Humidity	10% to 90%, no condensation
Altitude	2000 meters maximum
Sinusoidal vibration conforming to IEC 60068-2-6	5 to 16.8 Hz: 3.5 mm amplitude 16.8 to 150 Hz: 2g 1oct/min. 40 sweeps
Shock conforming to IEC 60068-2-29	3 shocks per direction 11ms 15g

Best conditions for storage of LCD display modules

1. Room ambient temperature 15 ° to 35 ° C and 65% RH or less.
2. Do not store in surroundings containing organic solvent or corrosive gas.
3. Store HMI in anti-electrostatic container or bag.

1.6 Operating conditions

Description	Details
Temperature	0 °C to + 50 °C
Relative Humidity	10% to 90%, no condensation
Altitude	2000 meters maximum
Pollution	Degree 2
Sinusoidal vibration conforming to IEC 60068-2-6	10 to 25.7 Hz: 0.75mm amplitude 25.7 to 150Hz: 1g 1oct/min. 10 sweeps
Shock conforming to IEC 60068-2-29	3 shocks per direction 11ms 10g



In the case of temperatures below 0 °C, the response time of liquid crystal becomes slower and color of the display will be darker than normal. Do not operate HMI in ambient temperature less than 0 °C.

1.7 LCD specifications

Description	Details
Touch operations	1,000,000 times using R 0.8 Polyacetal stylus with force 250g
Vibration test	10-55 Hz, Stroke: 1.5mm, 2 hrs. for each direction of X, Y, Z
Shock test	100 G, 6 ms, +/- X, +/- Y, +/- Z, 3 times for each direction
Package vibration test	0.015G*G/Hz from 5-200 Hz, -6dB /Octave from 200-500 Hz, 2 hrs for each direction of X, Y, Z
Package drop test	10 drops from 60 cm on 1 corner, 3 edges, 6 surfaces

Typical View Angle

Model	HMI 4.3"	HMI 7" (LOW COST)	HMI 7" (HIGH PERFORMANCE)	HMI 10"	HMI 15"
Vertical (Up/Down)	50°/70°	50°/70°	50°/70°	60°/70°	80°/80°
Horizontal (Left/Right)	70°/70°	70°/70°	70°/70°	75°/75°	85°/85°

1.8 Package check list

Description	Details
HMI device	
Power supply Connector	
Mounting kit	
HMI editing software CD with HMI user manual soft copy	

Other accessories if ordered in separate pack(s)

Along with standard HMI product catalog, please check additional accessories catalog for more details about specific PLC cables, spare parts etc.

Description	Details
Hardware lock with HMI Editing Software Plus software	
PC to HMI cable	Ethernet Cable
HMI to PLC cable	
SD card	
Flash memory, USB	
Sound Board	

2. Products Overview

Five HMI models HMI 4.3", HMI 7" (LOW COST), HMI 7" (HIGH PERFORMANCE), HMI 10" & HMI 15" are available.

2.1.1 Technical Specifications

Model	HMI 4.3"	HMI 7" (LOW COST)	HMI 7" (HIGH PERFORMANCE)	HMI 10"	HMI 15"
Size	4.3"	7"	7"	10"	15"
Resolution (W X H in pixels)	480 x 272	800 x 480	800 x 480	1024 x 768	1024 x 768
Display type	TFT, wide touch screen	TFT, wide touch screen	TFT, wide touch screen	TFT touch screen	TFT touch screen
Colors	65,536	65,536	65,536	65,536	65,536
Touch screen type	Resistive analog	Resistive analog	Resistive analog	Resistive analog	Resistive analog
Active display area (W X H mm)	95 X 54	152 X 91	152 X 91	203 X 152	304 X 228
Display position	Both horizontal & vertical	Both horizontal & vertical	Both horizontal & vertical	Both horizontal & vertical	Both horizontal & vertical
MTBF back light at 25 ^o C	30,000 hrs	50,000 hrs	50,000 hrs	50,000 hrs	50,000 hrs
Backlight	LED	LED	LED	LED	CCFL
Brightness adjustment	Yes	Yes	Yes	Yes	Yes
Screen saver	Yes	Yes	Yes	Yes	Yes
Language fonts	Yes	Yes	Yes	Yes	Yes
Main Hardware					
Processor, CPU speed	ARM Cortex-A8, 667Mhz	ARM Cortex-A8, 667Mhz	ARM Cortex-A8, 1GHz	ARM Cortex-A8, 1GHZ	ARM Cortex-A8, 1GHz
Flash Memory (ROM)	128 MB	128 MB	128 MB	128 MB	128 MB
SDRAM (RAM)	256 MB	256 MB	256 MB	256 MB	256 MB
Operating system	WinCE 6.0	WinCE 6.0	WinCE 6.0	WinCE 6.0	WinCE 6.0
Real Time Clock	Yes	Yes	Yes	Yes	Yes
Buzzer	Yes	Yes	Yes	Yes	Yes
Sound output	N.A	N.A	Option	Option	Option
SD card slot	Option	Option	Yes	Yes	Yes
Communication ports/Interfaces					
RS232C, DB9 male	1	1	1	1	1
RS232C/ RS422/ RS485, DB25 female	1	1	1	1	1
Ethernet 10/100 Mbps, RJ45	Option	Option	1	2	2
USB host	1	1	1	1	1

Model	HMI 4.3"	HMI 7" (LOW COST)	HMI 7" (HIGH PERFORMANCE)	HMI 10"	HMI 15"
Other networks (Slave)					
PROFIBUS-DP, PROFINET IO	Option	N.A	Option	Option	Option
DeviceNet, EtherNet/IP	Option	N.A	Option	Option	Option
CANopen	Option	N.A	Option	Option	Option
General specifications					
Rated voltage	24 VDC	24 VDC, 110/220VAC	24 VDC, 110/220 VAC	24 VDC, 110/220VAC	24 VDC, 110/220VAC
Power supply	11-36 VDC	11-36 VDC, 90-250 VAC	11-36 VDC, 90-250 VAC	11-36 VDC, 90-250 VAC	11-36 VDC, 90-250 VAC
Rated current	0.91A (DC)	1.09A (DC), 0.27A (AC)	1.18 A(DC), 0.29A(AC)	1.36A (DC), 0.33A(AC)	2.46A(DC), 0.6A(AC)
Power Consumption (without sound output)	10 W	12W	13W	15W	27W
Power on LED indicator	Yes	N.A	Yes	Yes	Yes
Outer dimensions (W X H X D mm)	140 X 116 X 57	212 X 156 X 57	212 X 156 X 57	325 X 263 X 56	400 X 310 X 56
Mounting depth (mm)	51	51	51	50	50
Panel cut (W X H mm)	123 ⁺¹ X 99 ⁺¹	197 ⁺¹ X 141 ⁺¹	197 ⁺¹ X 141 ⁺¹	310 ⁺¹ X 248 ⁺¹	367 ⁺¹ X 289 ⁺¹
Protection	IP65 front, IP20 rear	IP65 front, IP20 rear	IP65 front, IP20 rear	IP65 front, IP20 rear	IP65 front, IP20 rear
Front bezel, housing	Plastic, plastic	Plastic, plastic	Aluminum, plastic	Aluminum, metal	Aluminum, metal
Stainless steel front bezel (Option)	N.A	N.A	Option, IP66K	Option, IP66K	Option, IP66K
Installation	Panel mount	Panel mount	Panel mount	Panel mount	Panel mount
Net Weight (Kg)	0.5	1.2	1.4	3.6	5.1

2.1.2 Serial drivers (COM1/COM2)

PLC/Inverter Manufacturer	Protocol	Model
Allen Bradley	DF1 protocol	SLC 500 series, Micrologix, CompactLogix, ControlLogix, PLC5 series
Allen Bradley	DH485	SLC 500 series, Micrologix
Danfoss (Inverter)	FC protocol	FC series for Automation driver/HVAC drive
Delta	DVP serial	DVP-ES,DVP-EX,DVP-SS,DVP-SA,DVP-SX,DVP-SC,DVP-EH,DVP-EH2, DVP-SV,DVP-PM
Fatek	Fatek	FB series
Festo	CI Command	FEC series
Fuji	T-Link protocol	Micrex- F series
Fuji	Micrex Series protocol	SPH 200, SPH 300, SPH 300EX, SPH 2000
GE Fanuc	Series Ninety protocol (SNP)	Micro PLC,GE 90-30/ 90-70, Versa Max
GE Fanuc	SNP-X protocol	Micro PLC,GE 90-30/ 90-70, Versa Max
Hitachi	Hitachi Hi protocol	Micro EH, EH, EHV & H series PLC's
IDEC IZUMI	Data Link	MicroSmart, OpenNet Controller, Micro3
Koyo	Direct Net	DL05, 06, 105, 205, 305 & 405
Koyo	K Sequence	DL05, 06, 105, 205 & 405 series
Keyence	ASCII	KV 700, KV1000, KV3000 & KV5000
Lenze (Inverter)	LECOM	8200/9300 Vector, 9300 servo controller, 9300 Servo PLC, Driver PLC, 8200 Motec
LG	LG Cnet	GM series, MK series-K80S, K120S, K200S, K300S, K1000S, XGB & XGK series
Matsushita (Panasonic)	Mewtocol	FP series-FP0, FP2, FP-X, FP-Sigma, FP2SH
Modicon	Modbus ASCII, RTU Master	Any device
Messung	Modbus RTU	Nextgen 2000, 5000 series
Moeller	CanOpen	XC100, XC200 series (Via Canopen option converter)
Mitsubishi	Melsec	FX, A, QnA & Q series, FX direct CPU port

Omron	HostLink	CV, CVMX, CX, CH, CS, CJ, CQM1H series
Omron	Fins	CP, CS, CJ series
Siemens	PPI	S7-200
Siemens	MPI	S7-300/400 (Via 6ES7 972-OCA23-OXAO, RS232 To MPI/DP adopter)
Schneider	UniTeleway	TSX-Micro & TSX series
Toshiba	Computer link,T series serial	S2E/ST2 series
Toshiba	T1-micro series serial	T1-Micro
Teco	Modbus	TP03 M/H, 14/20 SR, 26/36 SR
TecoInverter	Modbus	7200 MA, 7300 CV
Vigor	Vigor Serial	M, VB, VH series
Vipa	MPI	100V, 200V, 300V, 300S, 500S (Via 6ES7 972-OCA23-OXAO, RS232 To MPI/DP adopter)
Yaskawa	Memobus- MP Serial	Memocon, MP-900 & MP-2000 series
Yaskawa (Inverter)	Memobus-Inverter serial	F1000, V1000, T1000, A1000
Yokogawa	Factory Ace FA-M3 serial	FA-M3 model F3SPX series

2.1.3 Ethernet drivers (RJ45)

Manufacturer	Protocol	Model
Allen Bradley Ethernet	Ethernet/IP, CIP	SLC 500, Micrologix, Compact Logix, Control Logix, PLC5
Beckhoff Ethernet	Beckhoff Ethernet	CX90X0 & CX10X0
Delta Ethernet	Delta Ethernet Protocol	DVP-SV series
Fatek Ethernet	Fatek Ethernet	FB series
Festo-Ethernet	Ethernet CI Command	FEC series
GE Ethernet	S RTP	GE 90-30/ 90-70, Versa Max
Hitachi Ethernet	H series Ethernet	EH, EHV and H series PLC
Koyo Ethernet	Direct ECOM	DL05,06, 205, 405
Keyence Ethernet	Keyence Ethernet	KV 700, KV1000, KV3000 & KV5000
LG Ethernet	LG Fast Ethernet	GM series, MK series 200S, 300S, 1000S, XGB & XGK series
Modicon	Modbus TCP Master	Any device
Mitsubishi Ethernet	A, Q, QnA & FX Ethernet	A, Q, QnA & FX series PLC
Omron Ethernet	FINS UDP	CH, CS & CJ Series

Siemens S7 Ethernet	Siemens TCP/IP	S7-200,300, 400 (Connection Via CP card at PLC), S7-1200
Toshiba Ethernet	Toshiba Ethernet	T series, V series
Vipa	TCP/IP	200V, 300 S, 500 S
Yaskawa MP Ethernet	Memobus Ethernet	MP-900 & MP- 2000 series
Yokogawa Ethernet	Yokogawa FA-M3 Ethernet	FA-M3 model F3SPX series

3. Ordering Code

3.1 HMI ordering code

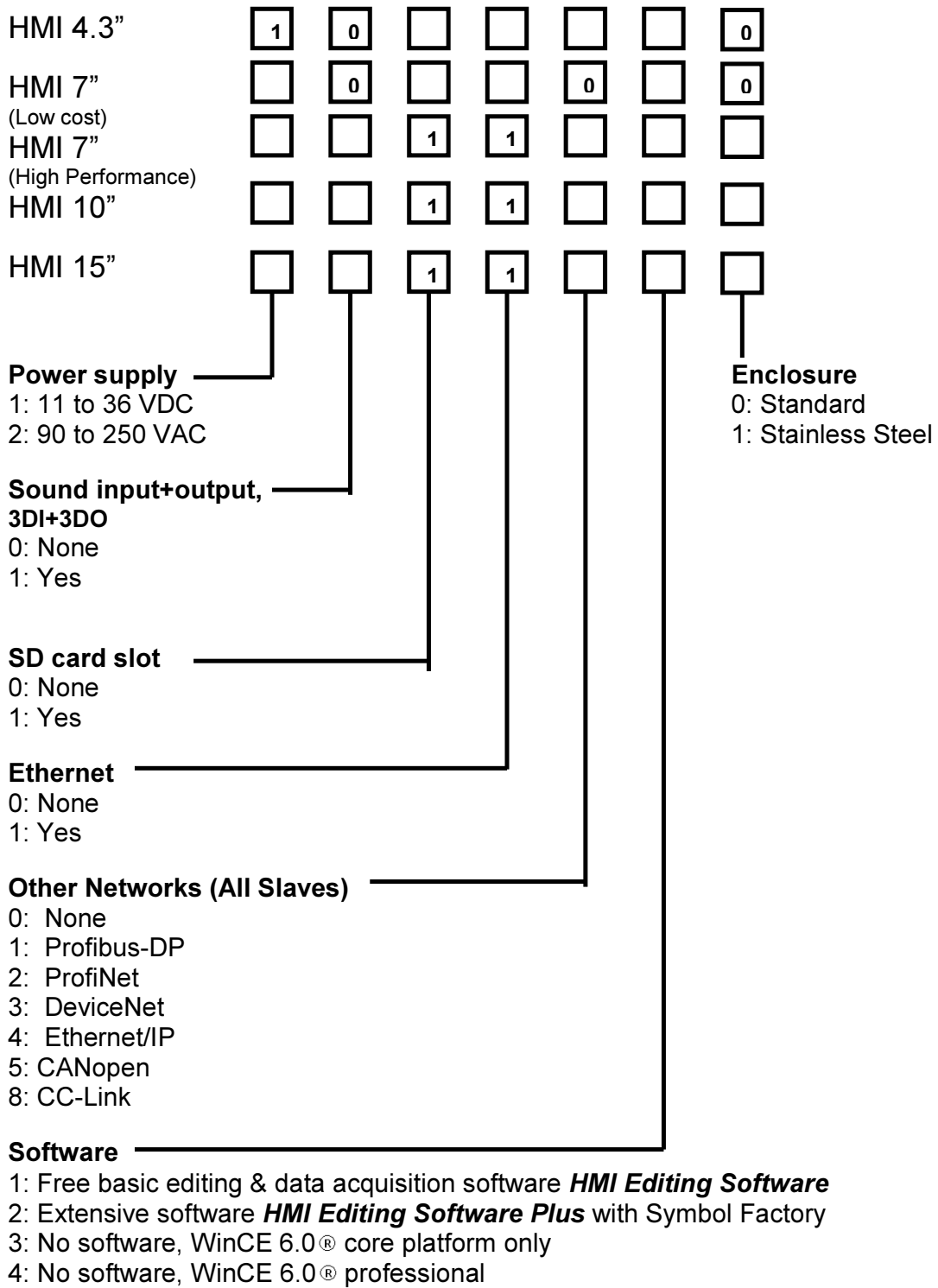

3.2 HMI Spares part list

3.2.1 HMI 4.3”

Part Number	Part number
Main Board	HMA045
IO Board	HIO045
LCD Display Module	321MODU-LM0451-A0
Power Fuse 4 Amp (DC power)	10350-15402-01-00
DC power plug	10343-11027-00-00

3.2.2 HMI 7” (Low cost)

Part Number	Part number
Main Board	HMA073
IO Board	HIO073
90-250VAC power board	HPM751
11-36VDC power board	HPM752
LCD Display Module	322MODU-LM0731-A0
Power Fuse 4 Amp (DC power)	10350-15402-01-00
DC power plug	10343-1103A-00-00
AC power plug	10343-1103A-01-00
Resistor 2.4/1w (AC power)	10301-42409-55-00

3.2.3 HMI 7” (High Performance)

Part Number	Part number
Main Board	HMA075
IO Board	HIO075
Sound Board	323PACK-SB0751-AO
90-250VAC power board	HPM751
11-36VDC power board	HPM752
LCD Display Module	323MODU-LM0751-A0
Power Fuse 4 Amp (DC power)	10350-15402-01-00
Resistor 2.4/1w (AC power)	10301-42409-55-00
DC power plug	10343-1103A-00-00
AC power plug	10343-1103A-01-00
DI/DO plug	10343-1208B-00-00

3.2.4 HMI 10”

Part Number	Part number
Main Board	HMA105
Display Board	HDP105
Connection Board	HCB105
Sound Board	324PACK-SB1051-AO
90-250VAC power board	HPM751
11-36VDC power board	HPM752
LCD Display Module	324MODU-LM1051-A0
Power Fuse 4 Amp (DC power)	10350-15402-01-00
Resistor 2.4/1w (AC power)	10301-42409-55-00
DC power plug	10343-1103A-00-00
AC power plug	10343-1103A-01-00
DI/DO plug	10343-1208B-00-00

3.2.5 HMI 15”

Part Number	Part number
Main Board	HMA155
Backlight Board	HBL155
Sound Board	325PACK-SB1551-AO
90-250VAC power board	HPM751
11-36VDC power board	HPM754
LCD Display Module	325MODU-LM1551-A0
Power Fuse 6.3 Amp (AC power)	10350-15632-01-00
Resistor 2.4/1w (AC power)	10301-42409-55-00
DC power plug	10343-1103A-00-00
AC power plug	10343-1103A-01-00
DI/DO plug	10343-1208B-00-00



It is possible to change power supply from AC to DC and vice versa (Except HMI 4.3”) by replacing power supply board, after replacing power board, the label for marking power input range located on the enclosure has to be changed.

3.3 Network option module part numbers

Option card	Part number
Profibus DP	Hnet-1
ProfiNet	Hnet-2
DeviceNet	Hnet-3
Ethernet/IP	Hnet-4
CANopen	Hnet-5
CC-Link	Hnet-8

Table: Part number for network option modules.

3.4 Accessories part numbers

Part Number	Description
WPG045	Gasket for HMI 4.3" (For dust and Moisture protection)
WPG073	Gasket for HMI 7" (LOW COST)/ HMI 7" (HIGH PERFORMANCE) (For dust and Moisture protection)
WPG105	Gasket for HMI 10" (For dust and Moisture protection)
WPG155	Gasket for HMI 15" (For dust and Moisture protection)
HMB045	HMI Mounting Brackets (Metal Enclosures)
HMB073	HMI Mounting Brackets (Plastic Enclosures)

3.5 PLC cables part numbers

For PLC to HMI cables and various connectors, please refer additional brochure "HMI accessories".

4. Installation

4.1 Installation

Guidelines



Stainless steel front HMI has sharp edges and more weight. Enough care should be taken while inserting HMI into enclosure/panels using proper hand gloves. Improper handling may cause injury personal during installation of HMI into enclosure/panels.

1. The HMI is intended for indoor use and not in any hazardous area.
2. HMI device should be installed in suitable enclosure/panels/cabinets/housings.
3. Avoid facing of HMI screen directly exposed to sun light.
4. Avoid installation in high vibration area/ moving parts.
5. Avoid installation near to high radiation/noise emitting devices like motors, transformers, variable frequency drives, inverters, UPS, cellular towers etc.
6. Avoid installation in areas where there is the presence of vapors, gases, oils, lubricants, chemicals etc.
7. Install HMI at suitable height and location which is easy accessible to operators.
8. When HMI is installed inside main panel, make sure that proper vents are available for the main panel, ambient temperature inside the panel is not exceeded beyond HMI specifications, operator is alerted incase of exceeding temperature limits.
9. When HMI is installed on panel front door, check depth of the HMI and make sure that there is enough clearance available inside the panel after closing the main panel door.
10. A sufficient panel gage should be used in the main panel to firmly install HMI. Take care when using stainless steel fronts as weight is heavy compared with alloy or plastic fronts. Use rubber gaskets properly to achieve degree of Ingress Protection.
11. Use panel cut out as specified and firmly attach all mounting clips.
12. Maintain proper clearances around the HMI panel approx: 50 mm on all directions to make sure that it is easy to remove HMI for maintenance purpose and temperature dissipates by natural air cooling method.
13. Use proper line protections in power supply line via fuses, circuit breakers etc.
14. Connect earth properly to the HMI enclosures/panels/cabinets/housings.
15. Use proper cables, connect to ground properly before connecting power supply to HMI
16. Thoroughly check voltage levels accepted by HMI, measure voltage levels with a multimeter before connecting them with HMI.

17. While using HMI with stainless steel front for wash down applications, make sure that panels/enclosures/cabinets/housings are perfectly closed to avoid water entry inside panels causing damages to the equipment and injury to operating personal.

18. Improper installation voids warranty.

4.2 Dimensional drawings

4.2.1 Dimensional drawings of the HMI 4.3"

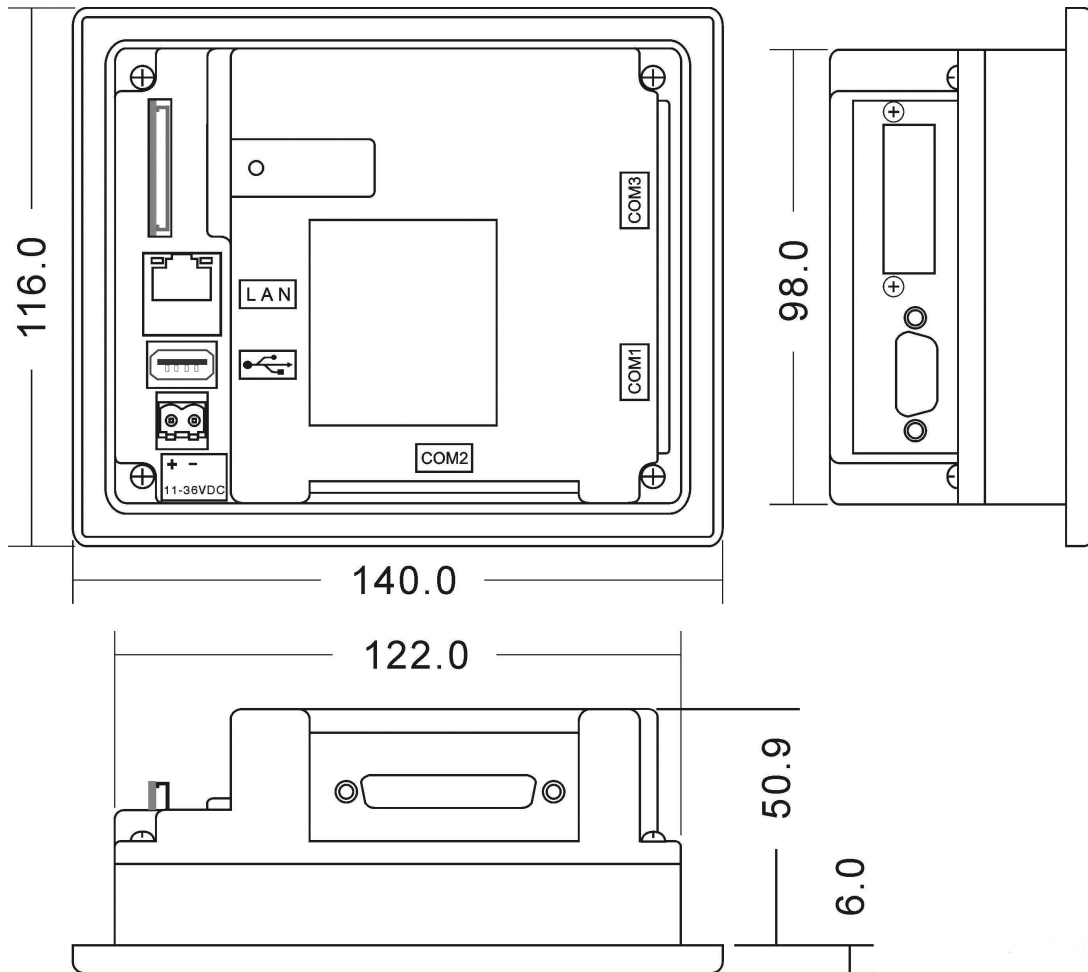

Note: All dimensions are in mm. Tolerance +/- 1 mm.

Panel cutout: 123⁺¹ X 99⁺¹

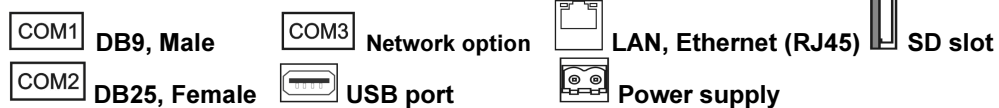

4.2.2 Dimensional drawings of the HMI 7”

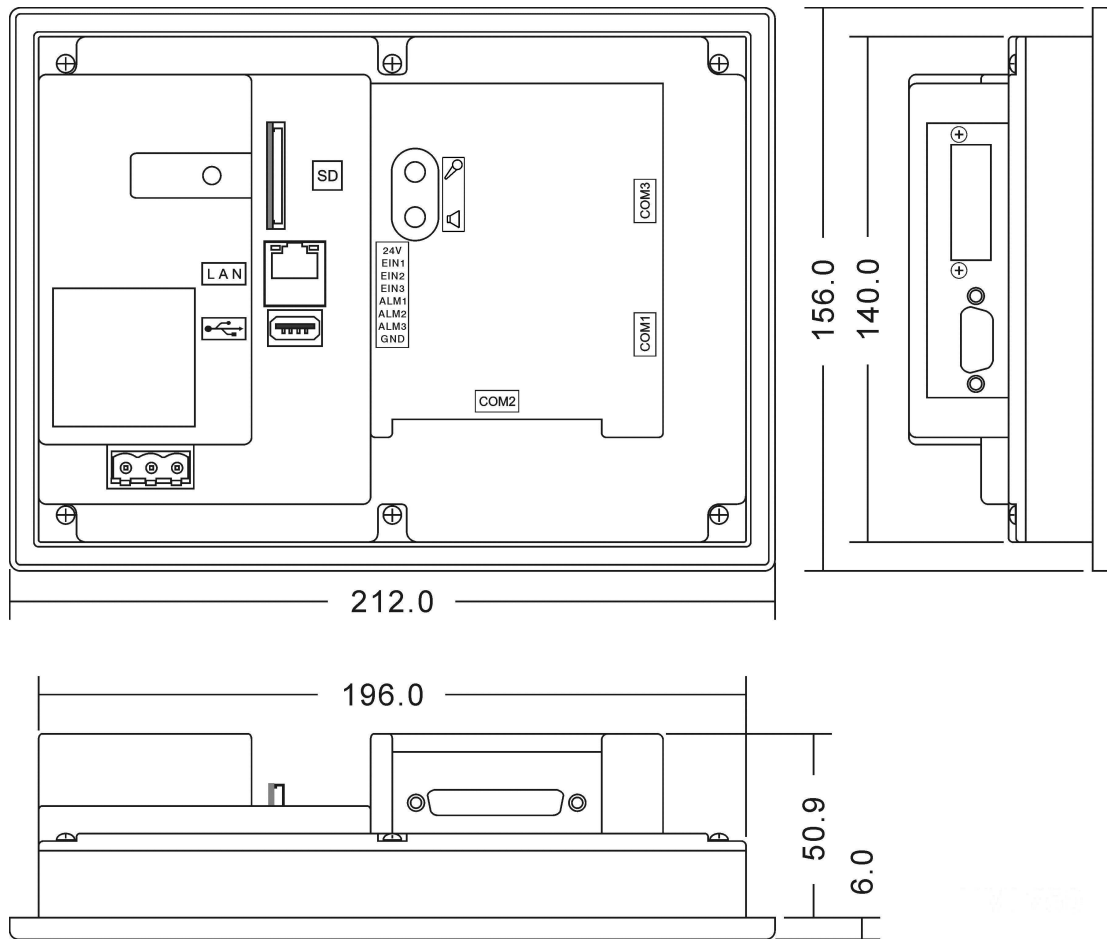

Note: All dimensions are in mm. Tolerance +/- 1 mm

Panel cutout: 197⁺¹ X 141⁺¹

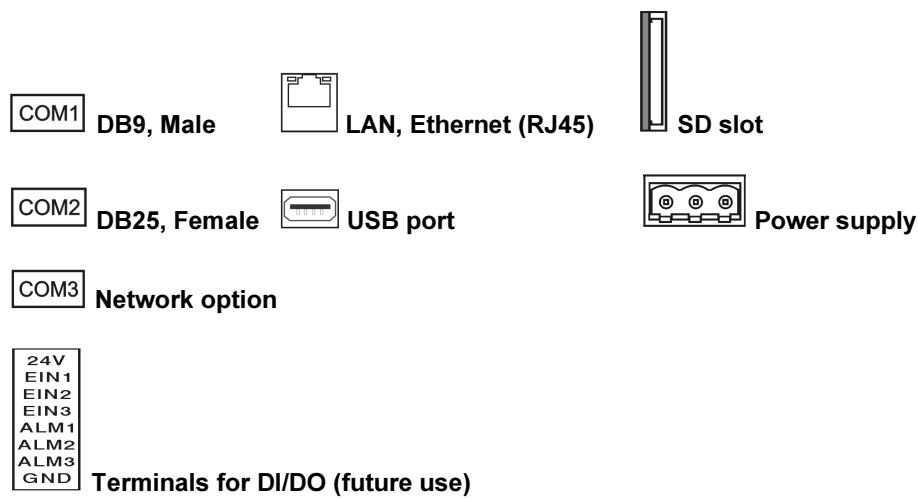

4.2.3 Dimensional drawings of the HMI 10”

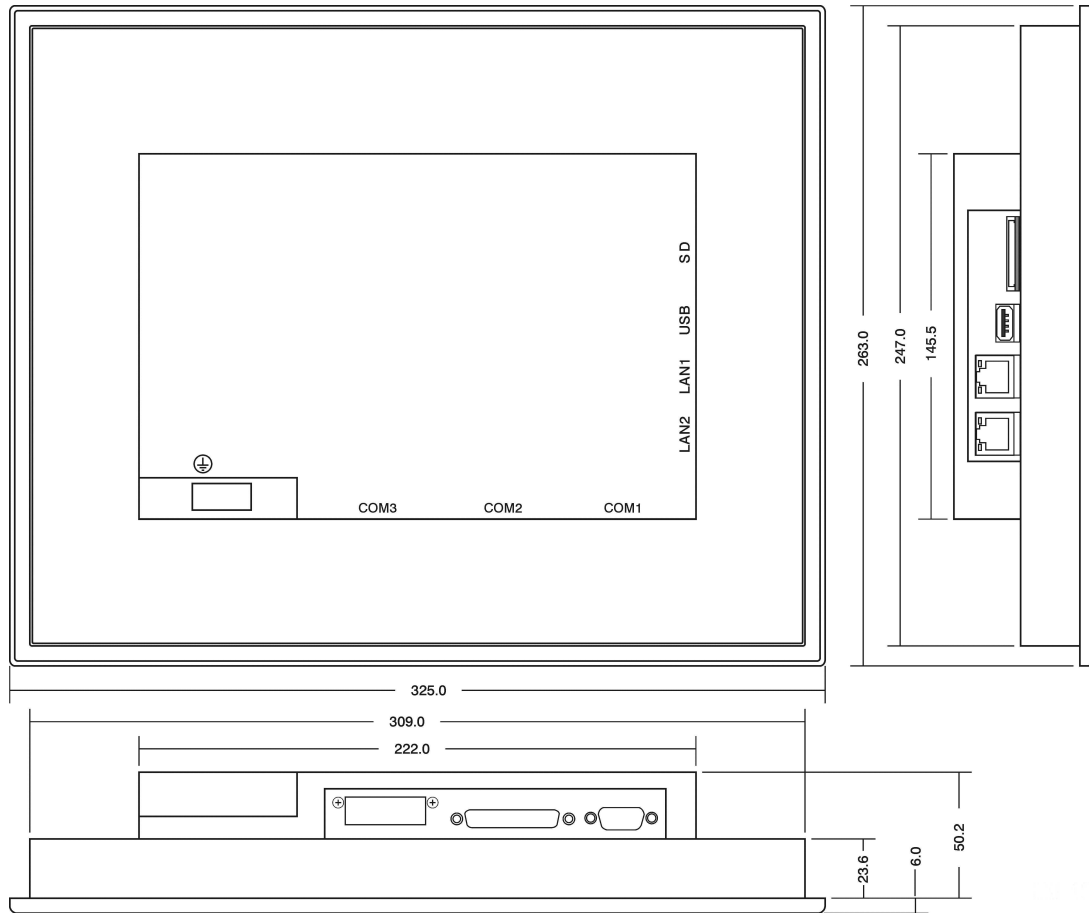

Note: All dimensions are in mm. Tolerance +/- 1 mm

Panel cutout: 310⁺¹ X 248⁺¹

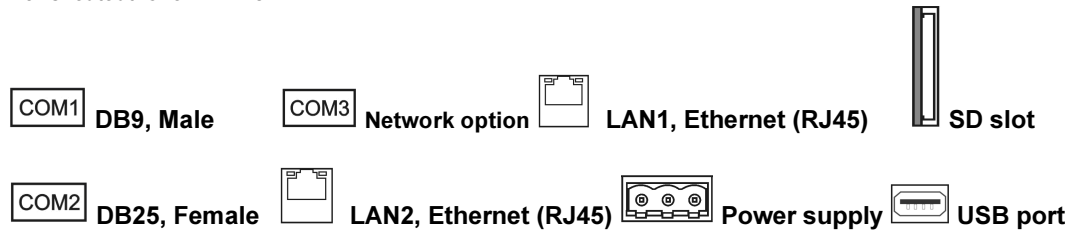

4.2.4 Dimensional drawings of the HMI 15”

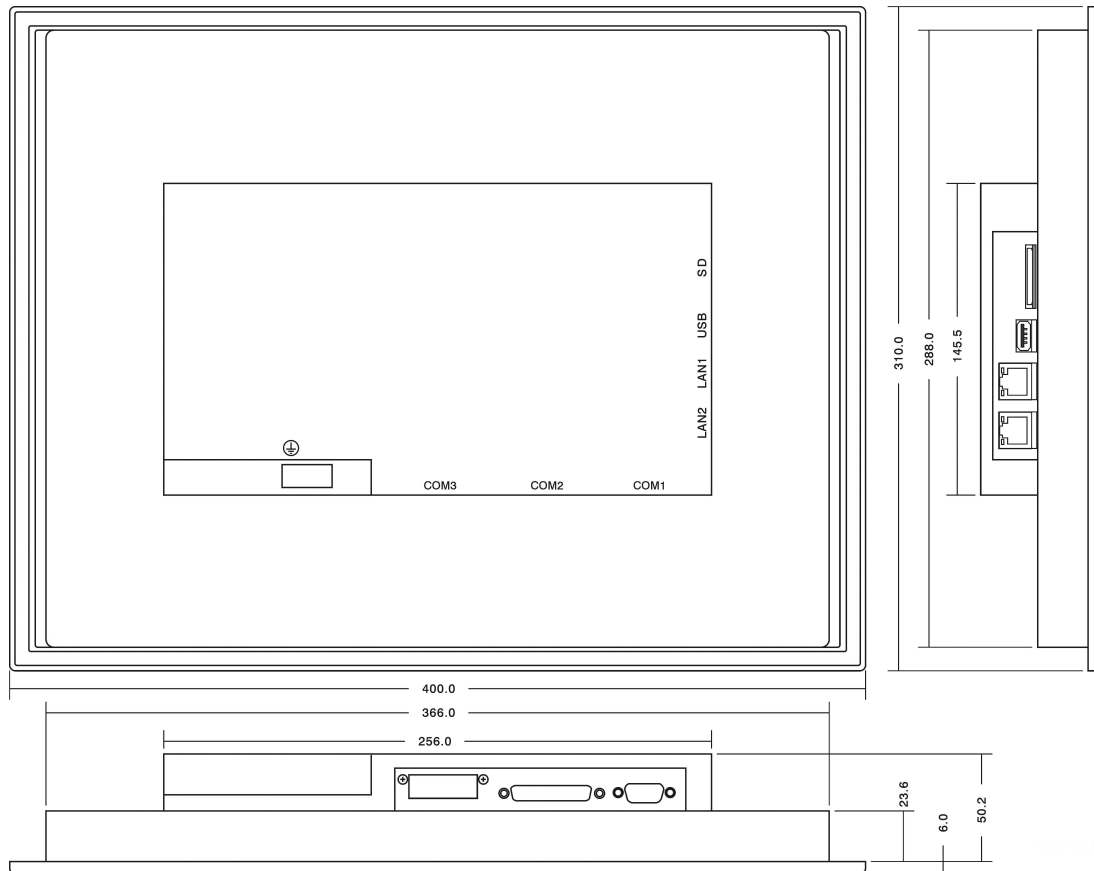

Note: All dimensions are in mm. Tolerance +/- 1 mm

Panel cutout: 367⁺¹ X 289⁺¹

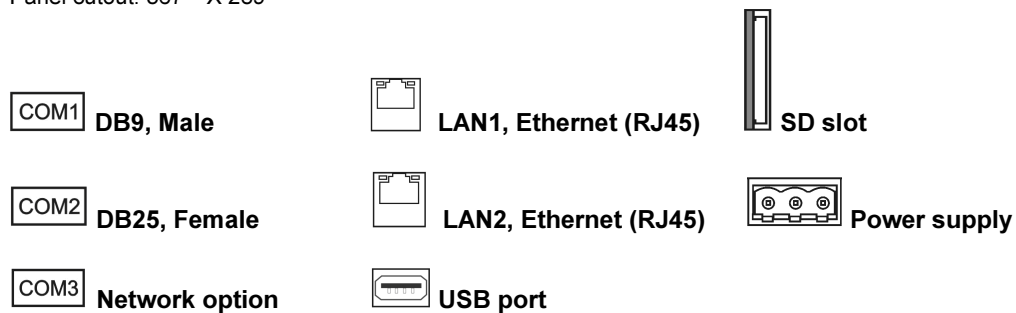

4.3 Mounting

It is possible to insert HMI in either vertical or horizontal direction in enclosures/ panels/ cabinets/ housings. Panel cut out is as follows.



If HMI to be installed vertically, while creating new project in HMI editor software, select resolution carefully at the beginning and then select the angle correctly during HMI

start up at the panel. Please refer section “Instrument” at “HMI startup” about how to select angle for vertical installation.

Horizontal Installation

Model	HMI 4.3"	HMI 7" (Low Cost)	HMI 7" (High Performance)	HMI 10"	HMI 15"
Width (mm)	123 ⁺¹	197 ⁺¹	197 ⁺¹	310 ⁺¹	367 ⁺¹
Height (mm)	99 ⁺¹	141 ⁺¹	141 ⁺¹	248 ⁺¹	289 ⁺¹
Depth (mm)	51	51	51	50	50

Vertical Installation

Model	HMI 4.3"	HMI 7" (LOW COST)	HMI 7" (HIGH PERFORMANCE)	HMI 10"	HMI 15"
Height (mm)	99 ⁺¹	141 ⁺¹	141 ⁺¹	248 ⁺¹	289 ⁺¹
Width (mm)	123 ⁺¹	197 ⁺¹	197 ⁺¹	310 ⁺¹	367 ⁺¹
Depth (mm)	51	51	51	50	50

HMI 4.3" : 4 nos. mounting clips
 HMI 7" (LOW COST)/HMI 7" (HIGH PERFORMANCE) : 6 nos. mounting clips
 HMI 10" : 10 nos. Mounting clips
 HMI 15" : 12 nos. Mounting clips

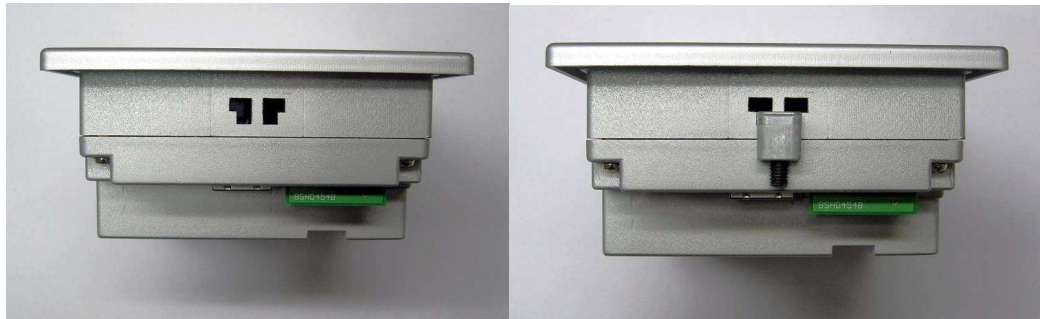

Mounting clips for HMI with Metal enclosures

Top view Bottom View



Use Proper Tools to open HMI enclosure.

Mounting clips for HMI with Plastic enclosures

Top view



Bottom View



Tighten all mounting clips otherwise it may effect the touch panel operation and ingress protection will be compromised.



The torque used for 4 sides of the housing should be balanced and not more than 1N-m (8.9Lb-in or 10.2 KgF-cm) to eliminate the LCD panel from bending.

4.4 Power Supply

The following options are available.

1. AC Power, 90-250 V AC, 47~63 Hz, Universal AC power supply (Except HMI 4.3")
2. DC Power, 11-36 V DC

AC Power, 90-250 V AC, 47~63Hz

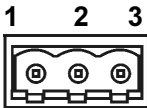

Pin	Description
1	Earth
2	Neutral
3	Line

Note: Orange color terminal supplied for AC

DC Power, 11-36 V DC

1 2 3

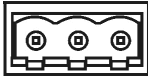

Pin	Description
1	Earth
2	DC-
3	DC+

Note: Green color terminal supplied for DC

DC Power, 11-36 V DC (For HMI 4.3" only)

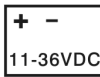

Pin	Description
1	DC +
2	DC -

Different power boards are available for above options and they will be fitted into HMI as per ordering code.



The protective earth terminal should be connected first before any other connection is made.



Do not open HMI enclosure in potentially explosive environments. If any service is required, switch off the power supply and bring HMI to environment which is clean. Use proper tools to open HMI enclosure. Repairs/servicing should be done by personal qualified, trained, experienced and authorized to perform these kind of tasks. Dangerous high voltages may be present in parts of PCB and improper servicing may cause shock and fatal injury to personal involved in job.



All local electrical regulations should be strictly followed while connecting power supply to HMI. Use proper rated cables, earth, grounding, shielding from reliable sources, line protections in power supply circuit via fuses etc, to avoid shock, injury/death to operating personal.



It is advised to use uninterrupted regulated power supply with adequate protections and filters in power supply line to be used with HMI.



The plug-in terminal block for connecting the power supply is supplied along with HMI and is designed for cables with a maximum cross-section of 1.5 mm².

4.5 Interfaces



Tighten all the screws after inserting connector at COM1/COM2, otherwise, communication failure with connected PLC/Inverter devices may occur because of loose connections.



Refer OPC server manual for connection diagram between HMI and various PLC's. Every PLC may have different connector types, different pins are used for RS232C. Improper cable/connections may damage either HMI or connected PLC.



Do not attempt to connect two different PLC's manufacturers at a time on COM1/COM2 port unless they support the same protocol like Modbus RTU.



COM ports are used for connecting with various PLC's. It is not used for downloading application or firmware from PC to HMI.

4.5.1 COM1 port, DB9 male (RS232C)

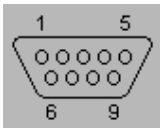

Fig: DB9 male

Pin number	Signal	Signal Name	Signal Direction
1	DCD	Data carrier detect	Output
2	RD	Receive data	Input
3	TD	Transmit data	Output
4	DTR	Data terminal ready	Output
5	SG	Signal Ground	-
6	DSR	Data set ready	Input
7	RTS	Request to send	Output
8	CTS	Clear to send	Input
9	RI	Ring Indicator	Input

Commentary note:

Please refer OPC Server user manuals for wiring connection between HMI and PLC

4.5.2 COM2 port, DB25 Female (RS232C/RS422/RS485)

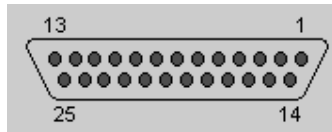

Fig: DB25 female

Pin number	Signal	Signal Name	Signal Direction	Type
1	FG	Frame Ground	-	-
2	TD	Transmit data	Output	RS232C
3	RD	Receive data	Input	RS232C
4	RTS	Request to send	Output	RS232C
5	CTS	Clear to send	Input	RS232C
6	DSR	Data set ready	Input	RS232C
7	SG	Signal Ground	-	5V-/RS232C
8	DCD	Data carrier detect	Output	RS232C
9	-	-	-	-
10	-	-	-	-
11	-	-	-	-
12	TXDA	Transmit data	Output	RS422/RS485
13	TXDB	Transmit data	Output	RS422/RS485
14	RTSA	Request to send	Output	RS422
15	RTSB	Request to send	Output	RS422
16	-	-	-	-
17	-	-	-	-
18	CTSA	Clear to send	Input	RS422
19	CTSB	Clear to send	Input	RS422
20	DTR	Data terminal ready	Output	RS232C
21	5 V +	5 V Power supply +	Output	-
22	RI	Ring Indicator	Input	RS232C
23	-	-	-	-
24	RXDA	Receive data	Input	RS422
25	RXDB	Receive data	Input	RS422

Commentary note:

Please refer OPC Server user manuals for wiring connection between HMI and PLC

4.5.3 COM3 (Network option card)

Supported Networks:

Profibus, ProfiNet, DeviceNet, Ethernet/IP, CANopen



HMI will act as a slave with network option. PLC or external device should be configured as master to communicate with HMI acting as slave in the network.



The above options are available for all HMI except low cost HMI 7" (LOW COST). At any time, it is possible to insert only one of above module in HMI. It needs to open HMI enclosure to change module from one type to another. Please insert the module properly in the connector and make sure direction is proper and it is inserted firmly.

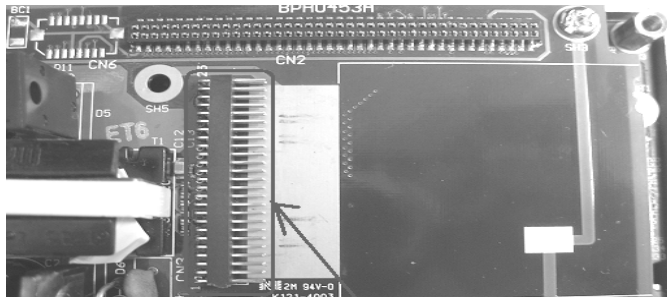

Insert Option card here and make sure all pins inserted properly

Fig: Main board, PCB inside HMI

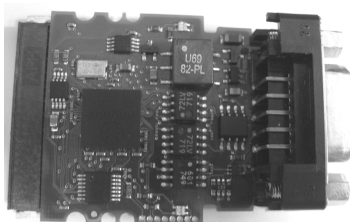

Fig: Option card Top view

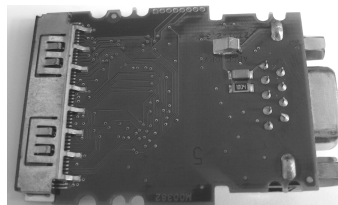

Fig: Option card Rear view

4.5.4 Ethernet

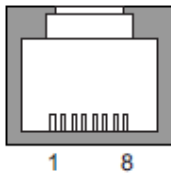

Fig: RJ45 connector

Ethernet, 10/100 Mbps

Pin	Description
1	Transmit (TX+)
2	Transmit (TX -)
3	Receive (RX+)
4	No connection
5	No connection
6	Receive (RX-)
7	No connection
8	No connection

Applications

- To download application from PC to HMI.
- To communicate with various PLC's via Ethernet using different Ethernet based communication protocols.



For HMI 10" and HMI 15", two Ethernet ports are supported. One may be used to connect with PLC devices for process control and data logging applications and another port may be used for commercial applications like connection to local area network (LAN), internet, Web server, IP Camera etc. in future.

4.5.5 USB Host

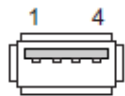

Fig: USB connector

Pin	Description
1	+ 5V DC (max 500 mA)
2	USB-DN
3	USB-DP
4	GND

Applications

- Connect Mouse, Insert USB flash disk etc.
- Update HMI firmware from USB flash disk to HMI.
- Transfer application from USB flash disk to HMI.
- Transfer historical data from HMI internal memory to USB flash disk.
- Connect USB printer to HMI
- Save Historical data and Historical Alarms in CSV format to USB flash disk



Use only USB flash disk recommended by manufacturer. Make sure that no virus is present in USB flash disk.

4.5.6 SD slot



Applications

It is used to store large volumes of historical data. All the data stored in SD card will be in proprietary format for data security reasons. It requires historical viewer software to import data from SD card and then archive historical data in PC. For compatibility reasons, we advice to use SANDISK make SD card tested till 32 GB.



Use only SD card recommended by manufacturer.

4.5.7 Sound input/Output

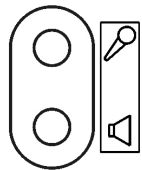

Sound Input: It is to connect Microphone. (Reserved to use in future)



Sound Output: It is to play audio files on trigger of Event/Alarm

Sound input/output connector: Use 3.5mm diameter with 14mm length stereo phone plug.



φ 3.5 MATE PLUG



HMI may be used to alert operators for process alarm conditions. These alarms are intended for indication and taking preventive action only and they should be not used as main source to safeguard operating personal and equipment. Do not use HMI for emergency applications.

Note: Sound input, Output, 3 DI and 3 DO are available in same card

4.5.8 Digital input/Digital output

24V
EIN1
EIN2
EIN3
ALM1
ALM2
ALM3
GND

Screen1
Tag

User Define
System

Tag

1 / 0

	Name	Type	Comment
	SystemDI_1	Digital	Option
	SystemDI_2	Digital	Option
	SystemDI_3	Digital	Option
	SystemDO_1	Digital	Option
	SystemDO_2	Digital	Option
	SystemDO_3	Digital	Option

Digital Input: 3 nos. Digital inputs are available on board in sound input/output option card. System tags available for digital inputs namely SystemDI_1, SystemDI_2 & SystemDI_3

Digital Output: 3 nos. digital outputs are available on board in sound input/output option card. System tags available for digital outputs namely SystemDO_1, SystemDO_2 & SystemDO_3

Pin	Description	Details	System tag
1	24V +	Power supply + 24V DC	N.A
2	EIN1	Digital input 1	SystemDI_1
3	EIN2	Digital input 2	SystemDI_2
4	EIN3	Digital input 3	SystemDI_3
5	ALM1	Digital Output 1	SystemDO_1
6	ALM2	Digital Output 2	SystemDO_2
7	ALM3	Digital Output 3	SystemDO_3
8	GND	Power supply + 0 V DC	N.A

Table: Pin connection details

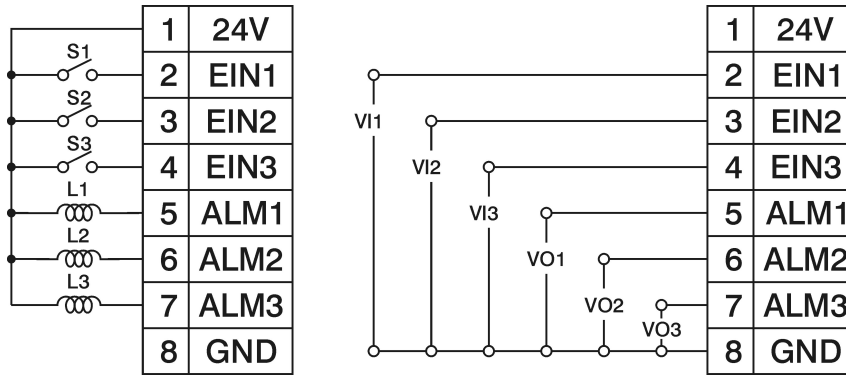

Fig: Wiring details

The digital input can accept a switch signal or a 24 volts logic input signal. The digital input function is activated as the switch is closed or the event input terminal is pulled up to 24 volts.

L1, L2 and L3 can be a resistive load or inductance load like a buzzer or relay.



The total current consumption for L1, L2 and L3 must be less than 10mA.

VO1, VO2 and VO3 are 24 volts logic outputs for driving PLC or external devices.

Note: Sound input, Output, 3 DI and 3 DO are available in same card

4.6 Real Time Clock

Item	Description
Make	Seiko Instruments
Model	MS621-FL11E
Rating	3V/4 mAH
Typical life time	10 yrs
Buffer period	6 months
Type	Rechargeable
Accuracy	Maximum +/- 2 sec/day

4.7 HMI Reset Procedure

For All models:

Formatting from HMI

- Short Pin 2 & 3 in Com2



- Power ON the HMI
- HMI Screen will be shows like below

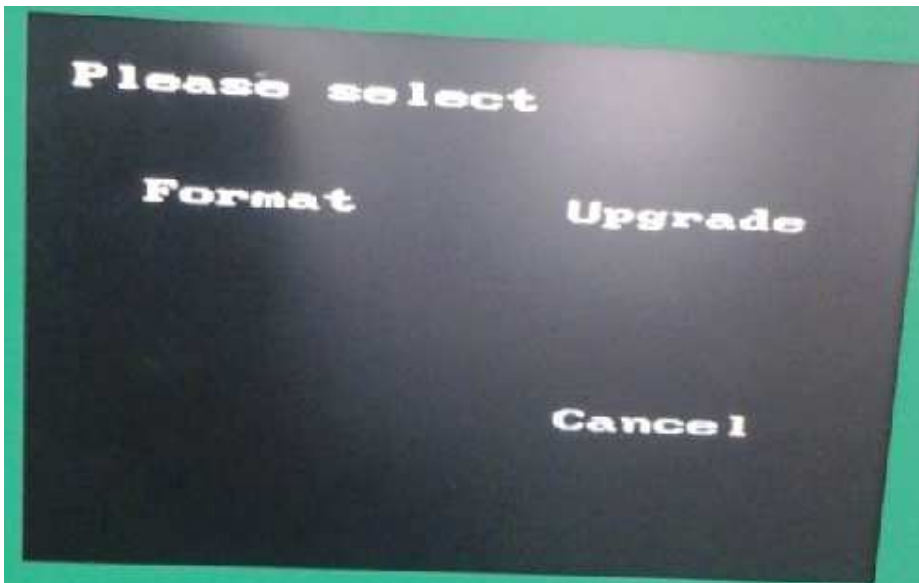

- Formatting is to format the project and data in the HMI
- Press the format button to Format

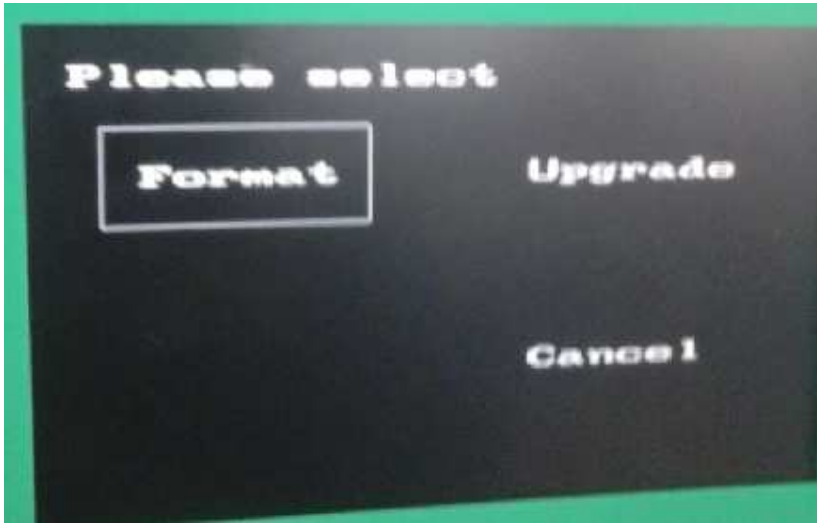

- After Formatting, it is needed to calibrate the touch screen

Upgrading the firmware By using SD Card

- Short pin 2 & 3 in Com2



- Insert SD Card with the firmware. The SD Card must be formatted to FAT32
- Power On HMI
- The Screen will Appear like below

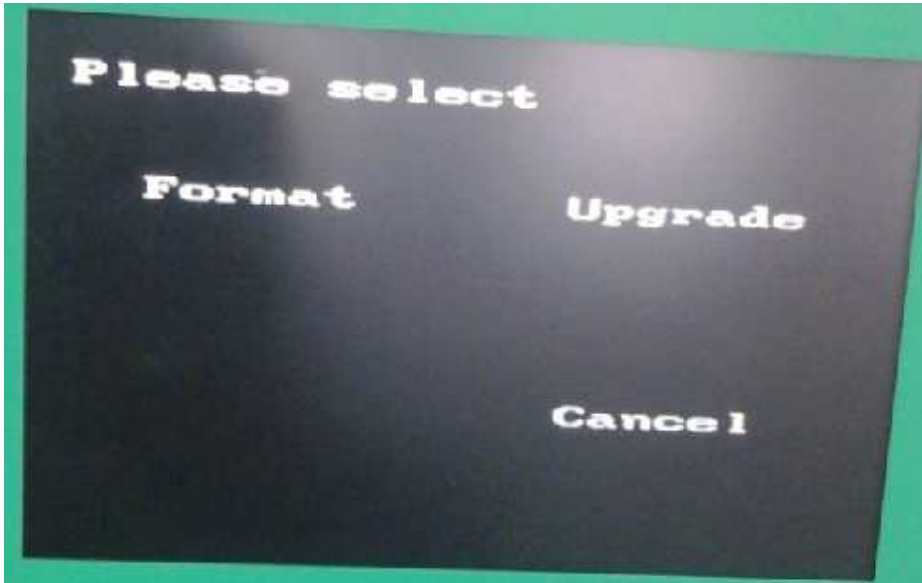

- Press Upgrade Button for 3 Seconds

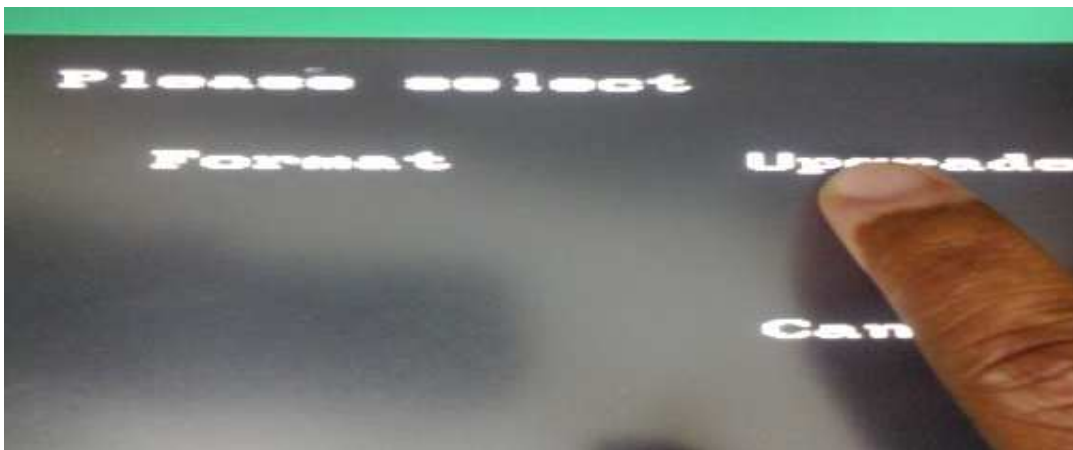

- The upgrade Process Starts
- After Completing the Upgrade The screen will appear like below



- Then it is needed to calibrate the touch screens

By Using USB:

- Insert USB with Updated Firmware in the USB Port of HMI
- Go to Control Center
- Select System Information



- Select Update Button to Update. This will update the firmware in HMI.

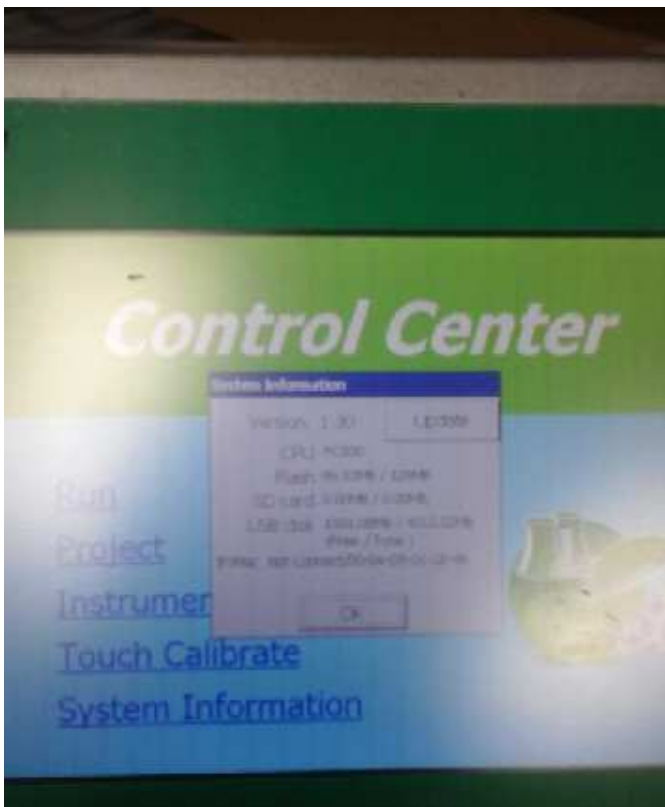

5. Software

5.1 PC Software

HMI Editing Software is Basic HMI Editing software

HMI Editing Software Plus is Extensive HMI editing Software with Symbol Factory ®

Historical Viewer software is to view historical data via PC

5.1.1 Basic software - HMI Editing Software

It is HMI editing software to develop applications in HMI. It is mainly used for application development useful for operator interface in industrial applications. Using HMI, operators will be able to communicate with PLC's, Inverters etc. using OPC server via COM port and Ethernet port on different kind of protocols. Using HMI editor software, it is possible to develop operator interface applications like the following.

Sending start/stop command from HMI to PLC to start motors, pumps etc.

Display running stats of motors, pumps etc.

Display Real time value of process parameters like temperature, flow, pressure etc

Visualize process data in meaningful way as bar graphs, real time trends, historical trends, dial, meter, level, digital LED etc.

Real time alarms, historical alarms, alarm management.

Recipe management, scripts programming

Animation like visibility control, blinking, horizontal movement, vertical movement etc

Scheduler with timers, counters, totalizers etc

Data logging, different log methods, security, multi language etc

HMI Editing Software contains basic symbols in various categories. Please refer section by name "Graphics" for more details about basic symbols.

5.1.2 Extensive software - HMI Editing Software Plus

HMI Editing Software Plus is Extensive Software with Symbol Factory ® control. It is an option.

It contains all the features of HMI Editing Software + Symbol factory.

Symbol factory contains thousands of symbols for many industrial applications. All the symbols are objects, allowing changing colors in run time based on tag value occupy less memory and do not loose quality of symbol on enlargement.

Please refer section "Symbol Factory" for more information about this topic.

5.1.3 Historical viewer

Historical viewer is a data acquisition software tool to view historical data via PC. It is supplied free along with both HMI Editing Software and HMI Editing Software Plus.

If Data logging is configured, then it stores historical data first in HMI internal memory or optional SD card (In selective HMI models) in proprietary format for data security reasons. This data can be dumped into USB flash, imported to PC via historical viewer and then archive historical data in user friendly formats.

Historical viewer in DAQ has following features.

Historical trend

Historical Alarms/Events

Display Historical values in tabular column.

Search data by Time, Timer Period, Event/Alarm, tag wise and Remark

View trends both horizontally and vertically

Zoom out & Zoom In

Display view options available at 1 sec/dot, 2 sec/dot, 5 sec/dot, 10 sec/dot, 20 sec/dot, 30 sec/dot, 1 min/dot, 2 min/dot, 5 min/dot, 10 min/dot, 30 min/dot, 10 min/page, 30 min/page, 1 hr/page, 2 hr/page, 4 hr/page, 8 hrs/page, day/page, week/page and month/page.

Display white back ground/black background.

Export data and alarms/events to CSV files. (Specify time or time period or all).

Print trend view, Event/Alarm list & Tag Values.

5.1.4 System Requirements

PC with Minimum 1GHz processor, 1GB RAM (Minimum), 2 GB preferred
500 MB free space in the hard disk

Minimum 20% free space in hard disk, Less than 10% space generates error message

Ethernet Network adopter RJ 45 female

RS 232 serial port, RS485/RS232 converter to check online simulation if required

USB host to insert USB flash disk

Screen resolution better than 1024 X 768 (For HMI 10" and 1550 projects)

Display font size (control panel->personal->display->font size) is to be default size.

Operating system: Windows XP, Windows Vista, Windows 7, Windows 2000 & Windows 2003 Server

5.1.5 Software Installation

Install Microsoft installer V3.1

Install Microsoft.Net frame work V3.5 SP1

Install HMI Editing Software

Install OPC server

Install Demo projects

Install Historical viewer

Install Remote viewer

5.1.6 Accessories

AC/DC power supply, preferably un-interrupted power supply (UPS)

PC to HMI programming cable (Ethernet)

USB stick

Pen for easy touch operations

Power supply connectors

5.1.7 Quick start

Install Microsoft.net, HMI Editing Software & OPC server software in PC.

Open HMI Editing Software in PC

Create a new project and develop a sample application.

Build project. If any errors, correct them

Save project

Check project in offline simulation

If PLC is being used for testing, then

Make sure that appropriate program is available at PLC

Check OPC server manual for specific PLC driver and prepare correct cable

Configure OPC server properly in HMI Editing Software and create PLC data base

Connect PLC to HMI cable, make sure correct COM port is connected as per configuration

Power on PLC, connect power supply to HMI and power on HMI

Connect Ethernet cable between PC and HMI and download project from PC to HMI.

Check section 6.8.7 for more detailed information how to download project

Run the application in HMI

5.2 HMI firmware

HMI firmware installed in HMI

HMI will be loaded with firmware at factory, then, on power on, HMI will display start up screen. It is possible for users to update firmware later via USB flash disk. You can find firmware version information in HMI itself. Hold touch area in HMI, power on, then on start up, press on “System information” to display firmware version number. Please contact the manufacturer/distributor/supplier for latest firmware updates.

Refer section “HMI Startup” for more details about HMI firmware. It is mainly used for operation and maintenance purpose including loading application, running application, calibration of touch screen, Setting clock, Setting IP address, adjusting beeper volume, back light, screen saver time, setting angle of orientation as per mounting etc..

5.2.1 HMI startup

WinCE 6.0 operating system is preinstalled in all HMI devices.

After power on, initial HMI screen is as follows



5.2.2 Run

It is to run application in HMI device. After receiving application from PC via Ethernet or USB stick, press on "RUN" soft button to run application in HMI

5.2.3 Project

It is to configure how to execute application

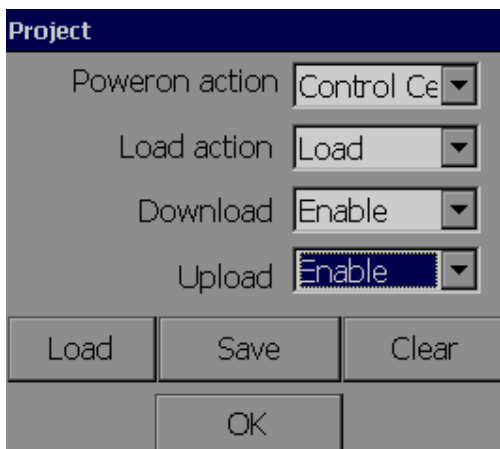

Power On execution

Available options are Run project and Control center

Project: If selected, then, after HMI power on it directly runs project automatically.

Control Center: If selected, then, after HMI powers on, it stays at Control center, initial screen.

Load action

Set how HMI should behave after downloading application. Option “Load” and “Load & Run” are available for selection.

Load: If “Load” is selected, then after downloading application from PC to HMI or removable disk to HMI, HMI will remain at initial screen.

Load & Run: If “Load & Run” is selected, then after downloading application from PC to HMI or removable disk to HMI, HMI will run and execute recently download application.

Download: Available options are Enable/Disable. Default action is “Enable”. If “Disable” selected, then, it will not allow to download application from PC to HMI. At this time, if any attempt to download application, will prompt the following message in PC

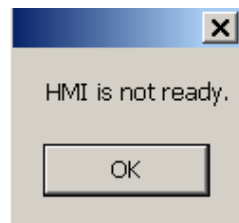

Upload: Available options are Enable/Disable. Default action is “Enable”. If “Disable” selected, then, it will not allow to upload application from HMI to PC. At this time, if any attempt to download application, will prompt the following message in PC

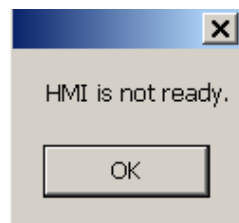

Load button

It is used to load application from USB stick to HMI manually.

First make sure that project is compiled in PC and stored on USB stick. Please check section “Download” for information about how to download project from PC to USB stick.

Procedure:

Build application in PC

Download application from PC to USB stick

Insert USB stick into USB port in HMI

Touch with finger on any active area in HMI screen, hold the finger and Power on HMI.

After loading bar, it shows initial screen

Then press on "Project", then, press on "Load button"

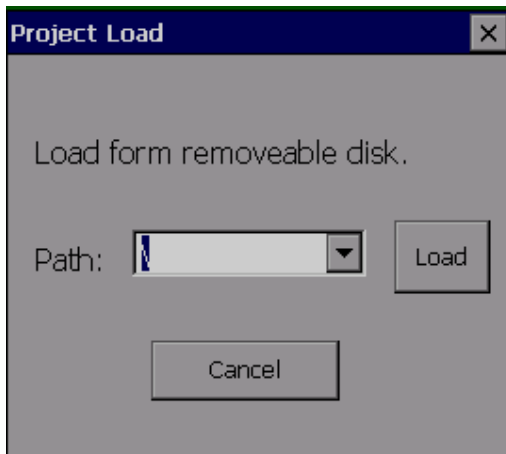
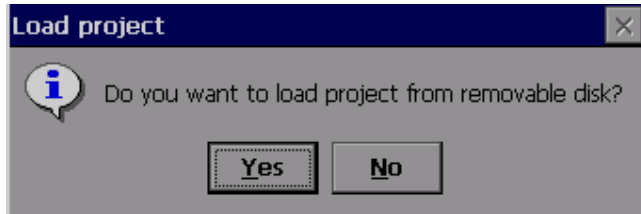

Press "Down" arrow and select the path, if folders are available in USB stick. Then, press on "Load" button near the combo box. If project file is available in selected path, then, it will transfer from USB stick to HMI.

Save button

It is to save application from HMI to USB stick

Clear button

It is to clear application manually in HMI

5.2.4 Instrument

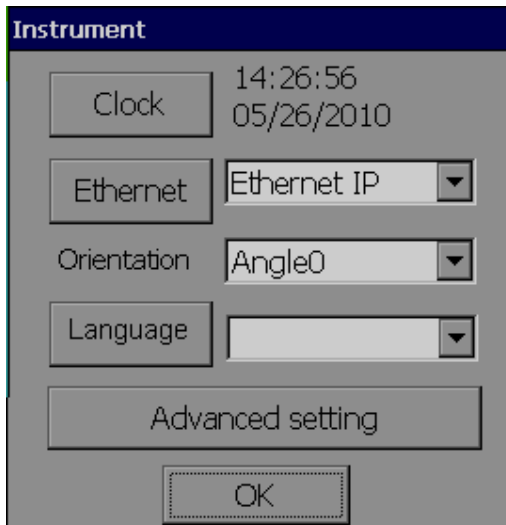

Clock:

It is to set Date Format, Date, Time Format and Time in HMI

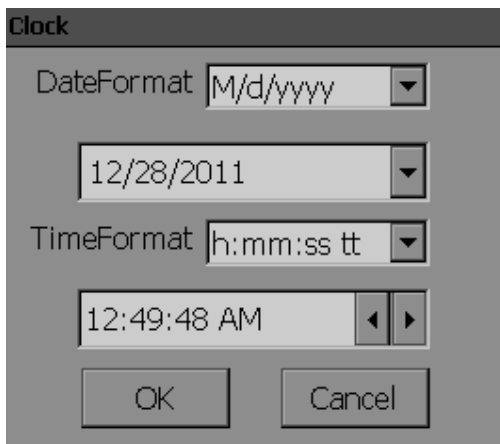

If earlier loaded application using data logging, then, before setting clock, it requires to transfer historical data and alarms from internal memory/SD card to safe place say USB stick or transfer to PC via Ethernet. Other wise, you may loose historical data and alarms in internal memory/SD card permanently after changing the clock

Ethernet:

It is to define IP address to HMI

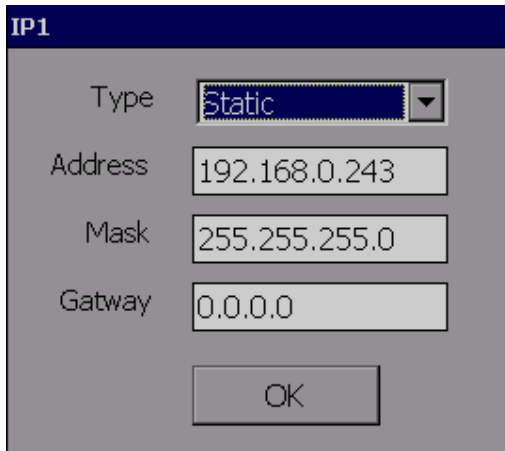

Type: Available options are static and dynamic. If dynamic is selected, then, address, mask and gateway are disabled and they will be assigned by DHCP server automatically.

If it is static, then, user can set IP address for HMI manually

Address: IP address of HMI

Mask: Subnet mask address

Gateway: Gateway address



If HMI is connected with LAN, contact system administrator to allot unique IP address for HMI in network

Orientation:

By default, it is Angle: 0°, other available options are 90°, 180° & 270°

Angle 0° and 180° are for horizontal installation, Angle 90° and 270° for vertical installation.

Horizontal Installation

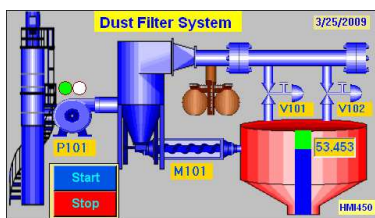

Angle 0°

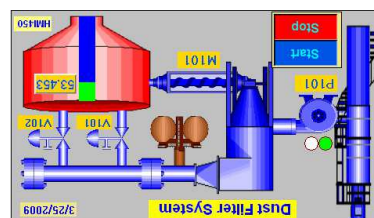

Angle 180°

Vertical Installation

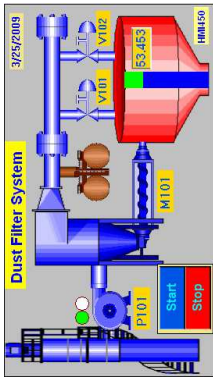

Angle 90 °

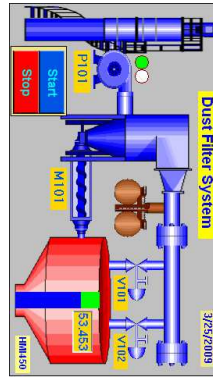

Angle 270 °



The given examples are for illustration only. In practice, if you create a project with horizontal installation and then select Angle 90 °, then, you may not be able to see full screen properly in HMI. For vertical installation, it requires first to select the resolution properly while creating a new project in HMI editor software and then select the same at HMI startup.

HMI 7" (HIGH PERFORMANCE) project

Project creation: Horizontal resolution

Orientation: Angle 0 °

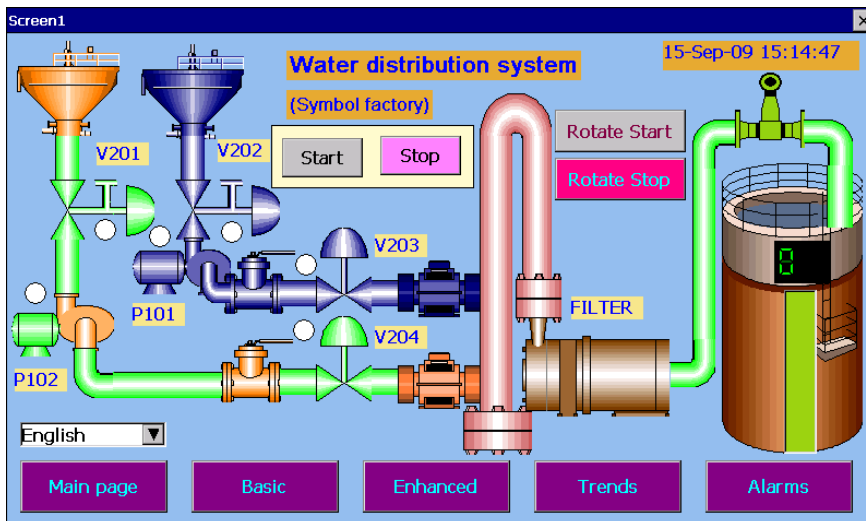

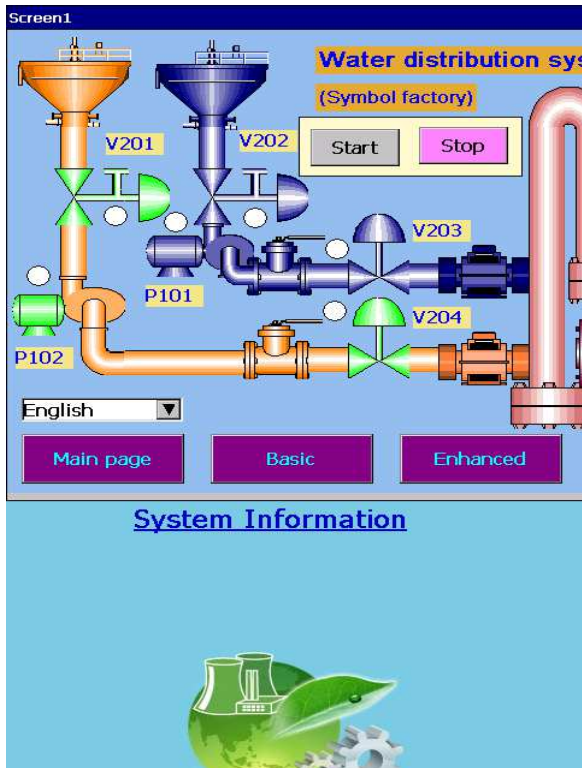

HMI 7" (HIGH PERFORMANCE) project
 Project creation: Horizontal resolution
 Orientation: Angle 90°

Language: It is to select language for the Control center. By default, it is English. Possible language options include Simplified Chinese, Traditional Chinese, Japanese, French, German, Italian, Polish, Spanish, Portuguese, Russian, Thai, Czech, Danish, Dutch, Korean, Swedish and Turkish

Advanced setting:

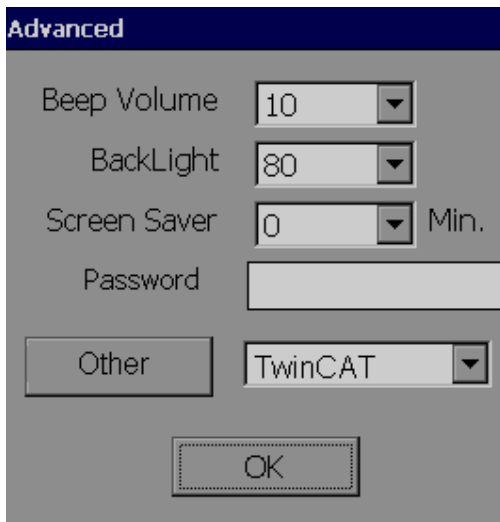

Beep Volume: It is to define beep volume from 5 to 100%. By default, it is 10. 100 means, maximum volume

Back Light: It is to define backlight setting from 5 to 100%. By default, it is 100%. 5 means less back light and you cannot see screen images properly.

Screen Saver: It is to define screen saver in min. from 0 to 60. By default it is 0 which means screen saver function is disabled.

Password: It is to define password for HMI control center. It accepts only numeric entry. If defined, then, it is required to enter password for all control center operations.

First time, it is required to enter password twice, first one is password and next one is for confirmation. If user enter wrong password, it shows message “Wrong password, try again please”.



Other: It is for configuration of special applications.

Example: TwinCAT, to configure TwinCAT Ethernet OPC server, it need to setup configuration at Control center as well. For this, select “TwinCAT”, press “Other” soft button to configure AMS net ID details etc.

5.2.5 Touch Calibrate



It is used to calibrate touch screen. While running the application, if soft button in application is not sensed properly or if boundaries of soft button are shifted, then it might require recalibration of touch screen.

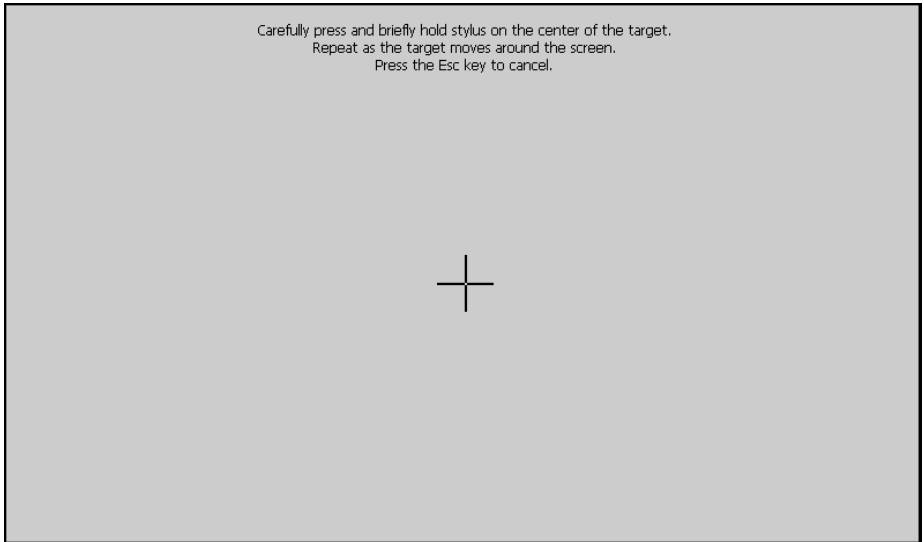

Initially target will be at center. Carefully press and briefly hold stylus on the center of the target. Repeat this procedure as target moves around all the 4 corners.

After completing above step, it prompts message “New calibration settings have been measured”. Press the enter key (touch with finger any screen area) to accept the new settings.

Avoid operating with hard or sharp material such as ball point pen or pencil, use polyacetal pen (stylus tip 0.8 mm or less) if possible.

5.2.6 System Info



Version: Shows current firmware version of HMI

Flash: It shows internal memory status in MB. First one indicates free memory available for use and second one represents total memory capacity. 32 MB reserved for system. So, remaining can be used for application and data logging.

SD card: It shows SD card memory status. First one indicates free memory available for use and second one represents total memory capacity.

USB disk: It shows USB stick memory status. First one indicates free memory available for use and second one represents total memory capacity.

IP/MAC: Display IP address and MAC address of HMI

Update: soft button used to update firmware in HMI.

5.2.6.1 Firmware update procedure

1. Please check current firmware version in your HMI. Power on HMI. At control center, touch soft button “System information” and note down current firmware version
2. Obtain latest firmware files from factory. There are different firmware files for different HMI models and please use correct file to update firmware in your HMI.

Model Firmware version	HMI 4.3”/ HMI 7” (LOW COST)	HMI 7” (HIGH PERFORMANCE) / HMI 10” / HMI 15”	HMI 7” (HIGH PERFORMANCE) / HMI 10” / HMI 15” (1Ghz CPU)
0.99B1/0.99B2 to V1.0	Img.bin(6410) folder- unzip to get IMG.BIN file	Img.bin(PC100) folder-Unzip to get IMG.BIN file	Not applicable
0.99B3 or later to 1.27	HMI_6410.BIN	HMI_PC100.BIN	HMI_PV210.BIN
1.30 to Latest Version	HMI_PC100.BIN	HMI_PV210.BIN	HMI_PV210.BIN

3. Make sure USB stick is empty
4. Copy firmware update file to USB stick directly to root path (do not keep firmware file in any folder)
5. Insert USB stick into HMI
6. Power on HMI
7. In Control center, Press “System information”.
 Note: In case if HMI is not going to Control center screen at power on because of control center settings, hold finger on any touch area and then power on HMI. Then, HMI will go to control center screen at Power on.
8. Press “Update”
Then, follow on screen instructions.

Restart the HMI after firmware update procedure and perform Touch screen calibration once.

 Note: Do not power off HMI during firmware update process. Failure to do so may corrupt files, needs to send HMI back to factory to restore

 Note: After firmware update, it needs to download application again

6. HMI Editing Software

6.1 Project status

During design time, it is possible to check current status of resources being used

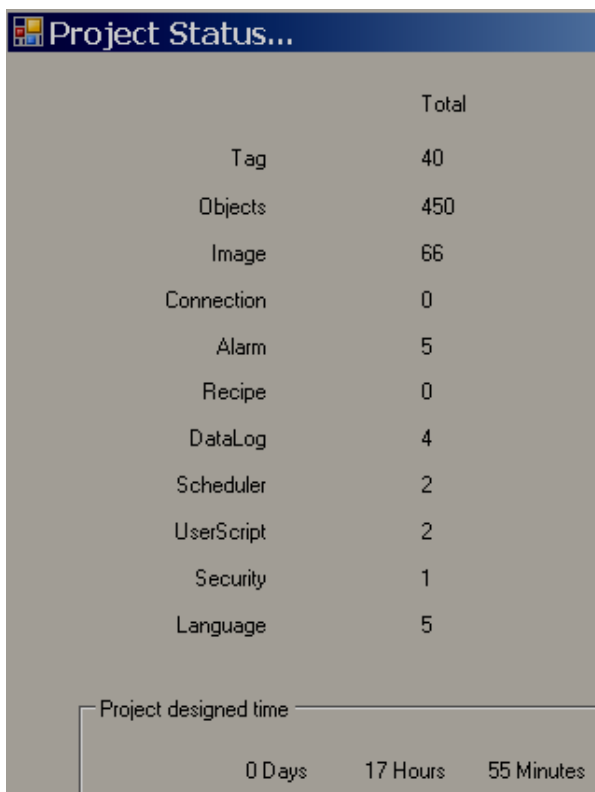
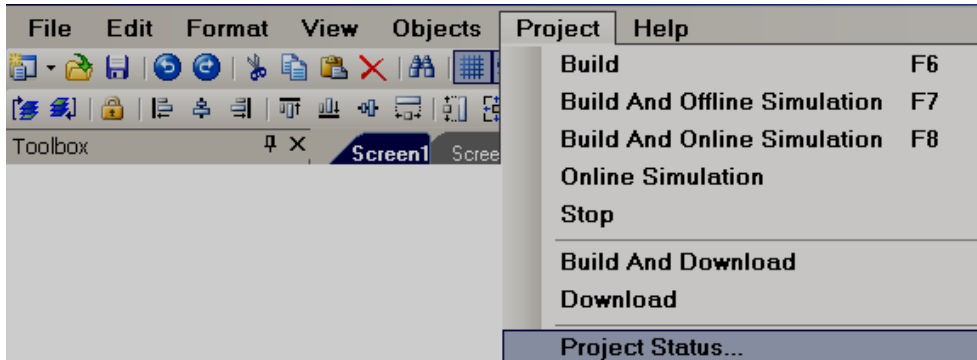

The 'Project Status...' dialog box displays a table of resource counts and a timer for the project's designed time.

	Total
Tag	40
Objects	450
Image	66
Connection	0
Alarm	5
Recipe	0
DataLog	4
Scheduler	2
UserScript	2
Security	1
Language	5

Project designed time: 0 Days 17 Hours 55 Minutes

Images means symbols used from graphics and symbol factory. These symbols also considered as objects so, if you add symbols, it also updates quantity in objects.

For example: If you add 2 symbols and one rectangle object. Then, Images = 2, Objects = 3

6.2 Create new project

Open HMI Editing Software from desktop icon or from Start-Programs-HMI Editing Software

Click on “Create a new project”

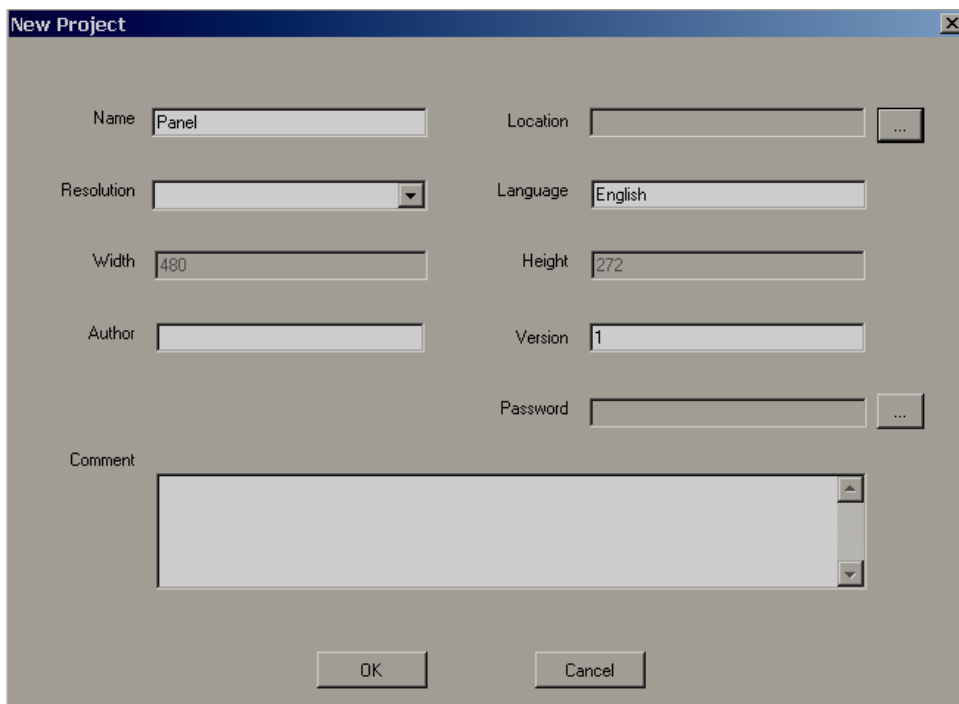
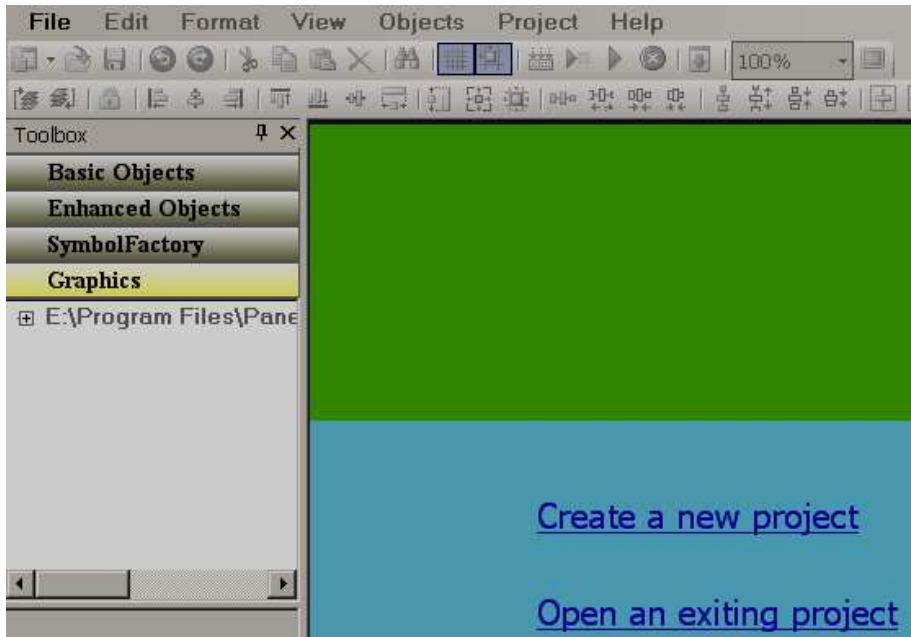
A screenshot of the 'New Project' dialog box. The dialog has a title bar with 'New Project' and a close button. It contains several input fields and buttons. The 'Name' field contains 'Panel'. The 'Location' field is empty with a browse button (...). The 'Resolution' field is a dropdown menu. The 'Language' field contains 'English'. The 'Width' field contains '480' and the 'Height' field contains '272'. The 'Author' field is empty. The 'Version' field contains '1'. The 'Password' field is empty with a browse button (...). There is a 'Comment' text area at the bottom. At the very bottom, there are 'OK' and 'Cancel' buttons.

Project Name: It is Name of Project. For ex: Boiler

Location: It is path for project file storage.

Resolution: Select the required HMI model and resolution

HMI size	Horizontal installation	Vertical Installation
4.3"	480 X 272	272 x 480
7" Low cost	800 x 480	480 x 800
7" High end	800 x 480	480 x 800
10"	1024 x 768	768 x 1024
15"	1024 x 768	768 x 1024

Note: HMI resolution should be selected properly when new project is created.

Default Language: English

Width: It is pixels, resolution in dots available on X-axis

Height: It is pixels, resolution in dots available on Y-axis

Author: Write author name/system integrator name for future reference

Version number: It is for version management

Comments: It is for project management

After entering all the above details, click at "OK"

Description	Horizontal Installation	Vertical Installation
HMI 4.3"	480 X 270	270 X 480
HMI 7" (LOW COST)	800 X 480	480 X 800
HMI 7" (HIGH PERFORMANCE)	800 X 480	480 X 800
HMI 10"	1024 X 768	768 X 1024
HMI 15"	1024 X 768	768 X 1024
Orientation	0 ° or 180 °	90 ° or 270 °

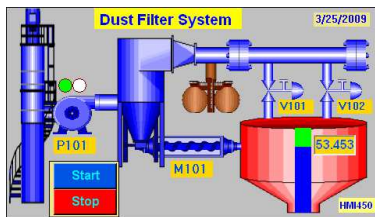

Fig: Horizontal Installation
HMI 4.3", Resolution: 480 X 270,
Orientation Selection at HMI start up 0 °

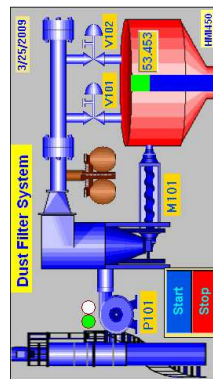

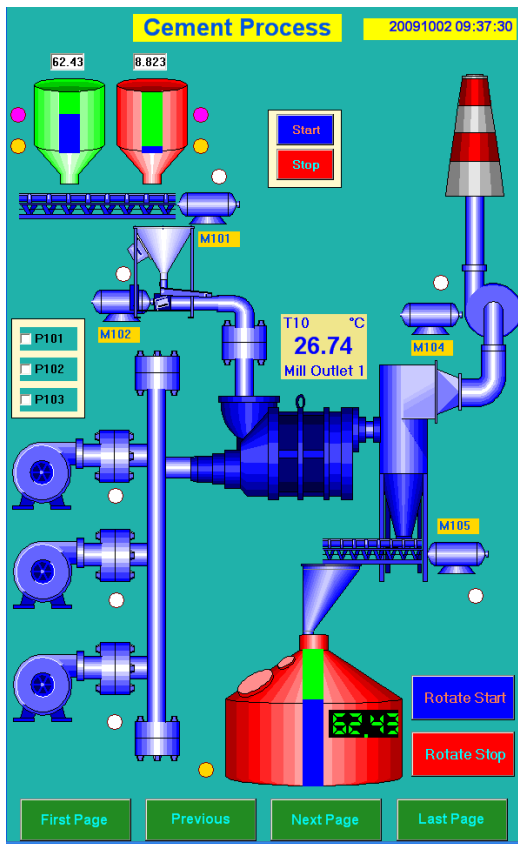

Fig: Vertical Installation
HMI 4.3", Resolution: 480 X 270,
Orientation Selection at HMI start up 90 °

 If HMI 4.3" is to be installed in vertical position, then, set resolution as 270 X 480 at beginning of project, develop application accordingly and set orientation angle at HMI startup. Once project is created with 480 X 270, it cannot be used for vertical installation.

 Once, Resolution is selected for a project, it cannot be modified later or upgrade this project to another project model/size.



HMI 10", Resolution: 768 X 1024,

Fig: Vertical installation,

 While creating new project, select correct HMI size, resolution properly based on Horizontal or Vertical resolution and select orientation angle properly at HMI startup screen.

 For HMI 10" and HMI 15", before creating vertical installation project, please set PC monitor settings properly and make sure that page height = 1024 and Width = 768 are displaying properly in page properties for screen1.

Properties	
Appearance	
BackColor	<input type="checkbox"/> Silver
Text	Screen1
Design	
(Name)	Screen1
Events	
Activated	
Deactivated	

Screen Style	
PageNo	1
ScreenHeight	1024
ScreenWidth	768
Template	
TitleBar	True
Type	Page

 If HMI 10" or HMI 15" is selected, then, suggested PC monitor resolution is 1280 X 1024, other wise, you may be not able to see view full screen in design time. Alternatively, set % view say 50 % or 75% as shown or click on "Full view" icon to view full screen in design time for preview purpose.

The screenshot shows the software interface with the menu bar (File, Edit, Format, View, Objects, Project, Help) and a toolbar. A zoom percentage dropdown menu is open, showing options: 100%, 75%, 100% (highlighted), 125%, 150%, 175%, and 200%. The toolbox is visible on the left, containing Basic Objects and Enhanced Objects.

The screenshot shows the software interface with labels pointing to the Menu bar (File, Edit, Format, View, Objects, Project, Help), Standard bar (toolbar icons), Format bar (zoom percentage dropdown), and Tool box (Basic Objects, Enhanced Objects, SymbolFactory, Graphics). The screen tabs below the toolbar are labeled Screen1 through Screen7.

6.3 Menu bar

File	Edit	Format	View	Objects	Project	Help
------	------	--------	------	---------	---------	------

6.3.1 File

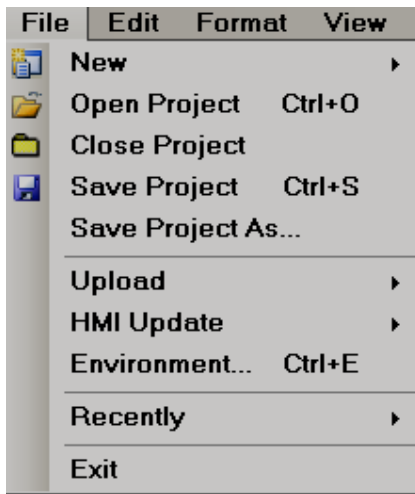

New: To create a new project

Open Project: To open existing project

Close Project: To close present project

Save Project: To save Project in default path

Save Project As: To save project in selected path other than default path specified while creating a new project settings.

Upload: To upload project from HMI back to PC

Recently: It is to open recently opened projects

Exit: To exit from current project

HMI Update: To update HMI firmware directly from PC via Ethernet.

Note: The best way is to update firmware via USB disk

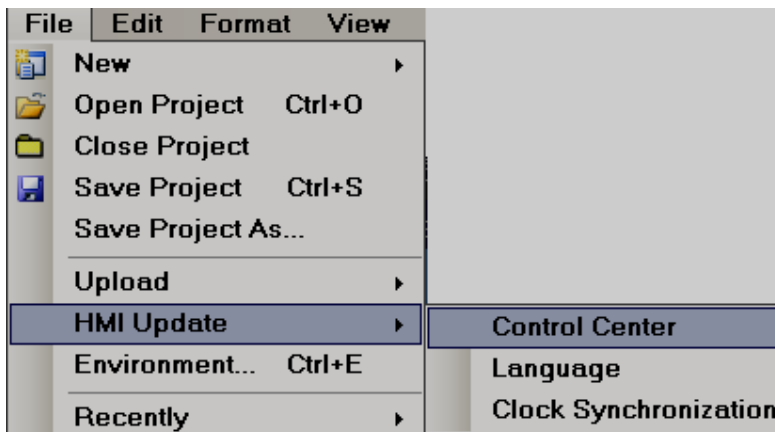

Control Center: To update control center firmware. You need to get latest firmware files from factory and save them in PC say Desktop.

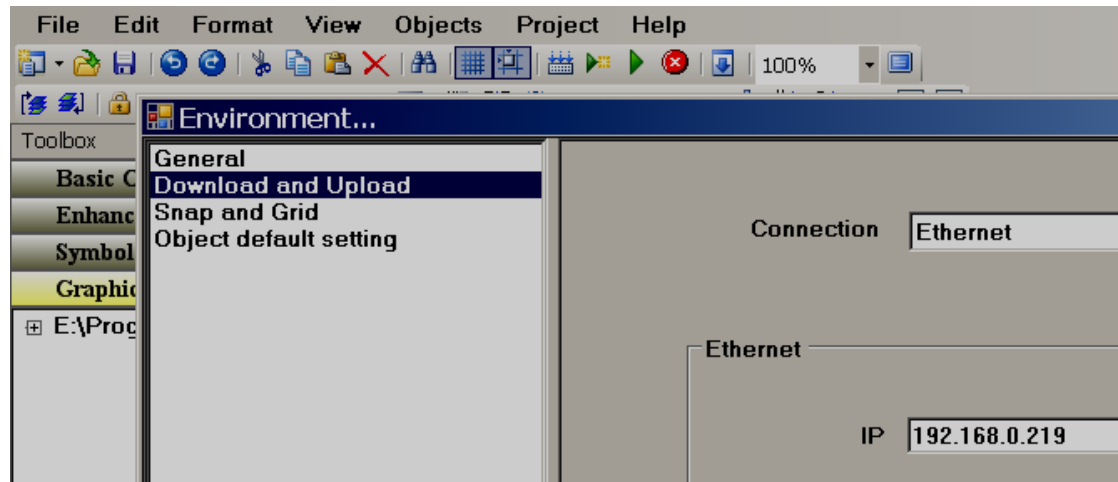

First enter IP address of HMI at Environment settings in HMI editing software as shown above, then, try to update firmware from PC to HMI via Ethernet

Click "HMI Update/Control Center"

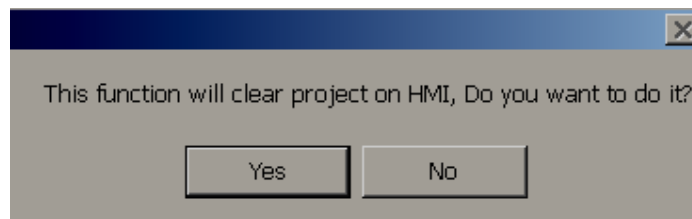

Press "Yes"

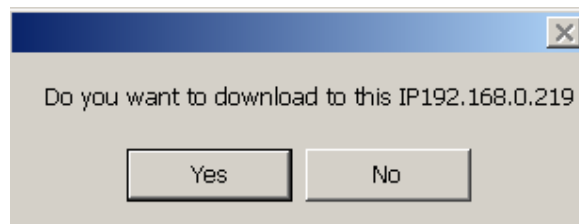
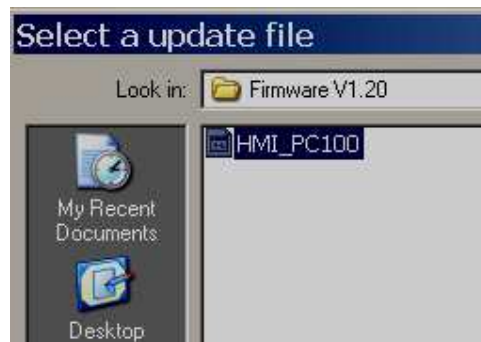

If you see “Download” message for long time, then, there might be problems to clear project. In this case, restart HMI, press “Project” at Control Center. Then, clear the project manually. Then, try to download firmware again

Language: To update language files in HMI. This is required only if new language required at Control Center. Contact factory for further information

Clock Synchronization: To Synchronize HMI clock with PC Clock

6.3.1.1 Environment

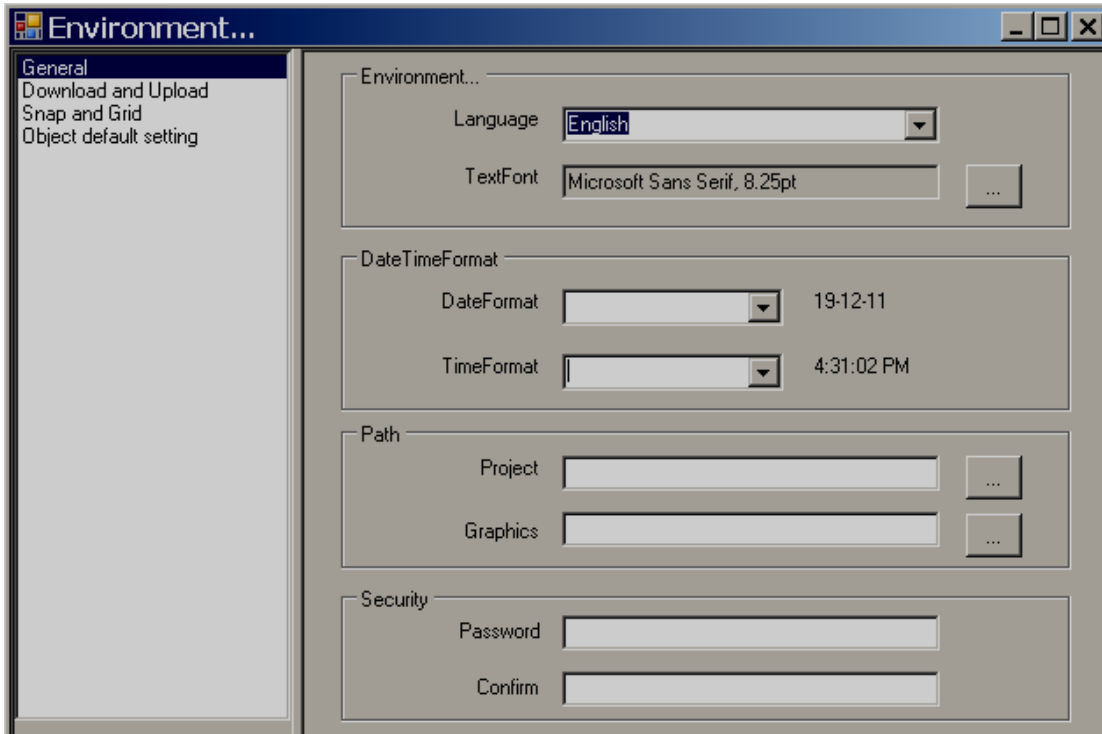

General:

Language: Select Language for project environment. 18 languages are supported from HMI editing software V1.1 onwards including English, Simplified Chinese, Traditional Chinese, Japanese, French, German, Italian, Polish, Spanish, Portuguese, Russian, Thai, Czech, Danish, Dutch, Korean, Swedish and Turkish

Environment font: Select font required for design time environment. Example: Menu, Tool Box, Project explorer, function editor etc.

Project Path: Location to storage of project files
Default project path: C:\Program Files\HMI Editing Software\HMI Editing Software\PanelProject

Graphic Path: Location of default basic Symbols
Default graphic path: C:\Program Files\HMI Editing Software\HMI Editing Software\Basic Symbols

Security: This is to protect opening HMI editing software in specific Personal computer (Not for project). Once password is entered, it is required to enter password correctly to open HMI editing software for the current session. This is useful in factory environment to prevent un- authorized users to open HMI editing software.

Note: If you need password for specific project, then, click at “Settings” in project explorer, select “General” tab and then enter the Password

The screenshot shows a 'Setting' dialog box with three tabs: 'General', 'Runtime', and 'Resource'. The 'General' tab is selected. The dialog contains the following fields and values:

Field	Value
Name	Panel
Location	
Resolution	
Language	English
Width	480
Height	272
Author	
Version	1
Password	
Comment	

Fig: Password for specific project



In general, it is preferred to take back up of project files regularly in other standard storage media like CD, DVD etc. It is recommended to store project files in separate folders at D: drive instead of C: drive. Developer may plan hard disk partition and save all project files in drive other than location of operating system such that even if there are problems with Operating system, still it is possible to retrieve project files.

Download and Upload: Please refer section “Project tools” for more detailed information

Snap and Grid: It is to define grid behavior in design time environment.

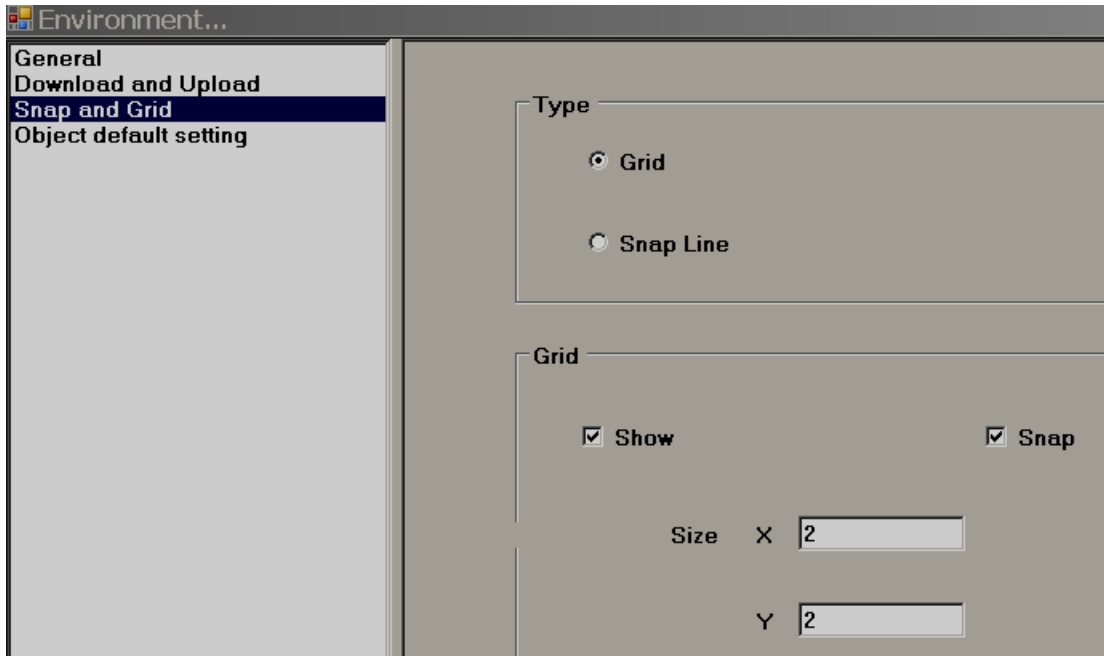

Grid: Select this option and select “Show grid” if grids are to be appeared in screen at design time.

Snap lines: Select this option if grids are not required to appear in screen at design time.

Snap: Select this option if component coordinates should with in grids all the time.

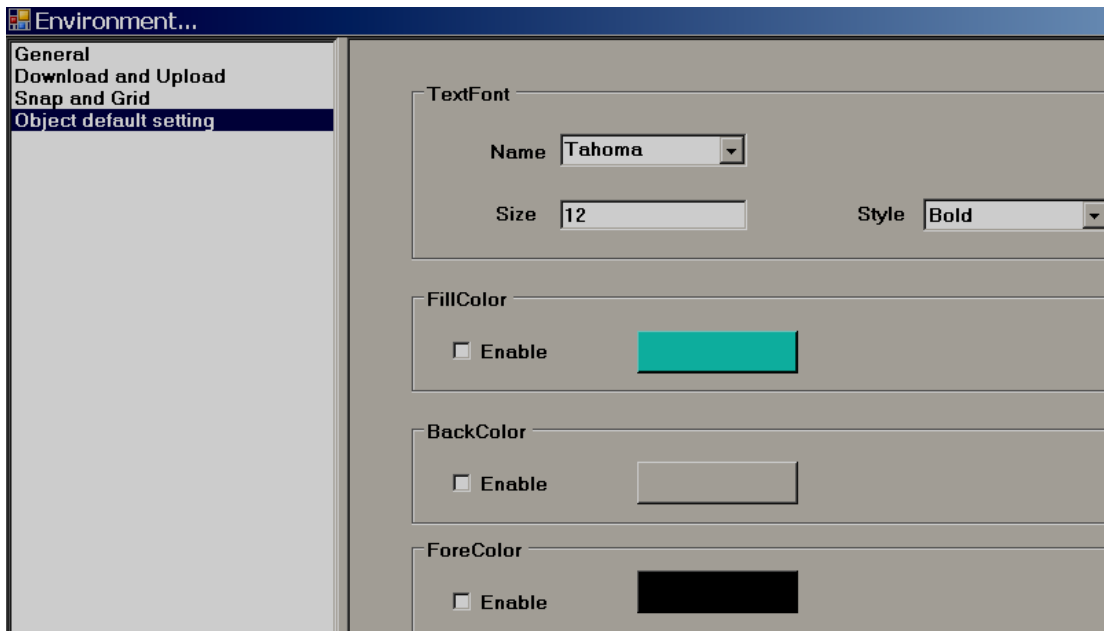

Object: Define default font size, Fill color, Back color and Fore color for the properties of most of the objects like label, Check box, Rectangle, Ellipse, Pie, Table, Dial, Level, Meter, Slider, Thermometer etc.

6.3.2 Edit

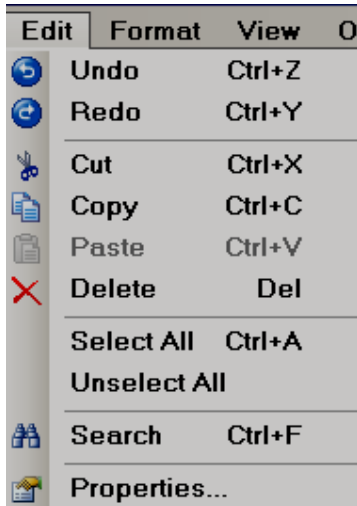

6.3.3 Format

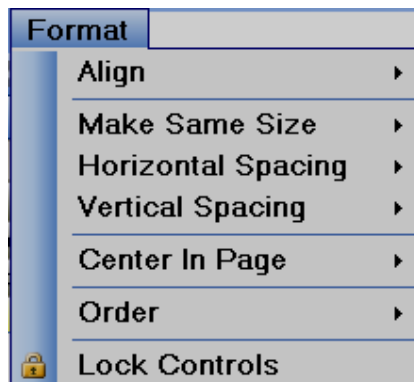

Align: It is to align selected components, objects etc. for adjusting their position precisely in screen layout. Available options for selection are Center, Right, Left, Tops, middle & Bottom.

Ex: Align two Labels to the left in HMI screen.

Assume both labels are created in Screen1. Select both the labels first using mouse, alternatively, select first label by left click at mouse, then press "Ctrl" in keyboard and then select second label by left click at mouse. Now, in Menu, click at "Format", then select "Align", then select "Left".

Before Align adjustment

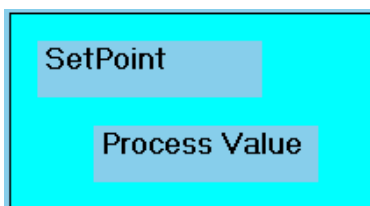

After Left Align adjustment

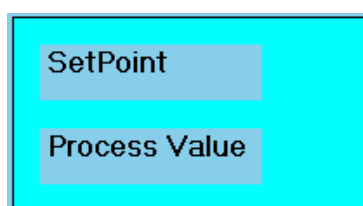

Make Same Size: It is to adjust different objects to the same Width, Height, Both width and height, Size to grid etc.

Ex: Adjust five buttons to same size i.e., height and width.

Create five buttons first say in Template. Then, select all these buttons via Mouse and then click at “Format”, then select “Make same size”, then select “Both”

Before size adjustment

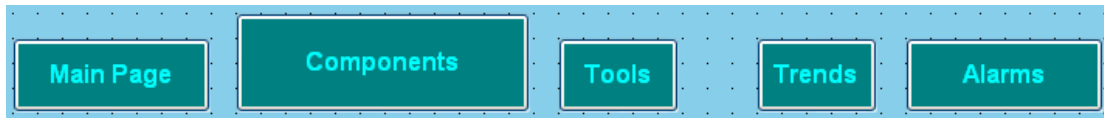

After Same Size adjustment

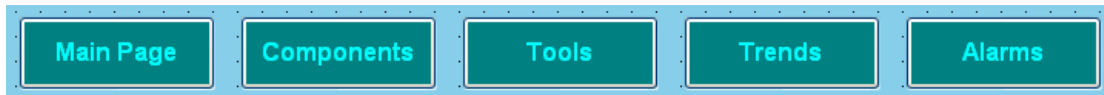

Horizontal spacing: It allows adjustment of horizontal spacing between any objects to make Equal/Increase/Decrease/Remove.

For ex: There are 3 buttons located at bottom area of a page. Spaces between these buttons are not equal and screen is not looking well. Now, select all the 3 buttons via Mouse or using “Ctrl” in keyboard along with mouse and then in Menu bar, click at “Format”, then select “Horizontal spacing”, then select “Make equal”. Now, it adjusts space between all these buttons with equal distance.

Before Spacing adjustment



After Horizontal spacing adjustment



Vertical spacing: It allows adjustment of vertical spacing between any objects to make Equal/Increase/Decrease/Remove

Before Spacing adjustment

After vertical spacing adjustment

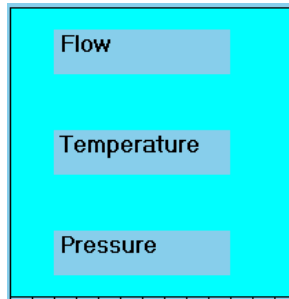
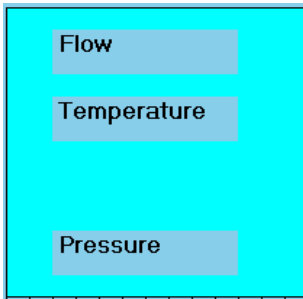

Center in Page: It allows adjustment of objects center in page horizontally and vertically.

For ex: There are 3 buttons located at screen. You wish to locate them center in page horizontally. Then, select these buttons and apply this feature to adjust buttons as per requirement.

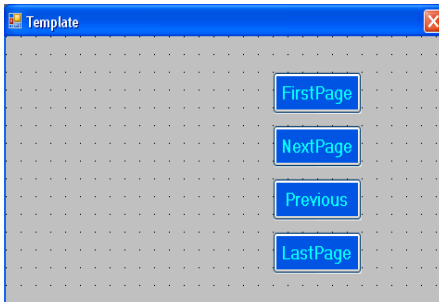

Order:

Bring to back: It take object back

Bring to Front: It take object to the front side

For ex: There is Rectangle box and a label with different colors. If you wish to keep label text on Rectangle, then, for the Rectangle, choose the option, “Bring to Back” and for the label, choose the option “Bring to Front” such that both are visible at same time allowing overlapping of two objects for clear display.

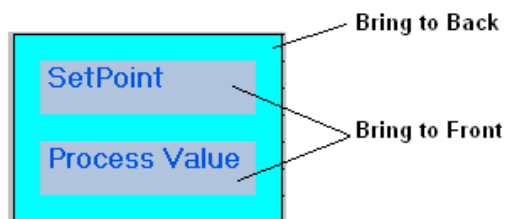

Lock Controls: It is to lock control for further development. Apply this for a second time to unlock the control.

6.3.4 View

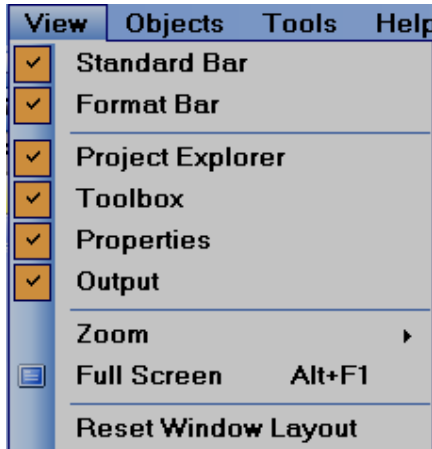

Select the required items to view in window layout.

Properties

If properties is checked as above, then, in the right side bottom of screen layout, properties box will appear showing all the properties for the component/object selected.

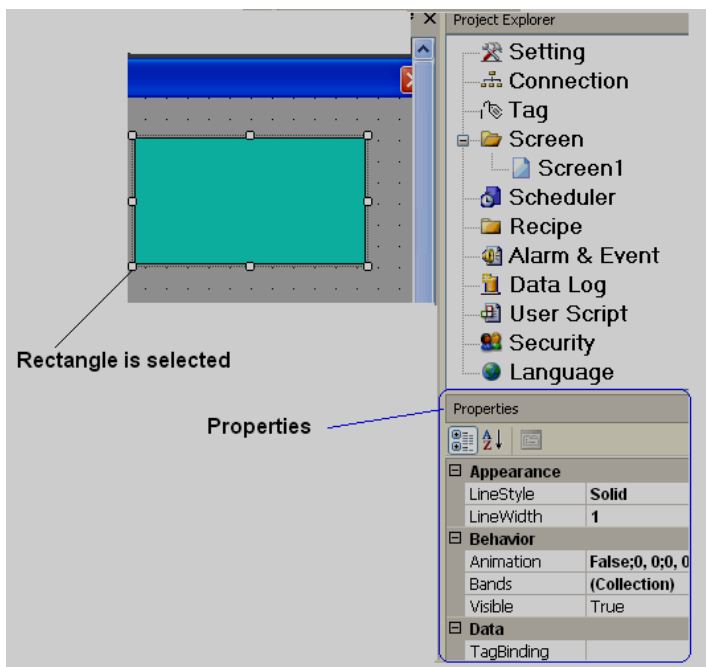

In above example, rectangle is drawn and once it is selected, then right side bottom corner, it shows all the properties for this specific rectangle if properties are checked in view at Menu bar. It is possible to modify properties of rectangle from property grid. Alternatively, double click on Rectangle and enter the same at Graphical wizard.

Output

If output is selected in the view, this window appears just below the screen working area. This window will display any errors that appear during compilation of project.

In Menu, click at “Tools” and then “Build” or alternatively, in standard bar, click at icon  to prepare build for the application. Then, project will compile and it shows summary in the output window as shown below.

```
Output
Screens preparing...
Check automatic of scan....
Screen1 images 0 / 0 objects 1 / 1
Conversion checking...
UserScripts checking...
Objects checking...
Alarms checking...
Scheduler checking...
Datalogs checking...
Recipes checking...
Build started....
Build succeeded.
```

Zoom

It is to Zoom current screen to various % and it is useful during screen editing particularly if screen size of PC screen is less. If 200% is used and if PC screen size is small, then horizontal and vertical slider will appear automatically in screen to navigate to other areas of screen easily.

Full screen

It is to display full screen and after selection, screen layout will be as shown below. To go back, in menu, click at “View” and then “Full screen” again

Reset window layout

It is to display default screen layout showing screen working area, tool box, project explorer, output window etc.



Ex: If user deselects project explorer at View, then it will not show Project explorer at right side of the window layout. In this case, user may select Project explorer again at View, alternatively, in Menu, click at “View” and then “Reset Window Layout”, then it will reset all the view selections and show default window layout.

6.3.5 Objects

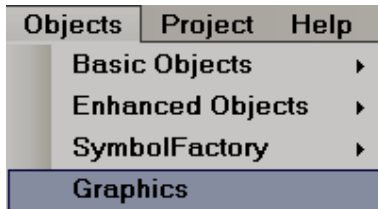

More details about Basic objects, Enhanced objects, Symbol factory and Graphics are explained in section "Tool Box"

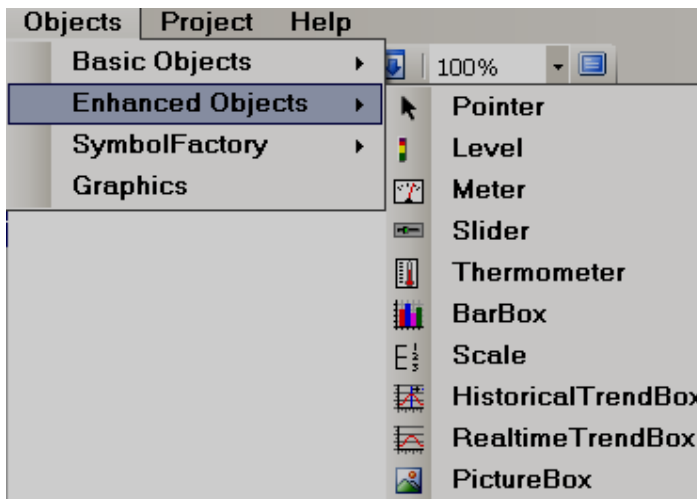
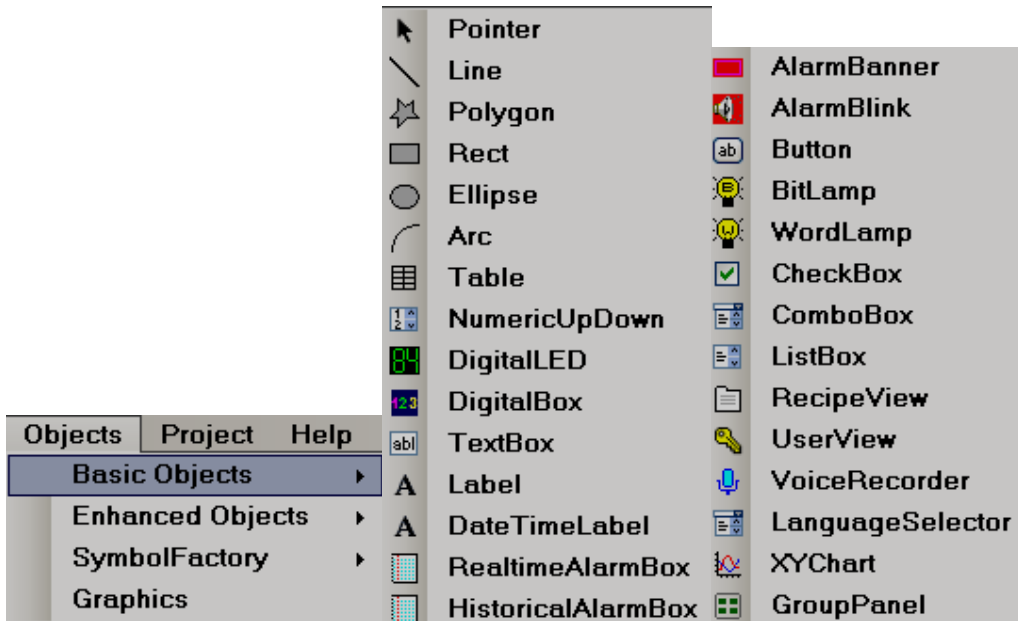



If you would like to increase font size in Menu bar, then, in menu, click at File, then click at “Environment” and then set font settings.

6.3.6 Project

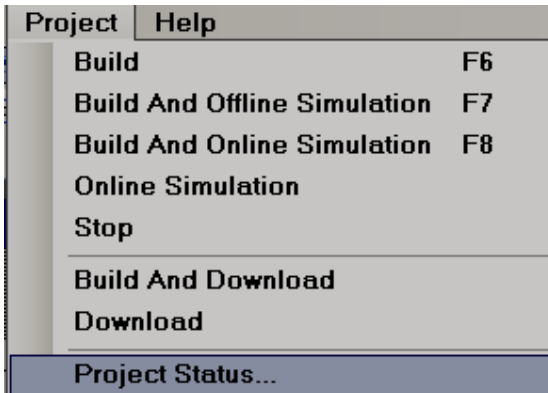

Above details are explained at section “Project Tools”

6.4 Standard bar



New Project



Open Project



Save Project



Undo







Redo



Cut









Copy

-  Paste
-  Delete
-  Search
-  Show Grid
-  Align to Grid
-  Build
-  Offline Simulator
-  Online Simulator
-  Stop simulation
-  Download
-  Full screen

6.5 Format bar



- | | | |
|--|---|--|
|  Bring to Front |  Bring to Back |  Lock the control |
|  Group |  Ungroup |  Align left |

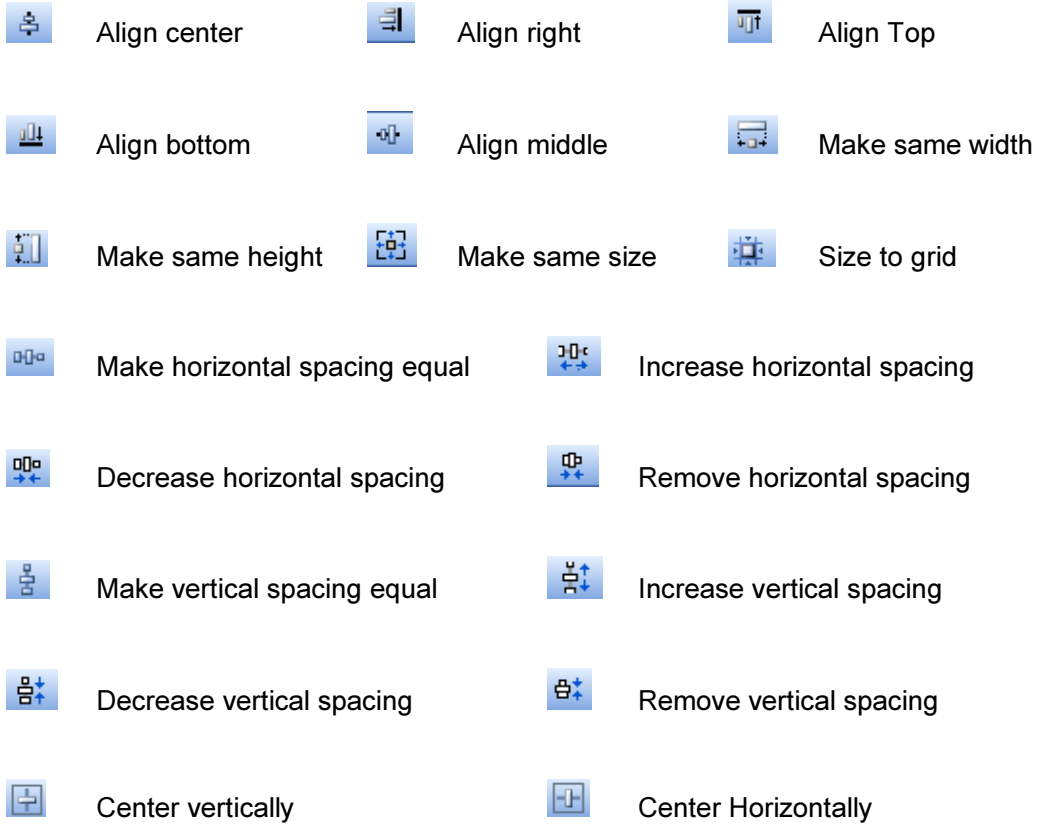

6.6 Project Explorer

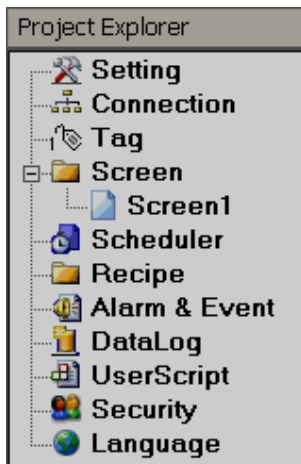

6.6.1 Setting

Project Settings

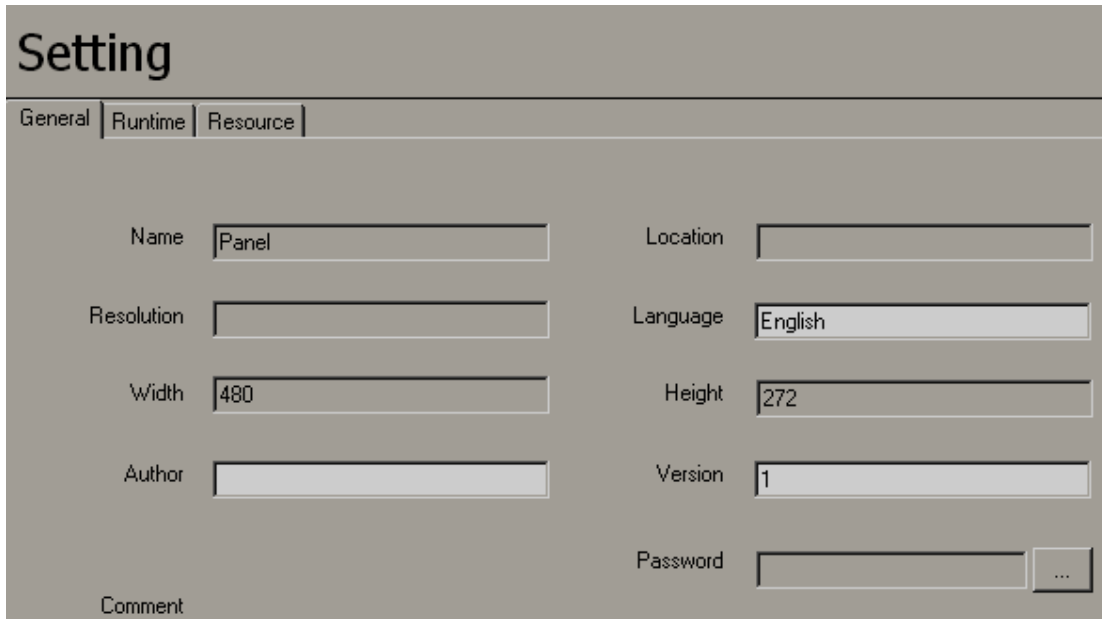

The screenshot shows a 'Setting' dialog box with three tabs: 'General', 'Runtime', and 'Resource'. The 'General' tab is active. It contains several input fields for project configuration:

Field	Value
Name	Panel
Location	
Resolution	
Language	English
Width	480
Height	272
Author	
Version	1
Password	
Comment	

General

While creating a new project, it requires user to enter Project Name, storage location, selection of HMI model with resolution (Horizontal/vertical installation) etc. Some setting like Project Name, storage location, resolution with width & height, Language cannot be modified after creating project, others can be modified later.

Password: It is password for specific project. If defined, then, it is required to remember carefully and it is prompted to enter password when specific project is opened in any PC.

Run Time

The screenshot shows the 'Setting' application with the 'Runtime' tab selected. The settings are as follows:

- Data log storage:** A dropdown menu currently showing 'SD card'.
- Alarm sampling rate:** A dropdown menu showing '1000' with 'ms' as the unit.
- Startup event:** A text input field with a yellow background and a '...' button to its right.
- Shutdown event:** A text input field with a yellow background and a '...' button to its right.
- Project start image:** A large empty rectangular area with a '...' button and a red 'X' button to its right.

It is to select Data, Alarm log path, start up and shutdown expressions

Data log storage: Define data log storage path. Available options include internal memory and optional SD card

Internal storage: Define internal storage path for Historical data and historical Alarms. Available options include internal memory and optional SD card. SD card option is available in selected HMI models. In case large internal memory is required, it need to select SD card and in this case historical data and alarms are stored in SD card instead of internal memory. How ever, retrieval of historical data and alarms from SD card may be little bit slower compared with retrieval from internal memory.

Alarm sampling rate: Define sampling rate for alarms. Default sampling rate is 1000 msec. Range of sampling rate is from 100 msec. to 10,000 msec.

Start up Event: Define events to be executed during HMI power on.

For ex: User can write a script to be executed at HMI power on and these scripts can be selected at start up expression. This feature is useful to initiate some values at register etc. Ex: Tag1=10;

Shutdown Event: Define events to be executed before shutdown of HMI.

Project Start Image: Select the image to be displayed at HMI Power ON. Supported formats include bmp, jpeg & Png. This image will be displayed in HMI after running the application but before showing Screen1

Resource

This is to add list of audio files (.wav format) to play for selection later from Alarms/Events. There are several audio files available in your PC at path C:\WINDOWS\Media

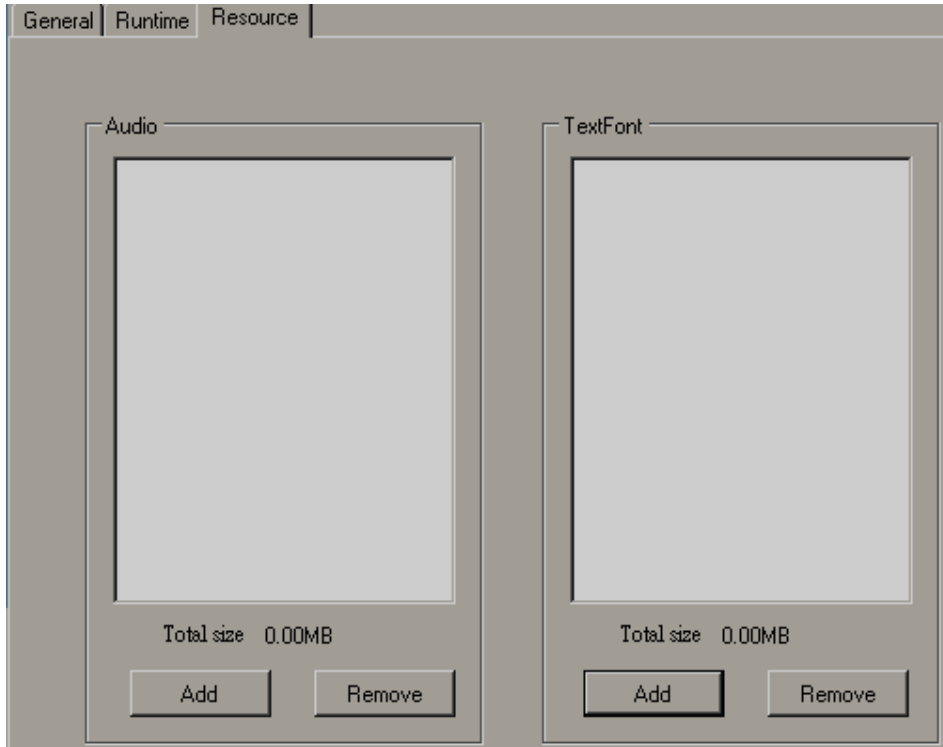

Please refer audio files functions in section “Function editor” for more information about the functions available to use for audio features. Audio functions include “Play sound” once/Loop and “Stop sound”.

This is to add Text fonts for the project. These fonts can be used in the texts on the Objects.

6.6.2 Screen

This is to add new screen to the project.

It is possible to set screen into following types

1. Page
2. Template
3. Popup

When new project is created, screen1 (Page type) is created by default. It is not possible to change screen1 to either template or popup. Screen1 (start page) should be “Page” type only.

How to add a new page

In Project explorer, select “Screen1”, then right click Mouse, then, it shows the screen below. Click at “Add”, Screen2 will be created and appears as shown below.

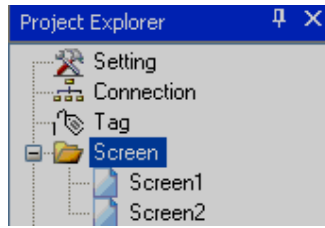
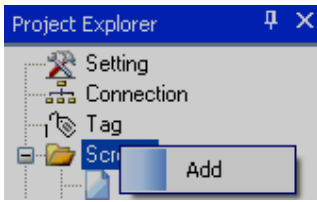

Now, Select Screen1, and then check its properties. For ex: It is possible to change background color of screen from the page properties

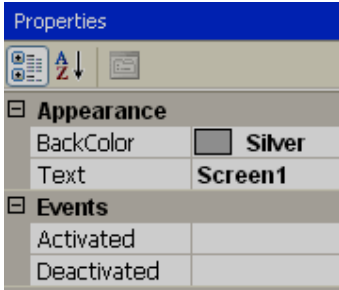

Screen Style	
PageNo	1
ScreenHeight	480
ScreenWidth	800
Template	
TitleBar	True
Type	Page

Right click mouse keeping pointer on any page, then, you can edit screen properties via wizard.

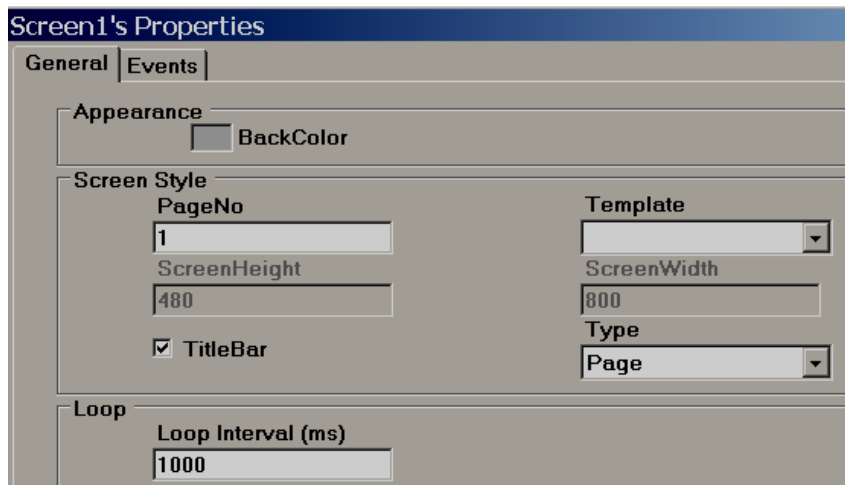
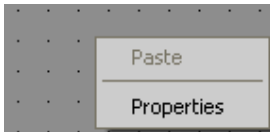

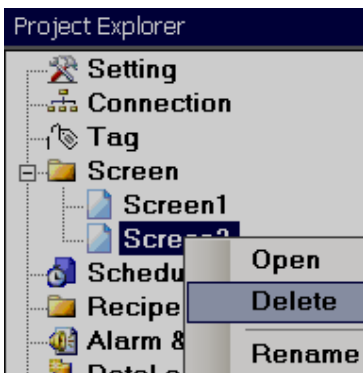
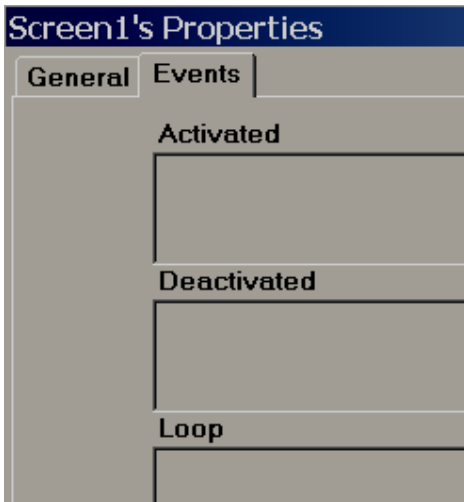

It is possible either to open, delete or rename screen. Select screen, then “Right click” at mouse to appear above dialog.

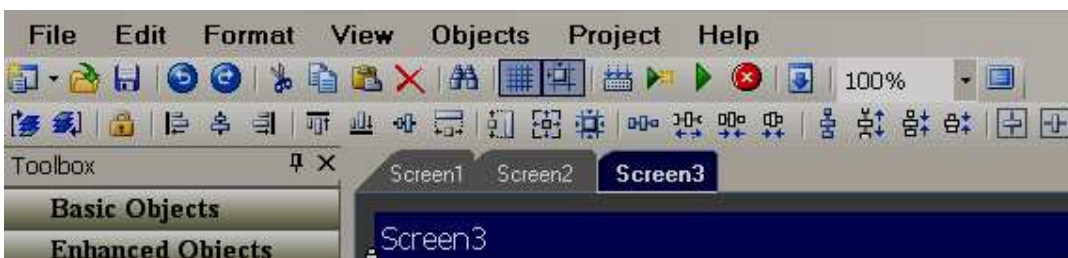

Note: These screen display names are same as available at project explorer. These are different from title bar (Text) defined for screen

Properties:

Back Color: Define background color of component.

Events:

Activated: Define tasks to be executed before opening Screen.

Deactivated: Define tasks to be executed before closing Screen.

Screen Style

Page No: Display current page number.

Screen Height: Define/Display current screen height.

Screen Width: Define/Display current screen width.

Template: Select Template page for this screen.

Title bar: Control visibility of Title bar and select it in design time.



If Title bar = True selected in Page properties, then, number of grids vertically in screen multiplied by grid size will not match with screen height as Title bar occupies some space.

Type: Define type of screen. Available options include Template, Page and Popup.

Template



If some common labels/buttons are required in all the HMI screens, you may customize template any time and these changes will be updated in all the screens available in project dynamically. It is preferred to create a template at the beginning before creating new pages such that you will know clearly about their location while designing new pages. For one project, it is possible to have more than one template and then select them in other pages.

It is to avoid duplication of work and save time.

If any page is created as template (except screen1), it is possible to link it with another normal page.

Ex: Create Screen2 as template, then, insert common objects in screen2 like date, time, page navigation buttons etc... Now in all other screens, select Template = Screen2 such that all objects in screen 2 will appear in other screens. In this case, there is no need to create date/time in every screen, just created once in screen2 and it is linked in other screens.

Note: Screen1 should be Page type only. If you need Template or Popup, create a new screen and then select the type accordingly.

Pop up

It is to pop up small screen with out closing current active screen.

Application: Operator may wish to monitor a bar graph of process value in small screen when he press a button near process value.

Screen2 is defined as popup.

Screen height= 240, Screen width = 400

Now, it is possible to open screen2 from button.

6.6.3 Tag

Mainly there are two types of tags.

User defined Tags (PLC tags, networking tags and internal memory)

System Tags (Available by default)

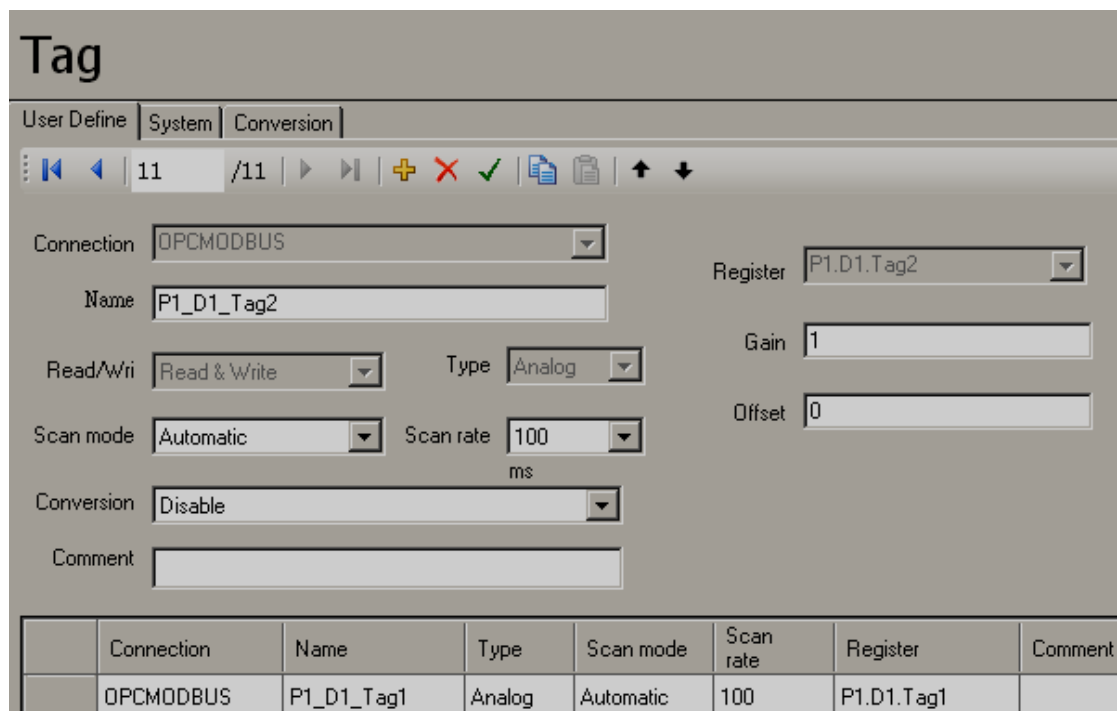

The screenshot shows the 'Tag' configuration window. The 'User Define' tab is active. The configuration includes:

- Connection: OPCMODBUS
- Name: P1_D1_Tag2
- Read/Wri: Read & Write
- Type: Analog
- Scan mode: Automatic
- Scan rate: 100 ms
- Conversion: Disable
- Register: P1.D1.Tag2
- Gain: 1
- Offset: 0
- Comment: (empty)

	Connection	Name	Type	Scan mode	Scan rate	Register	Comment
	OPCMODBUS	P1_D1_Tag1	Analog	Automatic	100	P1.D1.Tag1	

User define Tags

It is a tag data base, containing internal memory, PLC tags & network tags (With network option).

Click at  to add new internal memory tag.

Click at  to delete existing internal memory tag.

Note: To remove Tag created at OPC server, user is required to go to Connection, open OPC server and delete the tag.

Click at  to save changes related to Internal memory tags.



If new tag is added to data base or modifications are done for any existing internal memory tag, click on  to save the changes, other wise, click at any other Row in available Tag list such that changes will be saved to data base automatically other wise, changes will be lost.



It is to Copy and paste tags. Works fine with internal memory tags



It is to move up/down of tags. Works fine with internal memory tags

Name: It is Tag Name

Connection: HMI Internal memory or OPC server tags or devices connected externally via network option.

Connections refers to Protocol selection for specific PLC that is to be connected at Serial port or Ethernet port.

Type: Tag data type, available options for internal memory type tags are Digital, Analog and String.

Scan mode: Automatic, Always, Active on page, None options are available for selection.

Automatic: By default, Tag is selected as Automatic scan mode from V1.20 Onwards

If the scan mode of the Tag selects the [automatic] mode, then, if you use the functions [data log, Alarm , Script, scheduler, RealtimeTrendBox, startup event, shutdown event], then, [automatic] mode will change to the [always] mode automatically in the background of the program during compilation. If Tag is not used in any of above functions, then, its mode will get [OnActivePage] mode automatically.

Always: Tag will be scanned all the time.

Active on Page: If tag is present on specific page say 1, then when Screen1 is opened in run time, specific tag will be scanned as per set scan rate.



For a specific tag, if used in alarm or data logging or scripts etc. then, tag scan mode should be "Automatic or Always". If tags are defined as active page, then, it will improve performance of HMI.

Scan rate (ms): It is the rate at which tag is scanned by HMI from device connected at serial port/Ethernet port as per setting at connection. It is possible to select scan rate from 100 ms. till 10 sec. By default, tag scan rate is 100 m sec.

Comment: Description about the tag cab be entered here.

Default value: Set default value for internal memory tag. By default, it is 0.

Simulation: If enabled, it is possible to simulate this tag value from the HMI. It is useful for testing.

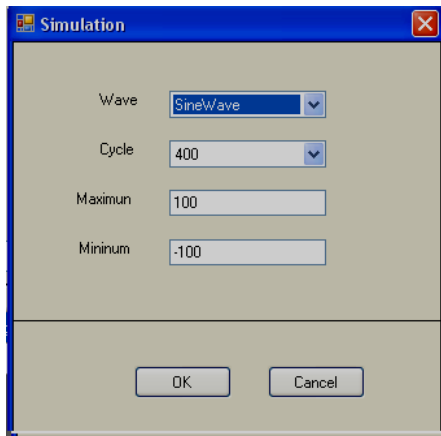

Retentive: If enabled, then, it can retain the value after power recycle. This is useful for set point etc. to retain operator entries. This is applicable only for internal memory tags and not applicable for PLC tags. Also, this is not available for internal string type tag

Offset: It is offset value to correct the sensor error.

Gain: It is a multiplier to correct the sensor error.

The correct value = (the process value + offset) x gain.

Offset and Gain are not applicable for internal memory tags, hence not visible for them.

Conversion: It is for scaling purpose. You can have some predefined conversions formula's and then use them on various tags.



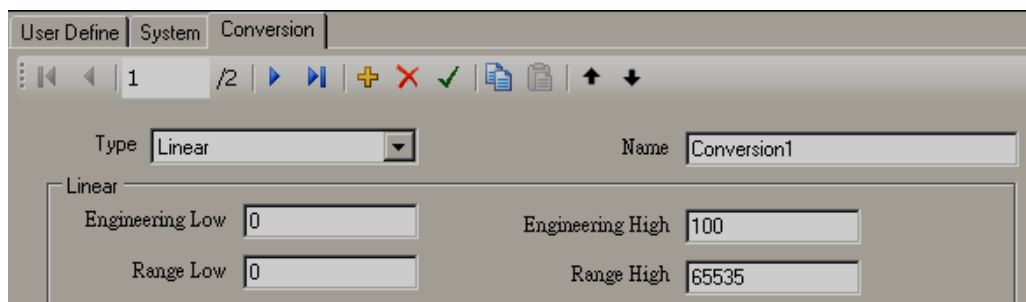

Note: At this time, it is mainly used for Networking tags and General drivers. Similar kind of scaling provision already available with in OPC Server configuration for PLC tags.

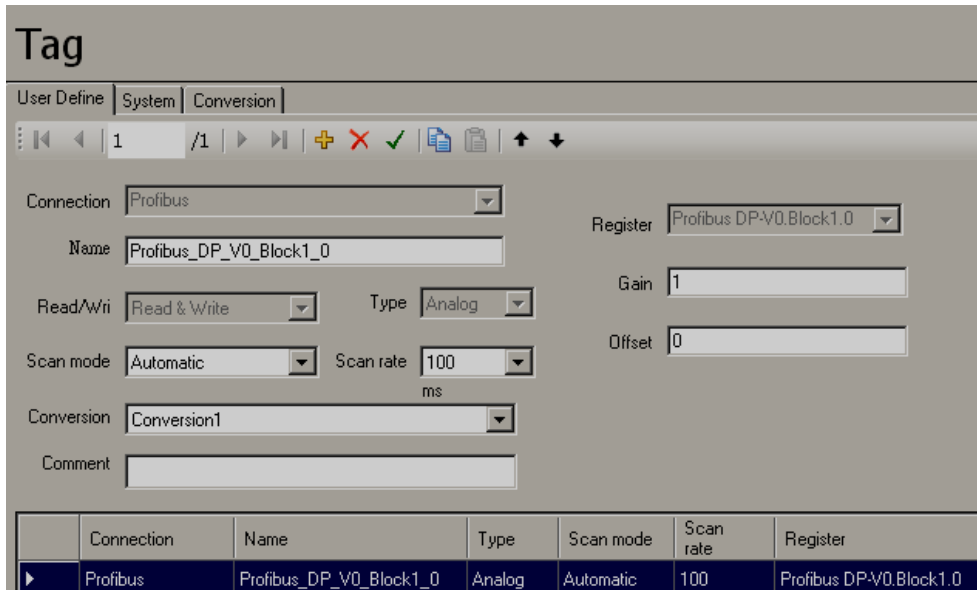
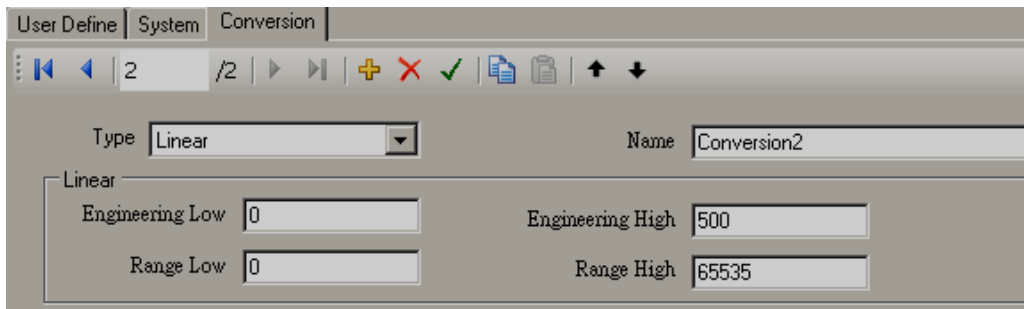

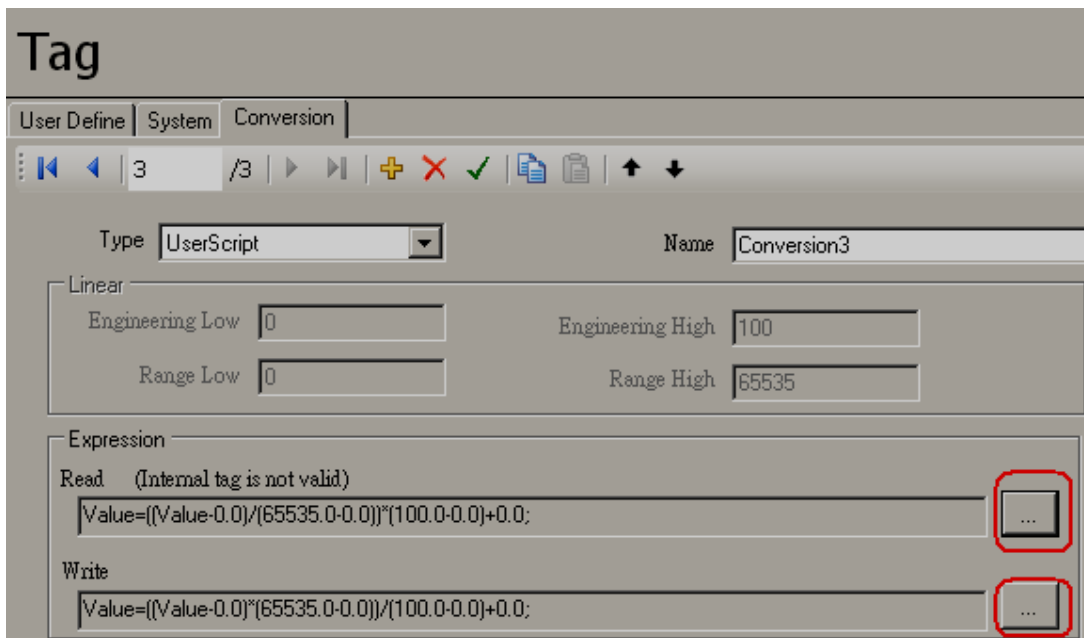

Type: Linear, standard scaling conversion formula used



Type: Script, then, it allows developers to enter custom script for scaling conversion. Click  and then enter required script. Two scripts are available to configure, one for Read and another for Write

System Tags

Tag				
User Define		System		
Name	Type	Comment	Read/Write	
▶ CurrentPage	Analog	Current Page	Read & Write	
CurrentUser	String	Current User	Read	
CurrentSecurityL...	Analog	Current Security Level	Read	
TriggerPer100ms	Digital	Trigger Per 100 milli second	Read	
TriggerPer1sec	Digital	Trigger Per 1 second	Read	
MemoryFull	Digital	Memory Full	Read	
MemoryAvailable...	Analog	Memory Available Present	Read	
NumberofRealim...	Analog	Number of Realtime Alarm	Read	
NumberofHistoric...	Analog	Number of Historical Alarm	Read	
ScreenSaverTime	Analog	Unit: Minute, 0: Disable	Read & Write	
BeeperEnable	Digital	Beeper Enable	Read & Write	

These system tags can be linked with objects like Labels and then displayed in screens. Most of the system tags are Read only except few tags like Beeper Enable, Backlight, Screen Saver time etc.. System tags are available for selection from Tag binding in Property grid as shown below.

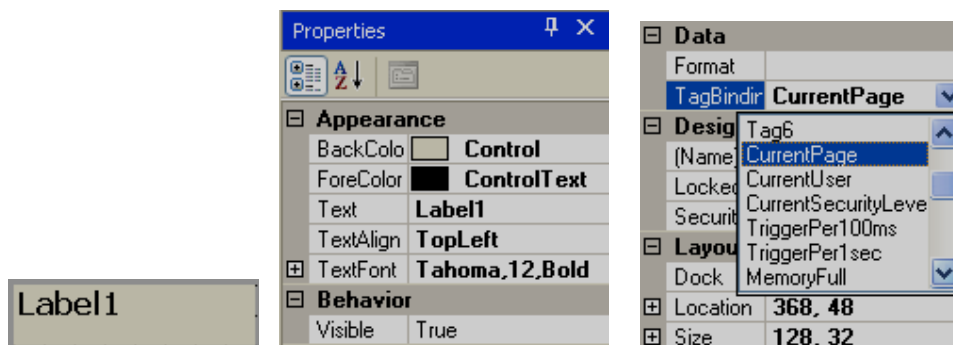

Current Page: Display current page number. It is Analog type system tag and support Read/Write functionality

Commentary note

Ex: There are 10 display pages (1 to 10) and one template screen in a project. Template screen linked to all other display pages. Create a label in a template screen and link with system tag "Current Page". In run time, the above label shows current page number and it shows in all the screens

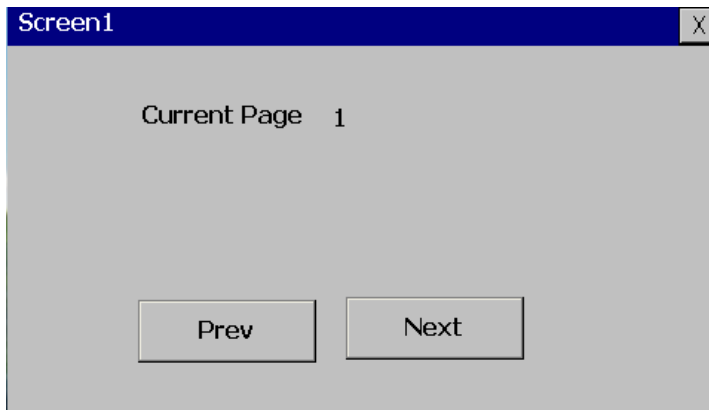

Fig: Screen1 shows value 1

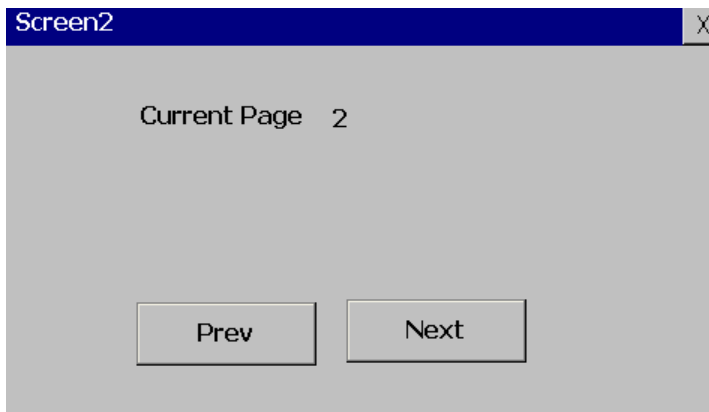

Fig: Screen2 shows value 2

Current user: It is string type tag and display current user name for the current session if security features are configured in project and users are available.

Commentary note

For ex: Login and Logout buttons should be configured first in the project. At run time, user need to login. Then, the label linked with system tag "Current user" will display the current user name in the screen

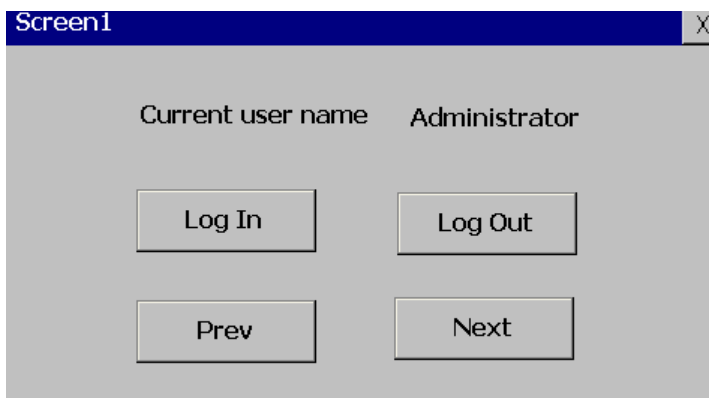

Fig: Display page showing Admin user in screen

Current security level: It is analog type tag and display security level for user logged in the current session.

Commentary note

There are 9 security levels available to assign for the user.

If label object is attached to the above “Current Security Level” system tag, in run time, it will display the security level assigned to the user currently logged into the HMI

In the following example, three users are created with different security levels in the design time. In Run time, display page shows user name and security level as shown below

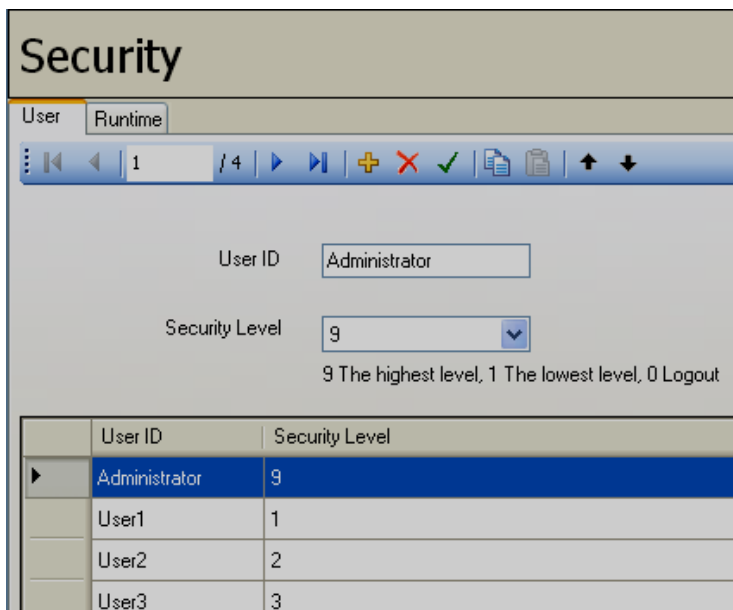
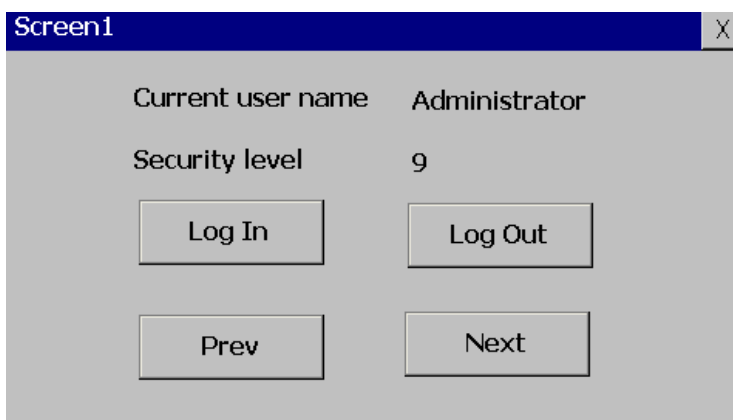

Fig: Security configuration in design time



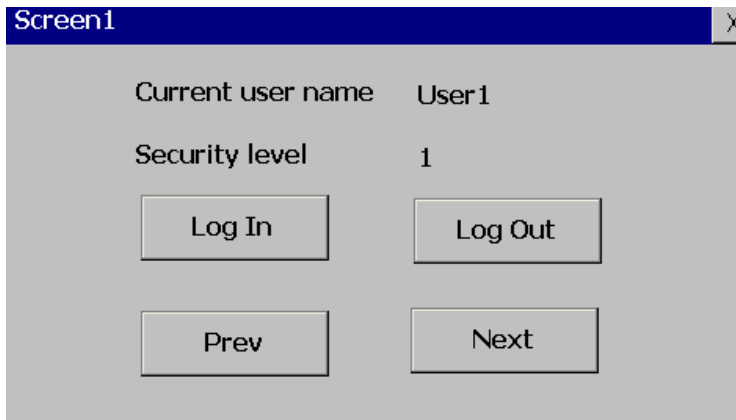
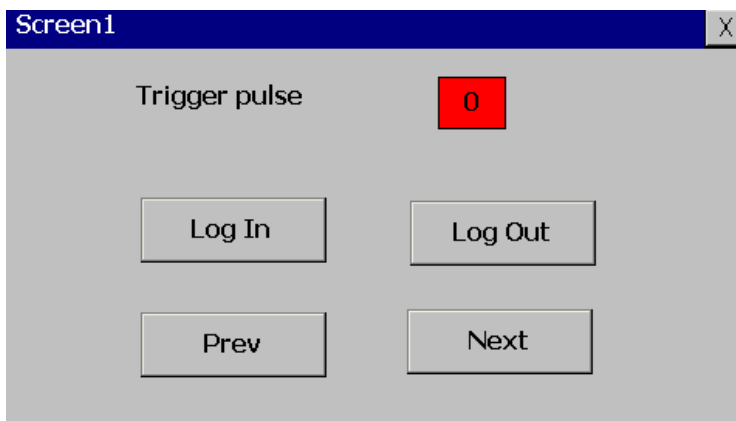
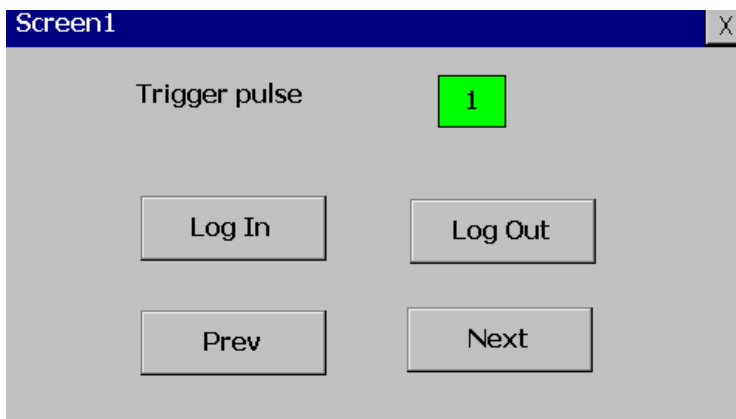

Fig: Display page showing current user name and security level in Run time

Trigger per 100 msec.: It is digital type tag and generates trigger pulse for once in every 100 m sec.

Commentary note

Since this is digital type tag, bit lamp object is used instead of label to link with this system tag for demonstration purpose. Also, color assigned to show green for 1 and 0 for red to display in Run time. For every 100 msec, a pulse is triggered and it can be observed in Run time.



Trigger per 1 sec.: It is digital type tag and generates trigger pulse once in every sec.

Commentary note

The description is similar to the system tag “Trigger per 100 msec.”

In this case, a pulse is triggered once in a second and it can be clearly observed in Run time.

Memory full: It is digital type tag and displays current status of internal memory. Value 0 indicates memory is not full and value 1 indicates internal memory is full.

Commentary note

Bit lamp is linked with “Memory full” system tag in design time

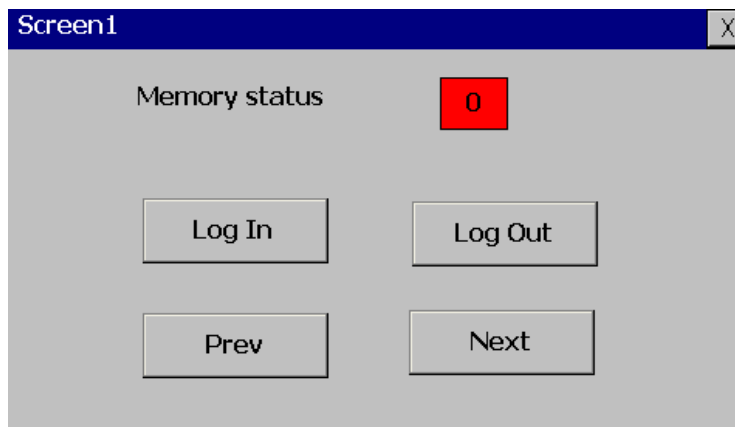
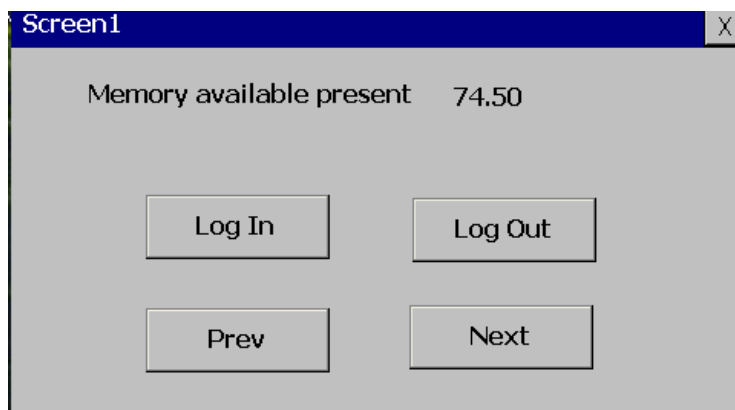

Fig: Bit lamp shows memory is not full in Run time

Memory available present: It is analog type tag and displays current status of internal memory/SD card available in %.

Commentary note

Label is linked with “Memory available present” system tag in design time. If data log configured in HMI, then, it shows value decreasing with time as memory is filled up



Number of Real time alarms: It is analog type tag and display active number of Real time alarms.

Commentary note

It needs to configure Real time alarms in the design time first.

During design time, say Label is linked with “Number of Real time alarms” system tag
Then in run time, it shows number of active alarms.

If alarm is not acknowledged, still it appears in Real time alarm box in run time, but since it is not active, it is not accounted in “Number of Real time alarms” system tag

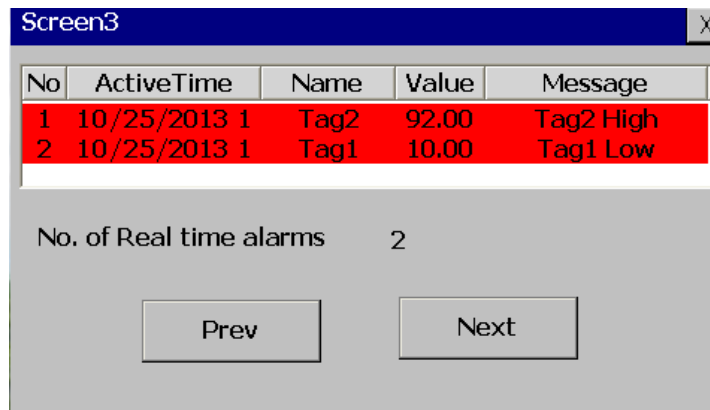

Number of Historical alarms: It is analog type tag and display total number of historical alarms available.

Commentary note

It needs to configure Real time alarms in the design time first.

During design time, say Label is linked with “Number of Historical alarms” system tag
Then in run time, it shows number of Historical alarms.

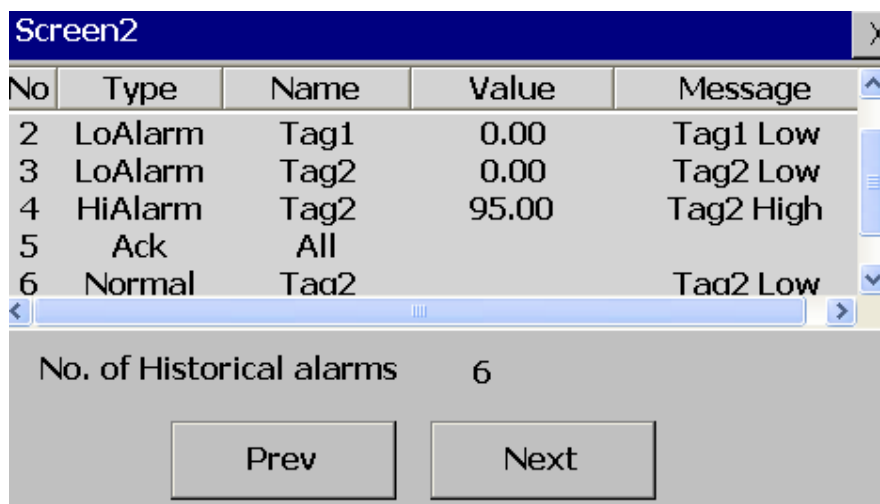

Screen saver time: It is analog type tag and used to enter screen saver time in minutes. Attribute for this tag is Read/Write.

Commentary note

This function is basically to save the LCD's life time

The unit is in minutes

In this example, numeric up/down object is linked with Screen Saver system tag to enter the value in minutes at the Run time

If user does not operate the HMI screen for the set time in minutes, HMI goes to Screen saver mode.

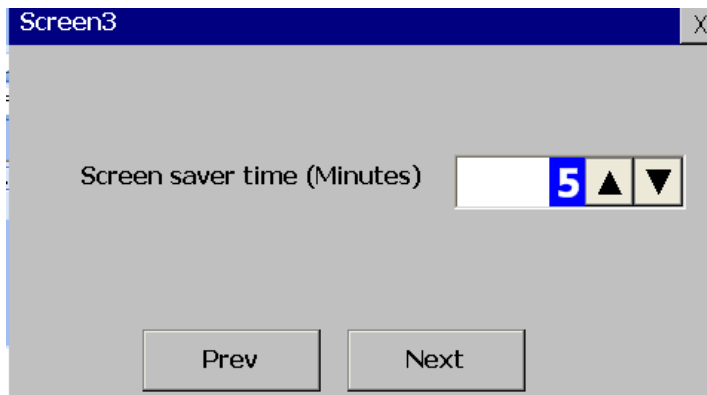

Beeper enable: It is digital type tag and used to enable/disable the beeper.

1 means beeper enable, 0 means beeper disable.

Commentary note

This function is basically used to set either Enable/Disable Beeper in Run time

For ex: In case if there is a new Real time alarm, Beep sound audible to the operators . By default, beep is disabled. To enable beep, set system tag "Beep Enable" to 1. Check box object is useful to enable/disable beeper

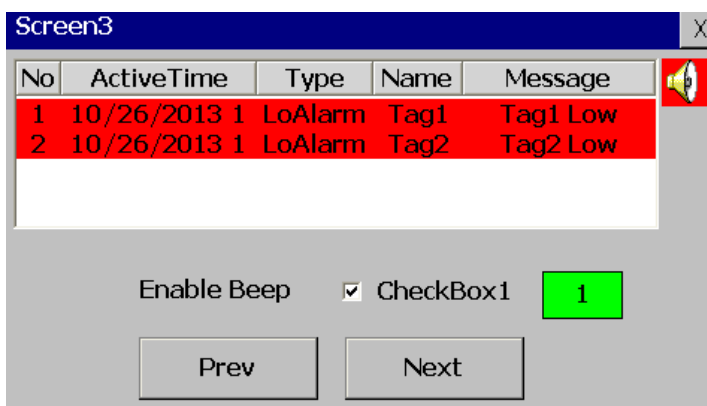

To disable beep, set system tag "Beep Enable" to 0.

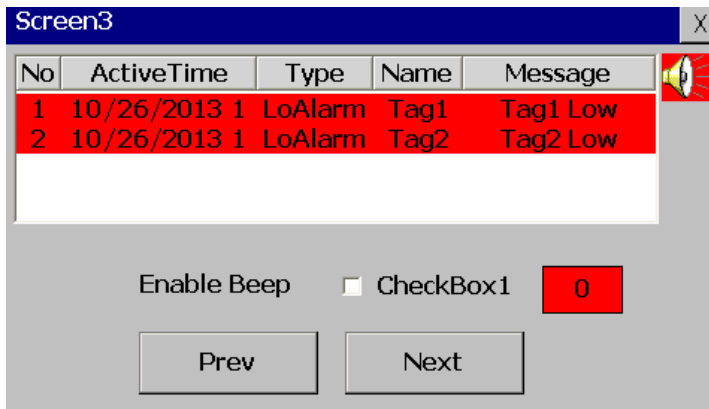

Beeper volume: It is analog type tag, which accepts 0 to 100 as value for volume control

Commentary note

This function is to adjust beep volume between 0 to 100%

0 is minimum and 100 is maximum

Generally, this system tag is used along with System tag "Beeper Enable".

First set Beep Enable = high, then, adjust the beep volume as per requirement

In the below example, numeric up/down object used to adjust beep volume

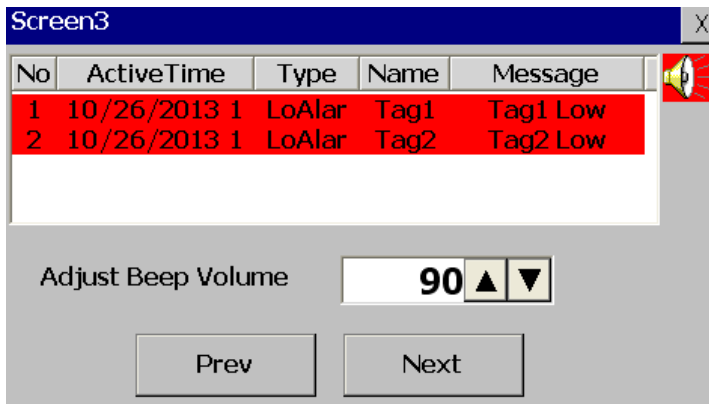

Fig: Operator can adjust beep volume in the Run time as shown above

Back light: It is to set backlight luminance value between 0 and 100.

0 means, backlight luminance is minimum (dark backlight) and 100 means backlight luminance is maximum (Bright backlight).

Commentary note

This function is basically to save the LCD's life time

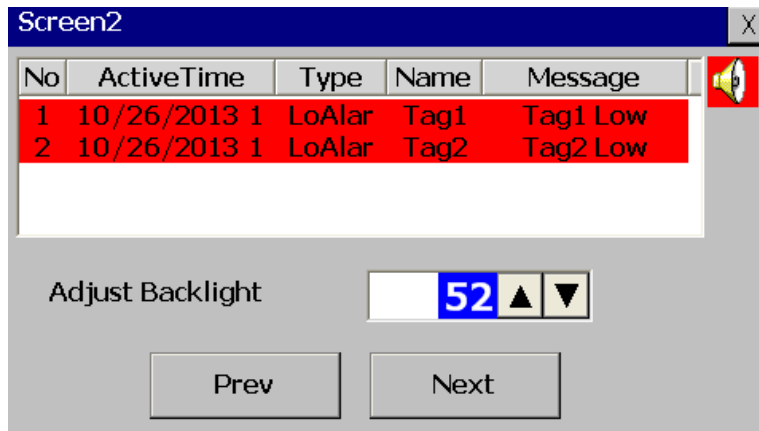

Fig: Operator can adjust Backlight set point in the Run time as shown above

RTC_Day: It is analog type tag and used to display RTC day value.

Commentary note

This is also RTC related system tag .It will have day value between 1 and 31

For ex: Jan 1, 2013, then, this system tag will have value 1

For ex: Oct 26, 2013, then, this system tag will have value 26

No matter if it's what's month, it will have just the value of the day

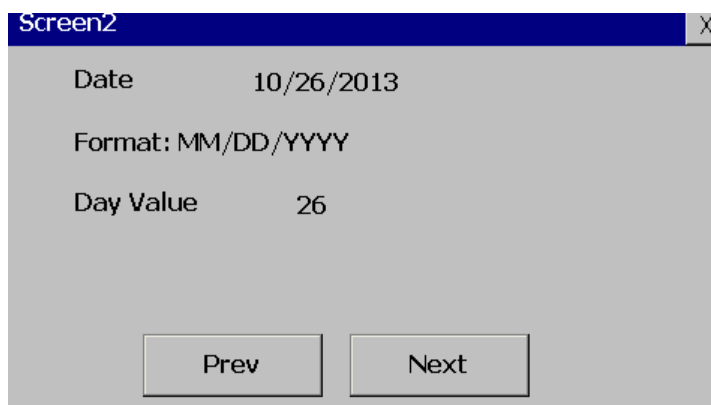

All the system tags related to RTC are Read/Write type. It means, if you wish to change date/time etc.. in run time, you can use Numeric Up/Down object or similar and then set the HMI clock

RTC_Month: It is analog type tag and used to display RTC month value.

Commentary note

This is also RTC related system tag . It will have Month value between 1 and 12

For ex: Jan 1, 2013, then, this system tag will have value 1

For ex: Oct 26, 2013, then, this system tag will have value 10

No matter if it's what's year, it will have just the value of the Month

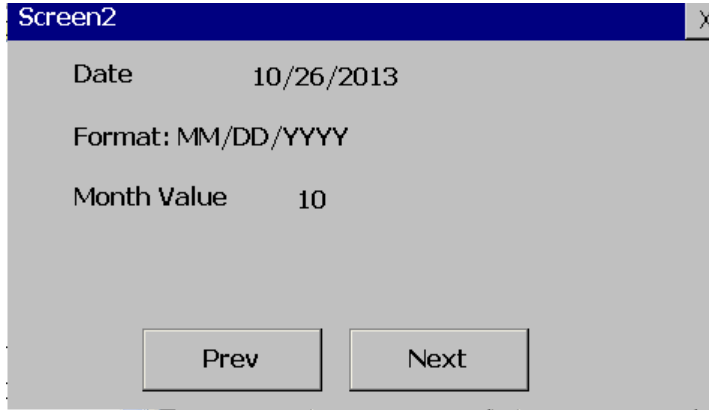

RTC_Year: It is analog type tag and used to display RTC year value.

Commentary note

This is also RTC related system tag .It will have year value

For ex: Jan 1, 2012, then, this system tag will have value 2012

For ex: Oct 26, 2013, then, this system tag will have value 2013

No matter if it's what's date/time in a year, it will have just the value of the year

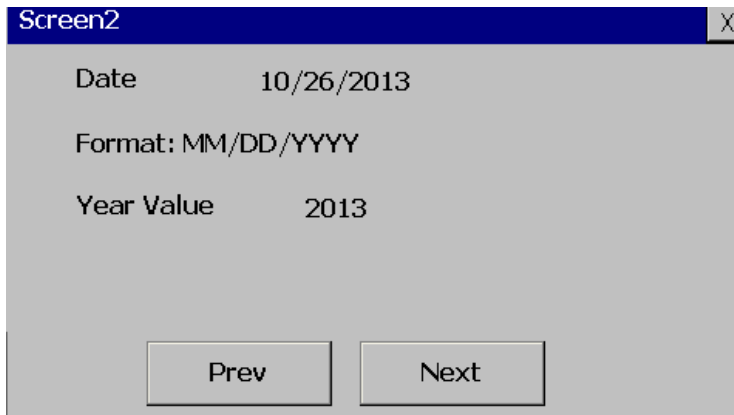

RTC_Hour: It is analog type tag and used to display RTC hour value.

Commentary note

This is also RTC related system tag. The description is similar to the Day/Month/Year. It will have Hour value in between 0 to 24

Sample applications

1. Set clock in Run time via numeric up/down object
2. Use system tag “RTC_Hour” in a script function to Switch on Water pump every day 8.00 hrs and then switch off water pump every day at 10.00 hrs

RTC_Min: It is analog type tag and used to display RTC minute value.

Commentary note

This is also RTC related system tag. The description is similar to the other RTC system tags

RTC_Sec: It is analog type tag and used to display RTC second value.

Commentary note

This is also RTC related system tag. The description is similar to the other RTC system tags

RTC_day of week: It is analog type tag and used to display RTC day of week value like Monday = 1, Tuesday = 2 and so on.

Commentary note

This is also RTC related system tag. The description is similar to the other RTC system tags and the rest is self explanatory

Is data logging: It is digital type tag indicates On/OFF status of data logging.

1 means data logging is running and 0 means data logging stopped

Commentary note

During application development, it is possible to give flexibility to the operator to control data logging in run time. By using this system tag, it is possible to let user understand the current status of data logging In Run time

SystemDI_1: It is system tag for Digital input1

Commentary note

There are total 3 digital inputs available in the option card

This is applicable only in case if your HMI hardware support the option module and fitted in HMI prior to use

If Digital input1 value is high, it will have value 1, if it's low, it will have value 0

Sample application: Pressure high at Pipeline. No additional PLC or IO module required. The IO signal can be directly connected to HMI (Optional module).

SystemDI_2: It is system tag for Digital input2

SystemDI_3: It is system tag for Digital input3

Commentary note

The description is same as above for other DI

SystemDO_1: It is system tag for Digital output1

Commentary note

There are total 3 digital Outputs available in the option card

This is applicable only in case if your HMI hardware support the option module and fitted in HMI prior to use

Sample application: Switch on the heater at 20:00 hrs and switch OFF at 06: 00 hrs. No additional PLC or IO module required. The IO signal can be directly connected from HMI (Optional module) to external relay for the heater control

SystemDO_2: It is system tag for Digital output2

SystemDO_3: It is system tag for Digital output3

Commentary note

The description is same as above for other DO

Note: The above IO card related system tags are available for use only when Sound Input/Output option card installed in HMI on selected models

LanguageIndex: It is to select language index in run time. Default language, index =0. If new language is added, its index number will be 1

Commentary note

This tag is useful to select HMI run time language from external PLC. Use function, Copy "TagB to TagA" to copy PLC tag value to "LanguageIndex" system tag.

	English	Russian
	This user account is closed.	This user account is closed.
	Ack	Ack
	Label1	Label1
	Next	Next
	Prev	Prev
	Language index	Language index
▶	Hello	привет
	Read/Write	Read/Write
	Read	Read
	Set Language	Set Language

Screen1 [X]

Hello

Language index 0 Read

Set Language Read/Write

Prev Next Ack

Screen1 [X]

привет

Language index 1 Read

Set Language Read/Write

Prev Next Ack

Input Tag: It is used for custom keyboard application. Please refer function “EditSystemTag” at section 6.7.1.19 for more details

CurrentRecipeName : Write Current Recipe Name into system tag after pressing icon

 “Write to PLC” at Recipe object in Run time

Commentary note

This tag is useful to select the current Recipe in run time and transfer this information to external connected devices.

This system tag is useful only if more than one Recipe configured in HMI

Please refer section “Recipe” for more details about functions available for handling Recipes

CurrentRecipeDataRecord : Write Current Recipe data record name into system tag after pressing icon  “Write to PLC” at Recipe object in Run time

Commentary note

This tag is useful to select the current Recipe data record in run time and transfer this information to external connected devices.

This system tag is useful only if more than one Recipe Records are available

Please refer section “Recipe” for more details about functions available for handling Recipes

SamplingOverloaded: It is read only tag

Commentary note

This tag provided for diagnostic purpose only. It provide basic clues in advance about potential issues between HMI and connected devices

Overloading system tag value under 1,000, communication and performance is safe on specific screen

If overloading system tag value is increasing and not reducing, there is potentially problem in specific screen

If overloading system tag value over 4,000, Communication and Performance will be affected seriously

Log Out Time: It is to write the Log out time for Security Level.
It is used to Logout the User automatically after the Set time.

6.6.4 Connection

It's to configure connection. Possible options include OPC server, other networks and General.

- a) OPC server: Configure HMI as OPC server for COM1, COM2 and Ethernet port(s)

b) Other networks: Configure HMI as fieldbus slave on COM3 Ex: DeviceNet, CAN Open etc. It's an option and works only after plug in specific fieldbus option module

c) General: Configure HMI as Slave for COM1/COM2. Drivers include Modbus RTU Slave, Modbus TCP Slave etc.

6.6.4.1 OPC server

Name	Type	Parameter	Comment
OPCABDF1	OPC Server	OPCABDF1	

OPC server is Protocol driver to communicate with PLC on specific protocol.



One additional common user manual is available for OPC server configuration. Every driver has dedicated user manuals. Refer to these manuals for more information about specific OPC server and configuration details.

OPC server user manual details



OPC server user manuals for each driver can be accessed from software itself during configuration of specific driver from menu bar as shown below

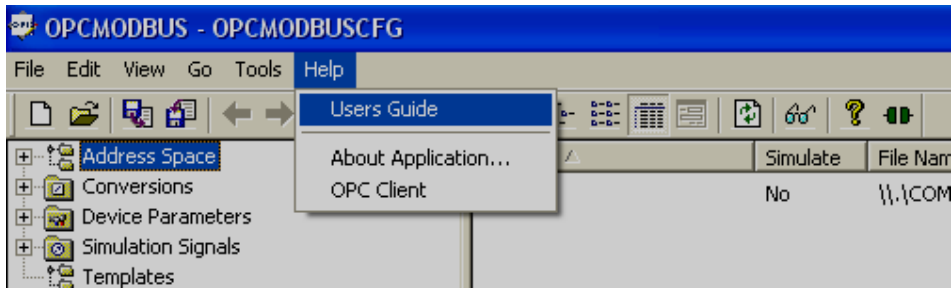

OPC server is to configure specific protocol at COM1/COM2 port and Ethernet Port. One connection means, one unique OPC server used. If you would like to connect same PLC (same protocol) on both COM ports, then, it needs only one unique OPC server for specific protocol. No need to define two connections, one connection is enough. With a single connection, it is possible to define COM1 and COM2 ports. You just need to define what COM ports you need in specific connection itself.

Case1 (Correct)

Connection 1 = OPC Server1, Ex: ABDF1, serial (COM1 port)

Connection 2 = OPC Server2, Ex: Siemens, Serial –MPI protocol (COM2 port)

Connection 3 = Ethernet port, Protocol1

Connection 4 = Ethernet port, Protocol 2

Case2 (Correct)

Connection 1 = OPC Server1, Ex: ABDF1, serial (COM1 port)
Ex: ABDF1, serial (COM2 port)

Connection 3 = Ethernet port, Protocol1

Connection 4 = Ethernet port, Protocol 2



In this case, one connection is enough and OPC configuration will be as shown attached

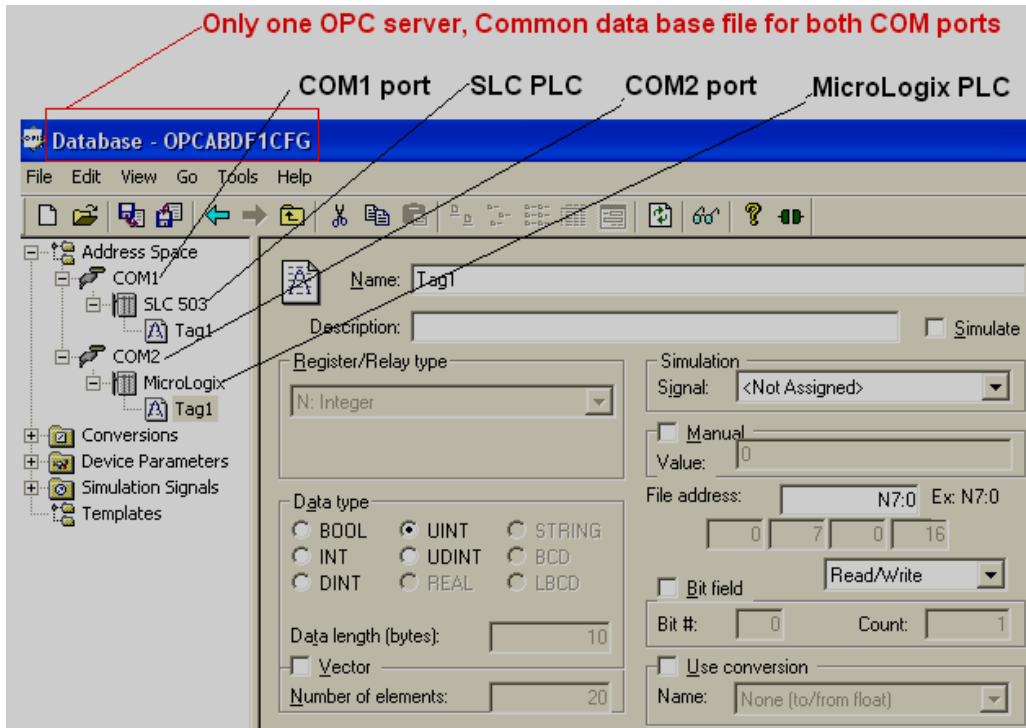

Case3 (Not correct)

Connection 1 = OPC Server1, Ex: ABDF1, serial (COM1 port)
(SLC 5/03 or ML1000 etc...)

Connection 2 = OPC Server1, Ex: ABDF1, serial (COM2 port)
(SLC 5/03 or ML1000 etc...)

Connection 3 = Ethernet port, Protocol1

Connection 4 = Ethernet port, Protocol 2

There is no need to configure ABDF1 at Connection1 and Connection2. It is not efficient. Just use one connection and define both COM ports as shown in case 2.

Case4 (Not correct)

Connection 1 = OPC Server1, Ex: ABDF1, serial (COM1 port).

Connection 2 = OPC Server2, Siemens, Serial –MPI protocol (COM1 port).

Connection 3 = Ethernet port, Protocol1.

Connection 4 = Ethernet port, Protocol 2.

It is invalid to configure different kind of protocols for same COM1 port.



One OPC server (Only one PLC vendor) is supported at each serial port at any given time.

For ex: If protocol, Allen Bradley DF1 is configured at COM1 port, then, it is not valid to create any other protocol like Siemens PPI for COM1 port again. It has to be entered (taken care) manually when creating connections and OPC server configuration.



Do not attempt to connect PLC's from different vendors at same serial ports unless both of them support same kind of protocols like Modbus. Make sure correct communication cable is being used between PLC and HMI to avoid communication problems.

On Ethernet protocol, it will support more than one protocol. For example: You can create number of connections each connection with specific Ethernet based protocols. Example: Connection 3 for Modbus TCP, Connection 4 for Siemens Ethernet etc.

Name: It is connection name.

Protocol: Select protocol from the list of protocols.

OPC Server: Select OPC server.

Comment: for later reference.

How to add/delete connections



Click on  to add one more connection.

Click on  to delete connection.



Click on  to save the modifications at connections other wise, the modifications may be not saved for the connection configuration. Alternatively click at any row in the connection to save the connection configurations after modification.

6.6.4.2 Other networks (Fieldbus)

It is to configure HMI as Fieldbus slave. Supported fieldbus includes Profibus DPV1, CANopen, DeviceNet, Ethernet/IP, ProfiNetIO etc..

Please note that, it need plug in module to get this connectivity and it is an option. It is possible to order HMI first and then add required network option plug in module as per customer requirements later. Location of this plug in module is designated with COM3 in HMI.

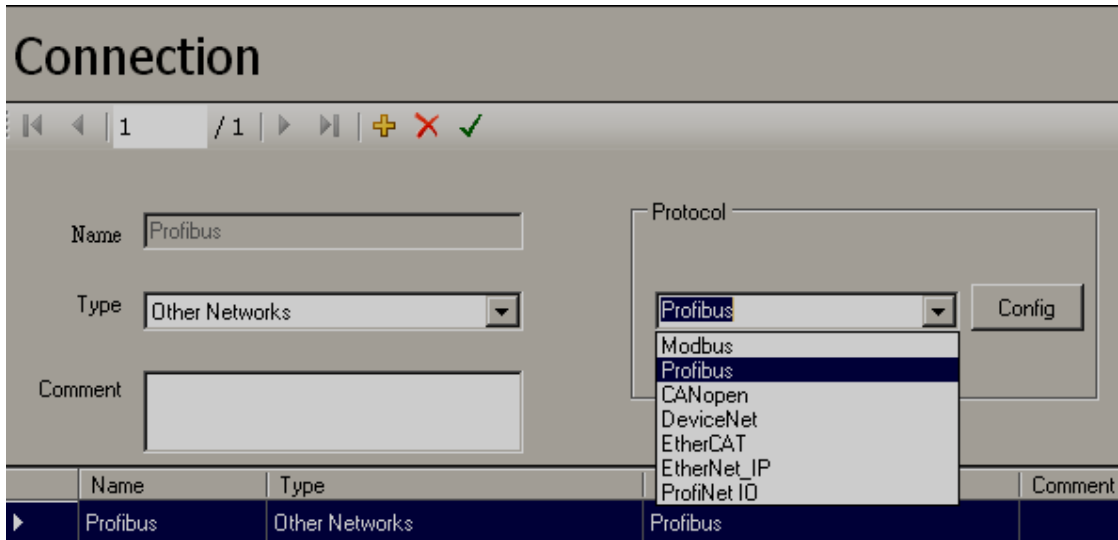

Note: Select Modbus from “Other networks” only for old projects using plug in Network option module for Modbus RTU Slave function. HMI editing software V1.10 onwards, Modbus RTU and TCP slave drivers added onboard using standard Serial & Ethernet ports, no special plug in module required

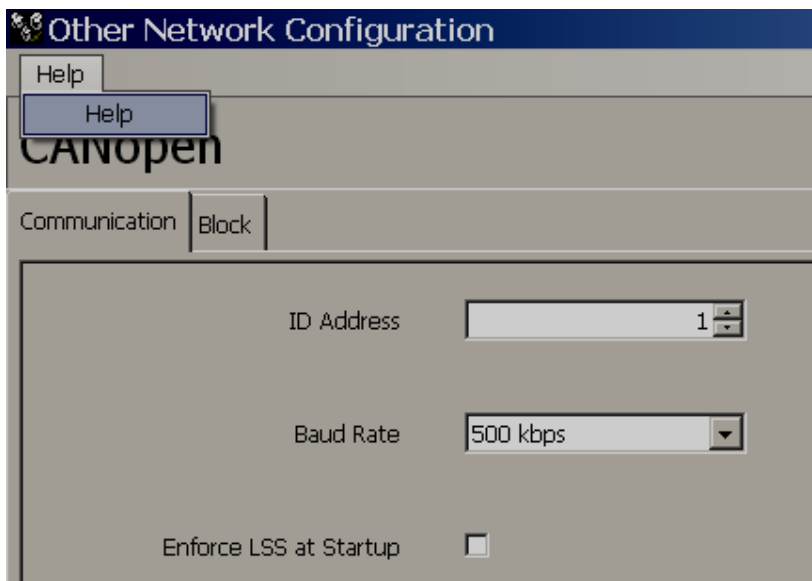

How to access help file for other networks.

Separate help files are available for each fieldbus network. Open the fieldbus configuration and then access help file from menu as shown attached from software itself

6.6.4.3 General

It is to support additional protocols. In HMI editing software, V1.1, Modbus Slave & Modbus TCP slave onboard drivers added. They can work from standard COM1/COM2 and Ethernet ports. In earlier versions, they are supported from Plug in option module only.

Note: Modbus RTU Slave can be used at only one of COM1 or COM2 ports

Name	Type	Parameter	Comment
ModbusSlave	General	ModbusSlave	

How to access help file for other networks.

Separate help files are available for each network. Open the configuration and then access help file from menu as shown attached from software itself

6.6.5 Scheduler

It is for scheduling jobs with respect to time period and real time clock.

Example: Every day morning 8.00 hrs, write a value to a tag.

Once in 30 sec, do some task say write a value to a tag or move to next page etc.

Scheduler

1 / 1

Type: Repeat Countdown
 Action: Enable
 Event: Function1();

Days: 0
 Hours: 0
 Minutes: 0
 Seconds: 10
 Millisecond: 0

No	Type	Action	Event	Days
1	Repeat Countdown	Enable	Function1();	0

Click on  to add one more schedules.

Click on  to delete selected schedules.



Click on  to save the modifications at scheduler other wise, the modifications may be not saved for the scheduler configuration. Alternatively click at any row in the scheduler to save the scheduler configurations after modification.

Type:

Countdown: Defines the interval of time, e.g. days, hours, minutes and seconds. (Not Real Time), execute task for only one time.

Repeated Countdown: Repeats the previous countdown. (Not Real Time), execute task cyclically.

Daily: The timer works in selected interval of Real Time, execute task once a day as per set time.

Weekly: The timer works in selected interval of Real Time, execute task once a week as per set time.

Monthly: The timer works in selected interval of Real Time, execute task once a month as per set time.

Action: Enables or Disables the timer.

Event: Configure the event.

Ex1: once in 30 sec, if Tag20 == 1, move current display page in HMI to next active page in run time.

Type: Repeated Countdown, Action=Enable, Second = 30,

Function1

```
if(Tag20 == 1)
{
ActivateNextPage();
}
```

Ex2: Every day at 8.00 hrs, write a value 1 to tag T11.

Type: Daily, Action=Enable, Hour=8,

Function2

Tag11=1;

6.6.6 Recipe

This is normally used to create a set of directions with a list of ingredients for making or preparing something, especially common in the food industry.

Examples: Preparation of Coffee

Recipe Name: Coffee

Recipe Elements: Milk, Sugar, Water



Recipe name and Recipe Elements should be created in Design time. Data Records can be added, deleted, modified and saved in either Design time or Run time.

Application

Create Recipe table in design time with various Recipe elements like Milk, Sugar and Water and then create Recipe data records (Set points). In Run time, these set points will be transferred from HMI to PLC by operator manually via Recipe Viewer or alternatively via Scheduler by using special function "WriteRecipetoTagByNumber".

Procedure to create Recipes

Design Time

1. Create Tags by name Milk, Sugar and Water first in PLC with different address and then create these tags in OPC server.

OPCABDF1	P1_D1_Tag1	UInt16	Always	1000	P1.D1.Tag1	This is for Sugar
OPCABDF1	P1_D1_Tag2	UInt16	Always	1000	P1.D1.Tag2	This is for Milk
OPCABDF1	P1_D1_Tag3	UInt16	Always	1000	P1.D1.Tag3	This is for Water

- In Project explorer, Select Recipe, Right click on Mouse and then click at “ADD”



- It adds new Recipe into the list. Select the Recip1 and then Right click on mouse, Click at Rename and enter Recipe Name like Coffee, Tea etc.

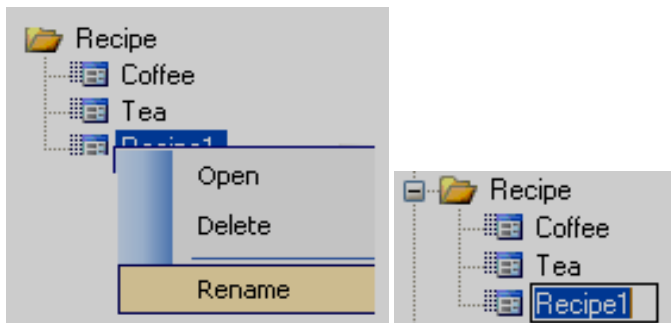

- Now double click on Recipe “Coffee” and then add Recipe Elements (ingredients) by selecting tags created earlier (Milk, Sugar and Water). Then, enter data records (Proportion or set point of various ingredients) for various batches as shown below.

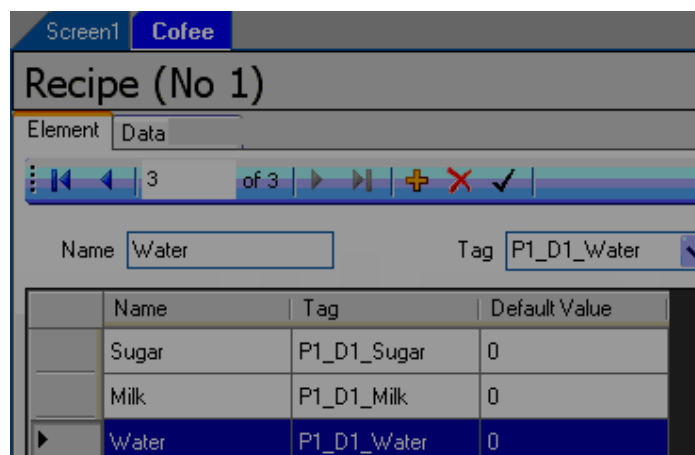

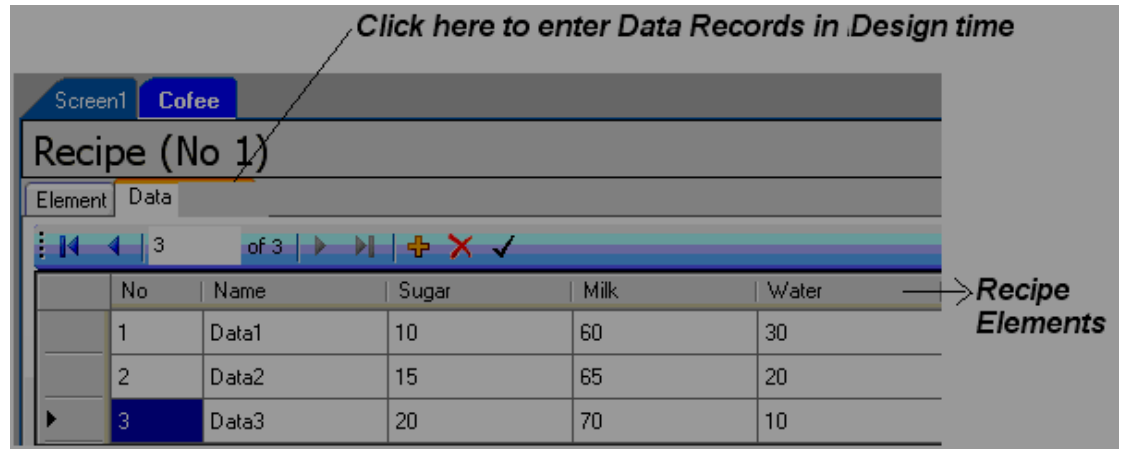

Transfer data records from HMI to PLC manually in Run Time

1. In Design time, Insert Recipe view from Basic Objects in HMI screen.

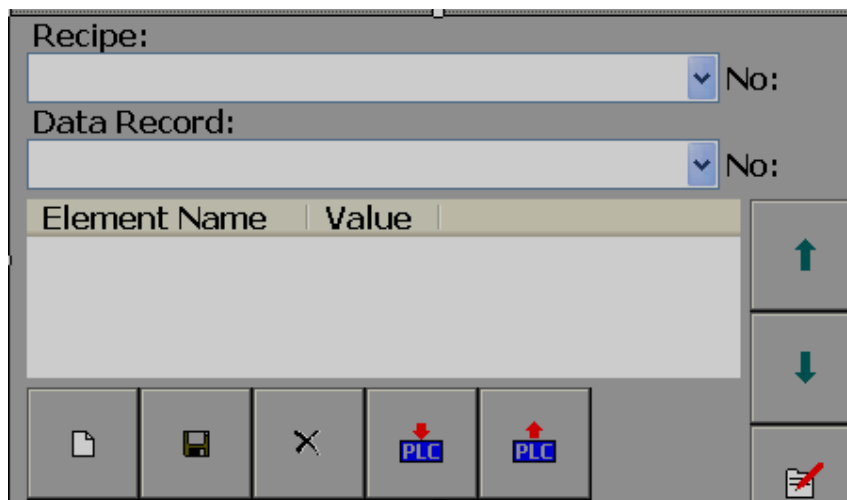

Select Recipe from the following Combo box

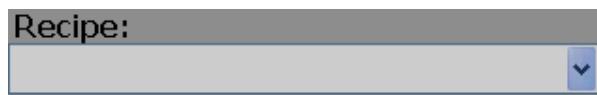

Select Data Record from the Data Record Combo box

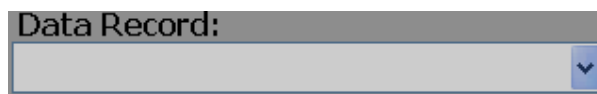



 This is to create new data Record by operator in Run Time.

 This is to Save manually entered data Record in HMI.

 This is to delete data Record from HMI.

 This is to send selected Data Record from HMI to PLC.

 This is to Receive Data Record from PLC to HMI and Update to current selected Data Record.

 This is to navigate from bottom to top of data Records after selecting Data Record from Combo box

 This is to navigate from Top to Bottom of data Records after selecting Data Record from Combo box.

 This is to enter value to Data record manually.

2. In Run time, select the Recipe and Data Record and send data record from HMI to PLC if required by pressing  button.

How to add new data Record manually by operator in Run Time via Recipe Viewer

1. Press at  button.

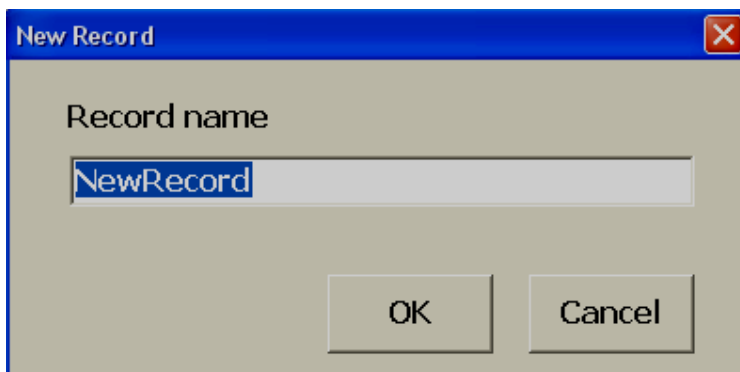

The screenshot shows a dialog box titled "New Record" with a close button in the top right corner. Inside the dialog, there is a label "Record name" above a text input field. The input field contains the text "NewRecord". At the bottom of the dialog, there are two buttons: "OK" and "Cancel".

2. Enter name for the new Data Record and press "OK"

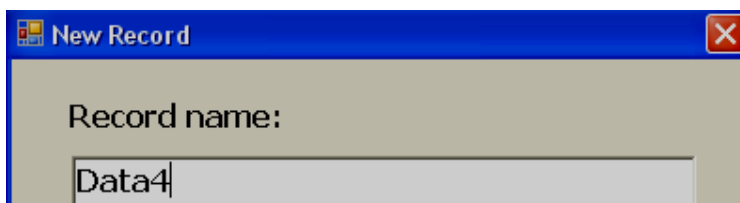

The screenshot shows the same "New Record" dialog box. The text input field now contains "Data4". The "OK" and "Cancel" buttons are still present at the bottom.





3. Select Data4 from Data Record in Recipe Viewer.

4. Use Up and Down arrows and navigate to Recipe element like Sugar and then press

 to enter data

Recipe:
Cofee No: 1
Data Record:
Data4 No: 4

Element Name	Value	
Sugar	0	↑
Milk	0	↓
Water	0	

Input





Sugar

25

OK

Recipe:
Cofee No: 1
Data Record:
Data4 No: 4

Element Name	Value	
Sugar	25	↑
Milk	0	↓
Water	0	

    

5. Similarly enter data for other Recipe elements and then press on  Save button other wise, these new added data records are only valid for the current session.



Data Records added are valid for current session only in PC. If Online/Offline simulation is run again, design time data records will only appear. However, in HMI, if operator presses on  “Save” button, the data records will be stored in Recipe data base permanently and can retain after power supply recycle.

How to Delete data Record manually by operator in Run Time via Recipe Viewer

1. Select Recipe and Data Record in Recipe Viewer.
2. Click on delete  button and following dialog will be prompted asking the data should record to be deleted.

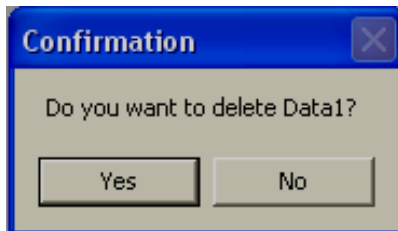

3. Click on “Yes” if you would like to delete data record.



Data Records will be deleted only from current session in PC. If Online/Offline simulation is run again, design time data records will appear again.



In HMI, it works in two ways. If you delete data records, it will delete only from current session. If you want to delete them permanently from Recipe data base in HMI, press “Save” button. Other wise, when you switch off the power to HMI and switch On power again, design time data records will appear again.

Application: Transfer 10 data records from HMI to PLC automatically in Run Time once in 10 minutes after operator press start button

1. Create internal memory tag say Tag1 with Int16 type.
2. Increase value of Tag1 by 1 once in 10 minutes using function “Add value to Tag” in Scheduler.

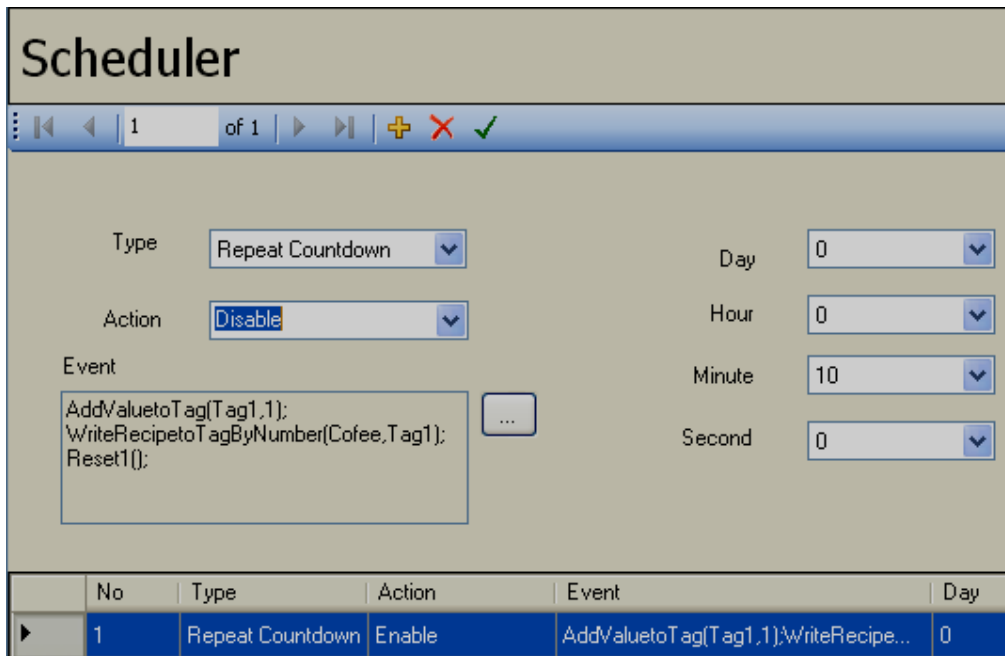

3. Select the Recipe and Data record number to be written from HMI to PLC by using function "WriteRecipeToTagByNumber(Coffee, Tag1)"
4. If Tag1 value is more than 10, it needs to reset Data Record pointer to 1 and you can do this writing conditional statement in scripts as shown below. You can call this function in scheduler itself, Function name: Reset1[] .

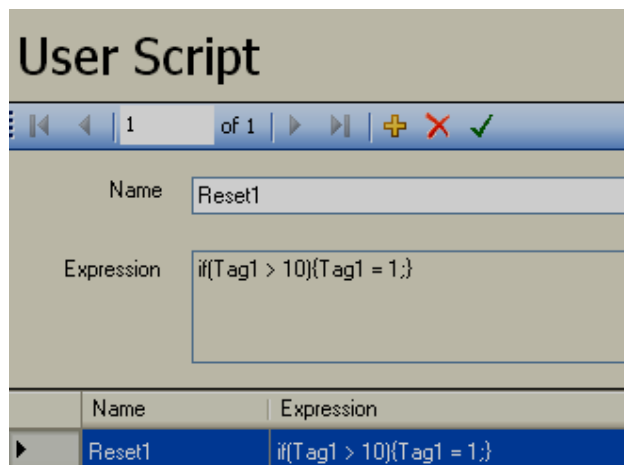

5. Use two buttons in any screen to control scheduler start/stop to begin transfer of Recipe data Records from HMI to PLC as per predefined set intervals.

6.6.7 Event & Alarm

The Event is frequently used for Alarm purpose. Event can be set for any Tag (Analog or Digital).

Alarm Event

User System

1 / 4

Tag: Tag1

Group: 1

Setpoint Mode: Constant

Value: 10

Decimal: 0

Hysteresis: 0

Type: LoLo

Message: TK101 Low Low level

Log: Alarm

Event: []

Print: Disable

No	Tag	Type	Log	Setpoint	Group	Event	Hysteresis	Message	Print
1	Tag1	LoLo	Alarm	10	1		0	TK101 Low Low level	Disable
2	Tag1	Lo	Alarm	20	1		0	TK101 Low Level	Disable
3	Tag1	Hi	Alarm	80	1		0	TK101 high level	Disable
4	Tag1	HiHi	Alarm	90	1		0	TK101 high high level	Disable

Click on  to add one more schedule.

Click on  to delete selected schedule.



Click on  to save the modifications at Scheduler otherwise, the modifications may be not saved for the Scheduler configuration. Alternatively click at any row in the Scheduler to save the Scheduler configurations after modification.

Tag: Select the Tag to set Events/Alarm.

Set point: To set up trigger set point for actuating selected Job

Type: Constant or Tag or bitwise.

Constant: Fixed set point value, ex: 80, Select Constant for Type and enter 80 at Value.

Tag: Tag can be selected as source for Trigger set point.

Ex: Tag1. Tag1 may contain some value say 80 which the operator can enter trigger set point for Alarm in run time.

Bit wise: it is to define alarm/event bit wise for the Analog type tag. For example: If alarm program logic is developed in PLC, then, send Analog type tag from PLC to HMI and in HMI, configure alarms for specific bits in Analog tag.

Ex: Tag1, INt32 type, contains status of 32 alarms in one Analog tag.

If Bit0 is Low, it is possible to generate alarm, Select Bit wise = 0, Type = Lo
 If Bit0 is High, it is possible to generate alarm, Select Bit wise = 1, Type = Hi

Similarly, it is possible to generate alarms for any bits 0 to 31 for analog tag.

Type: There are various types of H, L, HH, LL, dev+, dev-, Error or disable to be selected for job or

Alarm purpose

H: High limit. When the process is over high limit, the alarm or job is actuated.

Ex: High set point = 80. When process value is more than 80, it triggers alarm.

L: Low limit. Any the process is lower than low limit, the alarm or job is actuated.

Ex: Low set point = 20. When process value is less than 20, it triggers alarm.

HH: High high limit, to set up another limit higher than high limit for double warning.

Ex: High high set point = 90. When process value is more than 90, it triggers alarm.

LL: Low low limit, to set up another limit lower than low limit for double warning.

Ex: Low low set point = 10. When process value is less than 10, it triggers alarm.

Dev+: Trigger event on positive deviation of process value. The job or alarm is actuated when process value is deviated by greater than (set point) earlier process value.

For ex: Set point, Type: Constant, Value: 10

At 10.00.01, Tag1=40

At 10.00.02, Tag1 = 51

Then, job or alarm is activated.

Dev-: Trigger event on negative deviation of process value .The job or alarm is actuated when process value is deviated by less than (set point) earlier process value.

For ex: Set point, Type: Constant, Value: 10

At 10.00.01, Tag1=40

At 10.00.02, Tag1 = 29

Then, job or alarm is activated.

Disable: Select if Event/Alarm is not required for the tag at this time.

Log: It is to define type of Log required when an event occurs. Various options are available as follows.

None: Do nothing

Log Alarm (Auto ack.): Record alarms and acknowledge automatically.

Log Alarm: Record alarms. It requires acknowledgement.

Log Event: Record events, events do not require acknowledgement.

Print: It Enable this if you wish to print Real time alarms from HMI using network serial printer

Group: It is to group alarms for acknowledgement, dump, clear and navigation in Alarm box in Run time. 0 to 9 groups can be selected for any Alarm/Event.

For example: There are 100 tags. Tag1 to Tag50 belongs to section 1 of process plant. Tag 51 to Tag100 belongs to section 2 of process plant. Now, it is possible to acknowledge alarms for section 1 and section 2 of process plant separately via different soft keys.

Decimal: Select between 0 to 5

Hysteresis: To avoid alarm been activated too often, it can be set for no reaction. Hysteresis value can be defined for the event trigger set point.

Message: Message to appear in Alarm box in Run time on triggering of specific Alarm/event.

6.6.8 Data Logging

It is to configure data logging of tags to archive them later via Historical trend box object in Run time. All data stored in HMI internal memory/SD card can be dumped to USB flash disk and then use "Historical viewer" software to archive data in PC. It is also possible to transfer historical data from HMI to PC via Ethernet

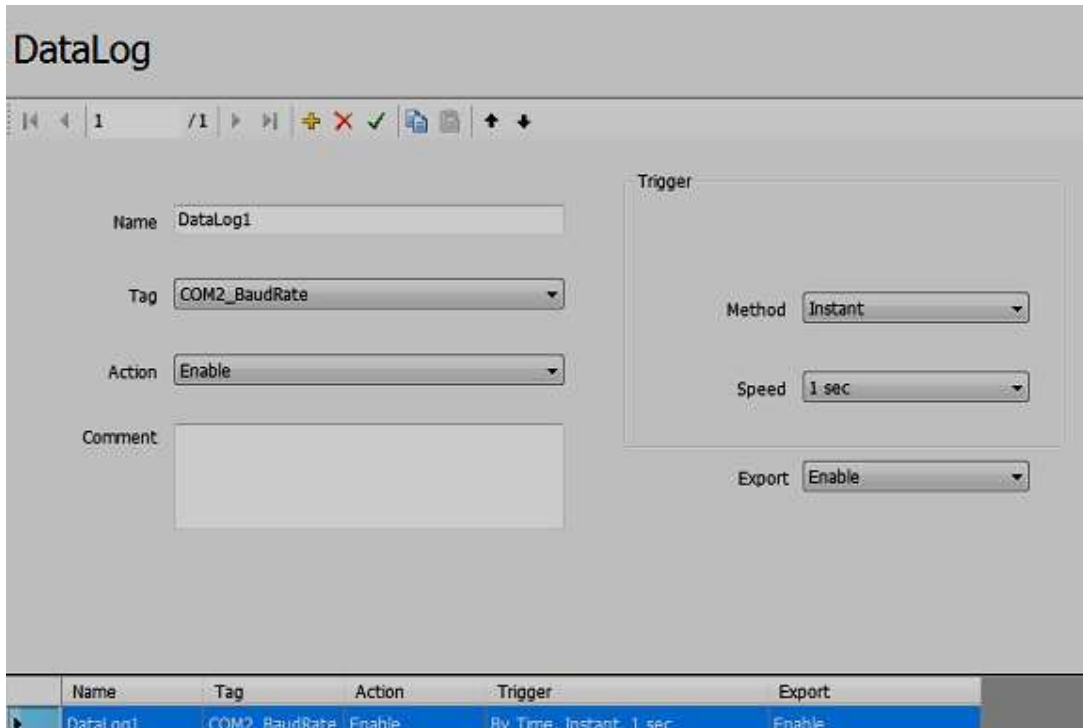

Name: Data log name.

Tag: Select the Tag to configure data logging.

Action: Enable or disable above tag for data logging.

Type: By Timer.

By Timer: As per Log Method and Log Speed

Method: This is method of logging measured data. Choose the Log method of Instant, Average, Minimum or Maximum data.

Instant: logging in the last measured data at the sampling interval.

Average: logging in averaged measured data at the sampling interval.

Minimum: logging in minimum measured data at the sampling interval.

Maximum: logging in maximum measured data at the sampling interval.

Log Speed: It is the data logging speed of measured data. Choose one of the following 100 msec., 1 sec, 2 sec, 5 sec, 10 sec, 20 sec, 30 sec, 1 min, 5 min and 10 min

Export: Enable this if you wish to export historical data to CSV files into USB disk and print historical data from Printer

6.6.9 User Script

It is possible to write scripts using C language and run them in HMI.

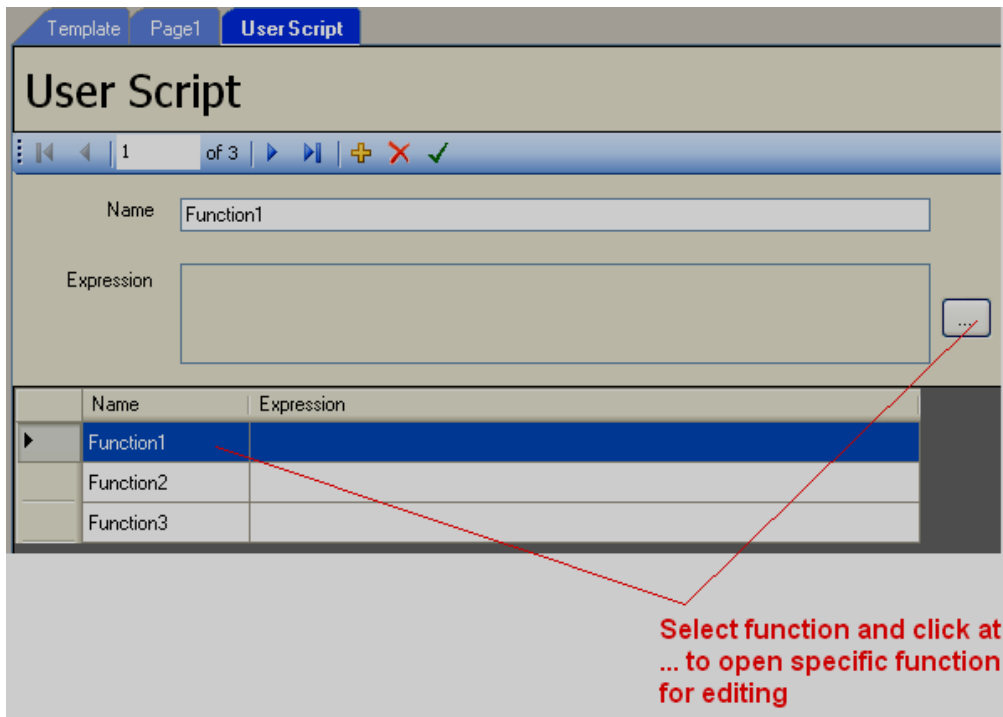

Click on  to add one more user script.

Click on  to delete selected user script.

Click on  to save content written in script or alternatively click on any other row then, it saves recently opened script content automatically.

If content in script is saved, then, it appears in expression box and also at the row.

There are many kinds of functions available as follows.

System functions: Predefined system functions like start scheduler, Stop scheduler etc.

Refer section "Function editor" for more detailed information about system functions.

Math functions: Trigonometric, Log, Exp, Round, Power etc.

Arithmetic functions: Addition, Subtraction, Multiply, Division, Remainder

Logical functions: And, Or, True, False, Not etc.

Shift functions: left, Right

Relational functions: "=", "!=", ">", "<", "<=", ">="

Assignment functions: "="

Selection functions: If, Else

Iteration functions: While, For

Jump functions: Break, Continue

User tag: User tag list to use in script

System tags: RTC data, Trigger 100 msec, trigger 1 sec, number of real time alarms etc.

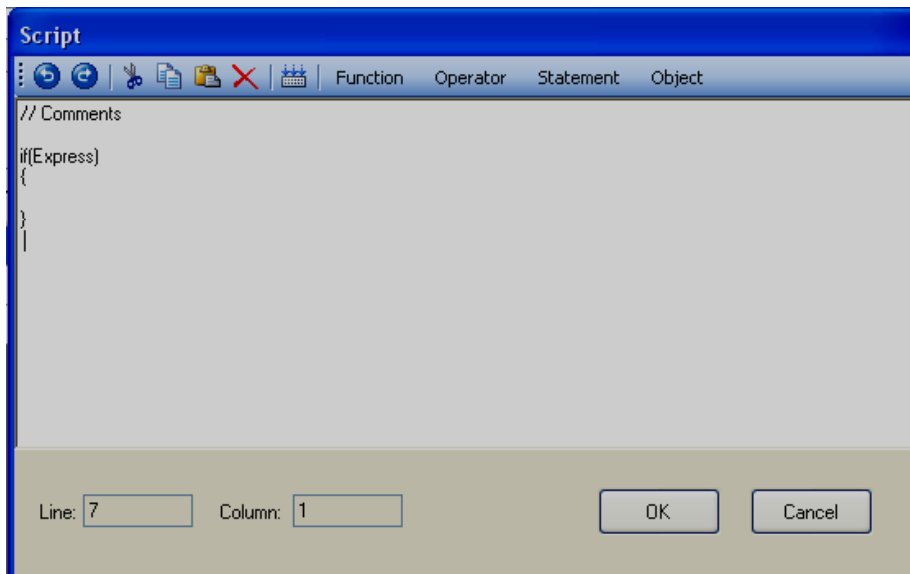

Refer chapter by name “**SCRIPTS**” for detail information about scripts.

6.6.10 Security

Screen1 Security

Security

User Runtime

User ID: User1

Password:

Security Level: 1

9 The highest level, 1 The lowest level, 0 Logout

	User ID	Password	Security Level
	Administrator		9
▶	User1		1

Click on  to add one more user.

Click on  to delete selected user.



Click on  to save the modifications at users other wise, the modifications may be not saved for the user configuration. Alternatively click at any row in the users to save the user configurations after modification.

User ID: Name of User

Password: Password for the user to access

Security Level: 0 to 9 levels supported

9 is highest authority

1 is lowest authority

Application

If page navigation button has authorize level 5, then level 5 to 9 are authorized to operate these buttons, where as level 1 to 4 are not authorized to operate these buttons. If level 1 to 4 attempts to use buttons set for higher level, then, the following error message will be prompted.

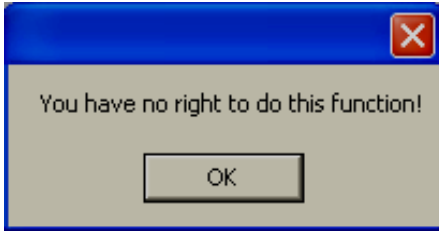

In case if it is required to modify authorization level for the user or modify authorization level for component to be used Example: Button, then, it can be done in two ways.

- a) If user view is being used in HMI screen, then log in with higher authority than user level and change authority in Run time.
- b) In design time, modify the application and download application again to HMI.

Security control button (Log in and Log out) are normally kept at Page 1 during design time and they will be prompted in HMI at Run time.

Design time

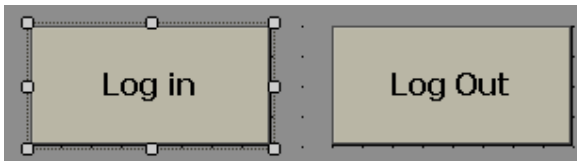

In Design time, place two buttons and set Function Login and Logout.

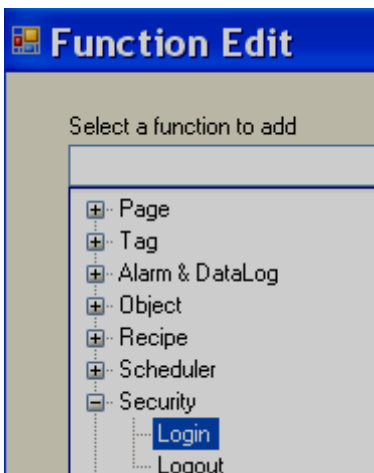

Then, for page navigation buttons in Template or other screens, set authorization level in design time properly.

HMI Run Time

When user attempts to Log in at first time in run time, proceed as follows

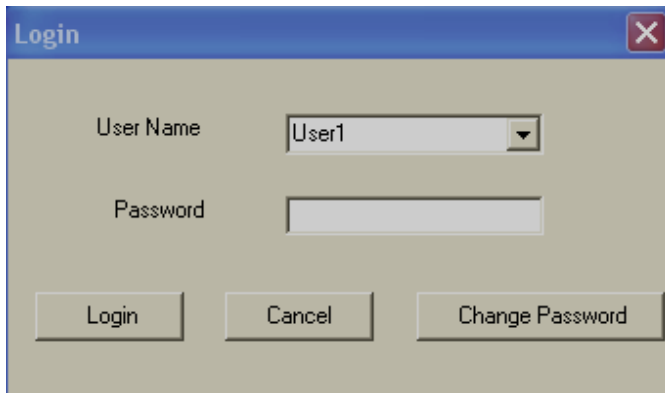

A dialog box titled "Login" with a close button (X) in the top right corner. It contains two input fields: "User Name" with a dropdown menu showing "User1" and a "Password" field. Below the fields are three buttons: "Login", "Cancel", and "Change Password".

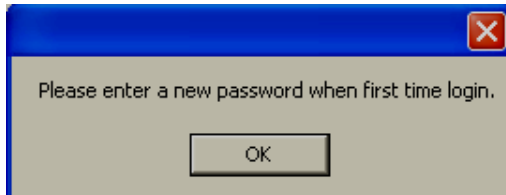

A message dialog box with a close button (X) in the top right corner. The text inside reads "Please enter a new password when first time login." Below the text is an "OK" button.



A dialog box titled "Change Password" with a close button (X) in the top right corner. It contains three input fields: "Password", "New Password", and "Confirm New Password". Below the fields are two buttons: "OK" and "Cancel".

Enter password and press at "OK" button.

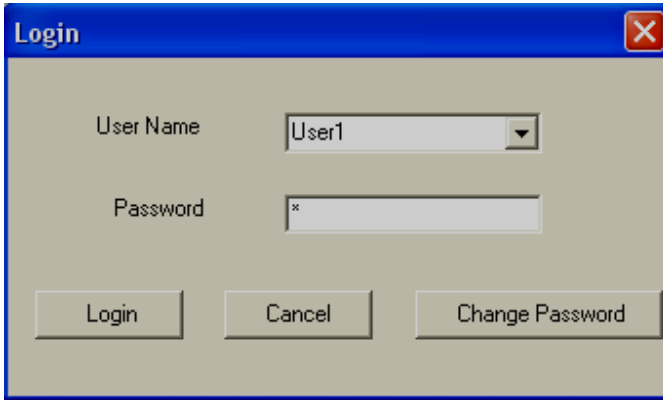

Enter password and press at “Login” button.

If user with lower level than set authorization level attempts to use components in real time, then, the following error message will be prompted.

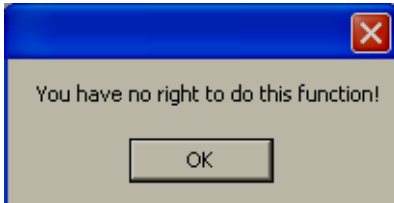

During Online/Offline simulation, if new users are added and passwords are created for any users, these are valid for current session only and this information is not saved in PC. If you build project and run Online/Offline simulation, then, design time user names will appear again in PC.



If user names are added and passwords are created in HMI, this information will be saved in HMI. If you switch Off power supply to HMI and switch on Power supply again, the earlier entered user names and passwords are retained. However, if user downloads project again from PC to HMI, user names and passwords will be erased in HMI. Design time user names will appear in HMI and users should create user name and passwords again as per their requirements.



Please refer section “User view” in basic objects. User view is component available to use for security control directly in Run time. Example: Add new user, delete user, change security level etc.

Security-Run time

The screenshot shows a web-based configuration interface for 'Security'. At the top, there is a header 'Security' and two tabs: 'User' and 'Runtime', with 'Runtime' being the active tab. Below the tabs, there are two input fields: 'Logout time : 30 minutes' and 'Password valid for number of days 0'. Below these, there is a section titled 'Security level of program' which contains a dropdown menu labeled 'Historical' with the value '0' selected. Below the dropdown, the text '0 Unlimited time' is visible.

Logout time: Define time in minutes for Log out. In case if there is inactivity, current user will be log out after this time

Password validity: Define the number of days for password validity. After this time, user needs to enter password again

Historical : Define the security level to use at Historical viewer.

For example: If level 5 is selected here in design time, then, if you wish to archive/create project using historical data in PC using Historical viewer software, user must log in at security level equal to or greater than 5 in Historical viewer software

6.6.11 Language

It is to select different language for the end user.

For example: End user is in Russia and application engineer wishes to display Russian fonts in HMI screens.

Procedure:

First setup the PC for the required language text entry. In case of Windows XP OS, open control panel, click on Regional options, Click on Regional and Language options and select Languages and click on "Details". Click on "Add", select required language and then follow on screen instructions to add Russian language as shown below.



In HMI editing software, Project explorer, Click on “Language” and it show Language table with “English” column. At this time for language pointer, 1 = English since it is first column.

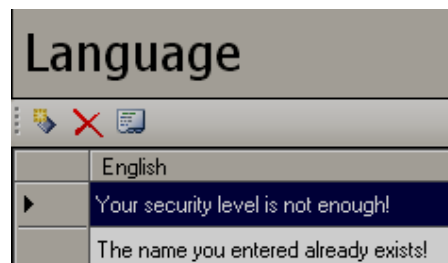
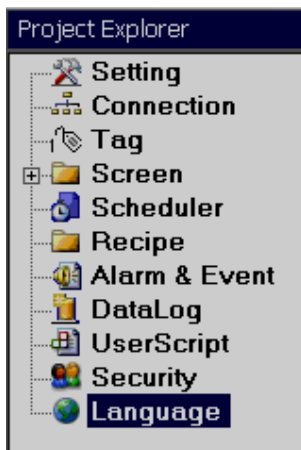

 To add new Language.

 To delete existing language.

Click on  icon to add another new language and, select Language name.

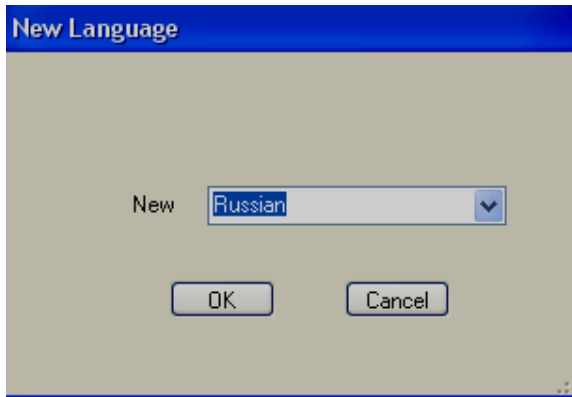

Now, another column “Russian” will be created.
 At this time, for language pointer, 0= English, 1=Russian .

Language	
English	Russian
▶ Your security level is not enough!	Уровень безопасности не дост...
The name you entered already ...	Введенное имя уже существует!
It's not a valid value!	Это не является допустимым з...
Do you want to save changes fo...	Сохранить изменения в текуще...
Do you want to delete this reco...	Удалить эту запись?
Name cannot be empty!	Необходимо ввести имя!
Name conflicted!	Конфликт имен!
First user cannot be removed!	Первый пользователь не може...

Now, in PC, select Russian from language bar available at bottom area of screen (Task bar) to key in “Russian” text from keyboard

Now, in language table, double click on empty rows under “Russian” column and enter “Russian” text equivalent to “English” texts. After completing “Russian” text entry, select “English” from language bar at Task bar.

	English	Russian
	Last Page	Последняя страница
	First Page	Первая страница
	Next Page	Следующая
	Previous Page	Предыдущая страница
	Label2	
	Title	

In Screen1, insert “Language Selector” and combo box will appear as shown.

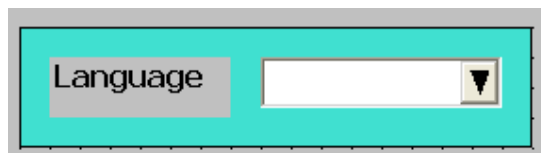

LanguageSelector1's Properties

General Common Events

Appearance

BackColor ForeColor

ButtonWidth
20

TextFont

Name: Tahoma (dropdown)
Size: 12 (text box)

Style: Bold (dropdown)

TagBinding

TagBinding (dropdown)

It shows list of languages configured for display of end user. Generally language selector if used in project is placed in screen1 for convenience to end user/operators. All the languages entered from project explorer will be displayed here.

Run time behavior

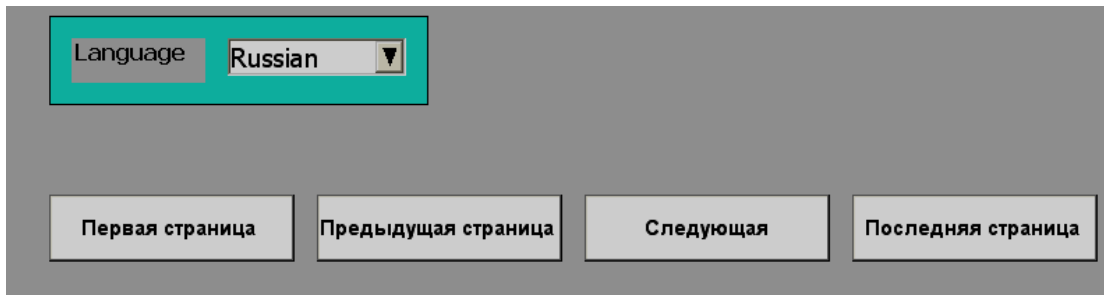
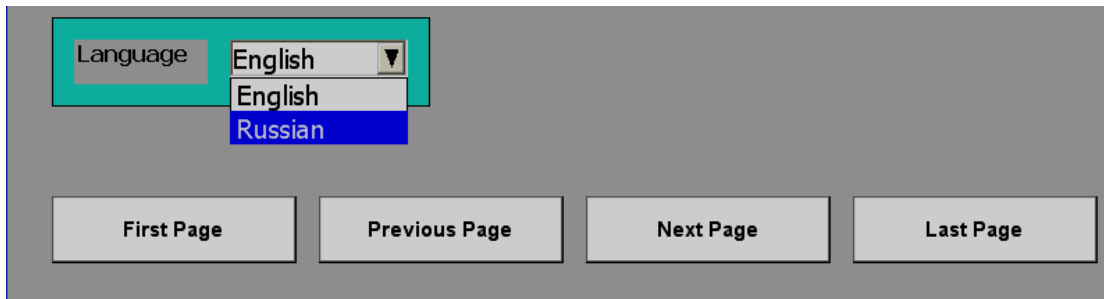

6.7 Tool box

These can be accessed from menu bar also from objects.

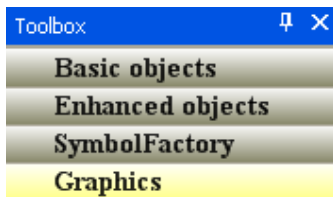

6.7.1 Basic Objects

It is to draw simple shapes in the screen, data entry, data display, alarms view etc.

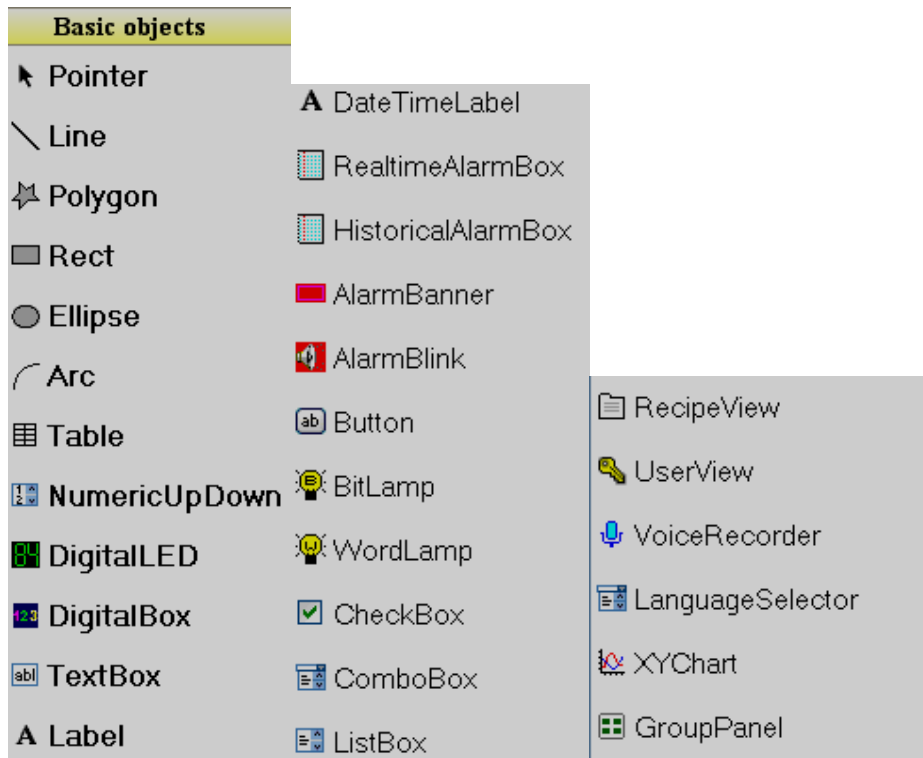

There are three ways to insert above objects into screen.

- i) Drag and drop.
- ii) Select the object say line first and then use mouse to draw a line in screen.
- iii) Select the object say line, then double click (mouse left click) quickly by keeping pointer on selected line. Then, line will appear in screen. For example, select line and Double click it 3 times by keep mouse pointer on line, you can see 3 lines appeared in screen.

After inserting object to screen, it is possible to edit properties either by Graphical User Interface (GUI) dialog or editing properties directly in property grid.

How to edit via GUI dialog

Insert any object in screen. Select the object, right click the mouse and then select properties.

Or

Insert any object in screen. Double click on Object and then GUI dialog will open automatically.

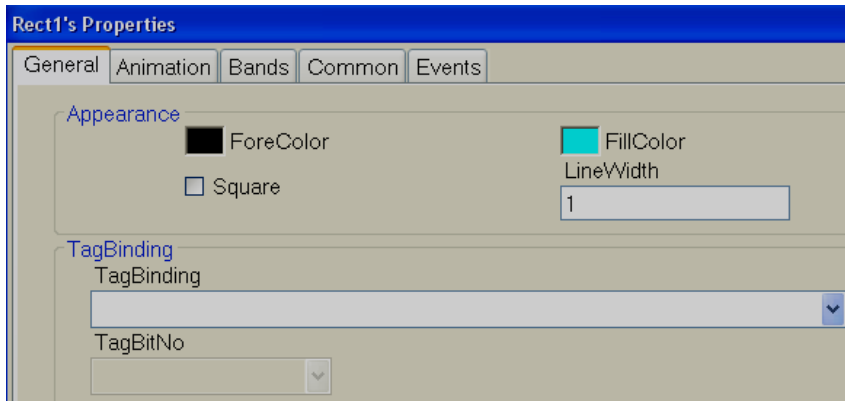

How to edit via Property grid

By default, property grid will appear at Right-Bottom area of screen editor. If not available, in Menu, click on "View" and then click at "Reset Window Layout", then, property grid will appear at bottom right side of the screen editor just below the Project Explorer.

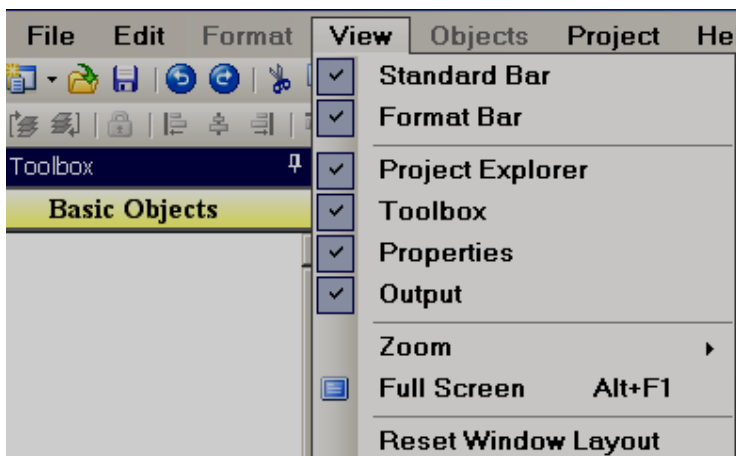

Property grid

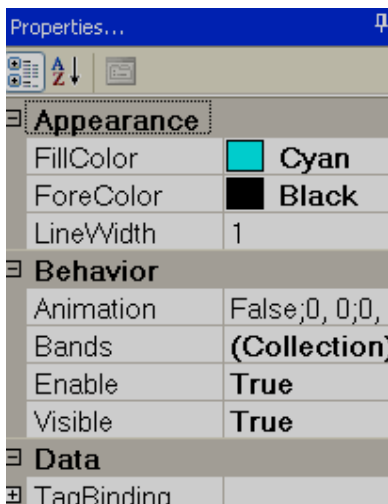



Before placing any objects in screens, check section File- Environment and set default font size, fill color, fore color and back color for the objects as shown.

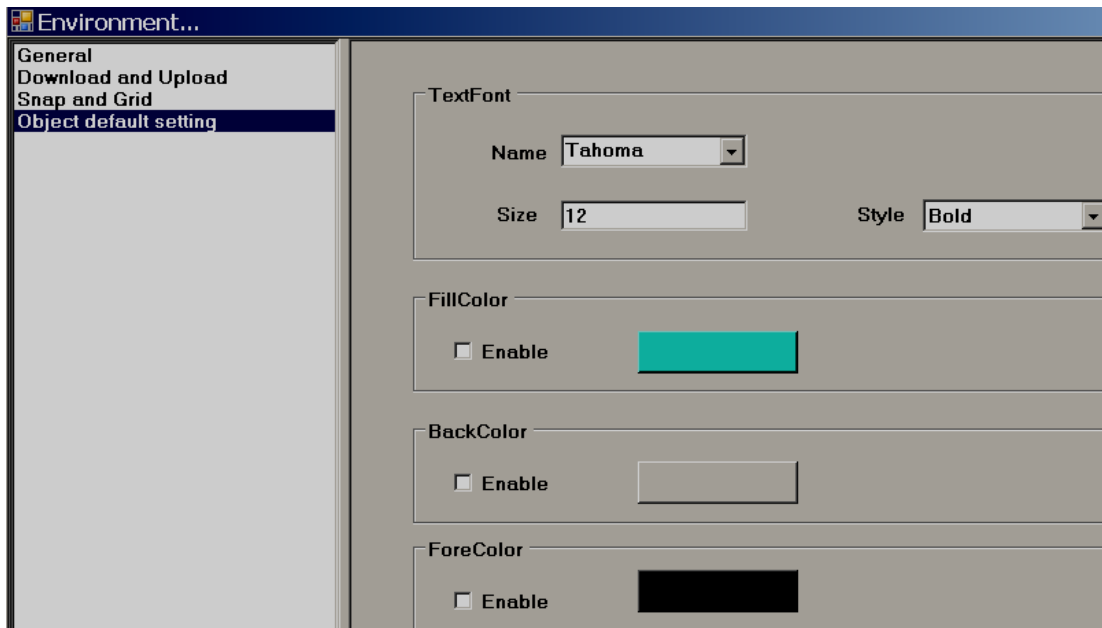

6.7.1.1 Common Properties

Appearance

Back Color: Set background color of the component.

Fore Color: Set Fore color of the component.

Bevel: It is to set border including inner border, outer border and style of border.

Inner Border: True/False

Outer Border: True/False

Style: 9 styles are available

None, Flat, Single, Double, Raised, Lowered, Double Raised, Double Lowered, Frame Raised, Frame Lowered

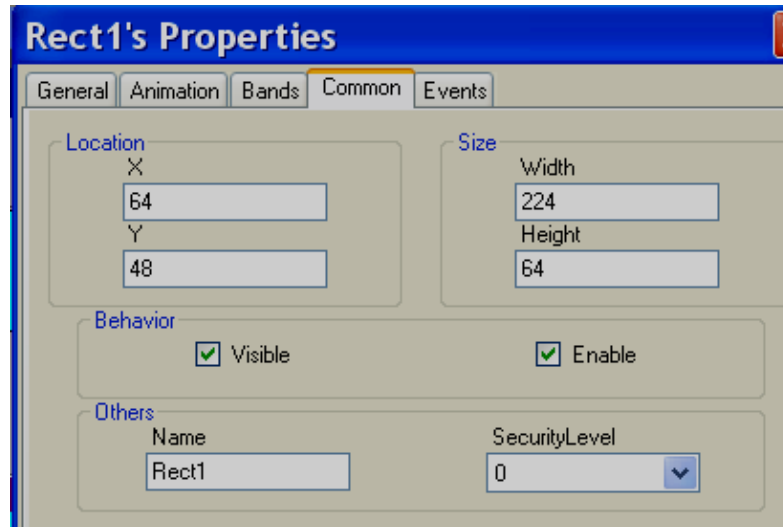

Behavior

Visible: True/False, determine whether component/control is visible or hidden

Enable: This is for event control. If linked with Digital tag, if tag value =1 in run time, then, events configured for the object will be executed. If tag value = 0, then, events will be not executed

Data

Tag Binding: Select the Tag of process value

Write design time value: If selected, it writes value available at "Text" in design time and also in run time replacing default value defined at Tag data base.

Design

Name: It is name of the component.

Security level: Define security level for the component.

Locked: True/False: It is to Move or Resize the component.

Layout

Dock: Defines which borders of the control are bound to the container.

Location: The coordinates of the upper-left corner of the component relative to upper-left corner of the container. Set X and Y position in screen in pixels.

Size: Size of the component in pixel. Set height and width of component in pixels.

↖ **Pointer:** It is to deselect the tool selection.

6.7.1.2 Line

✍ **Line:** It is an object used to draw line and do animation in Run time linking with Tag.

User can edit properties via GUI dialog or property grid as per convenience. After drag/drop of object to screen, double click on object to open GUI dialog or select the object and directly enter properties via property grid available at bottom right corner of screen editor.

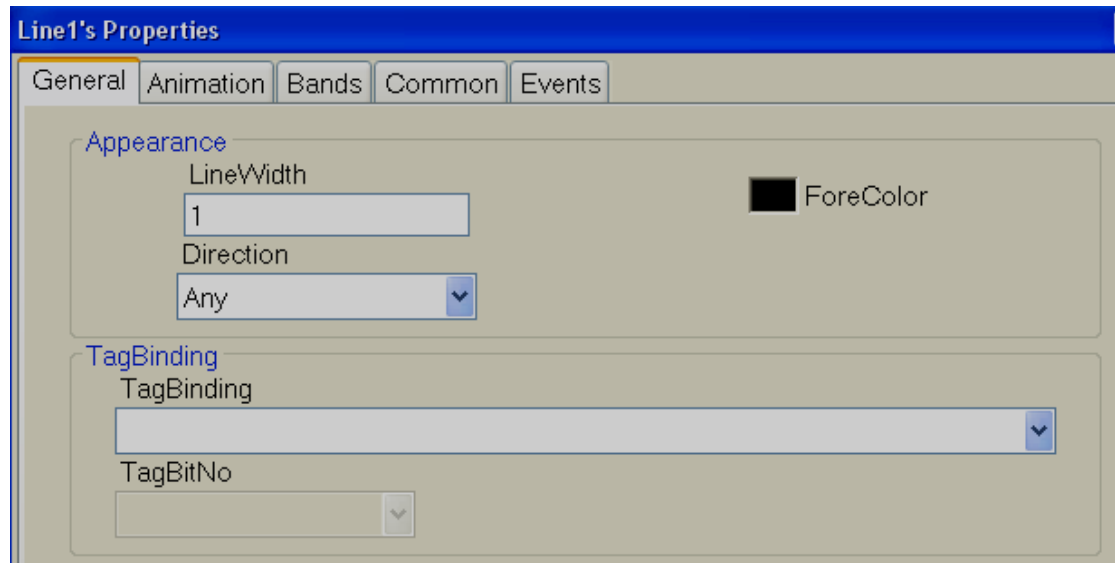

General

Appearance

Line Width: Define Line width

Direction: Horizontal or Vertical

Tag Binding

Select Tag to be linked with this line. This is useful if animation is required to be done on the line.

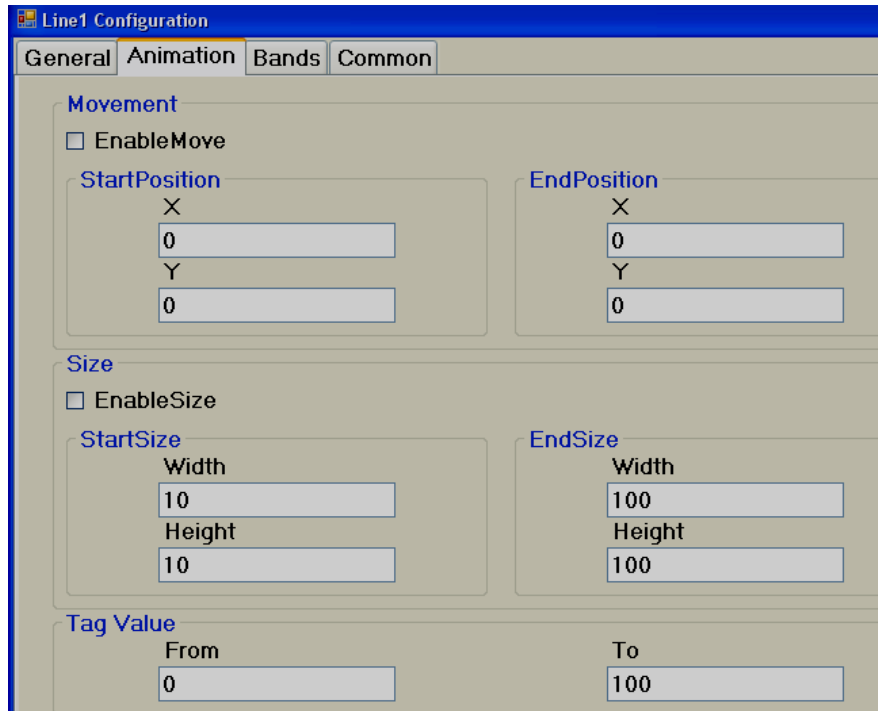

Animation

This is to do animation on line in Run Time

Movement

Select Enable Move check box if movement animation is required in Run time.

Start Position: Define X and Y coordinate for start position when tag value is minimum in Run Time.

End Position: Define X and Y coordinate for end position when tag value is max. Run time.

Where X position indicates movement from Left side to Right side which is Horizontal movement and Y position indicates movement from Top side to Bottom side which is Vertical movement.

For ex: HMI 7" (HIGH PERFORMANCE) project,
800 X 480 pixels,
Normal installation, Horizontal (Left to Right) = 800 pixels,
Vertical (Top to Bottom) = 480 pixels

Enable move: Selected
Start position X = 0, Y = 0
End position X = 800, Y = 0
Tag Value, From = 0, Tag Value To = 100

Now, in Run time, when Tag value = 0, then line will be at Top left and when Tag value = 100, position of line will be Top Right

Size

Select Enable Size check box to enlarge/decrease size of component in Run time.

Start Size: Define X and Y coordinate for start size when tag value is minimum in Run time.

End size: Define X and Y coordinate for end size when tag value is max. Run time.

Tag Value

Select Tag to be linked with this line. This is useful if animation is required to be done on the line.

Bands

This is to select various bands as part of animation in Run Time

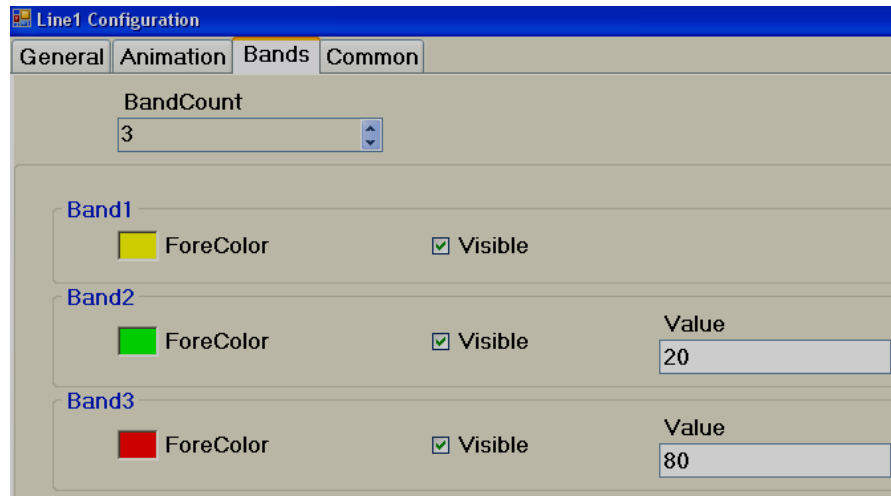

Band Count

Maximum 32 bands are available.

For ex: In above sample,
If Tag value is between 0 to 20, line will be in Yellow color
If Tag value is 21 to 80, then, line color = Green
If Tag value in Run time is above 80, line color = RED

6.7.1.3 Polygon

★ **Polygon:** It is to draw a polygon. After finishing drawing, double click using mouse (left) to complete the Polygon. It is also possible to link polygon to a tag and define user friendly animation to appear in Run time.

The screenshot shows the 'Polygon1's Properties' dialog box with the 'General' tab selected. The 'Appearance' section includes a 'ForeColor' color swatch (black), a 'FillColor' color swatch (cyan), and a 'LineWidth' text box containing the value '1'. The 'TagBinding' section contains a 'TagBinding' dropdown menu and a 'TagBitNo' dropdown menu.

The screenshot shows the 'Polygon1's Properties' dialog box with the 'Points' tab selected. It displays three points with their respective X and Y coordinates:

Point	X	Y
Point1	5	111
Point2	15	112
Point3	70	125

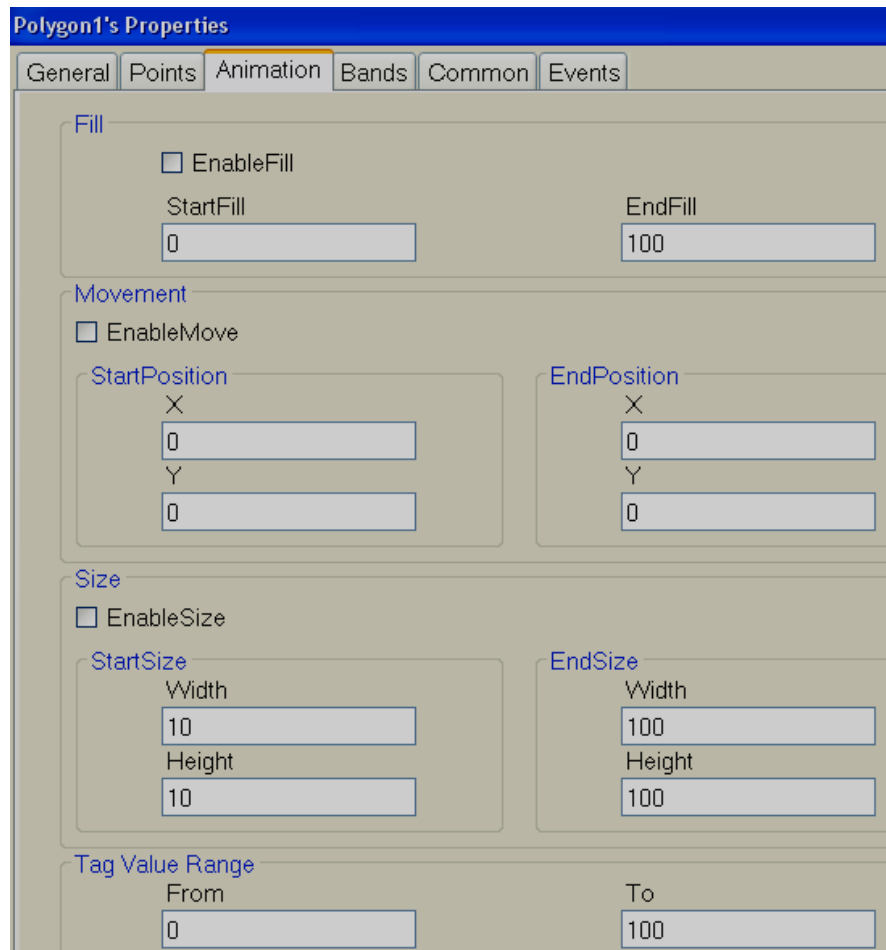

Animation

This is to do animation on Polygon in Run Time

Fill

Select Enable Fill if filling animation is required on Polygon object in Run time. When tag value changes in Run time, it appears filling with defined color inside Polygon object. It is like a bar graph but filling is with in polygon shape defined during design time.

Start Fill: Define Start value for Fill

End Fill: Define End value for Fill

Movement

It is to define movement position and it is the same as explained for Line object earlier.

Size

It is to define Size enlarge/decrease and it is the same as explained for Line object earlier.

Tag Value

Select Tag to be linked with Polygon object. This is useful if animation is required to be done on the Polygon.

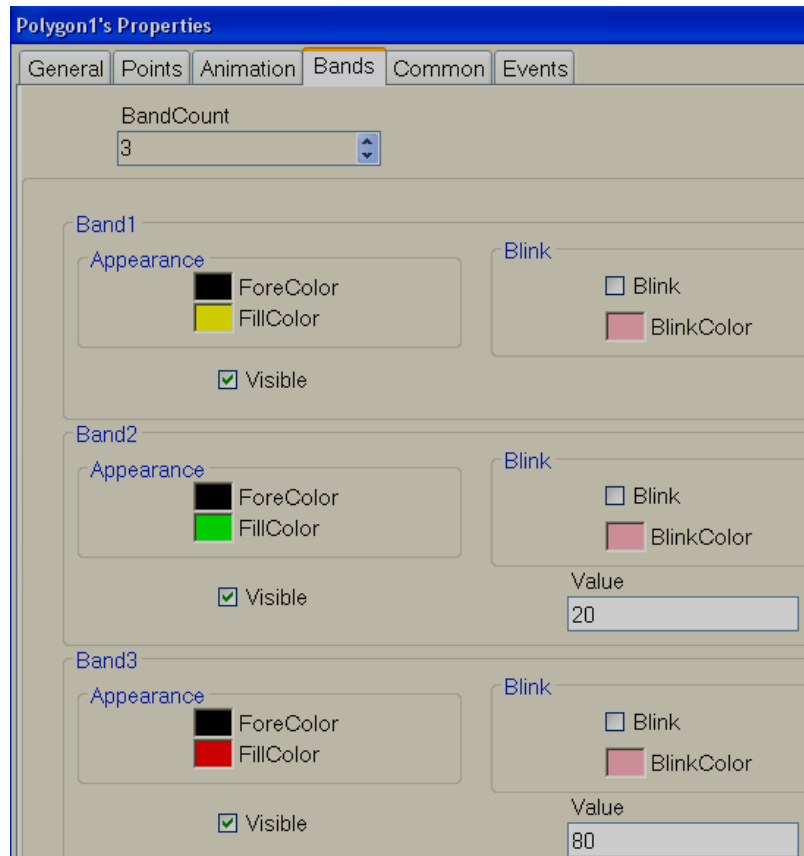

Band editor: Maximum 32 bands are available.

For example: In above sample,
If Tag value is between 0 to 20, Polygon fill color = Yellow
If Tag value is 21 to 80, then, Polygon fill color = Green
If Tag value in Run time is above 80, Polygon fill color = RED

If required, it is also possible to configure blink property and set blink color in any band.

6.7.1.4 Rectangle

▣ **Rectangle**: It is to draw a Rectangle and do animation in Run time linking with Tag.

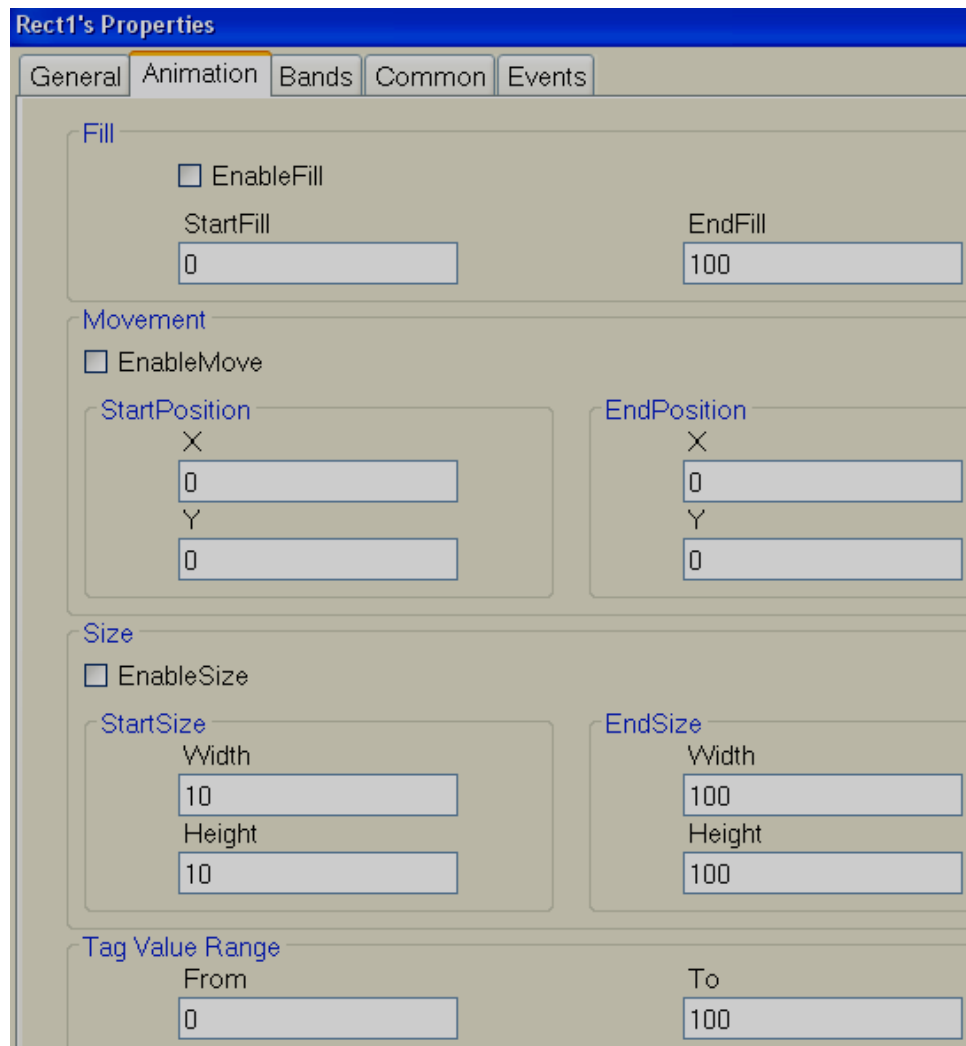
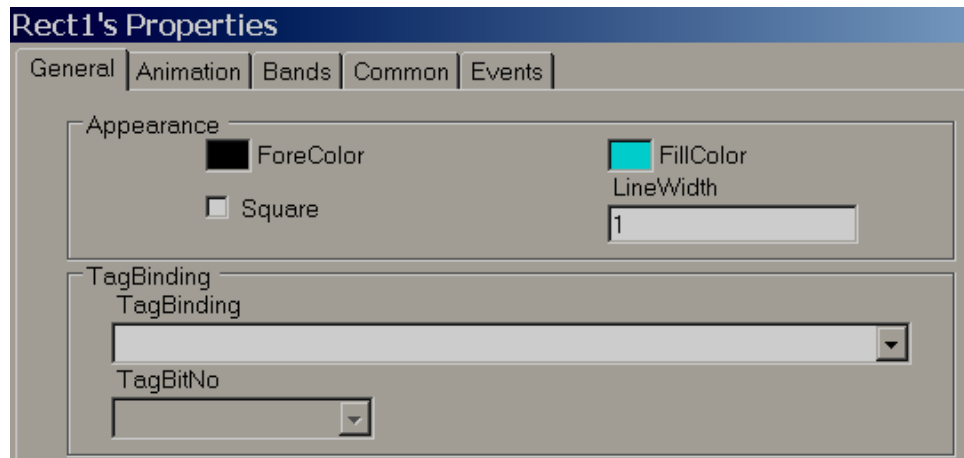

Animation Supported: Fill, Movement and Size

The above features are same as explained for Line and Polygon objects

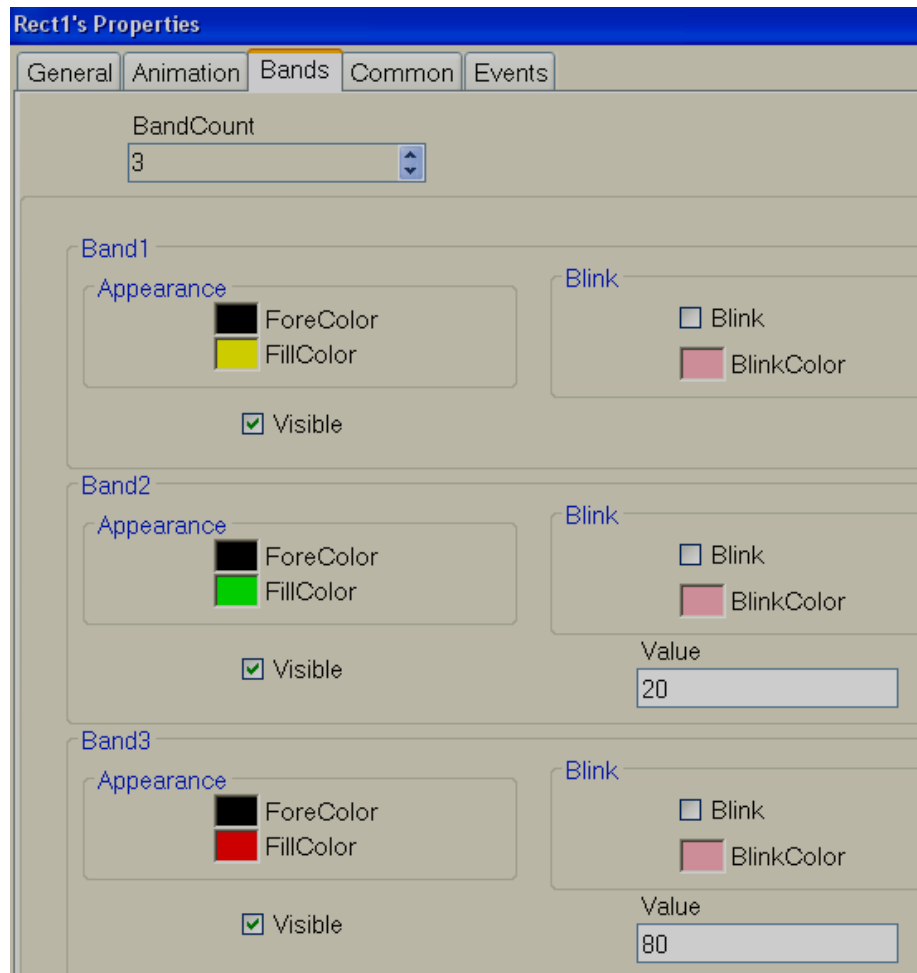

Band editor: Maximum 32 bands are available.

For ex: In above sample,
 If Tag value is between 0 to 20, Rectangle fill color = Yellow
 If Tag value is 21 to 80, then, Rectangle fill color = Green
 If Tag value in Run time is above 80, Rectangle fill color = RED

If required, it is also possible to configure blink property and set blink color in any band.

6.7.1.5 Ellipse

Ellipse: It is to draw Ellipse or a circle and do animation in Run time linking with a Tag.

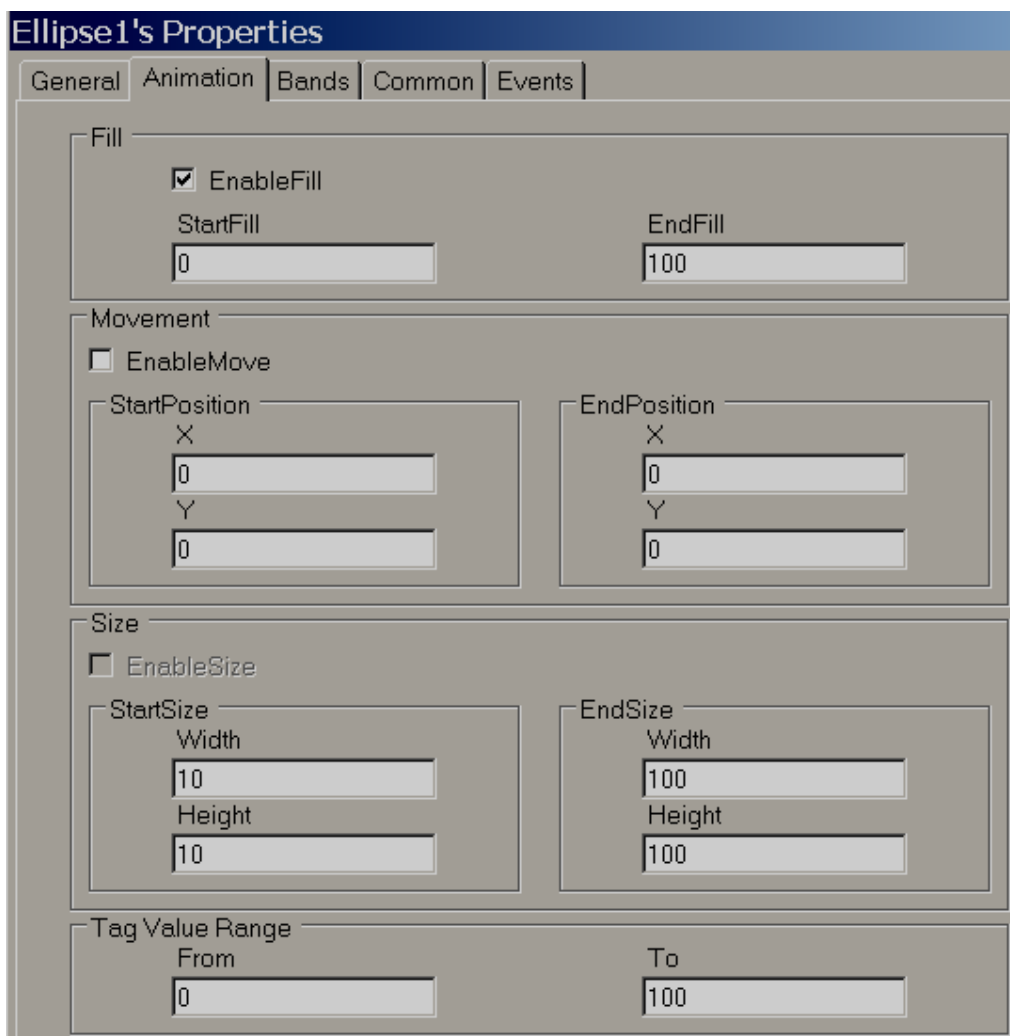
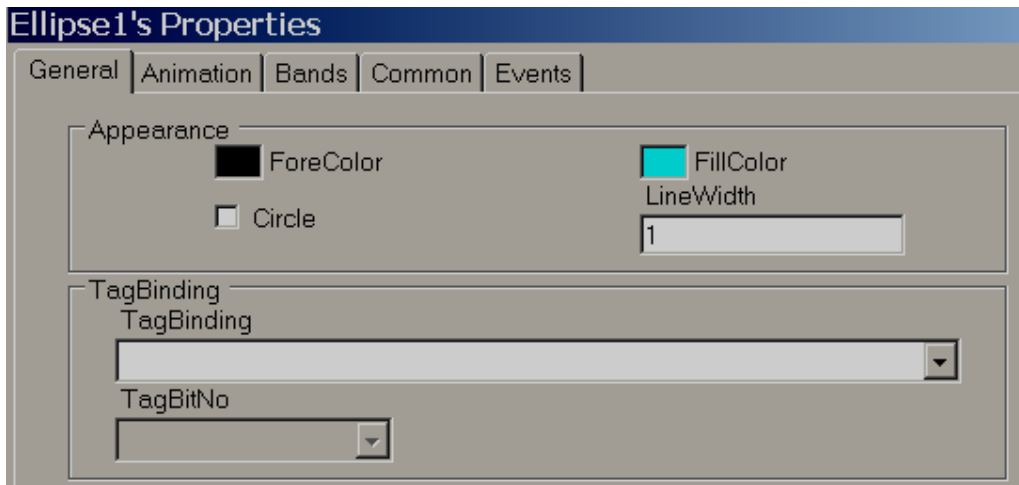

Animation Supported: Fill, Movement and Size

The above features are the same as explained for Line and Polygon objects.

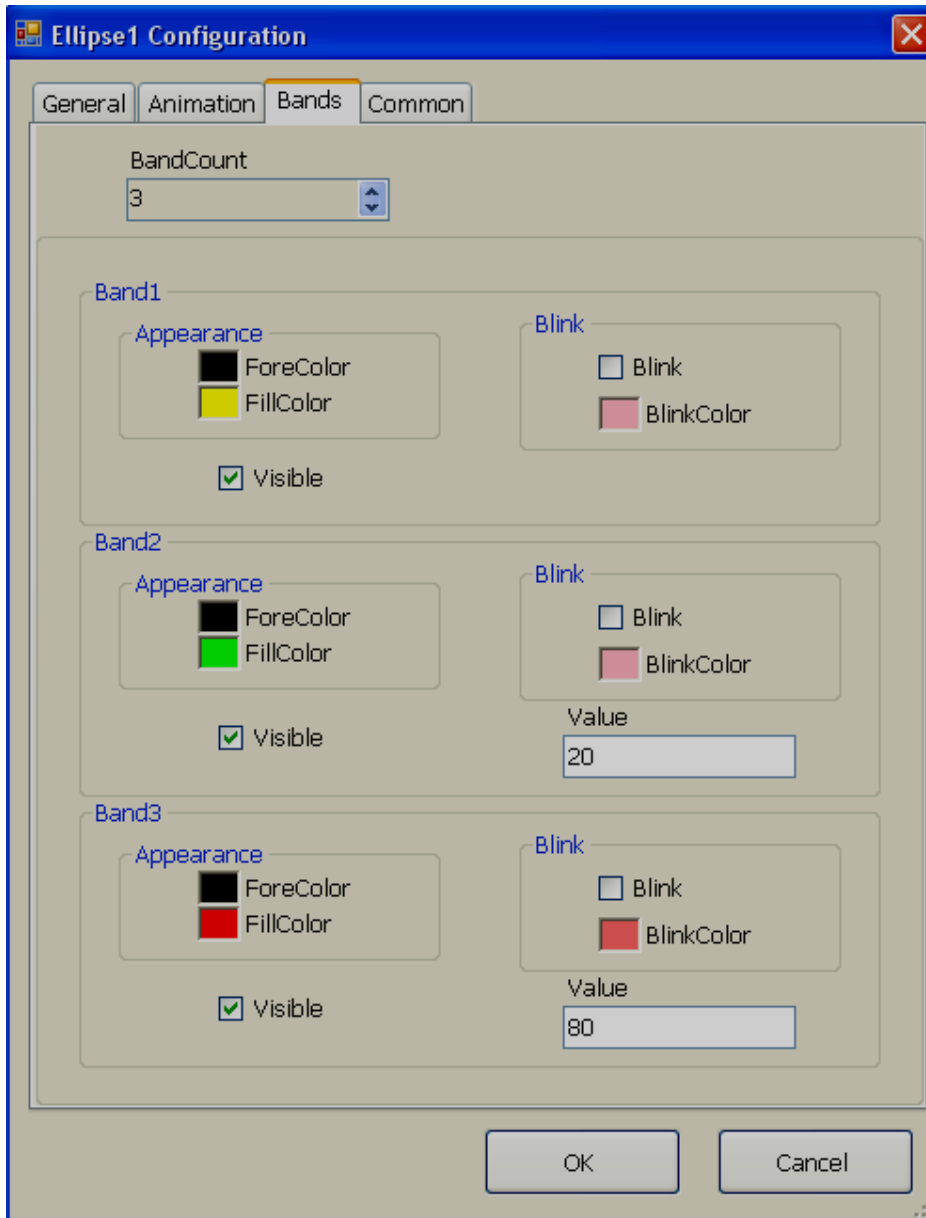

Band editor: Maximum 32 bands are available.

For example: In above sample,

If Tag value is between 0 to 20, Ellipse fill color = Yellow

If Tag value is 21 to 80, then, Ellipse fill color = Green

If Tag value in Run time is above 80, Ellipse fill color = RED

If required, it is also possible to configure blink property and set blink color in any band,

6.7.1.6 Arc

Arc: It is to draw Arc and do animation in Run time linking with Tag.

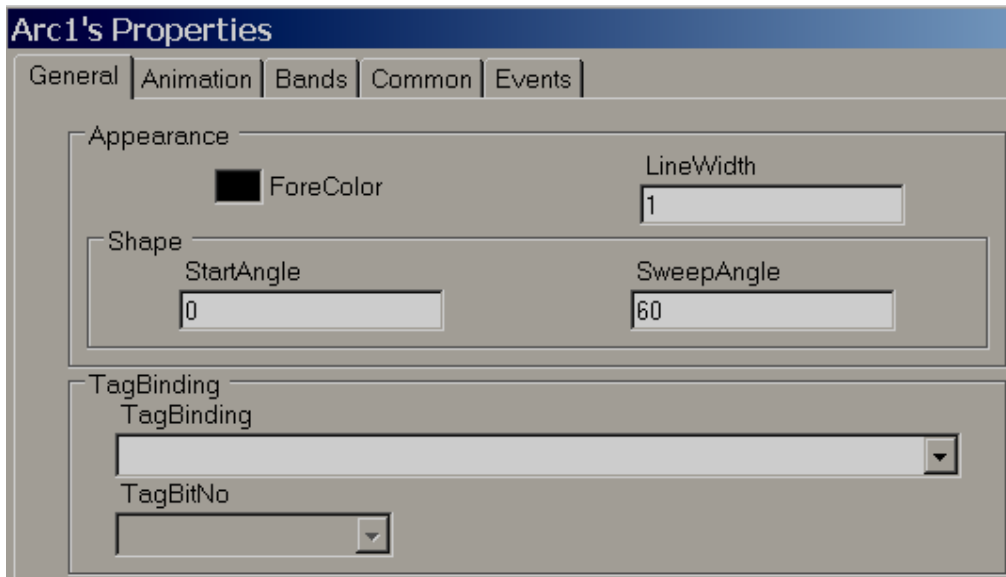

Start Angle: Define start angle, Sweep angle: Define end angle

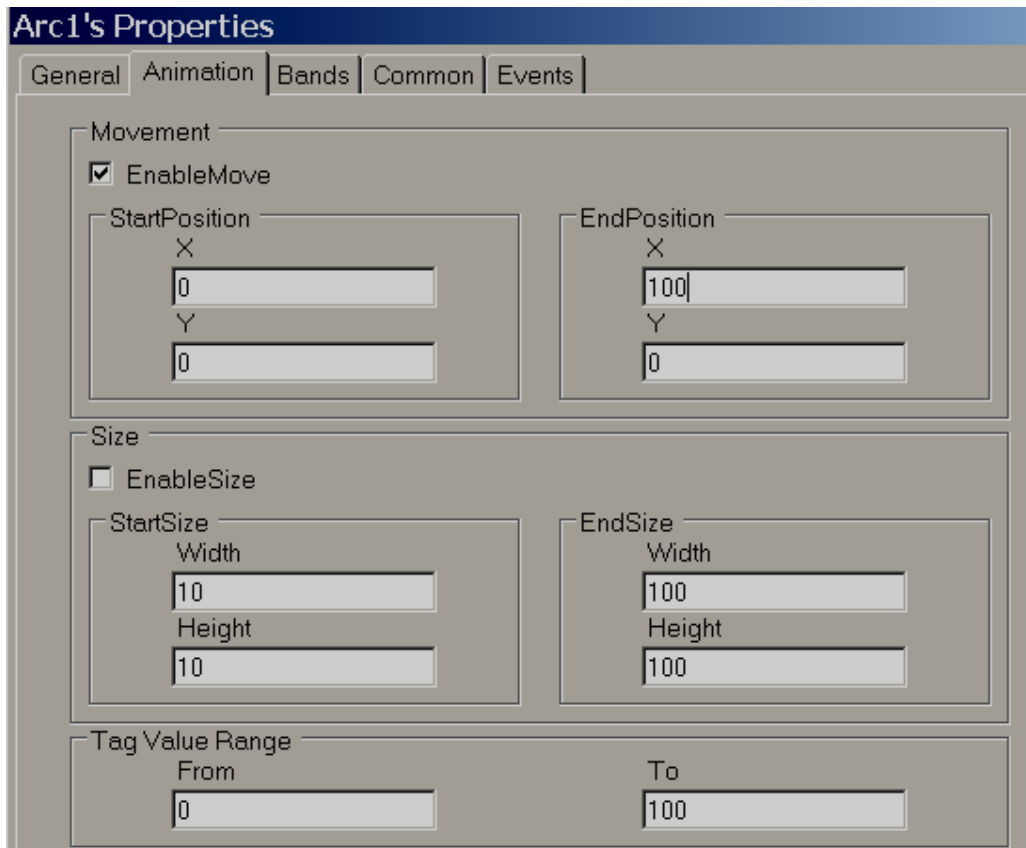

Supported Animation: Movement and Size

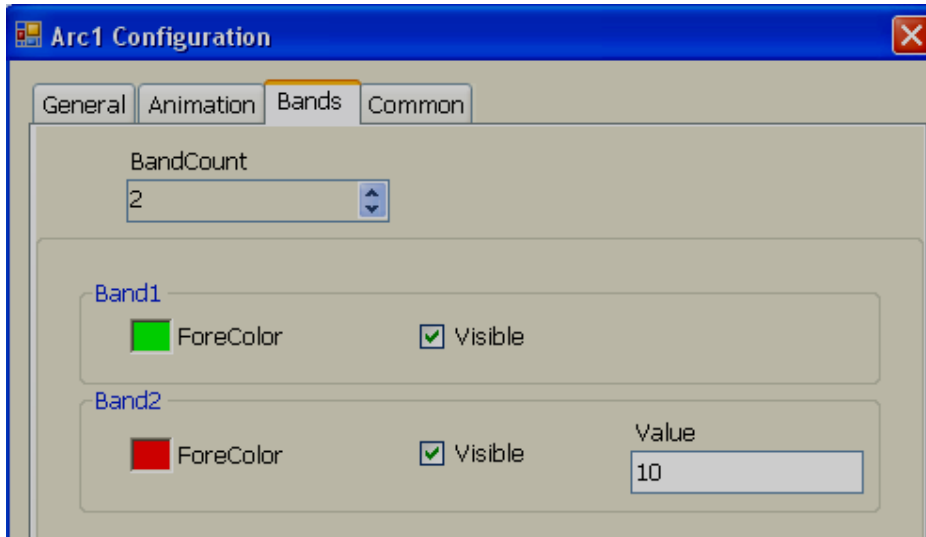

Band editor: Maximum 32 bands are available. Band editor for Arc is the same as explained for “Line” object earlier.

6.7.1.7 Table

It is to draw a table in design time by specifying number of rows & columns. All rows/columns will have the equal width and height. It is possible to place labels on rows (Linked with Tags) for displaying process values to appear like a tabular column. User can edit properties via GUI dialog or Property grid as per convenience. After drag/drop of the object to screen, double click on object to open GUI dialog.



While working with Table, in page properties, select Snap to Grid = False such that it is easy to place labels/ Textbox in required position easily.

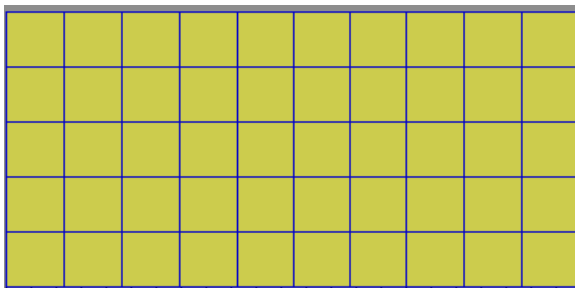

Drag/Drop Table from Basic objects to screen and double click on Table. Following screen will open.

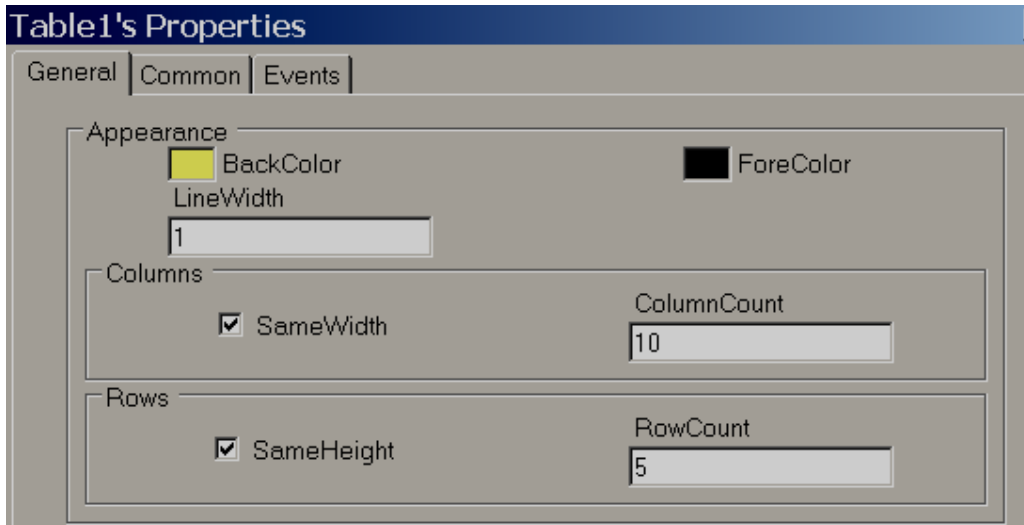

Note: Deselect “Same Width” to adjust column width in the Table

Note: Deselect “Same Height” to adjust Row height in the Table

Property grid

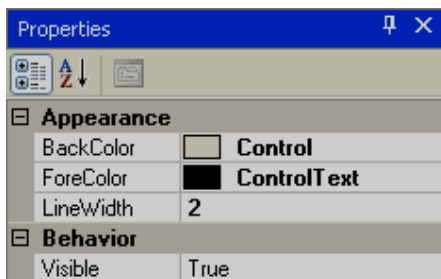

Design	
(Name)	Table1
Columns	5
Locked	False
Rows	5
Layout	
Dock	None
Location	80, 192
Size	480, 176

Properties

Back Color: It is back color for the table

Fore Color: It is color for the lines in table

Line Width: It is the width of lines

Columns: It is to define number of columns in table

Rows: It is to define number of rows in table

Name: It is the unique name for the table in specific page

Locked: It is to determine if table is locked for further moving and resize in design time and you can set this in property grid.

6.7.1.8 Numeric Up/Down

Numeric Up/Down is Graphical User Interface widgets that allow the user to increase or decrease value of a tag by pressing Up or Down arrows in Run time or alternatively enter numeric value directly via keypad. User can edit properties via GUI dialog or Property grid as per convenience. After drag/drop of object to screen, double click on the object to open GUI dialog.

Every Numeric Up/Down button should be linked with an **Analog** Tag.



Except Up/Down arrow, if user presses another area of Numeric Up/Down component in HMI at Run time, Numeric keypad will open. Then, user can enter numeric value directly. Numeric Keypad will not appear in PC during Online/Offline simulation and you can use keyboard directly to enter numeric value.

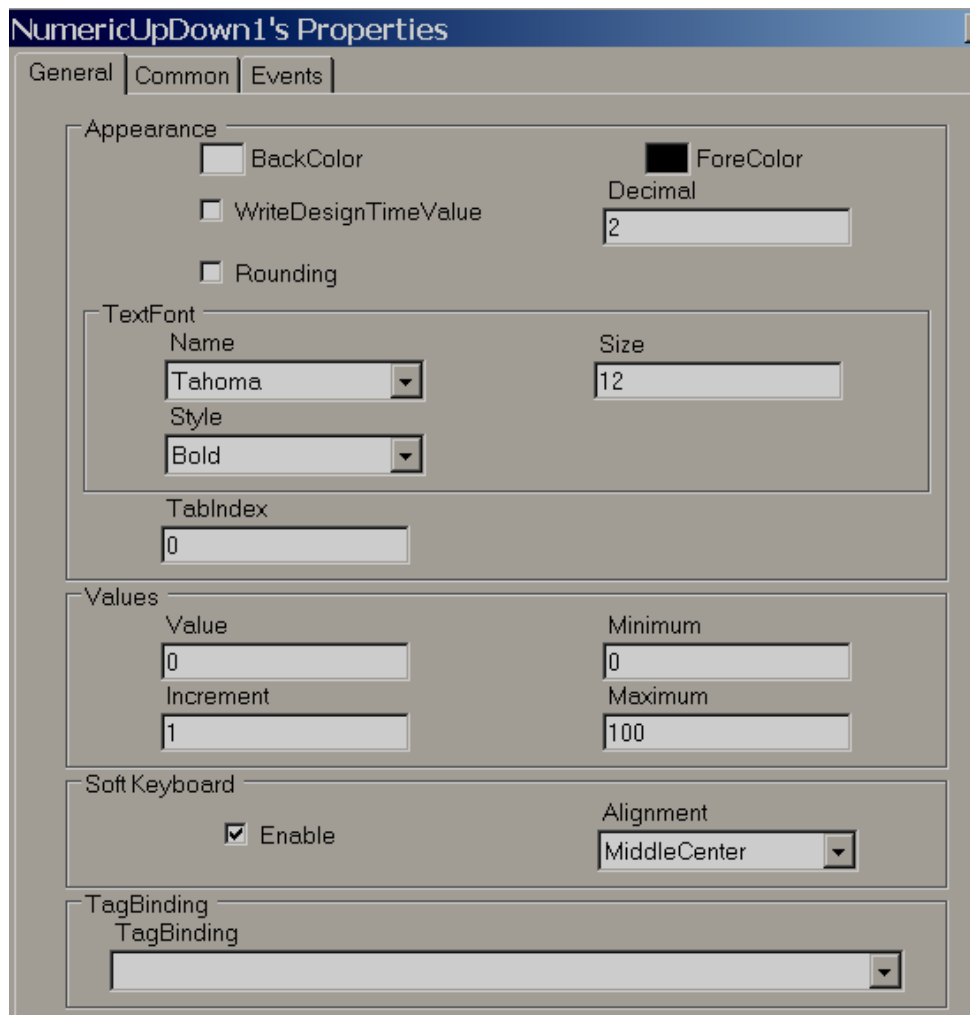

Increment: Select the value to be incremented/ decremented each time when up/down arrow is pressed in Run time.

Properties

Write design time value: If selected, it writes value available at “Text” in design time and also in run time replacing default value defined at Tag data base.

Rounding: Rounding to nearest value

Decimal: Enter number of decimal points

Value: Current Tag value. It is used to enter value in design time and check how value is displayed in Run time.

Increment: Value to be incremented in Run time after pressing Up/Down button.

Minimum: Define Minimum value

Maximum: Define Maximum value

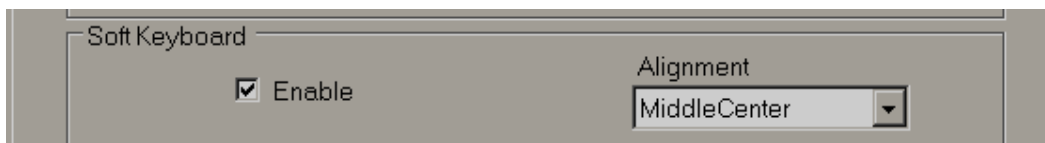

Soft keyboard: If enabled, then, it is possible to control the keypad appearance in run time. For example, if alignment is selected as Middle center, then, when keypad appears in run time, it will be located to Middle center in screen

Events: Define events to be executed when operator pressed on Up/Down arrow and value changes occurs in Run time.

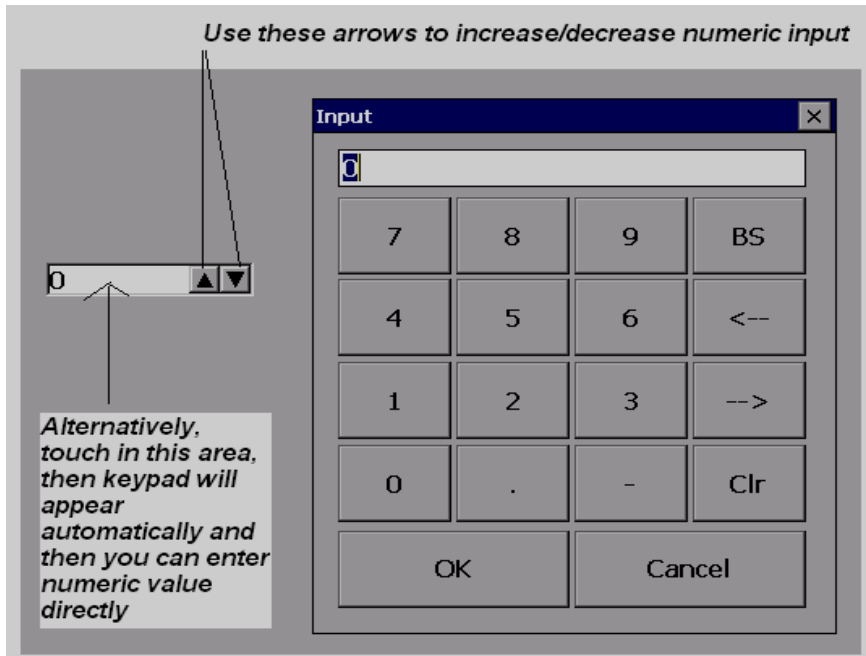

6.7.1.9 Digital LED

It is to view process value in Digital format. Generally it is linked with Analog type tag (Analog input type tag at PLC, which is received as 4-20 mA signals from field transmitters like Temperature, Pressure, Flow, Level, Position etc...)

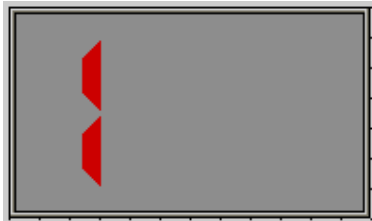

For common properties like Back Color, Bevel, please refer section “Common Properties

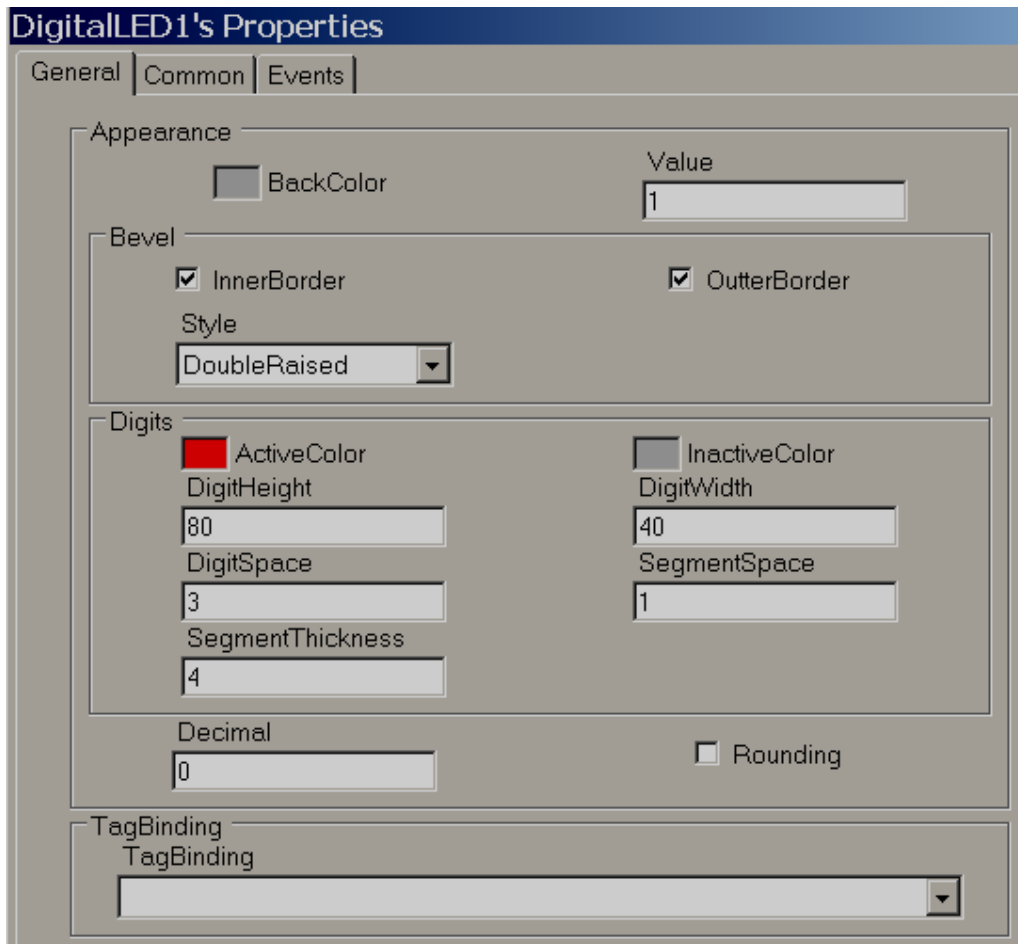

Property grid

Digits		Red,80,3,40,Color [Silver]
ActiveColor	■	Red
DigitHeight		80
DigitSpace		3
DigitWidth		40
InactiveColor	■	Silver
SegmentSpace		1
SegmentThickness		10

Properties

Back Color: Define background color for the component

Inner border: Select if inner border is required for the component

Outer border: Select if outer border is required for the component

Style: Define border style. Available options are Single, Double, Raised, Lowered, Double Raised, Double Lowered, Frame Raised and Frame Lowered

Active Color: Define Active Color of Segment for Digits

Inactive Color: Define color of inactive segment. In the seven-segment LED display, some segments might be active and some other segments might be inactive depending numeric value.

Digit Height: Define Height of Digits

Digit Width: Define width of Digits

Digit Space: Define Space between digits

Segment Space: Define space between segment to segment for digits

Segment Thickness: Define thickness of segments for digits

Decimals: Define number of decimal points

Tag Binding: Select the Analog Tag of process value

6.7.1.10 Digital Box

Digital Box is a Graphical User Interface widget that displays Digital Tag value along with four predefined labels as attributes for the process value in Run time.



Every Digital Box normally used with **Analog** Tag to display process values like Temperature, Pressure, Flow etc., It also allows 4 different labels as attributes for displaying tag related information.

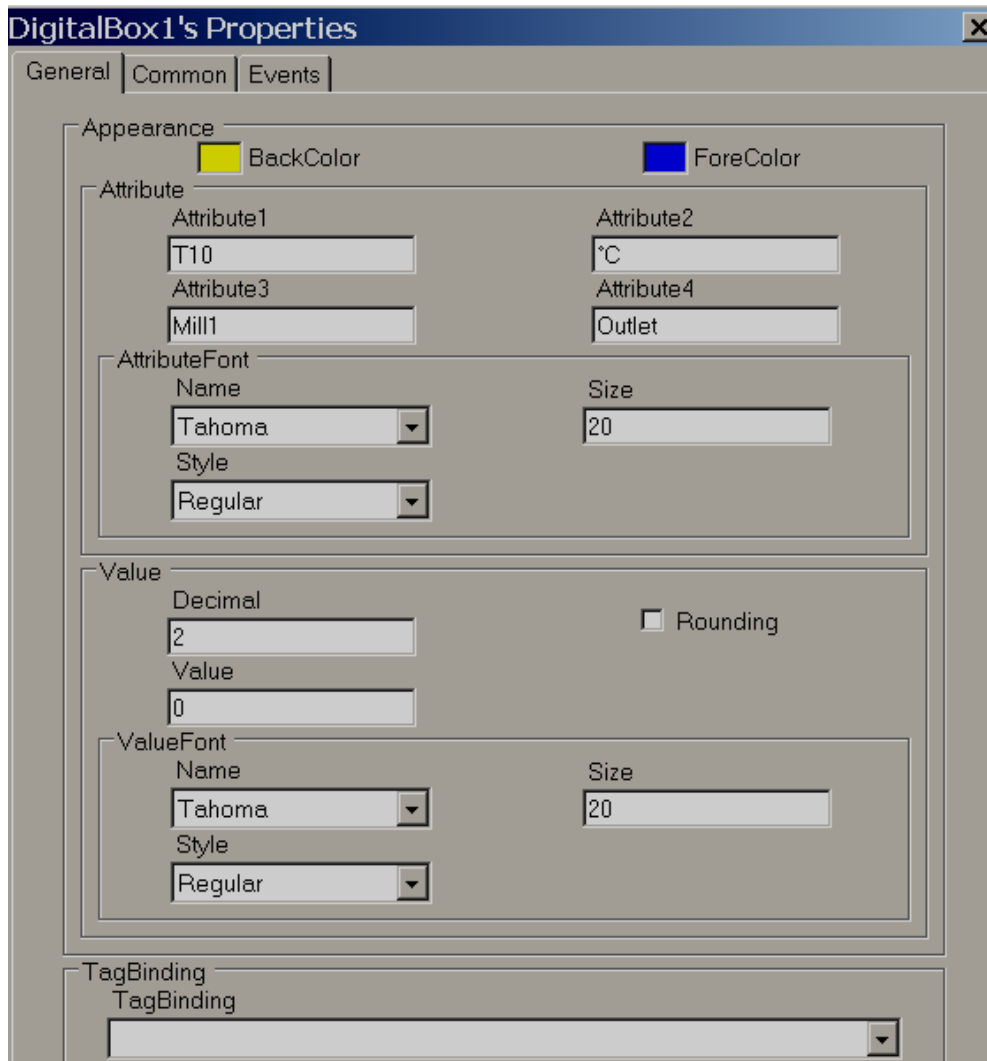

Appearance	
Attribute1	T10
Attribute2	^C
Attribute3	Mill 1
Attribute4	Outlet
AttributeFont	Microsoft Sans Serif
BackColor	Khaki
Decimal	2
ForeColor	Blue
ValueFont	Arial,20,Bold

Behavior	
Value	0
Visible	True
Data	
TagBinding	Tag3
Design	
(Name)	DigitalBox1
Locked	False
Layout	
Dock	None
Location	176, 224
Size	256, 112

Properties

Attribute1: attribute to be displayed at Top left side of Digital Box

Attribute2: attribute to be displayed at Top Right side of Digital Box

Attribute3: attribute to be displayed at Bottom Left side of Digital Box

Attribute4: attribute to be displayed at Bottom Right side of Digital Box

Attribute font: Define font for attribute, select type of windows font, size of font and style of font which includes Regular, Bold, Italic, Underline, and Strike out.

Back color: Define back ground color

Fore Color: Define fore color for the font

Decimal: Define number of decimal places for the value to be displayed

Value font: It is to adjust size of display process value font, select type of font, size of font and style of font including Regular, Bold, Italic, Underline and Strike out.

6.7.1.11 Text box

It is to Read/Write, Alpha numeric text in Run time. It can be linked with any type of tag.



If object is linked with String type tag, then, Alpha numeric keypad opens in Run time if users touch on object. If object is linked with Analog or Digital tag, then, numeric keypad opens in Run time if user attempts to touch on object. If Digital tag is used, then, make sure decimals are set to 0.

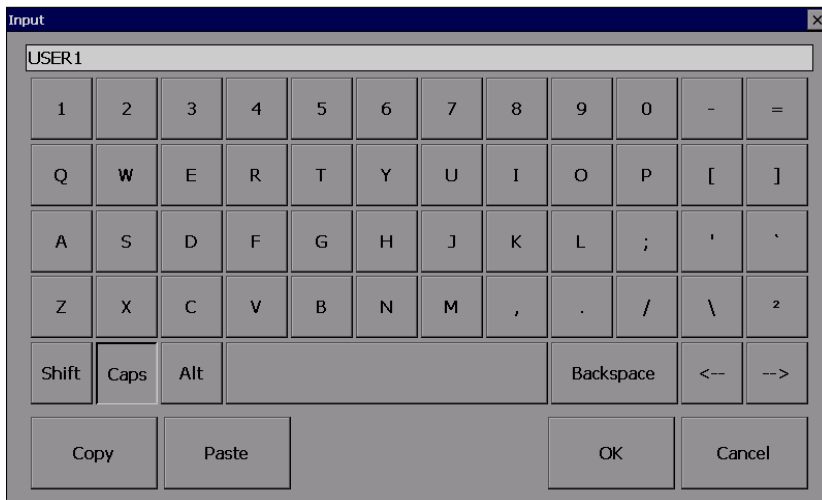

Alpha numeric keypad

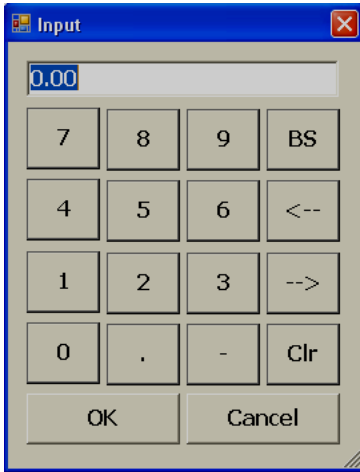

Numeric keypad

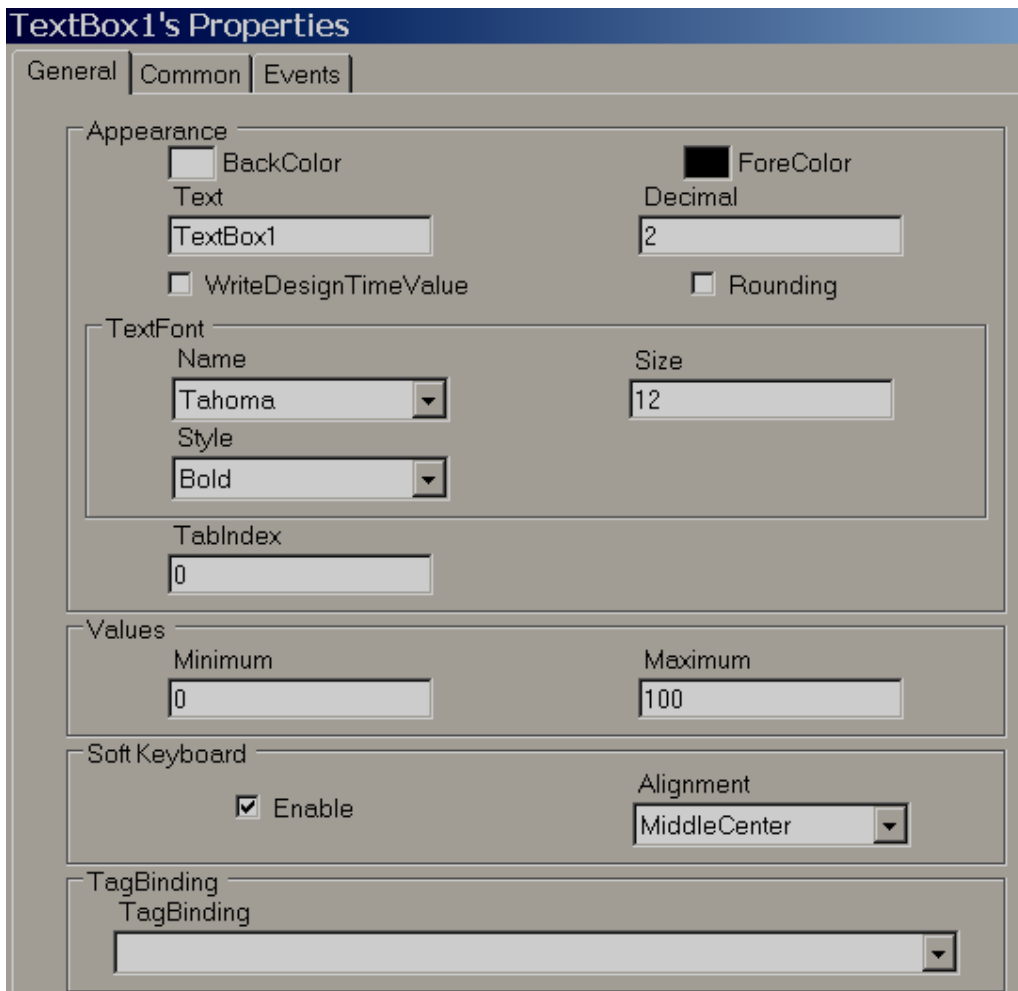

Note: For common properties of all the components, please check beginning of this section.

Write design time value: If selected, it writes value available at “Text” in design time and also in run time replacing default value defined at Tag data base.

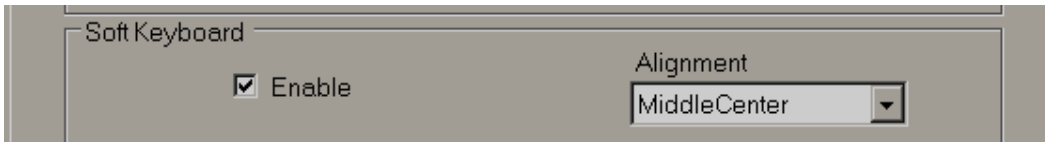

Soft keyboard: If enabled, then, it is possible to control the keypad appearance in run time. For example, if alignment is selected as Middle center, then, when keypad appears in run time, it will be located to Middle center in screen

<table border="1"> <tr><td colspan="2">☐ Appearance</td></tr> <tr><td>BackColor</td><td>White</td></tr> <tr><td>Decimal</td><td>2</td></tr> <tr><td>ForeColor</td><td>ControlText</td></tr> <tr><td>Password</td><td></td></tr> <tr><td>Text</td><td>TextBox1</td></tr> <tr><td colspan="2">☐ TextFont Tahoma,12,Bold</td></tr> <tr><td colspan="2">☐ Behavior</td></tr> <tr><td>Visible</td><td>True</td></tr> <tr><td colspan="2">☐ Data</td></tr> <tr><td>TagBindin</td><td>Tag1</td></tr> </table>		☐ Appearance		BackColor	White	Decimal	2	ForeColor	ControlText	Password		Text	TextBox1	☐ TextFont Tahoma,12,Bold		☐ Behavior		Visible	True	☐ Data		TagBindin	Tag1	<table border="1"> <tr><td colspan="2">☐ Design</td></tr> <tr><td>(Name)</td><td>TextBox1</td></tr> <tr><td>Locked</td><td>False</td></tr> <tr><td>SecurityL</td><td>0</td></tr> <tr><td colspan="2">☐ Events</td></tr> <tr><td>Changed</td><td></td></tr> <tr><td colspan="2">☐ Layout</td></tr> <tr><td>Dock</td><td>None</td></tr> <tr><td colspan="2">☐ Location 96, 96</td></tr> <tr><td colspan="2">☐ Size 112, 24</td></tr> <tr><td colspan="2">☐ Misc</td></tr> <tr><td>WriteDesi</td><td>False</td></tr> </table>		☐ Design		(Name)	TextBox1	Locked	False	SecurityL	0	☐ Events		Changed		☐ Layout		Dock	None	☐ Location 96, 96		☐ Size 112, 24		☐ Misc		WriteDesi	False
☐ Appearance																																																	
BackColor	White																																																
Decimal	2																																																
ForeColor	ControlText																																																
Password																																																	
Text	TextBox1																																																
☐ TextFont Tahoma,12,Bold																																																	
☐ Behavior																																																	
Visible	True																																																
☐ Data																																																	
TagBindin	Tag1																																																
☐ Design																																																	
(Name)	TextBox1																																																
Locked	False																																																
SecurityL	0																																																
☐ Events																																																	
Changed																																																	
☐ Layout																																																	
Dock	None																																																
☐ Location 96, 96																																																	
☐ Size 112, 24																																																	
☐ Misc																																																	
WriteDesi	False																																																

6.7.1.12 Label

Label is to write a simple text for user information in the screen to improve clarity for the operator. Example: Tag name, Pump number display etc. It is also used to display process value (read only) to operators by linking with Tag.

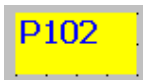

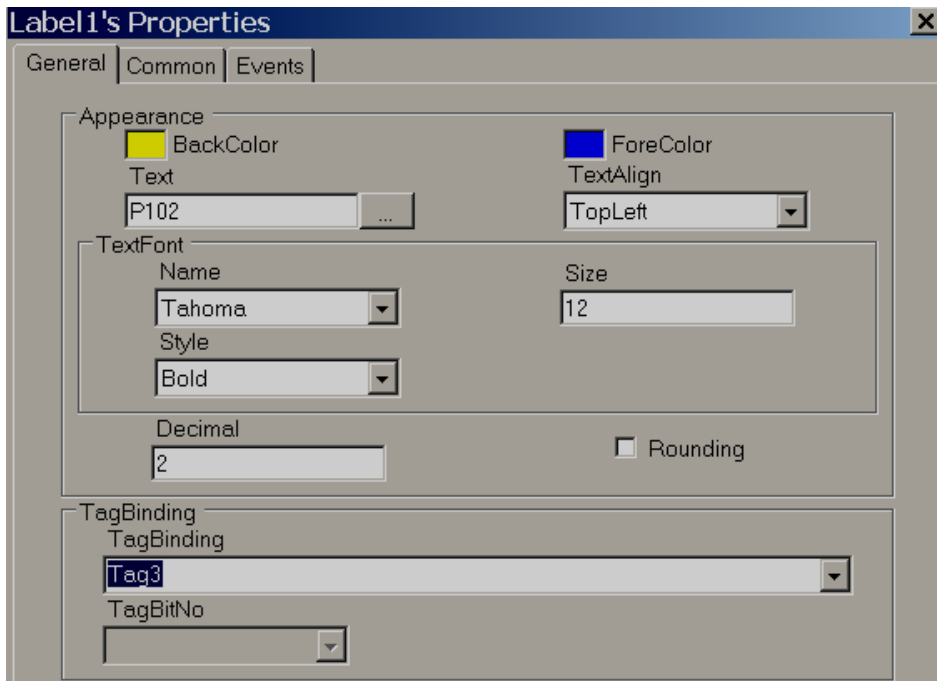

Properties...	
Appearance	
BackColor	Yellow
Decimal	2
ForeColor	Blue
Rounding	False
Text	P102
TextAlign	TopLeft
TextFont	Tahoma,12,Bold
Behavior	
Enable	
Visible	

Data	
TagBinding	Tag3
Design	
Name	Label1
Events	
Clicked	
Layout	
Location	224;126
Size	112;38

Note: For common properties of all the components, please check beginning of this section.

Properties

Text: Define text associated with this component and it should be entered at design time only.

Text Align: It is for Alignment of text and available options include Top Left, Top Center, Top Right, Middle Left, Middle Center, Middle Right, Bottom Left, Bottom Center and Bottom Right

Text Font: Define font for text including type of font, size of font and style of font. Styles include Regular, Bold, Italic, Underline and Strikeout.

Tag Binding: Select the Analog Tag of process value

Decimal: Define number of decimal points

6.7.1.13 Date and time Label

1/20/2010 PM 4:43:03

It is to display Date and Time in screen.

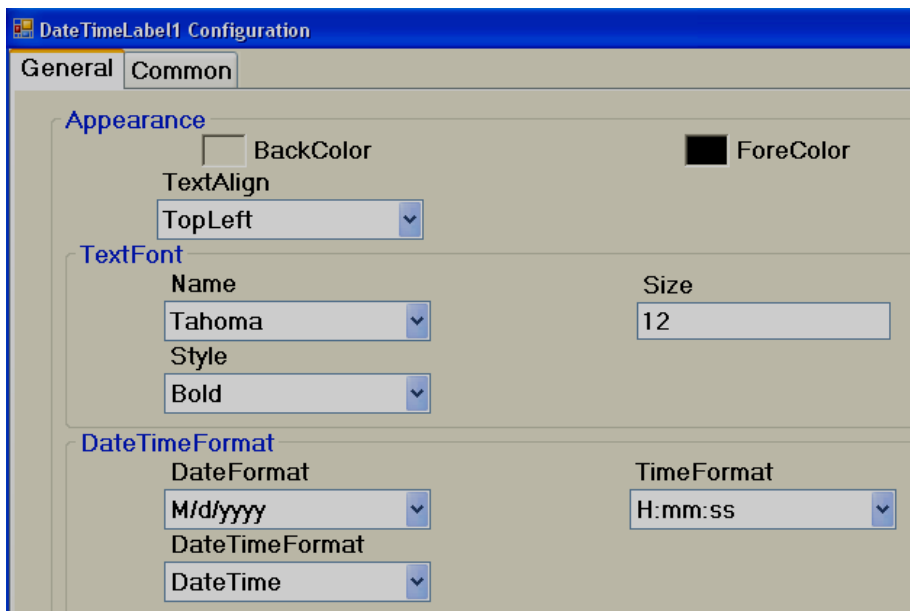

If date and time required in more than one screen, it is better to create screen and select screen type as "Template" and then link this template to all other required screens to display Date and Time automatically. This is more efficient than keeping Date and Time label in more than one screen.

6.7.1.14 Real time Alarm Box

Real time Alarm box is Graphical User Interface widget used to display Real time alarms in Run time.

No	ActiveTime	Acked	Type	Name	Value	Message	Group

RealtimeAlarmBox1 Configuration

General Columns Common

Appearance

TextFont

Name	Tahoma	Size	12
Style	Bold		

Behavior

LatestAlarm	Bottom
--------------------	--------

RealtimeAlarmBox1's Properties

General Columns Common

No	<input checked="" type="checkbox"/> Visible	Width	30
ActiveTime	<input checked="" type="checkbox"/> Visible	Width	160
Acked	<input checked="" type="checkbox"/> Visible	Width	60
Type	<input checked="" type="checkbox"/> Visible	Width	70
Name	<input checked="" type="checkbox"/> Visible	Width	160
Value	<input checked="" type="checkbox"/> Visible	Width	60
Message	<input checked="" type="checkbox"/> Visible	Width	102
Group	<input checked="" type="checkbox"/> Visible	Width	60

Property grid

Properties	
Appearance	
TextFont	Tahoma,12,Bold
Behavior	
LatestAlarm	Bottom
Visible	True
Column	
Columns	(Collection)

Design	
(Name)	RealtimeAlarmBox1
Locked	False
No	0
Layout	
Dock	None
Location	16, 32
Size	736, 160

Properties

Latest Alarm: Configure how alarms to be displayed in alarm box. Available options include Bottom and Top. If “Top” is selected, then, all the latest alarms will be displayed at the top of alarm box in Run time.

Columns: It is to select columns required to display in Alarm box. Select the required column and then Set Visible = true if column is required. Set Visible = false if column is not required. Also set width of specific column from here.

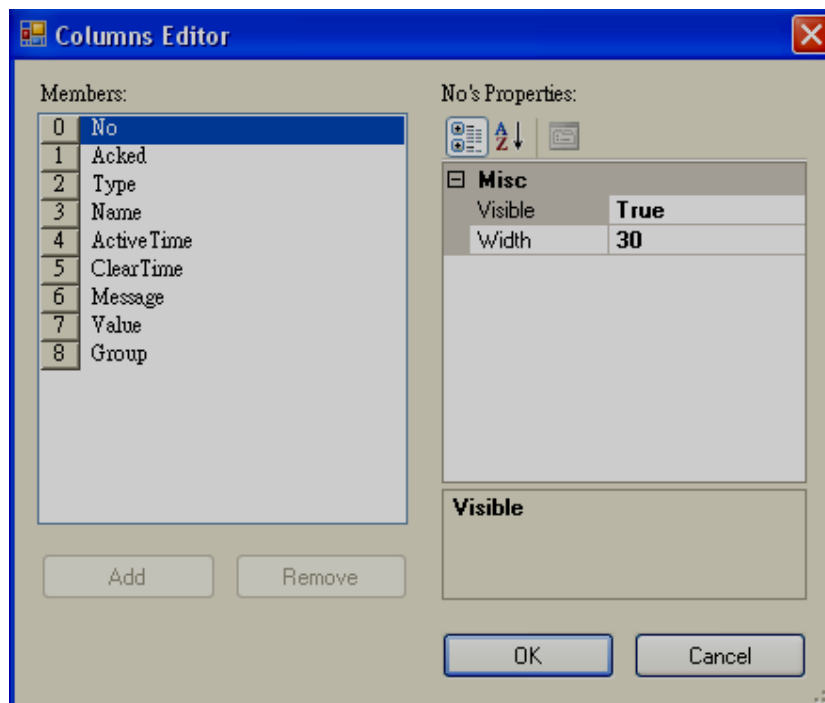

Alarm functions

Insert button and link events with any of the following functions via function editor.

Acknowledge alarm

Navigate alarms to first page, last page, page up & Page down

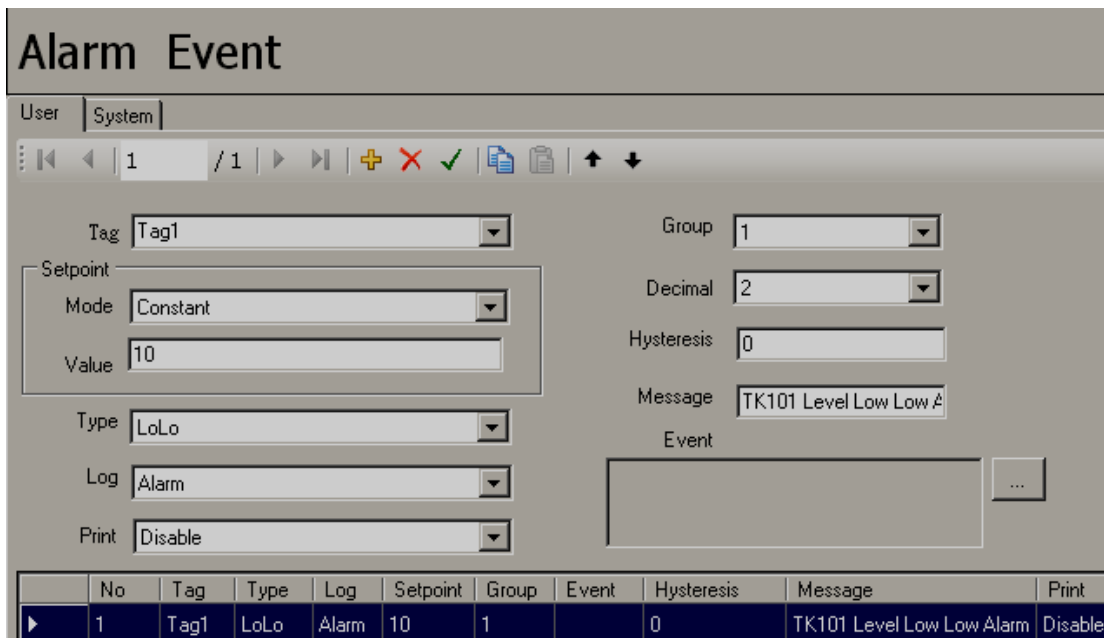
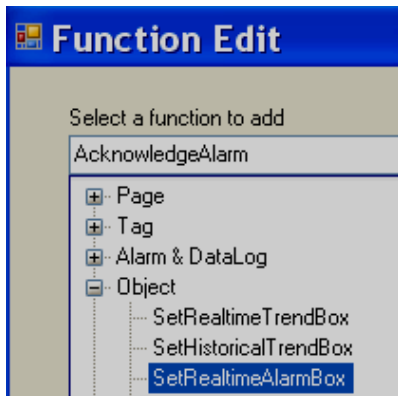
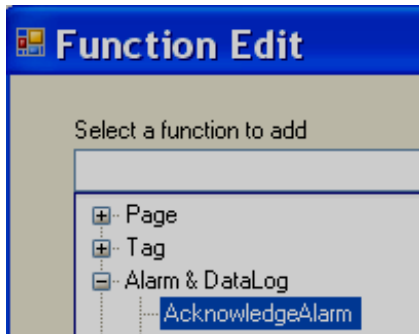

Fig: Alarm configuration screen in design time

Please check section Events and Alarms for more information about Alarm and Events configuration

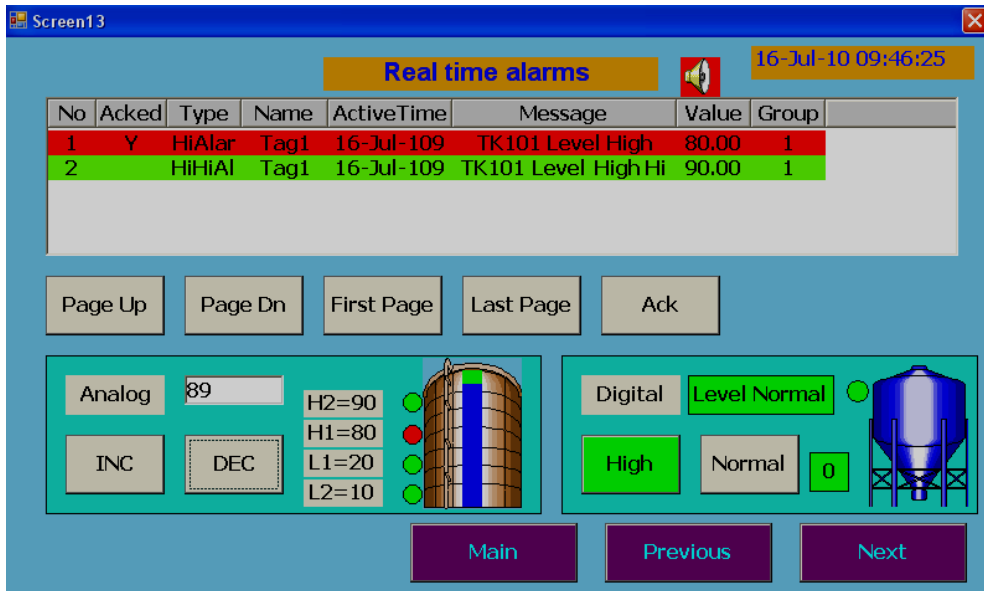

Fig: Real time alarm box in run time

On the Event / Alarm List, two different colors indicate the status of the alarm.

Red - Presently in alarm status

Green – The cause of alarm status was temporary, and has now returned to normal.

A temporary alarm (in green status), once it is acknowledged, then disappears from Real time alarm box.

Active Time is the time that alarm status becomes active.

Acked: Shows status of user acknowledgement. It shows “Y” after user acknowledged and does not show any thing if user does not acknowledge.

Type: Shows Alarm type

Name: Shows tag name

Value: Shows process value at the time of trigger

Message: Shows message defined for the alarm during configuration

Group: Shows group for the tag if defined during alarm configuration

Firstly alarm status is cleared and becomes normal, and secondly the user has acknowledged it. If any alarm occurs, if Alarm blink object used in screen, then the red buzzer icon starts to flash. After the cause of alarm is no longer met and the alarm is acknowledged, then the red buzzer icon disappears.

6.7.1.15 Historical Alarm Box

Screen14

21-Dec-11 14:34:39

Historical alarms

No	ActiveTime	Type	Name	Value	Message	Group
1	21-12-11 2:33:40 PM	PowerOn				
2	21-12-11 2:34:03 PM	LoAlarm	Tag1	18.00	TK101 Level Low	1
3	21-12-11 2:34:08 PM	Ack	All			
4	21-12-11 2:34:11 PM	Normal	Tag1		TK101 Level Low	1
5	21-12-11 2:34:24 PM	HiAlarm	Tag1	81.00	TK101 Level High	1
6	21-12-11 2:34:27 PM	Ack	All			
7	21-12-11 2:34:29 PM	Normal	Tag1		TK101 Level High	1

Page Dn First Page Last Page Refresh Dump Clear

Main page Basic Enhanced Trends Alarms

HistoricalAlarmBox1's Properties

General Columns Common

Appearance

TextFont

Name: Tahoma Size: 12

Style: Bold

Behavior

LatestAlarm: Bottom

Properties

Latest Alarm: Configure how alarms to be displayed in alarm box. Available options include Bottom and Top. If “Top” is selected, then, all the latest alarms will be displayed at the top of alarm box in Run time.

For example: If “Removable disk” is selected, then, make sure dump of historical alarms task is executed periodically say from Scheduler alternatively manually via button. Then, you will be able to view historical alarms properly.

Columns: It is used to select columns required to display in Alarm box. Select the required column and then Set Visible = true if column is required. Set Visible = false if column is not required. Also set width of specific column from here.

Column properties are same as defined at Real time alarm box

Alarm functions

Insert button and link events with any of the following functions via function editor.

Acknowledge alarm

Dump alarm

Clear alarm

Navigate alarms to first page, last page, page up & page down

6.7.1.16 Alarm Banner

It is to display Real time alarm in Run time in a single line. Ideally it is placed in Top of HMI screen in a template and link this template with other screens such that operator will be alerted with any new Real time alarm.

Acked, AlarmType, TagName, ActiveTime, Message, Value

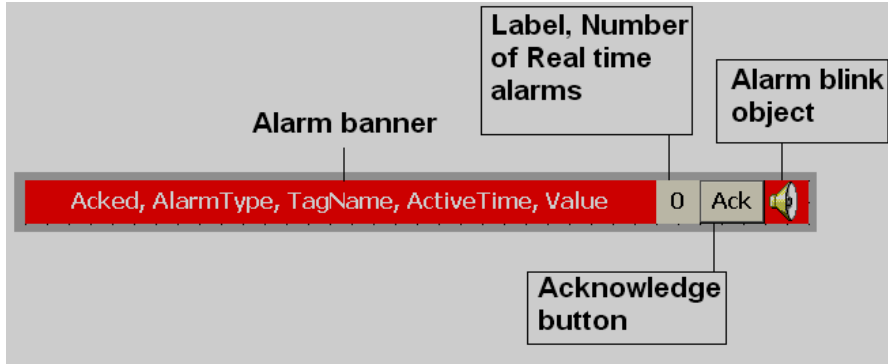

AlarmBanner1's Properties

General | Columns | Common | Events

Acked	<input checked="" type="checkbox"/> Visible
Type	<input checked="" type="checkbox"/> Visible
Name	<input checked="" type="checkbox"/> Visible
ActiveTime	<input checked="" type="checkbox"/> Visible
Message	<input checked="" type="checkbox"/> Visible
Value	<input checked="" type="checkbox"/> Visible

By default, all the columns are selected. If check box is de selected, then, specific column will not appear in the Alarm banner

6.7.1.17 Alarm Blink



It is ready made component available for Alarms. If Real time alarms are equal to or more than 1, then, alarm blink symbol appears with animation automatically. If there are no real time alarms and all active alarms are acknowledged, then, alarm blink symbol will disappear from the screen automatically.

AlarmBlink1's Properties

Common | Events

<p>Location</p> <p>X 564</p> <p>Y 76</p>	<p>Size</p> <p>Width 32</p> <p>Height 32</p>
<p>Others</p> <p>Name AlarmBlink1</p> <p>SecurityLevel 0</p>	

6.7.1.18 Button



A Button is commonly used to perform an action after operator presses it via finger or by clicking using a mouse in Run time.

Generally button is used to turn ON a bit, Turn OFF a bit etc. used with Digital type tags. Example: Start Pump, Stop pump etc.

Three kinds of events supported for a button. Clicked, Pressed and Released. Several functions are supported which can be configured from Events and all the functions are covered in next section "Function editor".

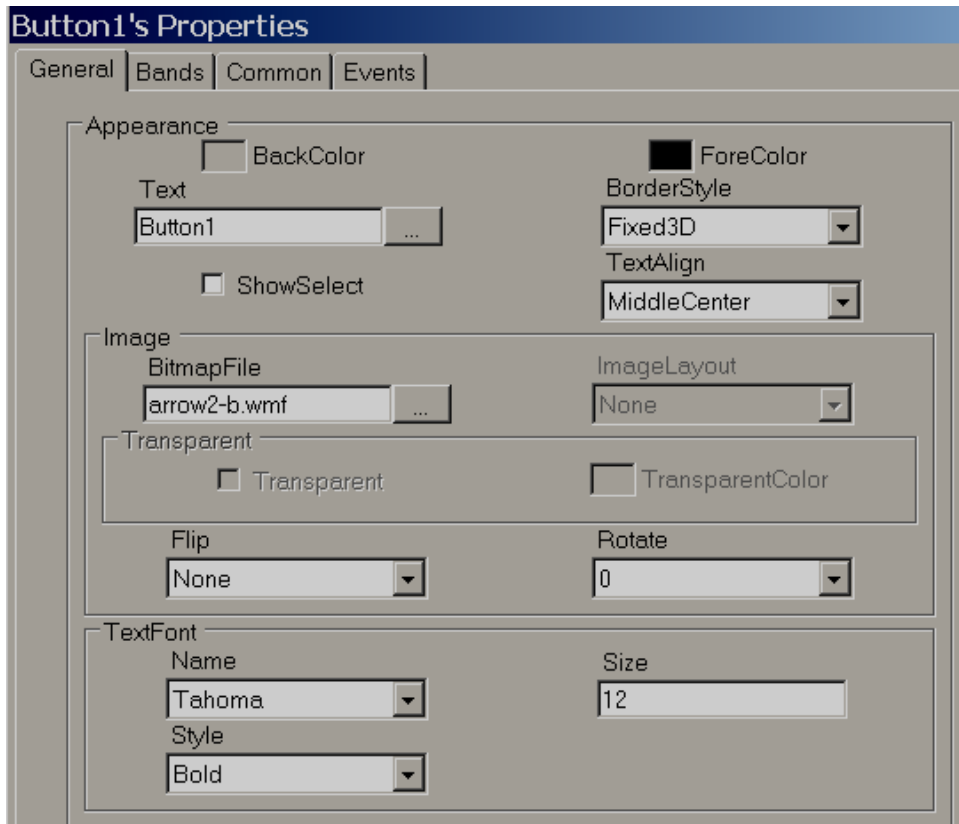

Properties

Back Color: Selects Back color for the object. Also, it is possible to select transparent mode if required from V1.20 onwards

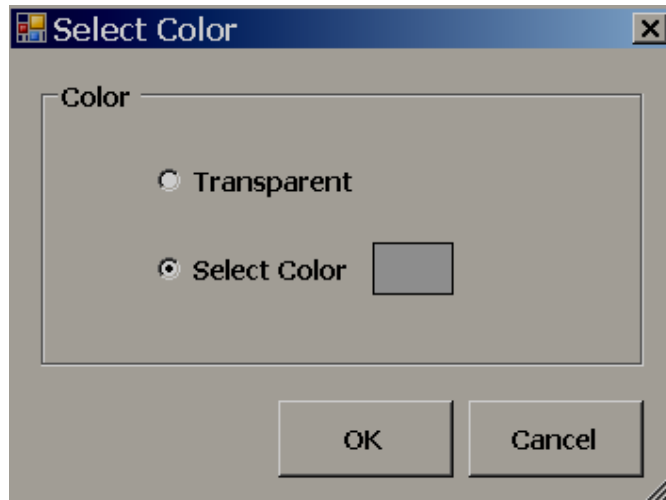

Text: Define required text to be displayed on the object. It is also possible to enter multiline text from V1.20 onwards

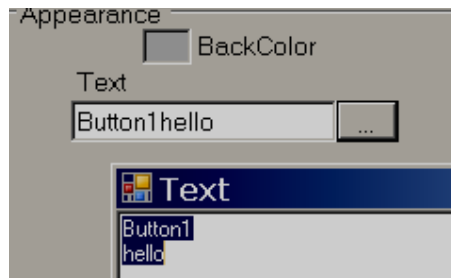

Show select: True/False. If it is selected, then, when operator presses this button, it will show dotted line just inside the button. When operator presses another button, it automatically shows selected “show” status to latest button and deselect “select” status for previous button pressed by the operator.

Border Style: Define border style. Available options include none, fixed single and fixed 3D

Image: Select the Image to be displayed on top of the object. Image can be selected either from Basic symbols or Symbol factory or custom image in formats of bmp, wmf, jpg, gif and png

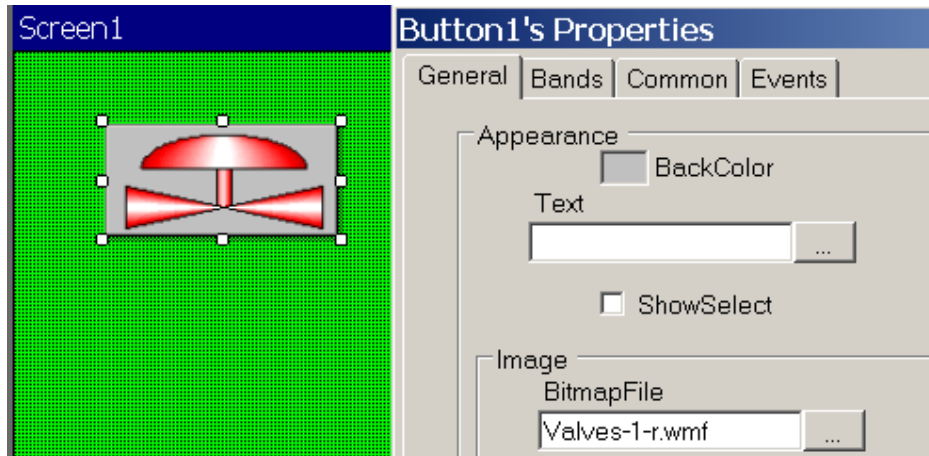

Text font: Define the font including name of font, size of font and style of font

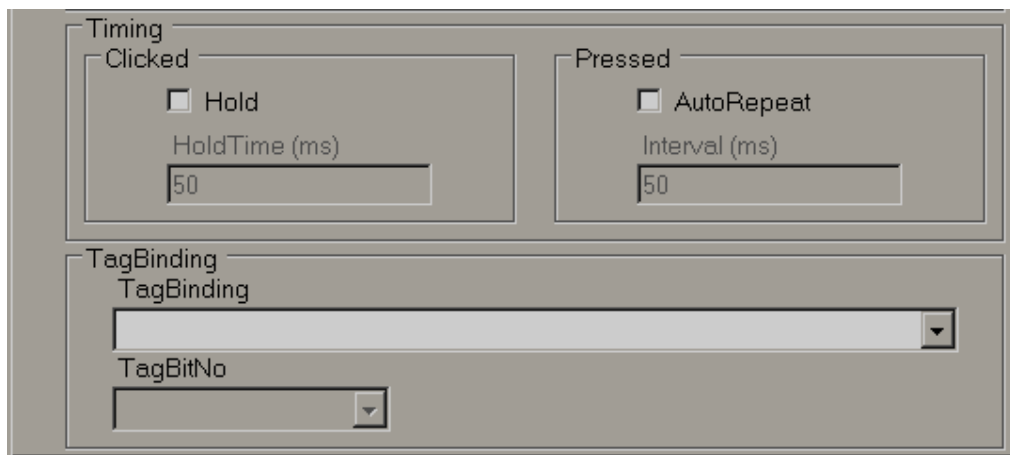

Timing: This is an advanced feature and used to make sure operator action is properly received by PLC when PLC scan time is large.

Hold time: This is generally applicable for “Click” event. This keep on executing action defined at Clicked event for the time defined at hold time. We suggest using holding time of button more than PLC scan time. Example: 300 msec.

Example:

Push button Function

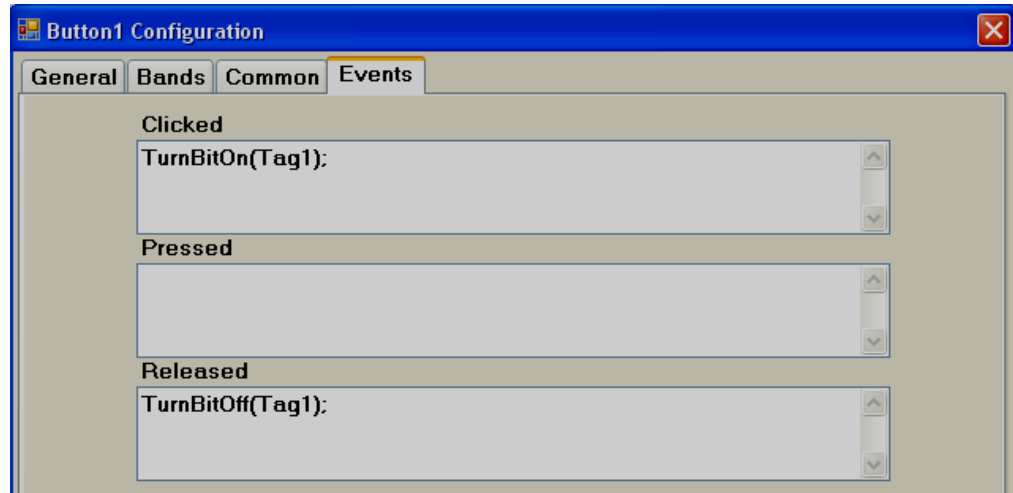

Example: Operator presses button for only 200 msec. When operator clicks button, Tag1 = 1 and when operator releases button, Tag1 = 0, holding time = 1000 msec.

Since holding time is set for clicked action, released action, "TurnBitOff" will be executed only after completing 1000 msec but not immediately after operator releases the button. In this case, if PLC scan time is 800 msec, and still operator click action will be detected properly because operator command will be available for 1000 msec.

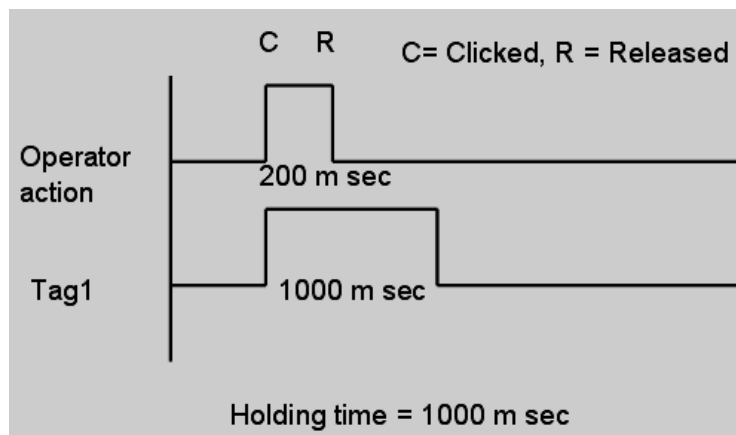

Auto Repeat & Interval time: This is generally applicable for "Pressed" event. It is to repeat the action defined at "Pressed" event as per set interval time.

Example: When operator keeps pressing button, set point should be incremented by 1 for every 1 sec and Tag1 is Integer type.

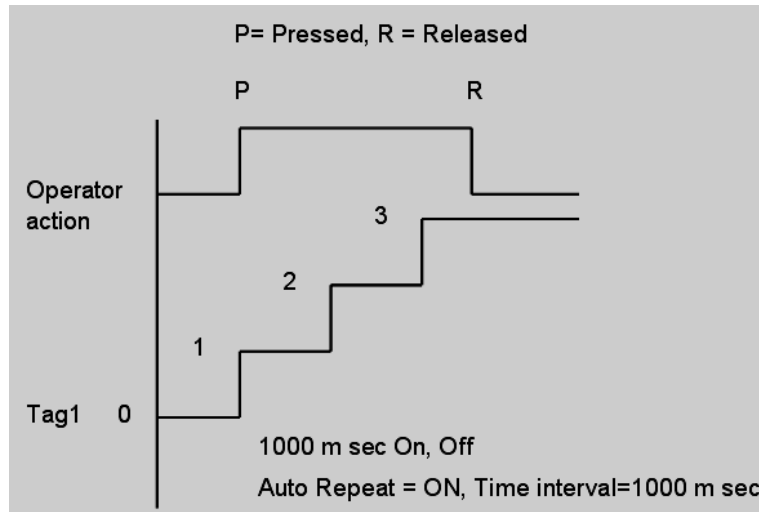

Auto repeat with time interval and holding time cannot be used together.

Tag binding: Select the tag that should be linked with the button to show different display in run time based on configuration available at Band editor. Both Analog

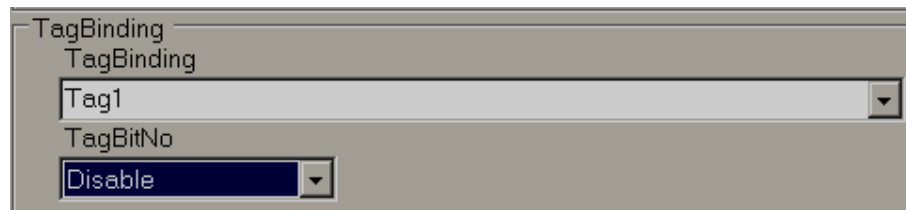

If Tag1 is Analog Type (32 bit), it is also possible to show different display based on individual bits. By default, it is disabled. You can select the bit from the combo box and then configure band editor as per project requirements.

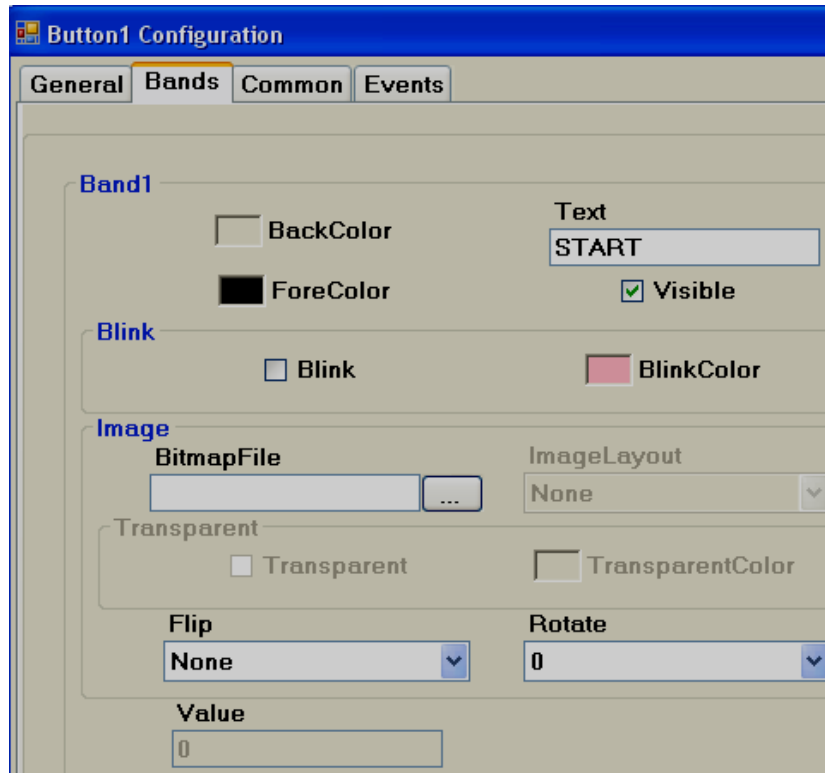

Bands: Define bands for the button.

Back color: Define back color for the selected band

Fore color: Define fore color to appear for selected band in run time

Text: Define the text to be displayed for selected band in run time

Visible: Control the visibility

Blink: Select if blink is required when tag value reaches selected band in run time. If yes is selected, then, it allows to enter blink color as well.

Bitmap file: Select the image to be displayed on button when tag value reaches this band in run time.

For example: When Tag1=0, show Red color motor symbol on button.
When Tag1=1, show Green color motor symbol on button.

Note: Two different symbols are required for the above

Bmp, wmf, jpg, gif and png types are supported. If selected file is other than wmf, then, it is also possible to select Image layout and transparent options.

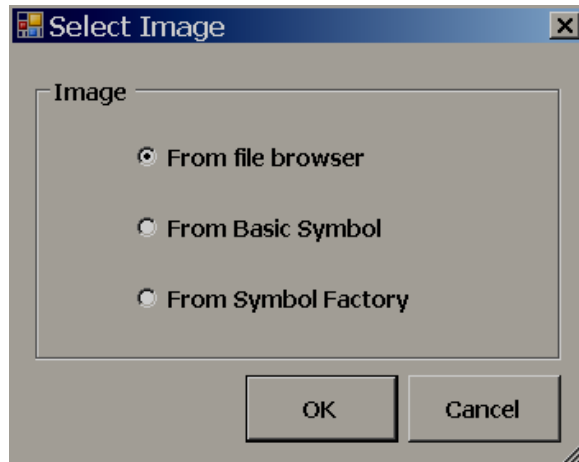

From File browser: It is to select image from required location

From Basic Symbol: It is to select images from free basic symbols (*.wmf format) available in HMI editing software.

From symbol factory: It allows to select symbol from symbol factory in wmf format

Image layout: None, center and Stretch options are available. Stretch means, selected bitmap will be fixed to the size of the button.

Note: If bitmap is with poor resolution, when stretch is used, it may show low quality image in screen.

Flip: It is to flip button and needs to be configured at design time. Available options include None, Horizontal, Vertical and Both.

Rotation: It is to rotate button in predefined angles and need to be configured at design time. Available options include 0° , 90° , 180° and 270°

Value: Define maximum range of selected band. Low range will be value defined at previous band. There is no need to enter any value for band 1 as its value is 0 which is low range.



If button is linked with Digital Tag, then, in the band editor, it shows only two bands for value 0 and 1. When, button is linked with Analog tag, it is possible to configure up to 32 bands for showing different states of button based on value of tag and then, it shows status similar to word lamp.

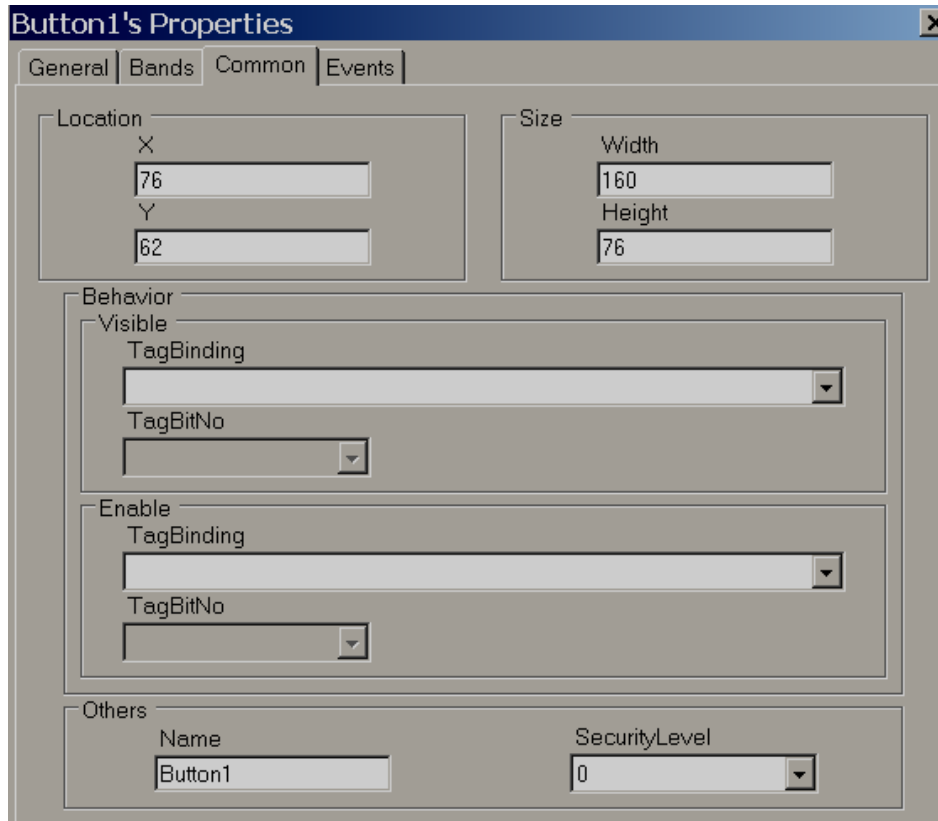

Security control: Define security level for button. It allows user to operate the button only when operator security level is equal to or more than security level defined here.

Please refer section “Security” at Project explorer for more information about security features.

Events

Clicked: Define the action when user presses button in Run time. If required, it is possible to configure holding time for this action.



Holding time is a very useful function. If PLC has a large scan time, some times, operator click action will be not detected by the PLC. In this case, it is possible to have a hold time for click event such that operator action will be continuously present for time defined at holding, such that PLC will receive operator action properly.



Practically once operator touches button and releases finger instantly, it is called as a Clicked action. During this time, a total of three actions will be executed. Click, Pressed and Released



Case-1

Holding time = 0

In above example, Tag1 value becomes 3

Case-2

Holding time = 5000 m sec

In above example, if scan time for Tag1 is 1000 m sec, then, Tag1 value becomes approximately 8.

When, button is clicked, Clicked and Pressed event action occurs and Tag1 value becomes 2. Since holding time is 5 sec, for next 5 seconds, Tag1 value is incremented by 1 for each 1 sec, so, it Tag1 value becomes 7. When button is released, Tag1 value incremented by 1 again, so it becomes 8.

The above example is for illustration only to understand about events for button object.

Pressed: Define the action when user continuously presses on button. If required, it is possible to configure Auto repeat and interval time for this action.



Practically once operator touch button, clicked event will be executed first and when operator keep pressing button continuously, then, pressed action will keep on being executed. When operator releases the finger on button, released action will be executed.

Auto repeat: On, Time interval=1000 m sec. In this case, Tag1 value first increment by 1, then, keep on incrementing by 1 once in 1000 m sec. as long as operator presses the button and increment by 1 when operator releases the button.

Released: Define the action when user release press on button

Switch Function

In this case, it requires using two buttons. One button to turn ON Tag and another button to turn OFF Tag

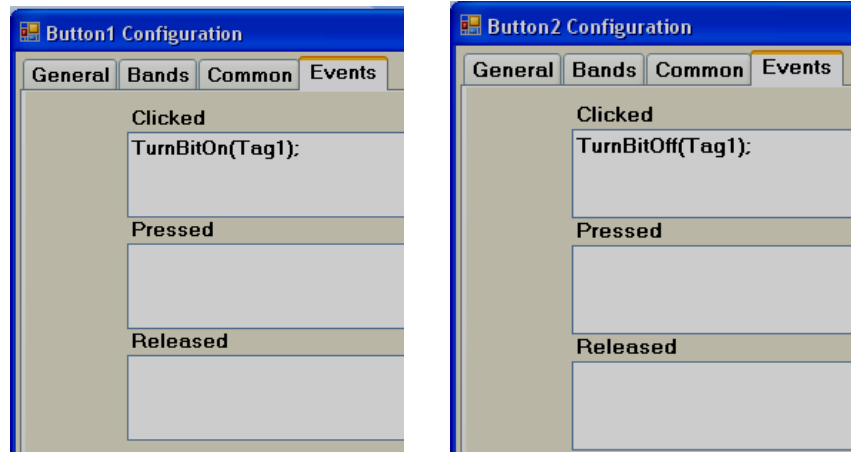

When operator clicks Button1, Tag1 = 1. Now, Tag1 = 1 even after operator releases button and it continues to maintain earlier state. When operator clicks Button2, Tag1 = 0

6.7.1.19 Function editor

This is very useful to select different functions to execute based on operator action or scheduler etc. in Run time and this provides an easy way for application developer to use a ready made macro instead of writing scripts. Insert Button in any HMI screen and configure events. The following functions are supported.

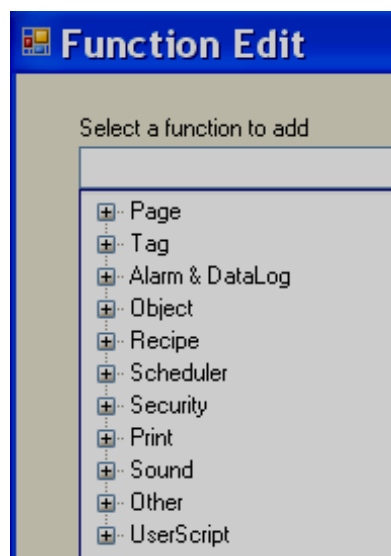

Page Control functions

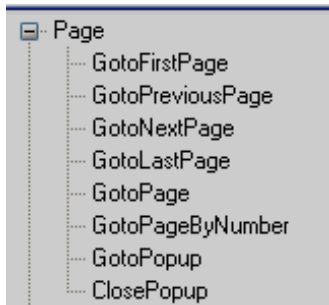

Every screen has a screen number and pointer will be screen number for navigation in.

GotoFirstPage: It is to navigate from current screen to first screen

GotoPreviousPage: It is to navigate from current screen to previous screen

GotoNextPage: It is to navigate from current screen to next screen

GotoLastPage: It is to navigate from current screen to Last screen

GotoPage: It is to navigate from current screen to specific screen by name

GotoPageByNumber: It is to navigate from current screen to specific page by number

GotoPopUp: It is to open specific pop up screen by name

ClosePopUp: It is to close pop up screen by name

Tag functions

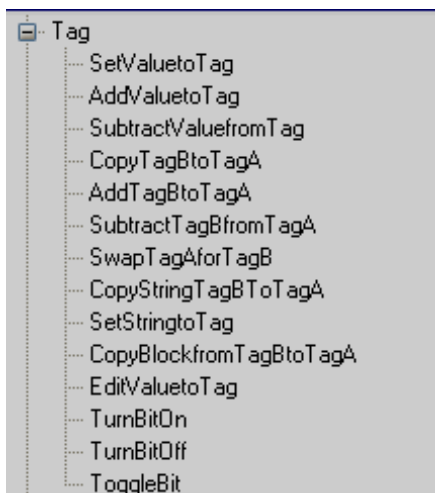

SetValueetoTag: It writes value to a tag

Example: Set 90 to TagA when operator presses on a button in run time

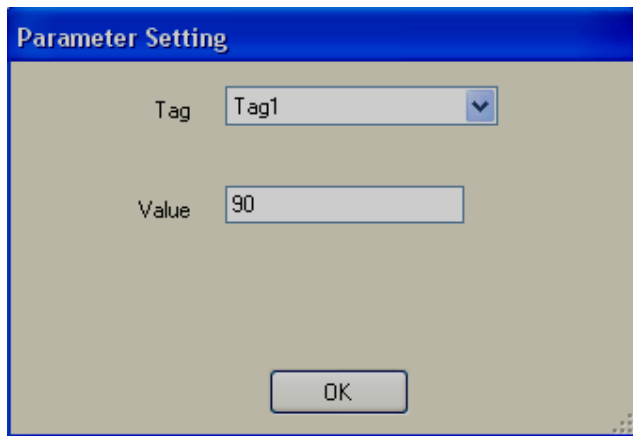

A screenshot of a 'Parameter Setting' dialog box. It has a blue title bar with the text 'Parameter Setting'. The main area is light gray. There are two labels: 'Tag' and 'Value'. The 'Tag' label is next to a dropdown menu showing 'Tag1'. The 'Value' label is next to a text input field containing '90'. At the bottom center, there is an 'OK' button.

AddValueToTag: It is add value to Tag

SubtractValuefromTag: It is to subtract value from Tag

CopyTagBtoTagA: It is to copy TagB value to TagA

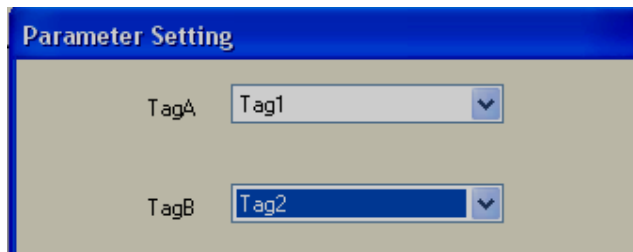

A screenshot of a 'Parameter Setting' dialog box. It has a blue title bar with the text 'Parameter Setting'. The main area is light gray. There are two labels: 'TagA' and 'TagB'. The 'TagA' label is next to a dropdown menu showing 'Tag1'. The 'TagB' label is next to a dropdown menu showing 'Tag2'.

AddTagBtoTagA: It is to add TagB to TagA and store result in TagA

SubtractTagBfromTagA It is to subtract TagB from TagA and store result in TagA

SwapTagAforTagB It is to swap TagB and TagA

CopyStringTagBtoTagA It is to copy string type TagB to TagA

SetStringtoTag: It is to write string to String type Tag

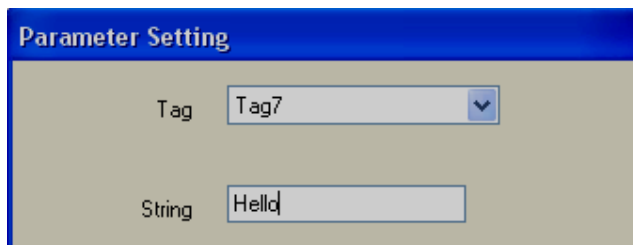

A screenshot of a 'Parameter Setting' dialog box. It has a blue title bar with the text 'Parameter Setting'. The main area is light gray. There are two labels: 'Tag' and 'String'. The 'Tag' label is next to a dropdown menu showing 'Tag7'. The 'String' label is next to a text input field containing 'Hello'.

CopyBlockfrom TagBtoTagA: It is to copy block of tags from TagB to Tag1

For example: Copy 4 continuous tags from Tag5 to target location starting from Tag1. Now, Tag5 is copied to Tag1, Tag6 is copied to Tag2 and so on.

Note: Maximum block size is limited to 80 tags

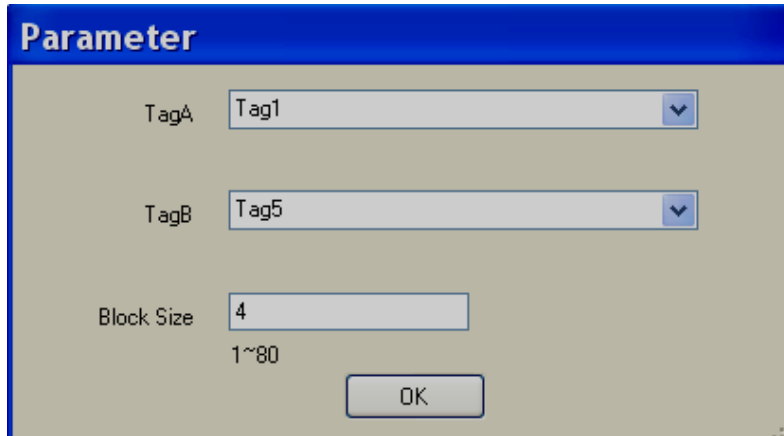

The image shows a dialog box titled "Parameter" with a blue header. It contains three input fields: "TagA" with a dropdown menu showing "Tag1", "TagB" with a dropdown menu showing "Tag5", and "Block Size" with a text input field containing "4". Below the "Block Size" field, the range "1~80" is displayed. An "OK" button is located at the bottom right of the dialog box.

EditValueToTag: It is to edit tag value in run time from keypad. For example, if this function is called from button click event, then, keypad will open in run time and user can enter set point

TurnBitOn: It is to turn on bit.

If momentary Turn on is required, then in "Click" action, select Turn On, then, in "Released" action, select "Turn OFF"

TurnBitOFF: It is to turn off bit

Togglebit: It is to toggle the bit



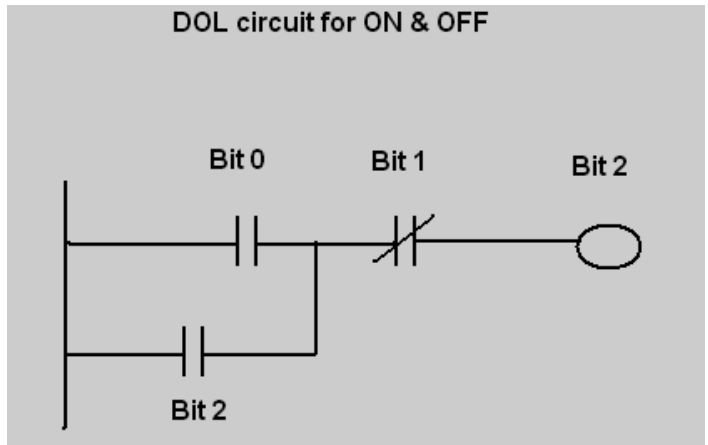

Fig: Ladder logic in PLC

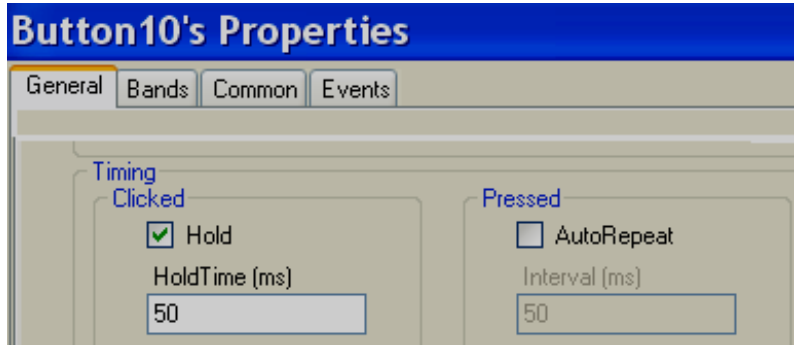
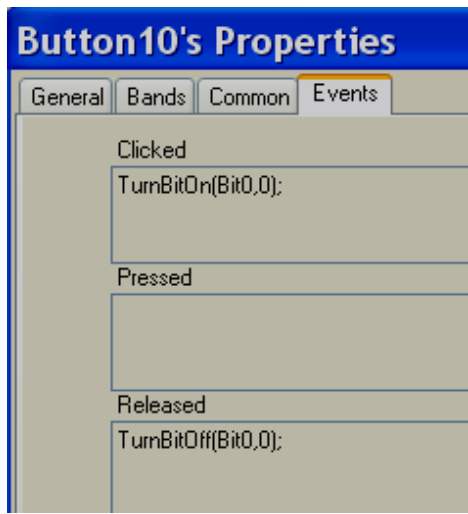

Fig: On button configuration



If button is not switching properly at PLC, then, in General Tab, select "Hold" check box and enter the hold time. Default value is 50 msec. If required, adjust this to 100 msec. and check again.

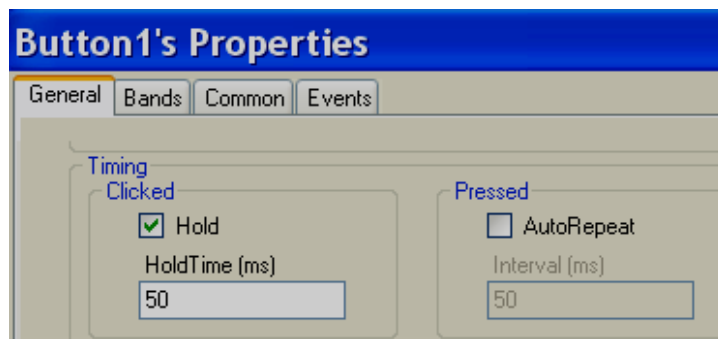
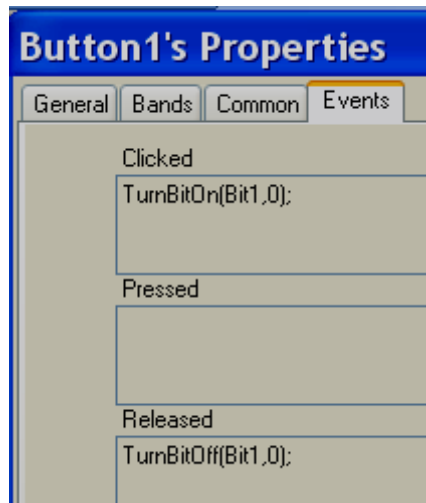
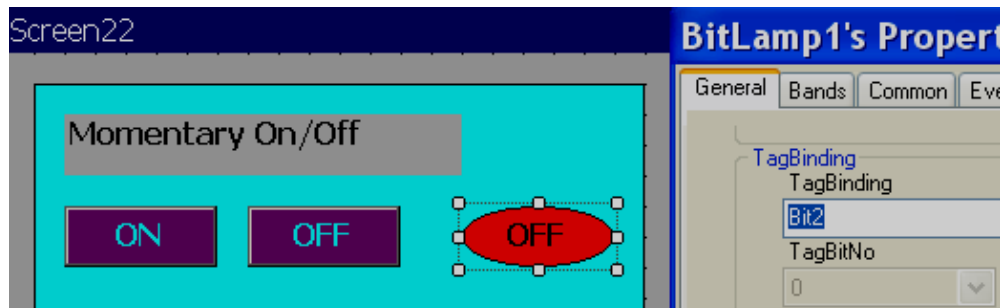

Fig: Off Button configuration



If button is not switching properly at PLC, then, in General Tab, select “Hold” check box and enter the hold time. Default value is 50 msec. If required, adjust this to 100 msec. and check again.



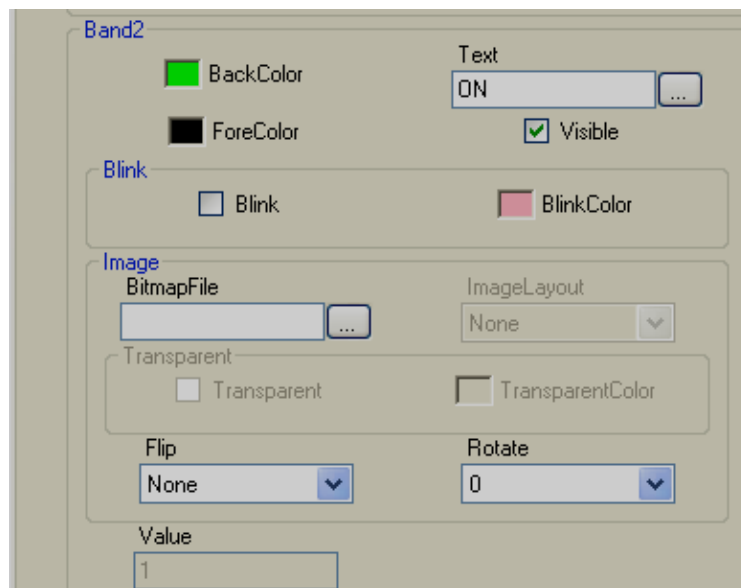
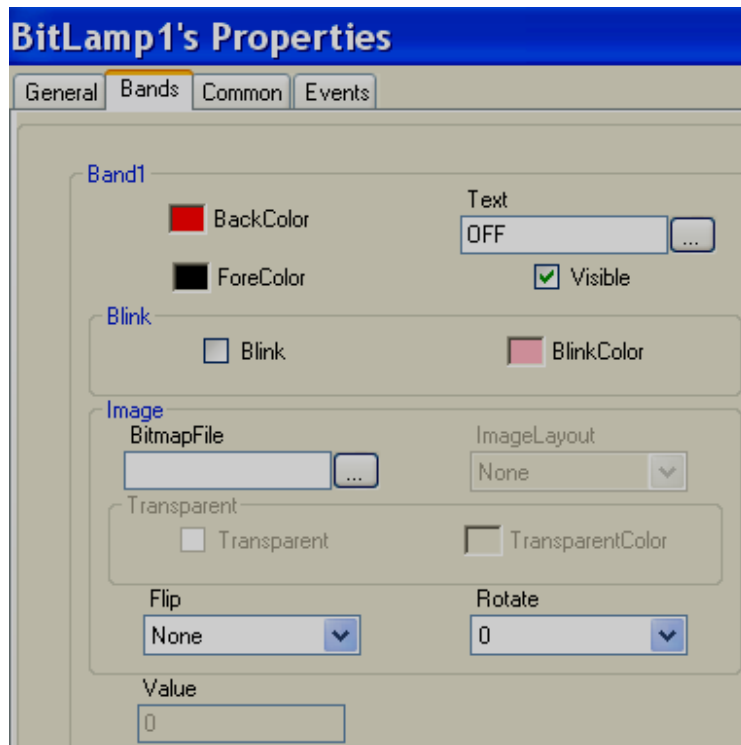
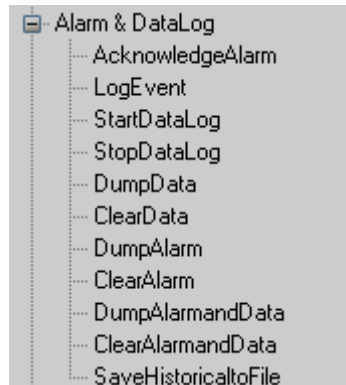

Fig: Bit lamp status

Alarm & Data log functions



Acknowledge alarm: It is to acknowledge alarms

Log Event It is to log event (Historical only)

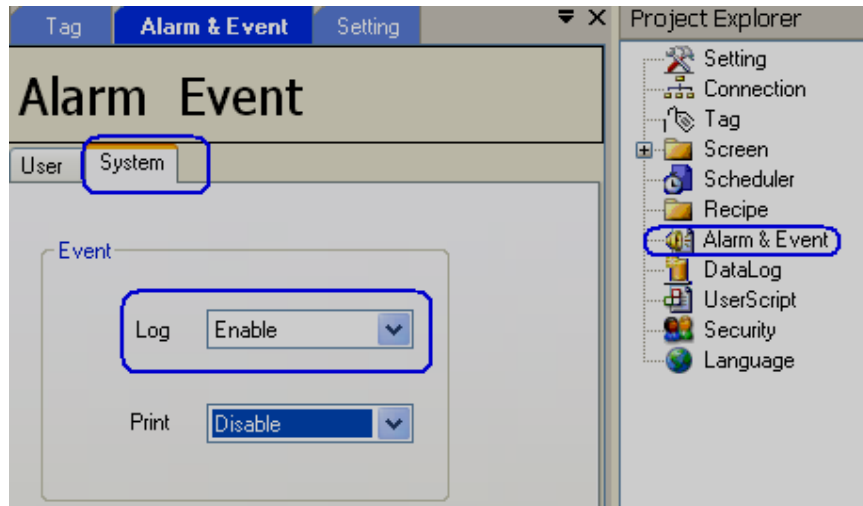

Start Data logging: It is to start data logging

Stop Data logging It is to stop data logging

Dump data: It is to dump historical data from internal memory/SD card to USB memory disk.

Clear data: It is to clear historical data from internal memory/SD card

Dump alarm: It is to dump historical alarms from internal memory/SD card to USB memory disk.

Clear alarm: It is to clear historical alarm from internal memory/SD card.

Dump alarm and data It is to dump data and alarms from internal memory/ SD card to USB stick.

Clear data and alarm: It is to clear data and alarms from internal memory/SD card.



Source of data storage is defined during HMI project configuration time. Available options are internal memory or SD card. SD card is optional in some HMI models.

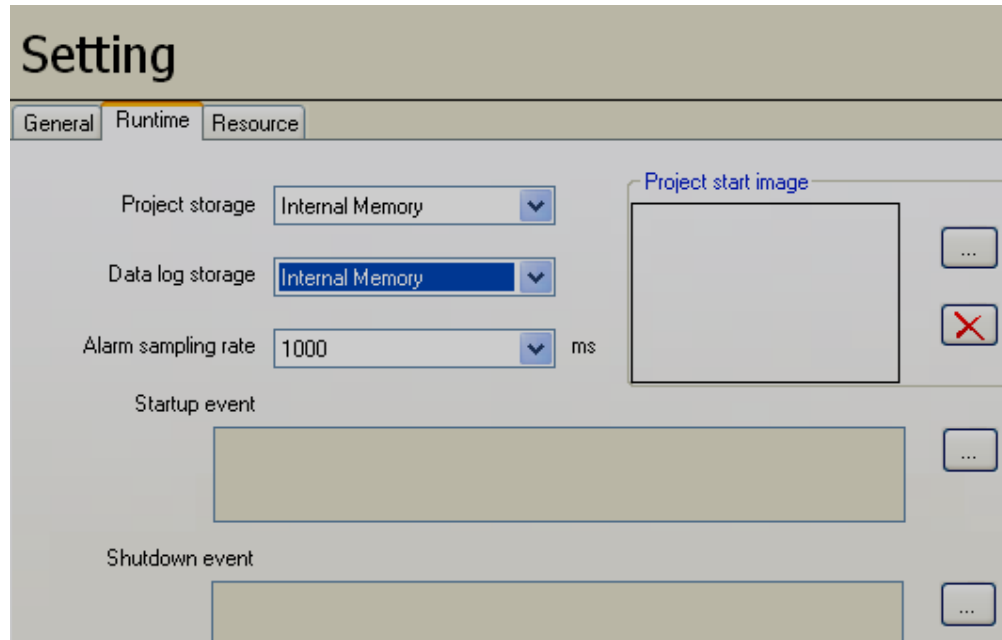

Save Historical to File: Save historical data and alarms directly to USB disk in CSV format in Run time. Two files will be created, one for data and another for alarms/events



Tag should be enabled in Data log configuration for export before using this function

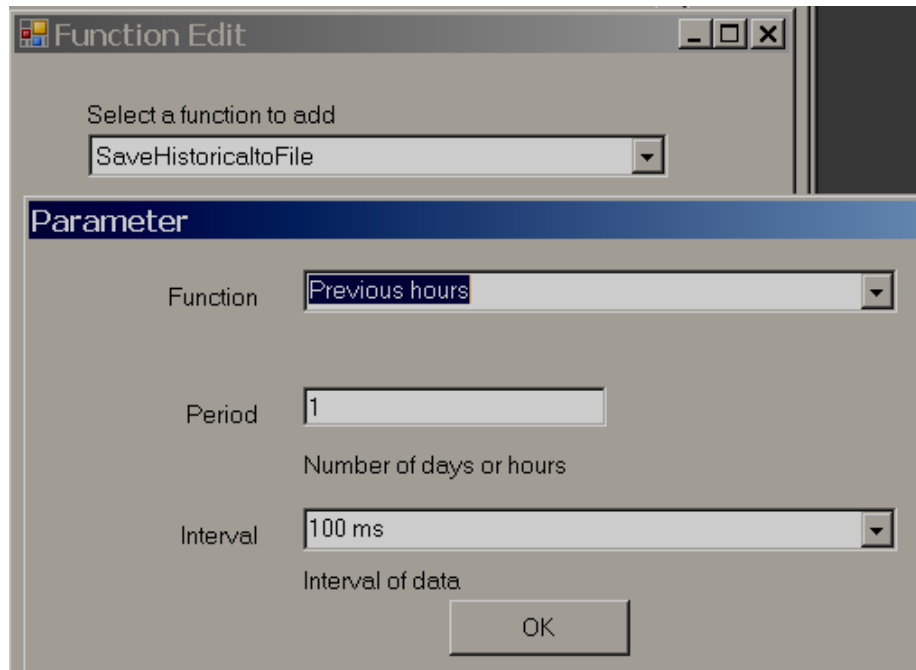
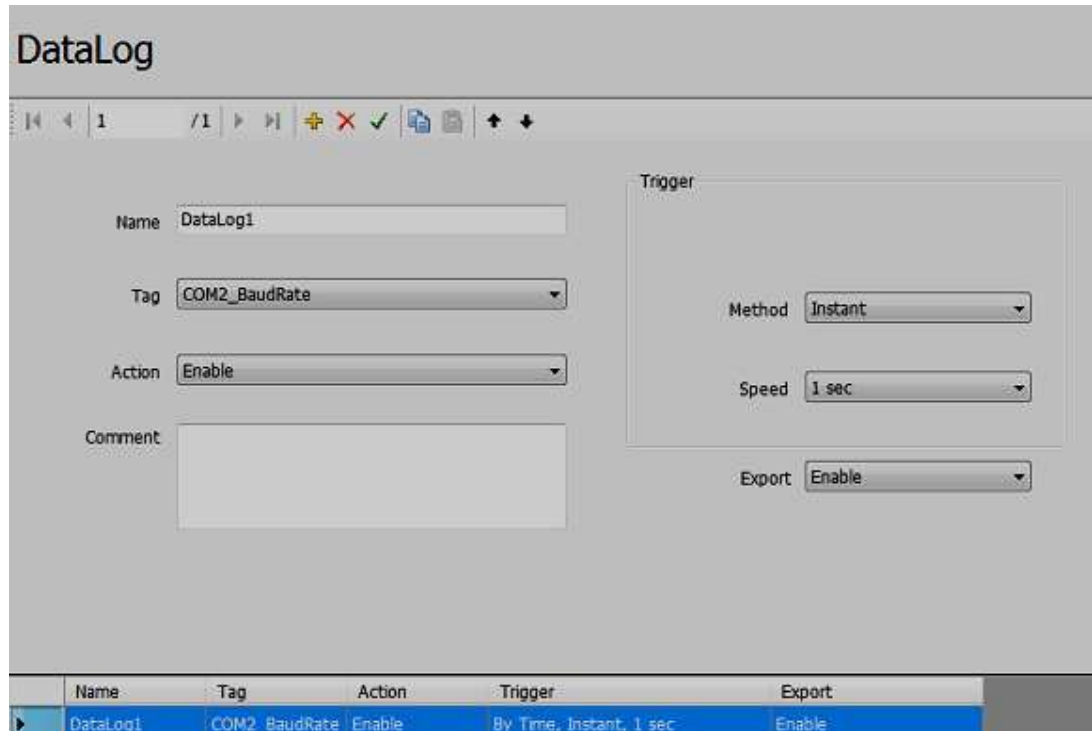

Function:

Previous hours: Design time configuration. Select number of days at period and specify required time interval

Previous days: Design time configuration. Select number of days at period and specify required time interval

User select: Run time selection by user.

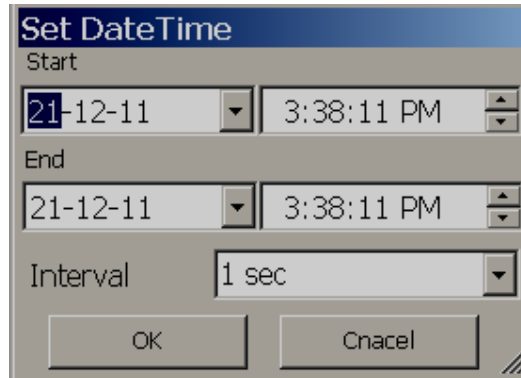

Periods: Number of days or hours

Interval: Available options: 100 msec, 1 sec, 2 sec, 5 sec, 10 sec, 20 sec, 30 sec, 1 min, 5 min and 10 min. First configure data log settings. Then use this function

File name format for data log file : 122111011058_DataLog
Month-Day-Year-Hr-Min-Sec

File name format for event file: 122811110551_Event
Month-Day-Year-Hr-Min-Sec

Each time function is executed, file generated and save to USB disk in above format. If you don't have USB disk fitted at HMI, when you try to execute this function, it will show message "Can not find external storage" in HMI itself

Recipe functions

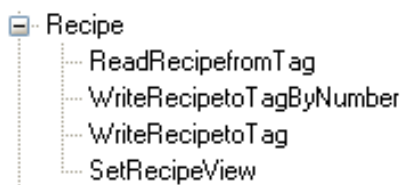

Read Recipe from Tag: Read Recipe from Tag

This function is to read Data from PLC and store as Data Record in HMI and this function can be used in Button event or scheduler

Write Recipe to Tag by number: Write Recipe to Tag by number

This function is to Write Data Record from HMI to PLC with pointer directed to data record number. Please check section "Recipe" at 'Project explorer" for sample application how to transfer 10 data records in sequence via scheduler in Run time automatically. It is possible to select Tag for data record such that if tag value changes in Run time, then corresponding data record will be transferred from HMI to PLC.

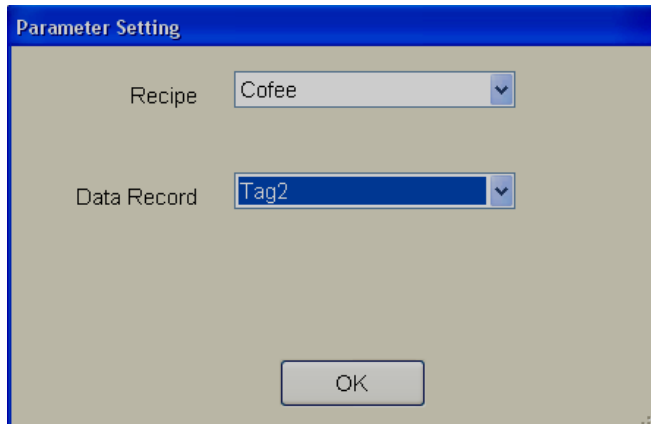

Write Recipe to Tag: Write Recipe to Tag

This function writes specific Data Record of a Recipe from HMI to PLC. This function can be used in Button event or scheduler. Example: Everyday at 10:00 hrs, transfer Data Record 1 in Recipe Coffee from HMI to PLC.

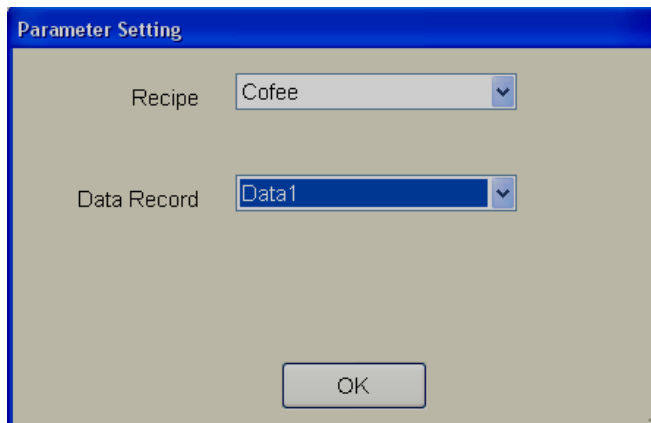
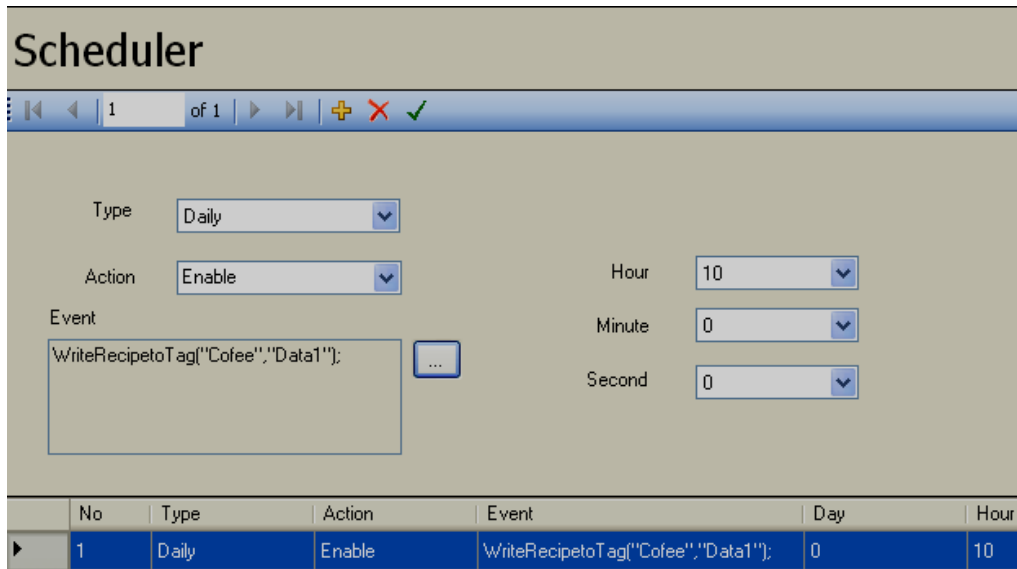

Set Recipe View function

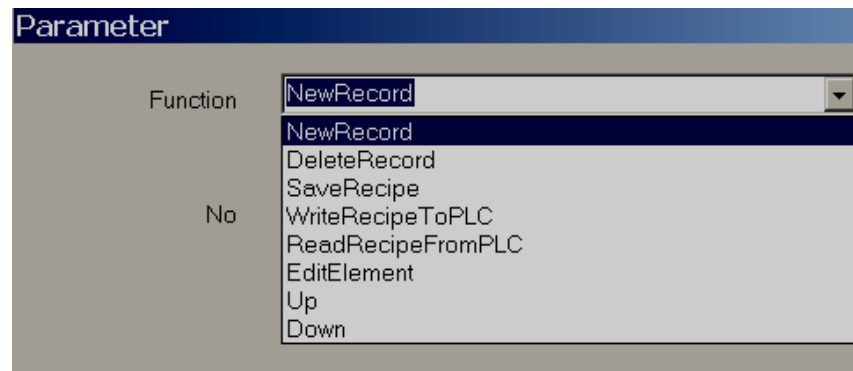
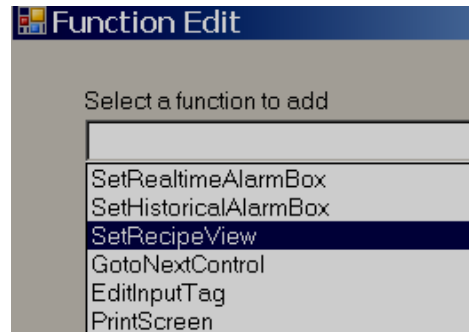

New Record: It is to add a new Record in Run time

Delete Record: It is to delete a Record in Run time

Save Recipe: It is to save Recipe in Run time

Write Recipe to PLC: It is to write Recipe to PLC in Run time

Read Recipe from PLC: It is to read Recipe from PLC in Run time

Edit Element: It is to edit element value at Recipe table in Run time. First select the element and then edit the value

Up: It is to move UP data record in Run Time

Down: It is to move Down data record in Run time

Scheduler functions

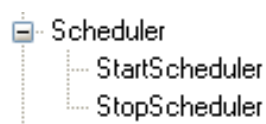

Start Scheduler: It is to start selected scheduler

Stop Scheduler It is to stop selected scheduler

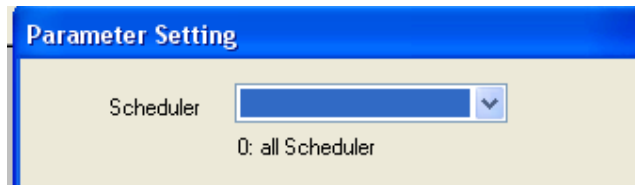

If 0 is selected, it means, select all the schedules

Security functions



Log in/Out: It is to log in and Log out if multiple users are created in design time. Please refer section “Security” for more information about how to Login/Logout functions.

Print Functions

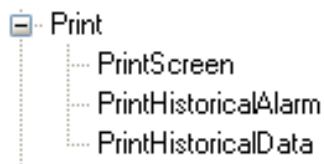

Print Screen: It is to Print current active screen directly from HMI

Print Historical Alarms: It is to Print Historical alarms directly from HMI



Please refer section “Print” for more details about how to configure Printer in HMI from Control Center and then use different features from HMI editing software

Print Historical data It is to print historical data directly from HMI

Log Event It is to print single event from printer supporting ESCP language

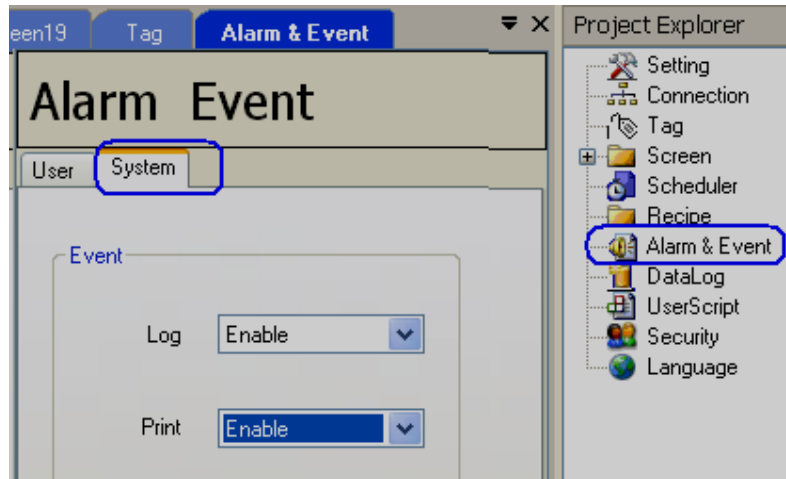

Note: By default "Print"= Disable

Select "Print=Enable" in case if line print is required from ESCP printer (Not USB based PCL, page printer)

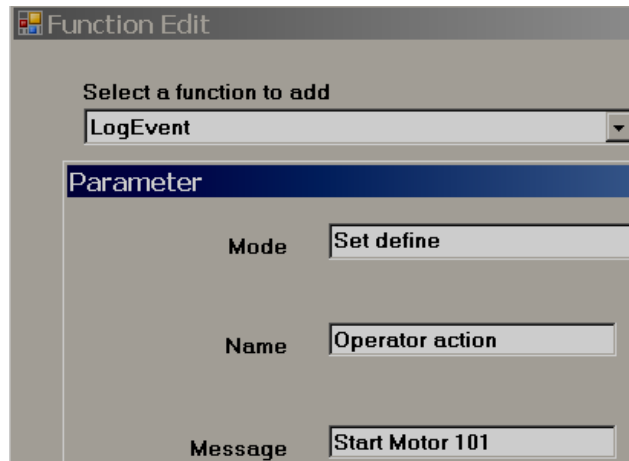

Mode: Set define/ User input

Set define: Define Name and Message in design time

User input: Enter user input at Run time

Audio functions

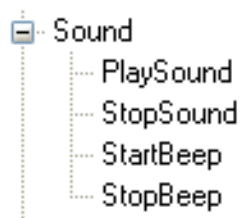

Play sound: It is to play audio file from external speaker. It supports .wav format files.

Options: Define the options how play the audio file. Available options include one time and loop.

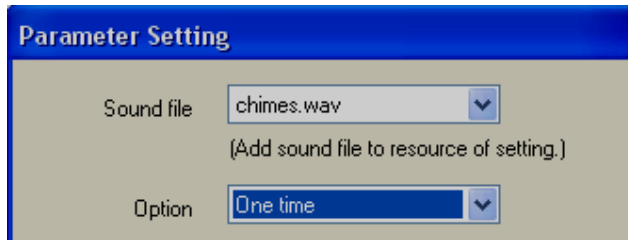

Stop sound It is to stop all the audio files.

Example

If Tag1 > 10, play Audio file1 once

If Tag > 20, play audio file2 in a loop

When operator press "Stop sound" button, then, stop the sound

First, you may search different audio files available in your PC.

In HMI editing software, in Project explorer, click on "Setting" and then add the required .wav audio files.

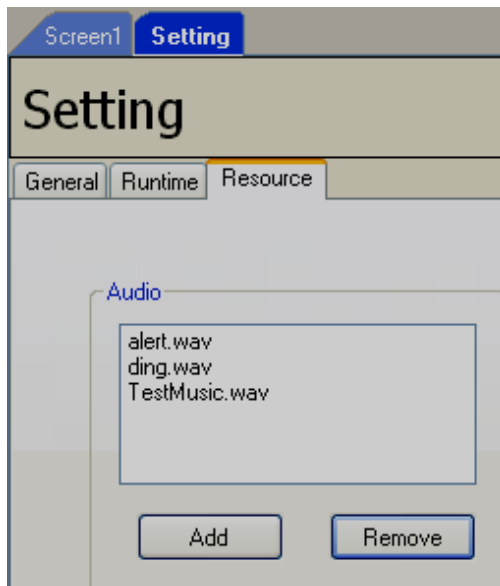

Then, in Events, configure them as shown

Screen1 Tags DataLogs **Alarms & Events** Setting

Alarm & Event

2 of 2

Tag: Tag1

Group: 1

Setpoint Mode: Constant

Value: 90

Decimal: 2

Hysteresis: 0

Type: HiHi

Message:

Log: Log Alarm

Event: PlaySound("alert.wav","Loop");

No	Tag	Type	Log	SetPoint	Group	Event	Hysteresis
1	Tag1	Hi	Log Alarm	80	1	PlaySound("alert.wav","One time");	0
2	Tag1	HiHi	Log Alarm	90	1	PlaySound("alert.wav","Loop");	0

Start Beep: Start Beep sound. This is very small sound generated from HMI internal beeper which is already linked with operator actions like press Button etc. This can be added for alarm event as shown below

User System

Alarm Event

1 / 2

Tag: Tag1

Group: 1

Type: Hi

Message:

Log: Alarm

Print: Disable

Event: StartBeep();

No	Tag	Type	Log	Setpoint	Group	Event
1	Tag1	Hi	Alarm	1	1	StartBeep();
2	Tag1	Lo	Alarm	0	1	StopBeep();

Stop Beep: Stop Beep sound

Others

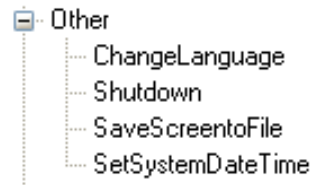

ChangeLanguage: It is to change language for the end user.
Ex: Change language by a click event from a button

Shutdown It is to shutdown HMI

Save Screen to File: It is to save HMI screen in JPEG format to USB disk

Set System date and time: It is to set HMI date and time in HMI at run time. It is also possible to set date and time in HMI on Power on from start up screen.

Object

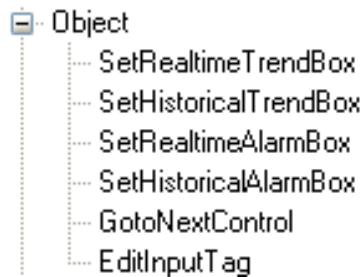

Real time trend control functions

Function name: Set Real Time Trend Box

Clear: It is to clear the data in run time

Historical trend control functions

Function name: Set Historical Trend Box

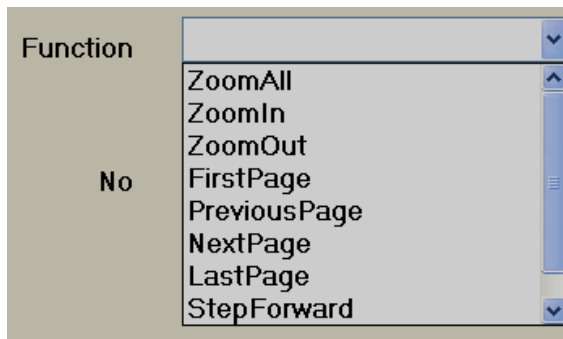
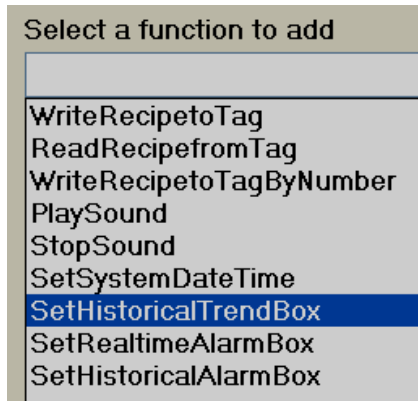

Zoom in/out/All: It is zoom functions

First page It is to move historical trend to first page

Previous page It is to move historical trend to previous page

Next page It is to move historical trend to next page

Last page It is to move historical trend to last page

Step forward It is to move a step forward.

Step backward It is to move a step backward

Set Zoom Rate: It is to select zoom rate in run time. It is possible to select one of the below options 100 msec/dot, 1 sec/dot, 5 sec/dot, 10 sec/dot, 20 sec/dot, 30 sec/dot, 1 min/dot, 5 min/dot, 10 min/dot, 10 min/page, 30 min/page, 1 hr/page, 2 hr/page, 4 hr/page, 8 hr/page & 1 day/page

Search by Time It is to search data with respect to time in run time

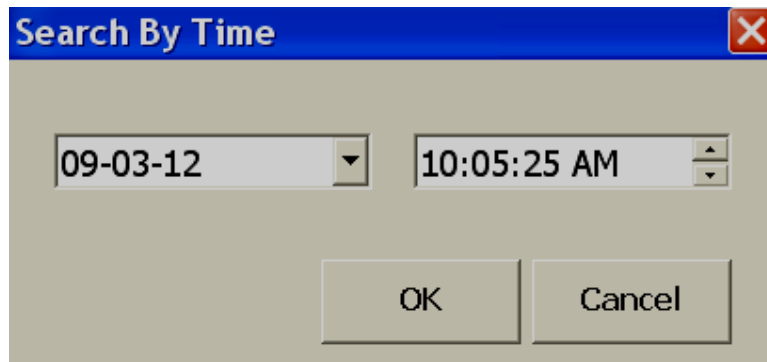

Real time alarm functions

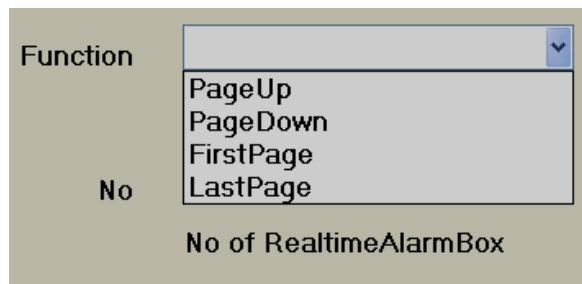
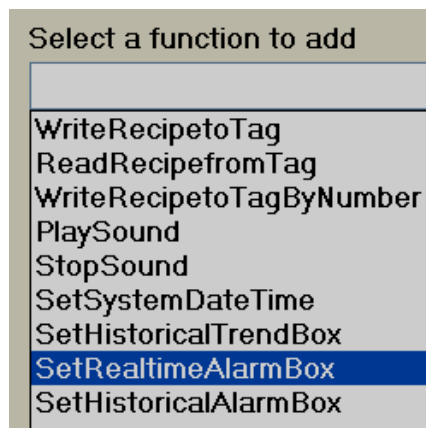

First page It is to move pointer to first page of alarms.

Last page It is to move pointer to last page of alarms.

Page Up: It is to move pointer to previous alarm.

Page Down: It is to move pointer from one alarm down to next alarm.

Historical alarm functions

First page It is to move pointer to first page of alarms.

Last page It is to move pointer to last page of alarms.

Page Up: It is to move pointer to previous alarm.

Page Down: It is to move pointer from one alarm down to next alarm.

Update Historical: It is to refresh historical alarms in Historical alarm box. For Example: You may create a task from Scheduler to refresh historical alarms display once in 5 minutes.

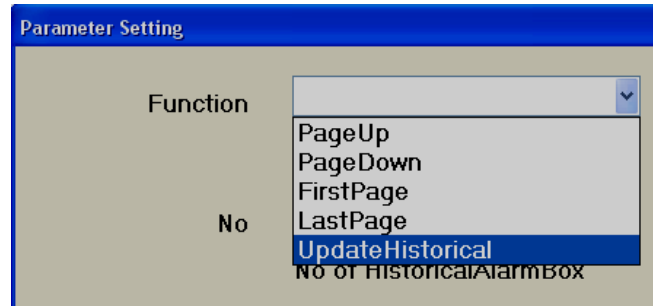

GotoNextControl: It is to move control to next object based on tab index setting. Some objects like Text box, Numeric Up and Down support Tab index function where priority sequence can be configured and move accordingly in run time. This is similar to Tab key in computer keyboard

EditInputTag: It is edit tag value in Data entry objects like Textbox etc.. in run time from a custom designed keyboard. This is closely used with system tag "InputTag" and system function "GotoNextControl". For example, it is possible to design custom designed keypad for numeric entry, display this keypad all the time in screen for the operator. Assume, you have 5 text boxes and all of them are used to send Set points from HMI to PLC. Now, EditInputTag will act like a buffer to get numeric values from Keypad and then transfer them to specific text boxes after pressing "Enter" key in custom keyboard, then control pointer automatically navigated to next Set point entry as per Tab index value defined during configuration

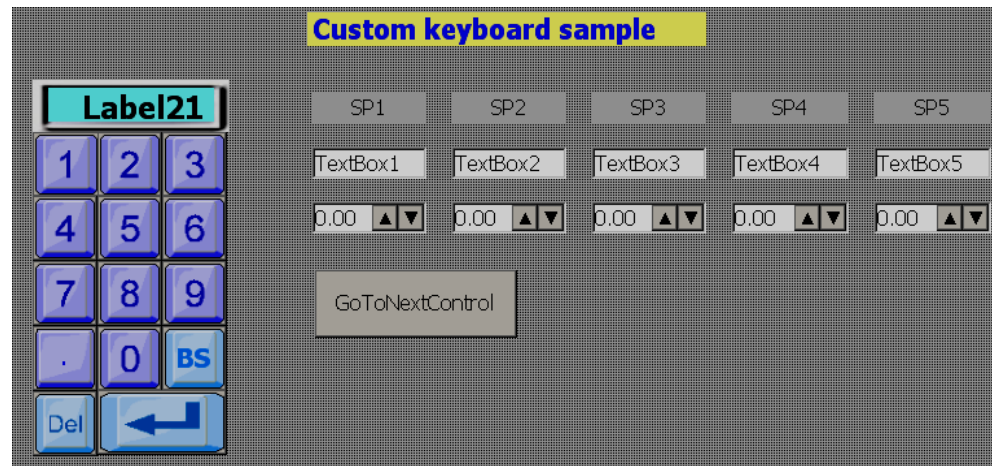

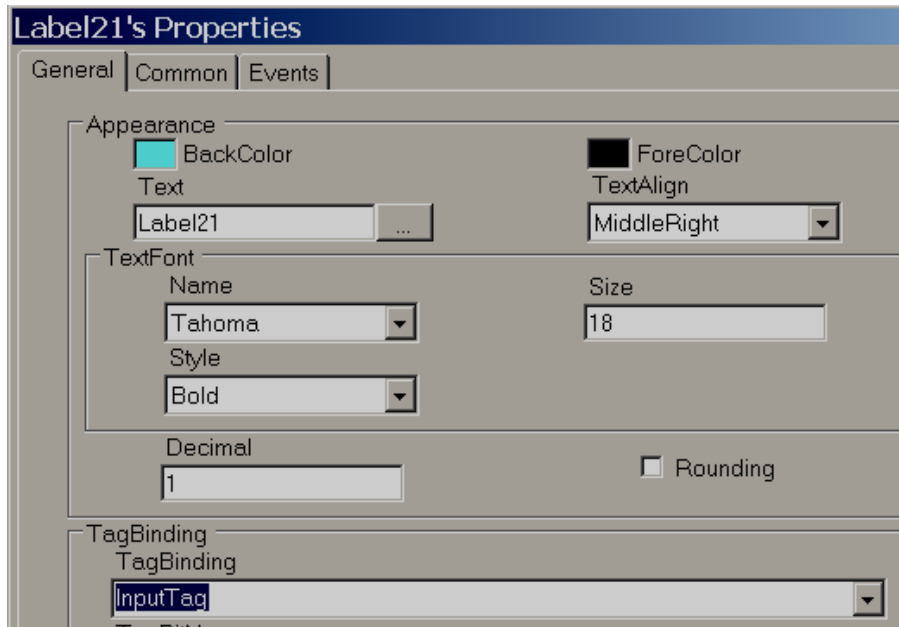
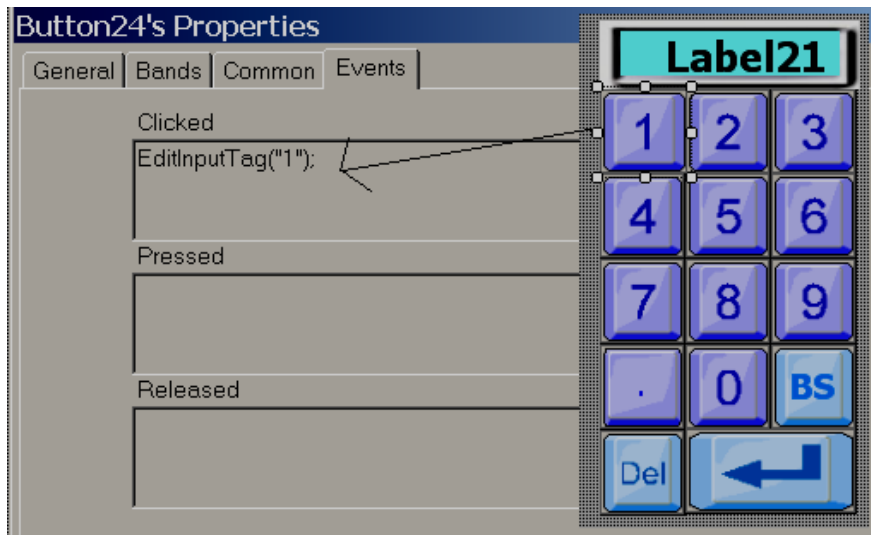
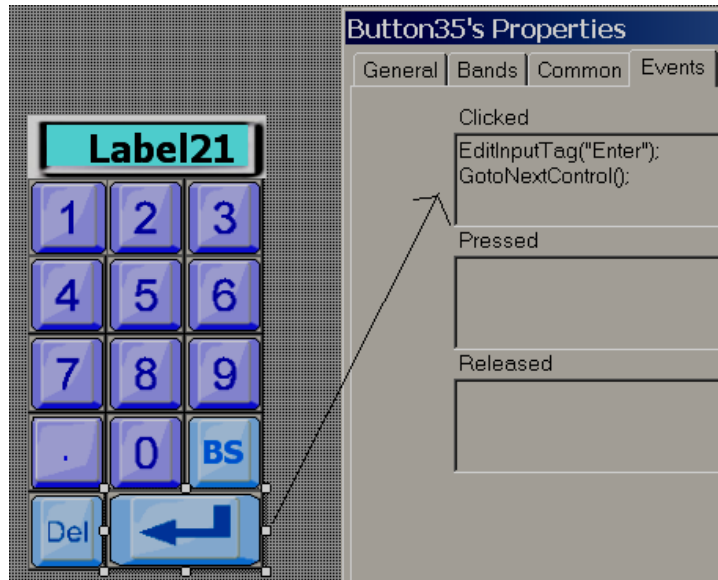

Fig: Label 21 is linked with system tag 'InputTag', it's buffer for keypad entries





For example, in this application, if cursor is first located at Textbox1 in run time, then, if operator enter value 123 from keypad and press “Enter” softkey, the value available at InputTag buffer will be moved to Textbox1 and then cursor will move to next Textbox as per Tab index value

6.7.1.20 Bit lamp

It is used to show Digital input status for operator. It is linked with either Digital input type tag or Analog input type tag. By using band editor, it is possible to display different foreground color, different background color, different text, different symbols, different Blink color, and control visibility when Tag value is 0 or 1.

When Bit lamp is linked with Digital type Tag, it has only two bands, by default, Band1 value is 0 and Band 2 value is 1.

For example: If Tag1 = 0, show Red color back ground with Orchid color blink. If Tag9=1, show green color back ground.



GUI Wizard

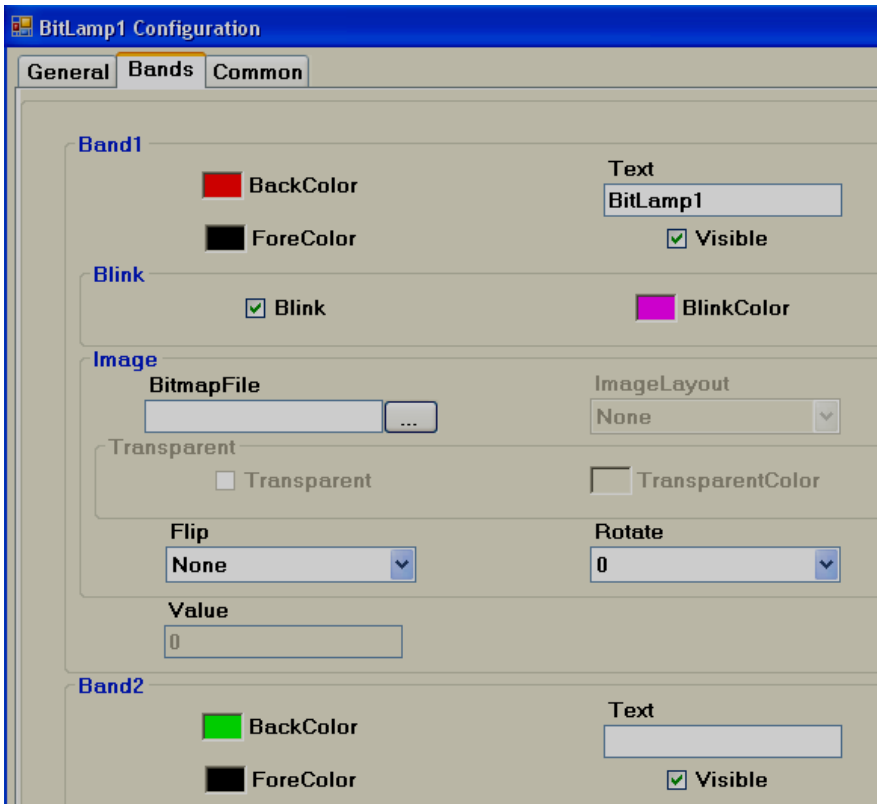
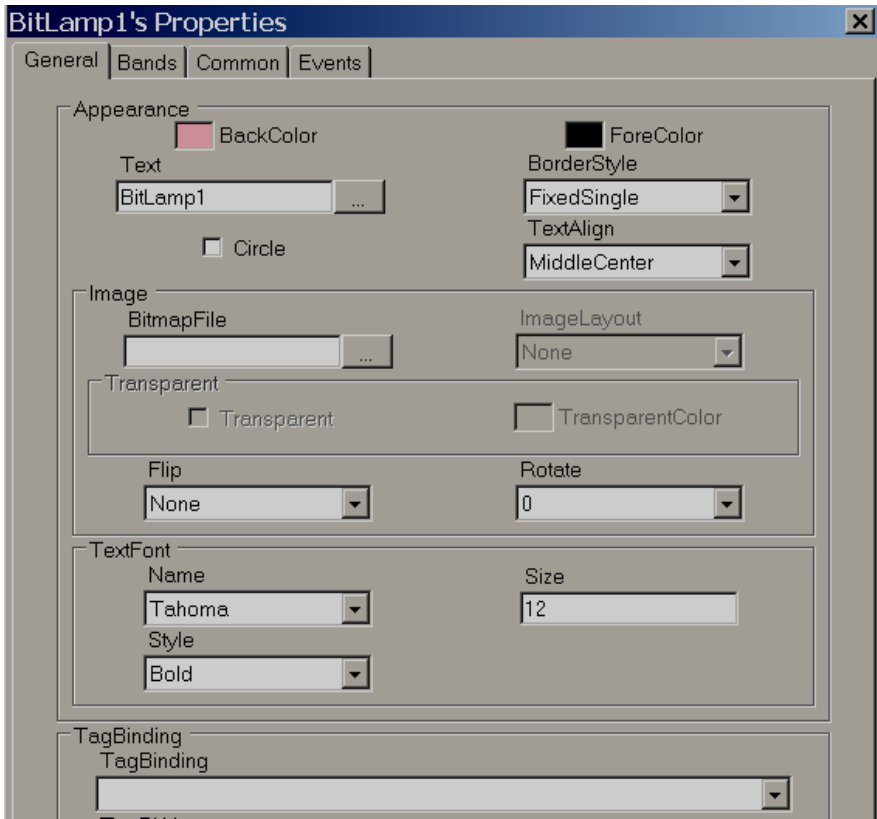

Bitmap file: Select the image to be displayed when tag value reaches this band in run time.

For example: When Tag1=0, show Red color motor symbol
When Tag1=1, show Green color motor symbol

Note: Two different symbols are required for the above

Bmp, wmf, jpg, gif and png types are supported. If selected file is other than wmf, then, it is also possible to select Image layout and transparent options.

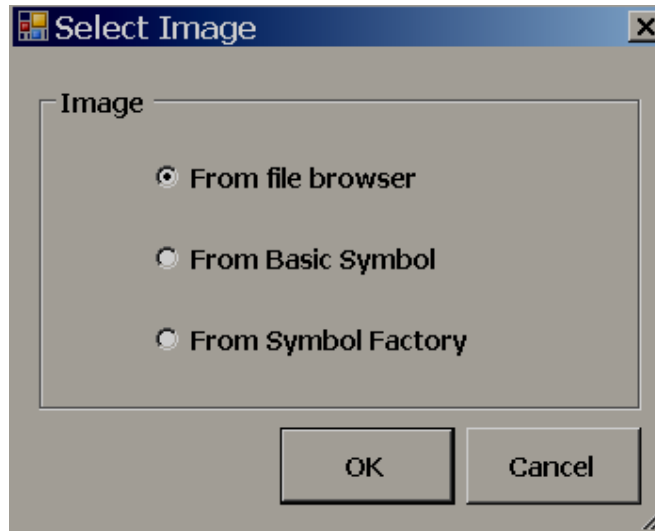

From File browser: Allows to select images in formats of bmp, wmf, jpg, gif and png

From Basic Symbol: Allows to select wmf format images from basic symbols

From symbol factory: It allows selecting symbol from symbol factory in wmf format

Image layout: None, center and Stretch options are available. Stretch means, selected bitmap will be fixed to the size of the bit lamp

Note: If bitmap is with poor resolution, when stretch is used, it may show low quality image in screen.

Flip: It is to flip bit lamp and needs to be configured at design time. Available options include None, Horizontal, Vertical and Both.

Rotation: It is to rotate bit lamp in predefined angles and need to be configured at design time. Available options include 0° , 90° , 180° and 270°

Circle: By default, bit lamp object shape is in Rectangle. Select this if you wish to change shape to circle. It is more useful to show status of digital inputs for the operator in Run time

How to show status of individual bit in Analog type tag

Some times, you will get 16 bit/32 bit tag from PLC with different diagnostic information and you would like to show 16 bit/32 bit lamps in HMI screen.

When Bit lamp is linked with Analog tag example: Int16/Int32, then also it has two bands, by default, Band1 value is 0 and Band 2 value is 1. In this case, using each bit lamp, it is possible to show status of each individual bit status with in 32 bits as per configuration available at band editor.

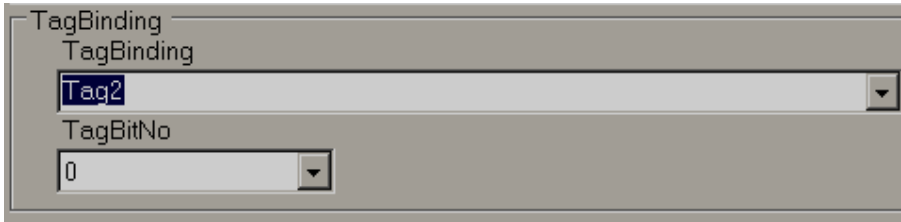

In above fig, Tag2 is analog type (4 byte), so, TagBitNo combo box will appear for selection of required bit with in 32 bits (0 to 31).

If Tag2 is Digital type tag, then, TagBitNo. Combo box is not visible.

6.7.1.21 Word lamp

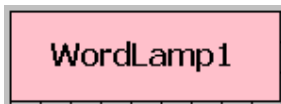

It is similar to Bit lamp but linked with Analog type tag only. It can have many bands. By using band editor, it is possible to display different foreground color, different background color, different text, different symbols, different Blink color, and control visibility when Tag value change values in Run Time.

For example: Tank Level indicator

When Tag1 value is

0 to 10, Text = Low Low Level, Color = Yellow Blinking

11 to 20, Text = Low Level, Color = Yellow Background

21 to 80, Text = Normal, Color = Green back ground

81 to 90, Text = High level, Color = Red back ground

91 to 100, Text = High High Level, Color = Red blinking

Create 5 bands as shown

GUI Wizard/Dialog

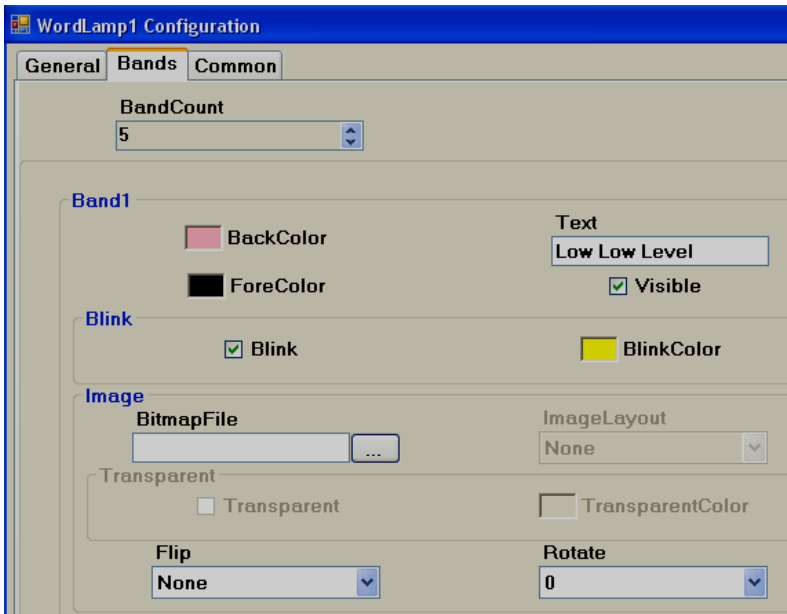
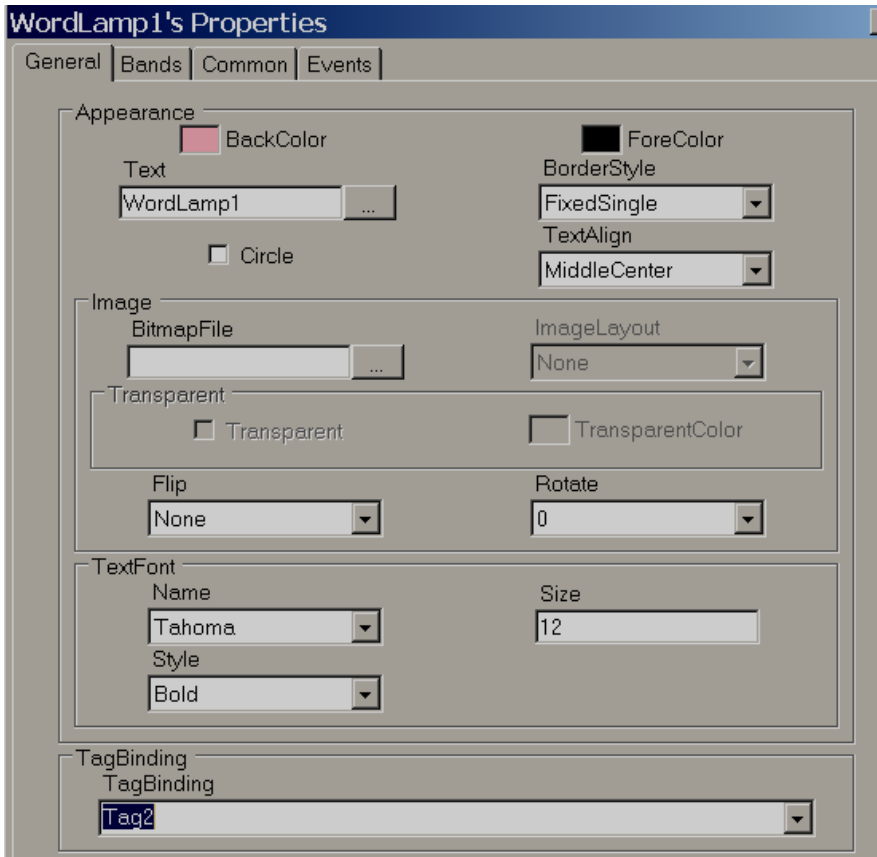

Band1 range = 0 to value defined at band2-1.
 i.e., 0 to 10

Band2

BackColor

ForeColor

Text:

Visible

Blink

Blink

BlinkColor

Image

BitmapFile: ...

ImageLayout: ▾

Transparent

Transparent

TransparentColor

Flip: ▾

Rotate: ▾

Value:

Band2 range: Band 2 value to Band3 value-1
i.e., 11 to 20

Band3

BackColor

ForeColor

Text:

Visible

Blink

Blink

BlinkColor

Image

BitmapFile: ...

ImageLayout: ▾

Transparent

Transparent

TransparentColor

Flip: ▾

Rotate: ▾

Value:

Band3 range: Band 3 value to Band4 value-1
i.e., 21 to 80

Band4

BackColor Text
 ForeColor High Level

Visible

Blink

Blink BlinkColor

Image

BitmapFile ImageLayout
 ... None

Transparent

Transparent TransparentColor

Flip Rotate
 None 0

Value
 81

Band4 range: Band 4 value to Band5 value-1
 i.e., 81 to 90

Band5

BackColor Text
 ForeColor High High Level

Visible

Blink

Blink BlinkColor

Image

BitmapFile ImageLayout
 ... None

Transparent

Transparent TransparentColor

Flip Rotate
 None 0

Value
 91

Band5 range: More than or equal to value defined at band 5 (In this case number of bands=5)
 i.e., greater than 91

6.7.1.22 Check Box

Check box (or tick box) is a graphical user interface widget that permits user to make multiple selections from a number of options in run time. Generally it is linked with Digital type tag Flag/Bit memory in PLC for using them in ladder programming to receive action from operator.

CheckBox

Every check box is linked with single **Digital** tag from properties.

In above white box, normally,
White space means Not selected, False, Tag Value = 0
Tick mark means, True, Tag value = 1

A caption describing the meaning of the check box is normally shown adjacent to the check box. Inverting the state of a check box is done by touching with a finger or clicking the mouse on the box, or the caption.

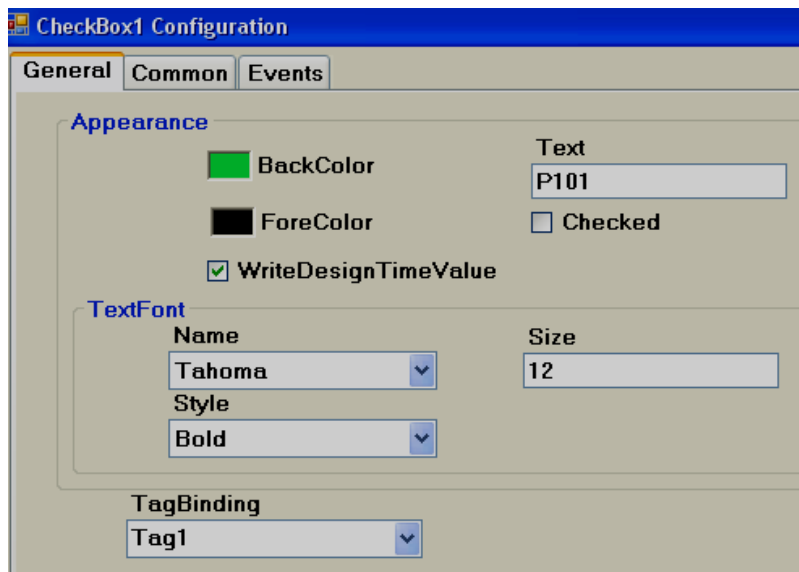
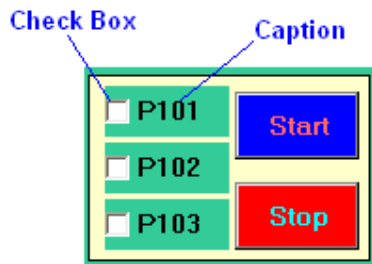

Properties

Write design time value: If selected, it over writes the default value defined at tag data base.

Checked: Default setting, available options True/False

For example: Tag1 is linked with Checkbox 1. If Checked = False, that means Tag1=0, if Checked = true, then Tag1 = 1.

Text: It is Text appears near Check box as caption. Example: Text = P101

Events

Changed: Define action using function editor. When operator presses on check box in Run time, the actions defined here will be executed.

Example: There are three pumps by name P101, P102 and P103 and operator may wish to select pump P101 for start up. Then, use check box, write a meaningful caption via property "TEXT" to appear at right side of check box, and link each of above check box with appropriate Tags say P101, P102 and P103.

Then, when P101 is selected by operator in run time, P101 Tag value will become 1.



If checked = false is selected in design time, then, normally, Tag value = 0. If operator presses on check box in Run time, then symbol ✓ appears and Tag value becomes 1.

If checked = True is selected in design time, then, normally, Tag value = 1 and it appears ✓ in Run time. If operator presses on check box in design time, then symbol ✓ disappears and Tag value becomes 0.



If you are unable to select the required selection using check box in Run time, please perform touch screen calibration once.



If Check box is linked with Analog type Tag, then, it is possible to select individual bit.

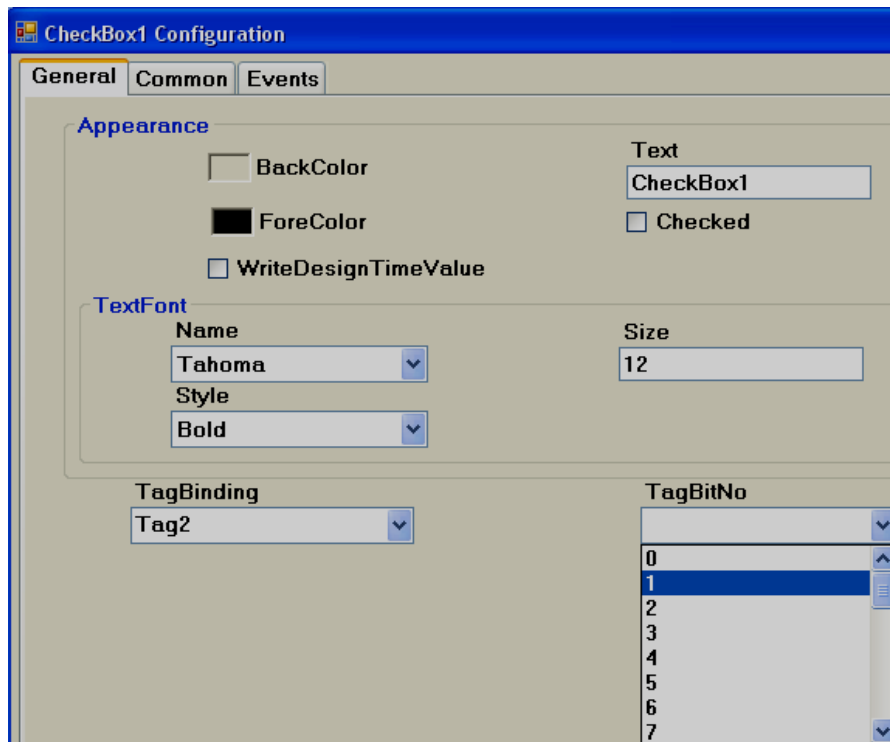

6.7.1.23 Combo box



A combo box is a commonly-used graphical user interface widget. It is a combination of a drop-down list or list box and a single-line textbox, allowing the user to choose from the list of existing options in Run time. Generally it is linked with Analog tag. Based on selection, value of tag will be changed and it can be used in Logic at PLC.

It saves space in HMI screen by allowing operator to select the option only when it is required by touching at the down arrow at right side of Combo box.

Every Combo box is linked with single **Analog** tag from properties.

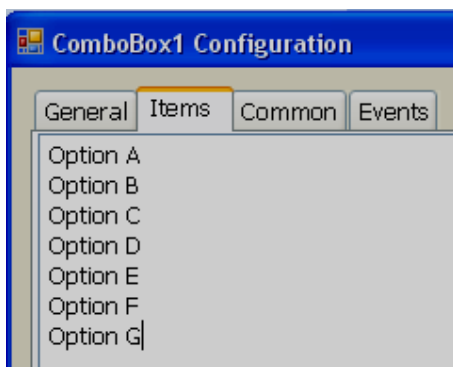
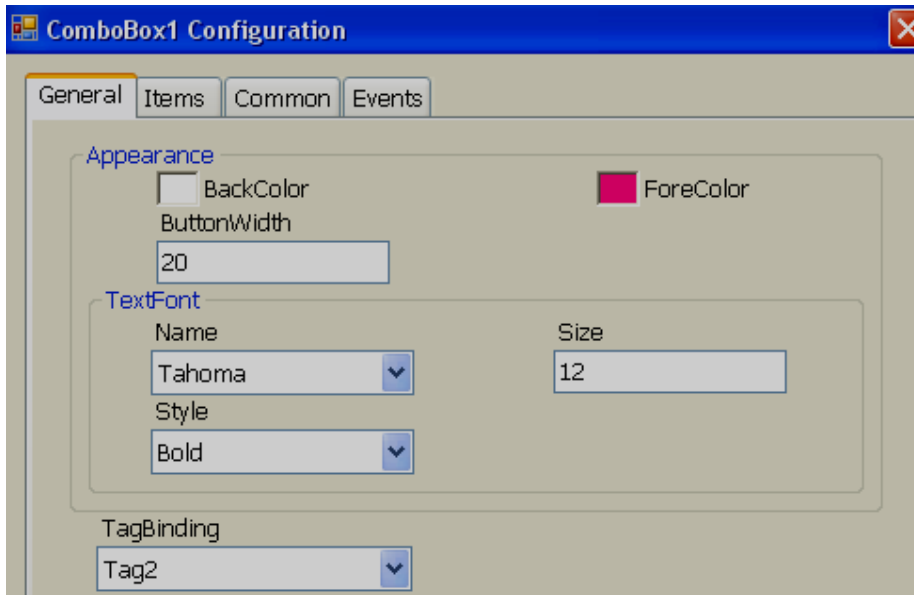

Note: Do not keep any empty space between different text entries, other wise, unpredictable results may appear

Property grid

Appearance	
BackColor	<input type="checkbox"/> White
ButtonWidth	20
ForeColor	<input type="checkbox"/> ControlText
TextFont	Tahoma,12,Bold
Behavior	
Visible	True
Data	
Items	(Collection)
TagBinding	Tag10

Write List of Options in Design time

Option A
Option B
Option C
Option D
Option E
Option F
Option G

Design	
(Name)	ComboBox1
Locked	False
SecurityLevel	0
Events	
Changed	
Layout	
Dock	None
Location	128, 96
Size	224, 24

Properties

Button Width: Define width of Button. It modifies width of down arrow at right side of combo button.

Items: Define all the available options in design time.

For example: There are 7 options available to select a process.

Tag1, Analog type of Tag is linked to Combo box1

Now, If Option A is selected, then in Run time, Tag1 value = 0

If Option B is selected, then Tag1 value = 1

.....

.....

If Option G is selected, then Tag1 value = 6

Events

Changed: Define action using function editor. When operator presses on combo box in Run time, the actions defined here will be executed.



To increase up/down arrow size on combo box, then, increase size of text font.

6.7.1.24 List box



A list box is a Graphical User Interface widget that allows the user to select single item from a list of available items. The available options are entered during Design time and they are available for selection at Run Time. On selection, it writes value to a Tag based on the order number.

Every List Box should be linked with **Analog** Tag.

GUI Wizard/dialog

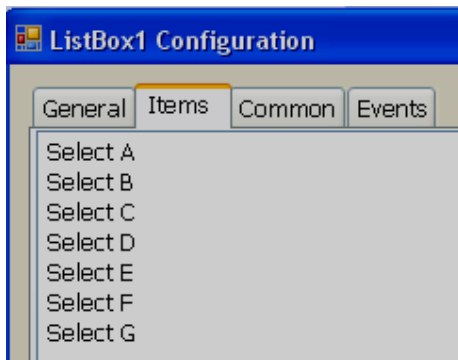

Note: Do not keep any empty space between different text entries, other wise, unpredictable results may appear

Property Grid

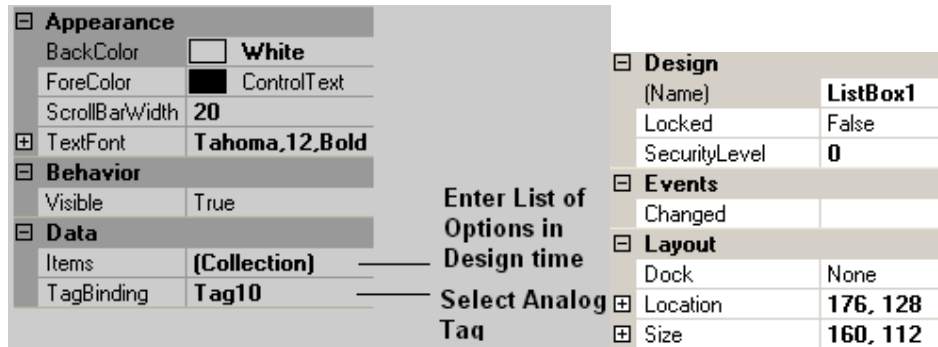

Properties

Scroll Bar Width: Define width of scroll bar appears on Right side of List box.

Items: Define all the available options in design time.

For example: There are 6 options available to select a process.

Tag1, Analog type of Tag is linked to List box1

Now, If Select A is selected, then Tag1 value = 0

If Select B is selected, then Tag1 value = 1

.....

.....

If Option G is selected, then Tag1 value = 5

Events

Changed: Define action using function editor. When operator presses on list box item in Run time, the actions defined here will be executed.

6.7.1.25 Recipe View

Please refer section Recipe (Project explorer) for detailed information about Recipe View.

Recipe viewer is used in Run time to select Recipe, Data Record and transfer Data Record from HMI to PLC manually. It is also used to add new data records, save new data records, delete data records and modify data records in Run time.

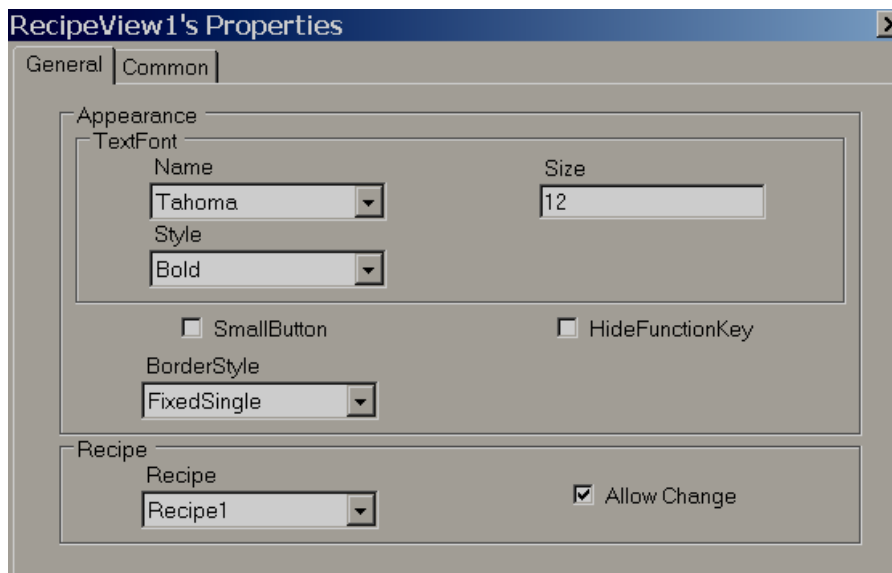
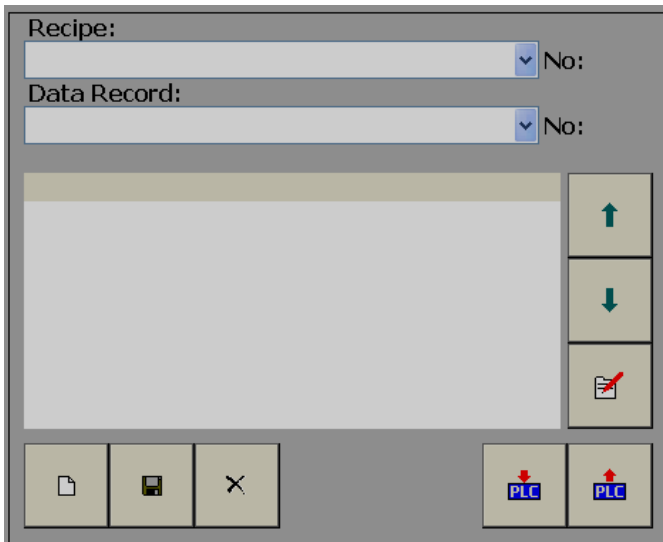

SmallButton Select this option to change all soft buttons to small size and this is most useful while using Recipe object in HMI 4.3”

HideFunctionKey From V1.20 onwards, it is possible to hide the soft buttons on Recipe object by selecting this option in General Tab. All the Recipe functions are now added in function editor and you can execute them from simple button object as per project requirement.

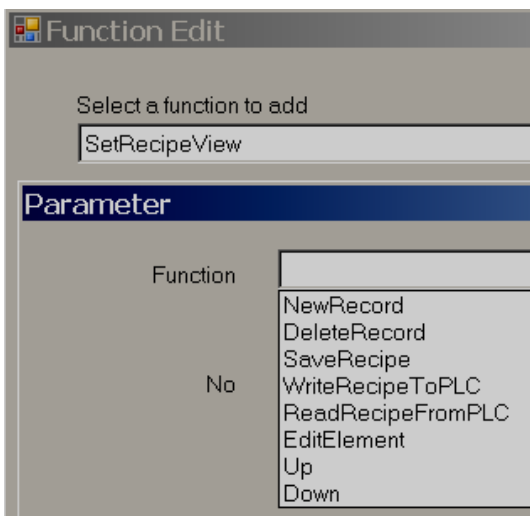
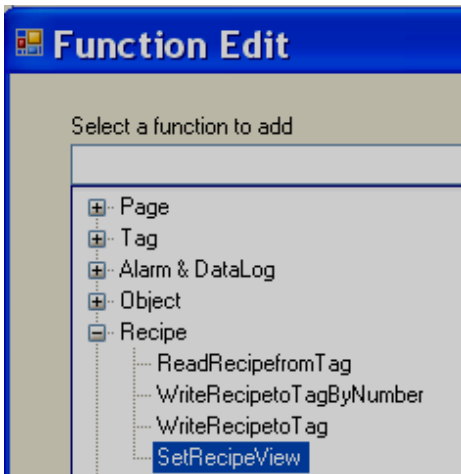

By default, it is not selected, so, it will show all the buttons. If this is selected, Recipe object will look as shown below (With out any Recipe function buttons)

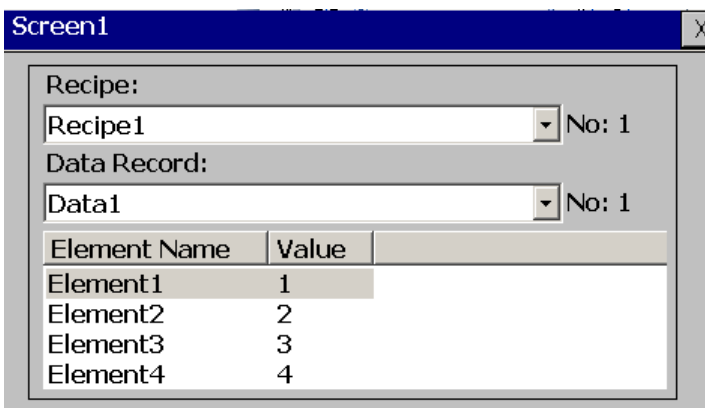

Allow Change

Select this option if you wish to select another Recipe in Run time.

Recipe:
 Recipe1 No: 1
 Data Record:
 Data1 No: 1

6.7.1.26 User View





Please also refer section Security (Project explorer) for detailed information about security features.

UserID	Secu...	
User1	9	↑
User2	1	↓
		✍

✎ ✕

In design time, it is possible to enter user name with security level. In design time, it requires operator to use two buttons in first screen and link them with functions “Login” and “Logout”. Then, in Run time, during first time Login, you can enter password. Password change feature is available in “Login” Dialog.

User view component is used to add new users in Run time with security level 9. It also allows changing security level for other users and deleting existing users. User view shows list of all the users with security level information.

-  It is to add new user by user with security level 9.
-  It is to delete existing user by user with security level 9.
-  It is to navigate from Button to Top in user list by user with security level 9.
-  It is to navigate from Top to Bottom in user list by user with security level 9.
-  It is to edit user name and security level by user with security level 9.

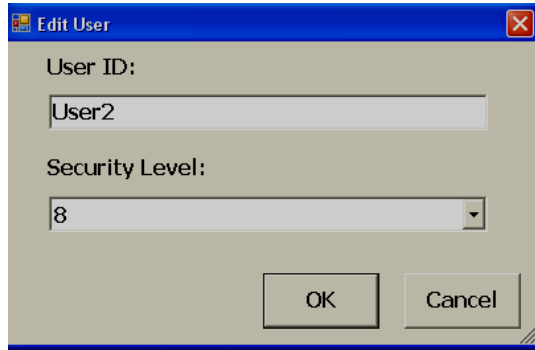

In PC during simulation, if new users are created, it is only valid for current session. If you close current session and run simulation again, design time users only will appear. Users created in earlier session will not appear. However, in HMI, this information will be saved in retentive memory and it will retain after power supply recycle.



If you download modified application from PC to HMI, all user information available in HMI for earlier project will be deleted.

6.7.1.27 Language Selector

It is to select HMI display language for the end user in Run time. Language selector should be configured and used along with Language table. Please refer section "Language" (Project explorer) for application example to know how to add new language.

6.7.1.28 XY Chart

This is to display Profile view for operator monitoring say Time Vs Set Points. It can be used with Recipe object to enter data in either design time or run time and then display for the operator

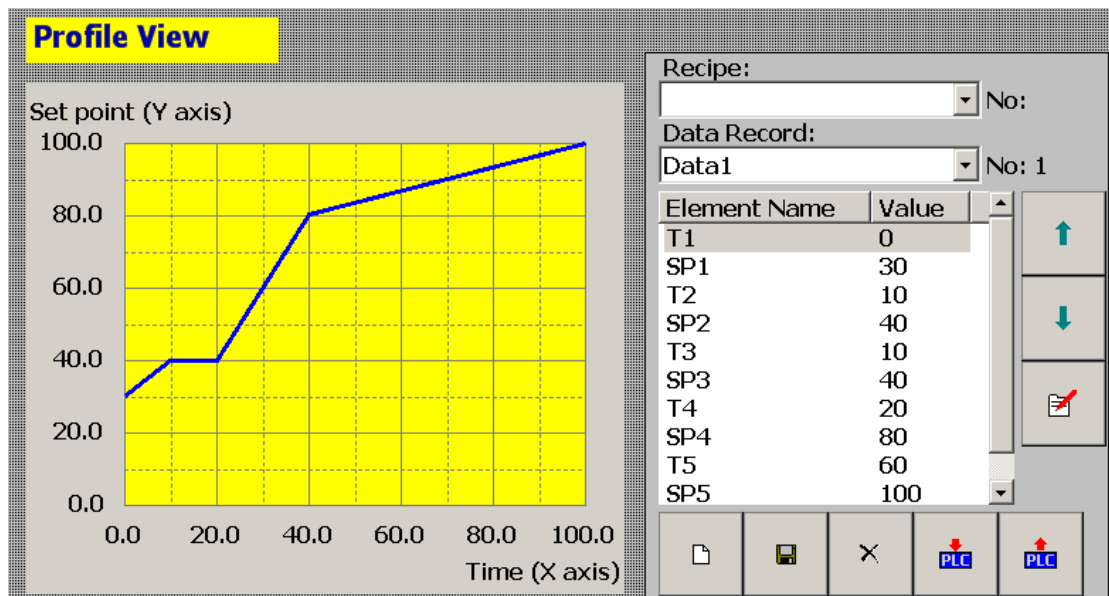

XYChart1's Properties

General | Curves | Common | Events

Appearance

BackColor
 GridColor
 ForeColor
 TextColor

TextFont

Name: Tahoma
 Size: 12
 Style: Bold
 Type: XY

Axis

X Axis

Decimal	1	Unit	
Divisions	5	SubDivisions	2
RangeLow	0	RangeHi	100

Y Axis

Decimal	1	Unit	
Divisions	5	SubDivisions	2
RangeLow	0	RangeHi	100



In run time, select Recipe and data record and then press icon  for first time in Recipe view object to refresh Profile view with latest data

XYChart1's Properties

General | Curves | Common | Events

Curve Count

1

Curve1

Source: Recipe1
 Color: ■
 Width: 2



Fig: Recipe configuration

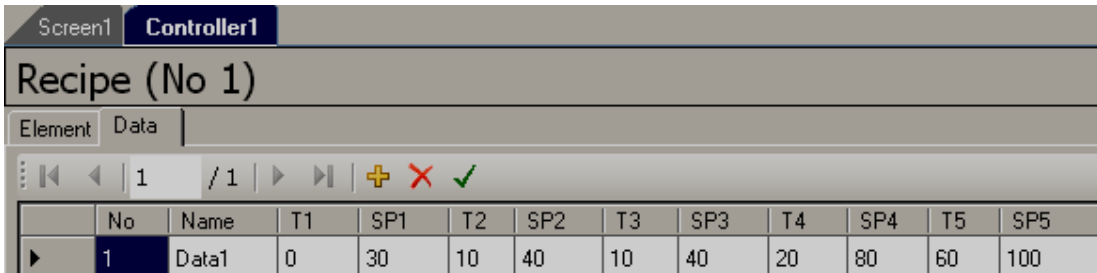

Fig: Time and Set point entry in Recipe table in design time

Above example reflects Ramp/dwell time arrangement. Observe T1, T2, T3, T4 and T4 values closely, they are Ramp and Dwell timings, SPx are Set points

6.7.1.29 Group Panel

It is used to group objects in a screen.

Procedure

Click on "Group Panel" at Basic Objects

On Screen, just draw a rectangle with mouse over the objects for which group function is required. It will show as follows

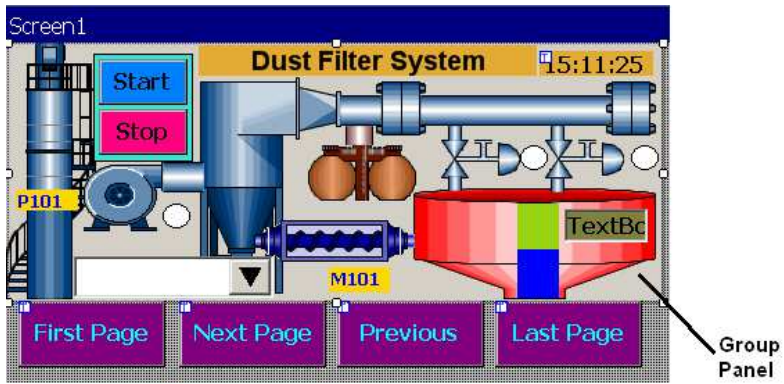

Now, double click on Group Panel object



Select "Group Controls" check box and click "OK"

Now, you will be able to move group panel to another location or rescale it to fit to another screen size etc..

Group Controls: Select Check box to apply group function. De select the check box for ungroup

6.7.1.30 Voice Recorder

It allows to Record and play back maximum 10 audio files, each up to 60 sec.

Note: Please make sure Audio Input/Output option selected while ordering the HMI and hardware installed in HMI prior to use this function

The audio file number (1 to 10) shown at Top Left corner on the Voice Recorder Object. If there is audio data, it will be filled with green color on the Time bar for the selected audio file

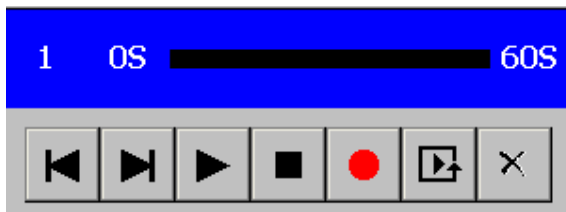

To move to earlier audio file (Navigation)



To move to next audio file (Navigation)



To play selected audio file



To Stop Recording audio file



To Start Recording at selected audio file number



To play all the audio files



To delete selected audio file

Use Navigation buttons to select the audio file number first and then use Start/Stop/Play functions

For ex: If you already have some data on file1 and if you attempt to Record data again on same file, then, earlier data is overwritten with new data.

6.7.2 Enhanced Objects

Fine components are available for User interface and display. The components include Dial, Digital LED, Level, Meter, Slider, Switch, Thermometer and Toggle.

6.7.2.1 Common Properties

Appearance

Back Color: Set background color of the component.

Bevel: It is to set border including inner border, outer border and style of border.

Inner Border: True/False

Outer Border: True/False

Style: 9 styles are available

None, Flat, Single, Double, Raised, Lowered, Double Raised, Double lowered, Frame Raised, Frame Lowered.

Behavior

Visible: True/False, Determine whether control is visible or hidden.

Enable: This is for event control. If linked with Digital tag, if tag value =1 in run time, then, events configured for the object will be executed. If tag value = 0, then, events will be not executed

Data

Tag Binding: Select the Analog Tag of process value

Write design time value: If selected, then, value entered here in design time will be replaced by default value defined at tag data base.

Design

Name: Label1, It is name of the component. Every Component will have a **UNIQUE** number in a page. If more than one Label is available in the same page, number will be incremented automatically. If required, user can also change name of this component if required.

Component "Name" property is very useful and it can be used in scripts also.

Example: Task: Change Label1 back color to blue in Run time when Tag1 is equal to 1.

```
if(Tag1 == 1)
{
  Screen1.Label1.BackColor=Color.Blue;
}
```

Screen1: It is location of Label1

Label1: Object name

BackColor: Property of Label related to back ground color

Color.Blue: Target Color

If above script is executed in scheduler once in a sec, then when Tag1 == 1, then, back color for Label1 will be changed to Blue color in Run time.



Properties are case sensitive.

BackColor : OK

Backcolor : Not OK

Security Level: Define security level for the component to be used by the operator. If operator security level is less than security level defined for component, it will not allow operator to operate the component.

Locked: True/False: It is to Move or Resize the component.

Layout

Dock: Defines which borders of the control are bound to the container.

Location: The coordinates of the upper-left corner of the component relative to upper-left corner of the container. Set X and Y position in screen in pixels.

Size: Size of the component in pixel. Set height and width of component in pixels.

Position: It is define position of Label, Value etc, for some components. Available options include None, Top Left, Bottom Right, Both and Internal.



Position naming convention for components

For example: Level component, Label Position = **Bottom Right**

If Orientation is Vertical, then, Label will be displayed at **Right** side to component.

If Orientation is Horizontal, then, Label will be displayed at **Bottom** side to component.

6.7.2.2 Level

It is normally used to display process parameter value in several steps. Generally it is linked with Analog type tag (Analog input type tag at PLC, which is received as 4-20 mA signal from field transmitters like Ear level transmitters (sound detectors in ball mills etc).

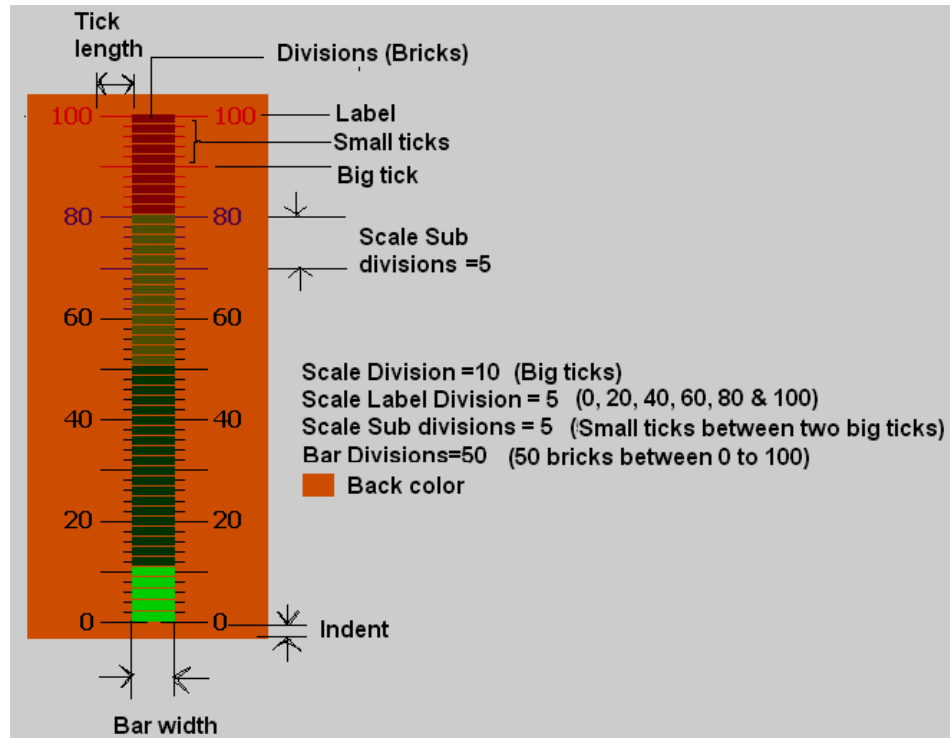

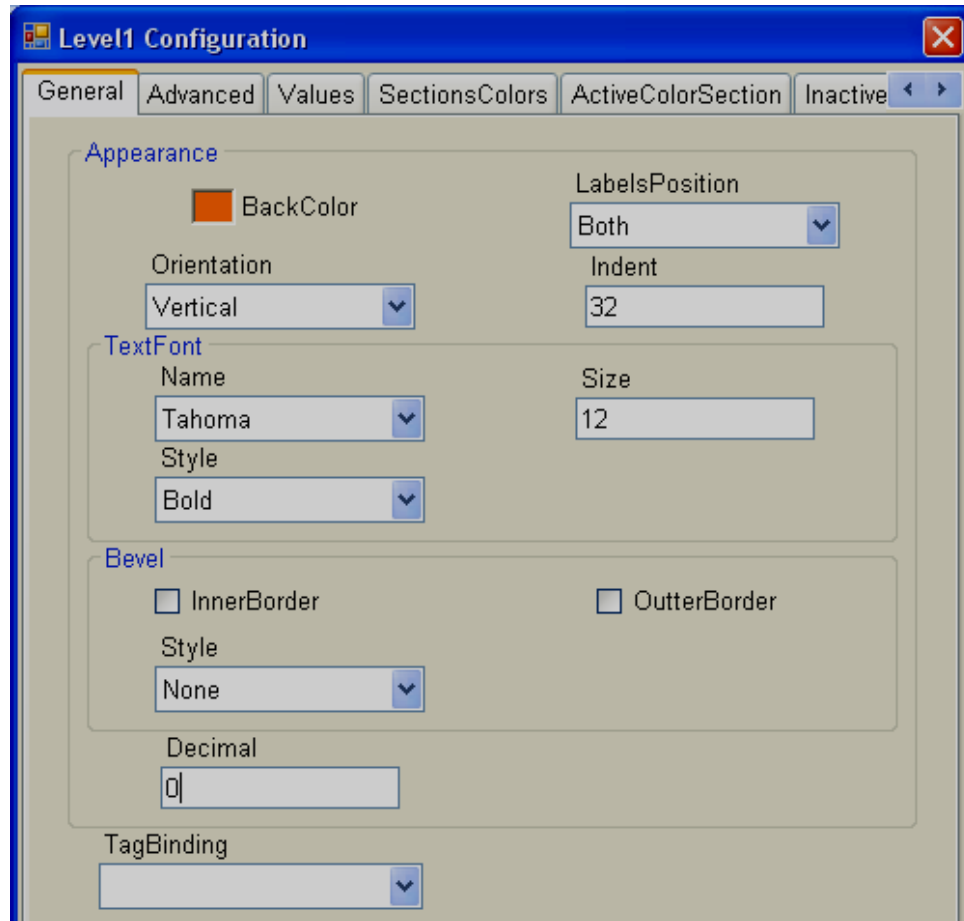

Properties

Back Color: Define background color for the component.

Labels Position: Define labels position. Available options are Top Left, Bottom Right and Both. Naming convention depends on orientation. If orientation = Vertical, then, if "Top left" is selected, label position will be shown on "Left" side. If orientation = Horizontal, then if "Top Left" is selected, label position will be shown on "Top" side of component.

Orientation: Vertical/Horizontal. Select direction.

Text Font: It is to set font for the label including Name of Font, Size of font and Style of font. Supported styles include Regular, Bold, Italic, Underline & Strikeout.

Bevel: Define inner border and outer border for the component. Please refer common properties at beginning of this section for more details.

Decimals: Define number of decimals to be displayed for value to be displayed along with level component in run time.

Tag Binding: Select the Analog Tag of process value.

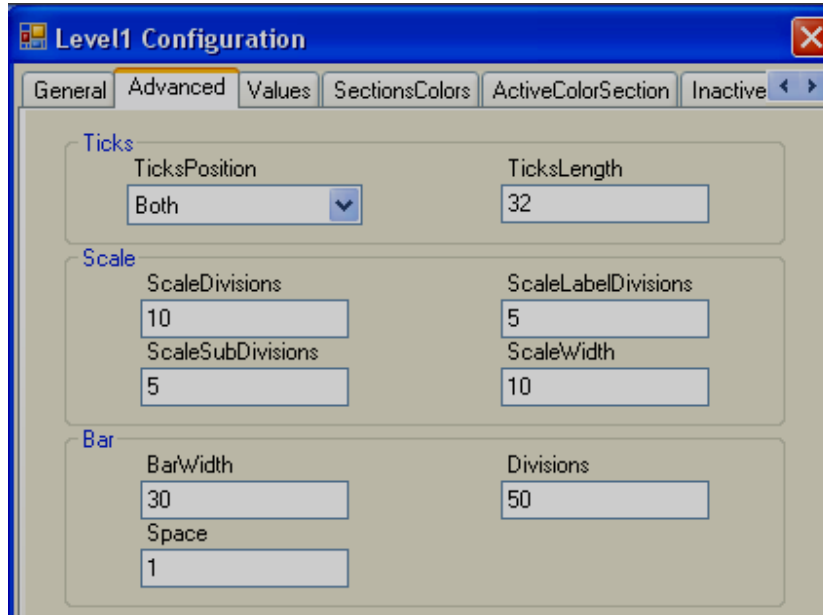

Ticks:

Ticks Position: Define Ticks Position. Available options include Top Left, Bottom Right, Both and None.

Ticks length: Define length of Ticks in pixels.

Scale:

Scale divisions: Define number of Big Ticks in Level graph.

Scale Sub Divisions: Define number of ticks between two big ticks.

Scale Label Divisions: Define number of Labels to be displayed. Example: If Scale label division = 5, Scale = 0-100, then, it display labels as 0, 20, 40, 60, 80 & 100.

Scale Width: Define Scale width. If ticks are selected to display on both directions, then, this define width between two scales on both sides.

Bar

Bar Width: Define width of Bar graph.

Divisions: Define number of divisions (Like bricks) to appear in Bar graph.

Space: Define Space between divisions (bricks) in pixels.

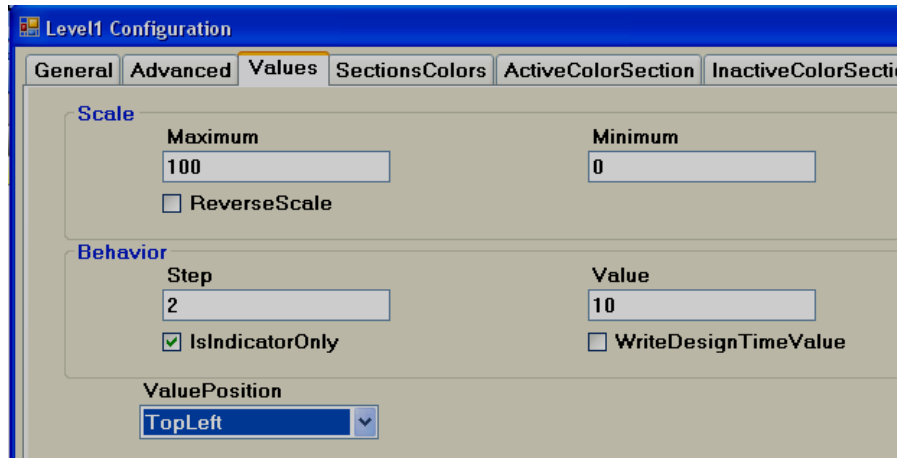

Maximum: This is maximum range of process value (Analog input Type Tag)

Minimum: This is minimum range of Process Value (Analog input Type Tag)

Example: If Ear Level transmitter range is 0 to 100, set Minimum = 0, Maximum = 100.

Reverse Scale: True/False. If it is selected, then, zero will be on bottom side and 100 will be at top side for vertical orientation.

Step: It is the minimum value to reflect change in Bar graph position. Bar Step and Bar divisions settings are closely related. If Bar divisions = 50 for scale value 0-100, then, if Step=2, when process value changes by value 2, it shows level value change clearly in level graph.

Value: It is used to enter process value in design time and check Bar graph display status in PC. It requires operator to enter value in multiples of step value or else, it is automatically corrected close to multiples of step value.



Is Indicator only: If it is selected, level graph is used only for Read only purpose. If it is not selected, then, you can use level graph for write purpose similar to Slider to send set point from HMI to PLC etc. Just use finger to touch at various places in Level graph to set the level required.

Value Position: Define position of process value to be displayed in Run time along with Level graph. Available options include None, Top Left, Bottom Right and Both.

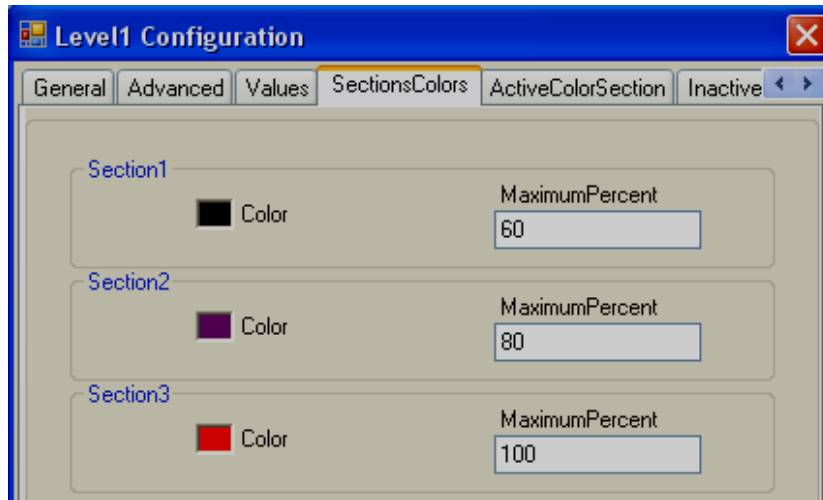

Sections colors: It is configure bands for the sections to show different colors for Labels and Ticks in Level graph.

Example: Three bands

Section 1, Max % = 60 that means, its band is from 0 to 60 % it shows labels and ticks in black color.

Section 2, Max % = 80 that means, its band is from 61 to 80 %.

Section 3, Max % = 100 that means, its band is from 81 to 100 %.

Note: Band setting is in % for the total Scale defined (Minimum to maximum).

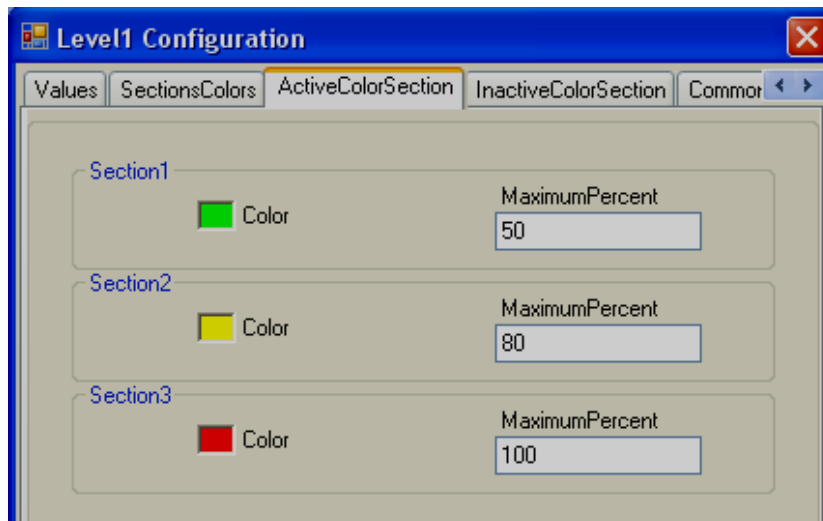

Active Color Section: Define Active color for process value band. For example: If process value range is 0-100, set different bands in % for process value, define colors to appear with in level Bar graph in Run Time.

When process value is between 0 and 50 % of scale, display bricks in Lime color.
When process value is between 51 and 80 % of scale, display bricks in Yellow color

When process value is between 81 and 100 % of scale, display bricks in Red color.

Configuration from Property grid

ActiveColorSection	ColorSection[] Array
InactiveColorSection	ColorSection[] Array

Click at “ColorSection[] Array, then it following screen will appear, then set all the bands and colors.

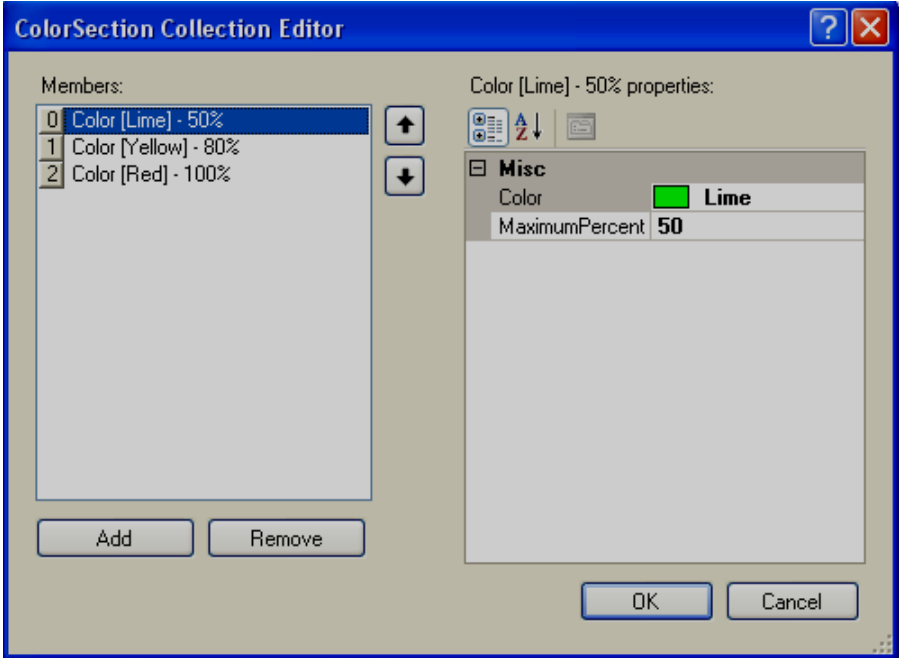

Inactive Color Section: Define Inactive color for process value bands same as above. Generally light colors are selected for Inactive colors and Dark colors with more contrast is selected for Active colors, then users/operators will be able to differentiate between active and inactive colors clearly.

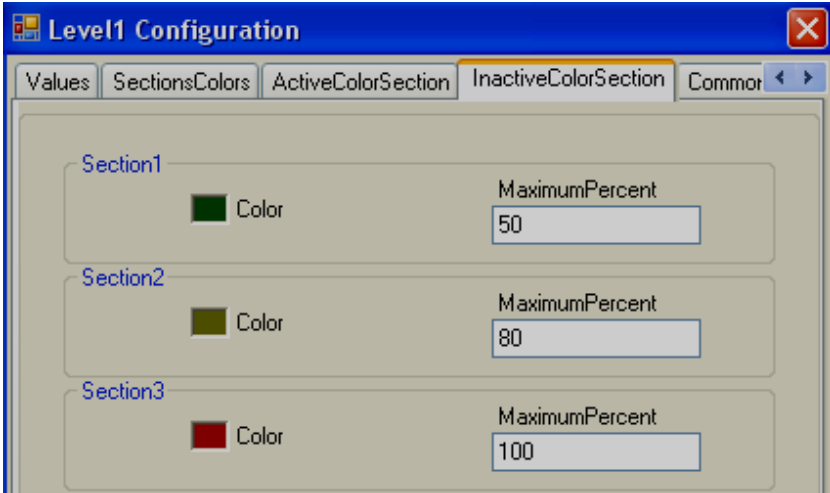

Events: It is to trigger functions/jobs to be executed when process value of tag linked with Level bar graph is changed in run time.

6.7.2.3 Meter

Meter is component generally used to display process value like pressure, Temperature, Flow etc. Generally it is linked with Analog type tag (Analog input type tag at PLC, which is received as 4-20 mA signal from field transmitters like Temperature, pressure etc...)

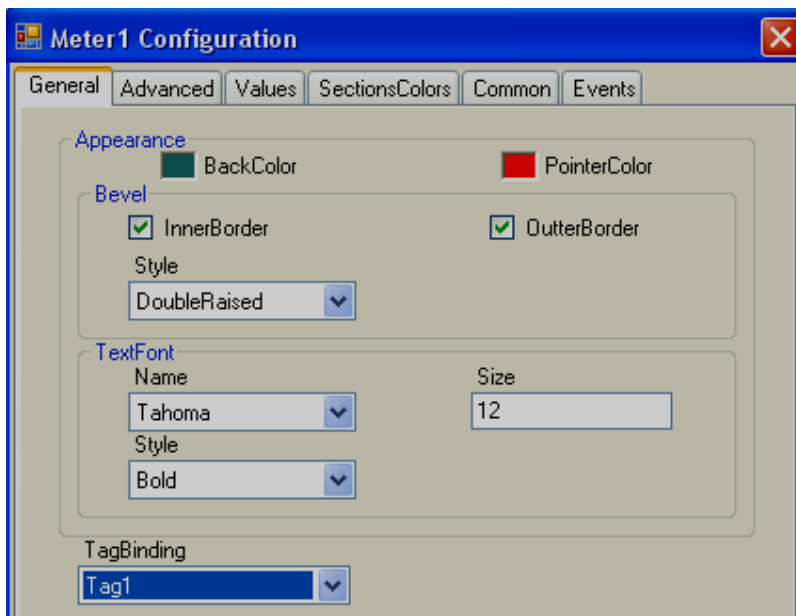
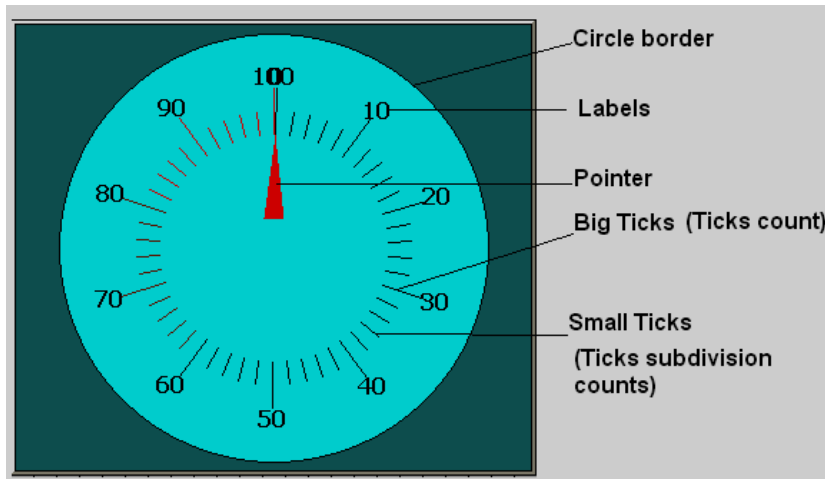

Properties

Back color: It is to set back ground color for the Meter.

Pointer Color: It is to set Pointer Color.

Bevel: It is to set border including inner border, outer border and style of border.

Inner Border: True/False

Outer Border: True/False

Style: 9 styles are available

None, Flat, Single, Double, Raised, Lowered, Double Raised, Double lowered, Frame Raised, Frame Lowered.

Text Font: It is to set font for the label including Name of Font, Size of font and Style of font. Supported styles include Regular, Bold, Italic, Underline & Strikeout.

Tag Binding: Select the Analog Tag of process value.

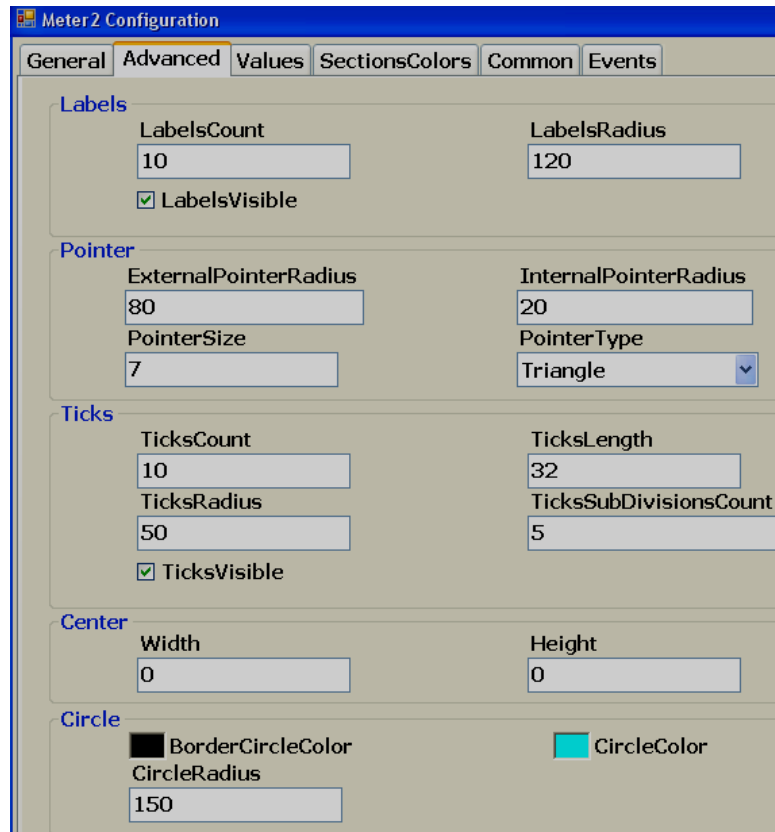

Labels:

LabelsCount: Number of labels to be displayed around the Meter.

Example: Pressure transmitter range 0-100 bar
Label count: 10, then, around, Meter, you will see labels marked with 10, 20, 30, 40, 50, 60, 70, 80, 90 and 100.

LabelsRadius: It is to set radius of Labels to be displayed around the Meter.

LabelsVisible: True/False, it is to set visibility for the labels.

Pointer

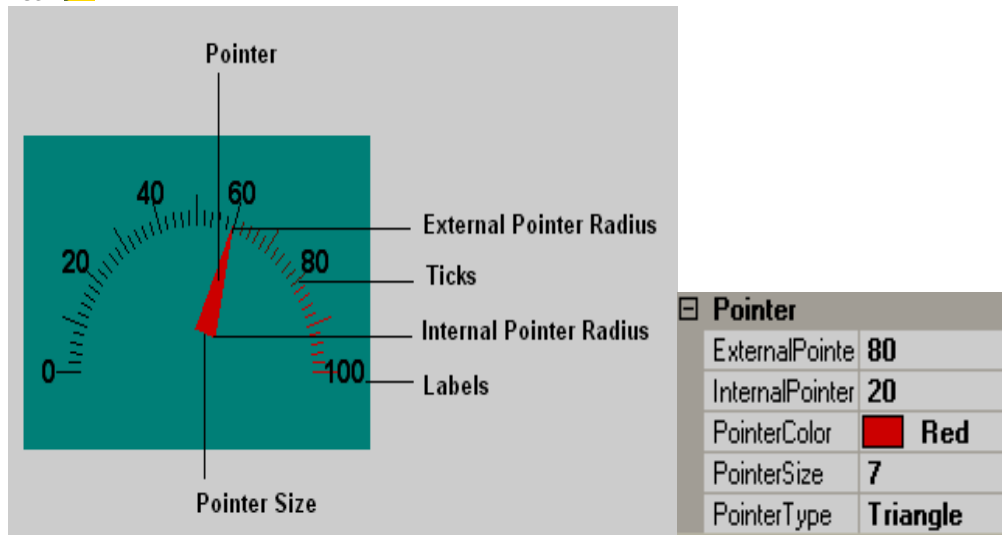

External Pointer Radius: It is to set external pointer Radius, define end position.

Internal pointer Radius: It is to set Internal Pointer Radius, defines start position.

Pointer Size: It is to set Pointer Size in pixels.

Pointer Type: It is set Pointer type. Available types include Triangle, Circle and Line.

Ticks

Ticks Count: Set number of ticks between labels.

Ticks Length: Set Tick length in pixels.

Ticks Radius: Set Tick Radius

Ticks subdivision counts: Set Tick sub division counts

Ticks Visible: True/False, Set Ticks visibility

Center

Width: Adjust width of meter with in boundaries.

Height: Adjust height of meter with in boundaries. This is useful when semi meter is required and need to adjust meter to the center as shown.

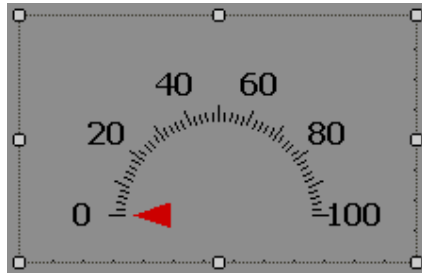

Circles

Border circle Color: Set border color for circle.

Circle Color: Set Color for circle.

Circle Radius: Set Radius for circle.



Note: If Border circle color, Circle Color is same as Back color, then, circle is not visible and it appears as shown below.

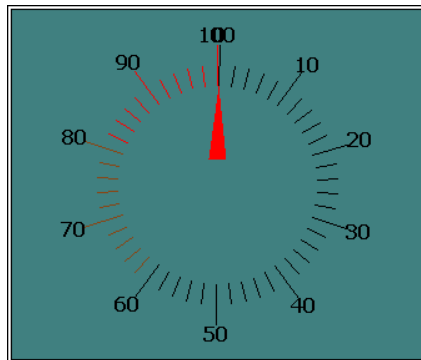

Meter1 Configuration

General Advanced **Values** SectionsColors Common Events

Angle And Scale

Minimum	<input type="text" value="0"/>	StartAngle	<input type="text" value="0"/>
Maximum	<input type="text" value="100"/>	EndAngle	<input type="text" value="270"/>
<input type="checkbox"/> ReverseScale			

Behavior

Step	<input type="text" value="0"/>	Value	<input type="text" value="0"/>
<input checked="" type="checkbox"/> IsIndicatorOnly		<input type="checkbox"/> WriteDesignTimeValue	

Angles & Scale

Maximum: This is maximum range of Process Value (Analog input Type Tag).

Minimum: This is minimum range of Process Value (Analog input Type Tag).

Example: If pressure transmitter range is 0 to 100 bar, set Minimum = 0, Maximum = 100.

Start Angle: It is start angle for the Range low (Analog input)

End Angle: It is end angle for the Range high (Analog input)

Reverse Scale: It is to set scale direction in Meter

False: Anti Clock wise

True: Clock wise

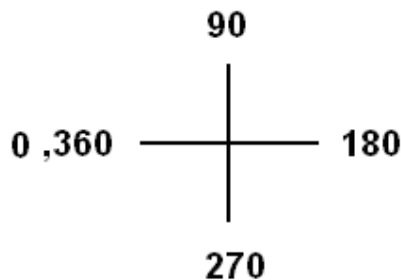

Fig: Standard Reference angle

Reverse Scale = True

For example: If you want 0° (Left) to 180° (Right) Meter for Process value range 0-100, set the following.

Start Angle: 0° , End Angle: 180° and Reverse Scale = True.

Behavior

Step: It is the minimum value to reflect change of pointer position in Meter.

For example: By default, Step = 0, i.e., pointer moves its position in Meter in Real time even with minor change in process value.

For example: Step = 5, i.e., pointer moves its position in Meter in Real time in steps of 5.

Value: It is used to enter process value in design time and check pointer position in PC.



Indicator only: By default, it should be selected such that the meter will be used for Read only purpose. If it is not selected, then, you can use the Meter for Write purpose similar to Slider to send set point from HMI to PLC etc. Just use finger and move pointer to change set point.

Write design time value: If selected, it writes design time value instead of default value defined at tag data base.

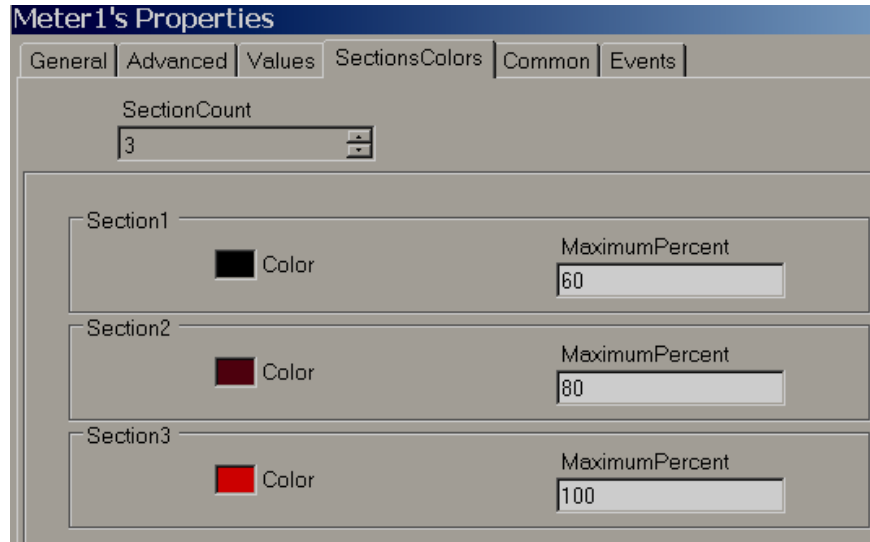

Sections colors:

It is configure bands for the sections to show different colors for Labels and Ticks in Meter.

Example: Three bands

Section 1, Max % = 60 that means, its band is from 0 to 60 % it shows labels and ticks in black color.

Section 2, Max % = 80 that means, its band is from 61 to 80 %.

Section 3, Max % = 100 that means, its band is from 81 to 100 %.

Note: Band setting is in % for the total Scale defined (Minimum to maximum).

6.7.2.4 Slider

This is normally used to change set point of process by operator from HMI in Run time. Generally it is linked with Analog type tag (Analog output type tag at PLC, to send 4-20 mA signal out from PLC for external Controllers, Variable speed drives etc).

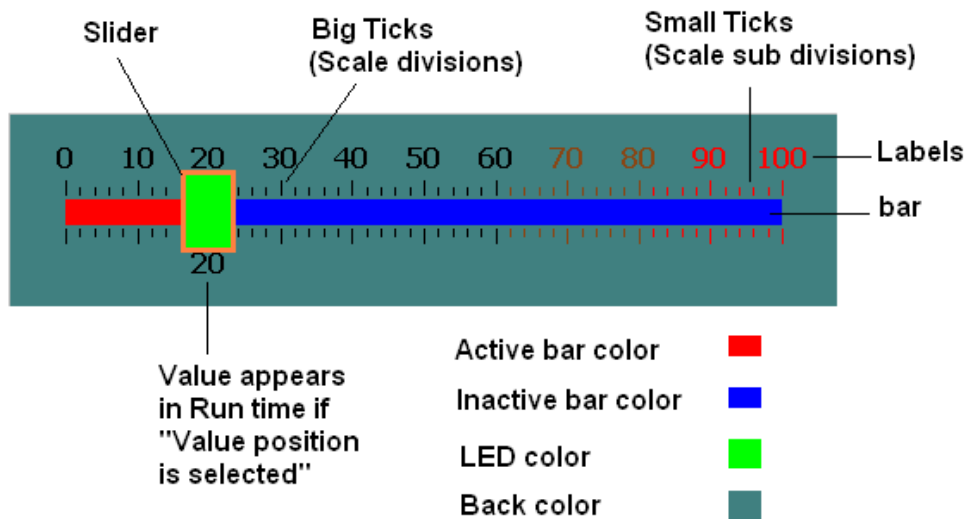

In above fig, Scale divisions = 10 (Big ticks).
 Scale sub divisions = 5 (Small ticks between big ticks).
 Scale Label divisions = 10 (0, 10, 20 till 100).

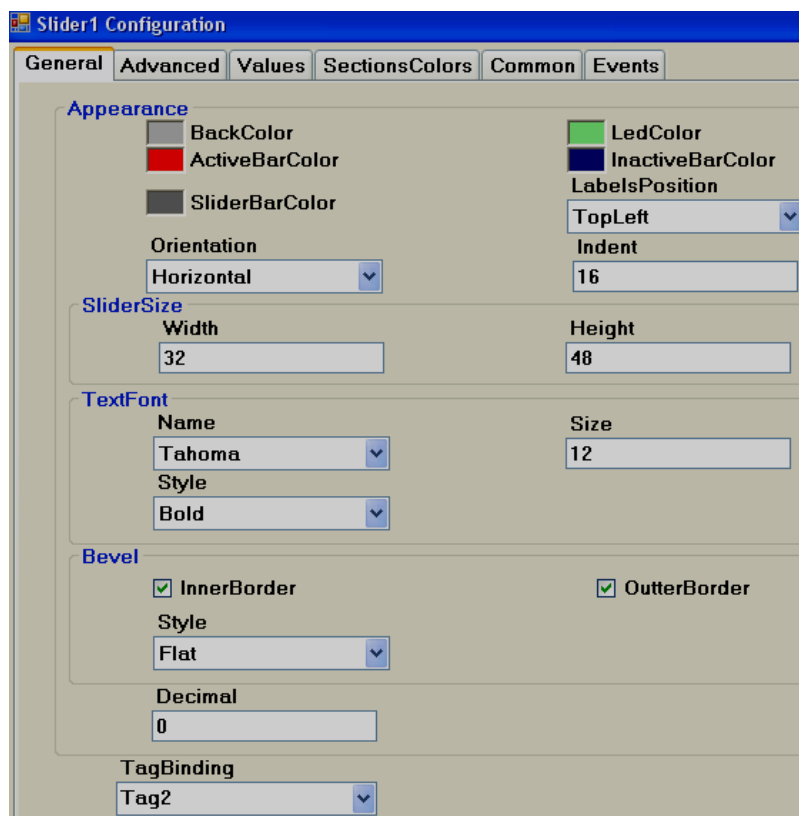

Properties

Back color: Back color for the component.

Active bar color: Define active bar color.

Slider bar color: Define border color for the slider.

LED color: Color of the handle

Inactive bar color: Define inactive bar color.

LabelsPosition: Define Labels position. Available options include Top Left, Bottom Right, Both, Internal and None.

Orientation: Horizontal/Vertical. This is orientation of Slider component and in above figure, it is Horizontal direction.

Slide size: Define height and width of the slider.

Text Font: It is to set font for the label including Name of Font, Size of font and Style of font. Supported styles include Regular, Bold, Italic, Underline & Strikeout.

Bevel: It is to set border including inner border, outer border and style of border.

Inner Border: True/False

Outer Border: True/False

Style: 9 styles are available

None, Flat, Single, Double, Raised, Lowered, Double Raised, Double lowered, Frame Raised, Frame Lowered.

Tag Binding: Select the Analog Tag of process value.

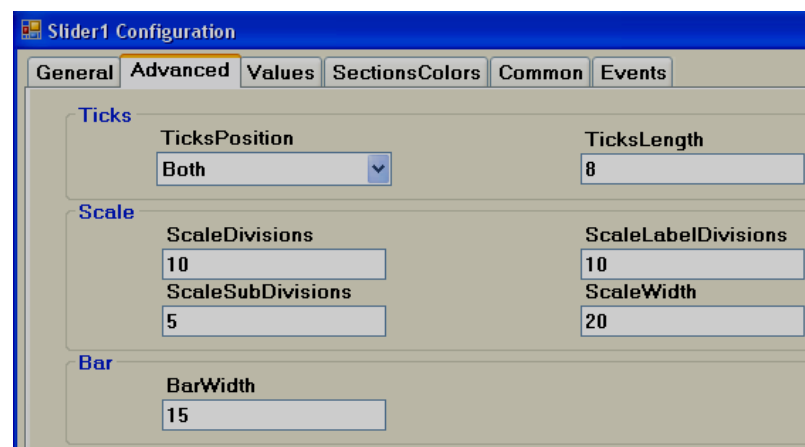

Ticks:

Ticks Position: Define ticks position. Available options include Top Left, Bottom Right, Both, Internal and None.

Ticks Length: Set Tick length in pixels

Scale:

Scale divisions: Define number of Scale divisions (Big ticks).

Scale Sub Divisions: Define number of Sub divisions (Small Ticks between big ticks).

Scale Label Divisions: Define number of Labels to appear like 0, 10, 20 etc. till 100 for scale 0 to 100.



Define same value for both Scale divisions and Scale label divisions.

Scale Width: Define Scale width.

Note: This is only width for Scale divisions. Example: If ticks position is selected on both sides, then it is gap between two scale ticks (Top and Bottom in Horizontal orientation or Left and Right in vertical orientation).

Bar:

Bar Width: Define width of Bar.

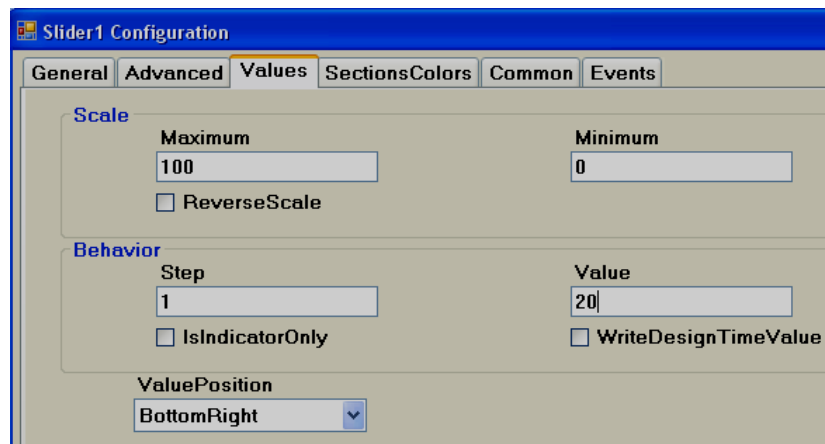

Scale:

Maximum: This is maximum range of Set point (Analog Tag, Normally Analog Output).

Minimum: This is minimum range of Set Point (Analog Tag, Normally Analog Output).

Example: If Controller set point is 0 to 100 Deg.C, set Minimum = 0, Maximum = 100.

Reverse Scale: If Selected, Scale labels will be displayed in Reverse.

Behavior:

Step: It is the minimum value to reflect change of the slider position.

For example: By default, Step = 0, i.e., Slider moves its position in Real time even with minor change in process value.

For example: Step = 5, i.e., Slider moves its position in Real time in steps of 5.

Value: It is used to enter process value in design time and check the Slider position in PC.

Indicator only:



If Indicator only is selected, slider is used for Read only. Operator will be not able to move slider in Run time.

If Indicator only is not selected, the slider is used for Read/Write. Operator will be able to move slider in Run time for example: change set point for variable speed drive.

Value Position: Define position for the value to appear in Run time. Available options include Top left, Bottom Right, Both, Internal and None.

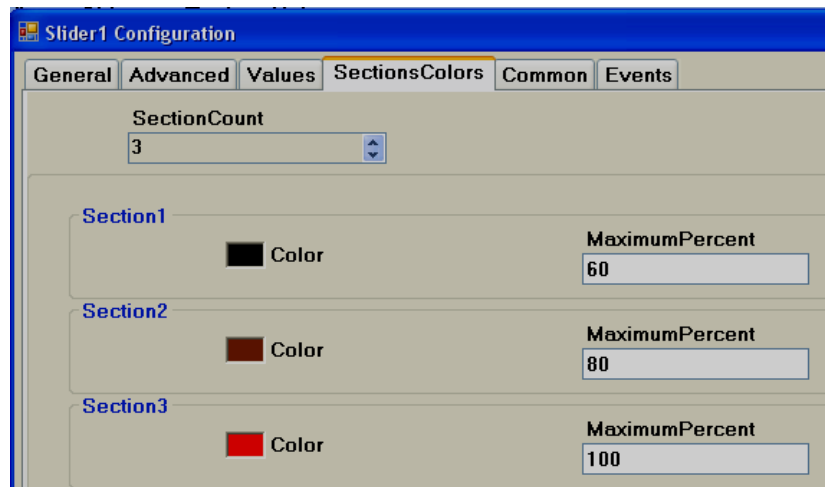

Sections colors: It is configure bands for the sections to show different colors for Labels and Ticks in Slider.

Example: Three bands

Section 1, Max % = 60 that means, its band is from 0 to 60 % it shows labels and ticks in black color.

Section 2, Max % = 80 that means, its band is from 61 to 80 %, it shows labels and ticks in brown color.

Section 3, Max % = 100 that means, its band is from 81 to 100 %, it shows labels and ticks in Red color.

Note: Band setting is in % for the total Scale defined (Minimum to maximum).

Security level:

It is the security level to operate slider in Run time. If security level of user currently Log in is less than security level defined for Slider, then, it will not allow user to operate Slider and it alerts the following message.

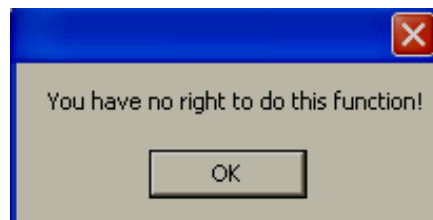

There are 9 security levels available for user selection.

For example: Security level defined for Slider = 3.

If User with Security level 1 or 2 is logged in, if user attempts to use slider, it shows the above message.

If User with Security level 3 or above is logged in, if user attempts to use slider, it will move slider and write value to Tag linked as per Scale setting.

6.7.2.5 Thermometer

This is normally used to view process temperature by operator in Run time. Generally it is linked with Analog type tag (Analog input type tag at PLC, which is received as 4-20 mA signal from field transmitters like Temperature etc...)

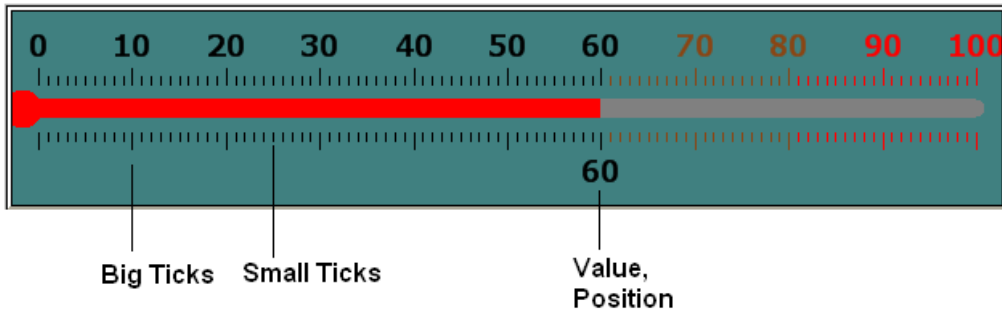

Scale Label Divisions= 10 (0, 10, 20... 100)

Scale Divisions = 10 (No.of Big Ticks)

Scale Sub Divisions = 10 (No.of Small ticks between Big Ticks)

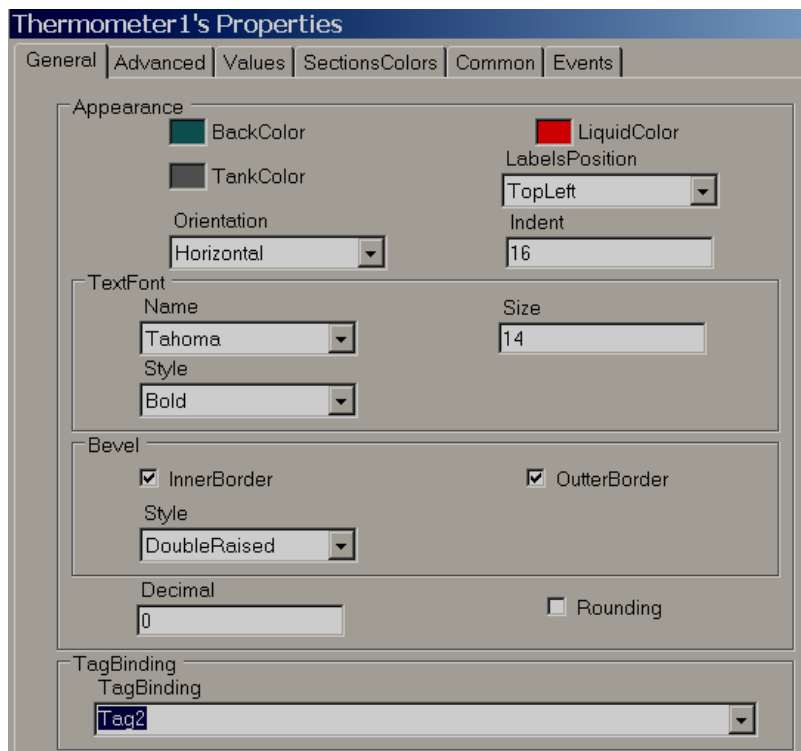

Properties

Back Color: Define back color for the component.

Liquid color: Shows temperature level (mercury) in Thermometer.

Tank Color: Define background color of thermometer without mercury.

LabelsPosition: Define Labels position. Available options include Top Left, Bottom Right, Both, Internal and None. The naming convention is based on selected orientation of component.

Orientation: Horizontal/Vertical. This is orientation of component and in above figure, it is Horizontal direction.

Indent: It is the gap between border and start of scale.

Text Font: It is to set font for the label including Name of Font, Size of font and Style of font. Supported styles include Regular, Bold, Italic, Underline & Strikeout.

Bevel: It is to set border including inner border, outer border and style of border.

Inner Border: True/False

Outer Border: True/False

Style: 9 styles are available

None, Flat, Single, Double, Raised, Lowered, Double Raised, Double lowered, Frame Raised, Frame Lowered.

Tag Binding: Select the Analog Tag of process value.

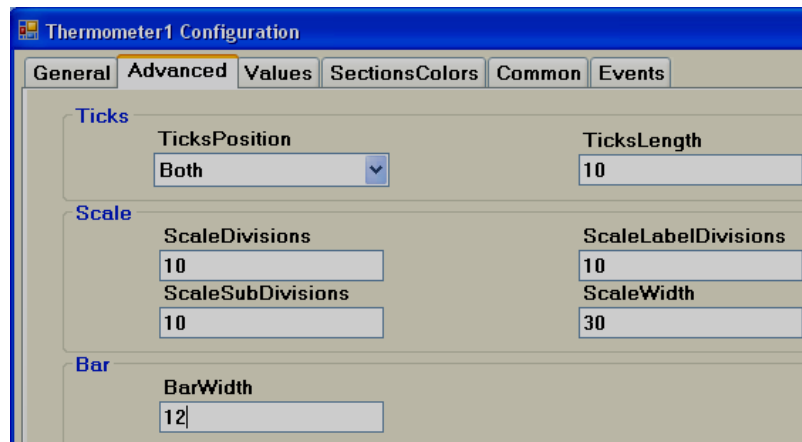

Ticks Position: Define ticks position. Available options include Top Left, Bottom Right, Both, Internal and None.

Ticks Length: Set Tick length in pixels

Scale divisions: Define number of scale divisions (Big Ticks) for the component.

Scale Sub Divisions: Define number of Sub divisions between the above scale divisions (Number of Small ticks between any two Big Ticks).

Scale Label Divisions: Define number of Labels to be displayed for component as per Scale Range of process value. For ex: 0, 10, 20, 30...100.

Scale Width: Define Scale width. If you have ticks on both sides of component, then, it defines width between Upper (Left) and Lower (Right) scale divisions based on orientation of component.

Bar Width: Define width of Bar in pixels.

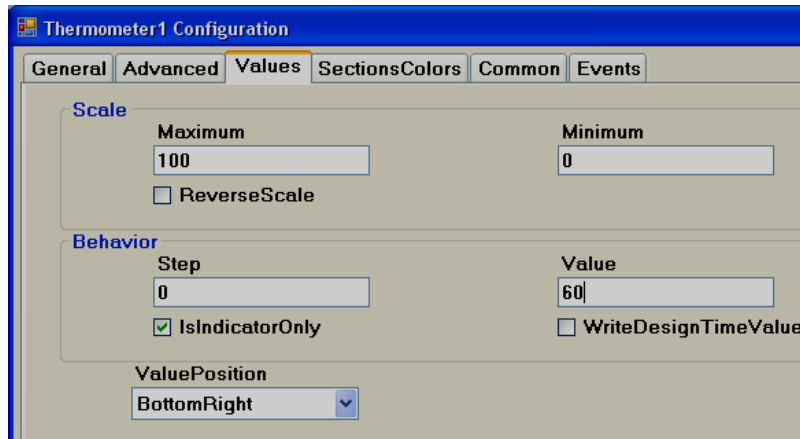

Maximum: This is maximum range of Set point (Analog Tag, Normally Analog input, 20 mA, 10V DC etc.)

Minimum: This is minimum range of Set Point (Analog Tag, Normally Analog input, 4 mA, 0V DC etc.)

Example: If Temperature transmitter range is 0 to 100 Deg.C, set Minimum = 0, Maximum = 100.

Reverse Scale: True/False. Define Scale direction.

Step: It is the minimum value to reflect change of mercury level.

For example: By default, Step = 0, i.e., Mercury level moves in Real time even with minor change in process value.

For example: Step = 5, i.e., Mercury level moves its position in Real time in steps of 5.

Value: It is used to enter process value in design time and check mercury level position in PC.

Indicator only: If selected, then, this component is used for Read only. If it is not selected, then, this component can be used for Write/Read purpose.

Write design time value: If selected, it writes design time value instead of default value defined at tag data base.

Value Position: Define position for the value to appear in Run time. Available options include Top left, Bottom Right, Both, Internal and None. The naming convention is based on orientation of component.

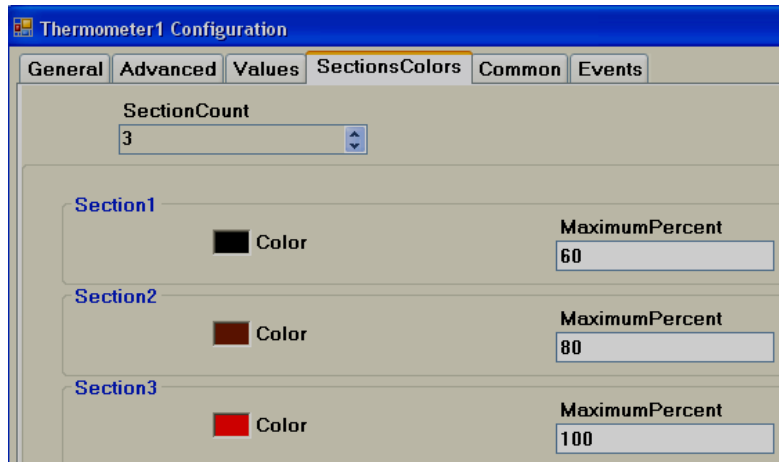

Section Colors: Define bands to display Ticks and Label color accordingly based on value of tag in Run time.

6.7.2.6 Bar Box

Bar Box is a Graphical User Interface widget display bar graph for Analog Tag in Run Time.

Every Bar box should be linked with **Analog Tag**.

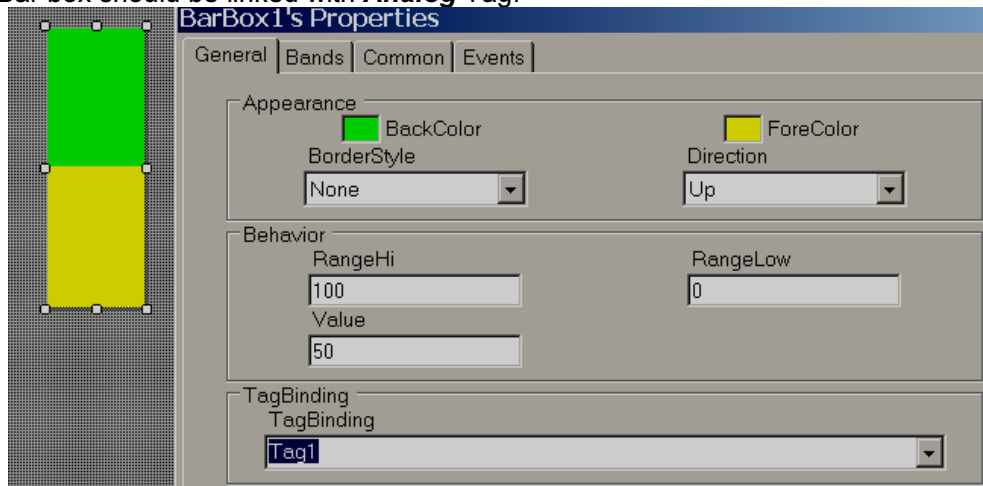

Properties

Border Style: Define border style. They include Fixed single, Fixed 3D and None.

Direction: Define direction of Bar graph. Up/Down/Left/Right

Range high: Display scale high.

Range Low: Display scale low.

Value: Default value. It is to check how fore color, back color displays in PC during design time.

Tag Binding: Select the Analog Tag of process value.

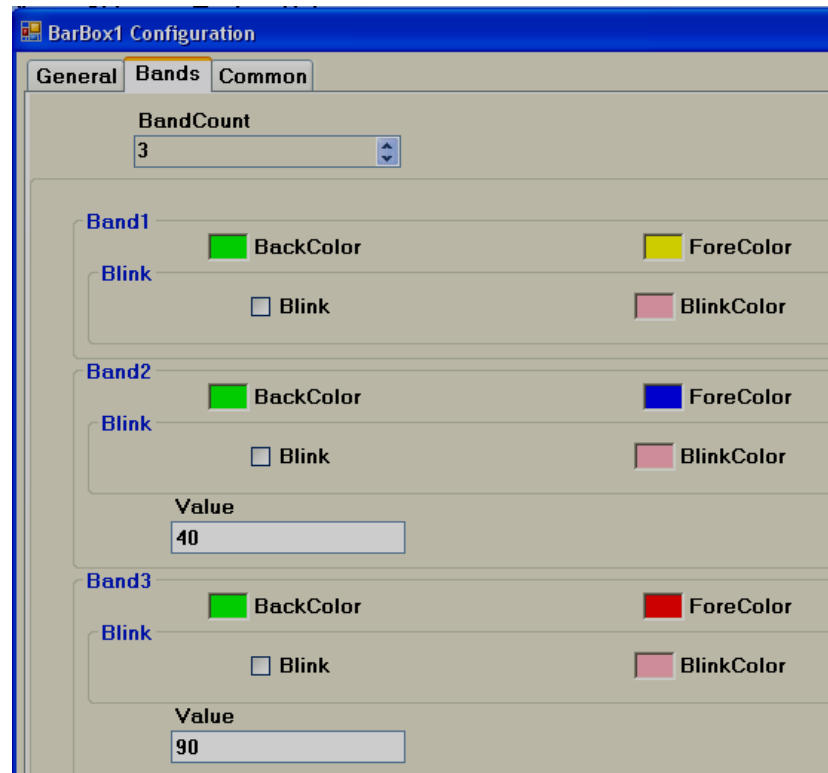

Bands

It is to define various bands for the process value to appear and display animation in Run time.

Band count: Use up/down buttons to increase/decrease number of bands. Maximum 32 bands are supported. In each band, it is possible to configure back color, fore color and blink properties.

Back color: Define back color.

Fore Color: Define fore color.

Blink: Select "True" if blink is required and "False" if blink is not required.

Blink color: If "True" is selected for blink, then, this property is visible and select required blink color.

Value: It is the band range. For the first band, it is always Range Low value defined for bar box. Band 1 high range is value defined at Band2. Band 2 high range value is value defined at Band3 so on.

6.7.2.7 Scale

Scale is a Graphical User Interface widget used along with bar box if required.

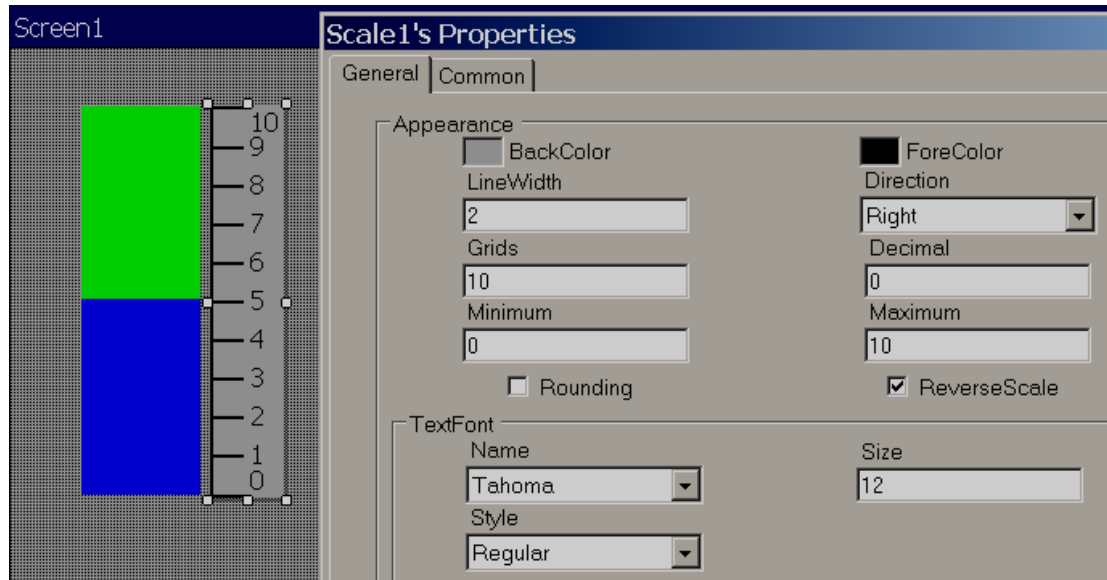

Properties

Back color: Define back color

Fore Color: Define fore color

Line width: Define width of line

Grids: Define number of grids

Direction: Define direction of Scale. Up/Down/Left/Right

6.7.2.8 Historical Trend Box

Historical Trend box is Graphical User Interface widget used to display historical trends for the process values in Run Time.

Related Historical functions:

Page Navigation: First Page, Next Page, Previous Page and Last Page

Zoom: Zoom in, Zoom Out and Zoom All

Data log control: Start Data logging and Stop data logging

Data: Dump data, Clear data

Any of the above functions can be assigned to a button and please check section "Function editor" for detail information about the above functions.

Procedure:

Step 1: Create tags used for data logging, Example: Tag1. Also create another tag for displaying historical value near Historical trend in Run time Example: Tag2.

Step 2: In Project explorer, click on Data logging and configure tags for data logging.

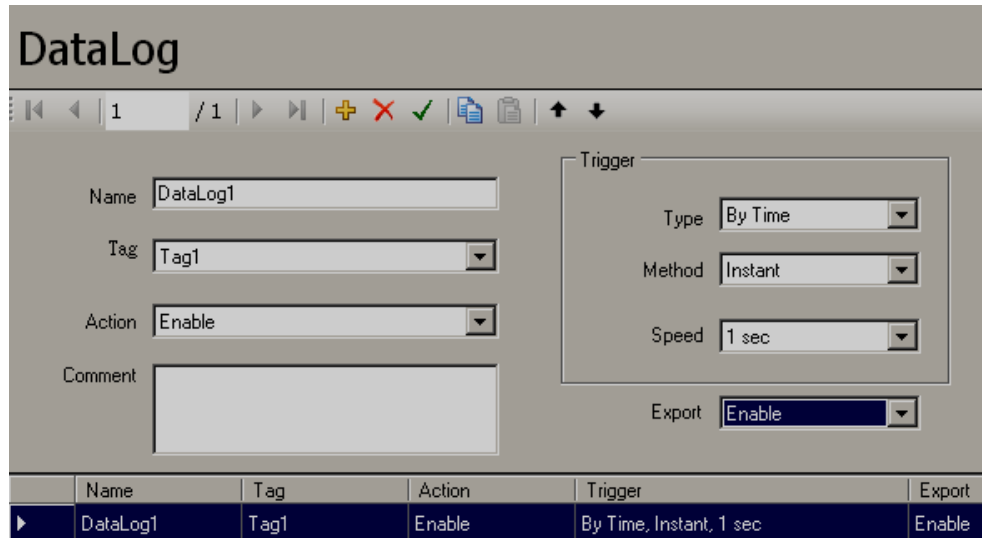

Name: Name of Data log tag (This name should be selected in Historical trend during historical trend configuration)

Tag: Tag name for which data logging is required

Step 3: Insert Historical trend box in screen and configure all the properties.

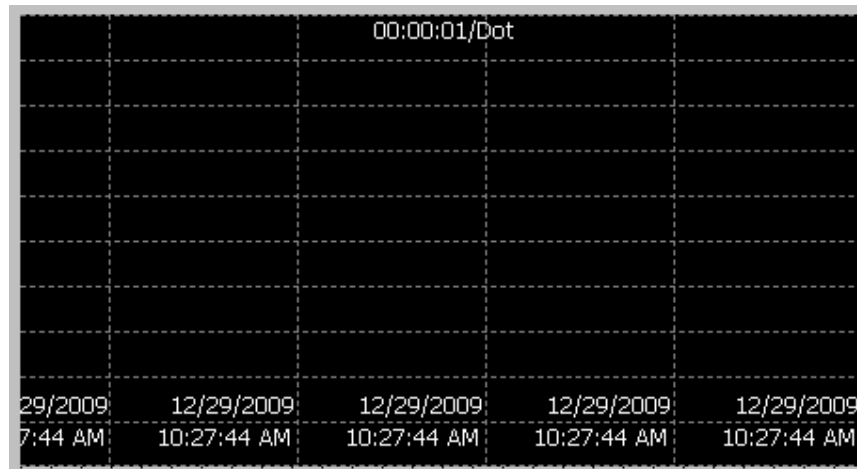

Double click on above historical trend component to configure properties.

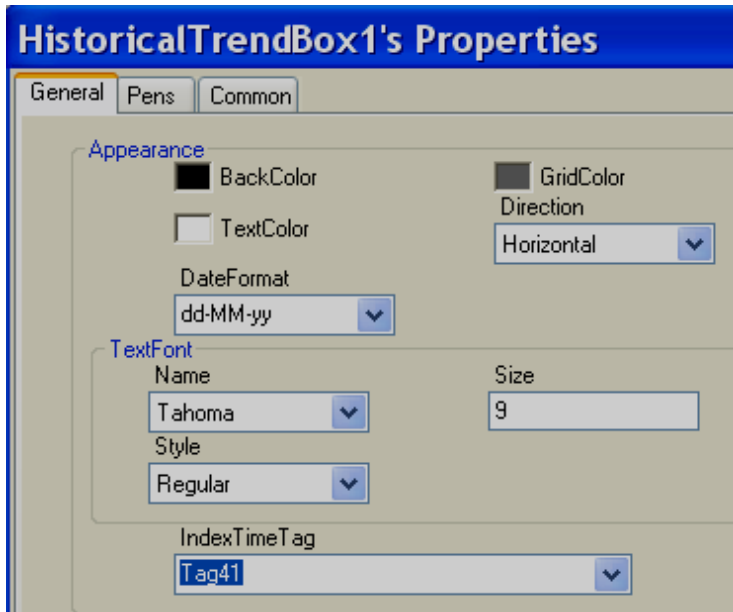

Properties

Back Color: Define back color for the historical trend component.

Text Color: Define color for the text to be displayed on Historical trend component.

Grid Color: Define color for the grid available on Historical trend component.

Direction: Define direction of the historical trends. Horizontal and Vertical directions are available for selection.

Date Format: Select the date format to be displayed on trend object.



Text font: Define text font displayed on Historical trend component.

Index Time Tag: It is the tag to display current pointer time at Run time in HMI itself. Create any **String type** internal tag and link to this. Later, you can insert Label object and then link with above string type tag to display Time

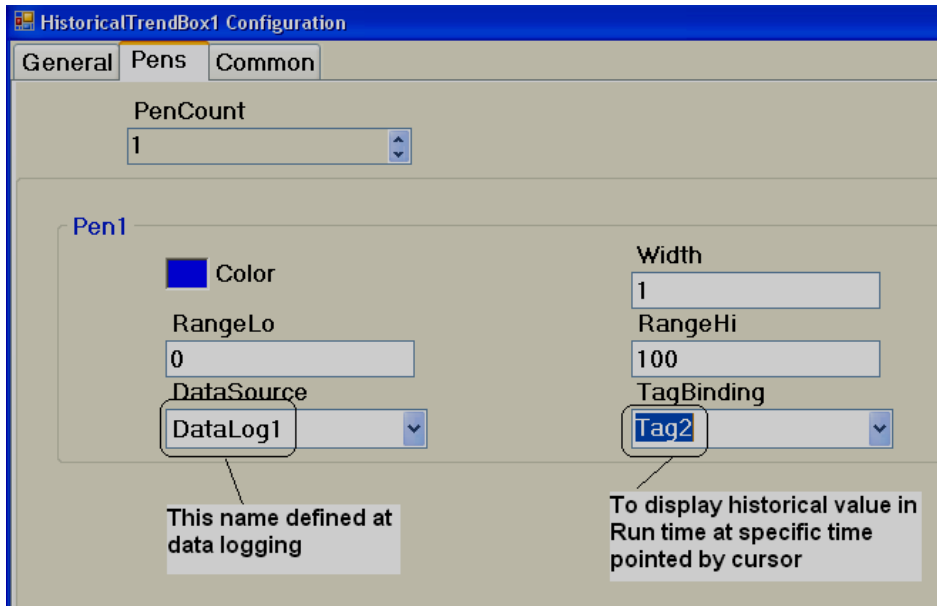

Pen Count: Define number of pens to be displayed in historical trend component. Maximum 24 pens are allowed. Click on “Up” arrow to add additional pen.

Color: Define color for the pen. Here, Blue color is selected for Pen1.

Width: Define width of pen.

Range Low: Define Low scale value for selected pen.

Pen Width: Define high scale value for selected pen.

Data Source: Select the Data log name defined at data logging. For example, DataLog1 for Tag1

Tag binding: This is to select Tag to be used to display historical value via “digital box” component in Run time in HMI screen with cursor pointer. (Please do not select Tag1 again here). This tag is only to link with object say Digital box component later for historical data archival in Run time via cursor pointer.



, Link this with Tag2 and write as Tag1 in Attribute1



Since Blue color is selected for Tag1 pen, you may select back ground color of Digital box also as blue color for clear understanding to operators.

Step3: Add buttons and configure historical functions.

Historical functions supported include navigation to First Page, Previous Page, Next Page, Last page and also zoom functions like Zoom Out, Zoom in, Zoom all etc.

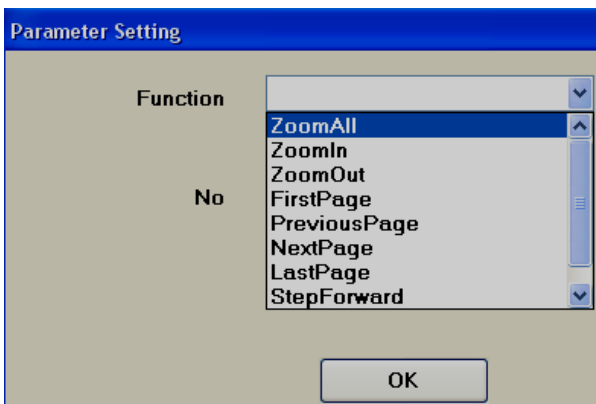
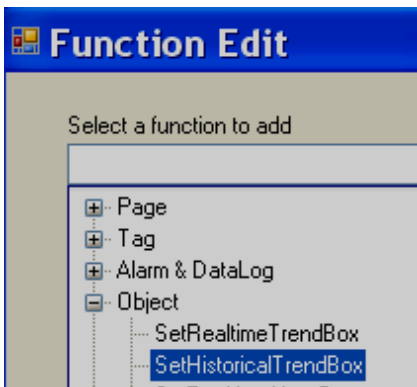
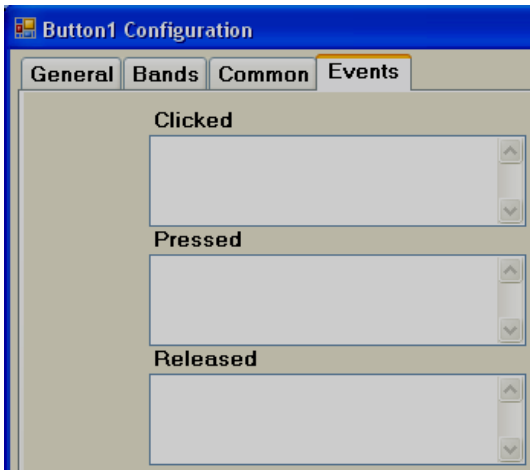

Step4: Add Data log control buttons if required.

Data log functions supported include Start data logging, Stop data logging, Clear Data and Dump data to USB stick etc.

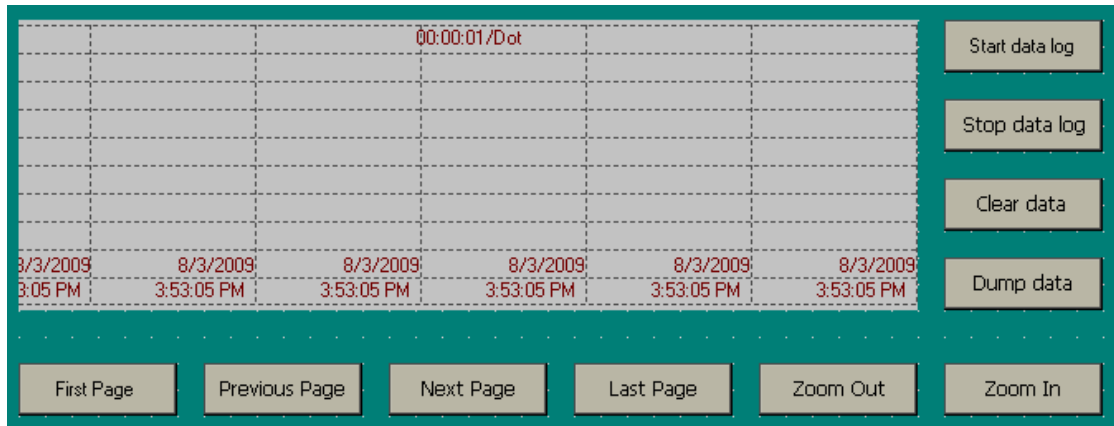

How to refresh historical trend automatically once in 10 min. in HMI at Run time

Use scheduler and define configuration as follows.

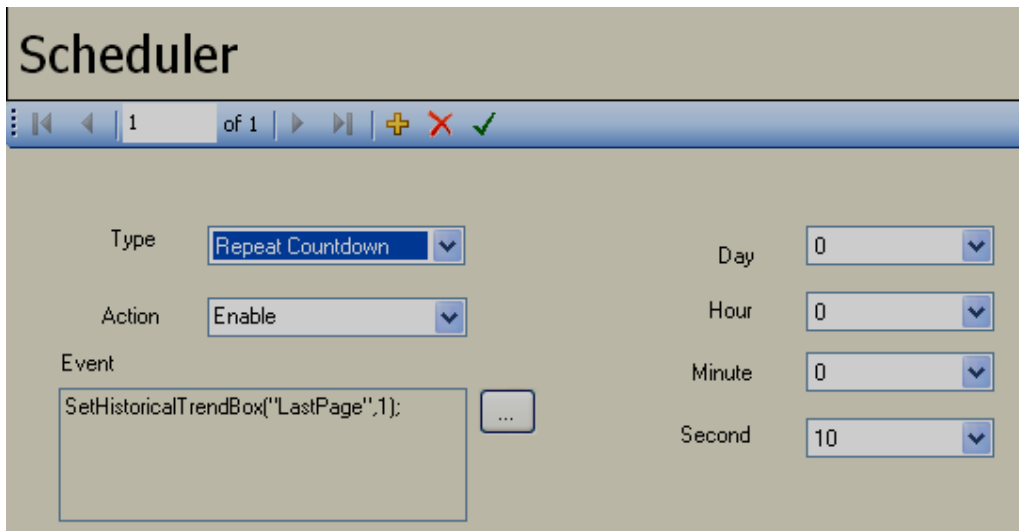

How to select Historical data source to internal memory or SD card

Source for historical data storage should be defined during design time. SD card is optional and it is available in some HMI models.

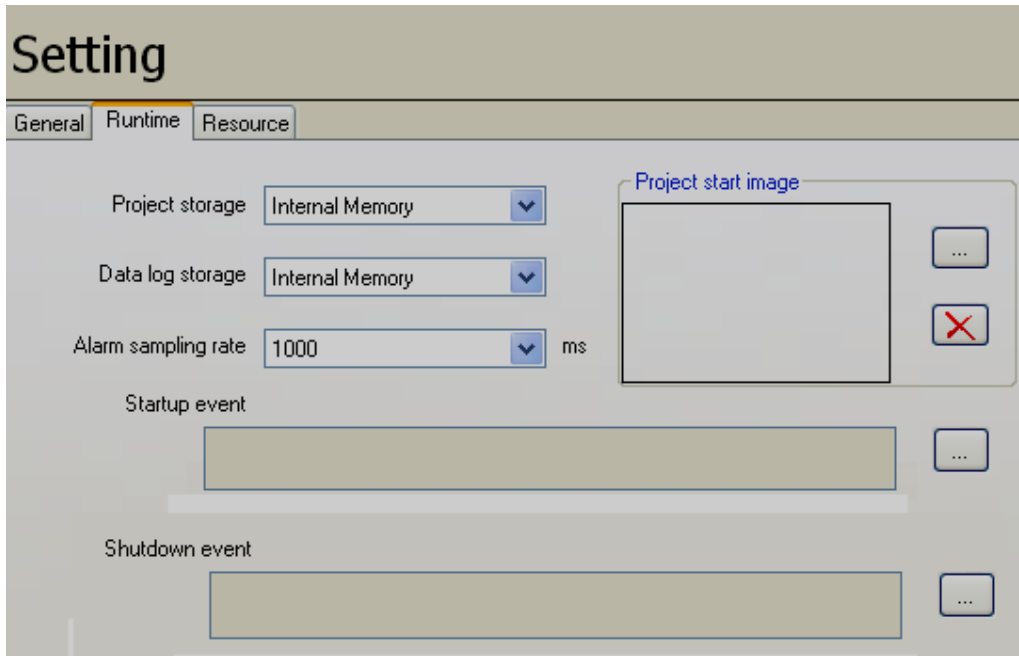

6.7.2.9 Real Time Trend Box

Real time Trend box is Graphical User Interface widget is used to display Real time trends for the process values in Run Time.

Insert Real Time trend box in screen and configure all the properties. Maximum 24 pens are supported in each Real time trend box.

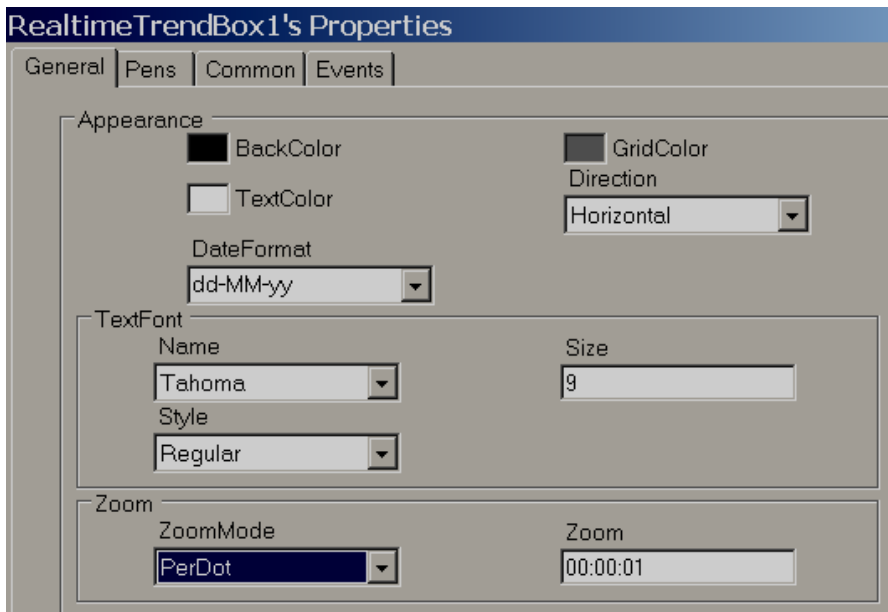

Properties

Back color: Define back ground color for Real time trend box.

Grid Color: Define color for the grid in Real time trend box.

Text Color: Define color for the text displayed (Date/Time) in Real time trend box.

Direction: Define Horizontal/Vertical to display Real time trend.

Text Font: Configure font properties like Font name, size, style for above text.

Zoom Mode:

Per Dot: Enter value at Zoom to reflect time period for the Trend.

For example, zoom value = 00:00:01 indicates, one data point = 1 sec

For example, zoom value = 00:00:05 indicates, one data point = 5 sec

Per Page: Shows value for the total time period for the current page at Zoom value

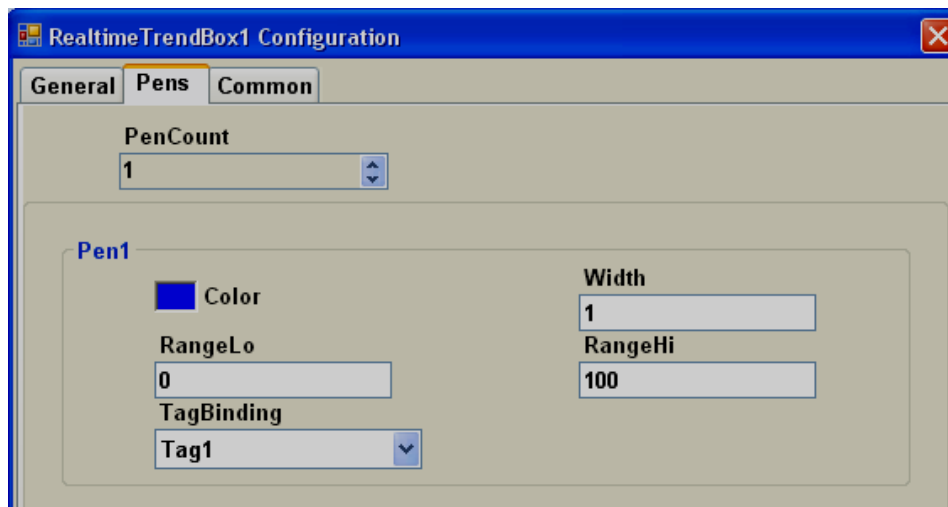

Pens: It is to configure required pens to view on specific Real time trend object in Run time. Use Up button at Pen count to add pens and then configure all the properties for specific pen say Color, Width, Range, Tag binding etc.

6.7.2.10 Picture box

Picture box permits the user to link different picture file into Picture box component during design time and then later view them in Run time based on value of Tag. Supported formats includes

Bitmap file (*.bmp)
Windows Metafile (*.wmf)

JPEG File (*.jpg)
 Graphics Interchange format (*.gif)
 Portable Network Graphic (*.png)

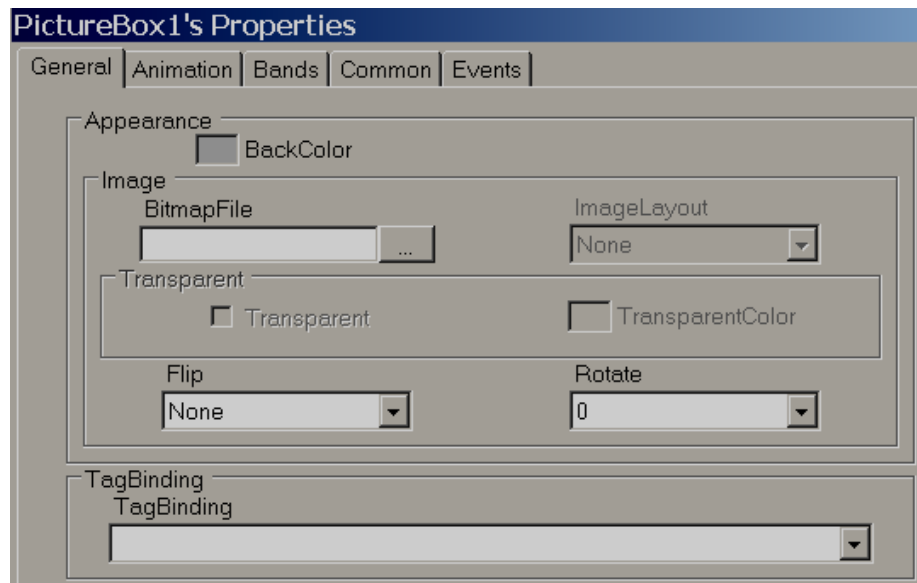

Properties

Bitmap file Select the image to be shown in the object

Flip: It is to flip picture file in design time. Available options are Horizontal, Vertical, Both and None.

Rotate: It is to select direction for the picture file in design time to adjust direction. Available directions include 0°, 90°, 180° and 270°

Tag Binding: Select the Analog tag to be linked with Picture box.

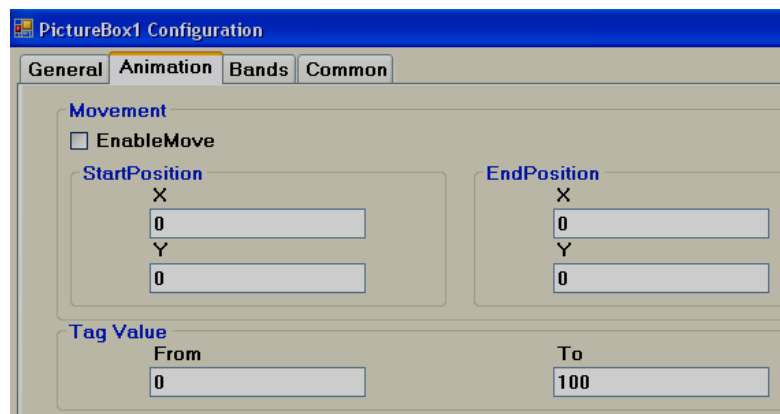

Movement: Select Enable Move if it is required to move picture in Run time from Location 1 to Location 2 based on tag Value. Start and End coordinates for X and Y needs to be configured in Design time and Picture moves in Run time based on Tag value.

Tag Value: Define Tag value

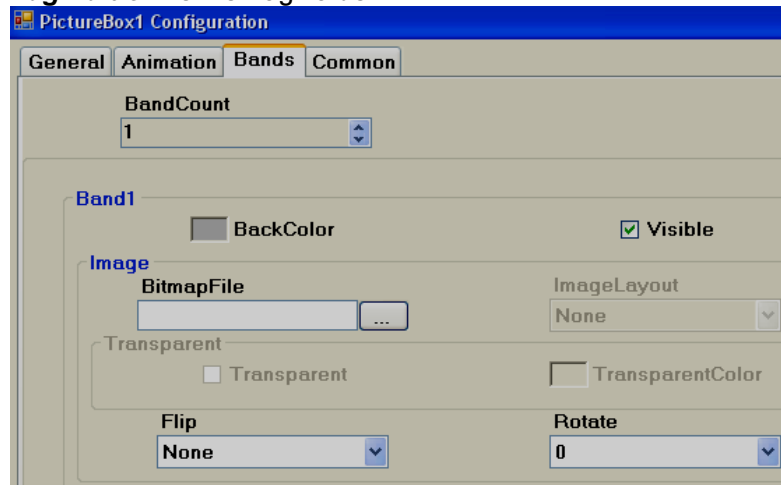

Band Count: Define number of bands required.

Back Color: Define back color for the selected picture file in specific band.

Visible: Define visibility for the picture in specific band.

Bitmap file: Select picture file for specific band.

Image Layout: Position of image with in Picture container. Available options include None/Center/Stretch. When stretch is selected, it attempts to fit picture file to the size of container.

Transparent: Select if no back color is required for picture file.

Flip: It is to flip picture file in design time. Available options are Horizontal, Vertical, Both and None.

Rotate: It is to select direction for the picture file in design time to adjust direction. Available directions include 0°, 90°, 180° and 270°

Example: You may take a photo of a section of the factory floor like a tank and use this in HMI screen instead of default symbols.



If a bitmap file by name sunset.jpg is linked with Picture box1 in screen1. If you wish the same sunset.jpg in screen no2, do not create picture box and link with sunset.jpg again. Since a resource with name sunset already available, if you try to use the same image in other place, it may not allow you to do so and may prompt with error message. If you really need the same image again, copy picture box1 at screen1 and paste it in screen no 2.

6.7.3 Graphics

It is to select a symbol in screen like a Tank, Motor etc... Basic symbols are available in HMI Editing Software and it includes the following symbol categories.

Symbol categories

	Category	Symbols	Colors	Qty
1	Arrows	7	6	42
2	Blowers	5	6	30
3	Boilers	4	6	24
4	Conveyors	6	6	36
5	Instruments- True Color	7	C	7
6	Lamps	4	6	24
7	Material handling	8	C	8
8	Motors	4	6	24
9	Nature-True Color	6	C	6
10	Office-True Color	7	C	7
11	Pipes	10	6	60
12	Power-True Color	7	C	7
13	Pumps	5	6	30
14	Push buttons	8	6	48
15	Tanks	5	6	30
16	Valves	8	6	48
17	Vehicles-True Color	6	C	6

C = True Color

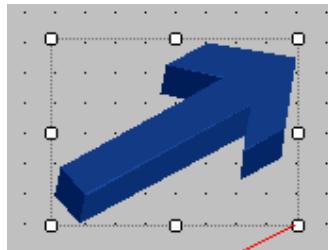
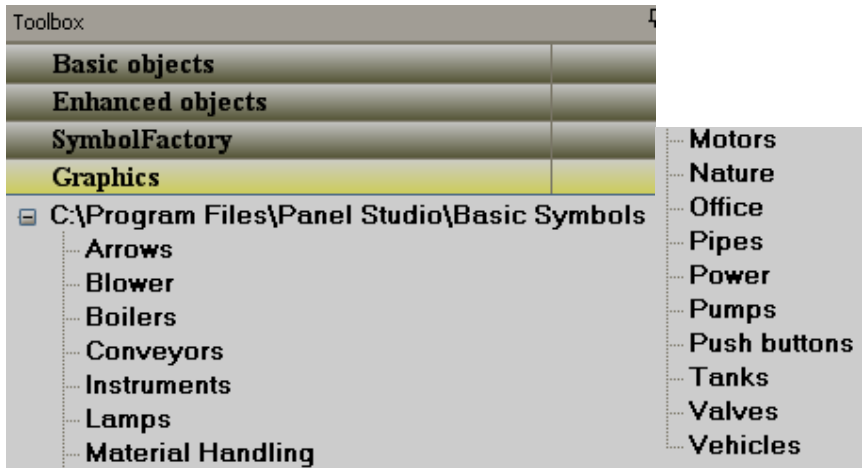

Use these cursor points to change the size

Some symbols are available with 6 different colors in Red, Green, Yellow, Blue, Brown and Grey.

All the symbols are vector graphics, occupies less memory space with high quality.

It is possible to set transparent property for symbol in design time from property grid. Transparent means screen color itself will appear as back ground color. Also, it is possible to change symbol back ground color during design time and Run time.

How to set transparent property to symbol from property grid

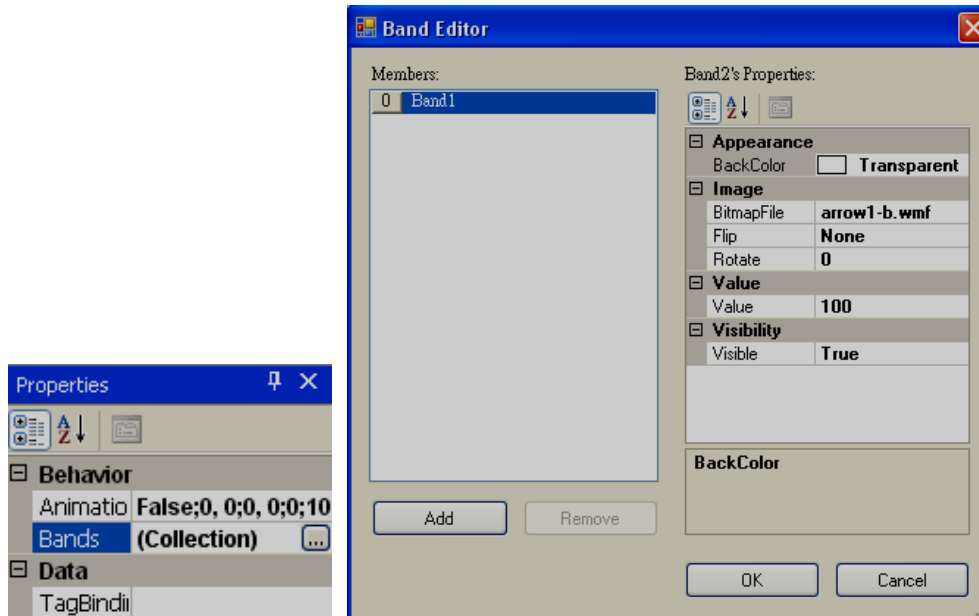

Click at ... at Bands and then select Back Color = Transparent

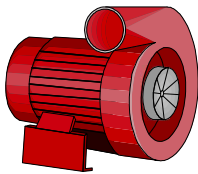

Fig: Back color=Transparent

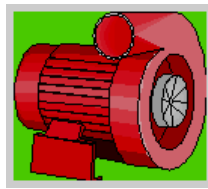

Fig: Back Color=Green color

Since all are vector symbols, if symbol is enlarged, it does not lose quality.

When HMI Editing Software is installed, all the basic symbols will be installed at default folders C:\Program Files\HMI Editing Software\HMI Editing Software\Basic Symbols

However, if applications developer has any additional symbols, they can be arranged in folders and placed along with standard basic symbols and keep them in above path.

Example: Create a folder by name "Custom" and copy it to C:\Program Files\HMI Editing Software\HMI Editing Software\Basic Symbols

It is possible to set path for graphic symbols in HMI software. In Menu bar, Click on "File", then select "Environment" and then select "Graphics path" such that all these will appear in a tree structure directly with in HMI editor such that no need to import these kind of symbols using special component "Picture Box".

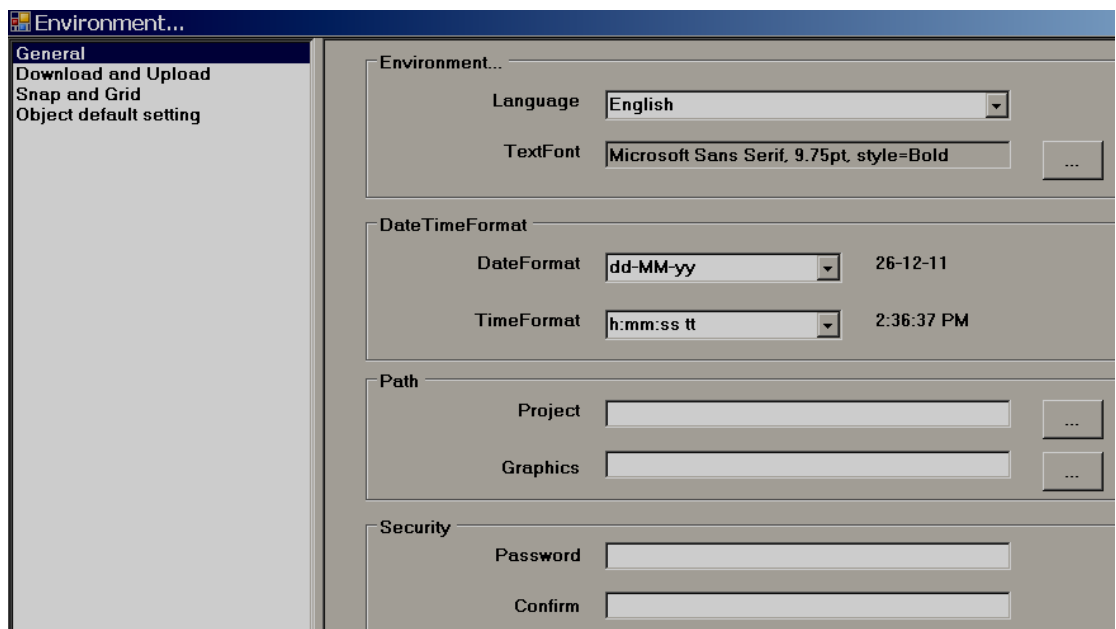
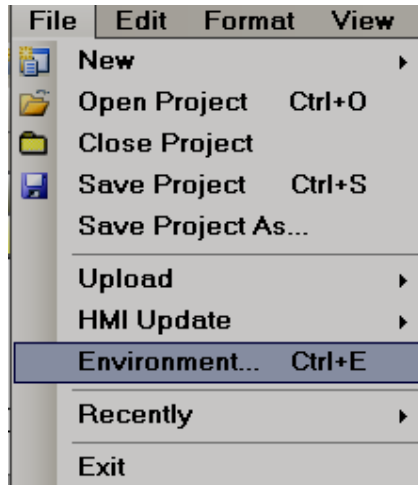

Once symbol is selected in HMI from Graphics, then if required it is possible to change Flip or rotate basic symbols in 0° , 90° , 180° and 270°

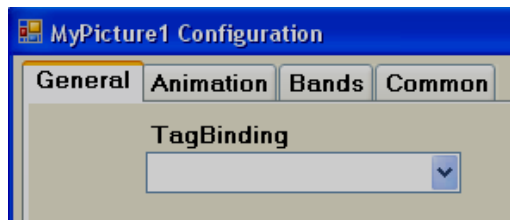

Properties

Tag Binding: Select Analog Tag if animation is required for the symbol in Run time.

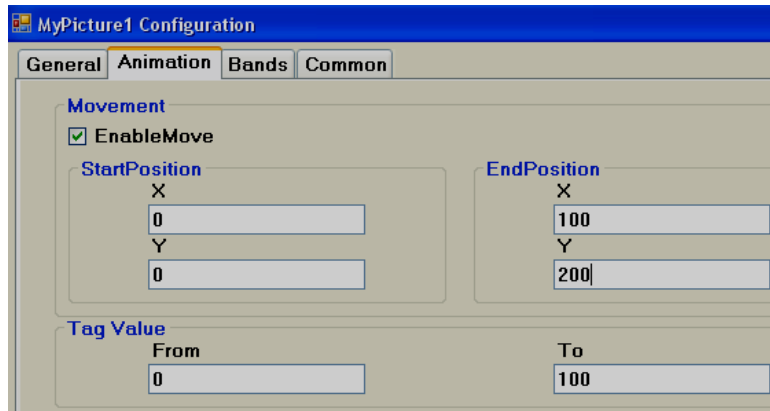

Movement: Select Enable/Move and then, enter X and Y start and end positions in pixels.

Tag Value: It is linked with Start and End Positions.

Ex: HMI 7" (HIGH PERFORMANCE), Screen Resolution = 800 X 480, Horizontal installation, Width=800, Height=480. Move symbol from Left to Right in screen at Run time when tag value changes from 0 to 100

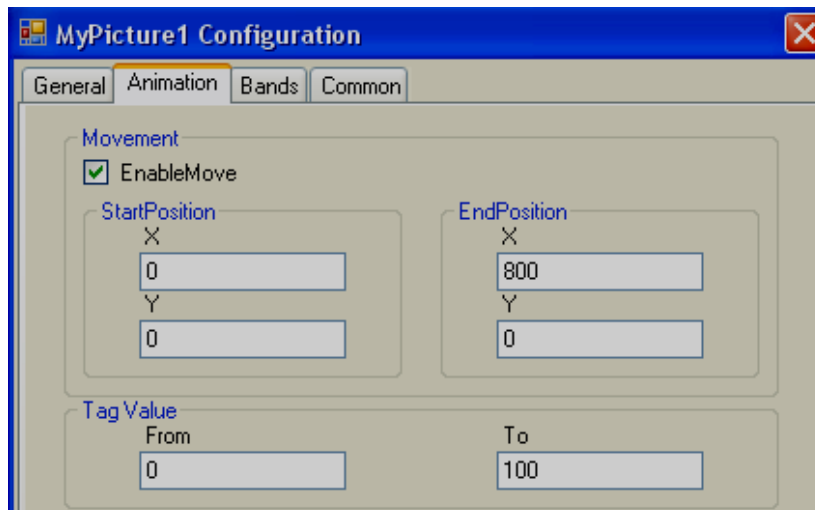

To move symbol from Left to Right, set start and end Positions for X coordinate in pixels and there is no need to set Y coordinates.

Tag value = 0 corresponds to Start Position (X)

Tag value = 1000 corresponds to End Position (X)

Ex: HMI 7" (HIGH PERFORMANCE), Screen Resolution = 800 X 480, Horizontal installation, Width=800, Height=480. Move symbol from Top to Bottom in screen at Run time when tag value changes from 0 to 100

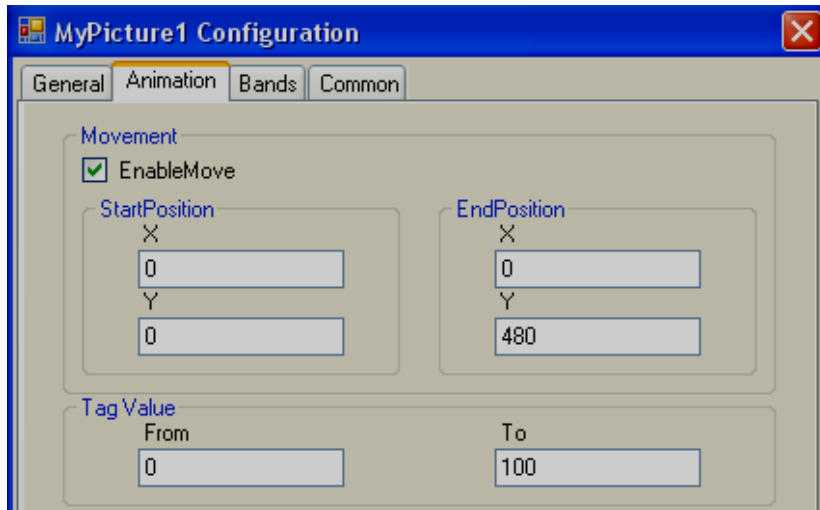

Ex: HMI 7" (HIGH PERFORMANCE), Screen Resolution = 800 X 480, Horizontal installation, Width=800, Height=480. Move symbol from Left Top to Right Bottom in screen in angle at Run time when tag value changes from 0 to 100

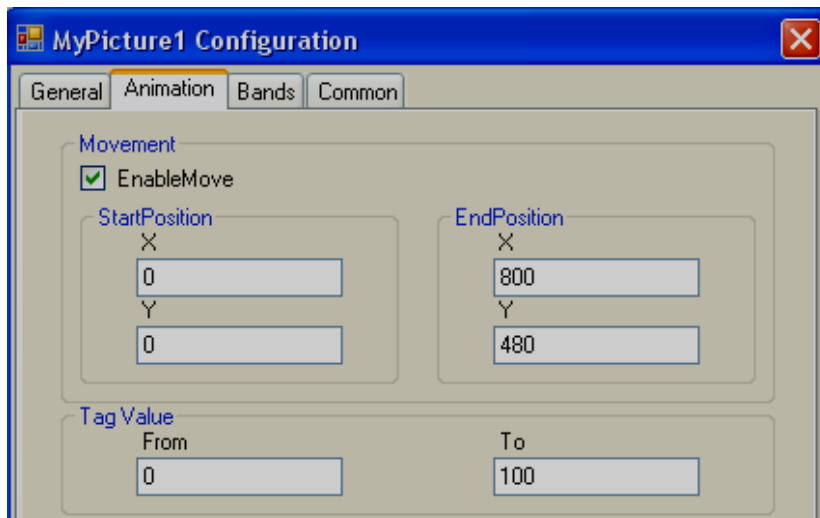

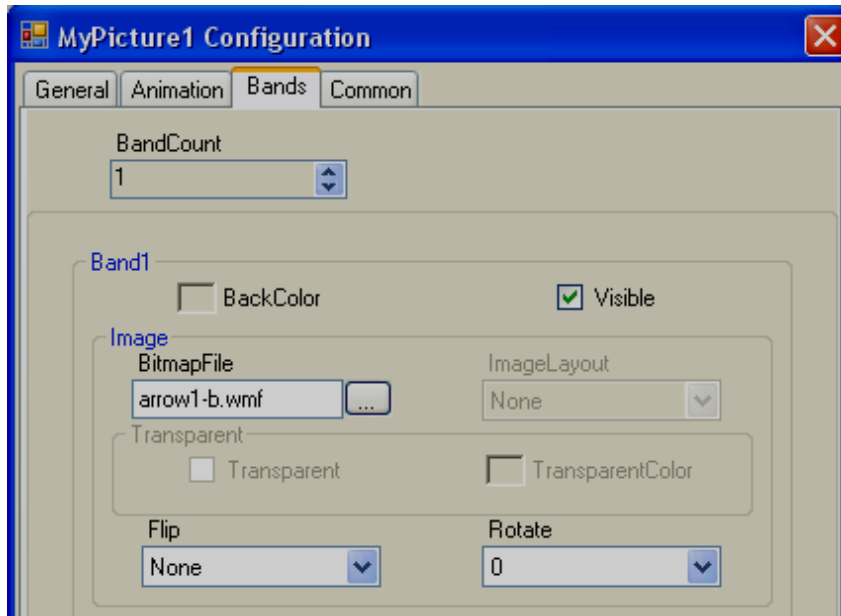

Band Count: It is to define bands for run time animation of symbol. Max. 32 bands are supported.

Back Color: Define Back Color of symbol to appear in specific band in Run time.

Visible: Define visibility control for symbol in specific band in Run time.

Image: Select different image file if required to display in specific band in Run time.

Flip: Define flip position for the symbol in specific band in Run time. Available options include None, Horizontal, Vertical and Both.

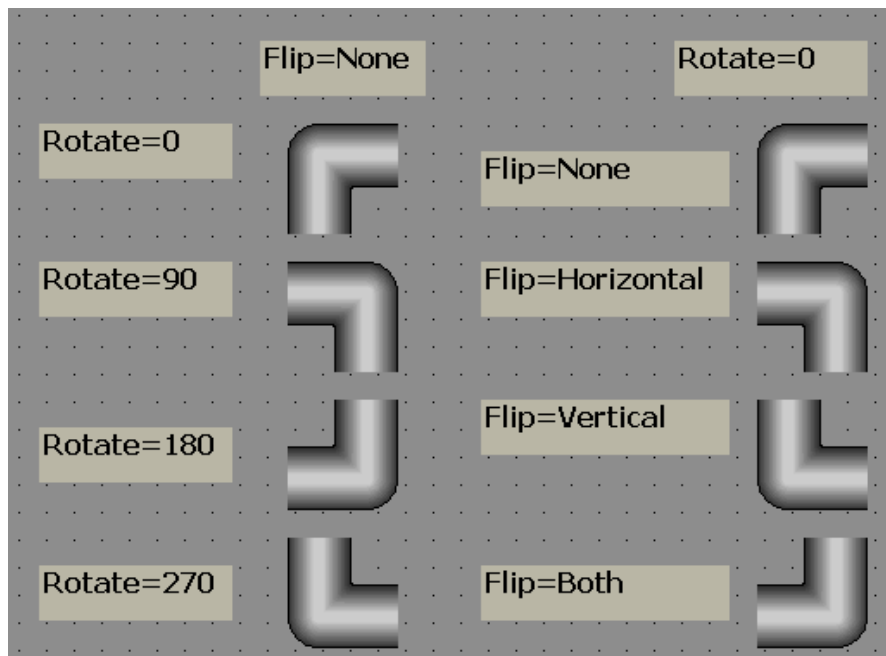

Rotate: Rotate symbol to any predefined direction in specific band at Run time. Available options include 0°, 90°, 180° and 270°

Example: There is Liquid level Tank. When, Tag value =0, an arrow should appear in Down direction indicating discharge of tank is in progress and when Tag value = 1, arrow should appear in Up direction indicating filling of tank is in progress.

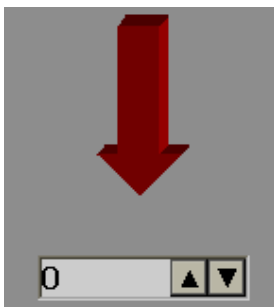
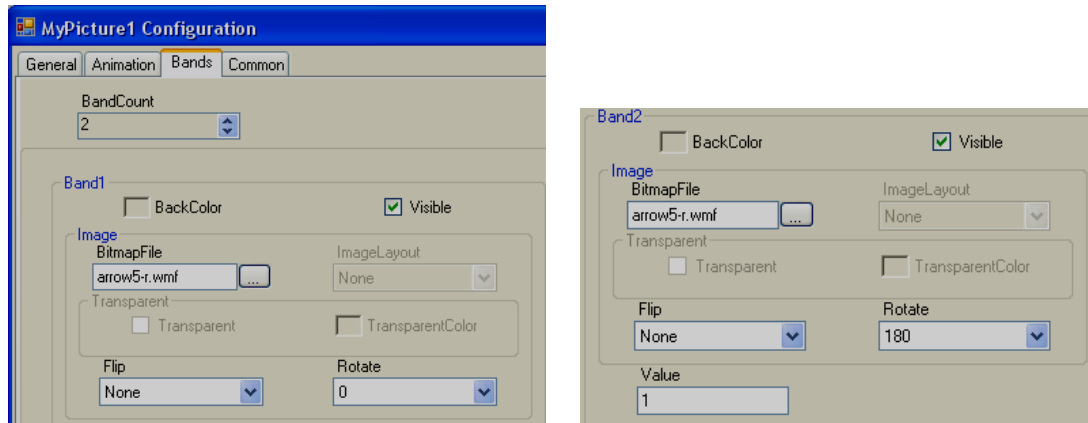

6.7.4 Symbol Factory

Symbol Factory® contains more than 4000 symbols in 64 categories.

No.	Category	Symbols	No.	Category	Symbols
1	3-D Pushbuttons Etc.	73	35	Machining	90
2	Air Conditioning	140	36	Maps and Flags	23
3	Architectural	49	37	Material Handling	118
4	Arrows	63	38	Mining	63
5	ASHRAE Controls & Equipment	100	39	Misc. Pipes	39
6	ASHRAE Ducts	86	40	Misc. Symbols 1	57
7	ASHRAE Piping	49	41	Misc. Symbols 2	79
8	Basic Shapes	86	42	Mixers	24
9	Blowers Etc.	34	43	Motors	38
10	Boilers	36	44	Nature	71
11	Buildings	42	45	Operator Interface	28

12	Chemical	50	46	Panels	14
13	Computer Hardware	38	47	Pipes	82
14	Computer Keys	68	48	Plant Facilities	52
15	Containers	56	49	Power	61
16	Controllers	35	50	Process Cooling	20
17	Conveyors, Belt	40	51	Process Heating	61
18	Conveyors, Misc.	26	52	Pulp & Paper	35
19	Conveyors, Simple	56	53	Pumps	99
20	Ducts	51	54	Safety	27
21	Electrical	83	55	Scales	36
22	Finishing	45	56	Segmented Pipes	41
23	Flexible Tubing	24	57	Sensors	55
24	Flow Meters	35	58	Tank Cutaways	23
25	Food	72	59	Tanks	145
26	General Mfg.	68	60	Textures	181
27	Heating	108	61	Valves	73
28	HVAC	74	62	Vehicles	41
29	Icons and Bitmaps	159	63	Water & Wastewater	112
30	Industrial Misc.	19	64	Wire & Cable	21
31	International Symbols	42		Total	4045
32	ISA Symbols	183			
33	ISA Symbols (3-D)	123			
34	Laboratory	23			



With HMI Editing Software, only first symbol from symbol factory can be selected. If you need all symbols, order HMI Editing Software Plus software and we will supply USB hardware lock to access more than 4000 symbol factory graphics



It is possible to link Analog Tag with Symbol factory graphic and change colors in Run time. 50 bands are supported

The screenshot displays the HMI software interface. On the left, a 'Symbol factory' panel lists color bands: '< 10 : Yellow Blinking', '10 to 19 : Yellow steady', '20 to 79 : Green Color', '80 to 89 : Red Color', and '> 90 : Red Color blinking'. A central graphic shows a pump with a 'Run time' display at '14:20:15' and a 'Max.50 band' label. At the bottom are navigation buttons: 'First Page', 'Next Page', 'Previous', and 'Last Page'. On the right, the 'Properties...' window shows the 'Data' section with 'TagBinding' set to 'Tag6'.

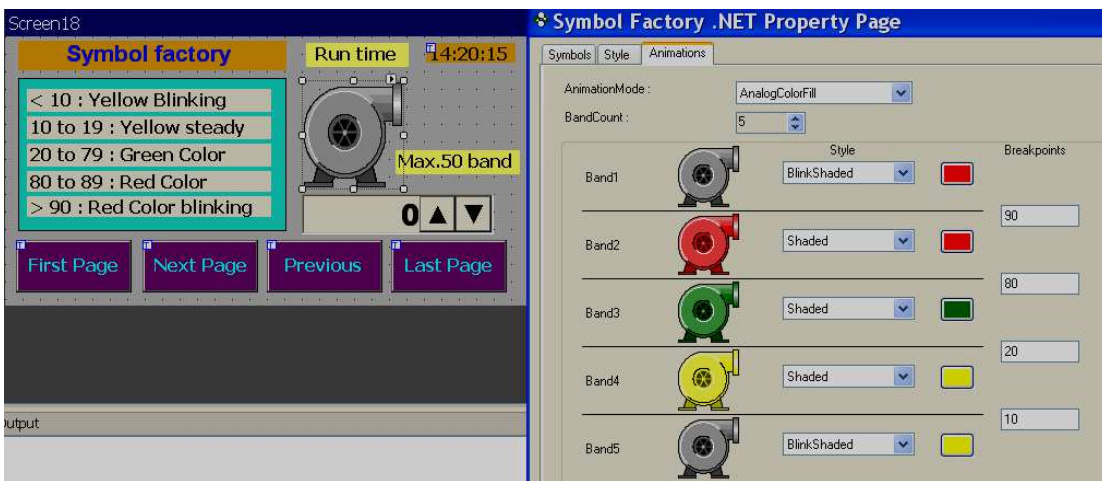
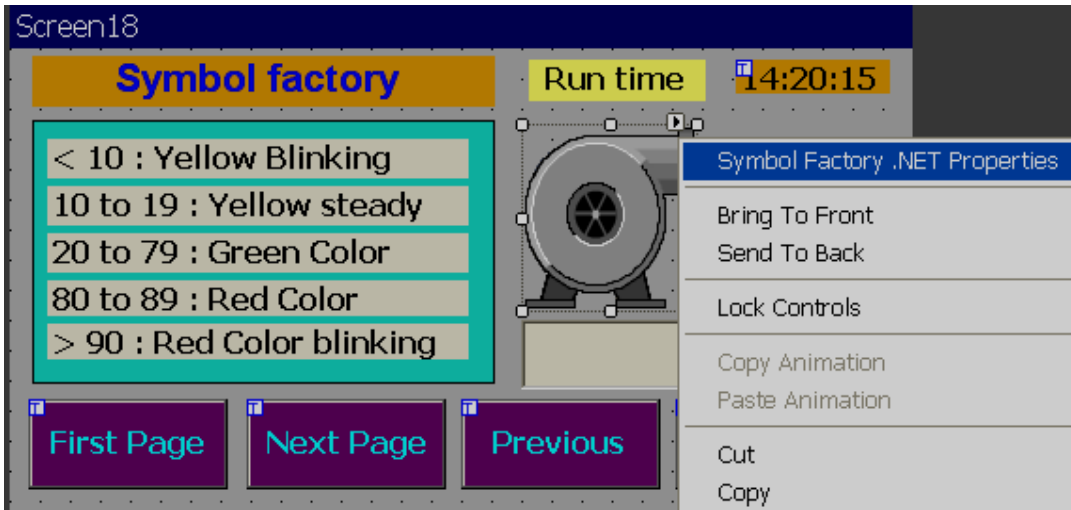

Design Time

In design time it allows to you to change colors of these symbols by application engineer.

Example: Change tank color from standard grey scale to Green color.

Task: Place symbol on a screen

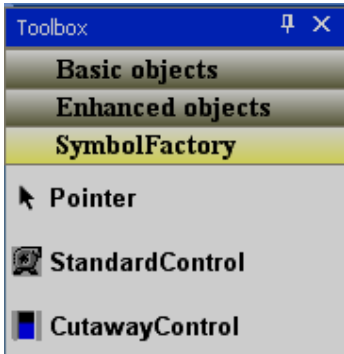

In Tool box, click on “Symbol Factory” and then, drag and drop standard control to screen.

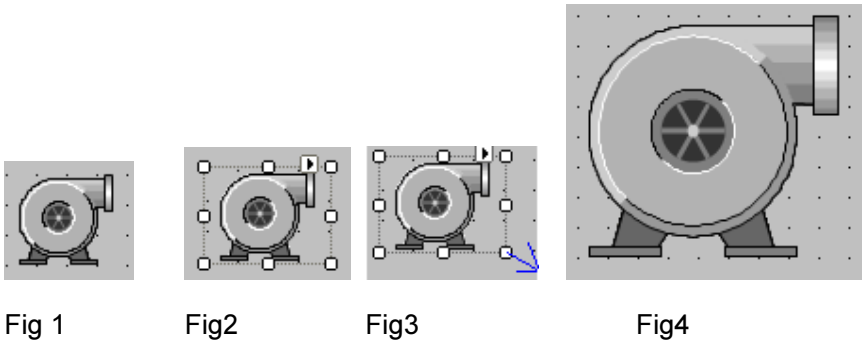

Task: Increase size of symbol

Select the symbol in screen and it will be as shown as Fig2

Then, move mouse to a square pointer till arrow appears and then hold left click at mouse and drag to increase size of symbol as per your requirement and then it will be as shown in Fig4. Alternatively, in property grid, enter size in pixels as shown attached.

Size	120, 100
Height	100
Width	120

Task: Changing symbol to another category

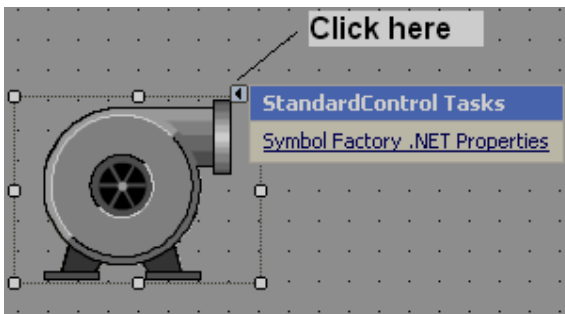

Drag and drop symbol factory component into screen.

Click on  and then click on Symbol Factory.NET Properties.

Alternatively, select the symbol factory component using single click (left) by mouse, keep mouse cursor on symbol, then, double click (left) in mouse to open symbol properties, then, it shows following screen.

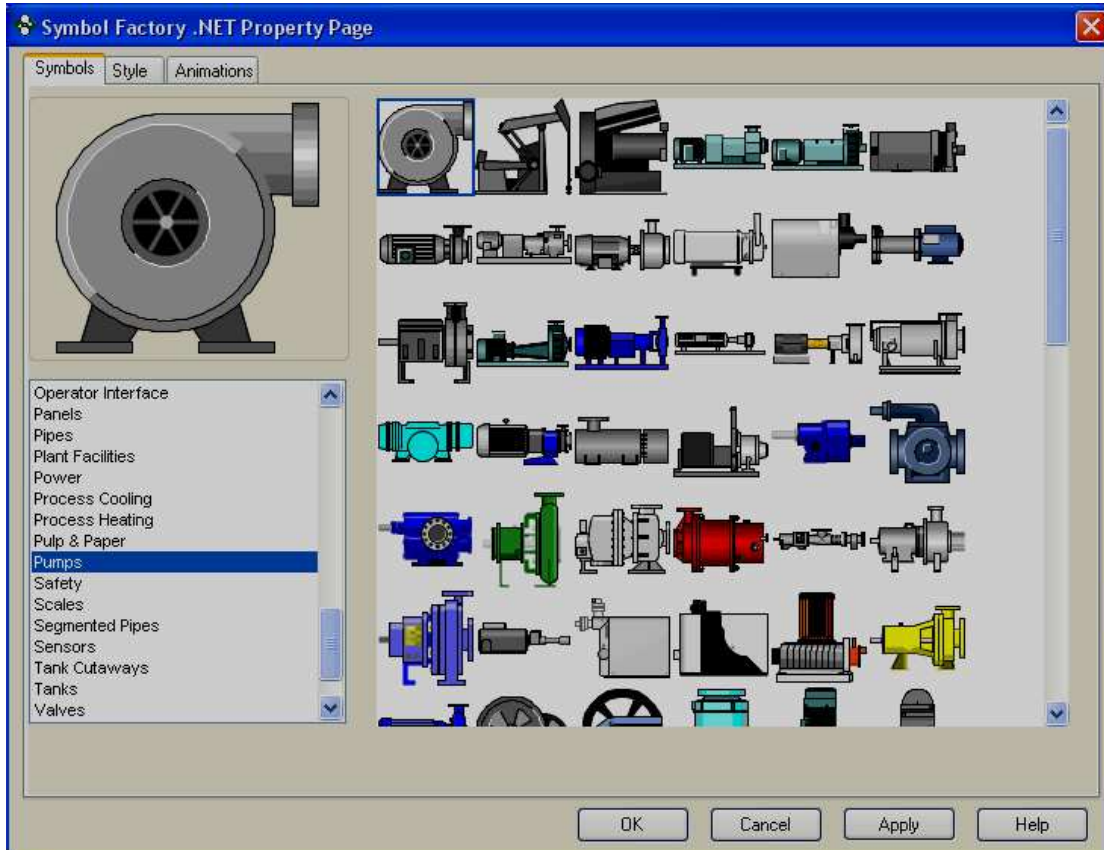

Select the required category, select the symbol and click on button “OK”, then new symbol will be placed in screen.



Click on Help in above screen to open Chm type help file (English) for symbol factory.

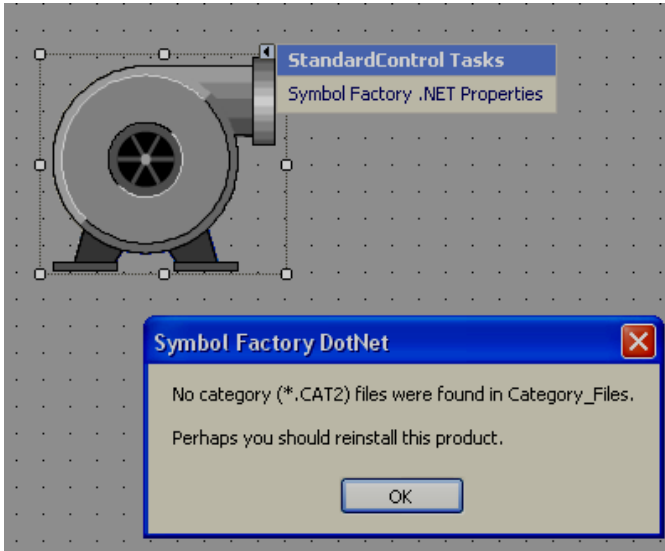

If above error message appears, then, it is required to reinstall symbol factory.

Style

It is to define style of symbol in design time.

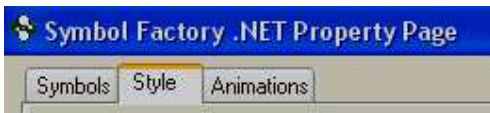

Click on "Style", then "following screen will appear.

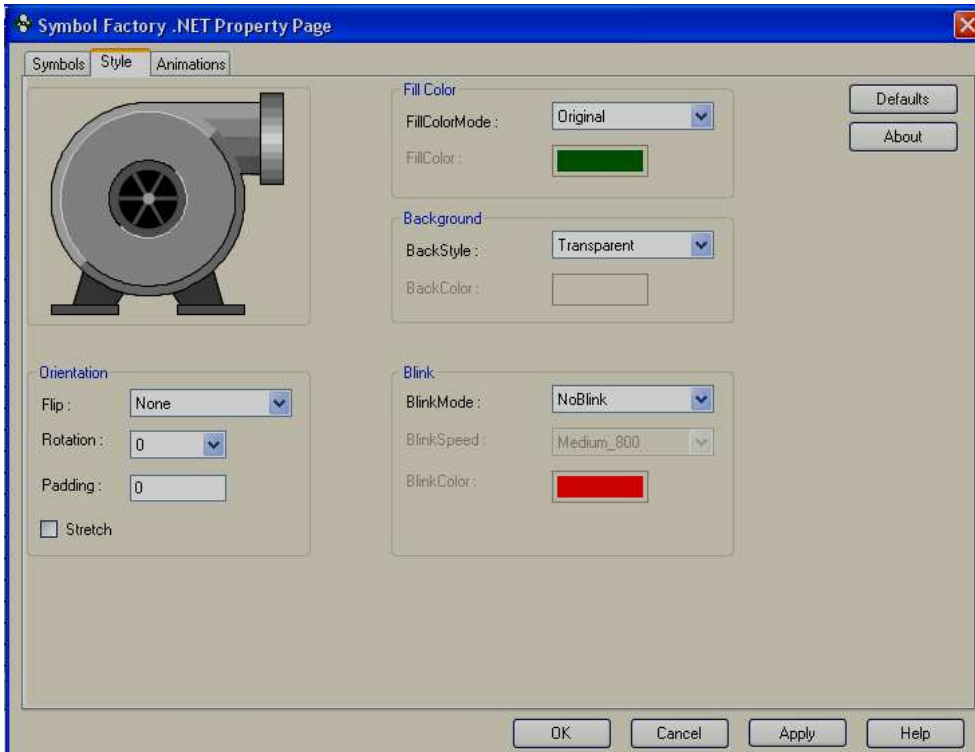
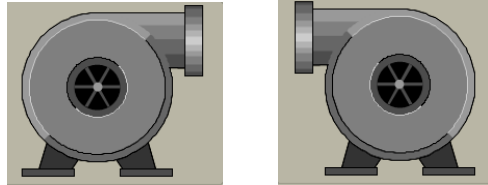

Fig: Default Style settings

Orientation:

Flip: It is possible to flip symbol in Design time and available options include Horizontal, Vertical, Both and None.



Flip=None

Flip = Horizontal

Rotation: It is possible to rotate symbol in design time and available options include 0°, 90°, 180° and 270°

Padding: Normally it is 0. It is used to decrease size of symbol with in selected boundaries.

Stretch: It is used to stretch symbol with in selected boundaries.

Fill Color:

Fill color mode: Available options include Original, Shaded, Solid and Hollow.

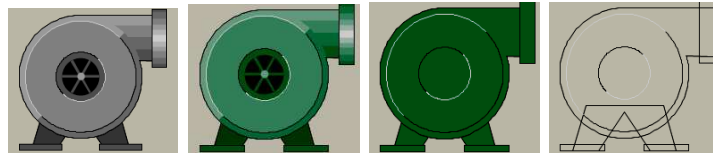

Fill Color Mode: Original
Fill Color: N.A

Shaded
Green

Solid
Green

Hollow
N.A

Fill color: Define color to be filled in Shaded and Solid fill color mode.

Background:

Back Style: Available options include Transparent & Opaque. Transparent means screen background color will appear for symbol. Opaque means, it is possible to set different background color for specific selected symbol.

Back color: Define background color when back style = Opaque.

Blink:

Blink mode: Available options include No Blink, Blink Invisible, Blink shaded and Blink Solid.

NoBlink: Blink is not required for symbol either in design time or Run time. Blink Speed and Blink color = Not available for selection.

BlinkInvisible: Symbol will appear and disappear cyclically in both design time and Run time as per set Blink speed. Blink color: Not Available for selection.

BlinkShaded: Symbol will flash, total 2 colors, one color at a time on same symbol as per set blink speed in both design time and Run time.

Example

Fill Color mode = Shaded, Color = Green

Blink shaded setting: Blink mode=Blink shaded, Blink speed = Medium_800, Blink color = Blue

Then, green color shaded symbol appears first time, then symbol turns into blue color shade after elapsing time at blink speed setting.

Blink speed: Define blink speed. Available options include Fast_400, Medium_800, Slow_1200. Its period is in **ms**.

Blink color: Define background color



Normally, blink is not used in design time and default settings will be as follows

1. Fill Color Mode = Original. If different color is required for symbol, select Fill color mode = Shaded and then define Fill color
2. By default, Back Style = Transparent in Background
3. By Default, Blink mode = NoBlink

Animation

It is to define animation for the symbol to appear at Run time in HMI.

Animation mode:

Define animation mode. Available options include Analog Color Fill, Discrete color fill, Analog integer color fill.

AnalogColorFill: Select this option if you wish to link analog type tag and then define band for the colors. For ex: 0 to 10, Color = Yellow, 10-90, Color = Green, 90-100, Color = Red etc..(See next section "How beak points work for more details)

DiscreteColorFill: Select this option if you wish to pass discrete values like 1,2,3... in Run time to the Tag linked with symbol for display of different colors. See next section “How beak points work for more details)

AnalogIntegerColorFill: This is same as Analog color fill, but only integer value is passed to the Tag linked with symbol. See next section “How beak points work for more details)

Band count: Define number of bands required for selected Animation mode

Styles: Define style of symbols. Available options include Original, Shaded, Solid, Blink Invisible, Blink shaded and Blink solid. All definitions are same as explained earlier.

6.7.4.1 How break points work

The idea behind Breakpoints is that certain animation will occur when a property of the component changes. If this change falls within the defined parameters (see below), an animation will be triggered

Please note: The screen shots in the examples below are based upon the Symbol Factory .NET Standard Control, but the same principle applies to the Cutaway control.

Two types of animation can be defined based upon the setting of Animation Mode: Analog Break Points and Discrete Break points

Analog Break points (Animation Mode = Analog integer color fill or Analog color fill)

Analog breakpoints are defined as a value on which an animation will trigger when a property on the component reaches that level. Depending upon your component, different properties will need to be changed depending upon the setting of Animation Mode. These properties are:

Component	Animation Mode Setting	Property that Changes to trigger an Animation
Standard	AnalogColorFill	AnalogValue1
Standard	AnalogIntegerColorFill	AnalogIntValue1
Cutaway	AnalogColorFill	Level
Cutaway	AnalogIntegerColorFill	LevelInt

Number and Ordering of Breakpoints

The number of breakpoints available to you is the number of bands defined minus 1. As a breakpoint is defined as the point to which an animation changes, make sure you arrange the breakpoints from high to low. So, for example, suppose you had this screen:



When the value of your property changes, this is what will happen to the control:

Value of Property	Band that is Active	Appearance of Component
Less than 10	Band5	Blink Shaded Red
10 to < 20	Band4	Display Shaded Yellow
20 to < 80	Band3	Original
80 to < 90	Band2	Display Shaded Yellow
Greater than 90	Band1	Blink Shaded Red

If you do not order your breakpoints in descending order, your results will be unpredictable.

Discrete break points (Animation mode = Discrete color fill)

Discrete Breakpoints aren't really breakpoints - instead, they enable animation if the "DiscreteValue" of an element in the BandsCollection is set to true.

However, since multiple DiscreteValue properties can be set at the same time, how does the component determine the animation to display? What it does is give priority to the animations based upon their order in the BandsCollection. If the first band in the collection (by default, Band1) has its DiscreteValue set to True, then that animation will be shown no matter which band also has its DiscreteValue set. As another example, if Band2 and Band5 each has their DiscreteValue set, the animation used will be the one defined in Band2.

Therefore, given the following definition of five bands:



Here is what the animations will be shown based upon different values of Discrete Value

Discrete Value for Band1	Discrete Value for Band2	Discrete Value for Band3	Discrete Value for Band4	Discrete Value for Band5	Appearance of Component
True	False	False	False	False	Blink Shaded Red (Band1)
False	True	False	False	False	Shaded Yellow (Band2)
False	False	True	False	False	Original (Band 3)
False	False	False	True	False	Shaded Orange (Band 4)
False	False	False	False	True	Blink Shaded Black

					(Band 5)
True	True	True	True	True	Blink Shaded Red (Band 1)
False	True	True	True	True	Shaded Yellow (Band 2)
True	False	False	False	True	Blink Shaded Red (Band 1)
False	False	False	False	False	Original (No bands active)

6.8 Project Tools

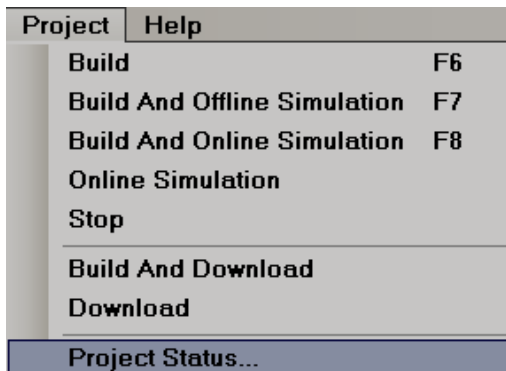

6.8.1 Build

Once project is compiled successfully, it creates build and this file need to be transferred to HMI. If any errors during preparation of build, it shows at output window just below to screen working area. If Output is not visible below screen working area, select it via Menu, "View", and then click at "Output" or apply "Reset window layout" from the Menu-"View"

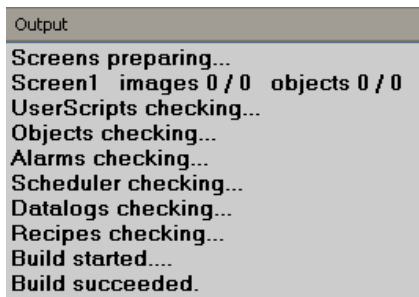



After creating build, if any errors are shown at Output window, do not attempt to download application from PC to HMI or PC to USB flash disk for transferring it to HMI. First clear the errors and make sure that compilation errors are not present before transferring application to HMI.

6.8.2 Build & Offline Simulation

First it creates build and then Run Offline simulation.

It is to test HMI application in PC before downloading application to HMI, without connecting PLC to either PC or HMI. It is possible to enter some values for the tags via table to check how HMI application appears in run time at PC itself with out downloading application to HMI or connecting PLC.

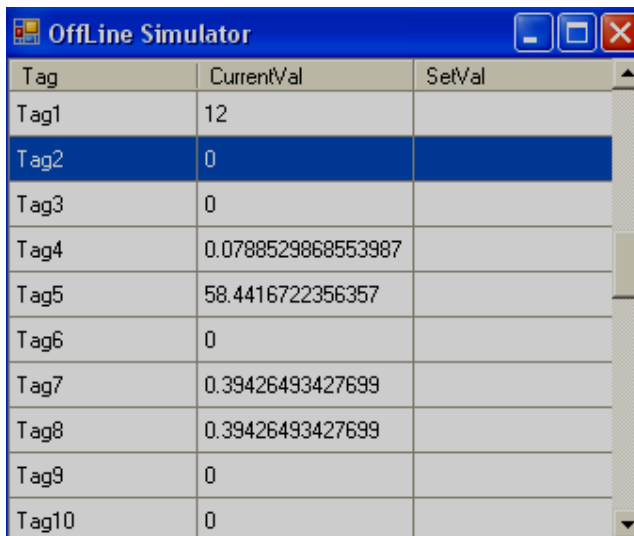

Tag	CurrentVal	SetVal
Tag1	12	
Tag2	0	
Tag3	0	
Tag4	0.0788529868553987	
Tag5	58.4416722356357	
Tag6	0	
Tag7	0.39426493427699	
Tag8	0.39426493427699	
Tag9	0	
Tag10	0	

Enter value at “SetVal” column and then press enter key in keyboard, then, it accepts and shows at “CurrentVal”, then, you will be able to see these values in objects linked with specific tag.



It is better to run offline simulation frequently say once in couple of hours or after completing specific screen editing by application engineer to verify how it works in HMI such that if there are any compilation errors, it is easy to locate and rectify them to save time.

6.8.3 Build & Online Simulation

First it creates build and then Run Online simulation.

It is to test HMI application in PC before downloading application to HMI, connecting PLC to PC.

6.8.4 Online Simulation

Online simulation: It is to test HMI application in PC before downloading application to HMI, connecting PLC directly with PC. It works for 2 hrs only.

6.8.5 Stop

It is used to stop simulation program in PC. When online simulation or Offline simulation is running in PC, click on  icon in PC to stop the current running simulation.

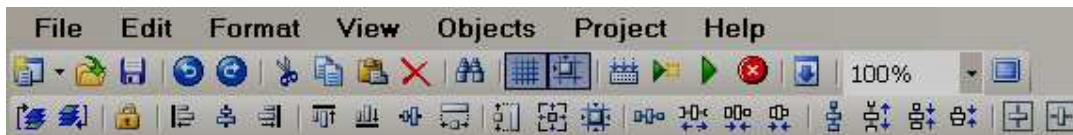

Task bar

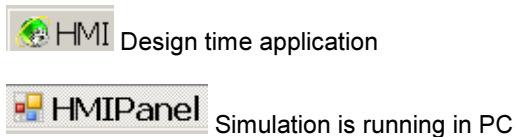

Fig: Icons in Task bar (Bottom area of screen in PC)



If Offline simulation or online simulation is already running in PC and user attempts to run it again, build will fail. It prompts error message similar to the following



Screen1

Build Started....

Could not write to Output file "C:\Program Files\Project\HMI\Panel.exe"

"The process cannot access the file because it is being used by another process"

Build Failed

In case if the above message is prompted, click on Stop icon  couple of times and make sure that icon  is not available in Task bar. Again click on "Build" once and then run simulation.

6.8.6 Build & Download

It is to build first and then download application from PC to HMI.

6.8.7 Download

It is to download application from PC to HMI

Available options

- i) PC to HMI via Ethernet
- ii) Removable Disk to HMI via USB flash disk

PC to HMI via Ethernet:

After creating application, create build in PC and make sure there are no compilation errors.

Connect Ethernet cable between PC and HMI

Check IP address of HMI in HMI itself via System information.

In HMI editor software, set Environment for Download via Ethernet and enter IP address of HMI. In Environment, Select "Ethernet" at Download and then, Click at "OK" button.

In HMI editor software, click at "Project", then click at "Download" or click at  icon.

It builds and transfers application from PC to HMI. If there are any errors during compilation, it needs to fix compilation errors first and then download it again.

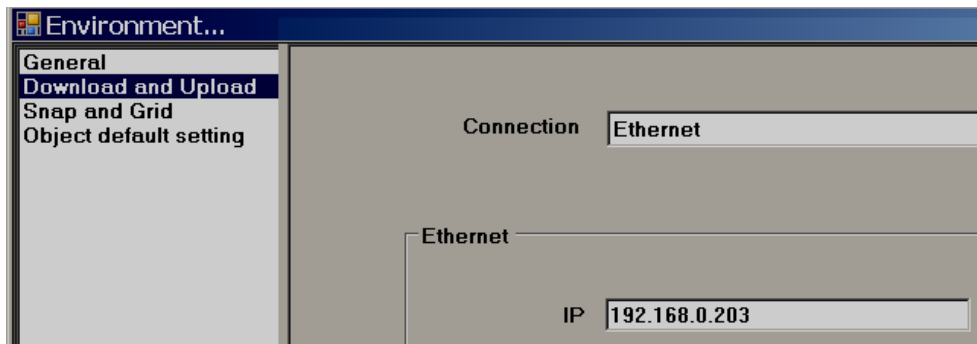

Removable disk to HMI

After creating application, create build in PC and make sure there are no compilation errors.

Connect USB flash disk in to PC via USB port.

In HMI editor software, set Environment for Download via Removable disk. In Environment, Select "Removable disk" at Download and then, Click at "OK" button.

In HMI editor software, click at "Project", then click at "Download" or click at  icon.

It transfers application from PC to USB flash disk.

Insert USB flash disk in HMI.

Switch on Power supply to HMI. Press at “Load”, select Path of project files and then press at “Load” button near path selection.

It transfers application from USB flash disk to HMI.

PC to HMI via USB to Ethernet Converter

For Low cost HMI models, now Ethernet is an option. You can purchase USB to Ethernet converter and then it is possible to download application from PC to HMI via Ethernet. Once USB to Ethernet converter is connected to HMI, you can see IP address at the HMI itself via system information similar to onboard Ethernet port

Note: The purpose of USB to Ethernet converter is to download application from PC to HMI only.

6.8.8 Project status

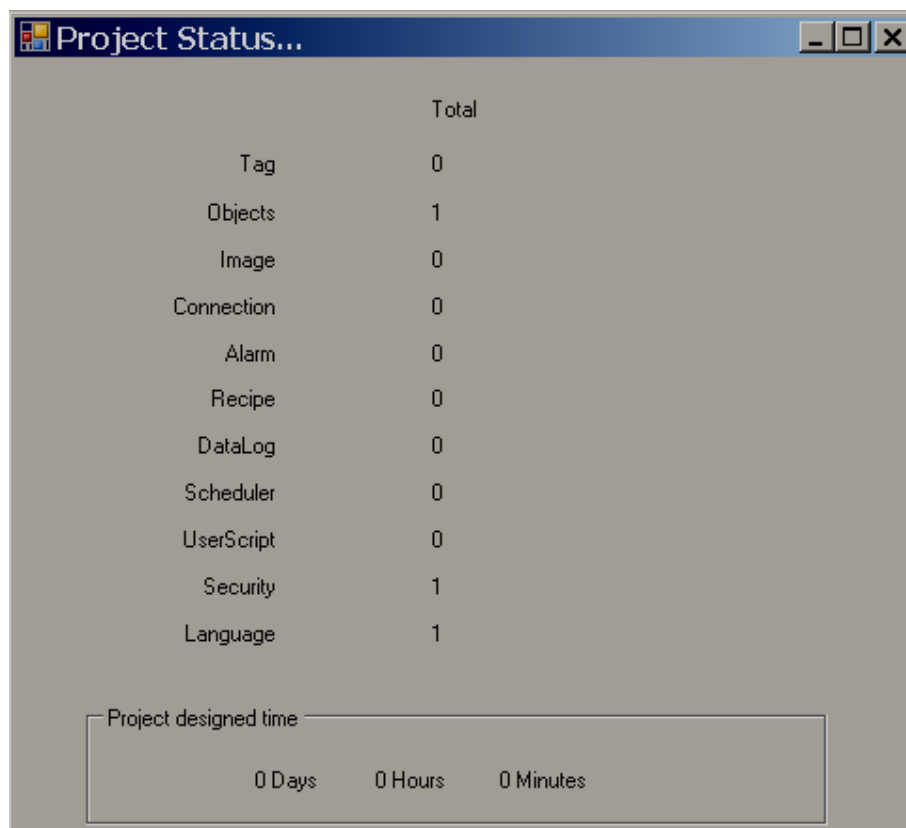

It is for project management purpose to know limits and usage of objects.

Project used time: It shows how much time project opened for editing purpose.

6.8.9 OPC Server tool

This tool is used to check communication between PC acting as master, device like IO module or PLC acting as slave and check quality of IO signals.

OPC server is used basically to configure PLC or inverter driver at COM1 port, COM2 port or Ethernet port using specific protocol.

Please check section “Connection” for more information about OPC server.

Example

PC acting as Modbus OPC server
8DIO module, address: 1, Modbus RTU Slave

Step-1: Open HMI editor software in PC.

Step-2: Open connection

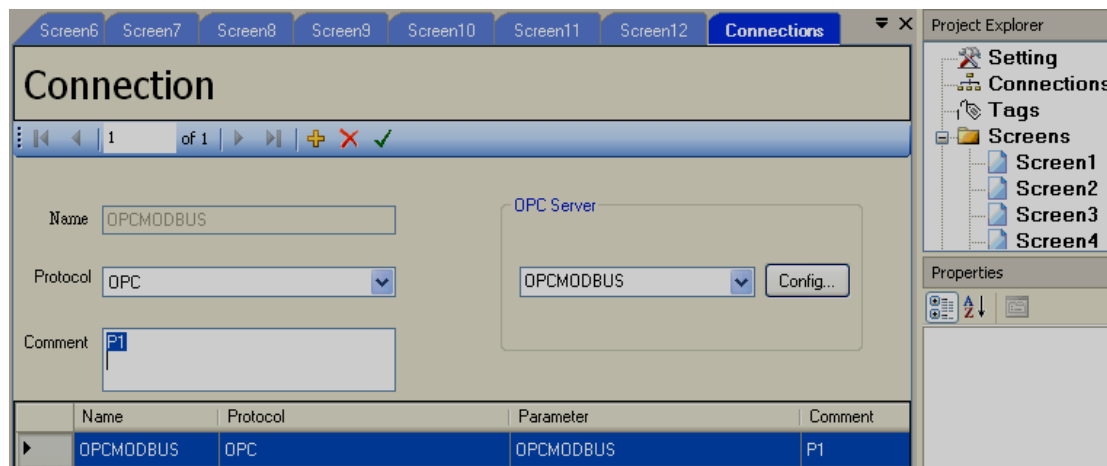

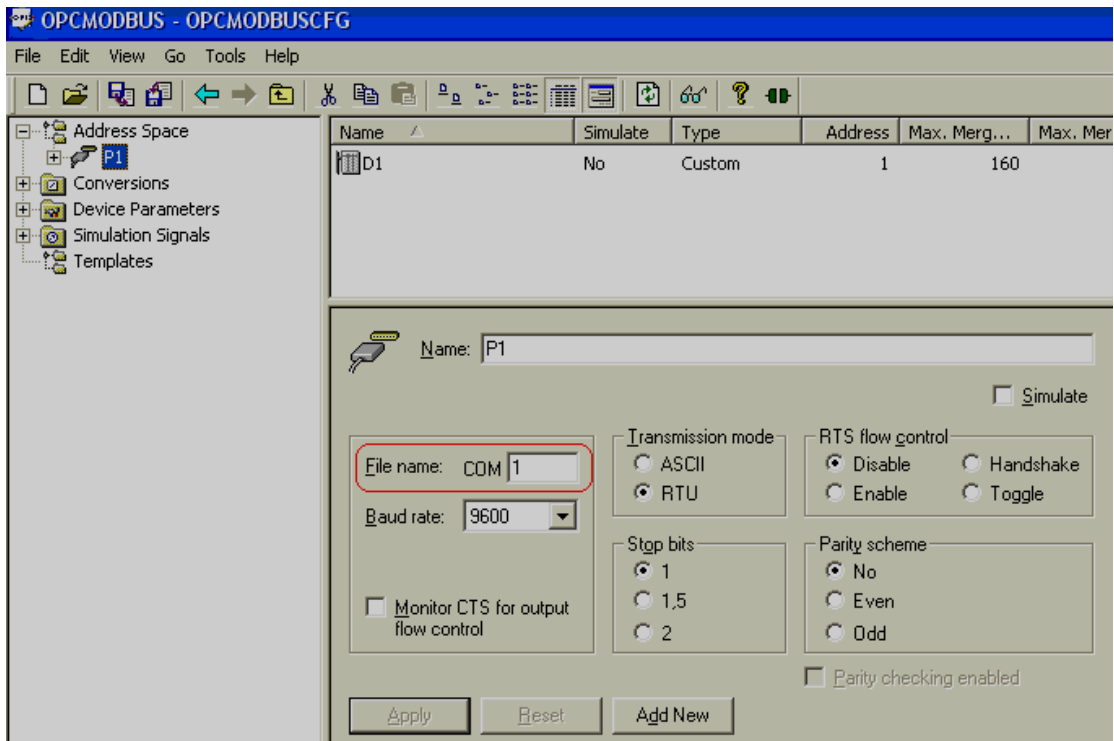

Step-3: Connect IO module to PC via RS485/RS232 converter, assume it is COM1 in PC. Now, PC is being used instead of HMI for testing purpose. PC is Modbus RTU Master and IO module is Modbus RTU slave.

Step-4: Select OPCMODBUS in OPC server and click at “Config”

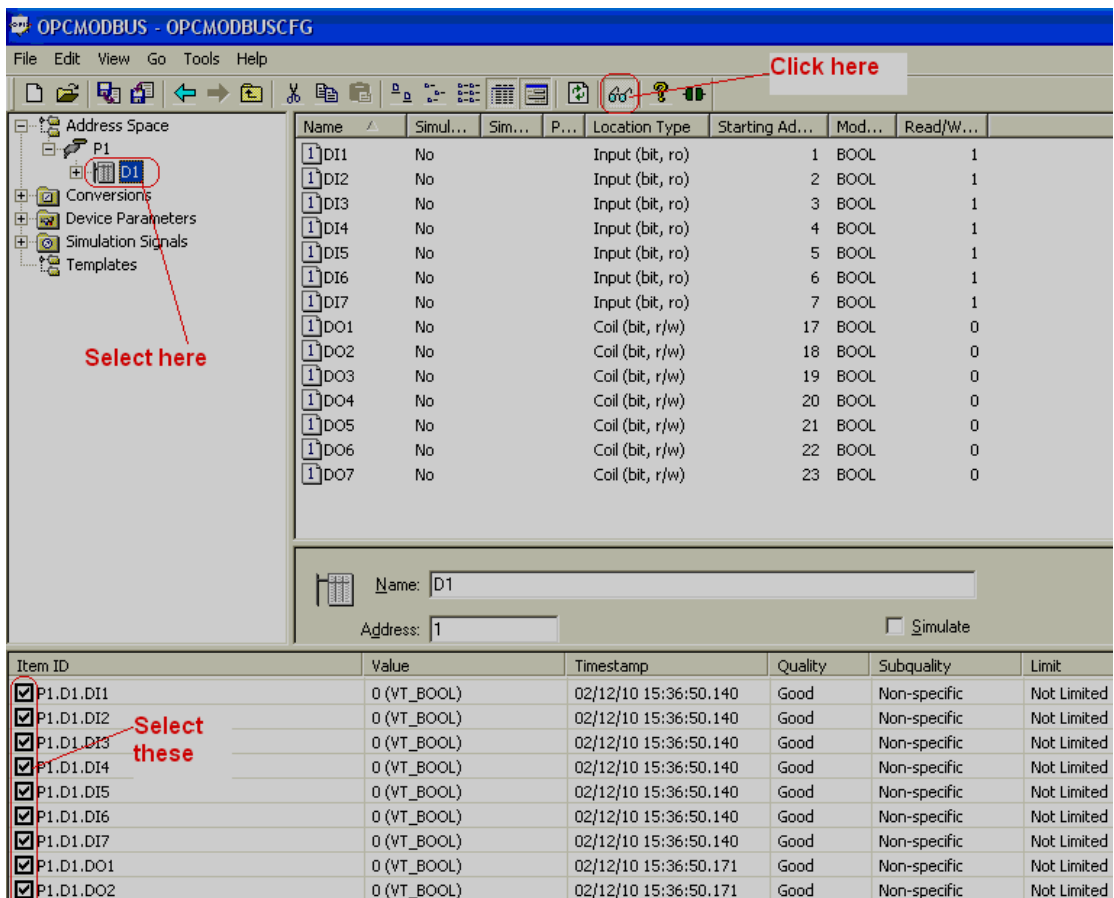

Step-4: Select COM port properly. This is COM port number in PC to which slave device is connected.





Step-4: Select device. Click at monitor icon  , then, select at check box for tags. Now, check quality, if there is good communication between PC and slave device, then, it shows “Good”. If it is showing “bad”, then, you need to check cable connection, COM port number at PC, communication setting of both Slave (IO module) and Master (OPC server).

If it is showing “Good”, then, close OPC server. Open HMI editor software and run Online simulation, it should work.

Now, you may disconnect cable at PC to IO module, download application to HMI, connect IO module to HMI and check.

6.8.10 OPC Client tool

This tool is used to Read/Write data between PC (master) and connected device (Slave) via OPC server.

If OPC server is running, click on icon  to close it. Then click on icon  to run OPC client.

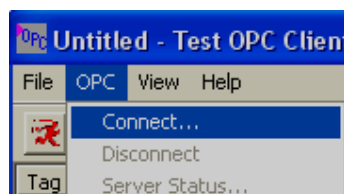
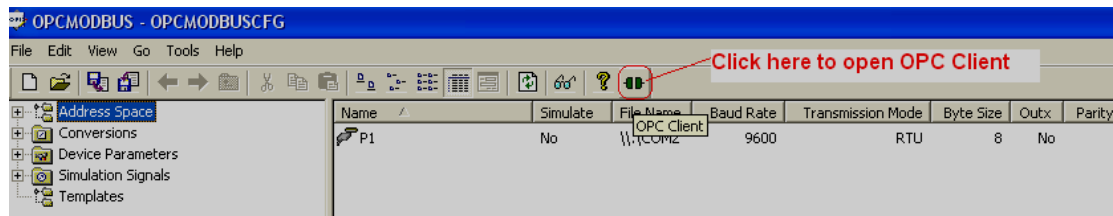

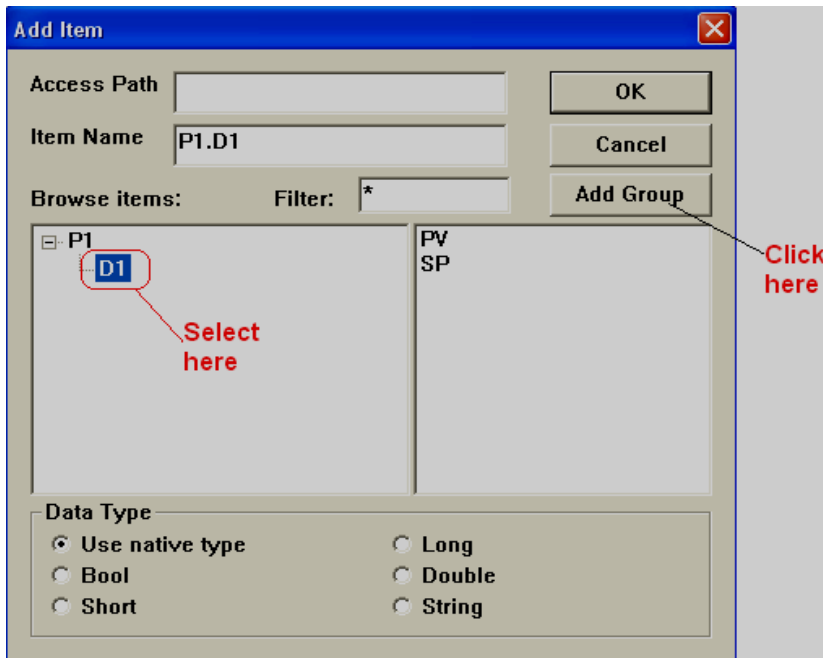
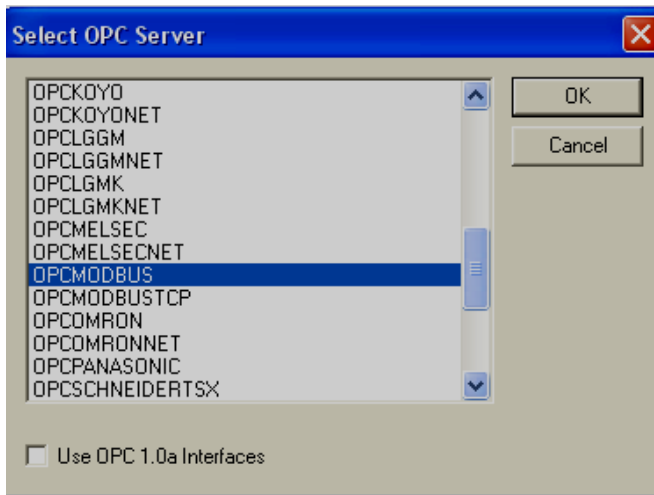

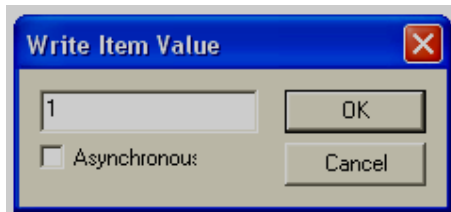
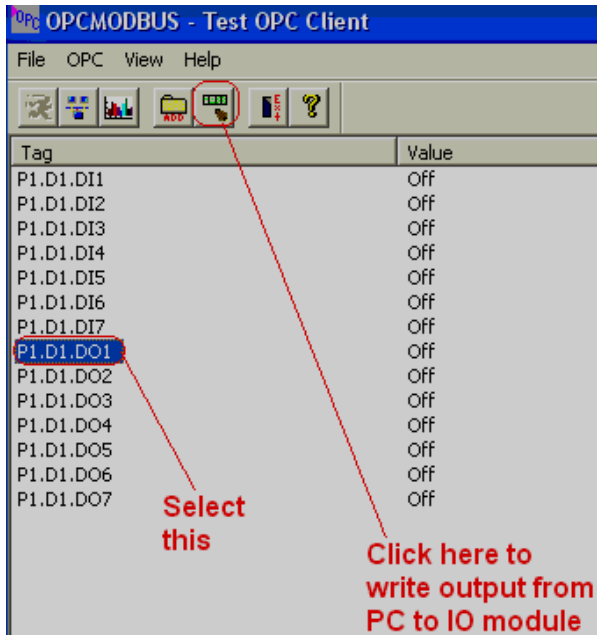

Write value 1 to switch on digital output
Write value 0 to switch off digital output

6.9 Project backup



During HMI application development, it is good practice to save application frequently say once every couple of hrs, automatic saving of application is not available at present.



For safety reasons, it is better to save project files manually once in a day in separate folders, with folder name say Jan1_2010 in D: Drive.



For safety reasons, it is better to keep application projects, software back up at multiple locations as per company policy to maintain and retain electronic records such that in case of act of God like natural calamities, earth quakes or accidents etc., you might be able to retain back up.

If HMI hardware is damaged for any reason, just replace HMI and load Run time files into HMI. It is easy to be handled directly by the customer. If Run time files are loaded into USB stick, then, it is easy to reload them back to HMI and end user does not need knowledge about HMI editing software or PC for this purpose.

6.10 Print

Two kinds of printers are supported. One is USB printer for page printing and another is Serial printer for Line printing

Applications: Print Historical alarms, Print Historical data & Print Screen directly from HMI

6.10.1 USB Printer

Generally, USB printer support PCL protocol. It means, it will support Page Print, but not line print. We support PCL language 4, 5 & 6

If USB printer supports ESCP protocol similar to EPSON LQ300+, then, it is possible to take line print.

Please refer Printer user manual for exact protocol details



Do not use USB printer supporting only PCL to print single line alarms, other wise, pages will be wasted

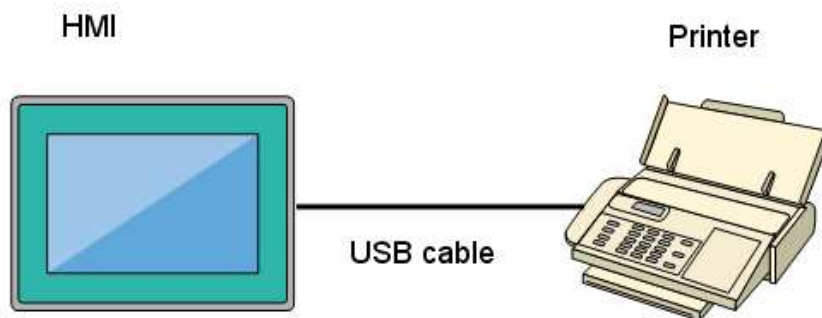

Procedure

Connect HMI to Printer via USB cable

Power ON Printer

Control Center

[Run](#)
[Project](#)
[Instrument](#)
[Touch Calibrate](#)
[System Information](#)



Press "Instrument" at Control Center

Instrument

Clock	7:17:21 PM 12/19/2011
Ethernet	IP
Orientation	0
Language	English

[Advanced](#) [OK](#)

Advanced

Beep Volume	5
BackLight	80
Screen Saver	0 Min.
Password	
Other	Printer

[OK](#)

Press "Advanced". Then, Select "Printer" and press "Other"

Print ? OK X

Printer:	PCL Laser	Print Range	Orientation
Port:	Network	<input checked="" type="radio"/> All	<input checked="" type="radio"/> Portrait
Net Path:		<input type="radio"/> Selection	<input type="radio"/> Landscape
Paper Size:	Letter	Margins (inches)	
Advanced	<input checked="" type="checkbox"/> Draft Mode	Left: 1" Top: 1"	
	<input type="checkbox"/> Color	Right: 1" Bottom: 1"	

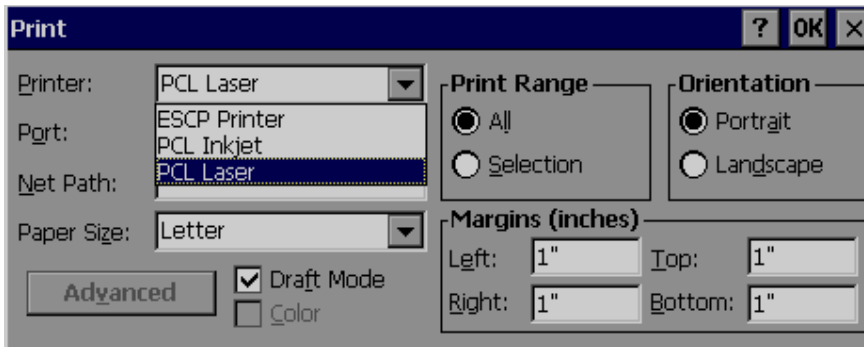

Select PCL laser or PCL Inkjet as per requirement and then press “OK”

Select ESCP if Printer supports this format for line printing

Paper Size: A4, B5, Legal and Letter are supported

Draft mode: By default, it is selected. If more quality print is required, deselect Draft Mode

Color: Enabled for Inkjet printer

Orientation: Select Portrait/Landscape as per requirements

Note: Margins & Print Range are not working at this time.

Now, setup is ready at HMI

6.10.2 Network Printer (LPT1)

Serial printer will print minimum one line and generally used for printing Real time alarms. Also, it can be used for printing historical data and alarms from HMI. ESCP language supported. So, any language supporting ESCP like LQ300 can be used. LPT1 port of PC can be connected to Serial printer directly. However, it needs to install Printer driver in PC first and share it for network use via Ethernet.

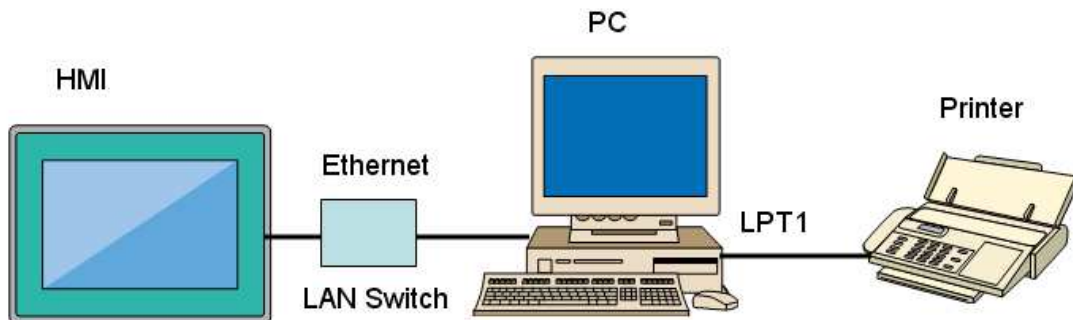

Procedure

Connect HMI to PC via Ethernet

Install Printer driver in PC. Share Printer for network use

Connect Printer to PC via LPT1

Power ON Printer



Press "Instrument" at Control Center

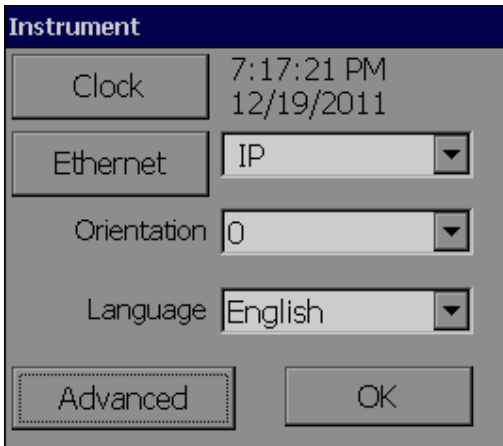

Press "Advanced"

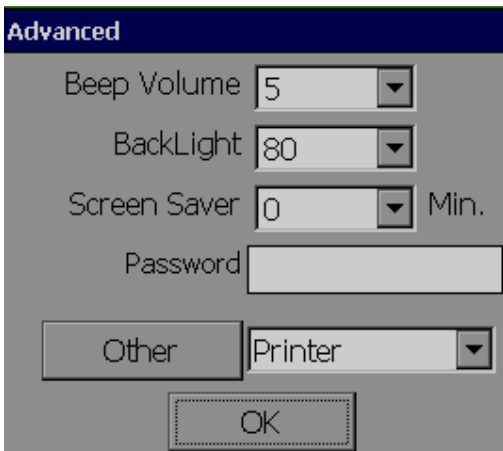

Select "Printer" and press "Other"

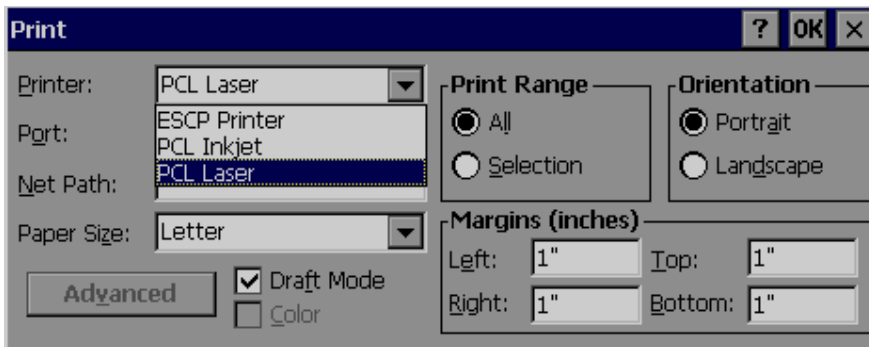
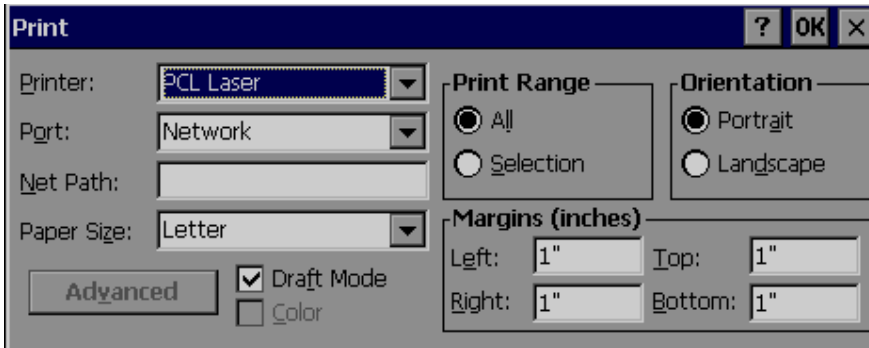

Select ESCP printer.

Then, enter NetPath properly. Ex: \\PC1\LQ300

Where, PC1 is computer name and LQ300 is shared printer driver for network use

Now, setup is ready at HMI

6.10.3 Alarms Print

6.10.3.1 Enable Print Events

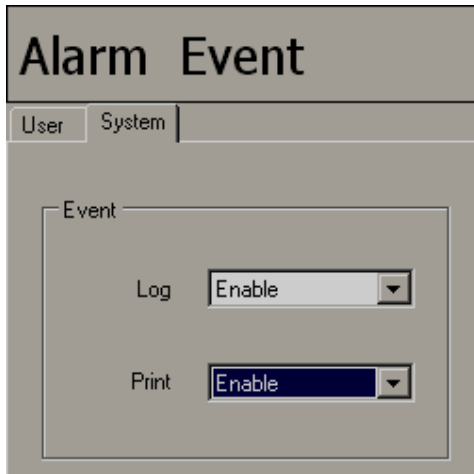

The screenshot shows a window titled "Alarm Event" with two tabs: "User" and "System". Inside the "System" tab, there is a section labeled "Event" containing two dropdown menus: "Log" and "Print". Both dropdown menus are currently set to "Enable".

Log= Enable, it means, event will be logged to internal memory/SD card if configured

Print=Enable, it means, event will sent to Printer if configured

6.10.3.2 Real time alarm print

First Step: Print=Enable as explained in previous section

Second Step: Enable print for specific tag as shown below

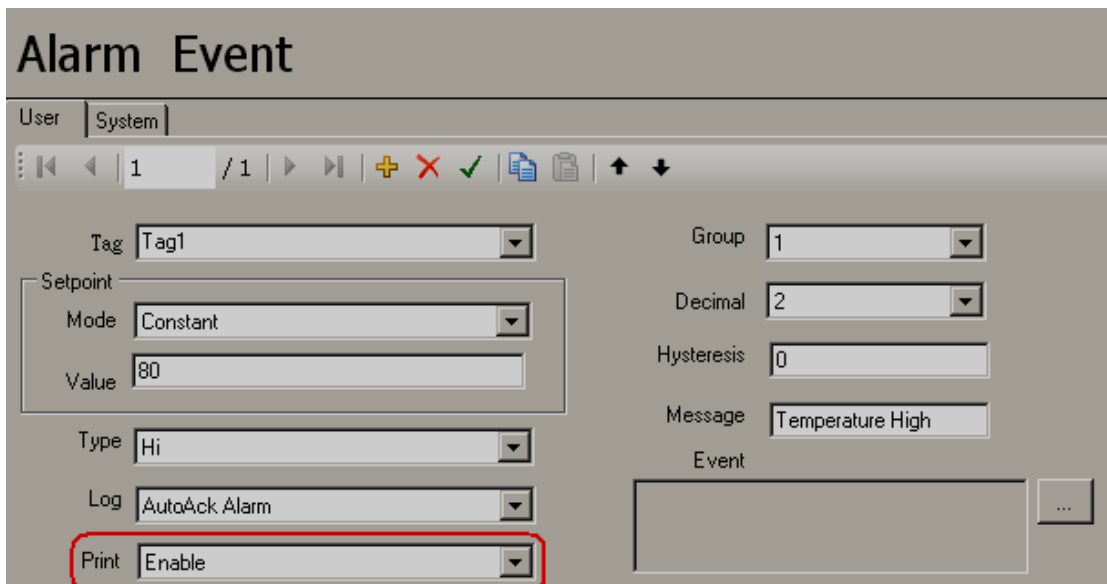

The screenshot shows a more detailed "Alarm Event" configuration window. It has "User" and "System" tabs. Below the tabs is a navigation bar with icons for back, forward, home, search, and other functions. The main configuration area includes:

- Tag: Tag1
- Group: 1
- Setpoint: Mode Constant, Value 80
- Decimal: 2
- Hysteresis: 0
- Type: Hi
- Message: Temperature High
- Log: AutoAck Alarm
- Print: Enable (highlighted with a red box)
- Event: (empty field with a button)

Format for the print

Real Time Alarm

Date	Time	Alarm Type	Tag	Value	Message
12/19/2011	11:13:01 PM	HiAlarm	Tag1	80.58	Temperature High

6.10.3.3 Historical Alarm Print

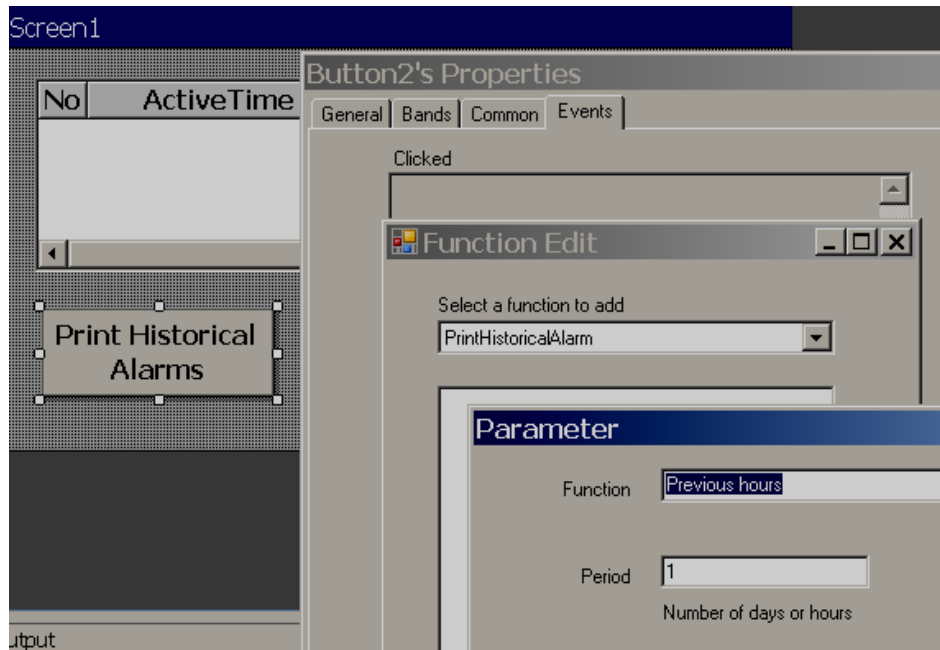

Previous hours: Select this if you wish to Print historical alarms for previous hours and then select period. For ex: Last one hr, select Function = Previous hours, period = 1

Previous days: Select this if you wish to Print historical alarms for previous days and then select period. For ex: Last one day, select Function = Previous days, period = 1

User select: Select this if you wish to select Time and Period in run time directly from HMI

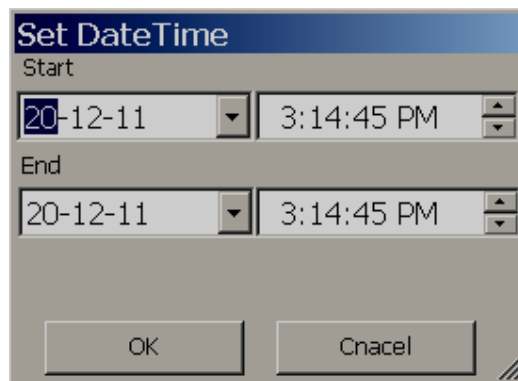

Format for the print

Historical Alarm

Date	Time	Message
12/19/2011	11:13:01 PM	PowerOn

How to change date format in Print out?

Hold any touch screen and Power ON HMI. At Control Center, press “Instrument”, then press “Clock” and then select the required Date format. Then press “OK”

6.10.3.4 Log & Print operator actions

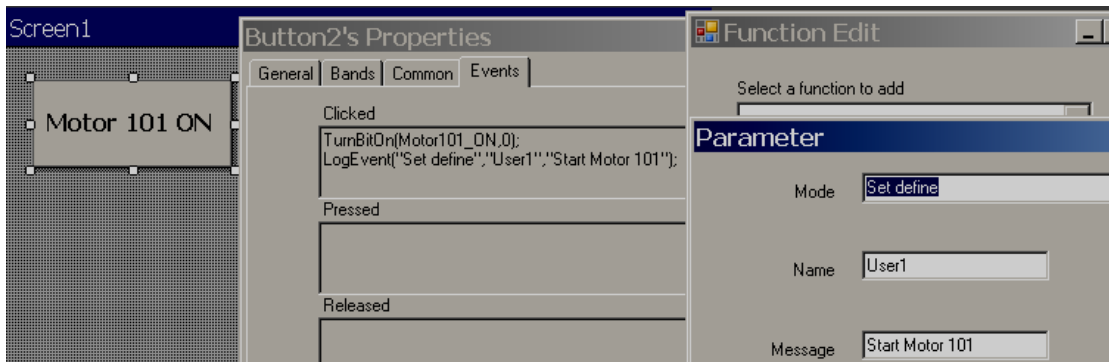

Mode: Set Define: Define Name and Message at Design time

User Input: User can enter Name and Message in Run time

6.10.4 Historical data Print

6.10.4.1 Enable Print Historical data

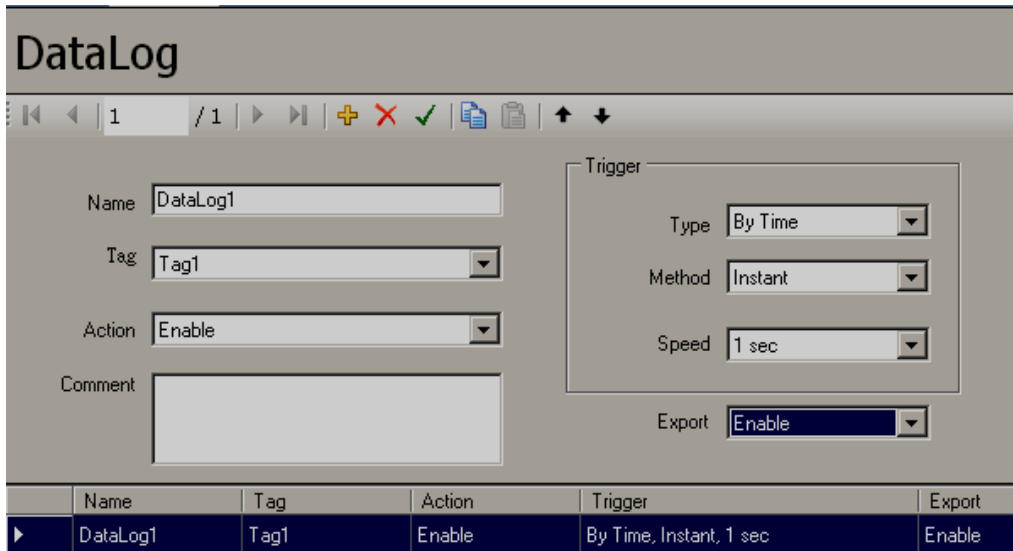

Make sure Export=Enable in Data log screen as shown above.

6.10.4.2 Print Historical data

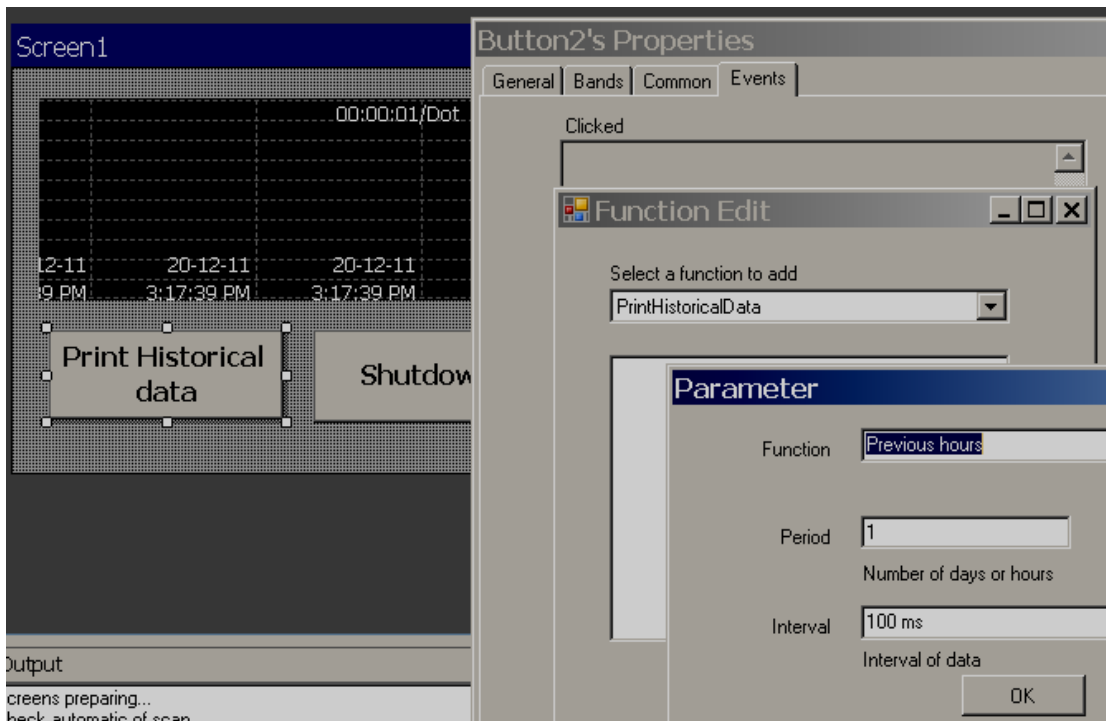

Previous hours: Select this if you wish to Print historical data for previous hours and then select period. For ex: Last one hr, select Function = Previous hours, period = 1, interval=1 sec.

Previous days: Select this if you wish to Print historical data for previous days and then select period. For ex: Last one day, select Function = Previous days, period = 1, Interval=1 sec.

User select: Select this if you wish to select Time and Period in run time directly from HMI

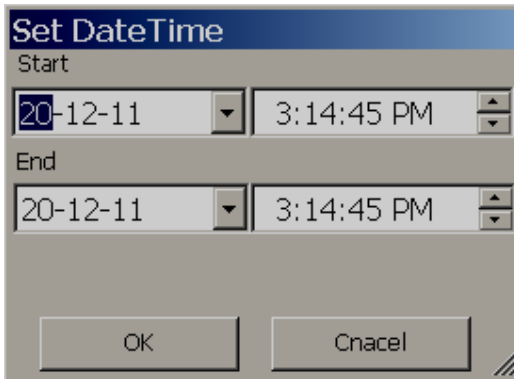

Interval: Select one of 100 msec, 1 sec, 2 sec, 5 sec, 10 sec, 20 sec, 30 sec, 1 min, 5 min & 10 min. Select this interval based on Data log configuration.

Format for the print

Ex: Data logging is already configured for Tag1, Log Speed= 1 sec.

Data Log Value

Ch1: Tag1

Data Time	Ch1
19-Dec-11 11:44:27	67
19-Dec-11 11:44:27	68
19-Dec-11 11:44:27	69
19-Dec-11 11:44:27	70

How to change date format in Print out?

Hold any touch screen and Power ON HMI. At Control Center, press "Instrument", then press "Clock" and then select the required Date format. Then press "OK"

6.10.5 Print Screen

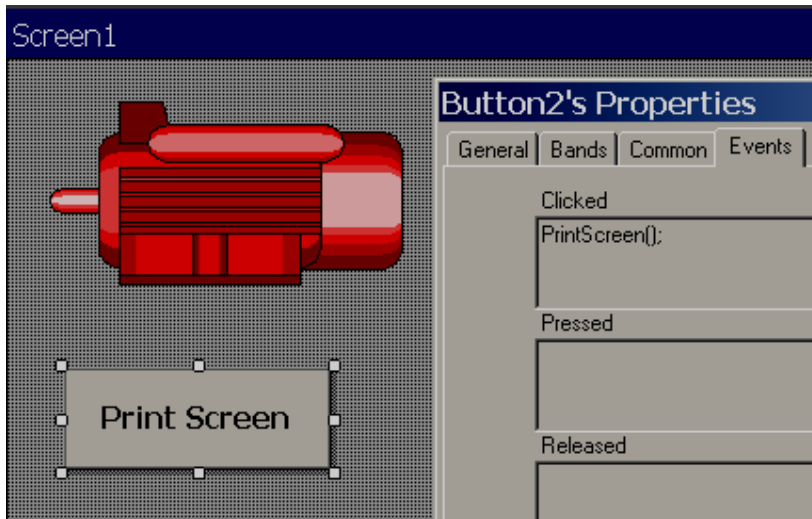

6.11 FDA 21 CFR part 11 compliance

On August 20th 1997 the Food and Drug Administration made 21 CFR Part 11 come into effective. This regulation is summarized as follows:

“The Food and Drug Administration (FDA) is issuing regulations that provide criteria for acceptance by FDA, under certain circumstances, of electronic records, electronic signatures, and handwritten signatures executed to electronic records as equivalent to paper records and handwritten signatures executed on paper. These regulations, which apply to all FDA program areas, are intended to permit the widest possible use of electronic technology, compatible with FDA’s responsibility to promote and protect public health. The use of electronic records as well as their submission to FDA is voluntary.”

6.11.1.1 Summary

The HMI have been designed to meet the standards set out in CFR 21 part 11 and it can be used as part of a validated system.

- 1) All process data recorded by HMI is protected by an Encrypted “Digital Signature” to ensure the authenticity of these records
- 2) Solid state flash memory is used to provide secure storage of data that is not reliant on battery back-up and which is not subject to magnetic fields.
- 3) Historical Viewer review software provides the ability to view the data records, digital signatures, user remarks, and audit trails in a human readable form.

4) User id and Password are provided in the HMI to limit access to authorized Personnel. Nine levels of security levels available for operators. Configurable Log Out time, password expiry features available

5) A detailed audit log accompanies all process data recorded by a HMI. All system events including operator Log in, Log Out , Power ON, Net Login, Net Dump, Log In Fail information's are automatically recorded by system with date and Time stamp. All Operator actions can be recorded in events via "Log Event" function with date and time stamp

FDA 21 CFR Part 11 Subpart B, Section 11.10: Controls for modification.

'Persons who use closed systems to create, modify, maintain, or transmit electronic records shall employ procedures and controls designed to ensure the authenticity, integrity, and when appropriate the confidentiality of electronic records, and can ensure that the signer cannot repudiate the signed record as not genuine.'

All process data recorded by HMI are in proprietary (tamper-proof) format and read-only from normal operator interface. Via the use of Historical Viewer data review software "digital signature" can be added and checked to validate the integrity of the data. If any part of the data record is changed the Historical Viewer software will warn the user of the invalid nature of the record.

FDA CFR21 Part 11 Section 11.10 (b)

"The ability to generate accurate and complete copies of records in both human readable and electronic form suitable for inspection, review, and copying by the agency FDA"

HMI can create process data files to USB disk in CSV format. It is also possible to generate CSV files from Historical viewer software. These data files are created from secure records stored in internal flash memory/SD card/historical viewer database, which are in tamper-proof proprietary format. Error detection algorithms are employed to ensure that the stored data faithfully represents the actual raw measurements made by the HMI. Each write to the archive media is also verified to ensure the integrity of the data record. The archived process data files from HMI can be viewed using the Historical Viewer review software. The data can be viewed and printed in graphical formats. Standard spreadsheet formats (e.g. Microsoft Excel) of the archived data files can be created for viewing by users who do not have the review software.

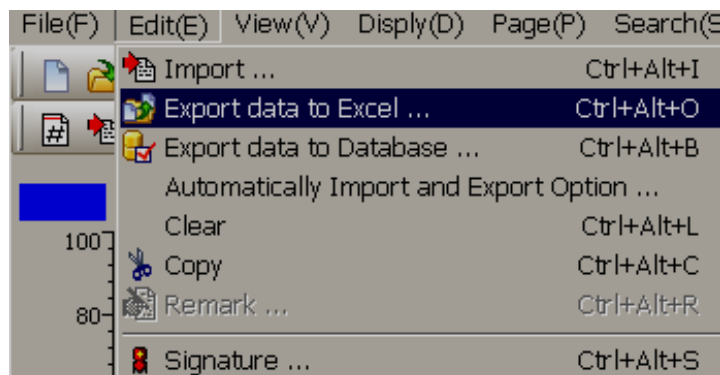

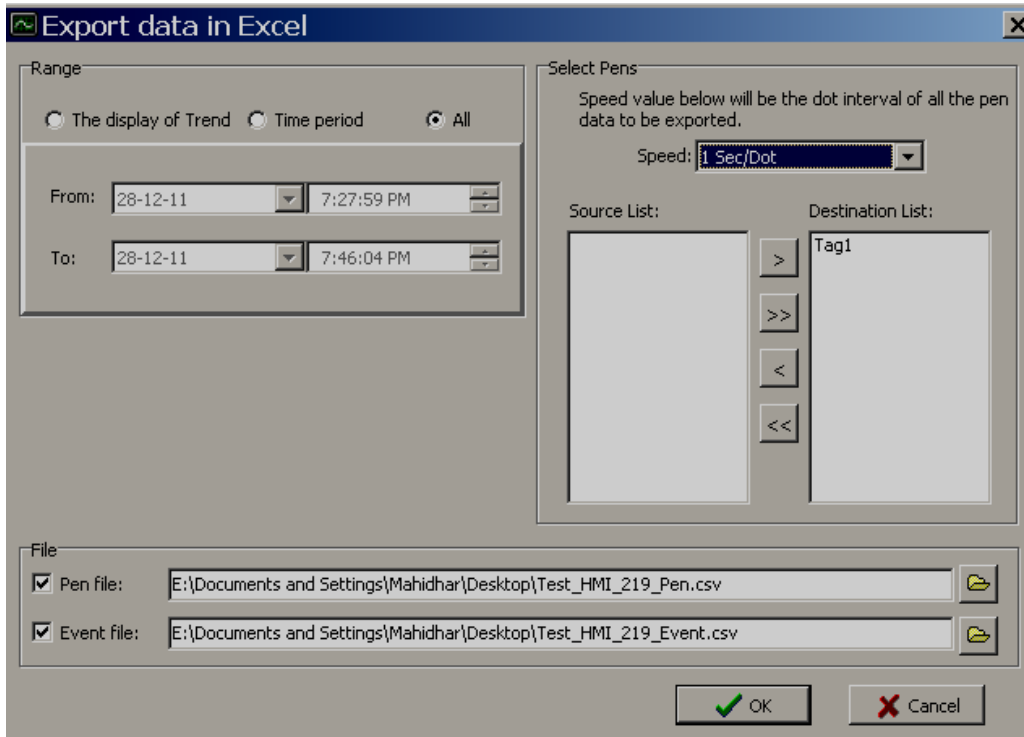

	A	B	C	D
1	Date	Time	Tag2	
2			Instant	
3				
4	28-12-11	19:51:57		
5	28-12-11	19:51:58		
6	28-12-11	19:51:59	51	
7	28-12-11	19:52:00	51	
8	28-12-11	19:52:01	52	
9	28-12-11	19:52:02	53	
10	28-12-11	19:52:03	54	
11	28-12-11	19:52:04	55	
12	28-12-11	19:52:05	55	

How to Save generate Historical data and alarm files from HMI to USB disk?

A special function “Save Historical to File” available from function editor, which can be triggered from button by an operator in Run time as shown below



FDA CFR21 Part 11 Section 11.10 (c)

“Protection of records to enable their accurate and ready retrieval throughout the records retention period”

HMI use solid state flash memory, for data storage, in the form of SD card/USB disk. Data retention for this device is specified at a minimum of 10 years. It provides Zero power data retention i.e. the data integrity is not dependent on battery back-up. The data is not affected by magnetic fields. For even longer term data storage the archive files can be copied to CDROM or to a network file server.

FDA CFR21 Part 11 Section 11.10 (d)

“Limiting system access to authorized individuals.”

HMI provide the ability to limit access to the HMI configuration for the application developers using Password feature

6.11.1.2 Security

The screenshot shows a 'Setting' window with three tabs: 'General', 'Runtime', and 'Resource'. The 'General' tab is active. It contains several input fields: 'Name' (with 'Panel' entered), 'Location' (empty), 'Resolution' (empty), 'Language' (with 'English' entered), 'Width' (with '480' entered), 'Height' (with '272' entered), 'Author' (empty), and 'Version' (with '1' entered). A 'Password' field is highlighted with a red box, showing an empty input field and a small button with three dots. Below these fields is a 'Comment' section with a large text area.

HMI provide the ability to limit access to the HMI for critical operator functions. For each user a unique id and password can be created for access to the configuration parameters. The id and password can be alphanumeric and up to 8 characters in length. In order to gain access to the configuration parameters, a valid operator id and password combination should be entered. HMI will logout automatically after a configurable period of inactivity say 10 minutes

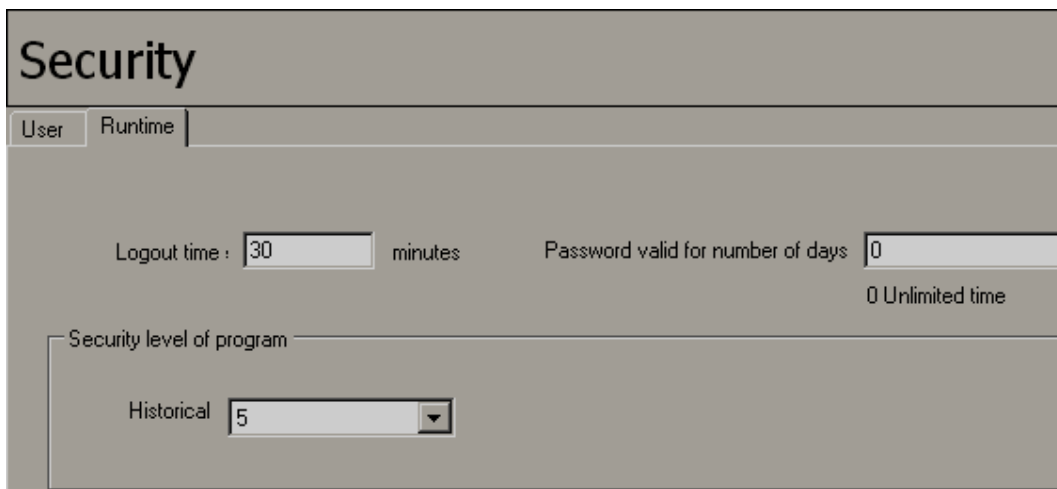
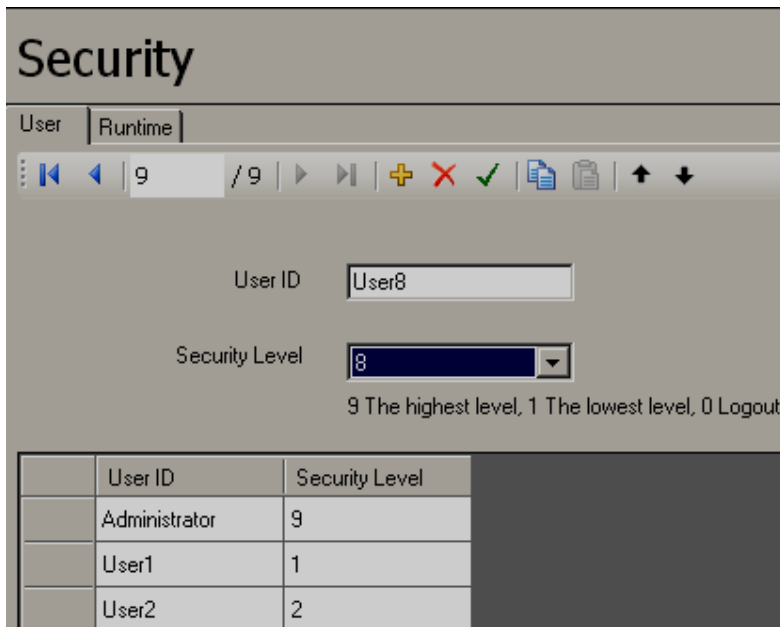

Please refer section “Security” for more information about this feature

Assume there are two users, User1 with security level 1 and User 6 with security level 6. Make sure both these users are already log in at least once in HMI and entered passwords for the first time.

Connect HMI to PC via Ethernet. Create a new project using Historical viewer. Please refer section “Historical viewer” for more information

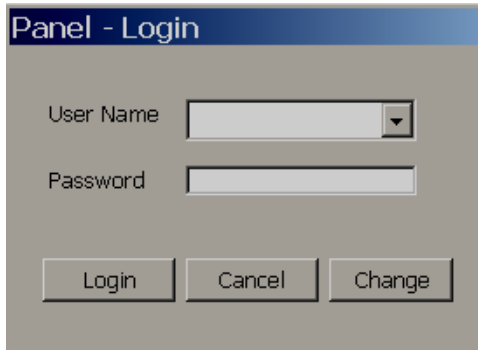

Fig: Operator Log in screen at HMI in Run time

UserID	SecurityLevel	
Administrator	9	↑
User1	1	
User2	2	↓
User3	3	
User4	4	
User5	5	
User6	6	📄
User7	7	
User8	8	

Fig: Advanced, Run time user management in HMI

6.11.1.3 Procedure to sign digital records

Step-1: Open Historical viewer project.

Log in at User with security level higher than or equal to defined at Project explorer/security/Run time

Ex: Try to Log in as User6, which is already defined with security level 6.

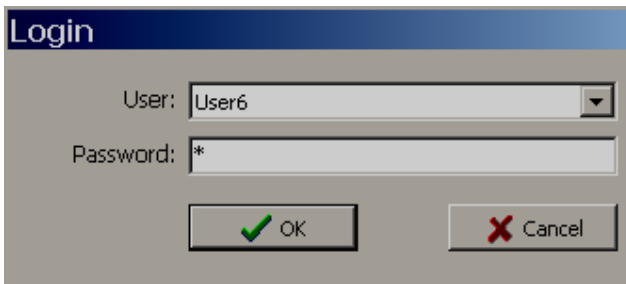

Step-2: Import historical data and alarms from HMI to PC via Ethernet

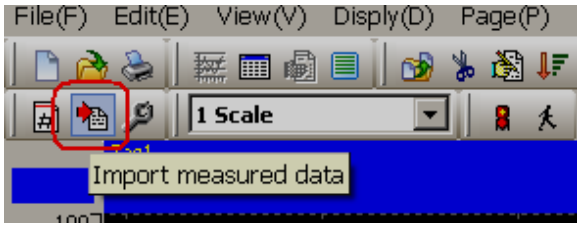

Step-3: Click “Signature” and then proceed for Digital signature

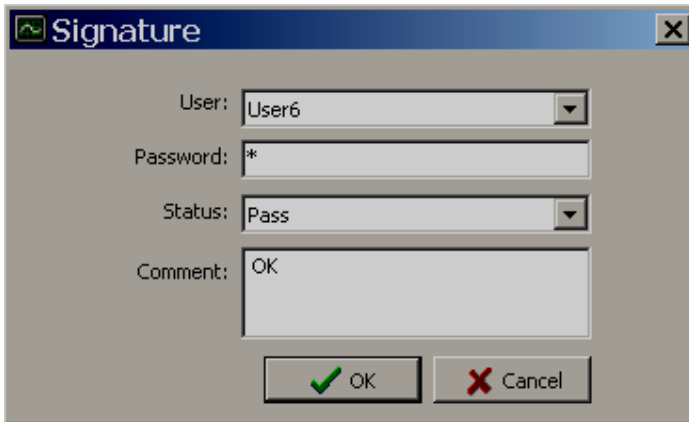
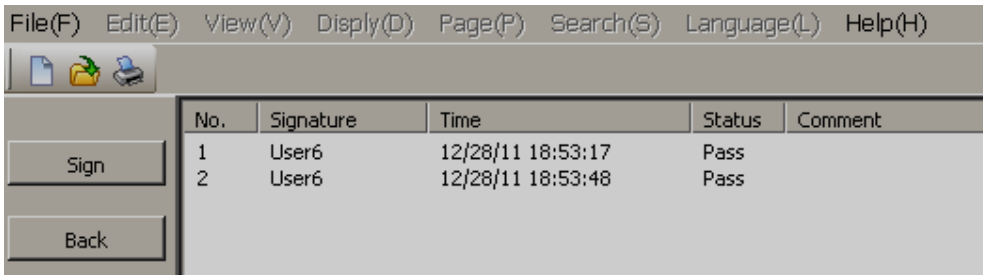
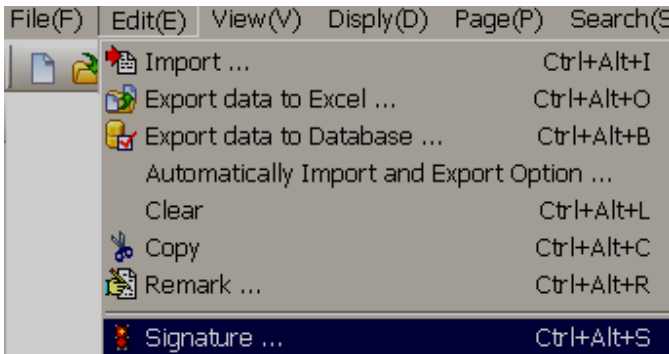

It records digital signature of user log in information in Historical viewer data base. With out signature, Historical viewer software do not allow user to exit from the application

If user attempt to exit/Logout the Historical viewer application, it alert user with following message

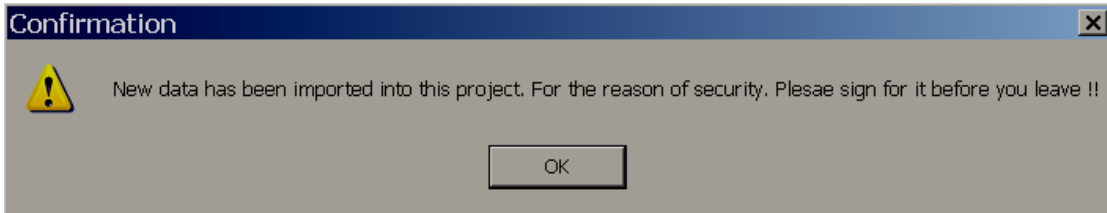

6.11.1.4 Procedure to add Remarks on Digital data

It also allows Users to add digital custom remarks on data

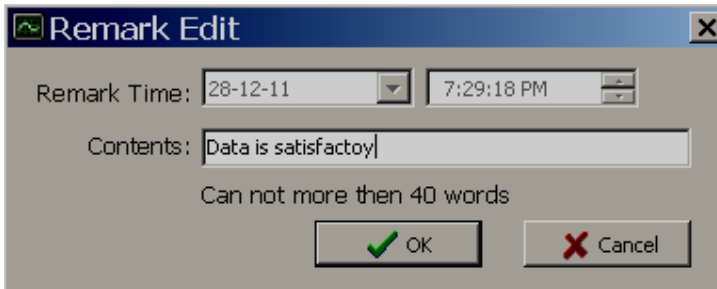
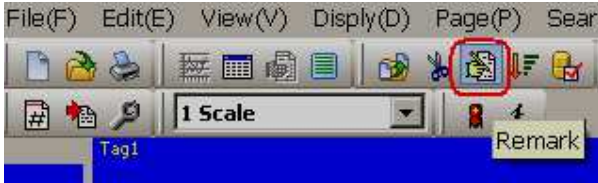

If User1 (Security level predefined as 1, which is less than actual security level defined at Project explorer/security/Run time) try to access historical data via Historical viewer in PC, it shows following message

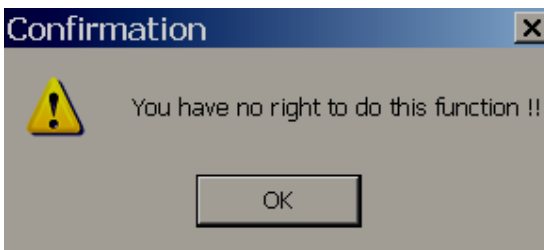
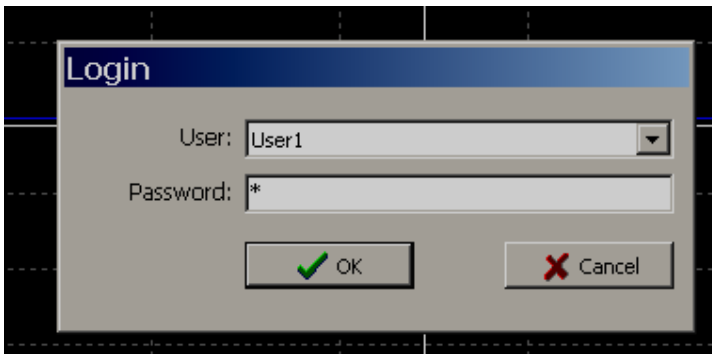

FDA CFR21 Part 11 Section 11.10 (e)

“Use of secure, computer-generated, time-stamped audit trails to independently record the date and time of operator actions that create, modify or delete electronic records”, Record changes shall not obscure previously recorded information. Such audit trail documentation shall be retained at least as long as that required for the subject electronic records and shall be available for agency review and copying”

The HMI automatically produce a time stamped audit trail that includes Power ON, Power OFF, data dumping, clearing, Net log in, Net Log Out (Historical viewer Log in at PC), operator actions (via Log event), Log in Fail etc... This information is stored in an audit log which can be archived to a permanent file at Resident flash/SD card. Alarm/event log automatically produces a time stamped record of all alarm state changes and can also be archived to a permanent file.

FDA CFR21 Part 11 Section 11.10 (g)

“Use of authority checks to ensure that only authorized individuals can use the system, electronically sign a record, access the operation or computer system input or output device, alter a record, or perform the operation at hand.”

The HMI security system outlined in part d) limits access to the system. Sign digital records etc.

FDA CFR21 Part 11 Section 11.10 (h)

“Use of device (e.g., terminal) checks to determine, as appropriate, the validity of the source of data input or operational instruction”

System generated events and input channel status are logged

FDA CFR21 Part 11 Section 11.10 (i)

“Determination that the persons who develop, maintain, or use electronic record/electronic signature systems have the education, training and experience to perform their assigned tasks.”

Only qualified people are employed in product design & development and their training is updated to meet advances in technology. This part is also applicable for end users ultimately using the HMI

FDA CFR21 Part 11 Section 11.10 (k)

***“Use of appropriate controls over systems documentation including:
(1) Adequate controls over the distribution of, access to, and use of documentation for system operation and maintenance.***

(2) Revision and change control procedures to maintain an audit trail that documents time sequenced development and modification of systems documentation.”

A design control system is used which is fully documented and traceable. Documentation is provided for installation, configuration and operation in HMI user manual

§ 11.300 Controls for identification codes/passwords.

Persons who use electronic signatures based upon use of identification codes in combination with passwords shall employ controls to ensure their security and integrity. Such controls shall include:

(a) Maintaining the uniqueness of each combined identification code and password, such that no two individuals have the same combination of identification code and password.

Any duplication of user name from a new created account will be forbidden.

(b) Ensuring that identification code and password issuances are periodically checked, recalled, or revised, (e.g., to cover such events as password aging).

The following things will automatically be done:

Force the user to enter a new password when the time of password expires

Use of transaction safeguards to prevent unauthorized use of passwords and/or identification codes, and detect and report in an immediate and urgent manner any attempts at their unauthorized use to the system security unit, and, as appropriate, to organizational management.

Any event of failed login will be logged for audit trail.

No	ActiveTime	Type	Name	Mess
13	12/28/2011 9:19:18 PM	LoginFail	User6	

6.11.1.5 Procedure to Log Operator actions in HMI

Example: Operation actions need to be recorded

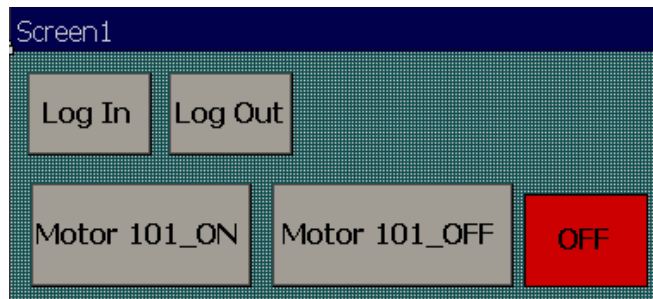

Use Log In, Log Out events with buttons first. Now, when operator Log in, it will record event in the Historical alarm box, it shows which operator log in to HMI

“Log Event” function available via Function editor useful to log custom messages for the operator actions

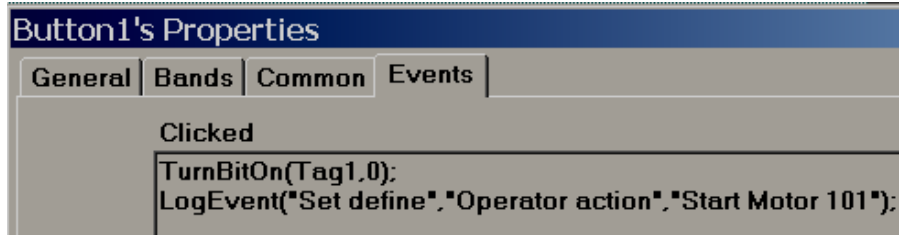

When operator press Motor 101_ON button, first it turn bit ON, then, it will log in message “Operator action” at “Name” and “Start Motor 101” at “Message” column in historical alarm box.

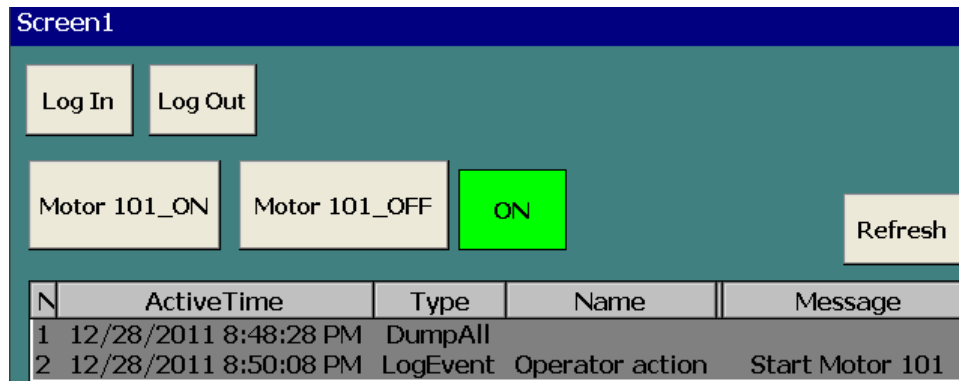

Fig: Historical alarm box in Run time

6.12 How to send Project files

Create a folder by name “Test” on your desktop

Open your project, Ex: Demo1

Use File Save as option and then save to “Test folder”

Now, there should a folder with name “Demo1” and a project file Demo1 in “Test” folder as shown below

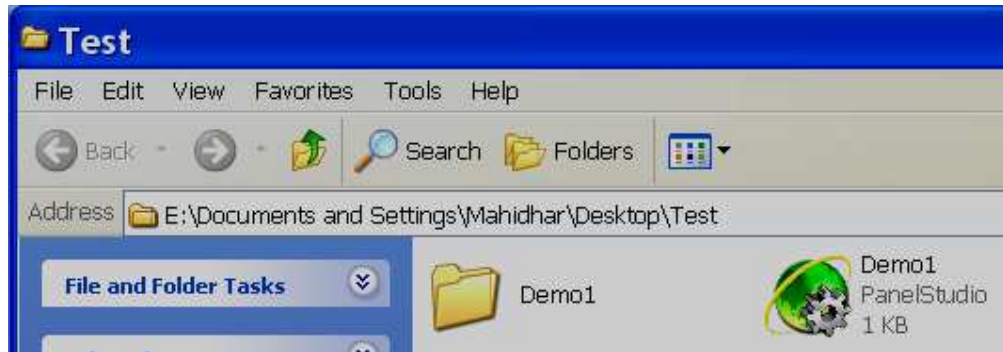

Close the Project. Open Project from the “Test” folder, click at “Build”, then save it again. Now, zip the “Test” folder and send it back to supplier for analysis

7. Scripts

This is useful for advanced users with Programming knowledge like C, C++, C#, Visual Basic etc.. HMI editor software allow to use scripts similar to C language

Scripts are useful to write simple program for small applications as follows

Math calculations
Execute conditional statements
Logic control applications etc.



Scripts are useful to write small tasks. If complex task with extended logic is available, better to write it at PLC level using ladder programs or functional blocks etc.

Procedure

First write a sample script. Double click at User Scripts at Project explorer

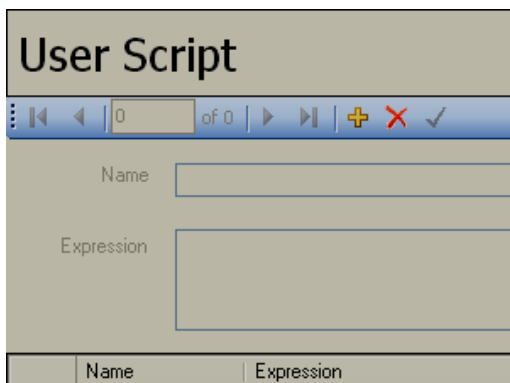
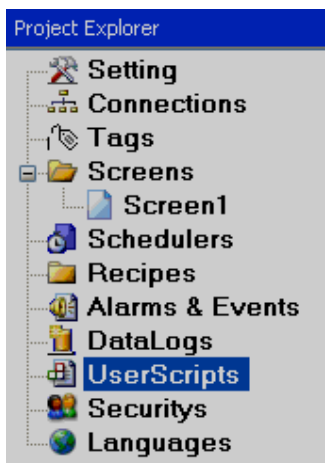

Click at icon  in above interface. By default, FunctionX will appears, where X is number. If required, you may change name of function so it is easy to remember.

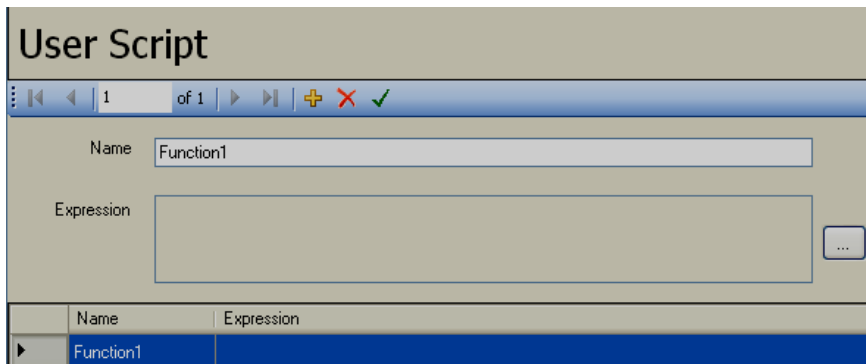

To write an expression or script, click at

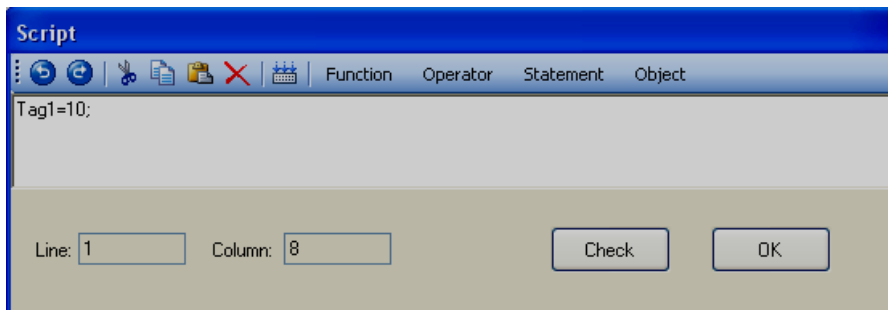



Click at Check button to compile the project or click at "OK" if you wish to compile later.

Now, it is possible to execute above script from different locations

a) HMI Startup, HMI Shutdown

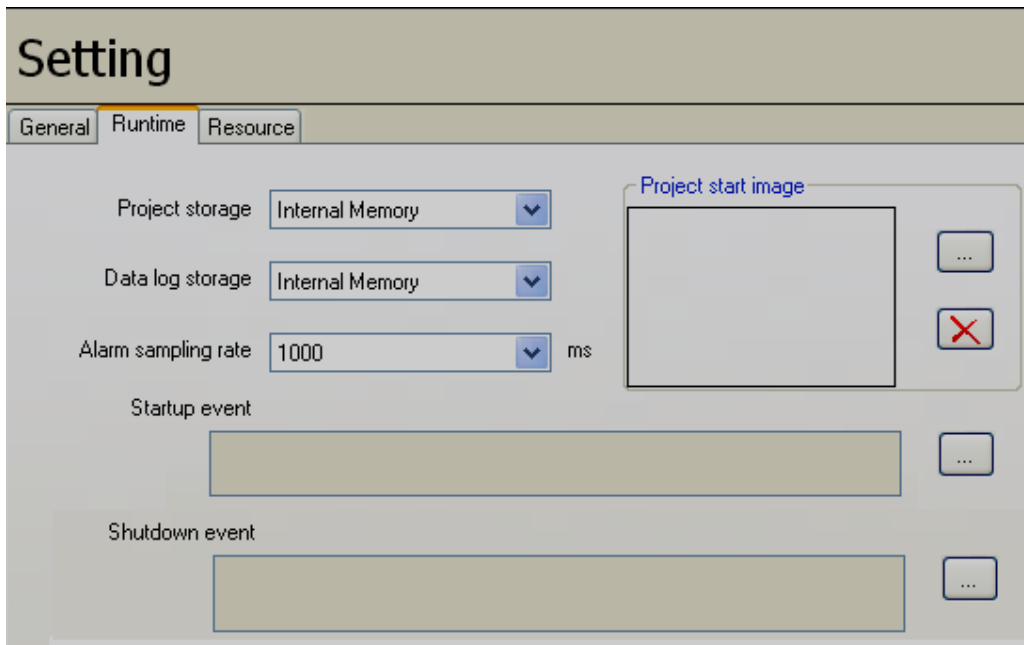
Click at "Settings" in Project Explorer, select "Run Time" and then select script at Start Up, Shutdown events.



Click at  to select the script.

b) Page Events

Double click on screen and select function at Activated or Deactivated as per requirements.

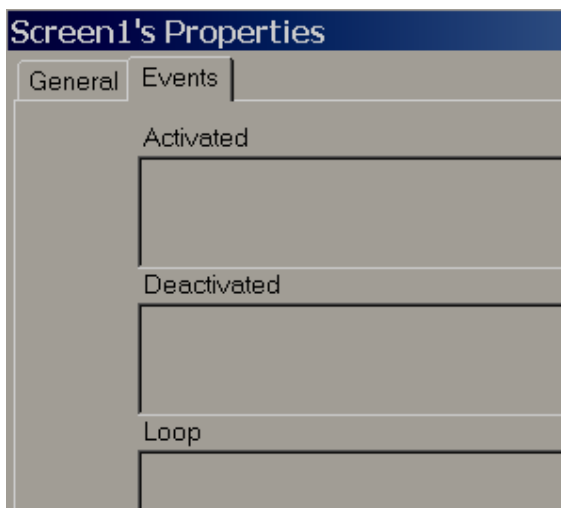

Alternatively, in page properties, click at Activated, Deactivated and select the required function.

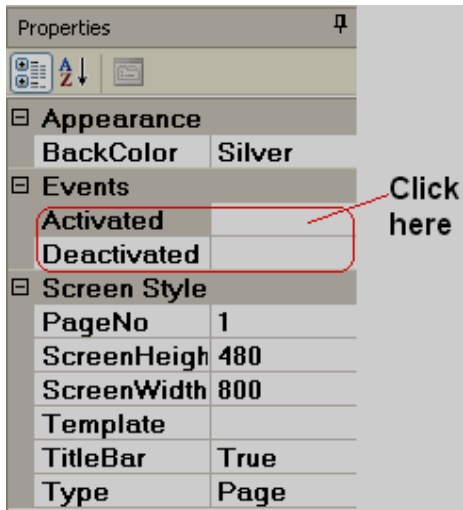

c) Scheduler

Click at [...] to select the script. In above example, Function1(); will be executed repeatedly once in 10 sec.

d) Alarm & Events

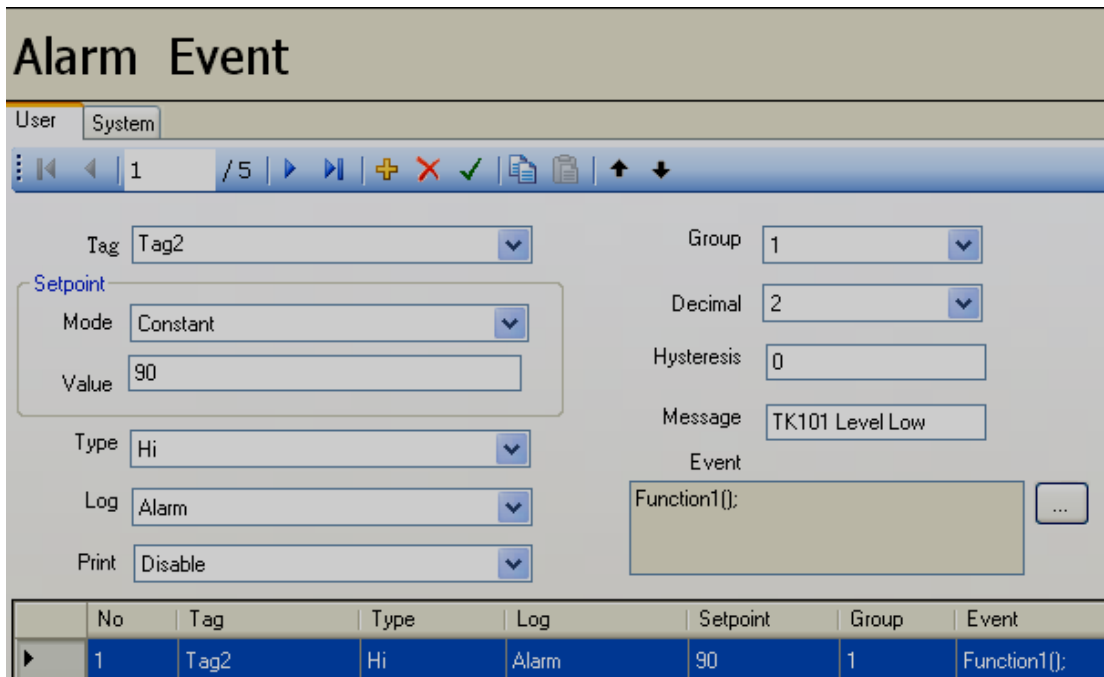

Click at [...] to select the script. In above example, Function1(); will be executed when Tag2 value is more than 90.s.

e) Objects

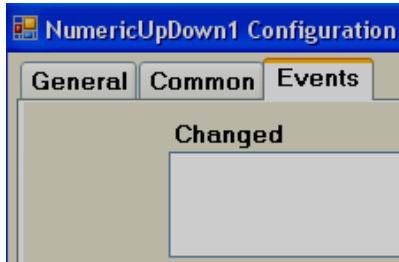

Some objects support events.

Example: When user change value of tag using numeric up/down, then when tag value changed in run time, then selected function will be executed.

Syntax

To set properties of objects via Script

ScreenNumber.Object.Property = Value

Example: Screen1.Ellipse1.Visible=true;



It is possible to create all required scripts first from Project explorer-Scripts. Then, call these scripts from Schedulers and set time.

For scripts, it is required to follow syntax properly other wise, it generate compilation errors.

```
if(Tag1==1)
{
Tag1=1;
}
```

Every line to be terminated using colon symbol “;”

Script editor is case sensitive.

For writing comments for line, it should be started with //

```
// this is comment line for user script
```

```
Screen1.Ellipse1.Visible=true; //this is ok
Screen1.Ellipse1.Visible=True; //this is not ok because Capital letter used for true
```

Application, Visibility Animation

There is Ellipse1 in Screen1 and it need to control visibility by Tag value in Run time.

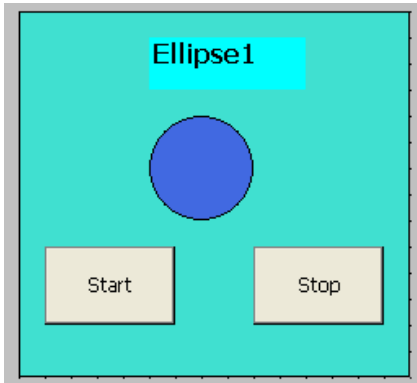

When Tag1=1, Ellipse1 is visible
When Tag1 is not equal to 1, Ellipse1 is not visible

Create a Digital Tag by name Tag1 in Tag database from Project Explorer and then save it using  in Tag base.



If Tag1 is not saved properly in Tag data base, script may be not able to find instance of Tag1 and it generates compilation error. Make sure that Tag is saved properly when it is created in Tag data base from Project explorer.

Write user script as follows

```
if(Tag1==1)
{
Screen1.Ellipse1.Visible=true;
}
Else
{
Screen1.Ellipse1.Visible=false;
}
```

Since Ellipse1 is available at Screen1, it required to write as Screen1.Ellipse1
Since we need to control visibility, we need to write Visible also.

Screen1, Ellipse1, Visible are separated by a dot symbol (.)



Note: Above script is case sensitive.

Application, Blink/Flash animation via script

In Screen, blink/flash Ellipse1 when Tag1 = 1

```

if(Tag1==1)
{
Screen1.Ellipse1.Visible=!Screen1.Ellipse1.Visible;
}

```

Running user scripts

Use Scheduler to run scripts

Scheduler 1
Scheduler1 Configuration
Type: Repeated countdown
Action: Enable
Seconds = 1

No	Type	Action	Event	Day
1	Repeat Countdown	Enable	Function1();	0

Now, Function1 will be executed once a sec. as per setting at Scheduler1.

Application: How to change colors of Rotate Start button in Run time via scripts.

Create two buttons in Screen1 as shown



// Rotate start button click event user script

```
Tag20=1;
```



```
// Rotate stop button click event user script
```

```
Tag20=0;
```

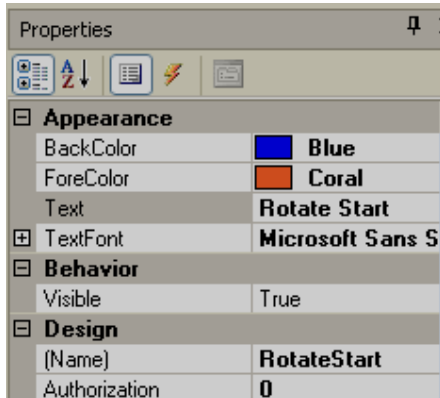

Normally, Rotate Start needs Blue color, when User presses on “Rotate Start” button, then, it need to turn to Green color as shown.

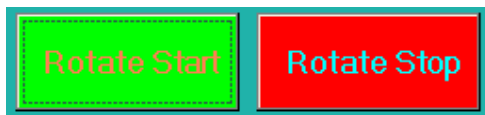

```
// User defined Script, name: Function1
```

```
if(Tag20 == 1)  
{  
Screen1.RotateStart.BackColor=Color.Lime;  
}
```

```
if(Tag20 == 0)  
{  
Screen1.RotateStart.BackColor=Color.Blue;  
}
```

```
Scheduler  
Scheduler Configuration  
Type: Repeated countdown  
Action: Enable  
Seconds = 1  
Event: Select Function1
```

7.1 System functions

These functions are same as explained in function editor, but these can be used in scripts and executed on some conditions as per requirement. When function is required, just open script editor, select System functions and click at required function, it will insert syntax for specific function in script editor automatically.

Function	Operator	Statement	Object
System ▶		Page	▶
Math ▶		Tag	▶
		Alarm DataLog	▶
		Object	▶
		Recipe	▶
		Scheduler	▶
		Security	▶
		Print	▶
		Sound	▶
		Other	▶
		UserScript	▶



Please refer section “Function editor” for more details about above functions

Example

GotoFirstPage()

It is to navigate from current screen to first screen.

Syntax

```
GotoFirstPage();
```

```
if(Tag1 == 1)
{
GotoFirstPage();
}
```

7.2 Math functions

7.2.1 Abs()

This function is used to find Absolute value of X.

In mathematics, the **absolute value** (or **modulus**) of a real number is its numerical value without regard to its sign. So, for example, 3 is the absolute value of both 3 and -3.

Syntax

Abs (X, Y);

Where,

X is Tag name to store result

Y is Value source tag name

Example: Abs (Tag2,Tag1);

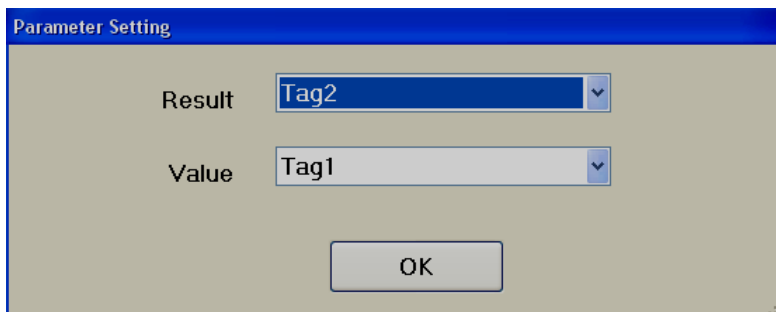

7.2.2 ACos()

This function is used to find Inverse cosine, result in radians.

$$\text{ACOS}(X) = \text{Cos}^{-1}(X)$$

Syntax

Acos(X, Y);

Where,

X is Tag name to store result

Y is Value source tag name

Example

Acos(Tag2,Tag1);

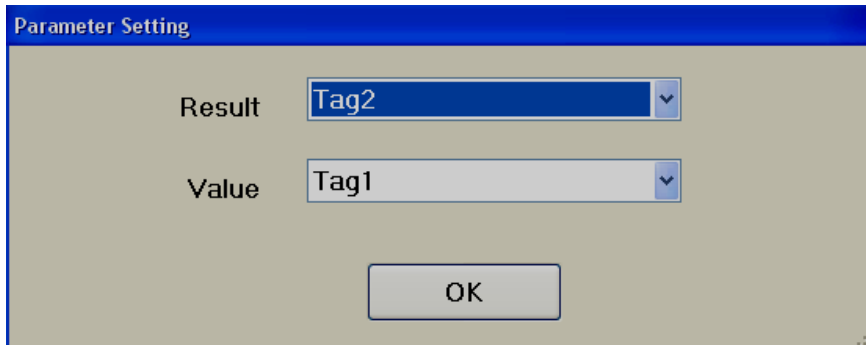

7.2.3 ASin()

This function is used to find Inverse Sin, result in radians.

$$\text{ASIN}(X) = \text{Sin}^{-1}(X)$$

Syntax

Asin(X,Y);

Where,

X is Tag name to store result

Y is Value source tag name

Example

Asin(Tag2,Tag1);

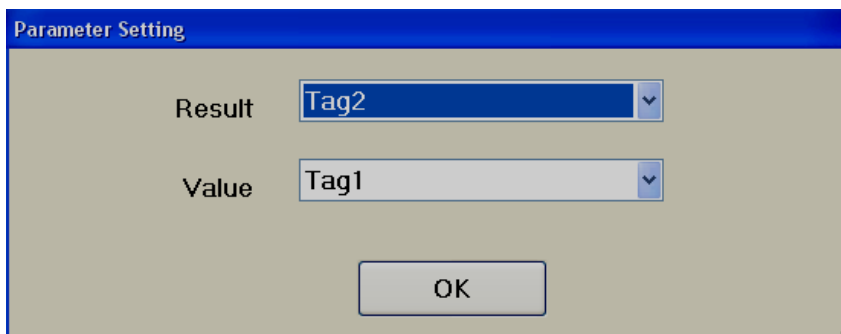

7.2.4 Atan()

This function is used to find Inverse Tan, result in radians.

$$\text{ATAN}(X) = \text{Tan}^{-1}(X)$$

Syntax

Atan(X,Y);

Where,
X is Tag name to store result
Y is Value source tag name

Example

Atan(Tag2,Tag1);

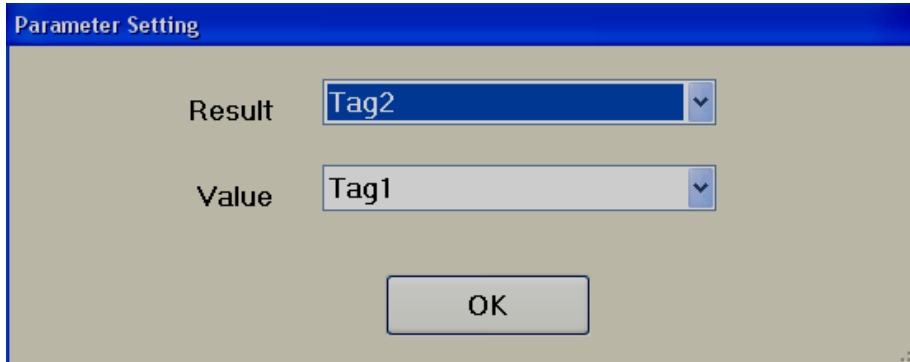

7.2.5 Cos()

This function is used to find cosine.

Syntax

Cos(X,Y);

Where,
X is Tag name to store result
Y is Value source tag name

Example

Cos(Tag2,Tag1);

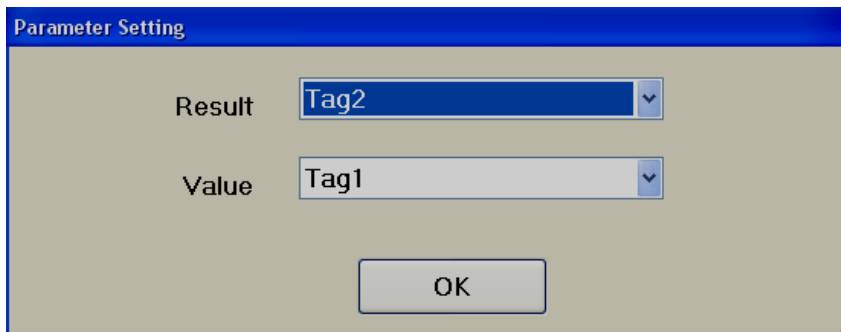

7.2.6 Exp()

This function is used to find e^x

EXP (X) = e^x

Syntax

Exp(X,Y);

Where,

X is Tag name to store result

Y is Value source tag name

Example

Exp(Tag2,Tag1);

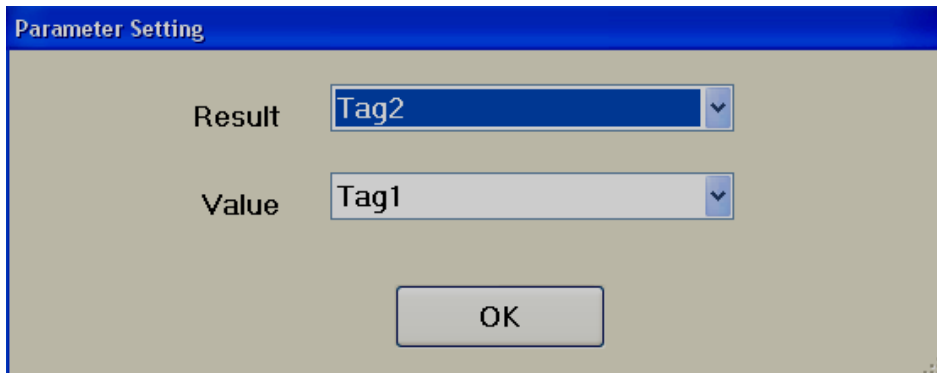

7.2.7 Log()

This function is used to find $\log_e(x)$

Syntax

Log(X,Y);

Where,

X is Tag name to store result

Y is Value source tag name

Example

Log(Tag2,Tag1);

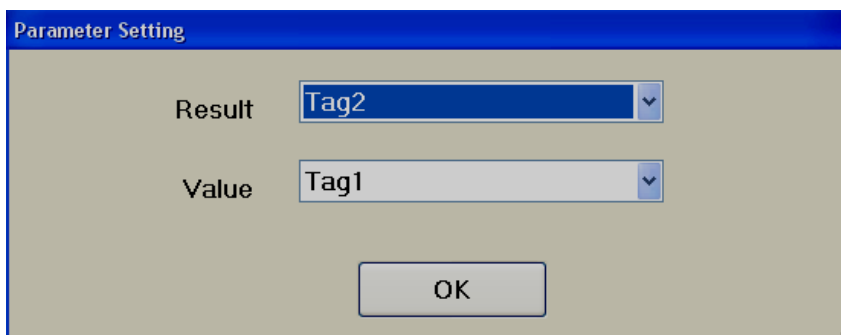

7.2.8 Log10()

This function is used to find $\log_{10}(x)$

Syntax

Log10(X,Y);

Where,

X is Tag name to store result

Y is Value source tag name

Example

Log10(Tag2,Tag1);

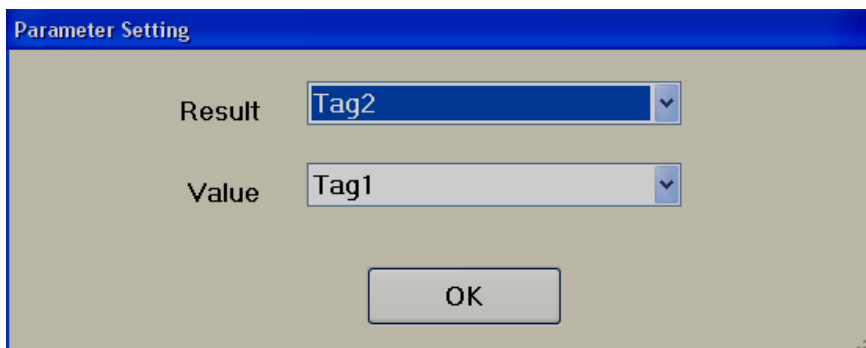

The screenshot shows a 'Parameter Setting' dialog box with a blue title bar. It contains two dropdown menus: 'Result' is set to 'Tag2' and 'Value' is set to 'Tag1'. Below the dropdowns is an 'OK' button.

7.2.9 Max()

This function is used to find maximum value in two Tags and store result in another Tag.

Syntax

Max(X,Y,X);

Where,

X is Tag name to store result

Y is Value1 source tag name

Z is Value2 source tag name

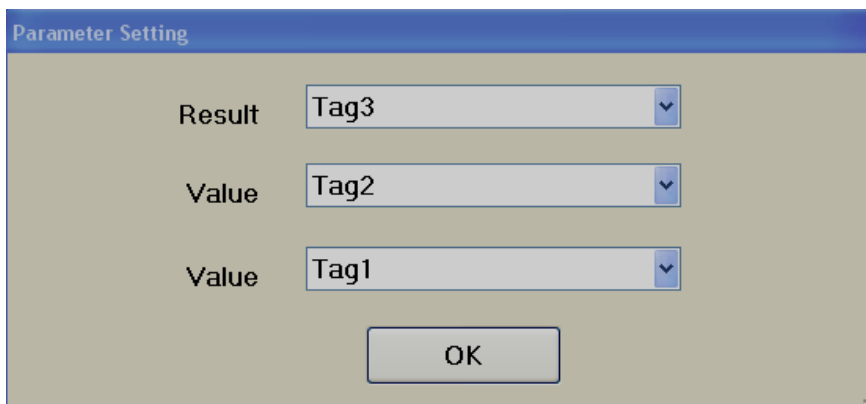

The screenshot shows a 'Parameter Setting' dialog box with a blue title bar. It contains three dropdown menus: 'Result' is set to 'Tag3', the first 'Value' field is set to 'Tag2', and the second 'Value' field is set to 'Tag1'. Below the dropdowns is an 'OK' button.

Example

Tag1=1
Tag2=2

Max(Tag3,Tag2,Tag1);

Now, Tag3=2

7.2.10 Min()

This function is used to find minimum value in two Tags and store result in another Tag.

Syntax

Min(X,Y,Z);

Where,

X is Tag name to store result

Y is Value1 source tag name

Z is Value2 source tag name

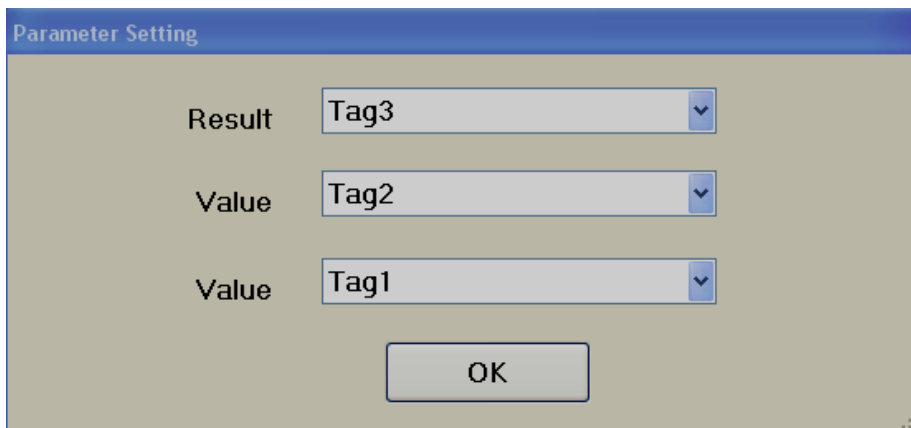

The image shows a 'Parameter Setting' dialog box with a blue title bar. It contains three rows of labels and dropdown menus. The first row has the label 'Result' and a dropdown menu showing 'Tag3'. The second row has the label 'Value' and a dropdown menu showing 'Tag2'. The third row has the label 'Value' and a dropdown menu showing 'Tag1'. Below these rows is an 'OK' button. The dialog box has a standard Windows-style appearance with a grey background and a blue border.

Example

Tag1=1
Tag2=2

Min(Tag3,Tag2,Tag1);

Now, Tag3=1

7.2.11 Pow()

This function is used to find Power

POW (X,Y) = X^Y

Syntax

Pow (X,Y,Z);

Where,

X is Tag name to store result

Y is Base value, X in X^Y

Z is Power value, Y in X^Y

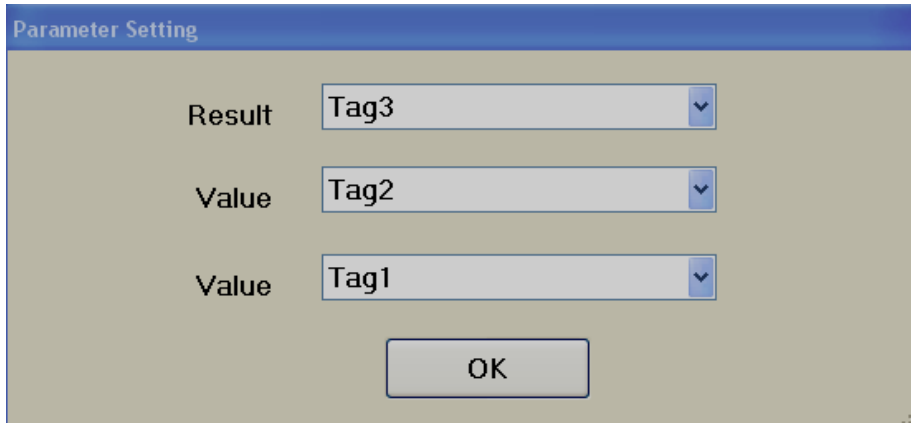

The image shows a 'Parameter Setting' dialog box with a blue title bar. It contains three rows of labels and dropdown menus. The first row has the label 'Result' and a dropdown menu with 'Tag3' selected. The second row has the label 'Value' and a dropdown menu with 'Tag2' selected. The third row has the label 'Value' and a dropdown menu with 'Tag1' selected. Below these fields is an 'OK' button. The dialog box has a standard Windows-style border and a small icon in the bottom right corner.

Example

Tag1=3 & Tag2=2

Pow (Tag3,Tag2,Tag1);

Tag3 = $X^Y = \text{Tag2}^{\text{Tag1}} = 2^3 = 8$

7.2.12 Round()

This function is used to find closest integral value of selected Tag.

Syntax

Round(X,Y);

Where,

X is Tag name to store result

Y is Value source tag name

Example

Round(Tag2,Tag1);

Tag1=3.49

Tag2 = ROUND(Tag2,Tag1); = 3

Example

Tag1=3.50

Tag2 = ROUND(Tag2,Tag1); = 4

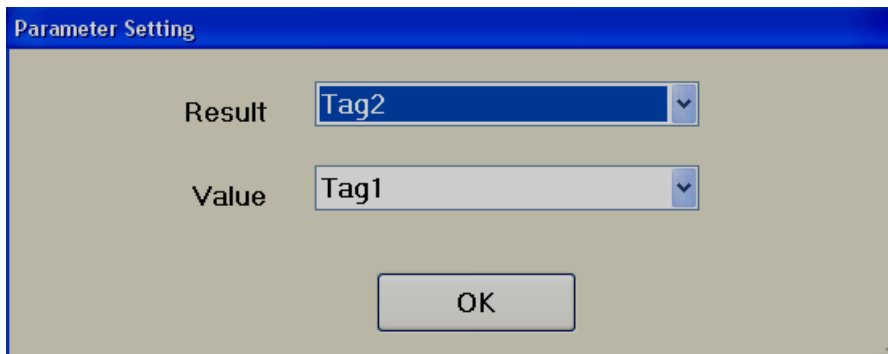

7.2.13 Sin()

This function is used to find Sin value

Syntax

Sin(X,Y);

Where,

X is Tag name to store result

Y is Value source tag name

Example

Sin(Tag2,Tag1);

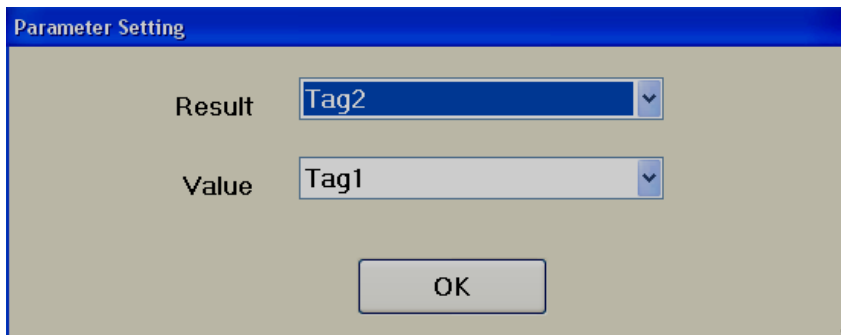

7.2.14 Sqrt()

This function is used to find **Square Root**

\sqrt{x}

Syntax

Sqrt(X,Y);

Where,

X is Tag name to store result

Y is Value source tag name

Example

Sqrt(Tag2,Tag1);

Tag1=4

Tag2 = Sqrt(Tag2,Tag1); = $\sqrt{4} = 2$

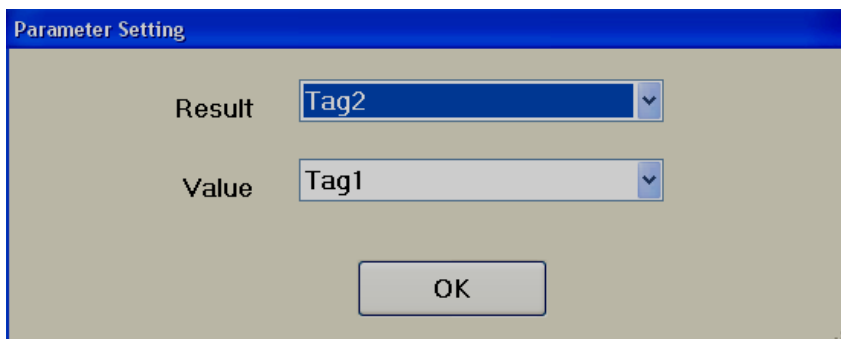

7.2.15 Tan()

This function is used to find Tan value.

Syntax

Tan(X,Y);

Where,

X is Tag name to store result

Y is Value source tag name

Example

Tan(Tag2,Tag1);

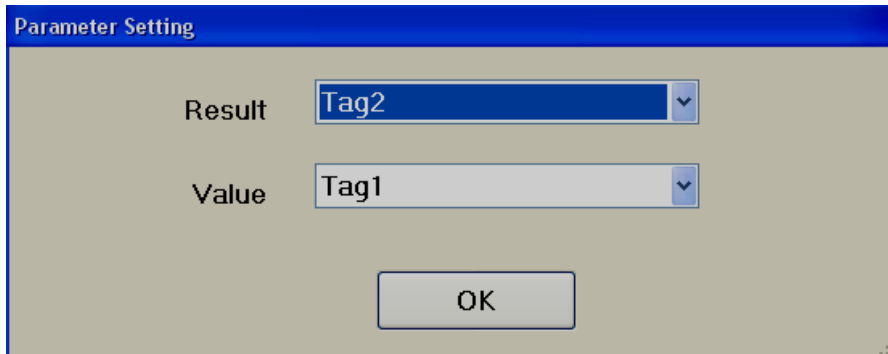

7.3 Arithmetic functions

7.3.1 ADD

This is to add two integers or float variables.

+ **Addition**

Syntax

$Y = A+B;$

Where, Y is Tag name

A, B = Tag Name or constant numeric value

Example

$Tag3 = Tag1+Tag2;$

$Tag1 = 1.1$

$Tag2 = 3.2$

$Tag3 = Tag1+Tag2; = 1.1+3.2 = 4.3$

7.3.2 SUB

- **Subtraction**

Syntax

$Y = A-B;$

Where, Y is Tag name

A, B = Tag Name or constant numeric value

Example

Tag3 = Tag2-Tag1;

Tag2 = 4

Tag1 = 3

Tag3 = Tag2-Tag1; = 4-3 = 1

7.3.3 MUL

* Multiplication

Syntax

Y = A*B;

Where, Y is Tag name

A, B = Tag Name or constant numeric value

Example

Tag3 = Tag2*Tag1;

Tag1 = 4

Tag2 = 3

Tag3 = Tag2*Tag1; = 3*4 = 12

7.3.4 DIV

/ Division

Syntax

Y = A/B;

Where, Y is Tag name

A, B = Tag Name or constant numeric value

Example

Tag3 = Tag2/Tag1;

Tag2 = 12

Tag1 = 3

Tag3 = Tag2/Tag1; = 12/3 = 4

7.3.5 Remainder

% Remainder of X/Y

Syntax

Y = A % B;

Where, Y is Tag name

A, B = Tag Name or constant numeric value

Example

Tag3 = Tag2%Tag1;

Tag2 = 17

Tag1 = 5

Tag3 = Tag2%Tag1; = 17%5 = 2

7.4 Logical functions

7.4.1 Bitwise And, &

Syntax

Y = A&B;

Where, Y is Tag name

A, B = Tag Name or constant numeric value

Ex: Tag3 = Tag2&Tag1;

The (&) operator compares two values with a bitwise AND function. You use the (&) operator with two operands, like this:

Evaluate a & b

Each of the operands “a” and “b” is converted to a binary number, and each of their bits is compared; that is, bit 1 of “a” is compared with bit 1 of “b”, and so on.

When two corresponding bits are both 1, bitwise AND combines them to produce 1

When one or both of the corresponding bits are 0, bitwise AND combines them to produce 0

For example, if you enter

Evaluate 25&77

25 and 77 are combined with a bitwise AND, and the result is 9

Ex: Tag3 = 25&77;

Result, Tag3 = 9

Ex: Tag3 = Tag2&Tag1;

7.4.2 Bitwise Or, |

Syntax

Y = A|B;

Where, Y is Tag name

A, B = Tag Name or constant numeric value

Ex: Tag3 = Tag2|Tag1;

The | operator compares two values with a bitwise OR function. You use the | operator with two operands, like this:

Evaluate a | b

Each of the operands “a” and “b” is converted to a binary number, and each of their bits is compared; that is, bit 1 of “a” is compared with bit 1 of “b”, and so on.

When two corresponding bits are both 0, bitwise OR combines them to produce 0,

When either of the corresponding bits is 1, bitwise OR combines them to produce 1

For example, if you enter

Evaluate 25|77

25 and 77 are combined with a bitwise OR, and the result is 93.

Ex: Tag3 = 25|77;

Result, Tag3 = 93

Ex: Tag3 = Tag2|Tag1;

7.4.3 Bitwise XOR, ^

Syntax

$Y = A^B;$

Where, Y is Tag name

A, B = Tag Name or constant numeric value

Ex: $\text{Tag3} = \text{Tag2} \wedge \text{Tag1};$

The ^ operator compares two values with a bitwise XOR (that is, a bitwise exclusive OR) function. You use the ^ operator with two operands, like this:

Evaluate $a \wedge b$

Each of the operands “a” and “b” is converted to a binary number, and each of their bits is compared; that is, bit 1 of “a” is compared with bit 1 of “b”, and so on.

When one of the bits--but not both--is 1, bitwise XOR combines them to produce 1.

When both bits are 0 or when both bits are 1, bitwise XOR combines them to produce 0.

For example, if you enter

Evaluate $25 \wedge 77$

25 and 77 are combined with a bitwise XOR, and the result is 84.

Ex: $\text{Tag3} = 25 \wedge 77;$

Result, $\text{Tag3} = 84$

Ex: $\text{Tag3} = \text{Tag2} \wedge \text{Tag1};$

7.4.4 Logical NOT, !

In arithmetic expressions, the ! operator means logical NOT

Syntax

$Y = ! A$

Where, Y is Tag name

A = Tag Name (Digital type) or numeric value say 0 or 1

Example

Tag1 and Tag2 are digital type

Tag2=!Tag1;

If Tag1 = 0, then, Tag2 = 1

If Tag1 = 1, then, Tag2 = 0

7.4.5 Bitwise NOT, ~

Bitwise NOT (also known as complement), takes the binary representation of a number, and turns all zeros into ones, and ones into zeros

Syntax

$Y = \sim X$

Where, Y is Tag name

A, B = Tag Name or constant numeric value

For example, bitwise Not of value 9 will result 4294967286

Evaluate ~9

The result of this command is 4294967286

It accepts variable as double which is 32 bit, so, $2^{32}-1 = 4294967295$

$\sim 9 = 4294967295 - 9$ which is equal to 4294967286

7.4.6 Logical AND, &&

It is also called as Conditional AND operator.

Syntax

$Y = A \ \&\& \ B$

Where, Y is Tag name

A, B = Tag Name or numeric value

Example: Tag3= Tag2&&Tag1;

The conditional AND operator (&&) is similar to the Boolean AND operator in that it evaluates two expressions and returns true when both expressions are true. It is different when the first expression evaluates to false. Since both expressions must be true, it's automatically assumed that if the first expression evaluates to false, the entire expression is false. Therefore, the conditional AND operator returns false and does not evaluate the second expression. When the first expression is true, the conditional AND operator goes ahead and evaluates the second expression.

The && operator compares two values with a bitwise AND function.

Evaluate a && b

Each of the operands “a” and “b” is converted to a binary number, and each of their bits is compared; that is, bit 1 of “a” is compared with bit 1 of “b”, and so on. When bits in both tags are 1, then, bitwise logical AND will produce 1. If any one or both of the tags contains 0, bitwise logical AND produce 0.

Example

2 =0010

3= 0011

Tag1 = Evaluate 2 & 3 = 0010

Tag1 = 2

```
bool inStock = false;
```

```
bool buy;
```

```
Tag1=18.95; //Price
```

```
buy = inStock && (Tag1 < 20.00); // buy = false
```

Notice that price < 20 will never be evaluated because in stock is already false.

7.4.7 Logical OR, ||

The Conditional OR Operator

Syntax

Y=A||B

The || operator means logical OR and has the same meaning as the OR operator.

Ex: Tag3 = Tag2||Tag1;

The conditional OR operator (||) is similar to the Boolean inclusive OR operator (||) in that it evaluates two expressions and returns true when either expression is true. The difference is when the first expression evaluates to true. Since either expression can be true to prove that the overall expression is true, the operator automatically assumes that the entire expression is true when it finds the first expression is true. Therefore, the conditional OR operator returns true without evaluating the second expression. When the first expression is false, the conditional OR operator goes ahead and evaluates the second expression.

Example:

```
bool changeOil;
```

```
changeOil = (Tag1>3000) || (Tag2>3);
```

```
Tag1=4305; // mileage  
Tag2=4; // Months  
changeOil = true
```

Notice that because mileage > 3000 is true, months >3 will never be evaluated.

7.4.8 True

The **true** keyword is a literal of type “bool” representing the boolean value true.

This is useful for types that represent true and false. Such types normally can be used for the controlling expression in “if”, “do”, “while”, “for” statements and also in “Conditional expressions”.

It require to create bool type variable

```
bool changeOil;  
changeOil = (Tag1>30) || (Tag2>3); // changeOil = true
```

```
if(changeOil == true)  
{  
    Tag3=1;  
}  
else  
    Tag3=0;
```

7.4.9 False

The **false** keyword is a literal of type “bool” representing the boolean value false.

This is useful for types that represent true and false. Such types normally can be used for the controlling expression in “if”, “do”, “while”, “for” statements and also in “Conditional expressions”.

It require to create bool type variable

```
bool changeOil;  
changeOil = (Tag1>30) || (Tag2>3); // changeOil = true
```

```
if(changeOil == false)  
{  
    Tag3=0;  
}  
else  
    Tag3=1;
```

7.5 Shift functions

7.5.1 Shift Left, <<

Syntax

Y = A << B;

Where Y is TagName

A, B are Integer values or Tag name;

Tag3=Tag2 << Tag1;

The << operator performs a shift left function on a number. A shift left function shifts a value's bits *n* characters to the left. The bits that are shifted out through the high-order bit are lost. For example, if you enter

Evaluate 3 << 1

the bit pattern in the number 3 is shifted left by one place. In other words, the bit pattern

... 0000 0011 #the value 3

becomes

... 0000 0110 #the value 6

Shifting left one place actually has the effect of multiplying a value by 2.

Ex: Tag1 = 3 << 1;

Result, Tag1 = 6

Tag3=Tag2 << Tag1;

7.5.2 Shift Right, >>

Syntax

Y = A >> B;

Where Y is TagName

A, B are Integer values or Tag name;

Tag3=Tag2 >> Tag1;

The >> operator performs a shift right function on a number. A shift right function shifts a value's bits *n* characters to the right. The bits moved out of the low-order bit are lost, and the bits shifted in to the high-order bits on the left have a value of 0. For example, if you enter

Evaluate 3 >> 1

the bit pattern

... 0000 0011

becomes

... 0000 0001

which has a value of 1. The right shift is a *logical* right shift, because bits with a value of 0 are moved into the high-order bits.

Ex: Tag1 = 3 >> 2;
Result, Tag1 = 1

Tag3=Tag2>>Tag1;

7.6 Relational functions

7.6.1 Equal To, ==

Equal to (strings, numbers, and variables)

Syntax

Y = A == B;

**Where, Y is Tag name;
A, B is Numeric value or Tag Name**

The character == means "equals" when it compares text strings, arithmetic values, or variables that contain text strings or arithmetic values. If the value of the expressions are equal, the command returns 1, meaning true; if the expressions are not equal, the command returns 0, meaning false.

```
if(Tag2==1)
{
Tag4=40;
}
```

When used with a text string, the match is case sensitive; for example

Tag1, string data type, Default Value = HELLO

```
if(Tag1=="HELLO")
{
Tag4=40;
}
else
Tag4=60;
```

Result, Tag4 = 40

Tag1, string data type, Default Value = HELLO

```
if(Tag1=="hello")
{
Tag4=40;
}
else
Tag4=60;
```

Result, Tag4 = 60

7.6.2 Not Equal To, !=

Not Equal to (strings, numbers, and variables)

The != operator means "not equal to" and is used between two numbers or variables in an expression. The != operator has the same meaning as the <> and ≠ operators.

Syntax

Y = A != B;

**Where, Y is Tag name;
A, B is Numeric value or Tag Name**

The character != means "Not equals" when it compares text strings, arithmetic values, or variables that contain text strings or arithmetic values. If the value of the expressions are not equal, the command returns 1, meaning true; if the expressions are equal, the command returns 0, meaning false.

```
if(Tag1!=1)
{
Tag4=40;
}
Else
Tag4=60;
```

When Tag1 = 1, Result, Tag4 = 60

When Tag1 = 10, Result, Tag4 = 40

7.6.3 Less than, <

Syntax

Y = A < B;

**Where, Y is Tag name;
A, B is Numeric value or Tag Name**

In arithmetic expressions, the < character means "less than." You can use the < character to compare the values of numbers or variables.

```
if(Tag1 < 10)
{
Tag4=40;
}
```

Else

```
Tag4=60;
```

When Tag1 = 5, Result, Tag 4 = 40

When Tag1 = 15, Result, Tag 4 = 60

7.6.4 Greater than, >

Syntax

Y = A > B;

**Where, Y is Tag name;
A, B is Numeric value or Tag Name**

In arithmetic expressions, the > character means "greater than." You can use the > character to compare the values of numbers or variables.

```
if(Tag1 > 10)
{
Tag4=40;
}
```

Else

```
Tag4=60;
```

When Tag1 = 5, Result, Tag 4 = 60

When Tag1 = 15, Result, Tag 4 = 40

7.6.5 Less than or equal to, <=

Syntax

Y = A <= B;

**Where, Y is Tag name;
A, B is Numeric value or Tag Name**

In arithmetic expressions, the <= character means "less than or equal to." You can use the <= character to compare the values of numbers or variables.

```
if(Tag1<= 10)
{
Tag4=40;
}
```

Else

```
Tag4=60;
```

When Tag1 = 1 or 5 or 10, Result, Tag 4 = 40

When Tag1 = 11 or 15 or any value greater than 10, Result, Tag 4 = 60

7.6.6 Greater than or equal to, >=

Syntax

Y = A >= B;

**Where, Y is Tag name;
A, B is Numeric value or Tag Name**

In arithmetic expressions, the >= character means "greater than or equal to." You can use the >= character to compare the values of numbers or variables.

```
if(Tag1>= 10)
{
Tag4=40;
}
```

Else

```
Tag4=60;
```

When Tag1 = 10 or 20 or 30, Result, Tag 4 = 40

When Tag1 = 5, Result, Tag 4 = 60

7.7 Assignment functions

7.7.1 Equal to, =

Syntax

Y = A;

**Where, Y is Tag name;
A is Numeric value or Tag Name**

In arithmetic expressions, = character means "equal to." You can use the = character to assign the values of numbers or variables.

Tag1 = 10;

Tag10 = Tag2

7.8 Selection functions

Syntax

```
If(expression)  
{  
}  
Else  
{  
}
```

Ex: If(Tag1==1)

```
{  
Tag4=20;  
}  
Else  
{  
Tag4=60;  
}
```

7.9 Iteration functions

7.9.1 While



Syntax

While(boolean Expression)

```
{  
statements;  
}
```

Continually executes the statements until the Boolean Expression becomes false. The body of a `while` loop will be executed.

Note: Please be careful while using iteration functions as there is a chance of creating infinite loops and HMI may go for non responsive mode or extensive delays in response. Make sure to have loop break statements available inside body of while statements to avoid infinite loops.

```
int a = 1;
```

```
While(a<10)
```

```
{  
a = a +1;  
Tag1=a;  
}
```

Result, Tag1 = 10 when above script is executed

7.9.2 For

Syntax

for(initialization ; Boolean Expression ; increment)

```
{  
statements;  
}
```

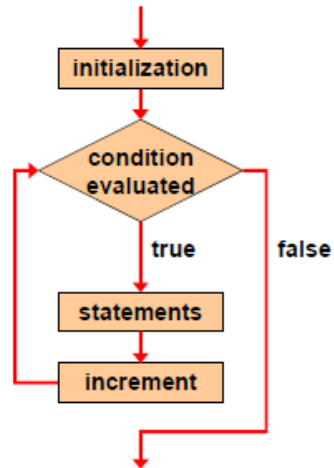

```
int i;
```

```
for(i=1; i < 100; i++)
{
  Tag1=i;
}
```

Result, Tag1=99 when above script is executed

7.10 Jump functions

7.10.1 Break

This is normally used in iteration loops like While, For Loops to break the loop when condition is true.

Syntax

```
Break;
int a = 1;
While(a<10)
{
  a = a +1;

  if(a>=7)
  {
    break; // to avoid infinite loop
  }
}
```

```
Tag1=a;
```

```
}
```

Result, Tag1 = 6 when above script is executed

7.10.2 Continue

Any remaining statements in the current iteration are not executed. It is used to bypass a section of a code. The next iteration of the loop is determined as follows :

- In a **while** loop, the next iteration starts by reevaluating the controlling expression of the **while** statement.
- In a **for** loop (using the syntax **for**(*init-expr*, *cond-expr*, *loop-expr*)), the *loop-expr* clause is executed. Then the *cond-expr* clause is reevaluated and, depending on the result, the loop either ends or another iteration occurs

```
int a = 1;

while(a<100)
{
a = a +1;

if(a<95)
continue;
ShowMessage(a);
}
```

Result, it will not show values between 1 and 94 because, remaining statements in the current iteration are not executed after continue statement. Result will show values 95, 96, 96, 98, 99, 100 because of usage of continue with conditional statement as above.

8. Historical viewer

It is a PC based tool to view historical data and historical alarms

8.1 Human machine interface (HMI)

8.1.1 Preparation of historical data storage in HMI

Procedure

1. Configure data logging, insert historical trend object in HMI, complete configuration of pens, download application to HMI and make sure historical data is showing properly in historical trend at run time.
2. Configure alarms, insert historical alarm box in HMI, download application to HMI and check historical alarms. If required, refresh alarms in Run time using Button linked with “Update Historical” function and make sure historical alarms showing properly in historical alarm box in Run time
3. Historical data and alarms are stored in internal memory/SD card as per data storage path defined at Project explorer-Setting-Runtime-Internal storage
4. Once data logging is configured in HMI, in Run time, historical data will be stored in HMI internal memory or SD card as per configuration. Once alarms are configured properly in HMI and they appear in run time, historical alarms will be stored in HMI internal memory or SD card as per configuration. These historical alarms and historical data can be archived in PC later using historical viewer software.

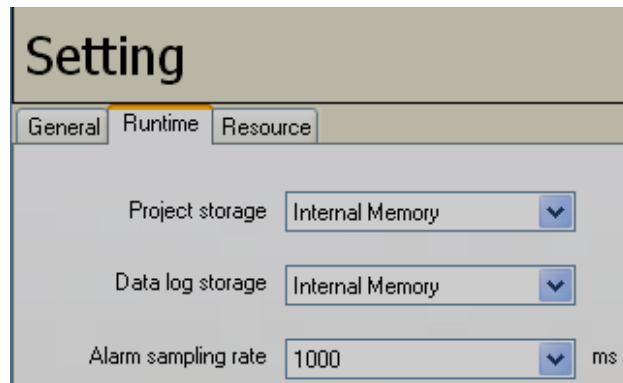

5. Historical data and alarms can be dumped from Internal memory/SD card to USB stick or directly transfer from HMI to PC via Ethernet using Historical viewer software.

8.1.2 HMI data archive in PC using storage device (USB stick)

1. First make sure data logging and historical trend is configured properly in HMI and they are running fine in Run time. Create a button in HMI screen. Link with a function – “Dump Alarms and Data”

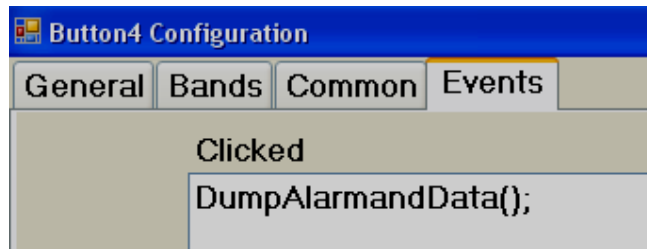

2. Check contents in USB stick. Make sure it is empty at first time and no invalid files are available in USB stick.
3. Insert USB stick in USB port of HMI
4. In Run time, check if historical data is showing properly or not in historical trend. If required, press “Zoom” and verify the presence of data.
5. Press on “Dump” button. Then, it transfers historical data and alarms from Internal memory/SD card to USB stick
6. Now, remove USB stick from HMI. Insert USB stick in PC and check its contents. It should have files similar to the following



7. Make sure Historical viewer software installed in PC. Double click on “Historical viewer” icon  available at desktop

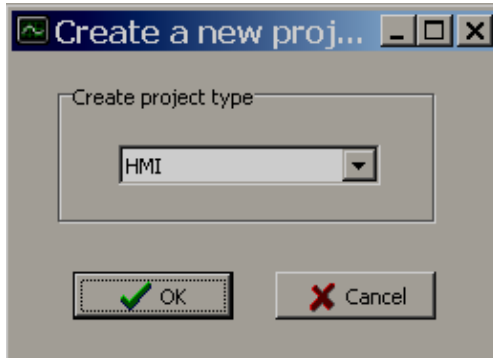

8. Select HMI and click "OK"

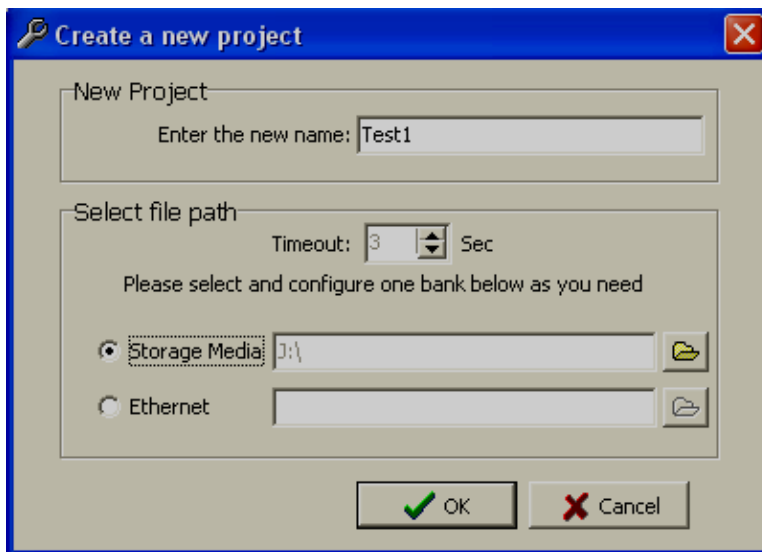

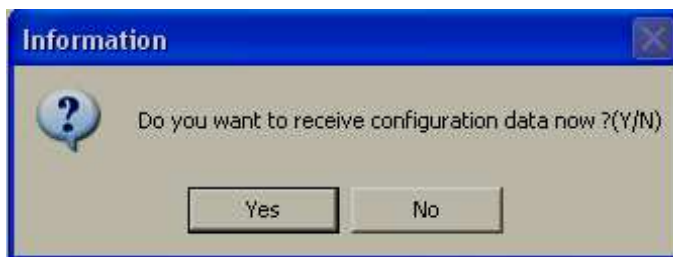

9. Enter the Project name. Select "Storage media", click at open folder icon  and select the path for the USB stick. Then, click "OK"

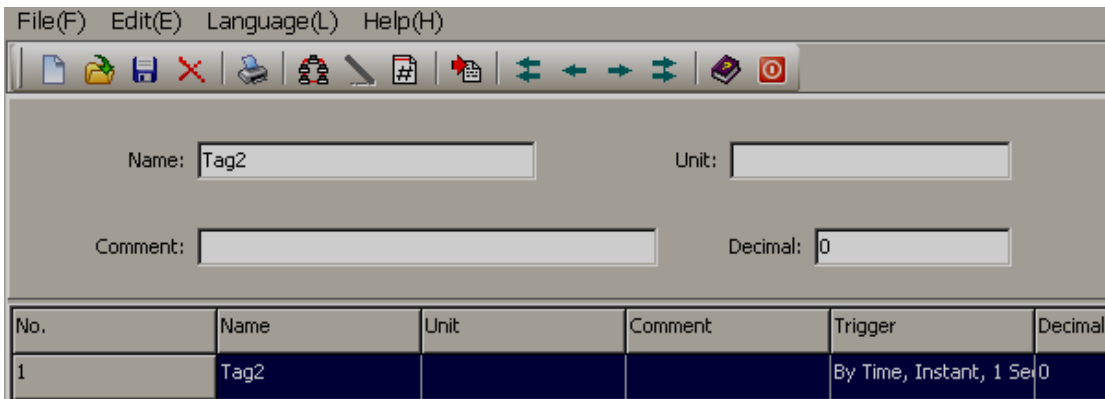

10. Click "Yes".



11. All data log tags will be shown here. Enter the unit and select the number of decimal points

12. Click "Save" icon . Then, click Return icon  to return to main program

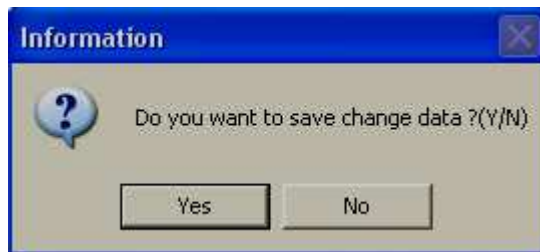

13. Click "Yes" to save project configuration in PC

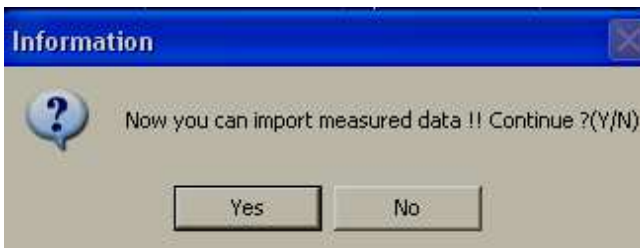

14. Click "Yes" to import historical data and alarms from USB stick to PC

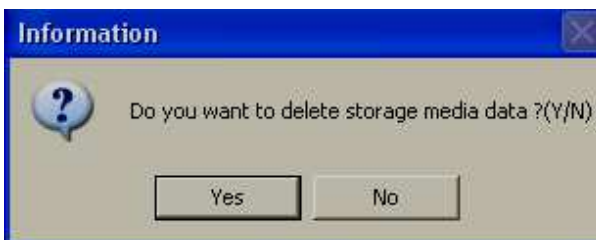

15. Click "Yes" to delete data and alarms from USB stick. Click "No", if you wishes to remain historical data and alarms in USB stick after transferring to PC

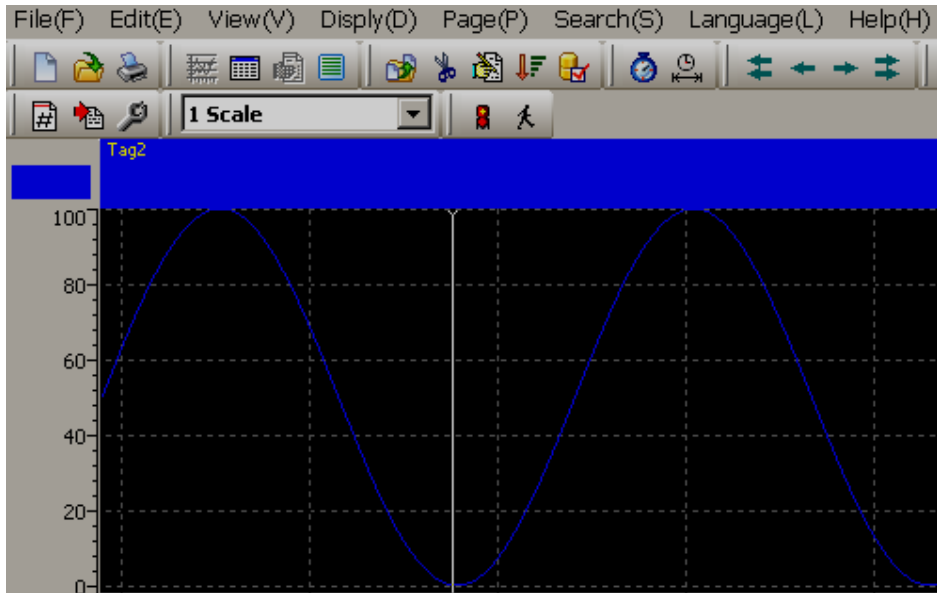

16. Now, you can view historical data trend in PC

8.1.3 HMI data archive in PC via Ethernet

1. First make sure data logging and historical trend is configured properly in HMI and they are running fine in Run time.
2. In Run time, check if historical data is showing properly or not in historical trend. If required, press "Zoom" and verify the presence of data.
3. Check IP address of HMI using System information at Control centre at HMI startup. For example, it is 192.168.0.203
4. If HMI is connected to PC directly, then, use cross over Ethernet cable. If HMI is connected to PC via LAN, then, use straight cable

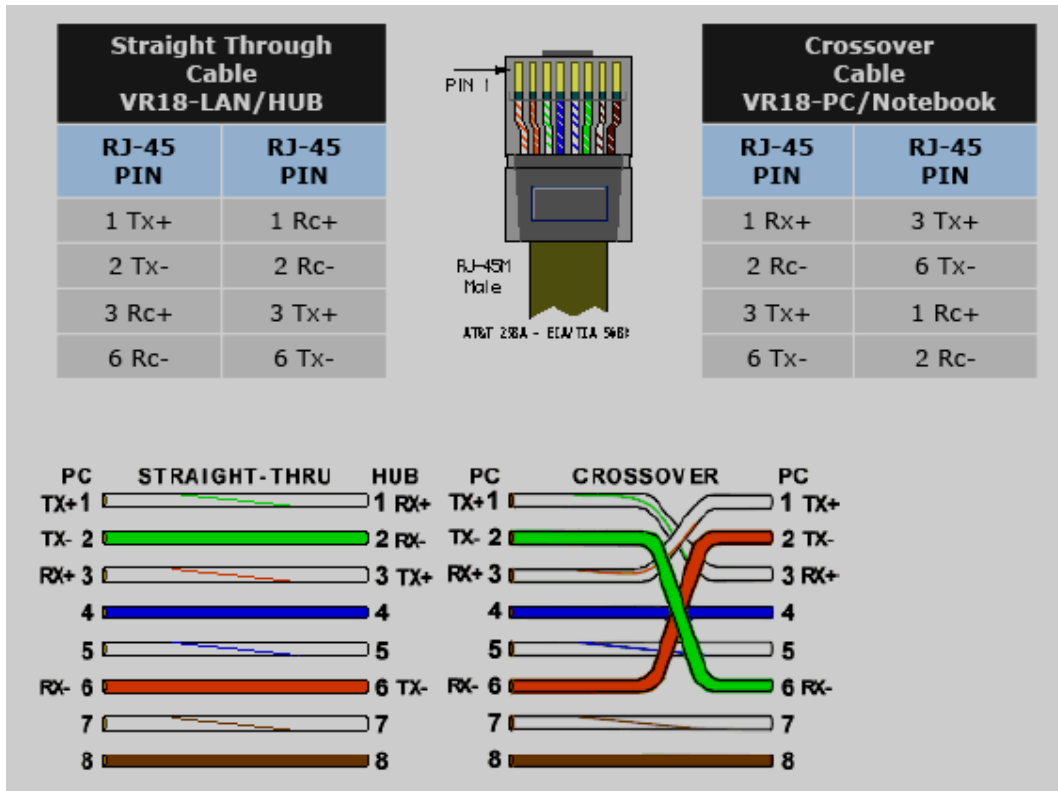

- At Dos prompt, using “Ping” instruction, check if communication is OK between HMI and PC. If it is OK, then, you should get reply as follows. If there is no reply, then, check Ethernet cable and IP address of HMI

```

C:\ Command Prompt
Microsoft Windows XP [Version 5.1.2600]
(C) Copyright 1985-2001 Microsoft Corp.

C:\Documents and Settings\mahi.MAHIDHAR>Ping 192.168.0.203

Pinging 192.168.0.203 with 32 bytes of data:

Reply from 192.168.0.203: bytes=32 time<1ms TTL=128
Reply from 192.168.0.203: bytes=32 time<1ms TTL=128
Reply from 192.168.0.203: bytes=32 time<1ms TTL=128
Reply from 192.168.0.203: bytes=32 time<1ms TTL=128

Ping statistics for 192.168.0.203:
    Packets: Sent = 4, Received = 4, Lost = 0 (0% loss),
    Approximate round trip times in milli-seconds:
        Minimum = 0ms, Maximum = 0ms, Average = 0ms

C:\Documents and Settings\mahi.MAHIDHAR>

```

- Make sure Historical viewer software installed in PC. Double click on “Historical viewer” icon  available at desktop

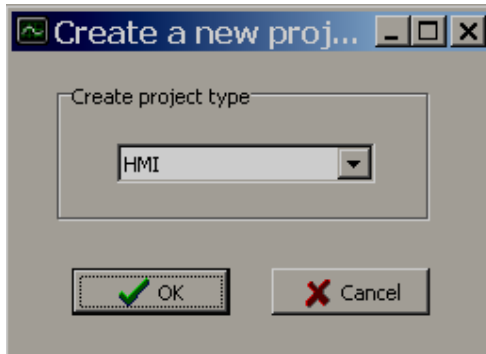

7. Select HMI and click "OK"

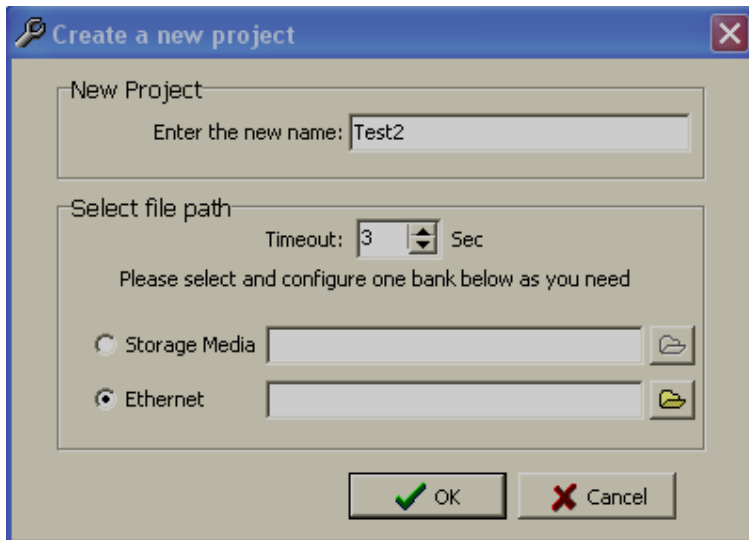

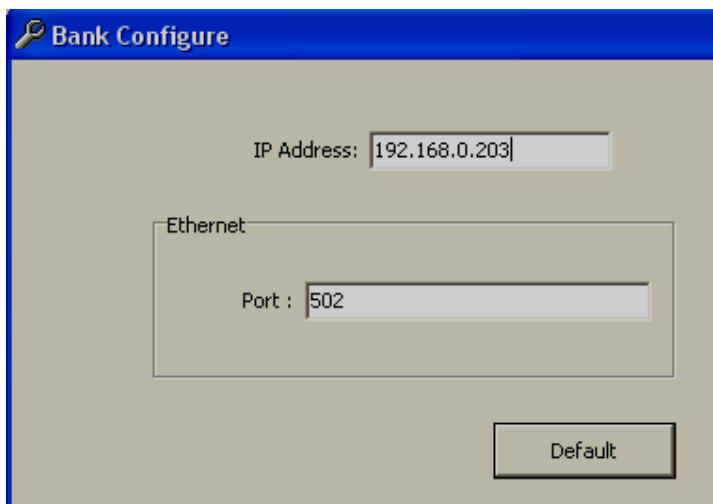

8. Enter the Project name. Select "Ethernet", click at open folder icon  and Enter IP address of HMI. Then, click "OK"

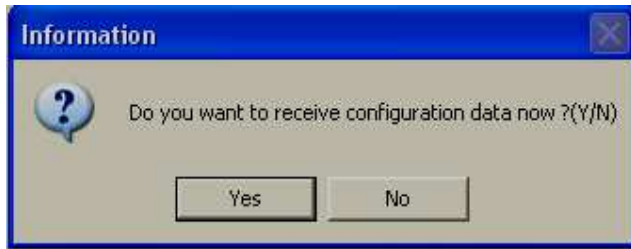

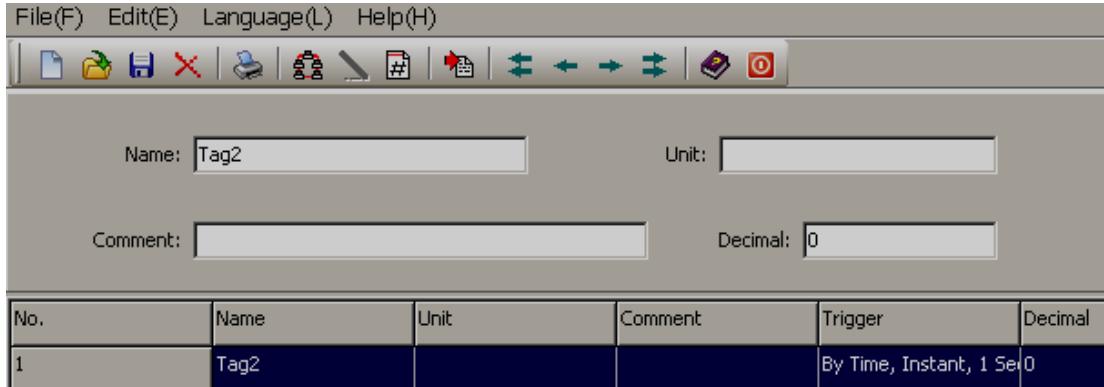
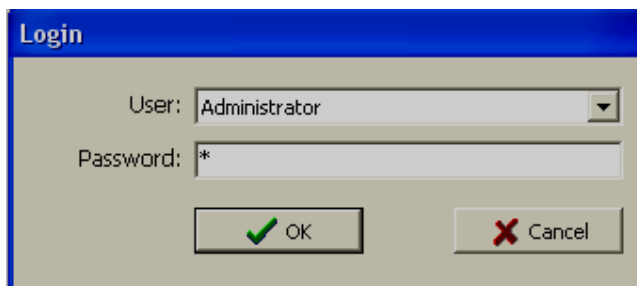

9. Click "Yes".
10. If security level is configured for historical viewer, then, it needs to enter user name and password



11. All data log tags will be shown here. Enter the unit and select the number of decimal points
12. Click "Save" icon . Then, click Return icon  to return to main program

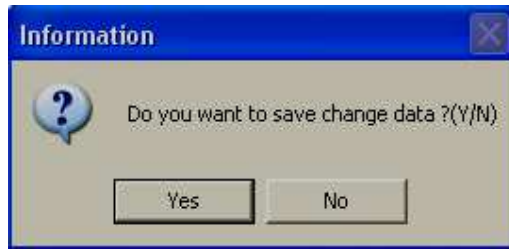

13. Click "Yes' to save project configuration in PC

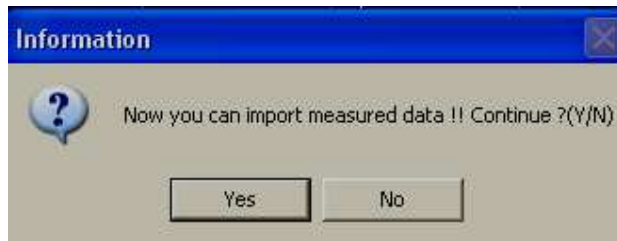

14. Click "Yes" to import historical data and alarms from HMI to PC via Ethernet

Note: If SD card used for data storage and data size is more than 64 MB, then, you need to switch OFF HMI, remove SD card, insert in SD card reader, then import data to PC. If data size is more than 64 MB, it is not possible to transfer data from HMI to PC directly via Ethernet cable

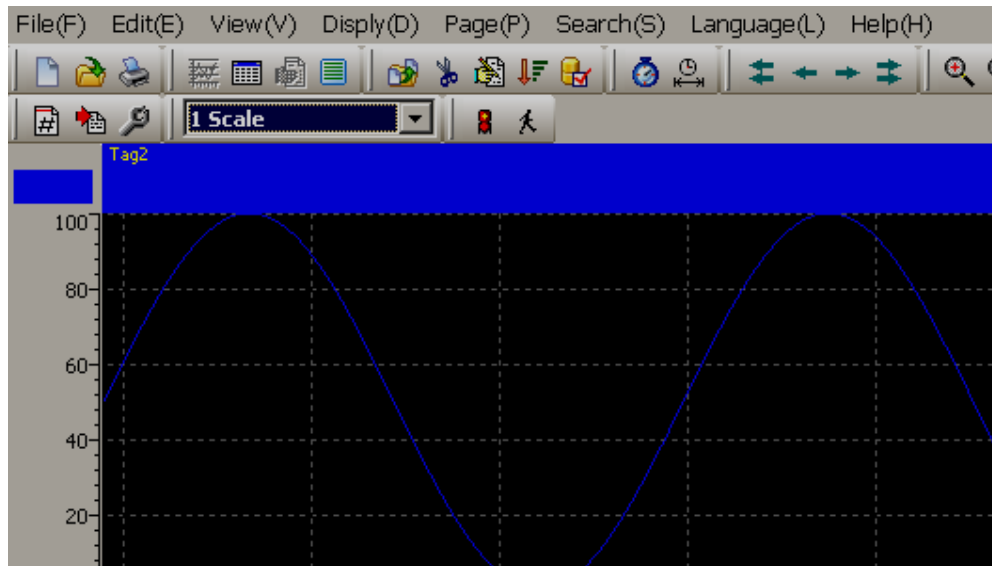

15. Now, you can view historical data trend in PC
16. If security is configured for Historical viewer, then, after seeing the data, if you wishes to close the historical viewer or log out, then, it prompts to digitally sign the record by entering user name and password. Then only, it is possible to exit from historical viewer

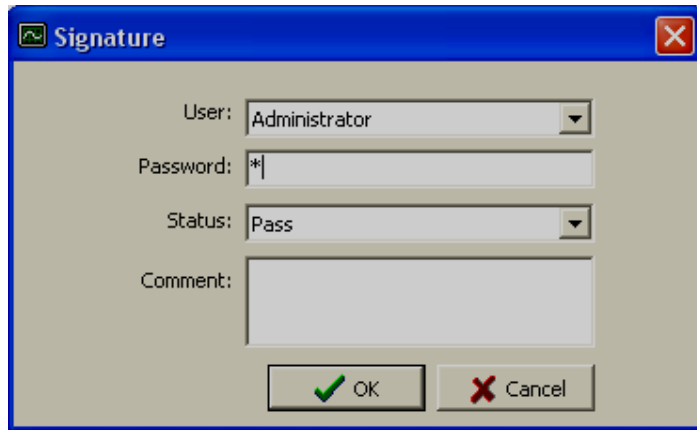

8.2 Reserved

8.3 Tools

8.3.1 Tool Bar



-
-
-
-
-
-
-
-
-
-
-
-

 Black background  White background

 Show graphical representation horizontally

 Show graphical representation vertically

8.3.2 Menu Bar

File(F) Edit(E) View(V) Disply(D) Page(P) Search(S) Language(L) Help(H)

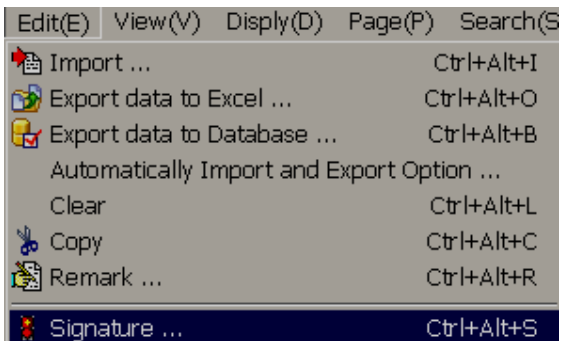
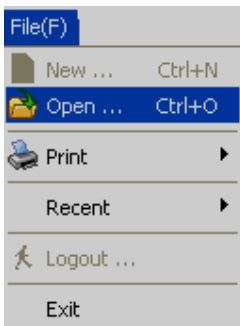

Import: reserved for future

Export: To export data to excel

Clear: To clear the clipboard

Copy: To copy the current screen image to clipboard.

Remark: To enter custom comments by user

Import Option: To refresh historical data as per set time interval

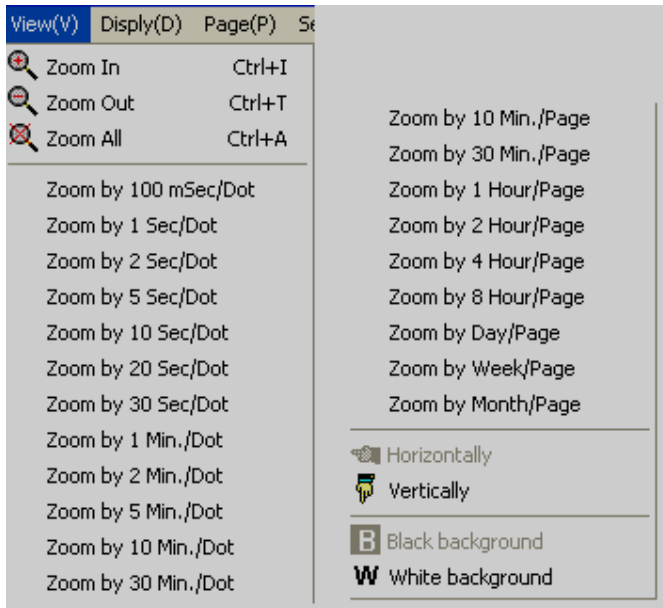

Zoom: Various options available for selection as shown above

Horizontally: To view historical trend horizontally in screen

Vertically: To view historical trend vertically in screen

Black background: To set black back ground for historical trend

White background: To set white background for historical trend

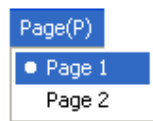

Page: To select the page

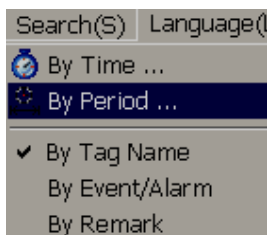

Search: To search historical data by various options

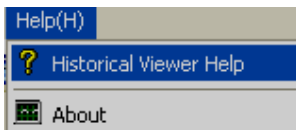

8.4 Import

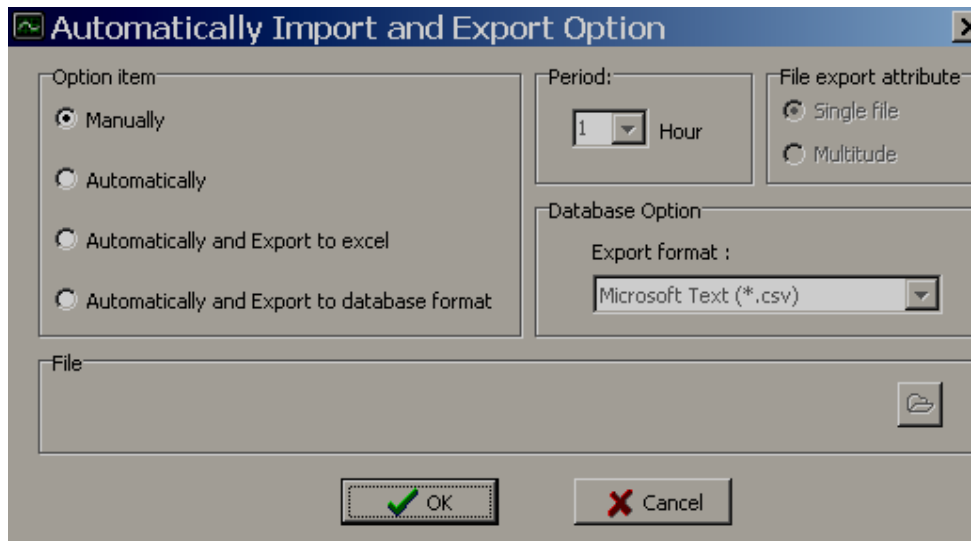
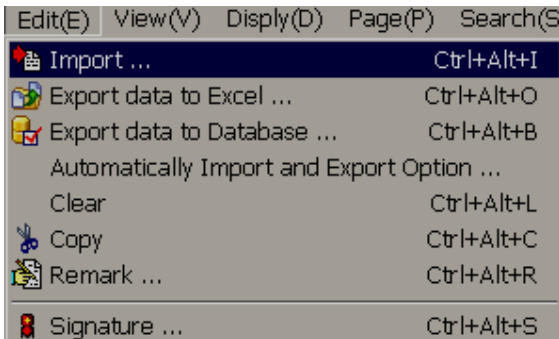

Manually: Select this option if it is required to import historical data and alarms manually from device to PC

Automatically: Select this option and select period between 1 to 24 hrs. to automatically import historical data and alarms from device to PC.

Automatic works only when device is connected to PC via Ethernet

8.5 Export data to Excel

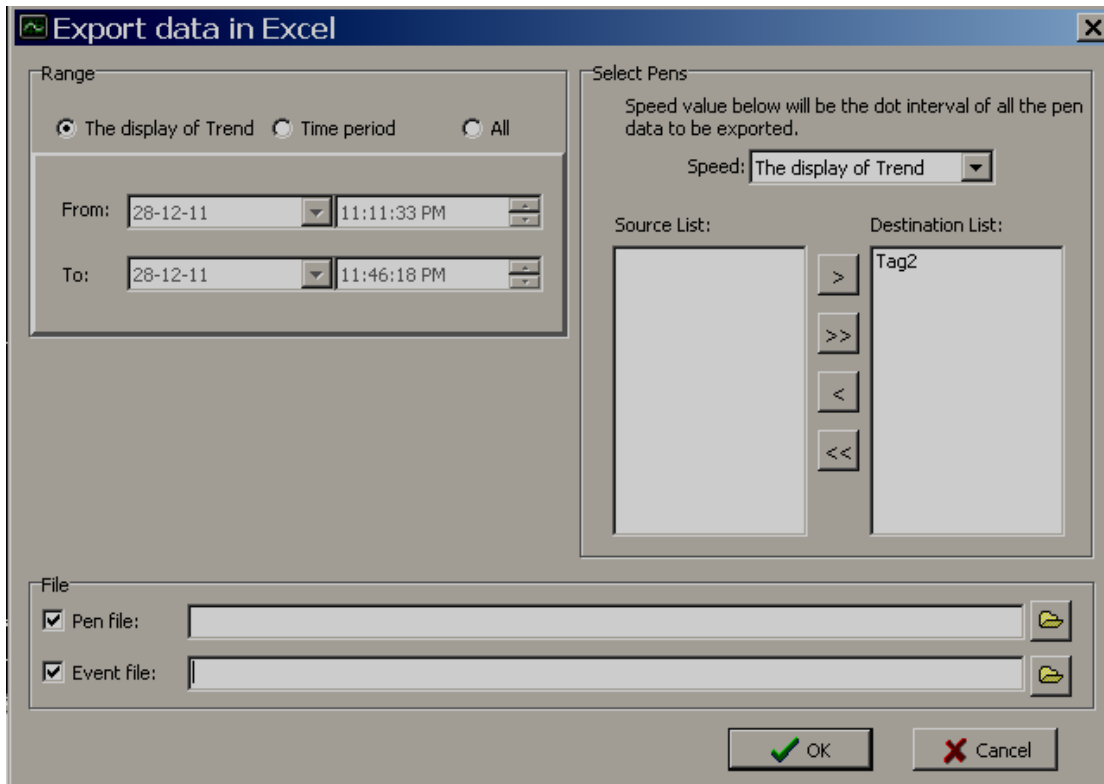
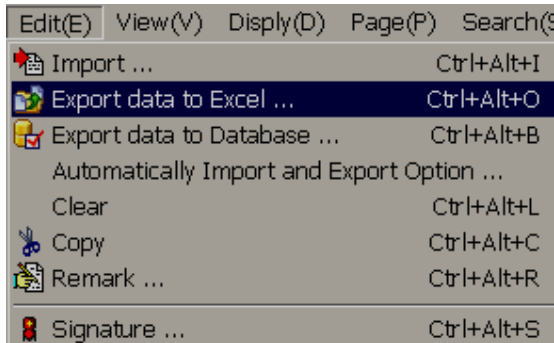

Range

The display: Select this option if it is required to export data specific to display screen (current view).

Time Period: Select this option and enter start data, end date, start time and end time. This is to select historical data with specific time period and then export to excel

All: Select this option if all the historical data needs to export to excel files.

Speed: This is to select resolution for data archival.

100 msec/dot, 1 sec/dot, 2 sec/dot, 5 sec/dot, 10 sec/dot, 20 sec/dot, 30 sec/dot, 1 min/dot, 2 min/dot, 5 min/dot, 10 min/dot, 30 min/dot, 10 min/page, 30 min/page, 1 hr/page, 2 hrs/page, 4 hrs/page, 8 hrs/page, day/page, week/page and month/page

For example: If 1 sec/dot selected, then you can archive data once in a second.

If 1 min/dot selected, then you can archive data once in 1 min

Source List: Tags available for selection for data export

Destination List: Tags already selected for data export



Move Tag from source to Destination



Move all Tags from Source to Destination



Move Tags from Destination to Source



Move all Tags from Destination to Source

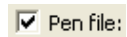

Pen file: Select path of data files where all the excel files (data) need to be available.

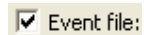

Event file: Select path of event files where all the excel files (event/alarms) to be available.

By default, all the above files will be stored at

C:\Program Files\Historical Viewer\Historical\Test2\Test2_Pen.csv

C:\Program Files\Historical Viewer\Historical\Test2\Test2_Event.csv

If you wish to store data/event excel files in different folder, click on  icon and then specify the target folder and click on "Save".



If there is large data, after 65535 rows, it creates new excel file with name Project name (Part X), where X is the file number say 1, 2 etc.

8.6 Export data to database

At present, it is similar to export data to excel. But, if you use this option, it is possible to open files using Notepad

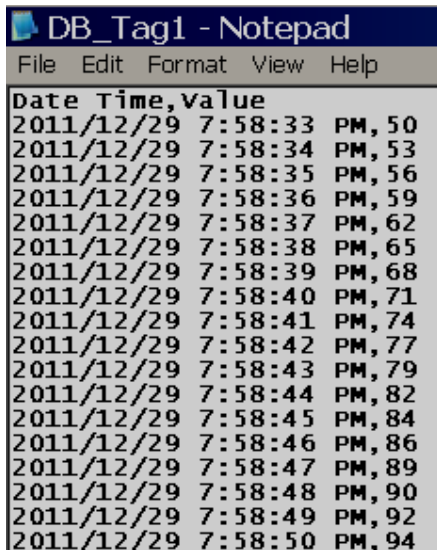
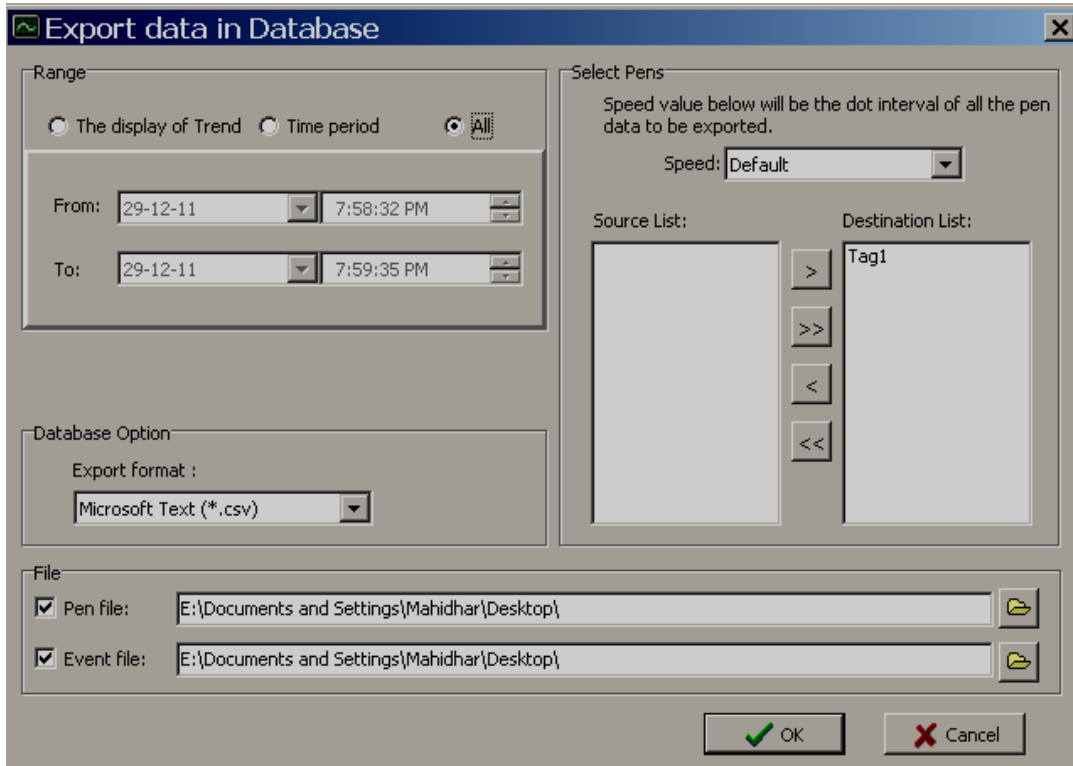

8.7 Remark

This is used to mark comment on data after verification. For example: supervisor checks historical trend and may wishes to mark a comment say “Irregular” at specific date/time. Maximum 40 characters are allowed in each remark.

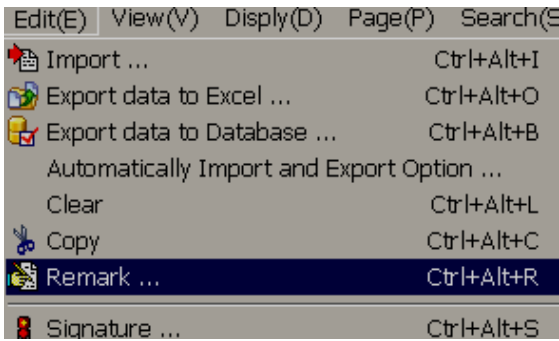

In historical viewer, there is a pointer which moves around the trend for selecting the data. Just use the mouse and left-single click on historical trend, then you can see pointer “+” as shown attached.

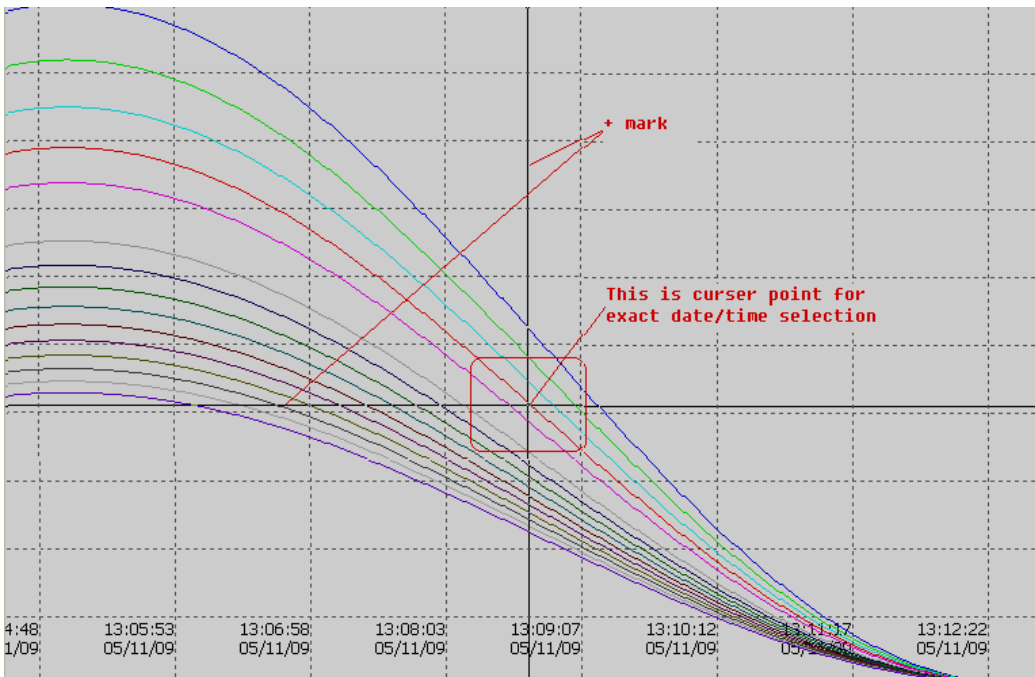

Place the pointer at exact date/time required, then in menu, click on “Edit”, then “Remark” and now, it prompts the following.

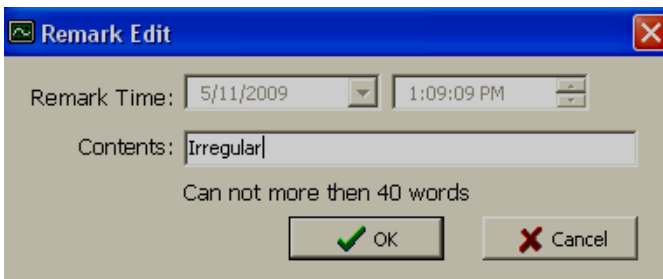

Click on “OK” after writing remark

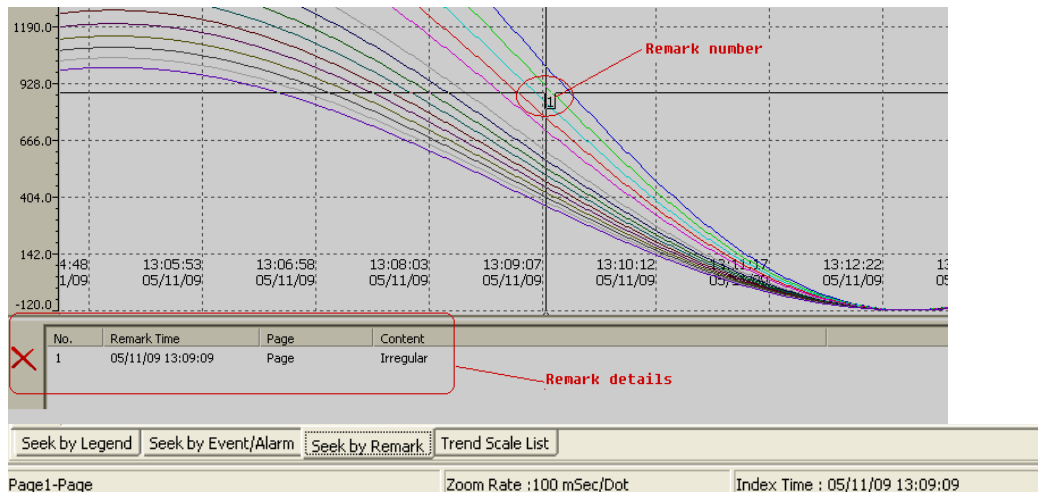

Later, it is possible to search data with respect to above remark by any one of the following ways.

Click on Remark icon 

In Menu, click on “Search”, then select “Remark”

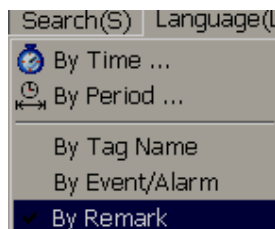

Alternatively, near the task bar at bottom area of the screen, click on “Seek by Remark”

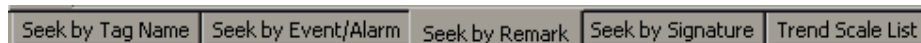

Then, it will show list of Remarks available in a window. Just double click on selected Remark and pointer will navigate to specific remark number automatically at specific date/time.

8.8 View

This is to display trend in monitor with various zoom rate.

Horizontally: To view historical trend horizontally in screen

Vertically: To view historical trend vertically in screen

Black background: To set black back ground for historical trend

White background: To set white background for historical trend

For example: Zoom 1 sec/dot

First check, monitor current display setting

If screen resolution is “1280 X 800” pixels, then you may be able to see data around 900 sec. at right side of the trend, it shows digital values and it occupies remaining pixels.

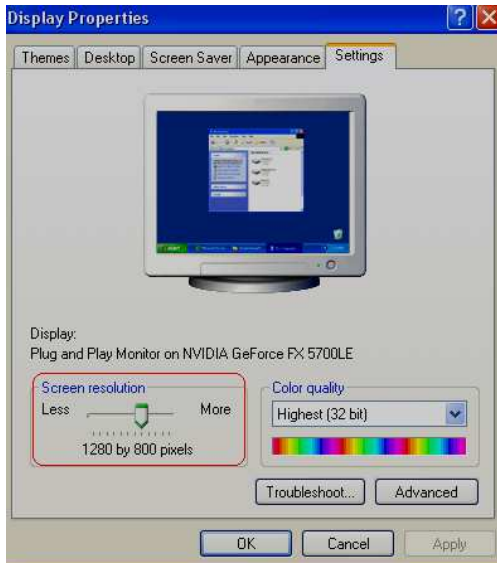

8.9 Display

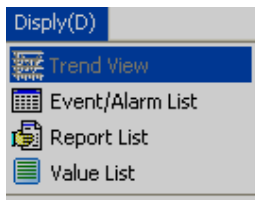

8.9.1 Trend view

It is to view historical trend

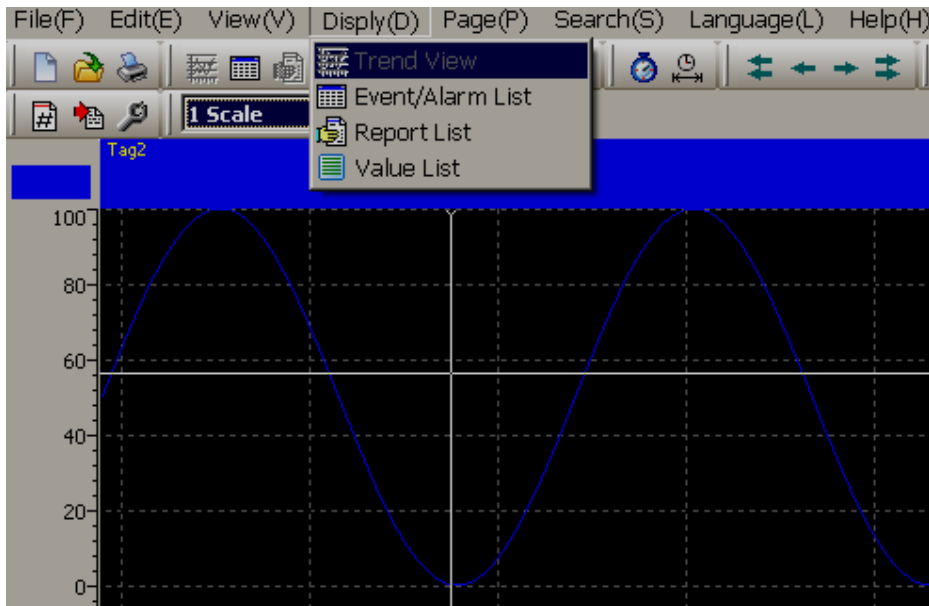

If 24 pens are configured in page1 and if it is required to view only 1 to 8 pens, then select them in window as shown.

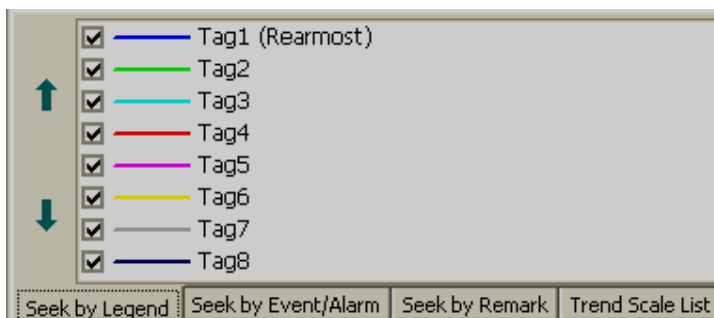

Tag1 scale is -120 to 1000

Tag2 scale is -120 to 1100

If it is required to see both the scales, then click on “Trend scale List”, select the required tags.

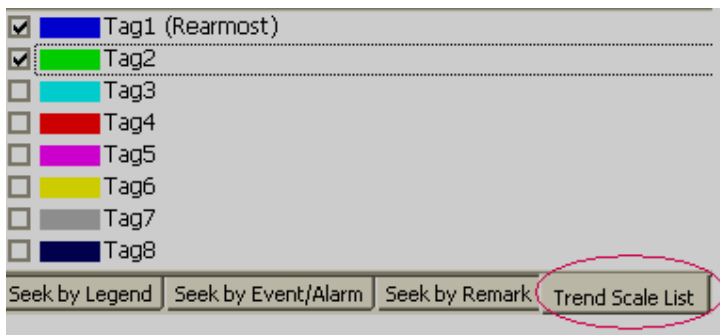

Select “All Scale” option as shown attached

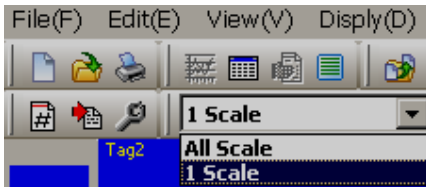

If it is required to change color, width, display scale of specific pen, then do the settings in HMI configuration itself. The settings made at HMI shall be retrieved in historical viewer also. No separate display settings available for Historical viewer.

8.9.2 Events/Alarm List

It is to view list of Events/Alarms

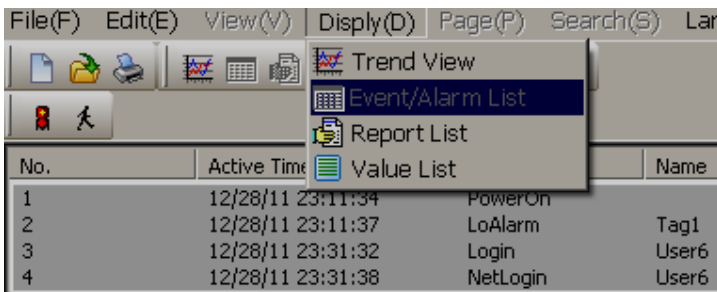

8.9.3 Reserved

8.9.4 Value List

It is to view data in tabular column

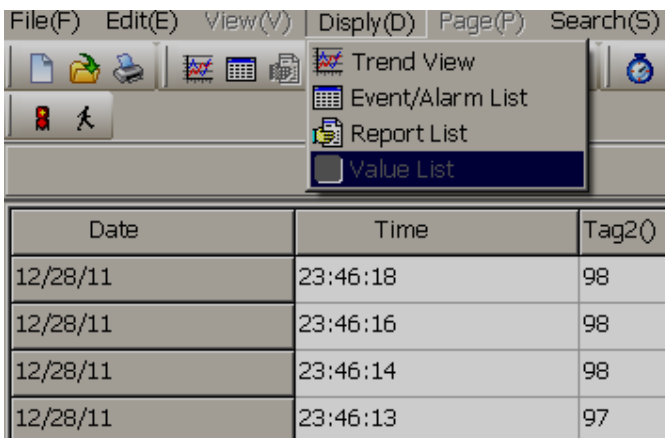

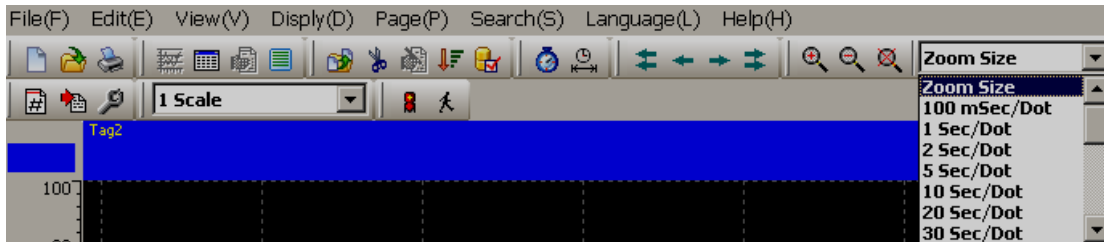

Various Zoom rates are available for selection

100 msec/dot, 1 sec/dot, 2 sec/dot, 5 sec/dot, 10 sec/dot, 20 sec/dot, 30 sec/dot, 1 min/dot, 2 min/dot, 5 min/dot, 10 min/dot, 30 min/dot, 10 min/page, 30 min/page, 1 hr/page, 2 hr/page, 4 hr/page, 8 hr/page, day/page, week/page and month/page



Search by specific time

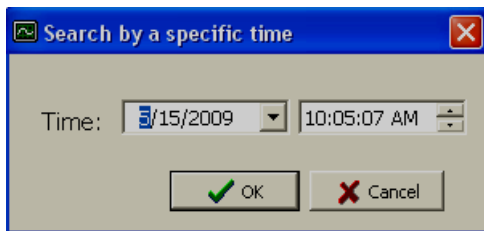

Search by a period of time

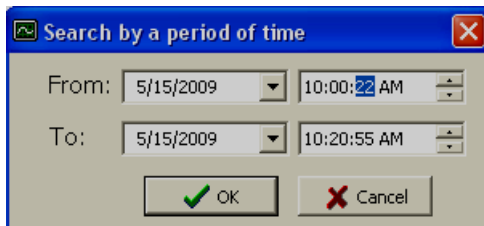

These are for navigation of pointer in tabular column fast backward, backward, forward and fast forward.

8.10 Page Selection



In Menu, click on “Page” and then select the required page.

Number of pages available for display depends on configuration of display pages in Real time.

Maximum 200 display pages are available and maximum 24 pens (channels) can be configured in each page.

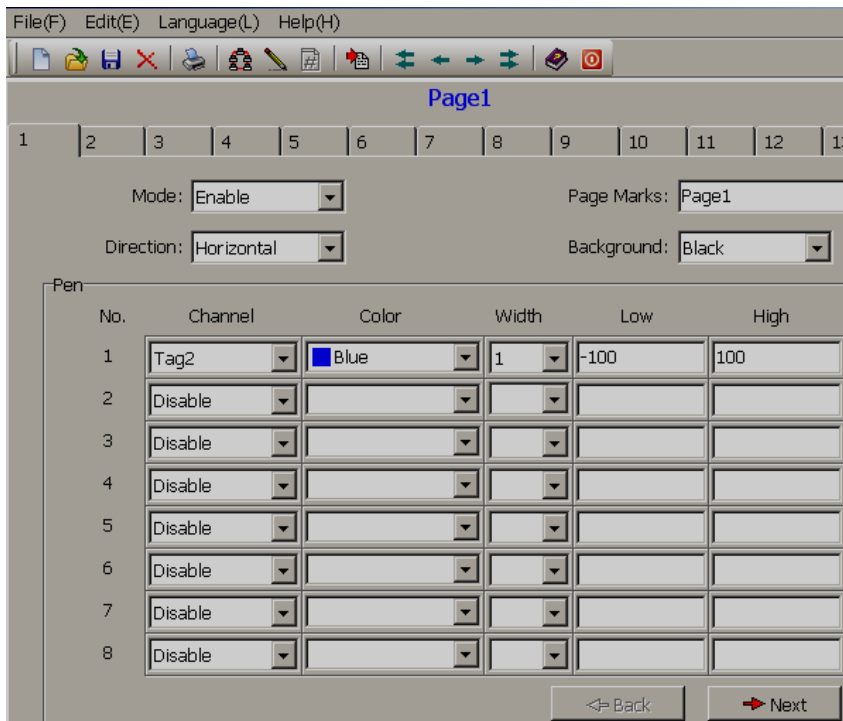

Fig: Display pages configuration in Real time.

Note: In Mode, if “Disable” is selected, then page will be not visible in either Real time viewer or Historical viewer.

8.11 Search

It is to search data and then take print out of trend if required.

Data can be searched with following criteria.

- By Time
- By Period of Time
- Seek by Tag Name
- Seek by Event/Alarm
- Seek by Remark

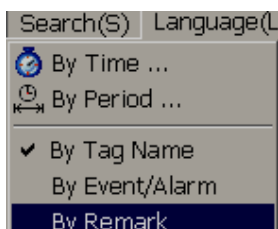

8.11.1 By Time

It is to search data by specifying exact date and time

Click on  icon for search by specific time, alternatively, in Menu, click on “Search” and then Select “By Time”.

Enter the required date and time of the data to be searched and click on “OK”, then pointer in trend will go to specified date/time.





8.11.2 Period of Time

It is to search data specifying time interval

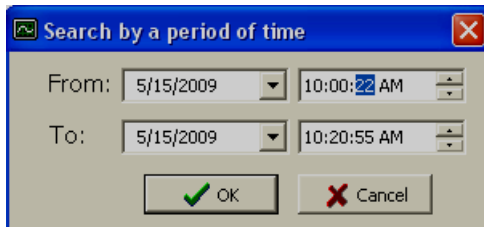
Click on  icon to search data by a period of time, alternatively, click on “Menu”, then select “By period”.



Enter Start date, end date, start time and end time for the data to be searched and click on “OK”, then it displays trend in specified range. To take print, click on Print icon  to open Print viewer and then click on  for printing the trend

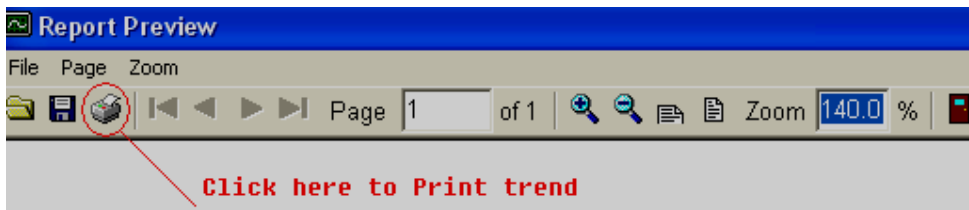



8.11.3 By Tag Name

It is to select specific trend for display. For example: You have configured 8 tags in page no.1, to check tag1 clearly, you wish to see only trend1. Then, select this option and select the required tag.



Click on “Seek by TagName”, and then select the required Tag to display in trend. If it requires viewing display scale, click on “Trend scale list” and select the required tag.

8.11.4 By Alarm/Event

It is to view and point to data based on selected event.

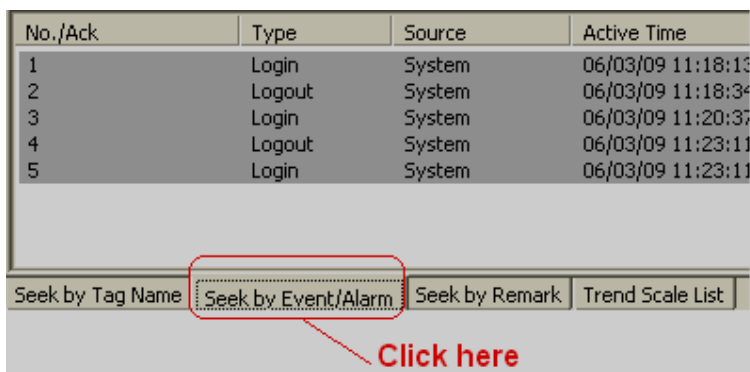

No./Ack	Type	Source	Active Time	Clear Time	Value/
1	Login	System	06/03/09 11:18:13		
2	Logout	System	06/03/09 11:18:34		
3	Login	System	06/03/09 11:20:37		
4	Logout	System	06/03/09 11:23:11		
5	Login	System	06/03/09 11:23:11		
6 <input type="checkbox"/>	HiAlarm	Tag1	06/03/09 11:28:18	Terminated	783.2
7 <input type="checkbox"/>	HiHiAlarm	Tag1	06/03/09 11:28:23	Terminated	863.0

Double click !!

Seek by Tag Name Seek by Event/Alarm **Seek by Remark** Trend Scale List

Select the required event/Alarm, then double click on it. Then, pointer in the trend will move to specific time at which event/Alarm is triggered.

8.11.5 By Remark

It is to view and point to data based on selected Remark.

No.	Remark Time	Page	Content
1	06/03/09 11:25:23	Page1	OK

Double click !!

Seek by Tag Name Seek by Event/Alarm **Seek by Remark** Trend Scale List

Click here

No.	Remark Time	Page	Content
1	05/15/09 10:36:28	Page	OK
2	05/15/09 10:41:06	Page	Irregular

Double click !!

All the list of Remarks will be shown in window at the bottom side of the screen as shown above. Select the Remark and double click. Then, pointer in trend will go to data where specific remark is marked earlier.

8.12 Print

It is to print Trends, Events/Alarms, Reports, Process Values etc.

First it requires to search the historical data as explained in earlier section and then click on Print icon, it open Print preview first and then click Print icon again to take print out.

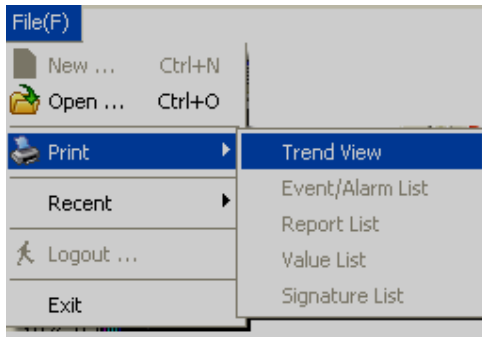

9. HMI Remote viewer



NEVER USE “HMI REMOTE VIEWER” FOR EMERGENCY APPLICATIONS OR CRITICAL PROCESS CONTROL APPLICATIONS

9.1 Overview

It's possible to control, monitor HMI from PC located at different location. Possible routing include Local area network (LAN), Virtual private network and Internet.

HMI Remote viewer show operator panel image in PC monitor. Images from HMI are regularly updated as per sampling rate configured between 1 and 120 sec. HMI Remote viewer function offers same functionality as HMI including full monitoring and control

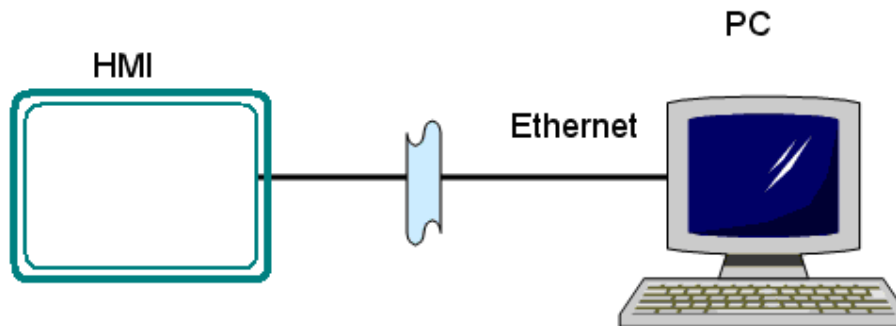

9.2 System Requirements

1. Microsoft operating systems Windows XP, Windows7, Windows Vista and Windows 2000
2. More than 10% of free memory in hard disk size
3. Computers installed with latest security updates, antivirus software etc.
4. 1 GB free RAM size

9.3 Limitations

Some of tags show differently between HMI and HMI Remote viewer. Some shows independently and known list is given below

- a) HMI Remote viewer/HMI different: It means, tag values display independently
- b) HMI Remote viewer/HMI different (Write only): It means, tag values display independently at first, and once tag value is modified at HMI Remote viewer, it will write value to HMI, do not effect HMI Remote viewer itself)
- c) HMI reference: It is Read only from HMI.
- d) HMI Remote viewer Read and Write: It is like Global. It means, tag value is same in both HMI and Remote viewer. If you modify tag at HMI, it will modify at HMI Remote viewer and Vice versa

Number	Tag Name	Details
1	CurrentPage	HMI Remote Viewer/HMI different (Write only)
2	CurrentUser	HMI Remote Viewer/HMI different
3	CurrentSecurityLevel	HMI Remote Viewer/HMI different
4	TriggerPer100ms	HMI reference (Read only from HMI)
5	TriggerPer1sec	HMI reference (Read only from HMI)
6	MemoryFull	HMI reference. (Read only from HMI). Check HMI memory is full or not
7	MemoryAvailablePresent	HMI reference (Read only from HMI)
8	NumberOfRealtimeAlarm	HMI Remote Viewer/HMI different
9	NumberOfHistoricalAlarm	HMI Remote Viewer/HMI different
10	ScreenSaverTime	HMI Remote viewer Read and Write
11	BeeperEnable	HMI Remote viewer Read and Write
12	BeepVolume	HMI Remote viewer Read and Write
13	Backlight	HMI Remote viewer Read and Write
14	RTC_Day	HMI Remote Viewer/HMI different
15	RTC_Month	HMI Remote Viewer/HMI different
16	RTC_Year	HMI Remote Viewer/HMI different
17	RTC_Hour	HMI Remote Viewer/HMI different
18	RTC_Min	HMI Remote Viewer/HMI different
19	RTC_Sec	HMI Remote Viewer/HMI different
20	RTC_DayofWeek	HMI Remote Viewer/HMI different
21	IsDataLogging	HMI reference (Read only from HMI)
22	SystemDI_1	HMI reference (Read only from HMI)
23	SystemDI_2	HMI reference (Read only from HMI)
24	SystemDI_3	HMI reference (Read only from HMI)
25	SystemDO_1	HMI Remote viewer Read and Write
26	SystemDO_2	HMI Remote viewer Read and Write
27	SystemDO_3	HMI Remote viewer Read and Write
28	LanguageIndex	HMI Remote Viewer/HMI different (Write only)
29	InputTag	HMI Remote Viewer/HMI different
30	CurrentRecipeName	HMI Remote viewer Read and Write
31	CurrentRecipeDataRecord	HMI Remote viewer Read and Write



First time after opening your HMI Remote viewer session, we suggest to “Upload project” function manually to get latest HMI configuration and system tag values if any to avoid confusions.

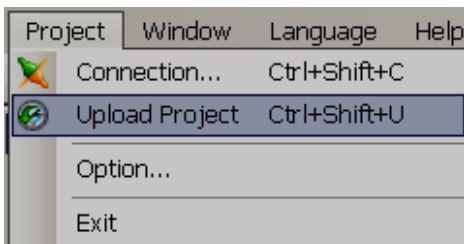

Other limitations

1. One HMI can be connected to maximum 3 nos. computers. There is no limitation to view number of HMI to view per HMI Remote viewer session and performance depends on PC resources and capabilities like CPU speed, free RAM size, free space in hard disk, network traffic etc. We suggest to use HMI Remote viewer to connect maximum 4 HMI
2. When operating on Internet, speed of internet connection also effect performance

3. Data encryption features are not available with HMI Remote viewer. It may be assumed to be safe to use HMI Remote viewer safely in Local area and Virtual private networks and may be not safe to use over internet.
4. Users are requested to take adequate precautions to include firewalls, updated antivirus software in computers, latest operating system security updates or associated safety configurations while using applications over internet
5. Some functions in HMI Remote viewer works in slightly different way. For example, if Real time trend and Historical trend is running in HMI, if you open the same trends via HMI Remote viewer, it will not show data from HMI, instead it will start showing as per current Real time data for current session in PC
6. The same case for alarms too. Historical alarms displayed in HMI may not exactly match with HMI Remote viewer, as later will show only for current session and unable to retain historical data from HMI itself.
7. If new users are added in HMI, then, it need to upload project again at HMI Remote viewer to get all user names and passwords, other wise, HMI Remote viewer will be showing as per earlier configuration data. The same case applied for Recipe data as well
8. If a system function do not use tag binding, then, it works independently at HMI and HMI Remote viewer. For example, acknowledge alarm function linked to a button do not use any tag binding. It is independent function. So, if you acknowledge alarm in HMI, it's only works with in HMI only, but not acknowledge alarm in HMI Remote viewer
9. System date and time object will show differently at HMI and HMI Remote viewer session. The same case applies to many other system tags which do not use tag binding, they display independently at HMI and HMI Remote viewer
10. Since it's possible to control HMI from multiple locations, it's not possible to display same screens at both HMI and computers. Also, it allows to log in via different user names and levels from multiple locations and no control available to log in by single user at any specific time
11. If you wish to set firewall setting for HMI Remote viewer, contact factory for the port number details

9.4 Installation

Make sure Microsoft.Net Framework 3.5 SP1 installed in PC

HMI Remote viewer software bundled in CD from HMI editing software V1.1 onwards. It can be selected during installation of HMI editing software or download latest version from website

 Microsoft Installer V3.1

 Microsoft .Net Framework 3.5 SP1

 HMI Editing Software

 OPC Server

 Demo Project

9.5 HMI Remote viewer session

1. First enter Password in HMI from Control Center.



2. Power ON HMI, press “Instrument”, then press “Advanced”, enter Password. Remember this password carefully
3. Make sure HMI application is running, HMI connected to PC via Ethernet.
4. Assume, IP address of HMI is 192.168.0.228
5. Use Ping instruction from PC to check if HMI is connected to PC or not. If there is no response, please check your Ethernet cable or Virtual private network or internet connection. If HMI is connected to Internet, then, make sure, you obtained Fix IP address (Global IP) from your internet solution provide and enter the same first in HMI from Control center.



```
C:\ Command Prompt
Microsoft Windows XP [Version 5.1.2600]
(C) Copyright 1985-2001 Microsoft Corp.

E:\Documents and Settings\Mahidhar>Ping 192.168.0.228

Pinging 192.168.0.228 with 32 bytes of data:

Reply from 192.168.0.228: bytes=32 time<1ms TTL=128
Reply from 192.168.0.228: bytes=32 time<1ms TTL=128
Reply from 192.168.0.228: bytes=32 time<1ms TTL=128
Reply from 192.168.0.228: bytes=32 time<1ms TTL=128

Ping statistics for 192.168.0.228:
    Packets: Sent = 4, Received = 4, Lost = 0 (0% loss),
    Approximate round trip times in milli-seconds:
        Minimum = 0ms, Maximum = 0ms, Average = 0ms
```

6. Click icon  to open HMI Remote viewer. If HMI Remote viewer software installed in PC successfully, then, above will be created in desktop.
7. Enter IP address of HMI in space provided for this. Then, click , then, IP address will be moved to IP list. If more than one HMI is required, repeat this procedure such that all IP address should be available here

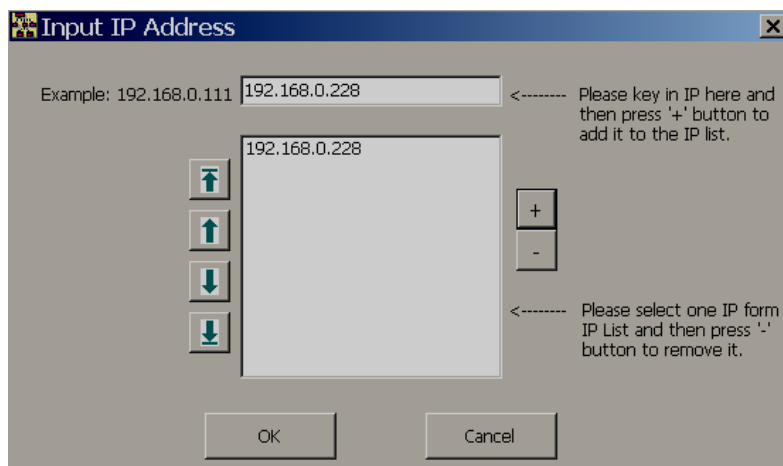
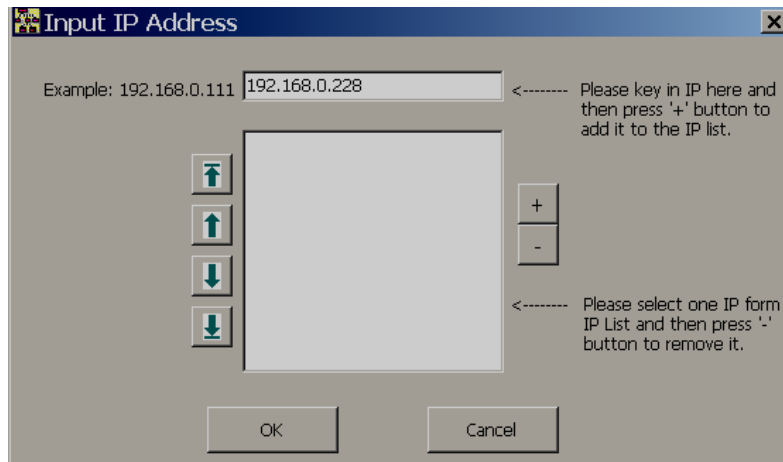

8. Press "OK", then, it will prompt to enter Password.



9. Now, you have to enter Password set at Control Center. If password match with password set at HMI Control center, HMI screen will be transferred to PC. Other wise, it will give message about incorrect password
10. For proper security, we suggest to utilize all the security features available in HMI editing software. You may reserve first screen in HMI for user log in as shown below.

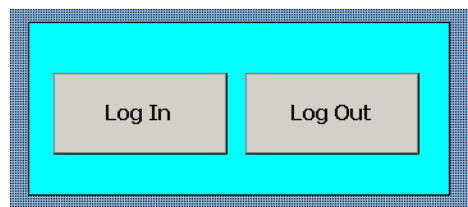

11. Once project configuration is received from HMI to PC, it will be stored in PC. If there are any changes like User security levels, Recipe etc.. in HMI, it will not update in HMI Remote viewer project automatically. In this case, you may upload the project again as shown below to effect new changes

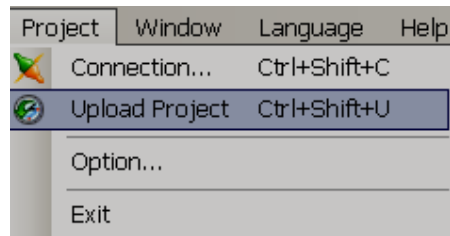

12. It's possible to set sampling time and time out as shown below.

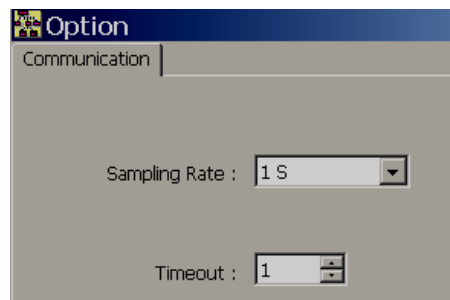
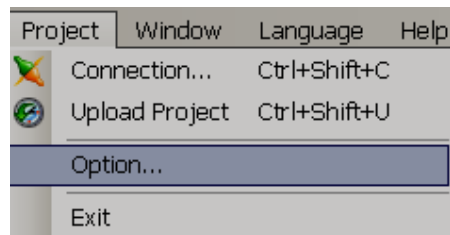

Once above settings are modified, it will be effective after you close the present HMI Remote session and open it again

9.6 View more than one HMI in one session

1. In Menu, click "Project", then, click "connection"

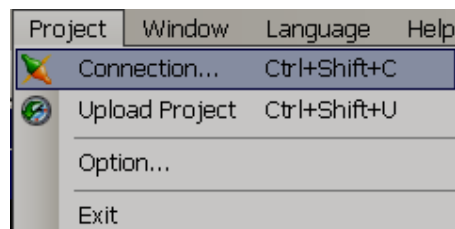

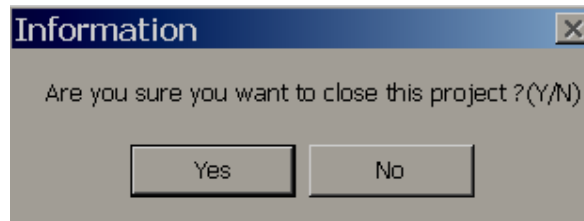

2. Click "Yes" to close current screen.

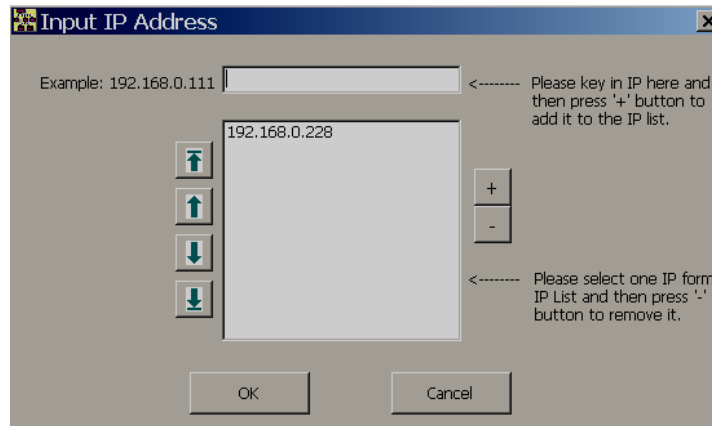

3. Enter IP address of second HMI and then click  to move to IP list

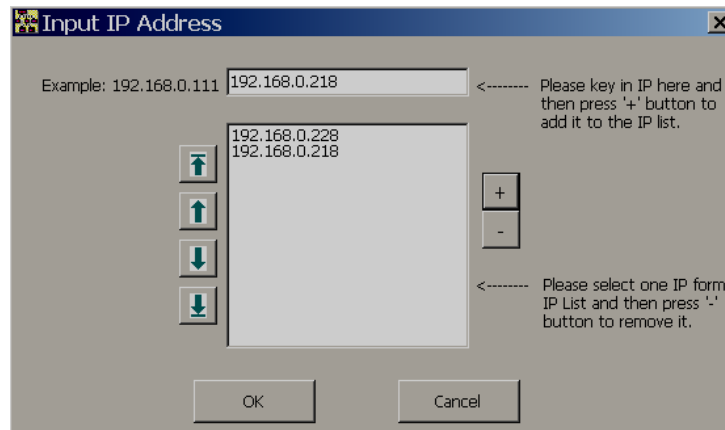

4. Press "OK" to get images from both HMI to single HMI Remote viewer session

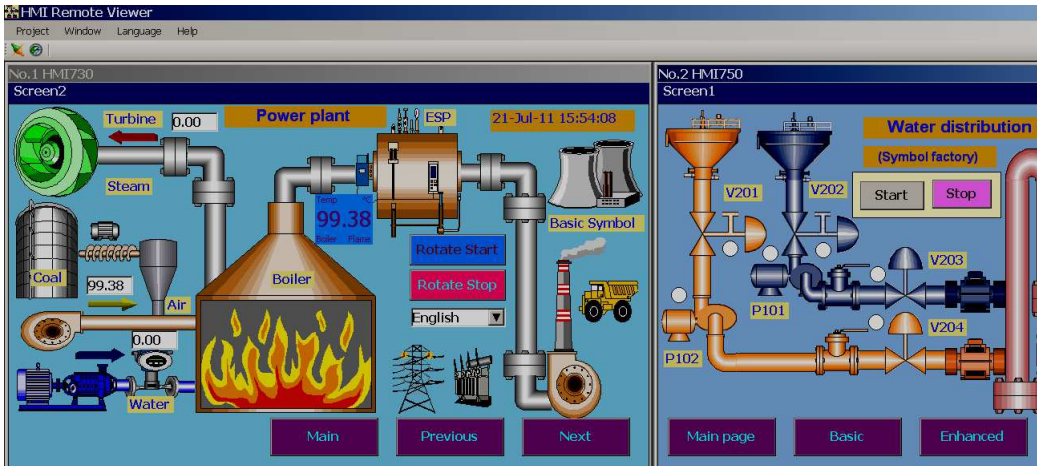

5. Depending on your PC monitor size and HMI screen size, it may not show all the HMI screens in your monitor properly. By default, horizontal mode is selected.
6. You may select “Vertical mode” as shown below then, HMI are shown vertically

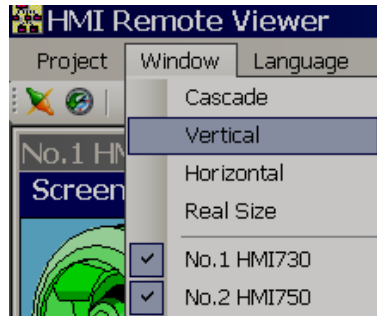

7. In cascade mode, vertical/horizontal scroll bar will appear and use can customize the size as per your requirements

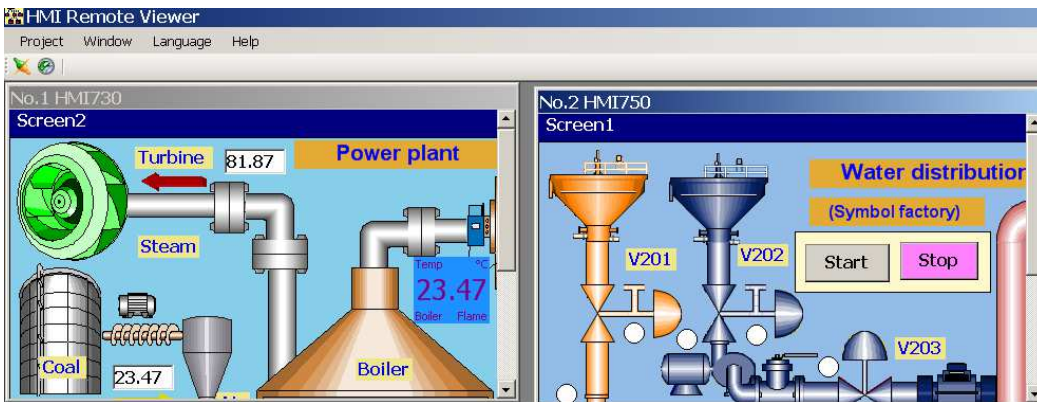

9.7 How to delete existing HMI project from HMI Remote viewer

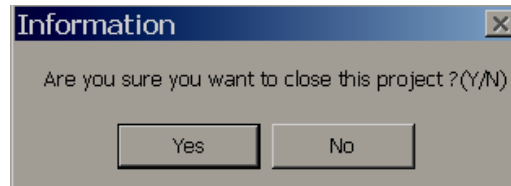
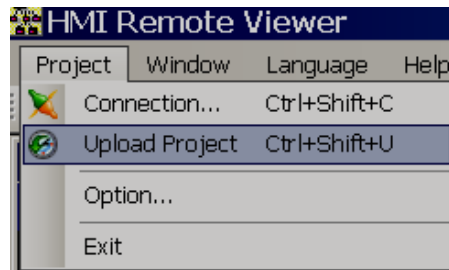

Click "Yes"

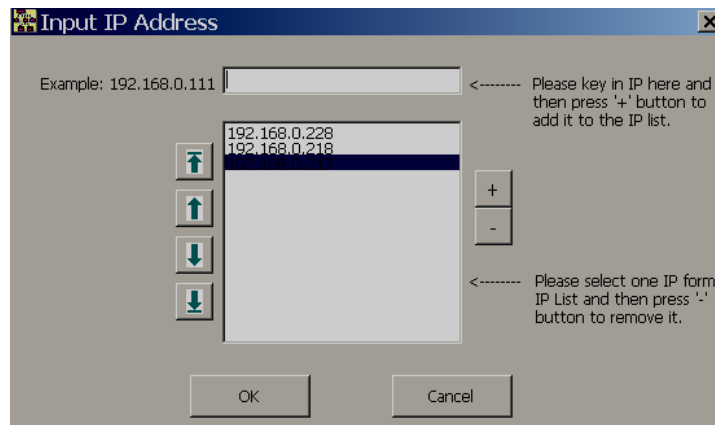

Select IP address of HMI to be removed, then click at soft button , then press soft button "OK".

If configured HMI is not available in network, it may show error message as shown attached

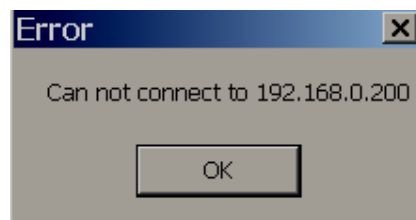

If HMI is disconnected when HMI Remote viewer session is running, it may show "Communication error" message in some objects like Text box etc.. no special alert messages are displayed in HMI Remote viewer

10. FAQ

1. Do you have any PLC drivers?

Yes, Many PLC drivers, Inverter drivers with various protocols over serial and Ethernet are supported. OPC server available to configure various PLC drivers

2. What is the difference between HMI Editing Software, HMI Editing Software plus, Data acquisition software Historical viewer & Remote viewer?

HMI Editing Software is basic HMI editing software with free basic symbols.

HMI Editing Software plus is basic HMI editing software + Symbol factory® which contains more than 4000 symbols.

Historical viewer is PC software tool to view historical data and historical alarms in PC. This is supplied along with both HMI Editing Software and HMI Editing Software plus at free of cost. Please refer chapter 8 in HMI user manual for more details

Remote viewer is to monitor and Control HMI from Remote location via LAN or Internet or Virtual Private Network. HMI should have Ethernet port for using with Remote viewer application. Please refer chapter 9 in HMI user manual for more details

3. Why do I have to pay for HMI Editing Software plus software?

It is towards license fees for using symbols from Symbol factory®. We will supply USB based hardware lock and it need to be inserted in PC during application development time to access more than 4000 symbol factory graphic library

4. How I can read PLC data in HMI?

Procedure

Configure OPC server for specific PLC driver

Add tags

Add objects like Bit lamp of word lamp into screen

Now, link objects with tags

5. How I can send a command from HMI to PLC?

Configure OPC server for specific PLC driver

Add tags

Insert button into screen

Configure events in the button

6. How I can do scaling for the Analog tag in HMI?

It is done during OPC server configuration after adding tag. If it's network option, then, you can do scaling conversion from Project explorer-Tag, then click Tab with name "Conversion"

7. We are system Integrator Company. We have 3 programmers. Do we need to buy 1 hardware lock or 3 hardware locks for HMI Editing plus software?

You need to buy three hardware locks if you wish to use HMI editing software simultaneously in three Personal computers. Hardware lock is USB based and you need to insert this in PC during application development to access more than 4000 symbol factory graphics library

8. Can I connect two different PLC's on the same Communication port?

Generally every PLC has proprietary protocols. In serial ports, it is not possible to keep two different PLC's on same RS422/RS485 network unless both of them support standard protocols like Modbus RTU.

However, in Ethernet, it is possible.

9. Is it possible to connect HMI with Profibus-Master?

Yes, it is possible. In this case, it is required to specify Profibus DP option for the networks while ordering the HMI or order Profibus DP spare later. A slot is available to fit various kinds of Field bus optional cards (Slave) like Profibus DP, DeviceNet, CANOpen, ProfiNet IO, Ethernet/IP etc. Please check with supplier for availability of these network option cards.

10. HMI will be Master or slave in Profibus network?

HMI is Profibus DP slave.

11. Can I configure HMI as Modbus RTU Master and Modbus RTU Slave?

HMI can be configured as Modbus Master via OPC server.
Earlier, Modbus RTU Slave is supported only from plug in option module
Now, Modbus RTU (COM1/COM2), Modbus TCP slave (Ethernet) drivers are supported from HMI editing software V1.1 onwards.

12. I want to transfer some data from PLC1 to PLC2, both PLC's are from different vendors with different protocols. Can I use HMI for gateway application?

Yes, it is possible. You may use a function "Copy TagB to TagA" in scheduler.

13. How quick I can scan a tag from PLC and display it in HMI?

Minimum time is 100 msec.. However, please define scan rate properly in tag data base and also make sure that optimum communication settings are selected at both HMI and PLC.

14. I need to run HMI application in different countries. Can I display different languages in HMI for end users?

Yes, it is possible.

15. Can I write scripts in HMI?

Yes, it is possible. You can write scripts in C language and call them via scheduler

16. Can I install HMI in outdoor?

No. HMI is intended to install indoors in suitable enclosure.

17. Do you have HMI with function buttons?

At present, all our HMI are touch screen only, function buttons are not available.

18. What is operating system in HMI? Can I install windows XP or Linux?

All our HMI are having WinCE operating system. No, it is not possible to install windows XP or Linux operating systems in our HMI

19. We are OEM Company. Can you supply WinCE hardware to us? Can I run my own applications in WinCE operating system?

Generally, you need to use our HMI editing software to develop your applications. If you want to use your own HMI editing software or only WinCE HMI for OEM application in high volumes, then contact the factory/supplier for more details.

20. I want to write a Math formula, how I can do this in HMI?

Create internal memory tags, use Scripts, it has different functions available for Math functions.

21. I completed project in 10" HMI. Now, I have another similar project with 10" size. Can I use some of screens from earlier projects in new project?

It is possible to open multiple sessions of HMI software. So, open both the projects simultaneously in PC, then, copy and Paste the screen elements between projects.

22. Do you have template in HMI software? If so, how many templates are available?

Any screen can be configured as a template (Except screen 1) and then link this with other normal pages. If you edit a template, it will be reflected in all other screens dynamically. It is possible to have more than 1 template screens in a project.

23. HMI editor software support Pop up screens?

Yes, it is possible. Please refer section 6.6.2 in HMI user manual for more details

24. I have developed project in 4" HMI and now, I want to use same program in HMI 7". Can I convert application from 4" to 7"

You may open HMI 4" project first. Then, apply Project save as and select HMI 7" size with correct resolution. You may give new project name for this. Please do remember, it will not change any object sizes from 4" to 7". Only extra space will be available in new project.

How ever, from V1.20 onwards, a new "Group panel" object added in Basic Objects. First group a screen in 4.3" size, then, in HMI 7", you can try to increase the size and check

25. I have some problems with Power supply. Can I change power supply card myself or I need to send HMI back to factory/Supplier?

It is possible to order power supply spare and it can be easily replaced by customer

26. Can you supply HMI to PLC cables?

Yes, it is possible, please refer HMI accessories catalog.

27. Can I store data in USB flash memory directly?

No, it is not possible. First it stores data in either directly in internal memory or SD card. Then, you can dump data from internal memory/SD card to USB stick.

28. How I can view historical data stored in USB or SD card in PC?

Install "Historical viewer", software from CD for this purpose.

29. I want to connect a printer to HMI. Is it possible?

Yes, it is possible from V1.2x onwards.

We support 2 kinds of Printers

USB Printer: Driver for PLC language 4, 5 & 6 is available.. Any printer supporting above languages should work and they can be directly connected to HMI. The main applications include printing historical data, alarms in several pages. Please refer printer user manual for exact protocol details

Line Printer: Driver supporting ESCP language is available. In this case, you need to connect printer to PC first and then connect HMI to PC via Ethernet. The main application of line printing is to print single line alarms/events

. Please refer section 6.10 for more details

30. What is the difference between online simulation and offline simulation

Offline simulation: It is to test HMI application in PC before downloading application to HMI, with out connecting PLC to PC. It is possible to enter some values for the tags via table to check the application.

Online simulation: It is to test HMI application in PC before downloading application to HMI, connecting PLC directly with PC. It works for 2 hrs only.

31. I want trigger an activity with respect to time at Real time clock. Is it possible?

Yes, it is possible. Use schedulers, set time and job.

32. Do you have RTC in HMI? How about battery?

Yes, RTC is available. Battery is rechargeable type and typical life time is 10 yrs.

33. Can I download HMI application via serial port?

No, it is not possible. Use Ethernet or USB flash disk for this purpose.

34. I want to update firmware in HMI. Is it possible?

Yes, it is possible. Please contact factory/supplier for latest firmware updates.

35. I want latest HMI editor software updates. Is they are free of cost? Where I can find them?

Generally updates are supplied free of charge. Please contact factory/supplier for latest software updates.

36. Can I use HMI in safety/emergency control application?

No

37. Can I connect Modbus RTU IO modules directly with HMI with out using any PLC?

Yes, it is possible for small applications. You can configure HMI as Modbus RTU Master and IO modules as slaves and then exchange data between HMI and IO modules. For complex logic and control tasks, it requires to use PLC.

38. Do you have some demo programs available?

During installation of HMI editing software, please select "Demo Projects". By default, these demo projects are available at following path
C:\Program Files\HMI Editing Software\Demo Project

39. How many screens I can have in any HMI?

It depends on memory left in your HMI project.

40. Is it possible to calibrate touch screen by user? When it requires to do calibration?

Yes, it is possible. Apply power supply to HMI and perform calibration from Control center screen. Normally calibration information is stored in non volatile memory. When user press a button and if boundaries are not correct and if it is not working properly, then, it may need to perform calibration once to store new settings into non volatile memory.

41. I lost my application backup. Can I upload application from HMI to PC back?

Yes, it is possible. After completing application development, it is safe to save editing software with exact version used for development along with Project source code in multiple locations as per your company back up policy to maintain and retain electronic files.

42. Do you have any tools to check communication between PC and PLC?

You may use OPC Server or OPC client for this purpose. Please check OPC server manuals for information about this.

43. Can I use more than 1 network option card in HMI?

No, it is not possible. Only one slot is available to insert network option card.

44. I am getting error message in HMI as follows

Memory used almost full. Alarm and data log stop work. Please dump or clear alarm and data log

If internal memory is less than 5% in HMI, then, you will get the above error message. You may dump or clear historical data manually or plan to execute dump/clear functions from the scheduler periodically to have enough internal memory available to use

45. What is the difference between HMI 7" (LOW COST) and HMI 7" (HIGH PERFORMANCE)?

HMI 7" (HIGH PERFORMANCE): CPU 1Ghz, 256MB RAM, SD slot, standard Ethernet, many Networks, IP65 aluminum front bezel, optional stainless steel IP66K front bezel, optional sound I/O&O/P+3DI+3DO

HMI 7" (LOW COST): CPU 667Mhz, 256MB RAM, Optional SD slot, optional Ethernet, no Networks, IP65 plastic front bezel, no sound I/O&O/P, no 3DI+3DO

46. Do you have any limits for number of tags, objects, pictures etc..?

From HMI editing software V1.1 onwards, there are no limits and now it depends on free memory. It is suggested to maintain free memory greater than 30 MB after downloading application. From Control center, check free flash memory (ROM) after pressing "System information". To know RAM, run application from Control center, it shows free memory and total RAM during loading bar for a while

47. Can I connect one HMI Remote viewer session to 4 HMI?

Yes, it is possible. However, performance depends on PC. Please refer chapter 9 in HMI user manual for more details

48. Can I display one HMI in three different PC?

Yes, it is possible. Please refer chapter 9 in HMI user manual for more details.

49. How many HMI Remote viewer sessions are possible for one HMI?

Maximum 3 HMI Remote viewer sessions are possible for single HMI. Please refer chapter 9 in HMI user manual for more details

50. How about security features?

It's assumed to be safe to use HMI Remote viewer in Local area network and there might be security related issues when using with Virtual private network/Internet. So, design the system with appropriate external distributed firewalls, make sure PC running HMI Remote viewer has latest security updates, antivirus software with latest updates to mitigate risk

51. Is it possible to enter password in HMI and then enter this password in HMI Remote viewer to establish a session?

Yes, it is possible. Please enter password in HMI at control center. At Control center, press "Instrument", then "Advanced", now enter "Password"

52. What are port numbers that are required to enter at firewall settings to allow HMI Remote viewer session?

Contact factory/supplier for further information

53. How I can connect HMI to internet?

You need to get fix IP address from your internet solution provider. This IP address will be unique in global network. Then, you can use HMI Remote viewer in any PC connected to Internet to monitor and control HMI.

54. What is the best advice to reduce risk when using HMI Remote viewer applications via internet?

Enter password at Control Center. We suggest using all the security features available in HMI editing software. There are 9 security levels available to

configure and link every button with appropriate security level and then assign users with appropriate security levels to reduce risk. Make sure first screen in HMI application dedicated for user log in with assigned security levels.

55. Can I have access for full control of HMI from HMI Remote viewer?

Yes, it is possible

56. Can I use HMI Remote viewer session for monitoring only with out any control?

In this case, we suggest using all security features in HMI editing software and make sure every button in HMI application will have security level of minimum 2. Then, for monitoring purpose, create users with security level 1

57. Besides of those drivers you have, can you develop a new driver for our devices? any condition ?

The answer is yes. To develop a specific driver, we need protocol information, the device itself for testing, and reasonable quantity.

59. Is Ethernet a standard for all models?

No, it is standard for high-end HMI 7" (HIGH PERFORMANCE), 1050 & 1550, but an option for low-cost HMI 4.3" & 730.

60. Do you supply faceplate in any other color than green?

Besides standard green faceplate, we do supply silver grey as well.

61. Do you supply neutral faceplate to OEM?

Yes, we do supply neutral faceplate without logo and product name.

62. Can you do private label on both faceplate and HMI software?

Yes, based on reasonable quantity we can do private label on both. Within software it has a tool called Customization, which allows the user to change logo, software name and company name.

63. How do you compare your HMI with other competitors'?

We position our HMI with 1st tier European & American spec. and features but at competitive prices. Please refer details from comparative charts supplied.

64. How can I quickly get an impression on your editing software?

You may download the editing software from CD or our website. Besides, you may also download its self-training program with voice, which will teach you the operation step by step.

65. Even it is expensive, my customers are happy with HMI they have. How can we switch their HMI to yours?

Show them better specifications, features on hardware, software on comparative charts, and competitive price. If they have reasonable quantity, suggest your FAE to do the application program for them, and finally offer them a free sample with the program for testing.

66. What is the difference between Ethernet and EtherNet/IP?

Ethernet/IP is Allen Bradley's Ethernet protocol. Ethernet is just hardware port.

67. Can Ethernet or other Networks be added on later?

For HMI 4.3", 730, Ethernet can't be added on later because it is not done by a module. It needs to be specified before production. As for other Networks, they can be added on later because they are done by modules.

68. To replace expensive Siemens MPI adapter, can you offer something?

Simply to order the option of Profibus-DP, it can save the cost. It can be added on later because it is a module.

Another way is to use existing Siemens Ethernet OPC Server on Ethernet port. You just need to make sure to select Siemens PLC with Ethernet port. In this case, no MPI adopter/ external module is necessary

69. What is the product warranty period of time?

It is two-year warranty after shipping.

70. Is it possible to run our own software instead of yours?

Yes, it is easy to run 3rd party software because HMI is built on WinCE V6.0

71. Can your HMI run InduSoft SCADA software?

Yes, with WinCE V6.0 Pro, they can run InduSoft Web Studio smoothly.

72. Do you offer other color housings besides standard silver grey?

For large OEM in big quantity, we do offer dark grey housings too.

73. To save expensive Mitsubishi communication module, can you offer something?

Our HMI can directly communicate with the CPU ports of Mitsubishi Q02, Q02H and Q00UJ to save the expensive communication module.

74. Can HMI support barcode reader?

HMI can support barcode reader via USB port.

75. How do your HMI communicate with various temperature controllers in the market?

Our HMI can communicate with the most of temperature controllers via Modbus RTU & TCP/IP because many of them support it.

76. What's reason to choose WinCE as HMI operation system?

Because it is mature and stable system with many ready-made tools, which can save the development time for our own software, and it is easy to implement 3rd party software too.

77. What's sound input and output for?

Sound input can work with microphone, for example to leave a message to the next shift worker in factory. Sound output works with speaker, for example to play the alarm warning.

78. Can we easily replace Siemens HMI by yours?

Yes, it is easy because of same dimensions, cutouts, Symbol Factory, options of stainless steel front bezels.

79. How do you compare your HMI software with others?

It was developed by taking advantages of Siemens' and AB's software. So, it is quite powerful and handy. Please refer details on comparative charts.

80. Does your software support multilingual?

Yes, HMI Editing Software does support multilingual in two ways. To display multilingual on HMI, specific languages can be keyed in via keyboard. To read the software itself, the user can also choose any one of 18 available languages.

81. Can your HMI be used for data acquisition purpose?

Our HMI supports data acquisition function. The user can read real-time and historical data and trend on HMI. Also, it is possible to search and export data to Excel format.

82. My application needs three COM ports, but your HMI only got two. Any solution?

By using USB port of HMI and a specific USB to COM converter US-101-485 supplied by us, the user may get the 3rd COM port.

83. Can two HMI exchange data each other? How to do it?

Yes, it can be done. Set one HMI as Modbus RTU Master and another as Modbus RTU Slave, then it is done.

84. If I use COM2 port for RS-485 communication, how many devices can be connected in maximum?

It depends on Transceivers and Protocol used. In case if low power Transceivers are used, it is possible to communicate with max. of 247 devices on Modbus protocol. In case of high power Transceivers are used, it can drive till 32 devices.

85. I wish to connect keyboard and mouse to HMI. You have only one USB host. What to do?

You can use commercially off the shelf USB hub available in market and then connect your devices to hub.