

SCREEN CREATOR 5
User's Manual
Vol. 6

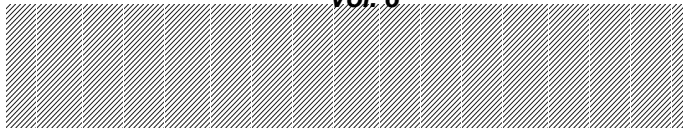

SCREEN CREATOR 5

K-Basic

Program Description

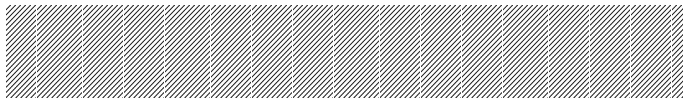

KOMATSU

Electronic System & Component Dept.
Electronics Div.

Contents

CHAPTER 1 INTRODUCTION 1-1

1-1	What is an Operation Program?	1-2
1-2	Objects to be Described in Operation Programs.....	1-3
1-2-1	Operation programs for parts.....	1-3
1-2-2	Operation programs for screens	1-3
1-3	Terms	1-4
1-3-1	Screens	1-4
1-3-2	Figures (backgrounds).....	1-4
1-3-3	Parts	1-5
1-3-4	Controls	1-5
1-3-5	Messages	1-6

CHAPTER 2 EXAMPLES OF PROGRAMMING..... 2-1

2-1	Creating a Part for Displaying Numerics	2-2
2-1-1	Arranging controls.....	2-4
2-1-2	Coding a program	2-6
2-1-3	Drawing a figure in a part.....	2-7
2-1-4	Saving a created part.....	2-8
2-1-5	Using a created part	2-9
2-1-6	Explanation for coded program content	2-12
2-1-7	Modifying a created part	2-15
2-2	Creating a Part to be Linked to a PLC Device	2-20
2-2-1	Numerical displays	2-20
2-2-2	Indicator lamps	2-24
2-2-3	Switches	2-26
2-2-4	Indicator switches	2-28
2-3	Creating a Part to be Linked to an External Device	2-30
2-3-1	Display for host computer	2-30

2-4	Creating a Part for Controlling Others	2-32
2-4-1	Part for calling others from touch panel.....	2-32
2-4-2	Part for sending/receiving numerics to/from others	2-34
2-5	Creating a Part for Using a Timer.....	2-38
2-5-1	Part for counting up.....	2-38
2-6	Editing a Program for a Displayed Part	2-42

CHAPTER 3 CODING RULES..... 3-1

3-1	Usable Characters.....	3-2
3-2	Special Characters	3-3
3-3	Constants	3-4
3-4	Constant Declaration	3-5
3-5	Variables	3-6
3-5-1	Classification of variables.....	3-6
3-5-2	Types of Variables.....	3-7
3-5-3	Checking variable types and variable interpretation in compilation.....	3-8
3-5-4	Initializing variables	3-9
3-6	Expressions and Operations	3-10
3-7	Type Conversion	3-13
3-8	Labels.....	3-14
3-9	Subroutines	3-15
3-10	User-defined Functions.....	3-16
3-10-1	Definition of user-defined functions	3-16
3-10-2	Definition positions of user-defined functions and ranges of referencing.....	3-17
3-10-3	How to call user-defined functions.....	3-17
3-10-4	Variable declaration in user-defined functions and referencing external variables	3-17

3-11 Program Operation 3-18

3-12 Message Format..... 3-20

3-13 Program Blocks 3-22

3-14 Devices and Communication 3-24

3-15 Memory Tables 3-25

 3-15-1 Describing memory table 3-25

 3-15-2 Reading and writing One element..... 3-25

 3-15-3 Reading and writing two or more elements 3-25

3-16 File Systems3-26

 3-16-1 Precautions for file systems 3-26

 3-16-2 Specifying a file..... 3-27

3-17 Notes3-28

CHAPTER 4 INSTRUCTION REFERENCE 4-1

4-1 Instruction Reference..... 4-2

4-2 Indexes by Functions 4-5

How This Manual Is Organized

This manual, Chapter 1 through 4, includes structures of data to be displayed on the OIP and operations in detail for you to use the OIP.

Chapter 1 Fundamentals in Creating Screens

Outlines general ideas and organizations of data to be displayed on the OIP. You should read through this chapter before referencing the other chapters.

Chapter 2 Installation for Screen Creator 5

Covers the environment in operation and installation of Screen Creator 5.

Chapter 3 Basic Operations for Screen Creator 5

Describes each function name of Screen Creator 5 and operations for the keyboard and mouse.

Chapter 4 Menu Reference

Thoroughly discusses each menu of Screen Creator 5.

You are recommended to reference the following manuals for using Screen Creator 5.

Vol.1 Screen Creator 5 Manual Introduction

Introduces fundamental operations of Screen Creator 5.

Vol.2 Screen Creator 5 Manual Operations

Describes operations of Screen Creator 5 in details.

Vol. 3 Screen Creator 5 Manual PLC/External Equipment Connection

Covers the communications procedures with a host computer and connections to peripheral devices.

Vol. 4 Screen Creator 5 Manual Standard Component Catalog

You can get to know the standard components and their functions the maker. offers.

Vol. 5 Screen Creator 5 Manual Control Reference

Describes what are controls and how to use controls for creating components.

Vol. 6 Screen Creator 5 Manual K-Basic Programming

Offers information on how to write action programs for creating screens and how to use functions.

Vol. 7 Screen Creator 5 Manual Trouble Shooting and Error Codes

Covers restrictions on creating screens with Screen Creator 5, how to cope with trouble, and error codes.

Safety Precautions

Be sure to follow the safety precautions listed below in order to use the OIP safely. Koyo Ltd. cannot be held liable for any damages incurred if these safety precautions are not followed.



WARNING

- **Design your system so that there are sufficient countermeasures for personnel accidents and major equipment accidents. The system should have an external protection and safety circuit, so that even if the OIP should malfunction or even if there is a defect in the program the safety of the system is assured.**
- **Do not use the touch panel of the OIP to make switches that are related to safety or people or major damages (emergency safety switches, etc.). Be sure that the system is designed so that it can cope with any errors or malfunctions in the touch panel.**
- **Be sure that type 3 grounding is used for the protective-grounding terminal. There is a possibility of electrical shock if the unit is not grounded.**
- **If the OIP should malfunction, immediately turn off the poser and leave it alone.**
- **If there is direct output to external output device such as PLCs, direct output will be driven regardless of the ladder circuit interlock. Output may be used to drive motors and the like, so avoid using direct output because it is dangerous.**



CAUTION

- **Use and store the OIP in the environment described in the specifications (regarding vibration, shock, temperature, humidity, etc.).**
- **Do not use the OIP where it is subjected to inflammable or explosive gas, or steam.**
- **Before turning on the power, be sure that the power voltage rating of the OIP and the voltage rating power supply match. Using a mistaken power supply can damage the unit.**
- **Do not disassemble or modify the OIP. Doing so can cause malfunctions and lead to other problems.**
- **The OIP touch panel is made of glass. Striking it with hard objects or pressing hard on it may break the glass.**
- **Do not push down on the OIP touch panel with mechanical pencils, screwdrivers, or other sharp objects. Doing so can damage the touch panel or cause malfunctions.**

Notations Used In This Manual

This manual uses the following symbol marks for you to use this system comfortably.



WARNING

Describes a peril that may cause operator's death or serious injury in neglecting the WARNING item(s).



Caution

Describes a peril that may cause bodily injury or serious device damage in neglecting the CAUTION items(s).



Describes general note(s) in use.

Note)

Explanations and supplements.

Glossaries used in this manual are as follows.

OIP	Stands for Advanced Intelligent Panel.
PLC	Stands for programmable controller. It is also called a sequence controller.
Link unit	A link unit is a communication equipment which connects this equipment and the PLC. The nomenclature of the communication equipment is different from each manufacture and the equipment is called a link unit in general.
Device	A device is such equipment that an input/output relay, internal relay, timer, counter, or resister in the PLC.

Notice

We have used our best efforts in preparing this manual. We make no warranties with respect to the accuracy, or completeness of the contents of this manual and purpose. We shall not be liable any loss of profit or any other commercial damages, applying this manual directly and indirectly.

- 1) All rights reserved. No part of this book may be reproduced in any form or by any means, without permission in writing from Koyo Ltd.
- 2) Contents of this manual shall be subject to change without notice.
- 3) While every precaution has been taken in the preparation of this manual, if the reader notice any errors or has any advice on the contents of this manual, please contact our customer support in Sales Division of koyo Ltd.
- 4) We shall have no liability to any loss or damage caused or alleged to be caused directly or indirectly by the statements contained in this manual or by the computer software and hardware products described in it.
- 5) Koyo Ltd. may have patents or pending patent applications, copyrights, or other intellectual property rights covering subject matter in this manual. The furnishing of this manual does not give you any license to these patents or other intellectual property rights. And we do not have any responsibility on troubles involved in the patents and other intellectual rights caused by the use of this manual.
- 6) Contact us at the following place concerning other unclear points in this manual.

**Customer Support Group
Electronics System Division
Komatsu Ltd.**

Address: 4-20-1, Kamata, Ota-ku, Tokyo Japan

Telephone: 81-03-5711-1838

Facsimile: 81-03-5711-1840

E-MAIL: panel.el.@komatsu.co.jp

Version Up

Koyo Ltd. has upgraded Screen Creator 5 for adding new functions, operationability and so forth. Below will be introduced the updated functions.

1. Version 2.10

- Supporting middle size systems (GC53) of GC5x Series
- Adding the uploading editing function

To make this function effective, attach all screen data and K-Basic programs used in the project and download them to the panel. Then download the uploaded entities from the panel and restore them. Then you can edit the data and programs. Note that the data with the project attached increase their size.

- The following PLCs have been added.

Omron	SYSMAC α
Fuji Dencki	FLEX-PC NJ-T/NS-T
Fuji Dencki	Computer-link protocol
Fuji Dencki	Loader command protocol
Toyota Koki	PC1
Toyota Koki	PC3
Matsushita Electric Industry	Panadac 7000

- Standard components, centered on the parts used for middle size systems (GC53) in the GC5x Series have drastically been added.

CHAPTER 1

INTRODUCTION

1-1 What is an Operation Program?

You must code an operation program to display data such as numerical values and characters in a part or to make a switch operate when you press it on the touch panel.

A dedicated language K-Basic is used to code the specific operation of each part.

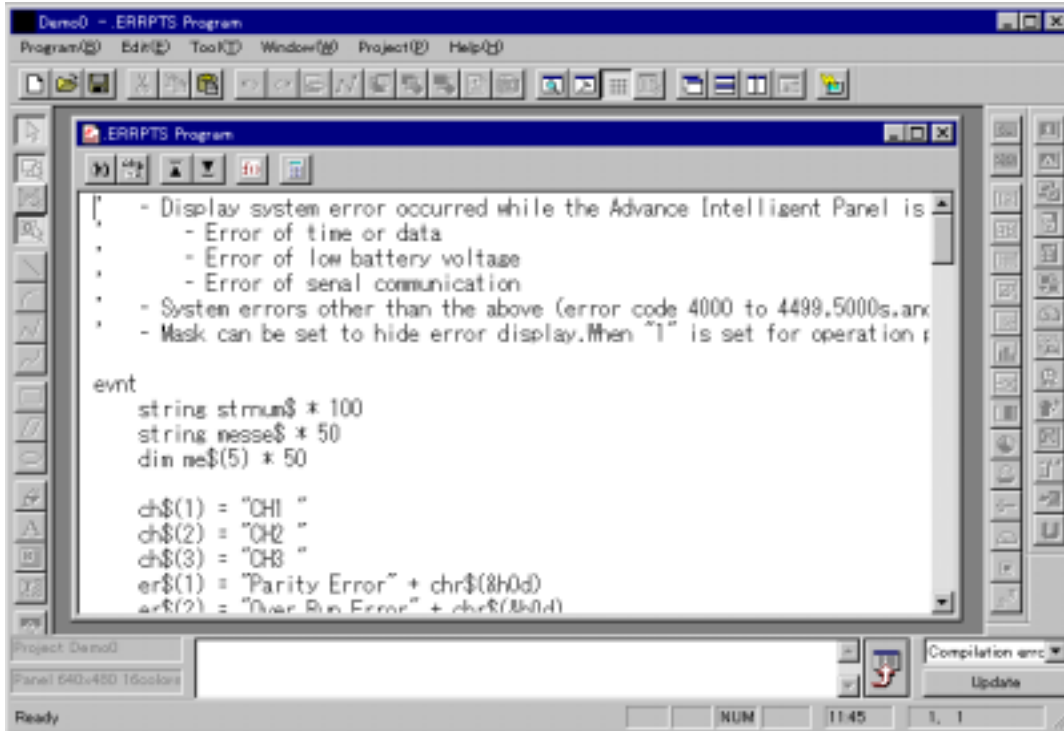

1-2 Objects to be Described in Operation Programs

1-2-1 Operation programs for parts

You can code an operation program individually for each part.

1-2-2 Operation programs for screens

You can also code an operation program for each screen just like for a part.

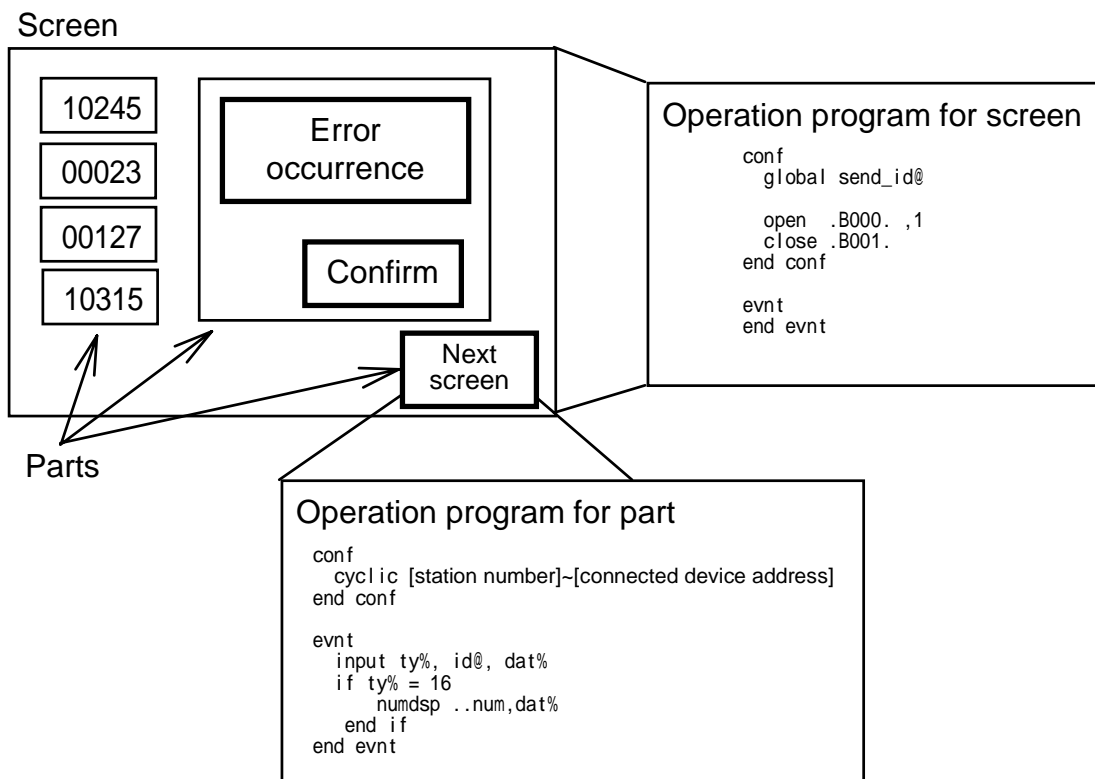

1-3 Terms

1-3-1 Screens

A screen consists of a figure (screen background) and some parts.

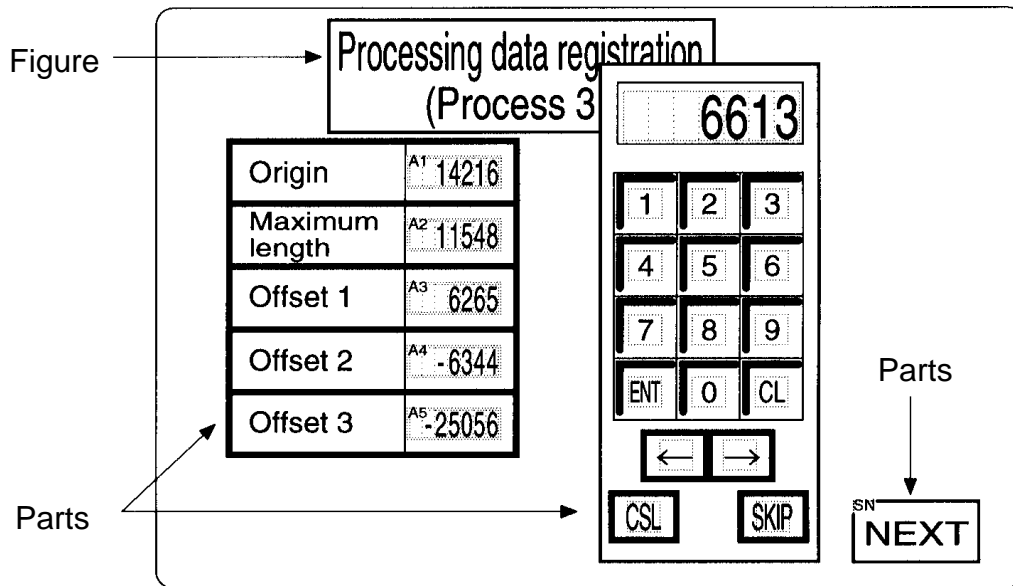

1-3-2 Figures (backgrounds)

You can draw a figure on a screen or a part by plotting elements such as lines, rectangles, circles, and characters.

1-3-3 Parts

A part is a combination of a figure (part background) and same controls such as displays and touch switches. The operation of such a part is coded as an operation program.

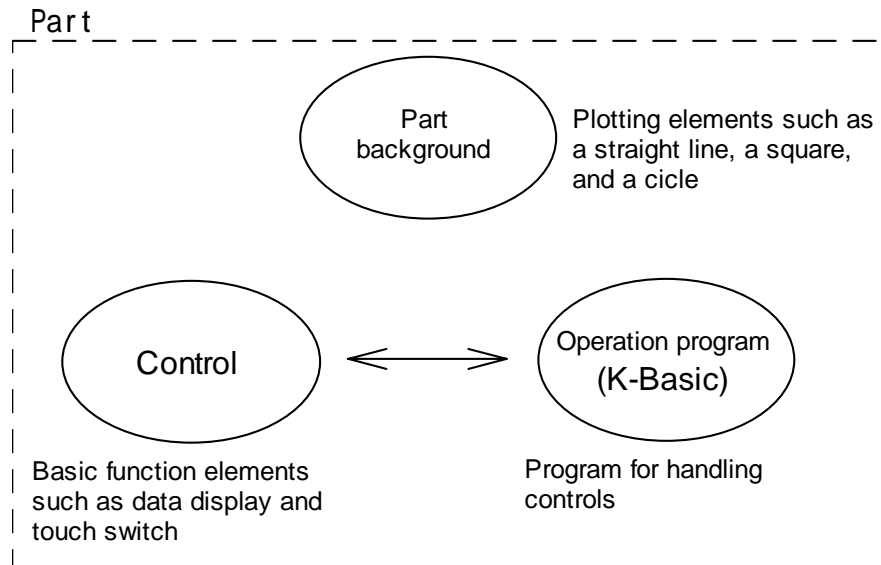

1-3-4 Controls

A control is used to display the value of a part or a meter value or to activate a switch. (The designation "primitive" has been used for GCSGP3, instead of control.) It is possible to overlay several controls on a single part.

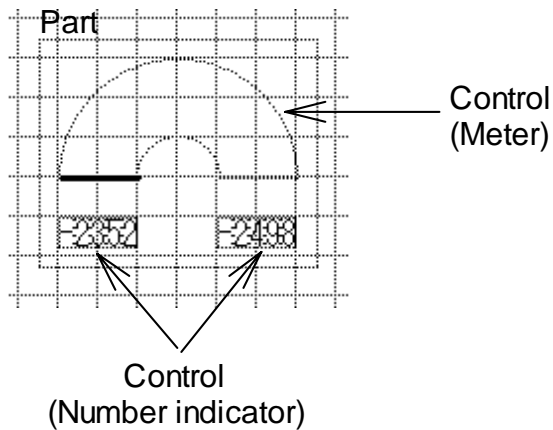

1-3-5 Messages

A message is a trigger for activating an operation program. A part starts its operation when it receives a message. Switches and external devices such as a PLC can issue messages.

Each message contains a sender ID (PLC device name, part name, etc.), data and so on.

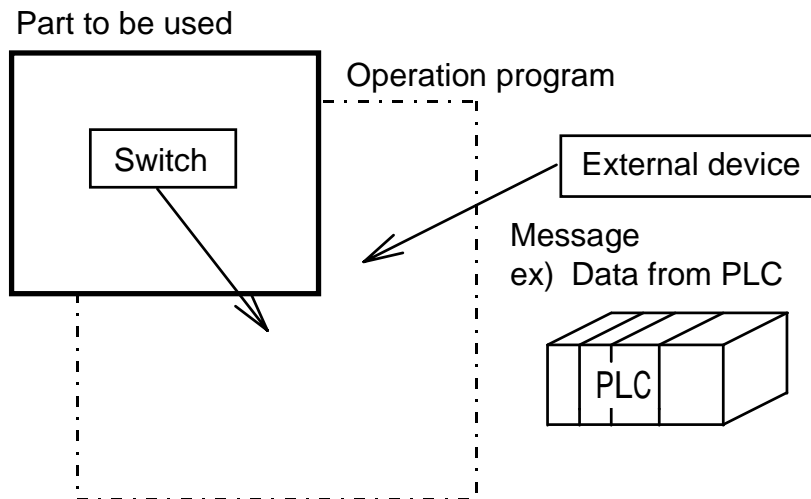

CHAPTER 2

EXAMPLES OF PROGRAMMING

2-1 Creating a Part for Displaying Numerics

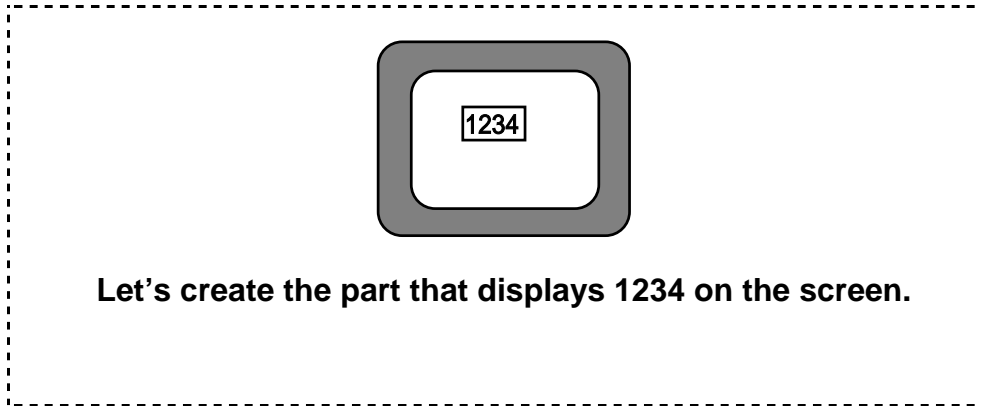

In this section, try to create a part which displays a numeric value on the OIP, for example. First, create a project on Screen Creator 5. To create a project, select "Project" on the Screen Creator 5 menu, then select "New".

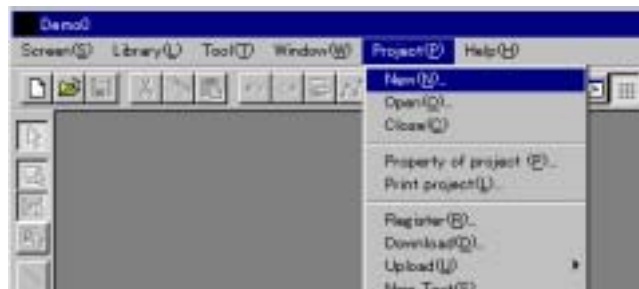

Now, the "Create new property of project" dialog box opens. Select "test" in the "Project Name" field and a model to be used in the "Panel" field, then press the OK button.

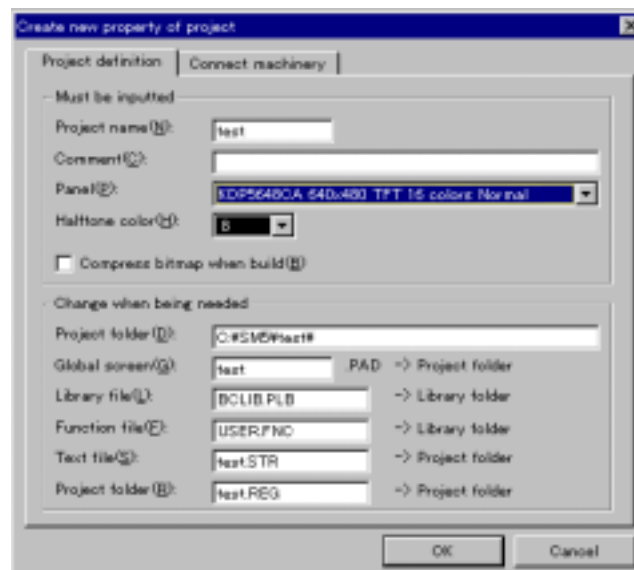

Then, select "Library" on the Screen Creator 5 menu. Select "New", then select "Part". Now, the part creation window opens.



Then, set the environmental conditions for creating a part. Select "Tool" on the Screen Creator 5 menu, then select "Option". The option setting dialog box opens. (Hereinafter, figures showing on-menu selection are not shown.)

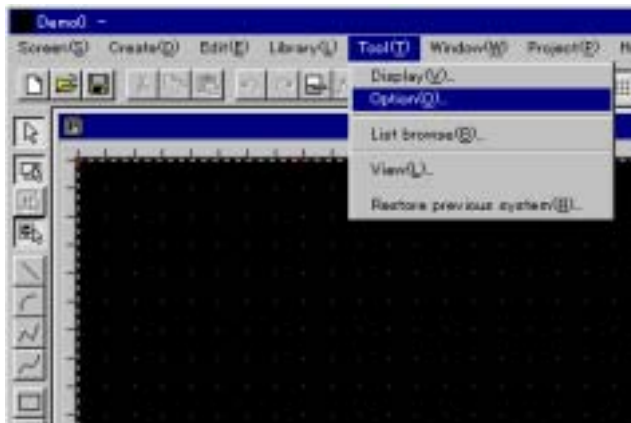

In this dialog box, check off the "Name automatically" check box and "Compile when saving screen" check box. Keep these boxes checked off.



2-1-1 Arranging controls

This section describes how to arrange a number indicator for displaying numeric values in the part creation window. In this example, use the number indicator control. For details of the controls, refer to the Control Reference Manual. To arrange the number indicator control, select "Create" on the menu, select "Control", then select "number indicator". The number indicator setting dialog box appears. Leave the default properties unchanged. Do not forget that the control name is "NUM000".

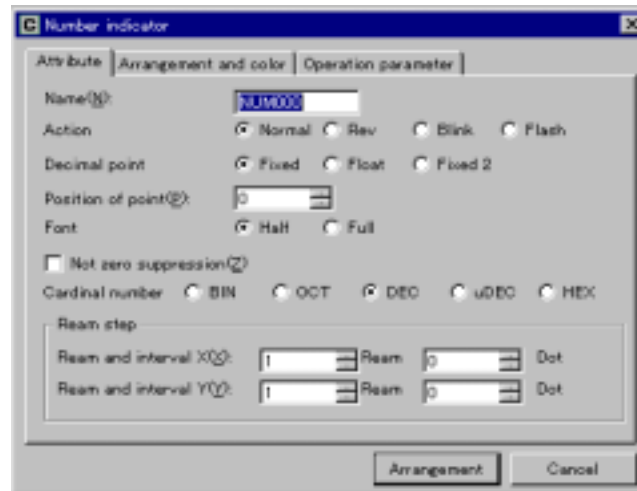

Then, click on the "Arrangement and color" tab in the dialog box as shown below. Try to change the number of digits of values displayed on the number indicator control. Change the value in the "Length and Interval" field into 4. Now, the number indicator control has been set. Press the Arrangement button.

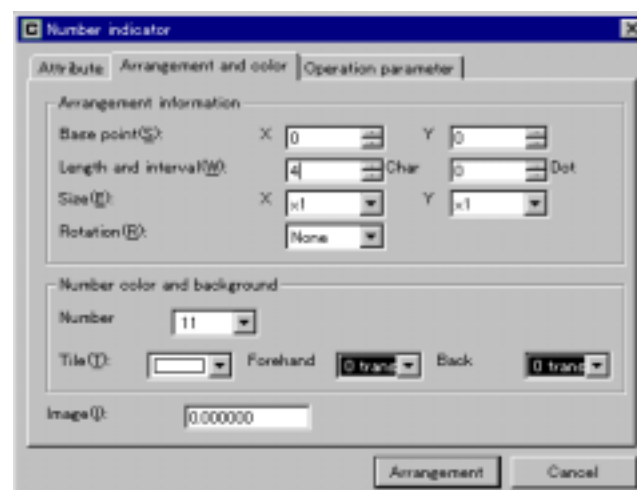

The dialog box is closed, and the mouse cursor changes into the mouse. In this condition, move the cursor to a window where the control is to be arranged (i.e., part creation window), and click the left mouse button. The mouse cursor changes into a rectangle frame, which shows the size of the number indicator control. Click the left mouse button at any position, and the number indicator control is arranged at that position.

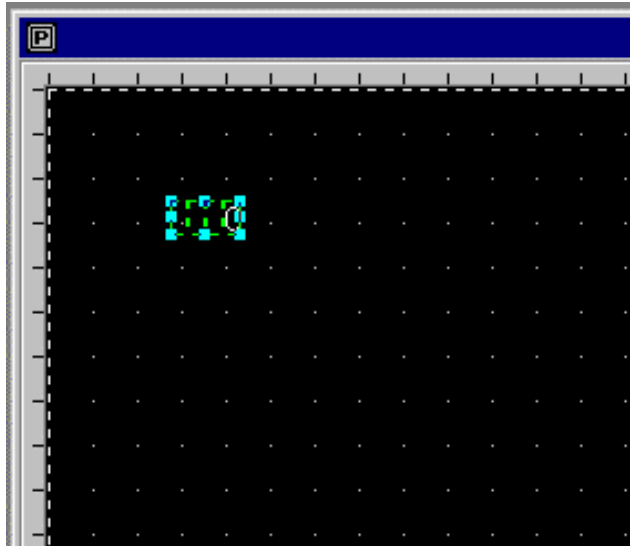

Then, try to change the size of this number indicator control. There are light blue squares on the frame of the control. These are called handles. When you bring the mouse pointer close to a handle, the pointer shape changes. In this condition, drag the handle, and you can change the control size as you like. In the example shown below, the control is enlarged four times as large as the original control size vertically and horizontally by dragging the lower right handle.

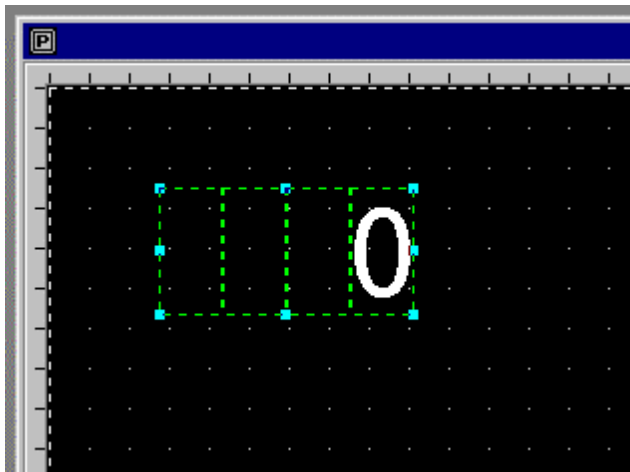

2-1-2 Coding a program

In this section, try to code a program for the part being created. Select "Edit" on the menu, then select "Edit Part Programs". The program editor window opens as shown below.

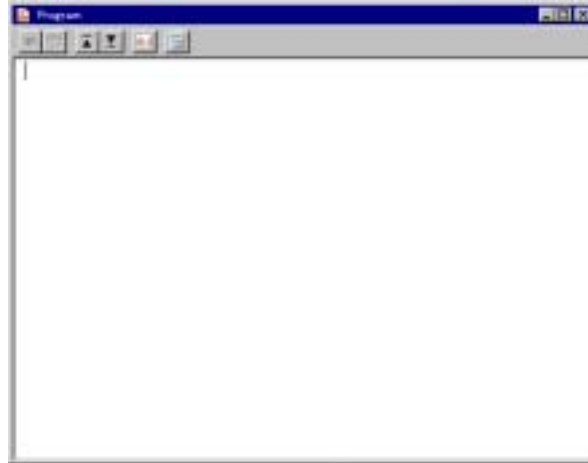

Type the following program on this screen.

```
init
  numdsp ..NUM000,1234
end init

conf
end conf

evnt
      end evnt
```

The program contents will be explained later. First of all, type the following program. The program editor screen will change as follows:

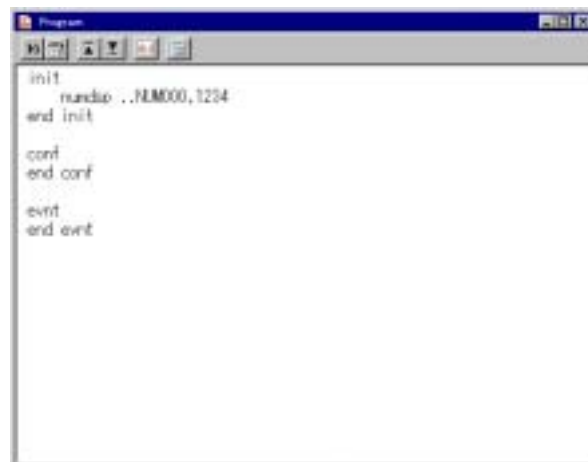

To save this program, select "Program" on the menu, then select "Save". Then, select "Program" on the menu and select "Close" in order to close the program editor window. Now, the program editor window is closed and the part editor window is re- displayed.

2-1-3 Drawing a figure in a part

Then, try to add a pattern to the part. In this example, enclose the number indicator control in a rectangle.

Select "Create" on the menu, select "Rectangle", and drag the rectangle along the diagonal line of the number indicator control. Now, the number indicator control is enclosed in a rectangle. The rectangular frame should be slightly larger than the control.

While drawing the rectangle, the dialog box for inputting the rectangle properties is open. It is possible to make changes in the rectangle shape, color, etc. in this dialog box. However, no properties are changed in this example.

Even after a rectangle has been drawn, the rectangle drawing mode is still active. To cancel this mode, click the right mouse button.

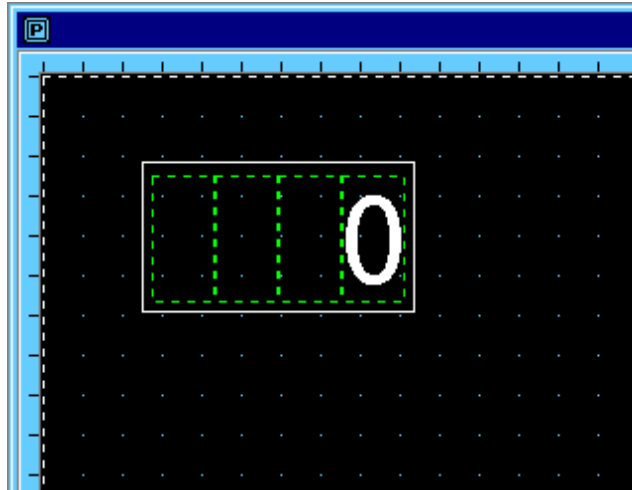

2-1-4 Saving a created part

Select "Window" on the menu, then select "Adjust to Object Size" in order to reduce the screen size to the current size of the part. The part must be displayed all over the OIP screen. Since such a part is too large, reduce the area to a size enough to accommodate the created numeral display enclosed in the rectangle. Look at the screen periphery, and you may see that the screen is enclosed in dotted lines. These dotted lines indicate the size of the part. Each side of the dotted rectangle has a red mark at the center. The red mark is a handle for changing the part area. Move the mouse pointer to one of the handles. The mouse pointer shape changes. Then, drag the handle to change the area size. The following shows an example of reducing the area.

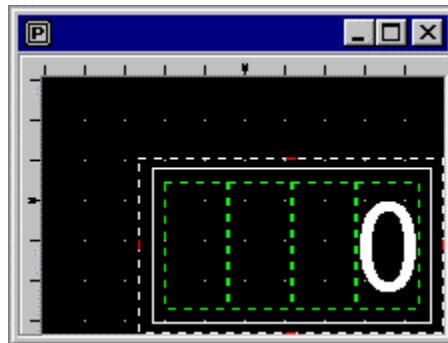

Then, save this part. Select "Library" on the menu, then select "Save". The dialog box shown below opens. The Class List field on the left shows the groups of the parts in the library. This example assumes that the part is saved in "User Parts". Thus, click on "User Parts". Input "test" in the "Name" field and "test part" in the "Comment" field. Click on the "Save" button to save the part. Then, select "Close" on the "Library" menu to close the part creation window.

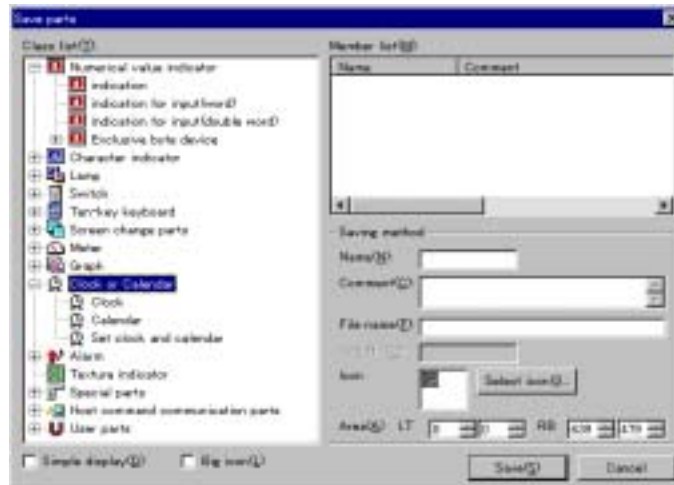

Now, part creation procedures are completed.

2-1-5 Using a created part

"New" to create a new screen. The screen creation window opens as shown below.

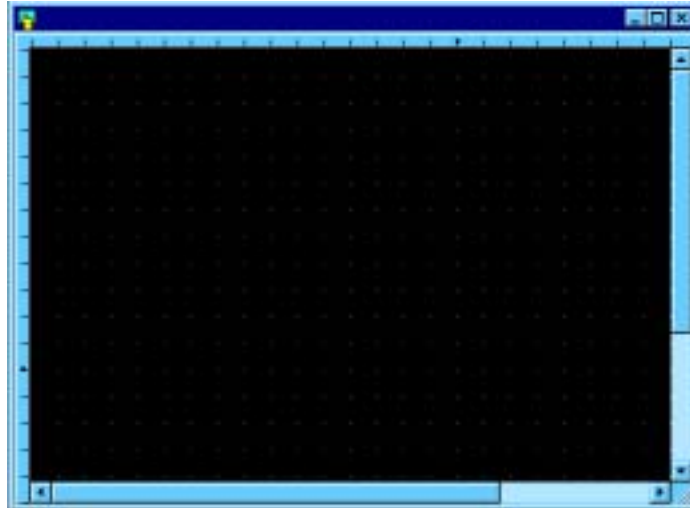

Arrange the part created above on this screen. Select "Create" on the menu, select "Parts", then select "User Parts". The part selection dialog box opens. Click on "test" created above.



The "Arranged Part Properties" dialog box opens. In this dialog box, only press the OK (Arrange) button without changing any items.

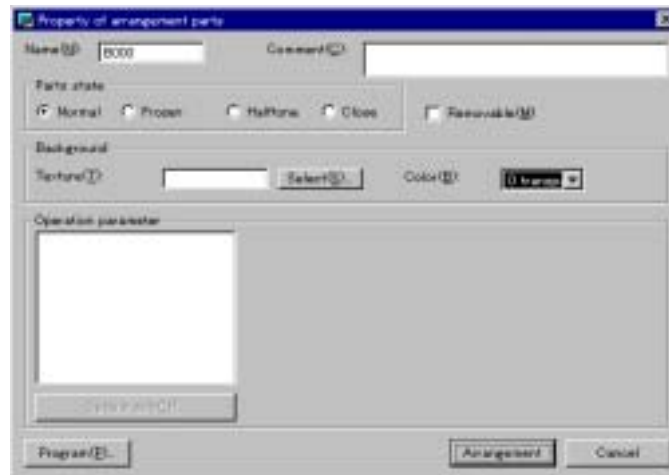

The dialog box closes, and the mouse cursor changes into the mouse. In this condition, move the cursor to a screen where the part should be arranged, then click the left mouse button. The mouse cursor changes into a rectangular frame, which shows the size of the part. Click the left mouse button at an intended position on the screen, and the part is arranged at that position on the screen as shown below.

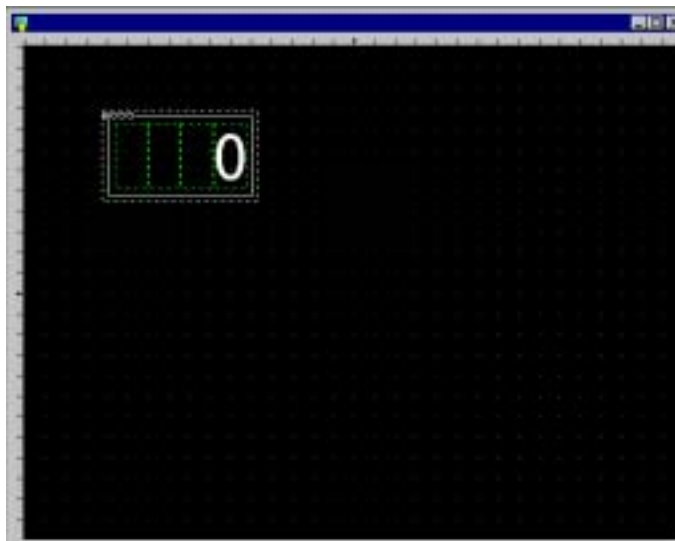

Then, save this screen. Select "Screen" on the menu, then select "Save". Input "gamen1" in the "Name" field, "test screen" in the "Comment" field, and "1" in the "Registration No." field in the "Save Screen" dialog box, then press the "Save" button. Now, the screen with the created part is saved.

Then, try to download this screen and display it. Connect the downloading cable between the OIP and the personal computer on which Screen Creator 5 is running, and bring the OIP into the download condition. Select "Project" on the menu, and select "Download". The download dialog box appears. Select "Build Transmit" in the download dialog box. When data to be downloaded is created and it is downloaded properly, bring the OIP into the user mode. A character string "1234" enclosed in a rectangular frame should be displayed on the OIP. If an error occurs while creating data, check carefully if the input program is correct. If an error occurs while downloading data, read carefully the description about downloading in the Operation Manual and check the serial port channel, baud rate, etc.

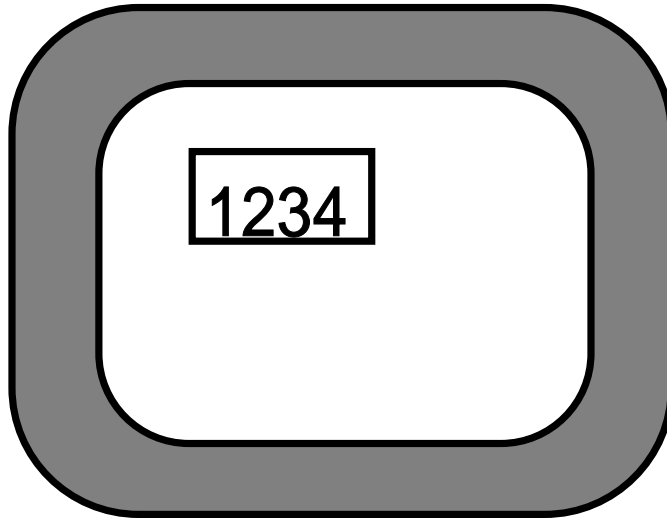

2-1-6 Explanation for coded program content

The following program was used.

```
init
    numdsp ..NUM000,1234
init init

conf
end conf

evnt
end evnt
```

The operation program for this part will be explained in detail below.

- (1) init-end init
This portion is called a Configuration Block, and is first executed in this program, which is generally used for declaring variable or initializing them,
- (2) numdsp ..NUM000,1234
The "numdsp" instruction displays a numerical value in a number indicator control. Write the name of the number indicator control for displaying data and the data to be displayed following the instruction. "..NUM000" shows the name of the control.

The following rules apply to this naming.

Control names and naming rules	
Screen:	GAMEN..
Part on GAMEN:	GAMEN.TEST.
Control in BUHIN on GAMEN:	GAMEN.TEST.NUM000
Current part on the current screen:	.. (Omitted)
Control in the current part on the current screen:	..NUM000

Note: Be sure to specify the names only with alphabetical and numerical characters.

Just like the part in this example, if a control is set in the same place as that of a programmed part, you can omit the screen name and the part name to specify the control.

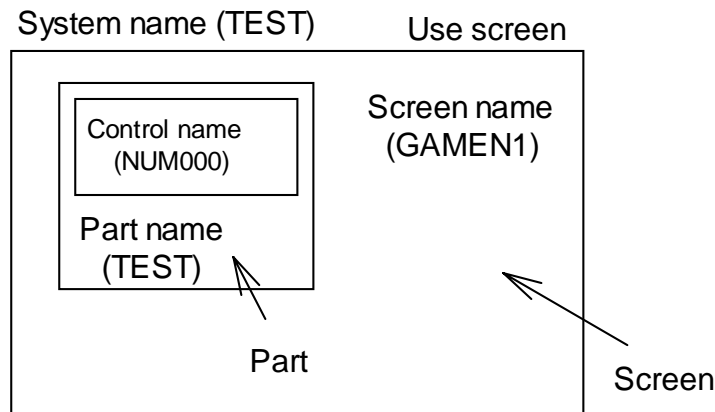

The program in part TEST is supposed to indicate control NUM000.

```
GAMEN.TEST .NUM000
or
..NUM000
```

The other parameter is the numerical value to be displayed. You can change the display value by changing this parameter.

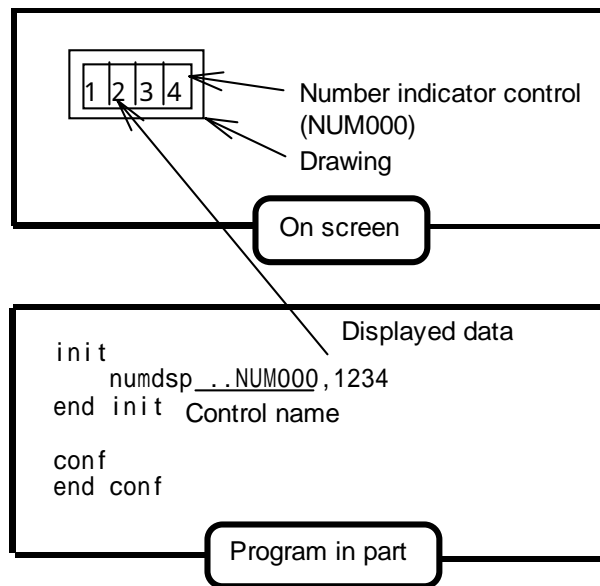

Correlation of this part

This sample program displays a character string "1234" on the number indicator control, which is the only control for the part.

(3) conf to end conf

This block is called a configuration block, which executes a program between "conf" and "end conf" only when a part is displayed on the screen (i.e., a part is opened or the screen is displayed or, to be accurate, immediately before the screen is displayed). The configuration block in this sample program causes no processing.

(4) evnt to end evnt

This portion is called Event Block. The program between these statements is executed only when a message is transmitted to this portion. In this example, no program is processed.

Note: A K-Basic program always requires the "conf", "end conf", "evnt", "end evnt" statements.

Messages arrive at a part from several devices and parts. For details, try to use the part actually in the following section and see what messages come.

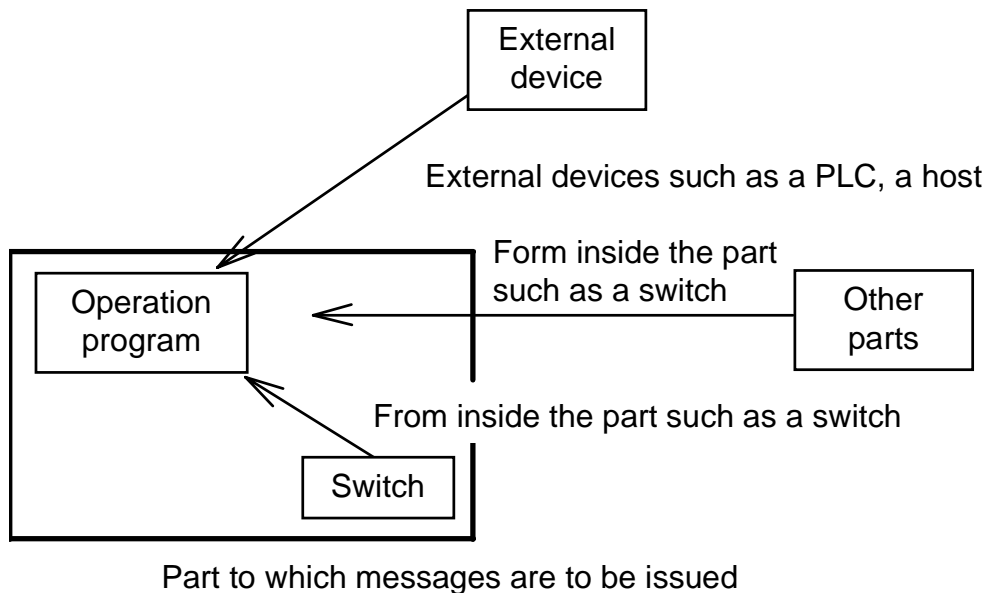

Message issuance

2-1-7 Modifying a created part

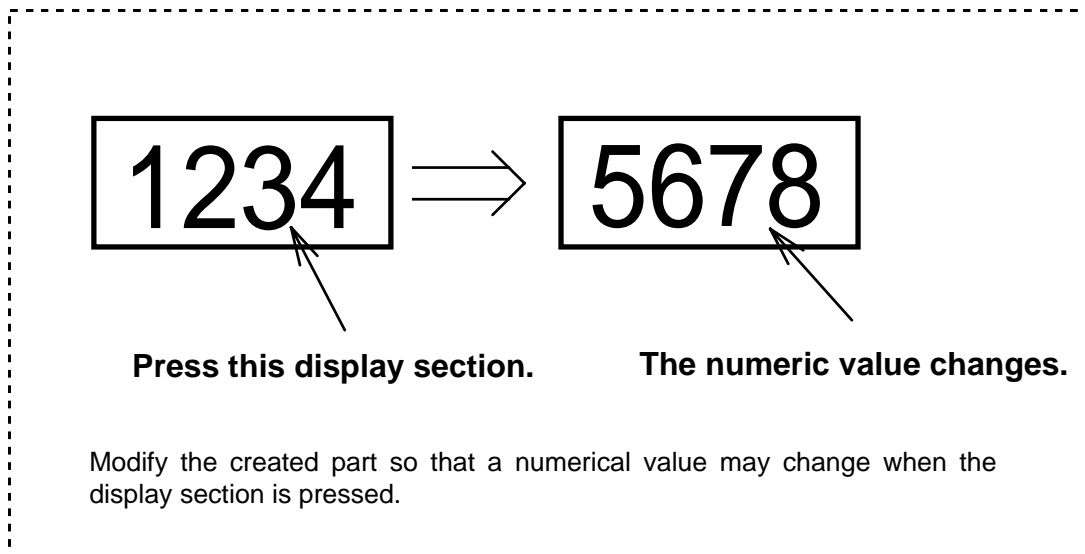

First, read "test" which has been created above. Select "Library", select "Open", then select "Parts". The "Open Parts" dialog box appears. Select "User Parts" and open "test".

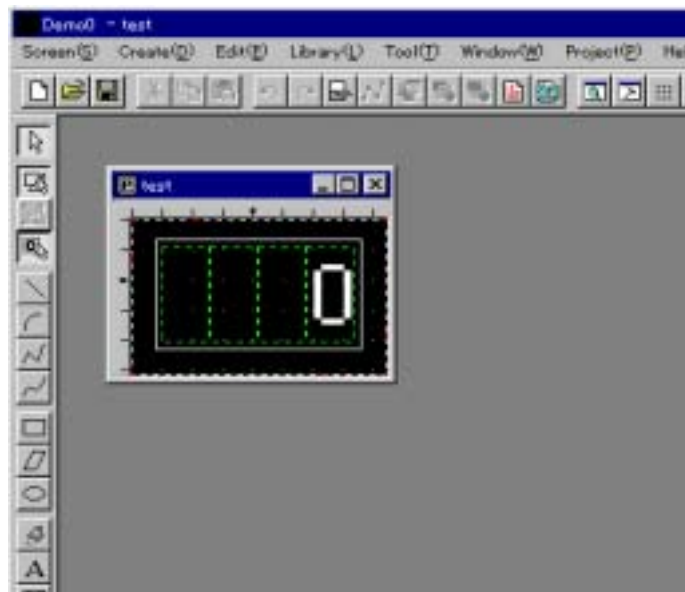

In this example, try to add a switch control to this part in order to use the touch panel. Select "Create" on the menu, select "Control", then select "Switch". The switch control setting dialog box is displayed. Press the OK (Arrange) button, since the default setting is not changed in this example. The mouse cursor changes into the mouse. Click on the part editor window of the part "test". The mouse cursor changes into a square switch control. Put this in the upper left of the part area. Since the switch control is a switch of the touch panel (20 dots x 20 dots), it moves in 20-dot steps.

Note: *This switch is a momentary switch. It is turned on when you press it and turned off when you release the finger.*

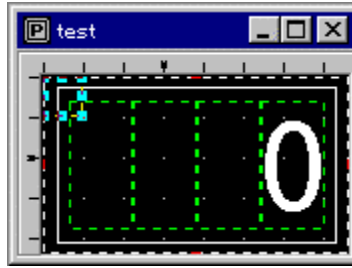

Then, try to change the size of the switch control. To change the size, drag a handle around the switch control with the mouse. Drag the lower right handle of the switch control, since the area should be expanded to the lower right. By the way, the part was created above without taking the switch size into consideration, and the size of the enlarged switch may not fit the size of the part. In such a case, drag the lower right of the part editor window to enlarge the window sufficiently. Then, enlarge the switch to a size enough to cover the part. Then, expand the part area identically to the switch size. As a result, the number indicator control shifts from the center of the part area. Select and move it to a proper position. In addition, drag the handle to enlarge the rectangular outer frame so that it shows the switch area. The part shown below is now created.

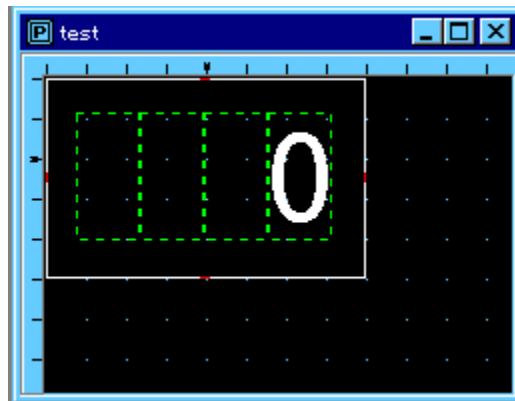

Then, select "Edit" on the menu, and select "Edit Part Programs" in order to edit the programs. The program editor window opens. Add programs to the initialization block and event block as shown below.



```

init
    local type%, id@, data%
    numdsp ..NUM000,1234
end init

conf
end conf

evnt
    input type%,id@,data%
    if type%=3 and id@=..SWT000 and data%=1 then
        numdsp ..NUM000,5678
    end if
end evnt

```

 Line to be added

 Line to be added

Try to explain where the program has modified.

The program added to the initialized block is a statement of declaring the variable used in the Event Block.

The “input” statement added in the Event Block enables to receive messages from the Switch control. You can know the message sender’s type, message sender’s ID, and data. If the condition is satisfied in the “if” and “end if” statements, the display of the Number indicator control changes.

First, the “input” instruction will be explained.

The “input” instruction can read various information from messages. The standard usage of the “input” instruction is given below.

```
input type%,id@,data%
```

In this example, the statement reads the type and ID of sender and data as explained below.

type%: The number indicating sender's type. For example, if the message is send by a switch, it is set to 3. If it is send by a PLC, it is set to 16. (For details, refer to 3-2, "Message format" reference.)

id@: The identification (ID) of sender. For example, if the message is send by a switch, it is set to the name of the switch. The ID is written in order of the screen name, the part name and the control name, delimiting each by a period(.).

Example: GAMEN.BUHIN.NUM000

This ID is called an ID-type constant; it is specific to K-Basic. You can also handle the ID as a variable by adding a "@" after the variable just like "id@".

Note: A message contains sender's type, ID and data in order.

data%: Data written by sender. For example, if the switch is ON, it is set to 1. If the switch is OFF, it is set to 0.

Next line is "if" and "end if" statements.

```
if type%=3 and id@=..SWT000 and data%=1 then
    : : : : : : : : : : : : : : : :
end if
```

Condition "type%=3" following "if" means a message from a Switch control. "id@=..SWT000" means the ID of the Switch control. "data%=1" means that the switch is ON. Inserting "and" between these three conditions enables the instruction of the next line executed if all the conditions are satisfied. If the "if" statement consists only of "type%=3 and id@=..SWT000", this condition is satisfied twice, when the switch is pressed and when it is released. In this example, the operation is restricted to be executed only when the switch is pressed after "data%=1" is added.

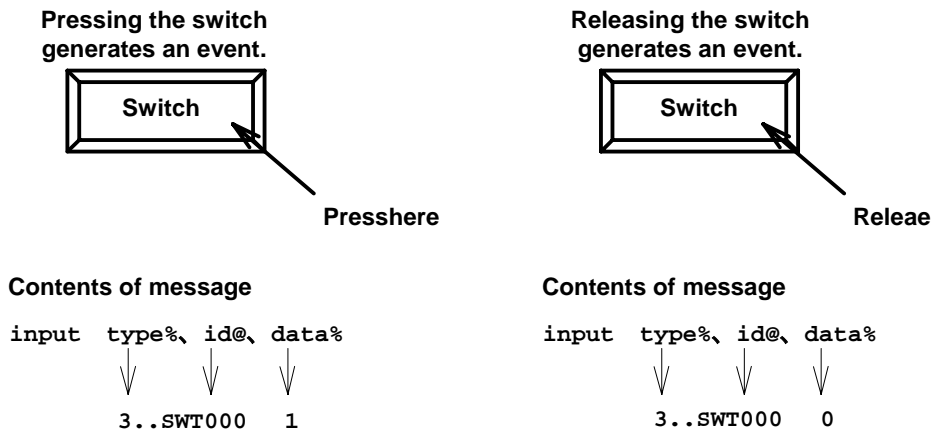

Note: If the switch type is set to "Momentary", it generates two messages "when it is pressed and when it is released".

These programs are so modified to execute the numdsp instruction and display "5678" on the number indicator control when the if statement is satisfied.

The part is almost completed now. Save the programs in the same manner as described in 2-1-2. Also save the part as described in 2-1-4. Though a warning message is given since the part "test" has already been registered, overwrite it to replace the old part with the new part. Now, use this part actually. Open "gamen1" created above again, and replace the old part with the new "test". To replace the old part, click on it, select "Edit" on the menu, then select "Delete". From now on, arrange the new part, create the screen data, and download it to the OIP in the same manner as described in 2-1-5. When the screen appears, "1234" must be displayed on the screen as previously. Press a point inside the frame, and you can see that "1234" changes into "5678".

In K-Basic, an "input" statement is used to receive messages and "if and "end if" statements used to judge various messages and execute operations.

For how to receive messages of other events, see the examples introduced in subsequent chapters.

2-2 Creating a Part to be Linked to a PLC Device

All the programs in this examples are for Mitsubishi PLCs. If you use a PLC of other maker, change the station number and device name of those programs and select the PLC type to be used in setting a connecting device setting.

2-2-1 Numeral displays

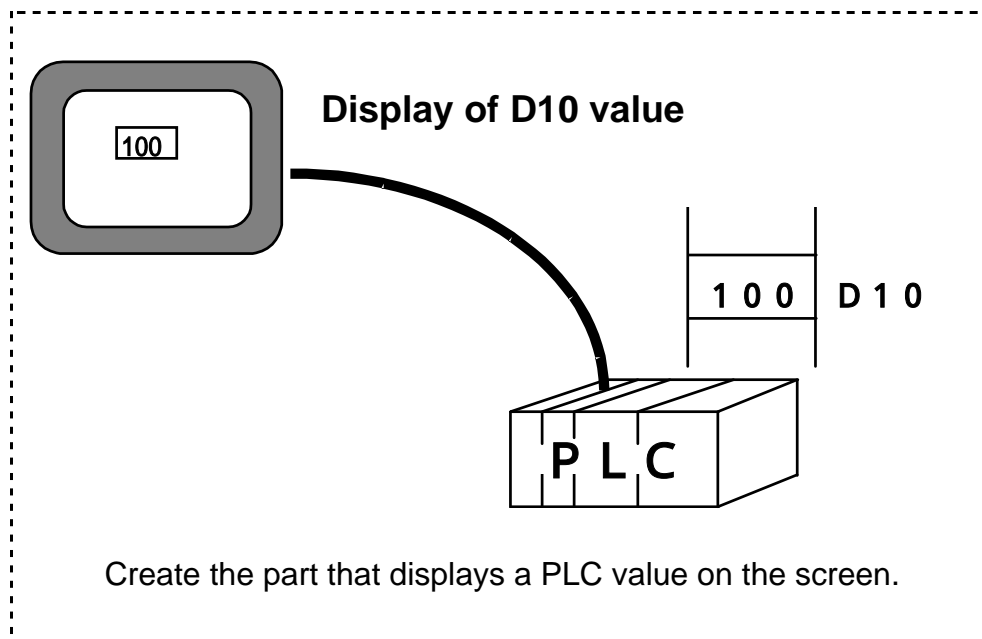

Control to use

One Number indicator control (NUM000)

Exterior view of the part

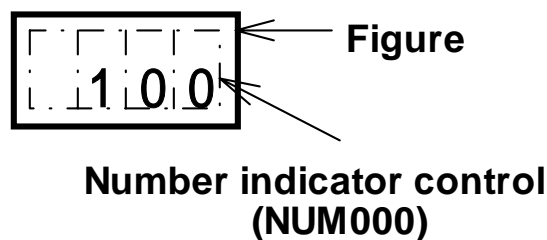

An example of the program is given below.

```

init
    local type%, id@, data%
    cyclic 00~D10
end init

conf
end conf

evnt
    input type%,id@,data%
    if type%=16 and id@=00~D10 then
        numdsp ..NUM000,data%
    end if
end evnt

```

● Configuration Block

```
cyclic 00~D10
```

The “cyclic” instruction reads the value of a device “D10” of the PLC whose station number is set to “00”.

The “cyclic” instruction is used to keep observing of PLC device values.

The “cyclic” instruction reads PLC device values periodically. When a PLC device value changes, the “cyclic” instruction transmits a messages to the Event Block. Type the station number and device name to be read after “cyclic”. K-BASIC rules require you to link the station number and the device name by a tilde “~”.

This instruction transmits a message when ever the screen changes.

● Configuration Block

Nothing is processed.

● Event Block

```
input type%,id@,data%
```

The “input” instruction reads the messages transmitted to the part. The format of the messages are in order of “type%” (16), id@ (00~D10) and data% (PLC value: 00~D10).

```

if type%=16 and id@=00~D10 then
    : : : : : : : : : :
end if

```

A condition “type%=16” put after “if” means a message from the PLC. “id@=00~D10” means that the ID of the device that has issued this message is 00~D10. Inserting “and” between these two items enables the subsequent programs to be executed only when both the conditions are satisfied.

```
numdsp ..NUM000,data%
```

The “numdsp” instruction displays data specified as a variable “data%” in the number indicator control specified as “..NUM000”. The variable “data%” in the “numdsp” instruction has the same value as that of “data%” of the “input” instruction (PLC device). This displays the PLC device value on the screen.

The flow of this program is as follows: The PLC device value is observed because the “cyclic” instruction is used in the Initialization Block. If the PLC device value changes, a message is issued to this part and the newest PLC device value is displayed on the screen by “numdsp” instruction.

Try to change the numerical value of the device used in this program from the PLC. You can see the numerical value on the screen changes simultaneously.

- How to make the part easier to use

If you want to observe plural PLC devices on one screen, you must rewrite and arrange two or more parts accordingly, each of which has a different device name. This will make you troublesome. The “Parameter” function will make this operation easier.

```
cyclic [station-number]~[num connected-device-address]
```

A character string enclosed in a pair of brackets, [], as shown above is called a template. (A maximum of 32 half-size characters can be written in [].) Since a character string written in brackets is displayed in the template of the corresponding part, the part can be used like a standard part. As a result, you only have to rewrite an operation parameter to change any device name without the need of changing the program.

A program example using templates is shown below.

```
init
    local type%, id@, data%
    cyclic [station number]~[num connected-device address]
end init

conf
end conf

evnt
    input type%, id@, data%
    if type%=16 and id@[station number]~[num connected-device name]
then
    numdsp ..NUM000,data%
    end if
end evnt
```

The "station number" and "num connected device address" templates are displayed in the "Property of arranged part" dialog box of the part having this operation program as shown below. It is possible to input values for these templates of each arranged part.

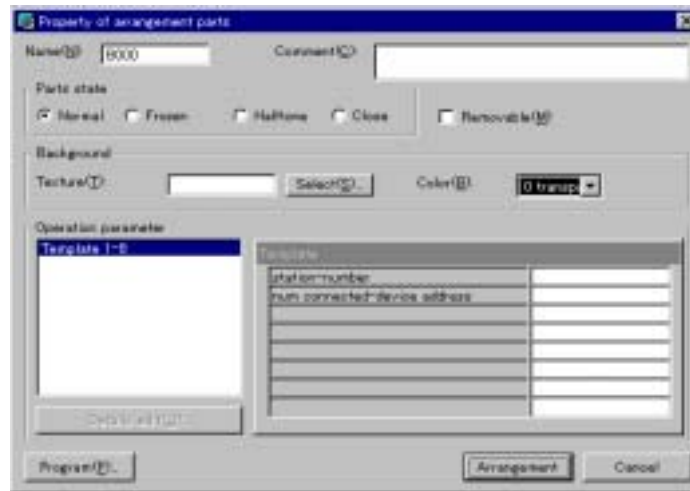

2-2-2 Indicator lamps

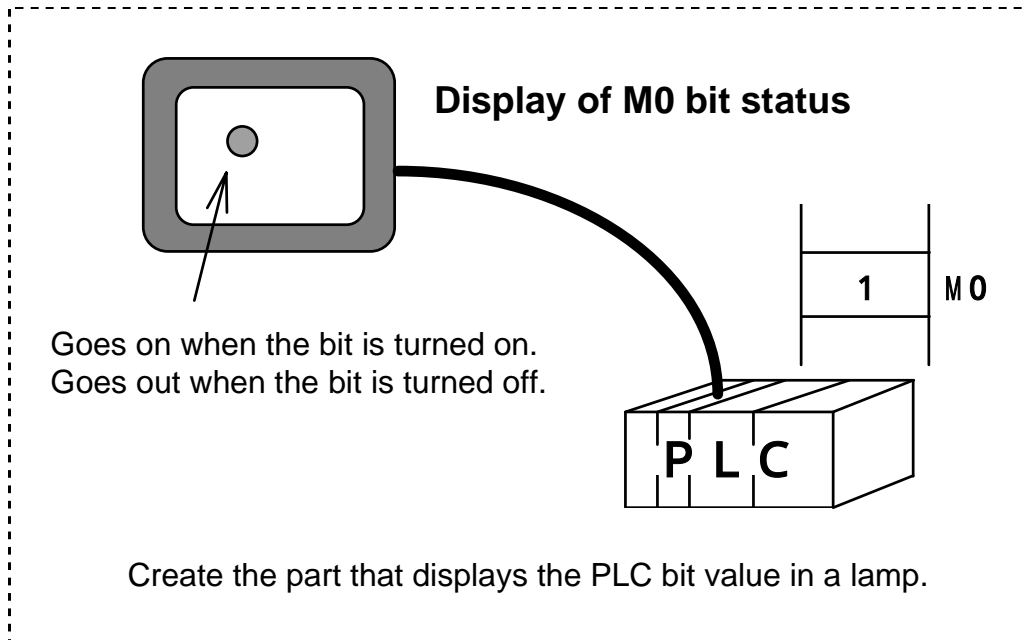

Control to use

One Lamp control (LAM000)

Exterior view of part

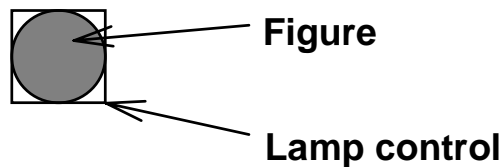

Note: The Lamp control has a function to change the OFF color of its area to the ON color if it is set to ON. So, the figure of the Lamp area must be painted with the OFF color.

A program of an indicator lamp to be linked to a PLC device is given below.

```

init
    local type%, id@, data%
    cyclic [station-number]"[lamp connected-device-address]
end init

conf
end conf

evnt
    input type%,id@,data%
    if type%=16 and id@= [station-number]"[lamp connected-device-address]
then
    lampdsp ..LAM000,data%
    end if
end if

conf
    cyclic [station-number]"[connected-device-address]
end conf

evnt
    input type%,id@,data%
    if type%=16 and id@[station-number]"[connected-device-address] then
        lampdsp ..LAM000,data%
    end if
end if

```

● Initialization Block

As explained above, a “cyclic” instruction is written in this block.

Configuration Block

Nothing is processed.

● Event Block

The “input” and “if” instructions are the same as that given in 2-2-1.

```
lampdsp ..LAM000,data%
```

The “lampdsp” instruction displays the ON or OFF color in the Lamp control. When the “data%” value is 0, the instruction displays the OFF color. When it is 1, the instruction displays the ON color.

The lanm displayed part has been created. Try to set and reset the PLC device bit specified in the program from the PLC. You can see the lamp color changes.

2-2-3 Switches

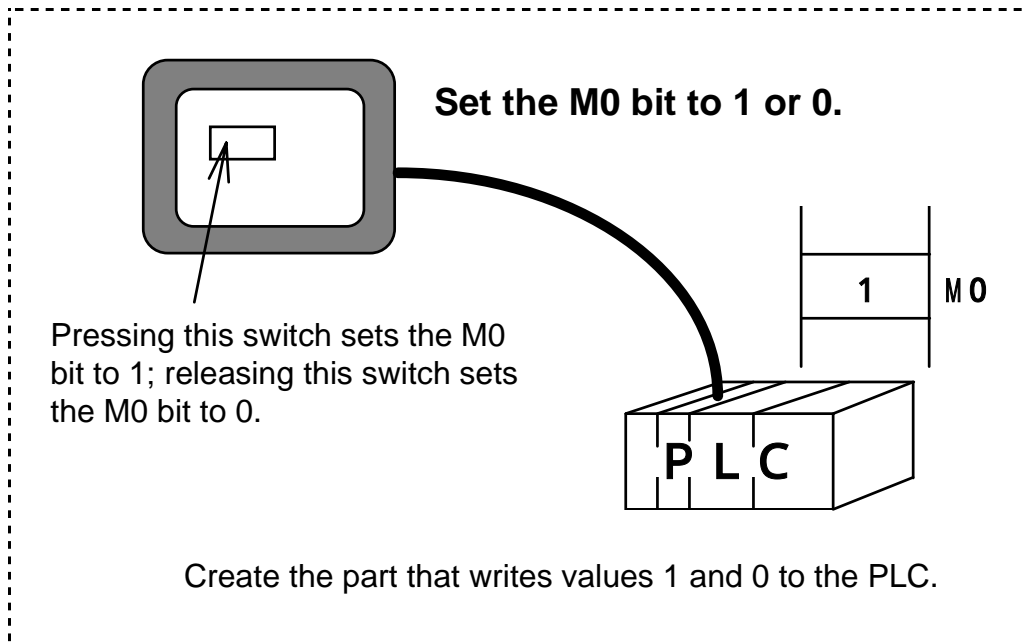

Control to use

One Switch control (SWT000)

Exterior view of part

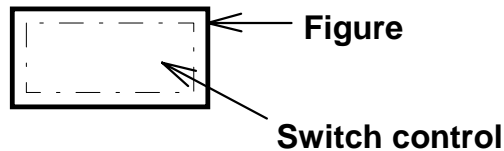

A program of a switch to be linked a PLC device is given below.

```

init
    local type%, id@, data%
end init

conf
end conf

evnt
    input type%, id@, data%
    if type%=3 and id@=..SWT000 and data%=1 then
        [station-number][connected-device-address]=1
    else if type%=3 and id@=..SWT000 and data%=0 then
        [station-number][connected-device-address]=0
    end if
end evnt
    
```

```
end evnt
```

- Initialization Block

You don't have to use any "cyclic" instruction in this example because a value is only written to the PLC.

- Configuration Block

Nothing is processed.

- Event Block

```
input type%, id@, data%
```

The "input" instruction reads messages from the switch. Messages are read in order of "type%=3", "id@=..SWT000.", and data%=ON/OFF (1 or 0) of switch.

```
if type%=3 and id@=..SWT000 and data%=1 then
    : : : : : : : : : : : : : :
else if type%=3 and id@=..SWT00 and data%=0 then
    : : : : : : : : : : : : : :
end if
```

"type%=3" means the message from the switch. "id@=..SWT000" means the ID of the switch control. "data%=1" means that the switch is pressed and "data%=0" means that the switch is released. The following instruction is executed when these three conditions are satisfied simultaneously.

```
[station-number][connected-device-address]=1
```

In this statement, 1 is written in the PLC device. 0 may be written in the same manner. The "if" statement of this program detects the moment the switch is pressed and writes 1 in the PLC device. The "else if" statement detects the moment the switch is released and writes 0 in the PLC device.

2-2-4 Indicator switches

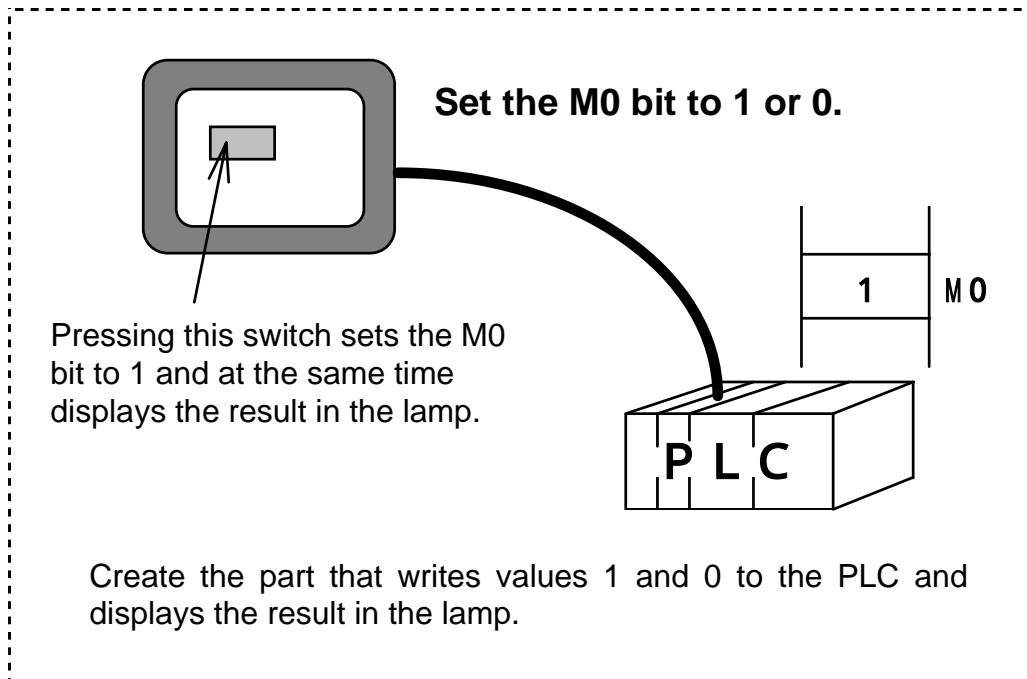

Control to use

One Switch control (SWT000) and one Lamp control (LAM000)

Exterior view of part

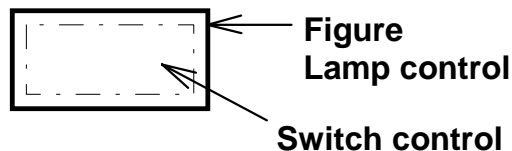

These two controls are placed, overlapping each other.

A program of an indicator lamp switch is given below.

```

init
    local type%, id@, data%
    cyclic[station-number]^[connected-device-address]
end init

conf
    cyclic[station-number]^[connected-device-address]
end conf

evnt
    
```

```

input type%,id@,data%
if type%=3 and id@=..SWT000 and data%=1 then
    [station-number][connected-device-address]=1
else if type%=3 and id@=..SWT000 and data%=0 then
    [station-number][connected-device-address]=1
else if type%=16 and id@[station-number][connected-device-address] then
    lampdsp ..NUM000,data%
end if
end evnt

```

This program consists of a lamp part and a switch part.

- Initialization Block

In this example, you can use a “cyclic” instruction to observe the PLC bit device that turns on/off the indicator lamp according to the device value.

- Configuration

Nothing is processed.

- Event Block

```
input type@,id@,data%
```

The “input” instruction reads messages from the switch and the PLC. If the message is from the switch, “type%” is set to 3, “id@” is set to ..SWT000, and “data%” is set to switch ON/OFF status (1 or 0). If the message is from the PLC, “type%” is set to 16, “id@” is set to the device ID (station number and device name), and “data%” is set to device value.

```

if type%=3 and id@=..SWT00 and data%=1 then
    : : : : : : : : : : : : : : : :
else if type%=3 and id@=..SWT000 and data%=0 then
    : : : : : : : : : : : : : : : :
else if type%=16 and id@[station-number][connected-device-address]
    : : : : : : : : : : : : : : : :
end if

```

In this portion, the message from the switch writes a value in PLC devices and the message from PLC turns on/off of the lamp.

2-3 Creating a Part to be Linked to an External Device

2-3-1 Display for host computer

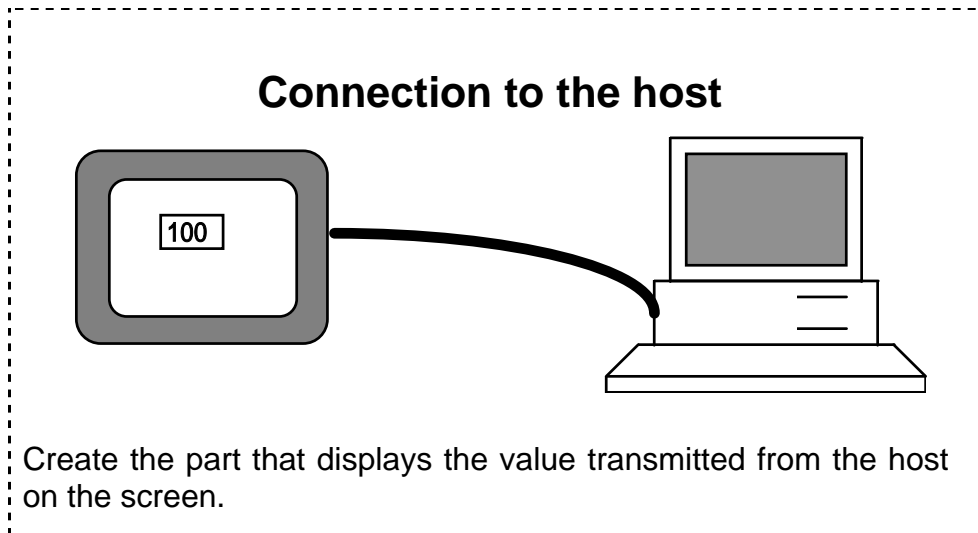

Control to use

One Number indicator control (NUM000)

Exterior view of part

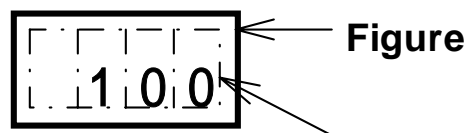

**Number indicator control
(NUM000)**

A program of a numeral display used for the host computer is given below

```

init
    local type%, id@, data%
    opencom HST
end init

conf
end conf

conf
    opencom HST

```

```

end conf

evnt
  input type%,id@,data%
  if type%=22 then
    numdsp ..NUM000,data%
  end if
end evnt

```

- Initialization Block

The “opencom” instruction is written in the Configuration Block.

```
opencom HST
```

The “opencom” instruction declares receiving of messages from external devices. Specify the following external device names after the “opencom” instruction.

```

HST:  Host computer
BCR:  Bar-code reader
TKY:  Ten-key pad

```

- Configuration Block

Nothing is processed.

- Event Block

```
input type%,id@,data%
```

The “input” instruction reads messages from the host computer.

```

if type%=22 then
  : : : : : :
end if

```

The condition “type%=22” put after “if” means a message from the host computer. If the message is transmitted from the host computer, the statement following “then” will be executed.

```
numdsp ..NUM000,data%
```

This block displays data on the numeral display. A numeric value from the host is input in “data%” in this block. This program ends here. The configuration block of this program receives a message from the host, and the event block displays the numerical data in the message from the host.

Note: For how to send data from the host computer, refer to the “Communication Manual”.

2-4 Creating a Part for Controlling Others

2-4-1 Part for calling others from touch panel

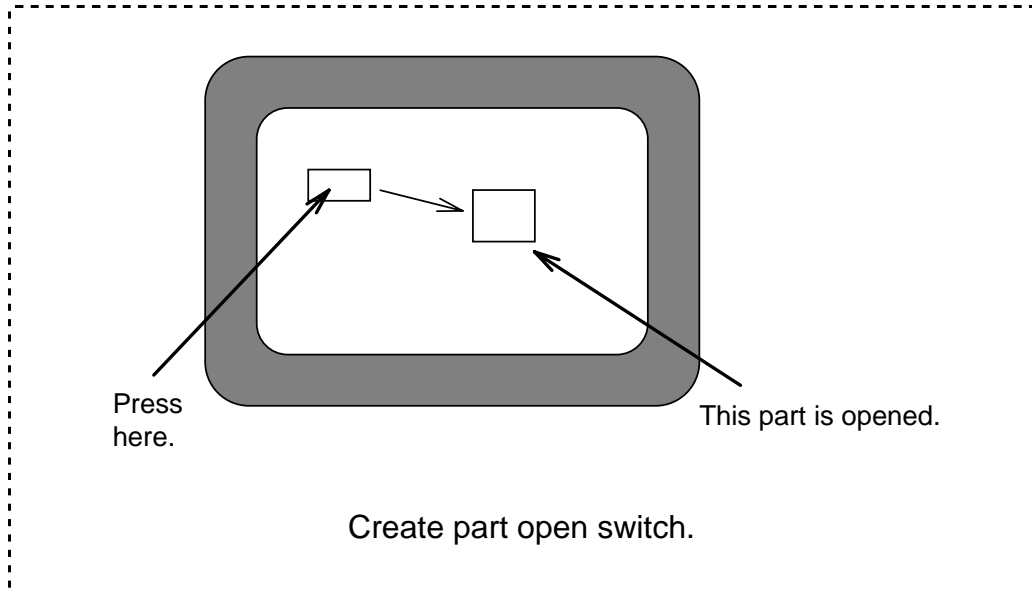

Control to use

One Switch control (SWT000)

Exterior view of part

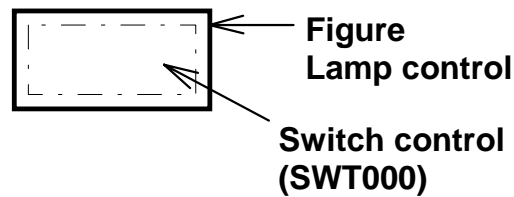

A program of a part for calling other parts from the touch panel is given below.

```

init
    local type%, id@, data%
end init

conf
end conf

evnt
    input type%,id@,data%
    if type%=3 and id@=..SWT000 and data%=1 then

```



```

        open .[name-of-part-to-be-opened] . , 1
    end if
end evnt

```

- Initialization Block

Nothing is processed except that the block declares local variables.

- Configuration Block

Nothing is processed.

- Event Block

```

input type%,id@,data%

```

The “input” instruction reads messages from the switch control.

```

if type%=3 and id@=..SWT000 and data%=1 then
    : : : : : : : : : : : :
end if

```

The portion indicates that the program between the “if” and “end if” statements is executed when the switch is pressed.

```

open .[name-of-part-to-be-opened] . , 1

```

The “open” instruction changes the part state specified by ID from close to open. If the numerical value following the part name is 1, the Configuration Block of the opened part is executed when the part opens. If the value is 0, the Configuration Block is not executed. This block uses an operation parameter for allowing a called part to be changed easily.

This program ends here. The configuration block of the part specified in the operation parameter is executed and the part is opened when the switch is pressed.

Note: Close the part specified for [name-of-part-to-open] on the screen.

2-4-2 Part for sending/receiving numerics to/from others

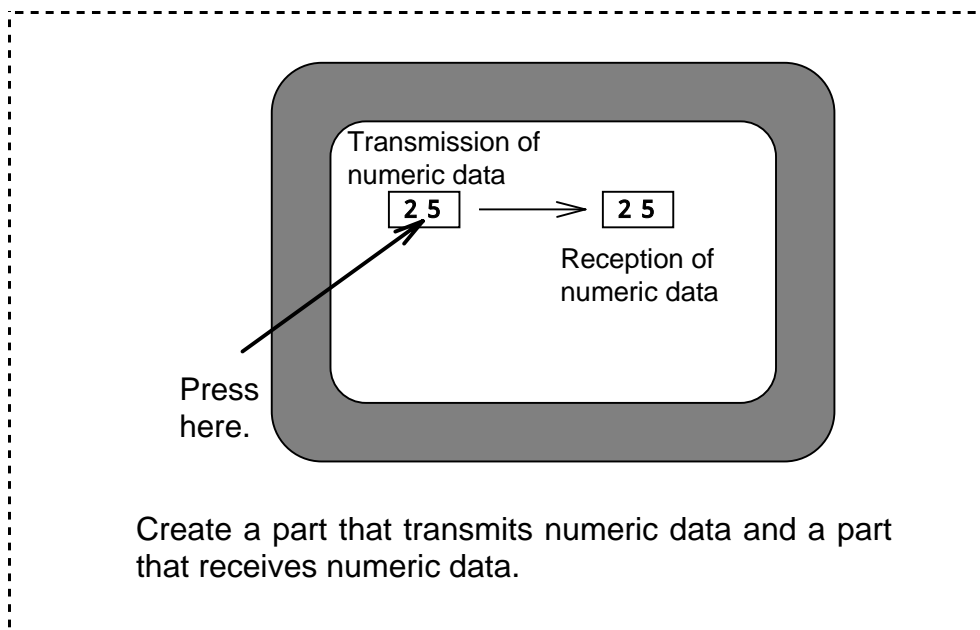

First, create a part that transmits numerical data.

Control to be use

One Number indicator control (NUM000) and one Switch control (SWT000)

Exterior view of part



**Number indicator control
(NUM000)**

These two controls overlap each other.

A program of a part for sending numerical data is given below.

```

init
    local type%, id@, data%
conf
    numdsp ..NUM000,[numeric-value-to-be-displayed]
end init

conf
end conf

```

```

evnt
  input type%,id@,data%
  if type%=3 and id@=..SWT000 and data%=1 then
    print [numeric-value-to-be-displayed]
    send .[remote-destination-part-name].
  end if
end evnt

```

- Initialization Block

```
numdsp ..NUM000,[numeric-value-to-be-displayed]
```

The “numdsp” instruction in the Configuration Block is necessary to display a numerical value from the beginning.

- Configuration Block

Nothing is processed.

- Event Block

```
input type%,id@,data%
```

The “input” instruction reads messages from the switch control.

```

if type%=3 and id@=..SWT000 and data%=1 then
  print [numeric-value-to-be-displayed]
  send .[remote-destination-part-name].
end if

```

This portion executes “print” and “send” instructions when the switch is pressed.

```
print [numeric-value-to-be-displayed]
```

The “print” instruction transmits messages to other parts. A message comprises a type, an ID, and a “display value” described here. If you want to transmit two or more numeral values, you can chain them by delimiting each value by a comma (‘,’).

```
Example print 123,456,789
```

In this case, the “input” instruction set for the part receiving data is divided into three as shown below.

```
Example input type%,id@,data1%,data2%,data3%
```

In this example, “data1%” is read to 123, “data2%” is read to 456, and “data3%” is read to 789.

```
send .[remote-destination-part-name].
```

The “send” instruction transmits a message generated by the “print” instruction to the specified part ([remote-destination-part-name]). Be sure to use “print” and “send” instructions in combination.

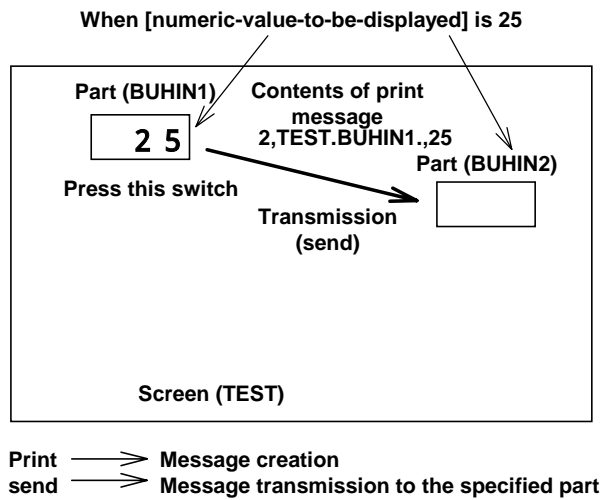

The program of this part ends here. This program sends a message containing a [display value] to the [remote destination part] specified in the operation parameter when the switch is pressed.

In the next place, create a part that receives numerical data.

Control to use

One Number indicator control (NUM000)

Exterior view of part

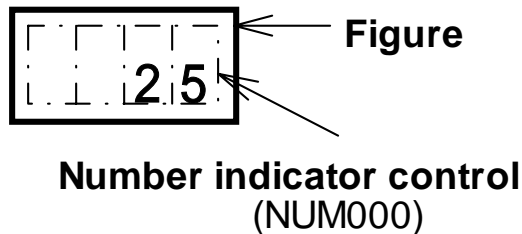

A program of a part that receives numerical data is given below.

```

init
    local type%, id@, data%
end init

conf
end conf

evnt
    input type%,id@,data%
    if type%=2 then
        numdsp ..NUM000,data%
    end if

```

```
end evnt
```

- **Initialization Block**

Nothing is processed except that this block defines local variables.

- **Configuration Block**

Nothing is processed.

- **Event Block**

```
input type%,id@,data%
```

The “input” instruction reads messages from the specified part.

```
if type%=2 then
    numdsp ..NUM000,data%
end if
```

The condition “type%=2” means receiving of a message from the part. The message is set in “data%” and displayed by the “numdsp” instruction.

The program of this part ends here. When another part sends numerical data to this part, this program displays the numerical data.

Next, try to paste two parts on the screen and use them actually. The operation parameter [destination-part-name] must coincide with the name of the part to receive the data. If you press the switch of the part that transmits numerical data, the same value will be displayed in the part that receives data.

2-5 Creating a Part for Using a Timer

2-5-1 Part for counting up

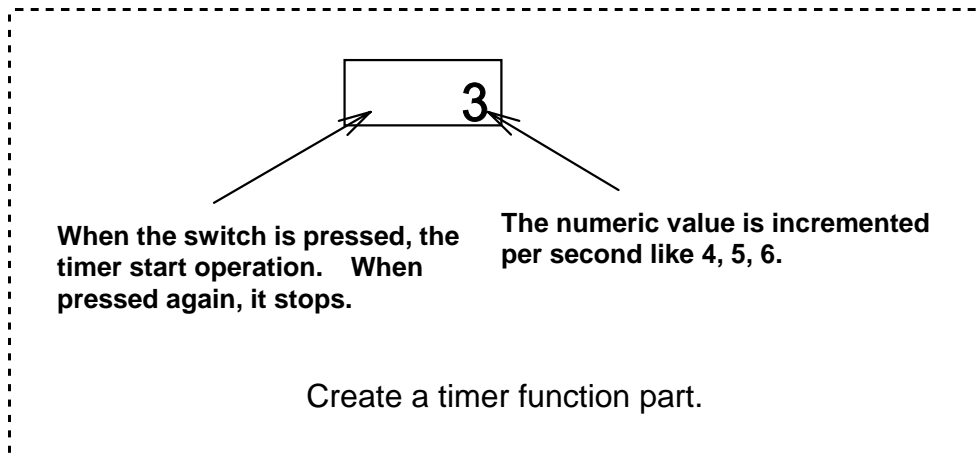

Control to use

One Number indicator Control (NUM000) and one Switch Control (SWT000)

Exterior view of part

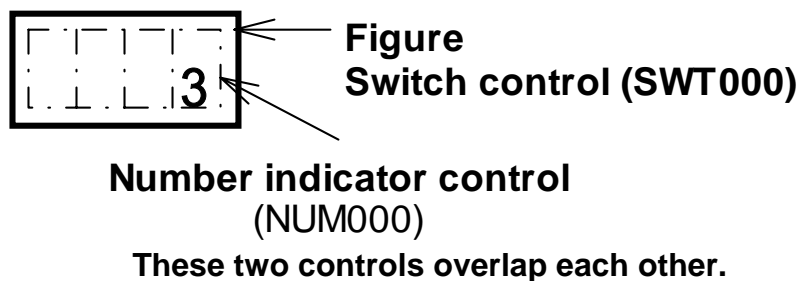

A program of a part that increments a numerical value is given below.

```

init
  local type%, id@, data%
  static timeid@
  static flag%
  static number%
  flag%=0
  numdsp ..NUM000,0
end init

conf
end conf

```

```

evnt
  input type%,id@,data%
  if type%=3 and id@=..SWT000 and data%=1 then
    if flag%=0 then
      timeid@=opentim()
      settim timeid@,10,1
      starttim timeid@
      flag%=1
    else if flag%=1 then
      stoptim timeid@
      closetim timeid@
      flag%=0
    end if
  else if type%=4 then
    number%=number%+1
    numdsp ..NUM000,number%
  end if
end evnt

```

- **Initialization Block**

The definitions of the local variables and static variables are written.

```

static timeid@
static flag%
static number%

```

You can use the “static” instruction to retain the contents of variables during a program execution. In this example, these instructions are used to retain the value of the timer ID, the timer ON/OFF flag, and the display value. Some “static” instructions can also be written as a group. The list of parameters also can be chained, delimiting each parameter by a comma in this case.

```

Example: static timeid@,flag%,number%

```

```

flag%=0

```

The statement “flag%=0” initializes the flag variable which indicates the timer ON/OFF state.

```

numdsp ..NUM000,0

```

The “numdsp” instruction displays “0” first at starting.

- **Configuration Block**

Nothing is processed.

- **Event Block**

```

input type%,id@,data%

```

The “input” instruction reads messages from the Switch control and the timer.

```

if type%=3 and id@=..SWT000 and data%=1 then
    : : : : : : : : : ← When the switch is pressed
else if type%=4 then
    : : : : : : : : : ← When messages from the timer are read
end if

```

An operation to be performed when the switch is pressed and an operation to be performed when a message is received from a timer are described after “then”. A message is received from the timer each time the displayed value is counted. (A message is transmitted every second.)

If the switch is pressed, the following program is executed:

```

if type%=3 and id@=..SWT000 and data%=1 then
    if flag%=0 then
        timeid@=opentime()
        settim timeid@,10,1
        starttim timeid@
        flag%=1
    else if flag%=1 then
        stoptim timeid@
        closetim timeid@
        flag%=0
    end if

```

When the timer stops (flag%=0), the program following the “if flag%=0 then” statement is executed.

```

timeid@=opentim()

```

This function acquires the ID of the timer to be used. The ID is assigned for a variable “timeid@”.

```

settim timeid@,10,1

```

This instruction sets the time limit of the timer to generate events. You can set the time limit in units of 100 milliseconds. Parameter “1” following “10” means that the timer generates events repeatedly. If it is set to “0”, the timer generate only an event.

```

starttim timeid@

```

This instruction starts the timer.

You must use these three instructions as a set to operate the timer.

```

flag%=1

```

In this example, the variable “flag%” is used to indicate and retain the timer state. “flag%=1” means that the timer is in operation.

The statements following “else if” stop the timer in operation (flag%=1).

```
stoptim timeid@
```

This instruction cancels counting up the timer.

```
closetim timeid@
```

This instruction cancels the use of the timer obtained with “opentim” and returns the timer to the system.

You can use up to 16 times. Unnecessary timers must be returned to the system.

```
flag%=0
```

flag%=0 indicates that the flag is set to 0 because the timer stopped.

When a message is transmitted from the timer, the following program is executed.

```
else if type%=4 then
  number%=number%+1
  numdsp ..NUM000,number%
end if
```

Each time a message is transmitted from the timer, the numerical value to be displayed (variable “number%”) is incremented by “1” and displayed in the Number indicator control.

The program ends here. The initialization block of this program declares the variable and displays the default value of 0. The event block processes a message from the switch or timer. As a result, this program alternates two conditions. Every time the switch is pressed, a displayed value increased by one in one condition or such increase stops in the other condition.

2-6 Editing a Program for a Displayed Part

To edit the program of a part arranged on the screen, double-click on that part in the screen creation window. The "Property of arrangement part" window opens. Select "Program" in the window.

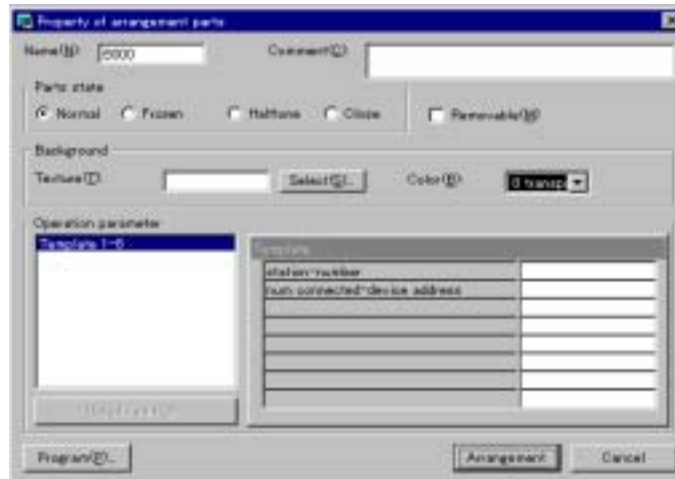

The program editor window opens.



CHAPTER 3

CODING RULES

3-1 Usable Characters

Half-size alphanumeric characters (0x20 to 0x7f ASCII codes), half-size Kana characters (0xa0 to 0xdf ASCII codes), and full-size characters (2-byte codes) can be used to write programs. As for the full-size characters, character strings enclosed in double quotation marks, " ", are valid. As for the Kana characters, device names and character strings enclosed in double quotation marks, " ", are valid. Alphabetic characters can be written in either capital letters or small letters. However, capital alphabetic letters and small alphabetic letters are discriminated from each other when they are used in character strings.

What uppercase and lowercase letters are not identified means that variable, function, and subroutine names used in K-Basic are handled as follows:

Label means the same as LABEL.
variable means the same as Variable.

3-2 Special Characters

Some characters in OIP K-Basic have special meanings. These characters are called special characters. The following special characters are used in OIP K-Basic.

Period “.”	Used to delimit screen, part, and control. Also used to represent a decimal point. Example of using periods to delimit screen, part, and a control GAMEN.BUHIN.PRIM BUHIN. Example of using periods to represent decimal points 1.23, 0.01
&, &0, &H	& and &0 are used to represent an octal number. &H is used to represent a hexadecimal number. &7 (octal notation) represents 7 in decimal notation. &10 and &010 (octal notation) represent 8 in decimal notation. &H20 (hexadecimal notation) represents 32 in decimal notation.
%, \$, !, @	Used to represent the types of variables or functions. These special characters are added to the ends of variable names or function names. %: Represents an integer-type variable. (VAR%) \$: Represents a character-type variable. (MOJI\$) !: Represents a floating-point-type variable. (FLOAT!) @: Represents an ID-type variable. (ID@)
Tilde “~”	Used to delimit a station number and a PLC device name. 00~D100: 00 is a station number and D100 is a PLC device address.
“[”, “]”	Used when operation parameters are written. conf cyclic [station-number][connected-device-address] end conf
Apostrophe “'”	Symbol for indicating the start of a comment. The portion from this symbol to the end of a line is treated as a comment. An apostrophe is used as follows: conf global var(3,2) ' This is the declaration of a variable. end conf
“:”	Used to delimit a label. A label is used as a GOTO jump destination or a subroutine name. evnt if var% = 0 then goto LABEL aa% = bb% + 1 LABEL: aa% = 10 end evnt

3-3 Constants

OIP K-Basic uses character constants, integer-type constants, floating-point-type constants, and ID-type constants.

Character constant	A character string enclosed in double quotation marks (") is called a character constant. Character strings of up to 80 bytes can be enclosed in double quotation marks. "ABCDEF" and "1234", etc., are character constants.
Integer-type constant	Integer-type constants can be represented in the octal, decimal, and hexadecimal formats. &123,&66 (octal notation) & or &O is added to the beginning of numbers 0 to 7. 100,322 (decimal notation) Values from -2147483648 to 2147483647 can be assigned. &H123,&HFF &H is added to the beginning of (hexadecimal notation) characters 0 to F.
Floating-point-type	Floating-point-type constants can consist of values from 1.70141E+38 to constant +1.70141E+38. The number of significant digits is 6 digits. A floating-point-type constant can be written like 1.23,0.001,-2,3E-4. E-4 indicates the -4 power of 10.
ID-type constant	Screen names, part names, primitive names, logical device names, graphic names, text names, and PLC device names can be written as ID-type constants. <ul style="list-style-type: none"> • Screen name, part name, and primitive name A screen name can be written like SCREEN.. and a part name can be written as SCREEN.PART. A primitive name can be written like SCREEN.PART.PRIM. • Logical device name In OIP BASIC, HST (host computer), PRN (printer), BCR (bar code reader), MCR (magnetic card reader), TKY (ten-key pad), ICC (memory card), and SIO (serial port) can be written as logical device names. Logical devices are connected to the OIP. • For figures and texts, the names assigned to register them can be written as they are. • PLC device names are written as 00~D100 and 00~M10, etc.

3-4 Constant Declaration

In Screen Creator 5, it is possible to declare constants. Declaring constants means giving constant names to constants in frequent use and using such constant names, instead of constant values, in programs. The character constants, integer constants, and real number constants can be declared. It is impossible to declare ID constants. Constant declaration allows the user to change the values of constants in programs at a time. It also makes programs easy to read.

Declare a constant as shown below.

```
const constant name = constant value
```

A constant name is a character string which is created in the same manner as creating a variable name and enclosed in a pair of # symbols. The constant value is as described in 3-3 above.

Example: `const #pai# = 3.1415`

When the "pai" constant is declared as shown above, all "pai" constants in the programs are replaced with the value of 3.1415.

Constants can be declared in portions other than the screen operation programs on a global screen. If a constant is declared in a screen operation program on a global screen, a compilation error occurs.

3-5 Variables

Alphanumeric characters and an underscore “_” can be used as variable names. (Uppercase and lowercase letters of variable names are not identified.) A variable name cannot begin with a number. Write each variable name with up to 20 characters (bytes).

Add one of the type declaration characters \$, %, ! and @ in order to the end of a constant name to express the type of the constant. The real number constant is the only exception. No type declaration character is added to the end of the real number constant.

3-5-1 Classification of variables

Character-type variable	Variable that stores characters. A variable ending with “\$” is a character-type variable. For the default, up to 20 characters (bytes) can be stored in a character-type variable. Use the STRING command to increase the number of characters.
Integer-type variable	Variable that stores an integer. A variable ending with “%” is an integer-type variable.
Floating-point-type	Variable that stores a floating-point number. A variable ending variable with “!” is a floating-point-type variable. Variables that do not end with ! are also treated as floating-point-type variables.
ID-type variable	Variable that stores ID-type values such as a screen name, a part name, a primitive name, and a logical device name. A variable ending with “@” is an ID-type variable.
Array-type variable	<p>A character-, integer-, floating-point-, or ID-type variable followed by the element(s) enclosed in parentheses is an array-type variable. Array-type variables can be used by declaring their arrays in the DIM command. They are usually written as follows:</p> <pre>GLOBAL VAR\$(2,3), VAR1%(10)</pre> <p>An array element can be usually referenced by specifying the subscript value in the parentheses. The subscript starts at 0. That is, VAR1%(10) is an integer-type array having 11 elements. Array-type variables can handle two-, three-, and ten-dimensional arrays.</p>

Note: Variables followed by different symbols (!, @, %, and \$) are handled as different variables although their names are the same. Variables are also handled as different variables, depending on whether they have an array.

VAR!, VAR@, VAR%, VAR\$, VAR!(5), VAR@(5), VAR%(5), VAR\$(5) are all different variables.

3-5-2 Types of Variables

The variables may be classified according to the storage method and difference between the ranges of the program to which can be referred in addition to the types.

Global variables	<p>Variables defined in the global declaration. Global variables are the common variables that can be referenced by all the global-declared BASIC programs.</p> <p>This variable can be referenced in a program where the variable is declared, as far as it is declared as a global variable.</p> <p>When the OIP is started, global variables are initialized only once. Integer- and floating-point-type global variables are initialized to 0. Character- and ID-type global variables are placed in the status in which nothing is written. A global variable is declared as follows:</p> <p style="padding-left: 2em;">GLOBAL VAR%</p> <p>When this declaration is made in two or more programs, they reference the same variable.</p>
Static variables	<p>Variables defined in the static declaration. Static variables can be referenced only in the declared program. When the OIP is started, static variables are initialized only once. Integer- and floating-point-type static variables are initialized to 0. Character- and ID-type static variables are placed in the status in which nothing is written. A static variable is declared as follows.</p> <p style="padding-left: 2em;">STATIC VAR%</p>
Backup variables	<p>Backup variables have almost the same characteristics as global variables except that their contents are retained even if the OIP power is turned off. Backup variables are not initialized even if the power is turned on again.</p> <p>However, a backup variable which hasn't been initialized is initialized to 0 when new screen data is down-loaded.</p> <p>A backup variable is declared as follows:</p> <p style="padding-left: 2em;">BACKUP VAR%</p> <p>When this declaration is made in two or more programs, they reference the same variable.</p> <p>Backup variables can be used for only OIP units with built-in backup memory. The backup memory stores data in it even when the OIP is turned off. If backup variables are used for an OIP with no backup memory, they cause the same functions as global variables. In other words, the values of backup variables are lost when the OIP is turned off and are initialized to 0's when the OIP is turned on again.</p> <p>An OIP with backup memory uses the backup memory for backup variables and RAM files (MS-DOS file systems or memory files). Thus, the sum of the memory size used for backup variables and the memory size used for RAM files must be less than the total size of the backup memory. The memory size used for RAM files is</p>

specified in "RAM File Setup" of "System Setup" on the OIP system screen.

Models	Backup memory sizes	Backup variable operations
GC56LC	63KB	Can be backed up.
GC55EM	63KB	Can be backed up.
GC53LC	None	Regarded as global variables.
GC53LM	None	Regarded as global variables.

Local variables

Local variables denote variables defined by local declarations (LOCAL) and undeclared variables used in portions other than the screen programs on global screens. Local declaration is not allowed in the screen programs on global screens.

Use LOCAL for local declaration as far as possible in Screen Creator 5, though it is possible to use DIM for local declaration of arrangement variables and STRING for local declaration of character string variables for compatibility with K-Basic of GCSGP3. Local variables are initialized every time programs are executed.

Each integer variable or real number variable is initialized to 0. Each character variable or ID variable is initialized to a blank.

A local variable is declared as shown below:

```
LOCAL VAR%
```

Auto variables

Auto variables denote variables defined by auto declarations (AUTO).

Auto variables can be defined and referred to in functions only. Auto variables are initialized every time functions are executed.

Each integer variable or real number variable is initialized to 0. Each character variable or ID variable is initialized to a blank.

An auto variable is declared as shown below:

```
AUTO VAR%
```

3-5-3 Checking variable types and variable interpretation in compilation

When screen data is created, the compiler executes syntactic analysis and processing of the program. If the program contains global declaration, static declaration or other distinctive declaration, processing is executed according to such declaration. In some cases, the type is interpreted and processing is done tacitly. If you do not keep such tacit interpretation in mind as a rule of writing programs, programs may not function as you expect. This section describes which types are interpreted tacitly.

- 1) Variables contained in screen programs on global screens not defined by global declaration, static declaration or backup declaration are interpreted as global variables tacitly, and variables are created automatically.
- 2) Variables contained in screen programs on screen other than global screens and variables contained in all part programs not defined by global declaration, static declaration, backup declaration, local declaration or auto declaration are interpreted as local variables tacitly, and variables are created automatically.

Tacit variable generation as shown above is one of the features of general BASIC languages. However, such a feature may not be desirable for some programmers. For example, if an incorrect variable name is written in a program, a local variable or global variable is generated automatically, while the programmer does not realize it. It is quite difficult to find such an error, since compilation of the program cannot find it.

To avoid such a trouble, Screen Creator 5 is capable of giving an error when it finds a variable with no declaration while it compiles a program. Normally, Screen Creator 5 goes not give an error. When a LOCAL CHECK statement is written in a program, Screen Creator 5 gives an error when it finds a variable with no declaration. For details of using the LOCAL CHECK statement, see Chapter 4 "Instruction Reference". To make programs as easy to read as possible and to minimize errors, it is recommended that the "LOCAL CHECK 1" statement be written at the beginning of a program to validate the error check function and all variables be declared.

3-5-4 Initializing variables

Screen Creator 5 can initialize a variable when it is declared. To initialize a variable, write an assignment statement behind declaration of the variable as shown below.

Example: `STATIC VAR% = 12`

In the case of an arrangement variable, the initialization data is complicated. Use "{" and "}" to list the initialization data. In the case of one-dimensional arrangement, write elements having subscripts which begin with 0.

Example: `GLOBAL ARRAY%(5) = {0, 1, 2, 3, 4, 5}`

In the case of multi-dimensional arrangement, write elements so that the subscripts increase from the right.

Example: `GLOBAL ARRAY%(2, 3) = {{0, 1, 2, 3, 4}, {4, 5, 6, 7}, {8, 9, 10, 11}}`
`GLOBAL ARRAY%(1, 2, 3) = {{{0, 1, 2, 3, 4}, {4, 5, 6, 7}, {8, 9, 10, 11}},`
`{{12, 13, 14, 15}, {16, 17, 18, 19}, {20, 21, 22, 23}}}`

If the type of the initialization data is different from the type of the variable, the data is initialized in the variable type.

It is impossible to initialize ID variables. Other types of variables can be initialized. Initialization applies to all types of variables. Note that, however, if initialization of backup variables is specified, backup variables are initialized every time the OIP is turned on and accordingly the purpose of using backup variables, i.e., storing values even after turning off the power, is not achieved.

It is also possible to initialize variables into backup variables. Note that, however, backup variables are initialized every time the OIP is activated and the purpose of using backup variables such as memorizing variable values is not fulfilled in this case.

Global variables, static variables and backup variables are initialized before all blocks in all programs are executed.

The position of initializing a variable depends on the variable type and where declaration is done. Global variables, static variables and backup variables are initialized before the program blocks are executed. Local variables are initialized when the block where the local variables are declared are executed. Therefore, note that, if local variables are declared in configuration blocks or event blocks, the variables are initialized every time these blocks are executed. Auto variables are initialized when the functions for which the auto variables are declared are called and executed.

3-6 Expressions and Operations

This section explains operations performed between variables and constants.

● Arithmetic operators

\wedge (exponent operation)	Exponent operation is written like $X \wedge Y$. This represents the Y power of X.
- (minus sign)	-100,-VAR! Integer- and floating-point-type numeric values are converted to minus values.
* (multiplication)	VAR1*VAR2 VAR1 is multiplied by VAR2.
/ (division)	VAR1/VAR2 VAR1 is divided by VAR2.
\div (division)	VAR1 \div VAR2 VAR1 is divided by VAR2. The quotient becomes an integer-type value.
+ (addition)	VAR1+VAR2 VAR2 is added to VAR1.
- (subtraction)	VAR1-VAR2 VAR2 is subtracted from VAR1.
MOD (remainder of integers)	VAR1 MOD VAR2 The remainder is obtained by dividing VAR1 by VAR2.

● Relational operators

Relational operators are used to compare two numeric values. The comparison result is true (-1) or false (0).

= (equal to)	= is used like VAR1=VAR2. When two values (VAR1 and VAR2) are equal, the result becomes true.
<> (not equal to)	<> is used like VAR1<>VAR2. When two values (VAR1 and VAR2) are not equal, the result becomes true.
< (less than)	< is used like VAR1<VAR2. When VAR1 is less than VAR2, the result becomes true.
> (greater than)	> is used like VAR1>VAR2. When VAR1 is greater than VAR2, the result becomes true.
<= (less than or equal to)	<= is used like VAR1<=VAR2. When VAR1 is less than or equal to VAR2, the result becomes true.
>= (greater than or equal to)	>= is used like VAR1>=VAR2. When VAR1 is greater than or equal to VAR2, the result becomes true.

● Logical operators

NOT	NOT is used like NOT VAR%. Logical negation applies to the numerical expression (variable or constant) following NOT.
AND	AND is used like VAR1% AND VAR2%. VAR1% and VAR2% are ANDed for each bit.
OR	OR is used like VAR1% OR VAR2%. VAR1% and VAR2% are ORed for each bit.
XOR	XOR is used like VAR1% XOR VAR2%. VAR1% and VAR2% are XORed for each bit.

Logical operators are used to operate two numeric values for each bit. For NOT, however, inversion is applied for each bit.

● Character operations

- Character connection

+	+ is used like VAR1\$+VAR2\$. That is, + is used to connect two characters. For VAR\$=VAR1\$+VAR2\$, the connected characters are assigned to VAR\$.
---	------------------------------------------------------------------------------------------------------------------------------------------------------

- Character string comparison

Two character strings are compared. The comparison result is true (-1) or false (0).

=	= is used like VAR1\$=VAR2\$. It is used to judge whether two character strings (VAR1\$ and VAR2\$) are equal.
<>	<> is used like VAR1\$<>VAR2\$. It is used to judge whether two character strings are not equal.
<	< is used like VAR1\$<VAR2\$. When VAR1\$ is less than VAR2%, the result becomes true.
>	> is used like VAR1\$>VAR2\$. When VAR1\$ is greater than VAR2%, the result becomes true.
<=	<= is used like VAR1\$<=VAR2\$. When VAR1\$ is less than or equal to VAR2\$, the result becomes true.
>=	>= is used like VAR1\$>=VAR2\$. When VAR1\$ is greater than or equal to VAR2\$, the result becomes true.

Two character strings are compared from the beginning for each byte. When two different characters are found, whether one character is greater than or less than the other is judged. When one character string becomes shorter than the other during comparison, the shorter string becomes small.

- **Priorities of operators**

Operators are written according to priorities below.

Expressions	Expression enclosed in parentheses
Functions	System-defined function and user-defined function
-	Minus sign
^	Exponent operator
*, /, %	Multiplication and division
+, -	Addition and subtraction
MOD	Remainder of integer
=, <>	Relational operators
NOT	Logical negation
AND, OR, XOR	Conjunction, disjunction, and exclusive

Note: *ID-type variables and constants can be applied only to the comparison between two items using relational operator “=”.*

3-7 Type Conversion

If logical operation is performed for different types when integer- and floating-point-type values are assigned to variables of different types, type conversion occurs.

- **Assignment**

The following is an example of assigning floating-point-type data to integer-type data.

```
VAR1% = 2.45
VAR2% = 2.56
```

In this case, 2 is assigned to VAR1% and 3 assigned to VAR2%.

A real number is rounded off when it is converted to an integer. The value obtained as a result of this rounding-off becomes an integer type.

- **Logical operation**

For logical operation, floating-point-type data is converted to integer-type data and operated.

```
VAR% = 23
FLOAT! = 12.35
VAR% AND FLOAT!
```

The result of this calculation is like 23 AND 12.

- **Others**

When an integer-type value is converted to a floating-point-type value, which in turn is converted to an integer-type value again, loss of significant digits may occur. In the OIP, the number of significant digits is 6 digits.

```
VAR% = 99999999
FLOAT! = VAR%
VAR% = FLOAT!
```

As a result of executing the above, 10000000 is set in VAR%.

3-8 Labels

Labels indicate a program jump destination and a subroutine name, etc. Labels are assigned names like variables. They are delimited by a colon (:). An example of a program that use labels is given below.

```
evnt
  input ty%,id@,dat%
  if dat% = 1 then goto LABEL1
  gosub SUBNAME
  .....
  .....
LABEL1: dat% = 20
end evnt

SUBNAME:
  dat% = 10
  return
```

3-9 Subroutines

Subroutines are written as a subroutine block outside the event block. Description of a subroutine begins with a label name and ends with RETURN. No K-BASIC command can be written in the line where a label name is written. Two or more subroutines can be written in one program.

```

conf
    ....
    Description of configuration block
    gosub SUB1
    ....
end conf
evnt
    ....
    Description of event block
    gosub SUB10
    ....
end evnt
SUB1:
    ....          Subroutine body

    RETURN
SUB10:
    ....          Subroutine body

    RETURN

```

Subroutines are classified into two types: local and global.

- **Global subroutine**

Global subroutines are the subroutines written on the global screen. Global subroutines can be called from all screen and part programs. Variables to be used by global subroutines are global and static variables. When a global subroutine is called from a screen (local screen) other than the global screen, only the variables for which "global" or "static" was declared on that screen can be used as global subroutine variables.

- **Local subroutine**

Subroutines written on screens other than the global screen are called local subroutines. Local subroutines can be used only in the program where they are written.

If the name of a written local subroutine is also contained in the global subroutine, the global subroutine is executed when the local subroutine is called. It is possible to give a warning indicating that the local subroutine name and global subroutine name are duplicated when creating download data by writing a LOCAL CHECK statement in such a program. For details of using the LOCAL CHECK statement, see Chapter 4, "Instruction Reference".

3-10 User-defined Functions

Screen Creator 5 supports user-defined functions. Several arguments are input by a caller, the user-defined functions are executed, and return values are sent to the caller.

3-10-1 Definition of user-defined functions

A user-defined function is defined in the format as shown below:

```
function function name [type declaration character] (argument 1, argument 2, .... )
    Program of the function
end function
```

The block between "function" and "end function" is called a function block. It is one of the program elements like the initialization block, configuration block, event block and subroutine block. It is impossible to write a function block in any other block.

The function name consists of a character string written in the same manner as writing a variable name. One of the type declaration characters \$, %, ! and @, which indicate the type of a return value, should be added to the function name. The real number function name is the only exception. It needs no type declaration character.

Argument 1, argument 2 and so forth enclosed in parentheses are given by the caller to the function. The type of the arguments is declared by the type declaration character. If no type declaration character is written, arguments are regarded as real numbers. The function caller can use variables, constants and calculation expressions as arguments.

If variables are specified as arguments, the function may substitute values for the arguments and, as a result, the arguments may be changed. In such a case, the variables of the caller are also changed. In other words, the function uses such arguments as the original variables, though they are called arguments, not variables.

If constants or calculation expressions are specified as arguments, the values are substituted for the arguments and the function is executed. If values are substituted for the arguments, the values of the arguments are changed, while no influences are placed upon the caller. In other words, the function regards such arguments as variables having default values (i.e., auto variables).

When a value is substituted for the function name with a type declaration character, a return value for the function is decided. The function caller can use the function name in an expression as a variable or an argument of another function.

The program of the function ends when processing reaches "end function" and processing is handed over to the caller. Use "exit function" to terminate processing of a function in the middle of a function program.

The following shows an example of user-defined function declaration:

```
function my_div%(a%, b%)
    if b% = 0 then
        if a% < 0 then
            my_div% = -217483648
        else
            my_div% = 217483647
        end if
    exit function
end if
my_div% = a% / b%
end function
```

3-10-2 Definition positions of user-defined functions and ranges of referencing

The types of programs which can refer to user-defined functions and the ranges of referencing differ with the positions where the functions are defined. The user-defined functions are classified into three types as shown below:

- Global functions

A global function has its function block written in the global screen program. A global function can be read from any screen or part program.

- Local functions

A local function has its function block written a program for a screen other than the global screen. A local function can only be called by the program in which it is defined.

- Library functions

A library function has its function block written in a function library under the control of Screen Creator 5. A library function can be read by any program.

3-10-3 How to call user-defined functions

To call a user-defined function, the user should declare the type of the function (i.e., prototype declaration) before all blocks of the program (i.e., initialization block, configuration block, event block, subroutine block and function block). The following format is used to declare a function. declare function name [type declaration character] (argument 1, argument 2, ...)
The type of the function shown in 3-10-1 "Definition of user-defined functions" is declared as shown below:

```
declare my_div% (a%, b%)
```

Functions to be actually referenced are selected in the order of the library functions, global functions, and local functions. If there are several types of functions having the same function name, these functions are referenced in the order shown above. By writing a LOCAL CHECK statement at the beginning of the program (before function declaration), it is possible to give an error indicating that function names are duplicate when compiling the program. For details of using the LOCAL CHECK statement, see Chapter 4, "Instruction Reference".

3-10-4 Variable declaration in user-defined functions and referencing external variables

It is possible to use auto variables in function blocks by declaring them. It is impossible to declare other types of variables.

Global variables and local variables contained in operation programs can be referenced, provided they can be referenced in the programs. In other words, it is possible to reference global variables, static variables and backup variables if they are declared in the programs. It is also possible to reference local variables which are declared or not declared in programs.

No library functions can be referenced, except auto variables declared in programs.

3-11 Program Operation

Operation of an OIP program is started when a message is issued to the part or screen written in the program. GCSGP3 provides the following types of messages:

- **Part and screen messages**
 - Part and screen programs can execute the SEND instruction to issue messages to a part or screen.
- **Switch messages**
 - A message is issued when the switch primitive placed on a part is set to ON or OFF.
 - A message is also issued by touching the switch primitive.
- **Internal timer messages**
 - A message is issued when the specified time has elapsed.
 - The internal timer in the program must be operated to receive messages from the timer. (See "OPENTIM.")
- **Alarm messages**
 - A message is issued when the specified time is reached.
 - For how to operate alarms, see "SETALARM Command."
- **PIO messages**
 - A message is issued when the parallel input status changes.
 - To receive messages from the parallel input, which PIO bit is to be used must be declared in the program in advance. (See "OPENPARALLEL.")
- **Non-procedual communication messages**
 - A non-procedual communication message is issued when non-procedual communication data reception is completed.
- **Sampling messages**
 - A sampling message is issued when the primitive that is performing sampling reads data.
- **PLC messages**
 - PLC device values are transmitted as a message. A PLC message is transmitted when the device contents change during communication between the OIP and PLC.
 - If the values of several PLC devices change, the changes are detected after the OIP communicates with the PLC. Therefore, messages may not be issued in the order of the changes in the device values.
 - To receive messages from the PLC, what PLC device is to be used must be declared in the program in advance. (See "CYCLIC command.")
- **Bar code/ten-key pad messages**
 - A message is issued when a bar code reader or ten-key pad starts communication with a part or screen. The contents of a message are the data itself transmitted from the bar code reader or ten-key pad.
 - The program must be coded in advance so that messages can be received from the bar code reader and ten-key pad. See "OPENCOM."
- **Host messages**
 - A message is issued when the host computer starts communication with a part or screen. The contents of a message are the data itself transmitted from the host computer.

- The program must be coded in advance so that messages can be received from the host computer. See "OPENCOM."

Messages are processed in the order they are issued (execution of the program that received messages).

Messages can also be issued to the undisplayed screen (rear screen). The operation program that received messages on the rear screen also operates.

3-12 Message Format

A message is a trigger for operating an OIP program. Each message consists of an issuer, an issuer ID, and issued data. By the way, each message can have one or more data. Three types are as shown below:

- 1 Value indicating the type of the message issuer (integer type)
- 2 Value indicating the ID of the message issuer (ID type)
- 3 Data itself (type of data to be issued)

Use the INPUT instruction to read messages into a program. Suppose, for example, that numeric data 10 was transmitted from the program whose screen name is SCREEN and whose part name is PART. In this case, the INPUT statement that reads messages is written as follows:

```
INPUT TYPE% , ID@ , DATA%
TYPE%: Value 2 indicating that messages were transmitted from the part is set in
      TYPE%.
ID@:   GAME.BUHIN. indicating the ID of the transmitted part is set in ID@.
DATA%: Data itself. 10 in this case.
```

The message format is as follows:

- Screens

Type of the message issuer: 1
 ID of the message issuer: Screen name
 Data: Data written in the PRINT statement

- Parts

Type of the message issuer: 2
 ID of the message issuer: Part name
 Data: Data written in the PRINT statement

- Switches

Type of the message issuer: 3
 ID of the message issuer: Switch name
 Data (single switch): 1 (when ON), 0 (when OFF)
 Data (multi-switches): Switch number 1 (when ON), 0 (when OFF)
 Data (selector switch): Switch number
 The switch number of a selector switch indicates the number of an activated switch when the number is 1 or more. If it is 0, it indicates that all switches are deactivated.

- Timers

Type of the message issuer: 4
 ID of the message issuer: ID of the timer opened by OPENTIM
 Data: 1 (fixed)

- Alarms

Type of the message issuer: 5
 ID of the message issuer: ID of the timer opened by SETALARM
 Data: 1 (fixed)

- **PIO**
 Type of the message issuer: 6
 ID of the message issuer: ID representing the parallel port
 Data: First: Bit number matching the condition set by OPENPARALLEL.
 Second: Bit status (1: ON, 0: OFF)
 Third: PIO channel number (0 to 3)
- **Non-procedual communication**
 Type of the message issuer: 7
 ID of the message issuer: –
 Data: First: Port number
 Second: Status
 Third: Number of received bytes
- **Sampling**
 Type of the message issuer: 9
 ID of the message issuer: ID of the primitive that is performing sampling
 Data: Sampled value
- **PLC and memory link**
 Type of the message issuer: 16
 ID of the message issuer: Device name or memory table name
 Data: Device value or memory table value
- **Bar codes**
 Type of the message issuer: 18
 ID of the message issuer: Logical name “BCR”
 Data: Character string read from bar code reader
- **Ten-key pad**
 Type of the message issuer: 20
 ID of the message issuer: Logical name “TKY”
 Data: Characters read from the ten-key pad
- **Host computer (command communication)**
 Type of the message issuer: 22
 ID of the message issuer: Logical name “HST”
 Data: Data transmitted from the host computer

Use the INPUT instruction to read messages into a program. Suppose, for example, that numeric data 10 was transmitted from the program whose screen name is SCREEN and whose part name is PART. In this case, the INPUT statement that reads messages is written as follows:

```
INPUT TYPE% , ID@ , DATA%
```

TYPE%: Value 2 indicating that messages were transmitted from the part is set in TYPE%.

ID@: GAME.BUHIN. indicating the ID of the transmitted part is set in ID@.

DATA%: Data itself. 10 in this case.

3-13 Program Blocks

An OIP K-Basic program consists of THE blocks: INITIALIZATION (INIT to END INIT), configuration (CONF to END CONF), event (EVNT to END EVNT), subroutine (label name: -RETURN), AND FUNCTION (FUNCTION to END FUNCTION).

This section describes the initialization block, configuration block and event block. For details of the subroutine block, see 3-9 "Subroutines" above. For details of the function block, see 3-10, "User-defined functions" above.

The following shows an example of a program using these blocks:

```

declare func%(a%, b%)           'Function-type declaration
init                             'Initialization block
    static var1% = 10
    global var2% = 20
end init
conf                             'Configuration block
    var2% = 30
end conf
evnt                             'Event block
    input type% , id@ , data%
    if type% = 3 then
        var1% = func%(data, var2%)
        .....
        .....
    endif
end evnt
SUB1:                             'Subrountion block
    ....
    RETURN
function func%(a%, b%)          'Function block
    .....
    .....
end function

```

● Initialization block (INIT ~ END INIT)

- An initialization block written in a screen or part program is executed only once when the configuration block or event block of that program is executed for the first time. An initialization block is used to declare or initialize variables needed in a configuration block or event block.

● Configuration block (CONF ~ END CONF)

- The configuration block where screens and parts are written is executed only once when a screen is displayed. This block is not executed while a screen is being displayed. It is executed only once again when another screen is redisplayed.
- The configuration block for global screens and parts is executed only once when the system is started.
- The configuration block is used to write processing such as initialization.
- Only the closed part's configuration block is not executed even if a screen is displayed; it is executed when a part is opened. (See "OPEN Instruction.")

- Event block (EVNT END ~ EVNT)

- The event block is a program block that starts its operation when a message is received. The contents to be executed when a switch is pressed are written in this block.
- The event block cannot be written in the global screen program.

Note: *A configuration block is not executed if a message is sent to a screen not displayed and an event block is executed (by the timer or a host command). Thus, initialization written in the configuration block is not executed. Write necessary initialization in an initialization block.*

3-14 Devices and Communication

To reference and modify PLC devices, device names are written in K-Basic as follows: A station number and a device name are delimited by “~”.

VAR%=00~D100: The contents of the device whose device name is D100 and whose station number is 00 are read.

00~D200=40: 40 is written into the device whose device name is D200 and whose station number is 00.

Communication is used to read and write the contents of a device. Screen Creator 5 provides the following two communication methods:

- **Cyclic communication**

- The OIP always communicates with the PLC to read the contents of the device to be used. A message is issued when the contents of the device to be used are modified.
- Cyclic communication can be performed even if a K-Basic program is not executed.
- Cyclic communication is enabled by declaring CYCLIC.
- Cyclic write is inapplicable.

- **Event communication**

- Event communication is performed when the contents of a device are read or modified.
- Event communication is executed by a K-BASIC program.
- Event communication can also be used to write data to a device.

In the OIP, a global screen and a local screen are displayed, overlapping each other. In this case, communication between the global and local screens is performed as follows:

- **Global screen communication**

- Cyclic communication in a global screen is always executed irrespective of the local screen to be used.

- **Local screen communication**

- Only the cycle communication declared in the current screen can be used.
- Event communication is performed when the contents of a device are read or written during execution of the program being displayed on the current screen.
- If a program of a screen not displayed currently is activated and device reading or writing is executed, data may be read or written from/into a device not specified in the program. To avoid such a trouble, write a program so that device reading or writing will never be executed in a program of a screen not displayed. For example, messages are sent to programs of non- displayed programs in timer, alarm or graph sampling. Thus, device reading or writing should be prevented in programs containing event blocks which process these messages. If device reading or writing is necessary for message processing, execute it in a global screen program.

3-15 Memory Tables

A memory table is used for communication between the host computer and memory link. This table is of word type (2 bytes). There are 2048 configuration elements (address 0 to address 2047).

The following explain how to access the memory table in K-Basic.

3-15-1 Describing memory table

00~MTBL(0): Memory table of 0th element
 00~MTBL(2047): Memory table of 2047th element
 00~MTBL(NO%): Memory table of element indicated by NO%

3-15-2 Reading and writing One element

- ABC=00~MTBL (100)
The contents of the 100th memory table are read into variable ABC.
- 00~MTBL (200) = 23
Data 23 is written to the 200th memory table.
- 00~MTBL (ABC) = XYZ
The contents of variable XYZ are written to the memory table indicated by variable ABC.

3-15-3 Reading and writing two or more elements

- BREAD 00~MTBL (100), 20, ABCD (XY)
- BREAD 00~MTBL (START), NUMS, ABCD (XY)
In the first example, 20 configuration elements are read into the XY location of array variable ABCD, starting at address 100 of the memory table. In the second example, NUMS configuration elements are read into the XY location of array variable ABCD, starting at the address indicated by START of the memory table.
- BWRITE 00~MTBL (100), 20, ABCD (XY)
- BWRITE 00~MTBL (START), NUMS, ABCD (XY)
In the first example, 20 data is written from the XY location of array variable ABCD to the memory table beginning with address 100.
In the second example, NUMS data is written from the XY location of array variable ABCD to the memory table beginning with the address indicated by START.

3-16 File Systems

This section describes the features of the file systems and the commands for accessing the file systems.

In the OIP, the backup memory and external memory cards can be used as MS-DOS-compatible file systems. These are called "MSDOS file systems".

Specify a drive name.

Drive name	Description
Drive A:	A part of the backup memory is used as the MS-DOS file system.
Drive E:	Memory card drive. Use a serially connected memory card.

In addition, "memory files" are available. In memory files, memory images are read and written from/into the system memory. To access a memory file, use the file name "MEMORY".

File systems or memory files created in the backup memory are also called RAM files. Only OIP units with built-in backup memory can use RAM files. The backup memory stores data in it even when the OIP is turned off. A model with no backup memory cannot use file systems or memory files in the backup memory.

Models	Backup memory sizes	RAM files
KDP5648CA	63KB	Available.
KDP5640EHA	63KB	Available.
KDP5320CA	None	Not available.
KDP5320LA	None	Not available.

None: Not available.

3-16-1 Precautions for file systems

- **Memory**

Memory files are managed not in the form of file systems. Since the same system memory is used, it is impossible to use the drive A and MEMORY simultaneously.

- **Precautions for using backup memory for RAM files**

To use the backup memory for RAM files (i.e., files in drive A or MEMORY files), it is necessary to specify the capacity to be assigned to the RAM files on the system mode screen of the OIP. Use "RAM File Setup" of "System Setup" on the system screen.

A model with backup memory uses the backup memory for backup variables and RAM files. Therefore, the sum of the memory size used for backup variables and the memory size used for RAM files must be less than the total size of the built-in backup memory.

- **Making backup**

Data in drive A and memory file is backed up and stored even after the power is turned off. However, the backup data is cleared to zero if the memory size is changed on the system mode screen.

- **Formatting files**

Before using a file system, it is necessary to format the file. Use the K-Basic "FORMAT" command to format a file.

- **Formatting memory card drive**

The OIP's memory card drive creates files in the MS-DOS-compatible format, and data in the memory card can be read and written by the MS-DOS system running on a personal computer, etc. However, make a directory so that the sum of a file path name and a file name does not exceed 128 characters.

The OIP's memory card drive does not support long file names, which are supported by Windows 95, etc. Be careful not to give long names to files which are to be used on Windows 95, etc.

3-16-2 Specifying a file

The character A or E followed by a colon, : , indicates a drive.

Example: A:, E:

To show a directory, type ¥ or / as shown below.

Example: A:¥ABC, A:/ABC/DEF

Each file name consists of a file name (in eight characters) and an extension (in three characters). ASCII codes and Kanji codes can be used.

Example: ABCDE.DOC

3-17 Notes

Note the following points when writing K-Basic.

- **Color and tiling numbers**

In K-Basic, numeric values (0 to 15) are used to change the display colors and tile figures of graphs and displays. These numbers are assigned like 0, 1, 2, starting at the left of the pallet color displayed by the tool and tile figures.

- **Note 1 on screen transition**

When one OIP screen is switched to another, the momentary switch is forcibly turned OFF if it is ON. This is done irrespective of the mode (Input Enabled, Input Disabled, or Half Tone) of the switch. When the OFF message is issued, the BASIC program is also activated.

- **Note 2 on screen transition**

When the screen for cyclic communication is displayed, messages are issued from all the devices that are performing cyclic communication.

- If a message is issued to a part of the undisplayed screen, the program is executed in background. If an attempt is made to execute an unexecutable instruction in background, however, an error occurs.

- If an infinite loop is created in a program, switching and communication cannot be performed.

- Parts on which switches are installed can be moved only in grid units.

CHAPTER 4

INSTRUCTION REFERENCE

4-1 Instruction Reference

ABS	4-10	CVW	4-59
ADDCYC	4-11	CYCLIC	4-60
ADDCYC2	4-12	CYCLIC2	4-62
ADDCYCID	4-13		
ASC	4-14	DATE\$	4-63
ATN	4-15	DECLARE	4-64
AUTO	4-16	DEV RD	4-65
		DEVWR	4-66
BACKUP	4-17	DIM	4-67
BARCOLOR	4-18	DIR	4-69
BARDSP	4-20	DINV	4-71
BARSET	4-21	DOT	4-72
BARSHIFT	4-22	DSPMODE	4-73
BCD2BIN	4-23		
BEEP	4-24	EOF	4-74
BIN2BCD	4-25	ERRCTL	4-75
BITSET	4-26	ERRSTAT	4-76
BITTEST	4-27	EVENTWR	4-77
BLCTL	4-28	EVNT ... END EVNT	4-78
BLSTAT	4-29	EXECPRCODE	4-79
BLTCOLOR	4-30	EXIT FUNCTION	4-80
BLTDSP	4-31	EXP	4-81
BLTSET	4-32		
BREAD	4-33	FCLOSE	4-82
BWRITE	4-34	FGET	4-83
		FIELD ... END FIELD	4-84
CHDIR	4-35	FIGCOLOR	4-86
CHKTIM	4-36	FIGDSP	4-87
CHR\$	4-37	FIGFORM	4-88
CINT	4-38	FINPUT	4-89
CIRCOLOR	4-39	FLUSH	4-90
CIRDSP	4-40	FOPEN	4-91
CIRSET	4-41	FOR ... TO ... NEXT	4-92
CLEAR	4-42	FORMAT	4-93
CLOSE	4-43	FPRINT	4-94
CLOSECOM	4-44	FPUT	4-95
CLOSEPARALLEL	4-45	FRECOLOR	4-96
CLOSESIO	4-46	FREDSP	4-98
CLOSETIM	4-47	FSEEK	4-99
COLOR	4-48	FSUM	4-100
CONF ... END CONF	4-49	FUNCTION ... END FUNCTION	4-101
CONST	4-50	FWRITE	4-103
CONTTIM	4-51		
COPY	4-52	GETBLIGHT	4-104
COS	4-53	GETDATE	4-105
CURDIR	4-54	GETGID	4-106
CVB	4-55	GETGNO	4-107
CVF	4-56	GETID	4-108
CVI	4-57	GETOFFSET	4-109
CVID	4-58	GETTIME	4-110

GLOBAL.....	4-111		
GOSUB	4-112	NUMCOLOR	4-161
GOTO.....	4-113	NUMDSP.....	4-162
		NUMFORM.....	4-163
HEX\$.....	4-114		
		OCT\$	4-164
IF ... THEN ... ELSE	4-115	ONFERR.....	4-165
INIT ... END INIT.....	4-116	OPEN.....	4-166
INP	4-117	OPENCOM.....	4-167
INPBIT	4-118	OPENPARALLEL.....	4-168
INPUT	4-119	OPENSIO	4-169
INSTR	4-121	OPENTIM.....	4-170
INT	4-122	OPENTIM2.....	4-171
INTERLOCK	4-123	OPENTIM3.....	4-172
IOCTL	4-124	OUT	4-173
IOCTL2	4-126	OUTBIT.....	4-174
IOSTAT.....	4-127	OUTBITSTAT.....	4-175
		OUTSTAT	4-176
JUMP.....	4-128		
		PIPCOLOR.....	4-177
KILL.....	4-129	PIPDSP	4-178
		PLTCOLOR.....	4-179
LAMPCOLOR	4-130	PLTDSP.....	4-180
LAMPDSP	4-131	PMODE	4-181
LEFT\$	4-132	PRDSP	4-182
LEN	4-133	PREVJUMP	4-183
LINE.....	4-134	PRINT	4-184
LINPUT.....	4-135	PRMCTL	4-185
LNECOLOR.....	4-136	PRMSTAT	4-192
LNEDSP.....	4-137	PSTAT	4-202
LNESET	4-138		
LNESHIFT	4-139	RANGE.....	4-203
LNESHIFT2	4-140	READTIM	4-204
LOCAL.....	4-141	RENAME	4-205
LOCALCHECK	4-142	REOPENCOM.....	4-206
LOF	4-144	REOPENPARALLEL	4-207
LOG.....	4-145	RESETALARM.....	4-208
		RETURN	4-209
MCPY.....	4-146	RIGHT\$	4-210
MEDIACHK	4-147	RMDIR	4-211
MEDIASIZE	4-148	ROTATE.....	4-212
MID\$	4-149	RSTAT.....	4-213
MID\$	4-149	RUN.....	4-214
MKB.....	4-151		
MKDIR.....	4-152	SELECT CASE ... END SELECT.....	4-215
MKF	4-153	SEND.....	4-216
MKI	4-154	SETALARM.....	4-217
MKID	4-155	SETBEEP	4-218
MKS	4-156	SETBLIGHT.....	4-219
MKW.....	4-157	SETDATE.....	4-220
MOVE	4-158	SETLNEPLOT	4-221
MTRCOLOR.....	4-159	SETSIO.....	4-222
MTRDSP	4-160	SETTIM.....	4-223

SETTIME	4-224
SHIFT	4-225
SIN.....	4-226
SLDDSP	4-227
SOF.....	4-228
SQR	4-229
STARTTIM.....	4-230
STATIC	4-231
STOP	4-232
STOPTIM.....	4-233
STR\$.....	4-234
STRCOLOR	4-235
STRDSP	4-236
STRFORM	4-237
STRING.....	4-238
SWFIG.....	4-239
SWMODE	4-240
SWREAD	4-241
SWREV	4-242
SWWRITE	4-243
TAN.....	4-245
TIMES\$	4-246
TIMID	4-247
TIMINT	4-248
VAL/VAL2.....	4-249
WHILE ... WEND	4-250
WRITESIO/WRITESIOB	4-251

4-2 Indexes by Functions

Control structure

Arithmetic operation

ABS	4-10
ATN.....	4-15
BITSET.....	4-26
BITTEST	4-27
CINT.....	4-38
COS	4-53
EXP.....	4-81
INT.....	4-122
LOG.....	4-145
SHIFT.....	4-225
SIN.....	4-226
SQR.....	4-229
TAN.....	4-245

Variable declaration

AUTO.....	4-16
BACKUP.....	4-17
CONST.....	4-50
DIM.....	4-67
GLOBAL.....	4-111
LOCAL.....	4-141
STATIC.....	4-231
STRING	4-238

Character string manipulation

ASC	4-14
CHR\$.....	4-37
CVB.....	4-55
CVF.....	4-56
CVI.....	4-57
CVID	4-58
CVW.....	4-59
HEX\$.....	4-114
INSTR.....	4-121
LEFT\$.....	4-132
LEN	4-133
MCPY.....	4-146
MID\$ (Function).....	4-150
MID\$ (Statement).....	4-149
MKB.....	4-151
MKF.....	4-153
MKI.....	4-154
MKID.....	4-155
MKS.....	4-156
MKW.....	4-157
OCT\$	4-164
RIGHT\$.....	4-210
STR\$.....	4-234
VAL.....	4-249

Messages

INPUT.....	4-119
PRINT.....	4-184
RUN.....	4-214
SEND.....	4-216

--

Type conversion

BCD2BIN.....	4-23
BIN2BCD.....	4-25
GETGID.....	4-106
GETGNO.....	4-107
GETID.....	4-108
GETOFFSET.....	4-109
TIMID.....	4-247
TIMINT.....	4-248

Screen/part control

CLOSE.....	4-43
JUMP.....	4-128
MOVE.....	4-158
OPEN.....	4-166
PMODE.....	4-181
PREVJUMP.....	4-183
PSTAT.....	4-202
RSTAT.....	4-213

Switch control

SWFIG.....	4-239
SWMODE.....	4-240
SWREAD.....	4-241
SWREV.....	4-242
SWWRITE.....	4-243

Numeric displays

NUMCOLOR.....	4-161
NUMDSP.....	4-162
NUMFORM.....	4-163

Character string displays

STRCOLOR.....	4-235
STRDSP.....	4-236
STRFORM.....	4-237

Graphic displays

FIGCOLOR.....	4-86
FIGDSP.....	4-87
FIGFORM.....	4-88
ROTATE.....	4-212

Plot displays

PLTCOLOR.....	4-179
PLTDSP.....	4-180

Bar graph displays

BARCOLOR.....	4-18
BARDSP.....	4-20
BARSET.....	4-21
BARSHIFT.....	4-22

Line chart displays

LNECOLOR.....	4-136
LNEDSP.....	4-137
LNESSET.....	4-138
LNESHIFT.....	4-139
LNESHIFT2.....	4-140
SETLNEPLOT.....	4-221

100 percent bar chart displays

BLTCOLOR.....	4-30
BLTDSP.....	4-31
BLTSET.....	4-32

Pie chart displays

CIRCOLOR.....	4-39
CIRDSP.....	4-40
CIRSET.....	4-41

Free graph displays

FRECOLOR.....	4-96
FREDSP.....	4-98

Slide displays

SLDDSP.....	4-227
-------------	-------

Meter displays

MTRCOLOR.....	4-159
MTRDSP.....	4-160

Lamp displays

LAMPCOLOR.....	4-130
LAMPDSP.....	4-131

Pipe displays

PIPCOLOR.....	4-177
PIPDSP.....	4-178

Control control

CLEAR.....	4-42
DSPMODE.....	4-73
EXECPCODE.....	4-79
PRDSP.....	4-182
PRMCTL.....	4-185
PRMSTAT.....	4-192
RANGE.....	4-203

Serial control

CLOSECOM.....	4-44
CLOSESIO.....	4-46
FLUSH.....	4-90
OPENCOM.....	4-167
OPENSIO.....	4-169
REOPENCOM.....	4-206
SETSIO.....	4-222
WRITESIO.....	4-251

Parallel control

CLOSEPARALLEL.....	4-45
INP.....	4-117
INPBIT.....	4-118
OPENPARALLEL.....	4-168
OUT.....	4-173
OUTBIT.....	4-174
OUTBITSTAT.....	4-175
OUTSTAT.....	4-176
REOPENPARALLEL.....	4-207

Timers/alarms

CHKTIM.....	4-36
CLOSETIM.....	4-47
CONTTIM.....	4-51
OPENTIM.....	4-170
OPENTIM2.....	4-171
OPENTIM3.....	4-172
READTIM.....	4-204
RESETALARM.....	4-208
SETALARM.....	4-217
SETTIM.....	4-223
STARTTIM.....	4-230
STOPTIM.....	4-233

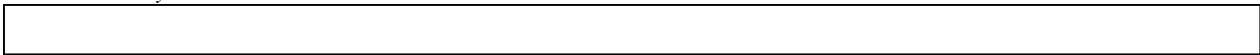

PLC/memory link communication	
ADDCYC	4-11
ADDCYC2	4-12
ADDCYCID	4-13
BREAD	4-33
BWRITE	4-34
CYCLIC	4-60
CYCLIC2	4-62
DEV RD	4-65
DEVWR	4-66
EVENTWR	4-77

Hardcopy	
COPY	4-52

Drawing	
COLOR	4-48
DINV	4-71
DOT	4-72
LINE	4-134

Back light control	
BLCTL	4-28
BLSTAT	4-29
GETBLIGHT	4-104
SETBLIGHT	4-219

Buzzer control	
BEEP	4-24
SETBEEP	4-218

Time/date	
DATE\$	4-63
GETDATE	4-105
GETTIME	4-110
SETDATE	4-220
SETTIME	4-224
TIME\$	4-246

File control	
CURDIR	4-54
DIR	4-69
EOF	4-74
FCLOSE	4-82
FGET	4-83
FIELD	4-84
FINPUT	4-89
FOPEN	4-91
FORMAT	4-93
FPRINT	4-94
FPUT	4-95
FSEEK	4-99
FWRITE	4-103
KILL	4-129
LINPUT	4-135
LOF	4-144
MEDIACHK	4-147
MEDIASIZE	4-148
MKDIR	4-152
ONFERR	4-165
RENAME	4-205
RMDIR	4-211
SOF	4-228
SUM	4-100

--

System control

Compiler control
LOCALCHECK.....4-142

ABS

Function

Function	The ABS function calculates an absolute value.
Format	ABS (numerical-expression)
Example of Use	AA = ABS (-50) AA = ABS (Var)
Description	The ABS function calculates the absolute value of the numerical expression (numeric constant, integer-type variable, or floating-point-type variable) enclosed in parentheses.
Related Item	None

Example of Program

```
evnt
  input type% , id@ , data%
  if data% < 0 then data% = abs(data%)
  numdsp ..num000 , data%
end evnt
```

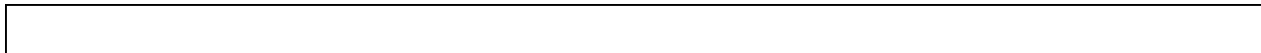
ADDCYC

Statement

Function The ADDCYC statement enables even BASIC of a part to read the device declared in control-name.

Format ADDCYC control-name

Example of Use ADDCYC ..NUM000

Description

- When a control in a part is used to validate an operation parameter, the ADDCYC statement enables even a part program to cyclically communicate with the PLC device/memory table set in the part operation parameter specification.
- The number of devices must match that of devices to be used by the control. (The devices placed in consecutive stages are used only the number of elements.)
- control-name must be the primitive in the local part.
- If the specified control is not using the PLC device/memory table, an error occurs.
- When the control is specified in a numeric display in a doubleword, the ADDCYC statement also reads it in a doubleword.

Related Item CYCLIC, CYCLIC2, ADDCYCID

Example of Program

```

conf
  ADDCYC ..NUM000          ' Uses 2X2 as a consecutive-stage display.
end conf
evnt
  input type% , id@ , data%  ' Displays data on the corresponding display.
  id1@ = addcycid ( ..NUM000) ' Indicates the ID of the device being used.
  i% = getoffset (id1@, id@)+1 ' Indicates the device to be used relative to the first
device.
  id1@ = getid(..NUM000, i%)  ' Obtains the ID of the corresponding display.
  numdsp id1@, data%         ' Displays the ID on the display.
end evnt

```

ADDCYC2

Statement

Function	The ADDCYC2 statement enables even BASIC of a part to read the device declared in primitive-name.
Format	ADDCYC2 primitive-name
Example of Use	ADDCYC2 ..NUM000
Description	<ul style="list-style-type: none"> • The ADDCYC2 statement is almost equivalent to the ADDCYC statement. • The only difference between these two statements is that the PLC device declared in the ADDCYC2 statement can communicate to obtain data even if the screen showing the declared part is not being displayed (when another screen is being displayed). Usually, the declared PLC device communicates to obtain data only when the screen showing the declared part is being displayed.
Related Item	ADDCYC, ADDCYCID

Example of Program

```

conf
  ADDCYC2 ..NUM000          ' Uses 2X2 as a consecutive-stage display.
end conf
evnt
  input type% , id@ , data%  ' Displays data on the corresponding display.
  id1@ = addcycid ( ..NUM000) ' Indicates the ID of the device being used.
  i% = getoffset (id1@, id@)+1 ' Indicates the device to be used relative to the first
device.
  id1@ = getid(..NUM000, i%) ' Obtains the ID of the corresponding display.
  numdsp id1@, data%        ' Displays the ID on the display.
end evnt

```

ADDCYCID

Function

Function	The ADDCYCID function obtains the ID of the device that was declared in control-name and enabled to be read by even part programs.
Format	ADDCYCID (control-name)
Example of Use	ID@ = ADDCYCID (..NUM000)
Description	<ul style="list-style-type: none"> • The ADDCYCID function obtains the ID of the device being used by the control enabled to be read by even part programs and returns the ID type. To enable this operation, however, the operation parameters of the control in the part must be set to “effective” and the PLC device must be set in the associated operation parameter in advance. • control-name must be the primitive in the local part. • If the specified primitive is not using the PLC device/memory table, an error occurs.
Related Item	ADDCYC, ADDCYC2

Example of Program

```

conf
  addcyc ..NUM000          ' Uses 2X2 as a consecutive-stage display.
end conf
evnt
  input type% , id@ , data%  ' Displays data on the corresponding display.
  id1@ = ADDCYCID ( ..NUM000) ' Indicates the ID of the device being used.
  i% = getoffset (id1@, id@)+1 ' Indicates the device to be used relative to the first
device.
  id1@ = getid(..NUM000, i%) ' Obtains the ID of the corresponding display.
  numdsp id1@, data%        ' Displays the ID on the display.
end evnt

```

ASC

Function

Function	The ASC function specifies the first 1-byte character code of a character string.
Format	ASC (character-string)
Example of Use	AA = ASC ("AABCD") AA = ASC (MOJI\$)
Description	<ul style="list-style-type: none">• The ASC function specifies the first character code of the character expression (character string constant or variable) enclosed in parentheses with a decimal number.• The ASC function specifies only the initial 1-byte code of a character expression which begins with a Kanji character.
Related Item	CHR\$

Example of Program

```
evnt
  input type, id@, data$
  num = ASC (data$)
  numdsp ..NUM000, num
end evnt
```

ATN

Function

Function The ATN function calculates the inverse tangent for the numerical expression.

Format ATN (numerical-expression)

Example of Use ANGLE = ATN (X/Y)

Description The ATN function calculates the inverse tangent value for the numerical expression. The result must be a value from $-\pi/2$ to $\pi/2$. The unit is radian.

Related Item TAN

Example of Program

```
evnt
.....
pi = 3.141592
angle% = atn( pi/4)
numdsp ..num000 , angle%
end evnt
```

AUTO

Statement

Function

The AUTO statement declares an auto variable.

Format

AUTO variable name [, variable name ...]

Example of Use

AUTO VAR, XYZ(2,3), MOJI\$ * 20

Description

- The AUTO statement declares that the variable is an auto variable. An auto variable can be declared and referenced in a function only.
- The value of an auto variable stays valid only while the function of that variable is called and executed.
- The value of an auto variable is initialized when the function is called and execution starts.
- A variable name can be specified in a normal variable, arrangement variable or character string variable.
- DIM declaration or STRING declaration is not needed to declare an arrangement variable or character variable.
- The auto variable type is one of the new features of Screen Creator 5.

Related Item**Example of Program**

```
function userfunc%(a%, b%)  
    AUTO c%  
    c% = a% + b%  
    userfunc% = c% / 2  
end function
```

BACKUP

Statement

Function	The BACKUP statement declares a backup variable.
Format	BACKUP variable-name [,variable-name ...]
Example of Use	BACKUP VAR, XYZ(2,3), MOJI\$*20
Description	<ul style="list-style-type: none">• The BACKUP statement declares a backup variable. Besides the characteristics of a global variable, a backup variable has a function to retain its value even if the power supply is turned off.• A normal variable, an array variable, or a character string variable can be specified in variable-name.• In order to declare arrays and character string type, no DIM and STRING declarations are required.
Related Item	AUTO, DIM, GLOBAL, LOCAL, STATIC, STRING

Example of Program

```
conf
  BACKUP a , x(2,3) , moji$ * 40
  .....
end conf
```

BARCOLOR

Statement

Function	The BARCOLOR statement changes the bar color and figure of the bar graph display.
Format	BARCOLOR display-name, bar-number, tile-1, display-color-1, background-color-1, tile-2, display-color-2, background-color-2
Example of Use	BARCOLOR ..BAR000, 2, 3, 1, 4, 5, 2, 1
Description	<ul style="list-style-type: none"> • The BARCOLOR statement changes the bar tiles and colors of the bar graph display and the background tiles and colors of the entire display. -1 indicates that the color and tile for which -1 was specified remain unchanged. • control-name is the name of a bar graph or the ID-type variable indicating the graph. • The value indicating the bar number in the bar graph to be changed is set in bar-number. The bar number can be specified with a constant or variable. The bar number starts at 1. • tile-1 indicates the tiling figure of the bar. Specify this tiling figure with a numeric value from 0 to 15. • display-color-1 is a numeric value indicating the color number of the tile display section. Specify this color number with a numeric value from 0 to 15. • background-color-1 is a numeric value indicating the color number of the tile background section. Specify this color number with a numeric value from 0 to 15. • tile-2 indicates the background tiling figure of the bar graph. Specify this tiling figure with a numeric value from 0 to 15. • display-color-2 is a numeric value indicating the color number of the tile display section of the background. Specify this color number with a numeric value from 0 to 15. • background-color-2 is a numeric value indicating the color number of the tile background section of the background. Specify this color number with a numeric value from 0 to 15.
Related Item	BARDSP, BARSHIFT

Example of Program

```
conf
  static name@
  name@ = ..BAR000
end conf
evnt
  input type%, id@, data%
  if type% = 3 then
    barcolor name@, 2, 2, 3, 1, 4, 5, 2
  end if
end evnt
```

BARDSP

Statement

Function	The BARDSP statement displays data in the bar graph display.
Format	BARDSP control-name, bar-number, display-value
Example of Use	BARDSP ..BAR000, 1, 30
Description	<ul style="list-style-type: none">• The BARDSP statement displays bar data in the bar graph display.• control-name is the name of a bar graph or the ID-type variable indicating the graph.• The value indicating the bar number in the bar graph to be displayed is set in bar-number. The bar number starts at 1.• display-value is the numeric data indicating the size of the bar graph.• display-value cannot be changed even if this statement is issued to the display for which operation parameters are set to “effective” in the control.
Related Item	BARCOLOR, BARSHIFT

Example of Program

```
conf
    static name@
    name@ = ..BAR000
end conf
evnt
    input type%, id@, data%
    bardsp name@, 2, data%
end evnt
```

BARSET

Statement

Function	The BARSET statement sets data in the bar graph display.
Format	BARSET, control-name, bar-number, display-data
Example of Use	BARSET .BUHIN.GRAPH, 2, 30.0
Description	<ul style="list-style-type: none">• The BARSET statement sets the data to be displayed in the bar graph display. The speed of executing the PRDSP (display) statement after setting data in each bar is faster than that of modifying all bar values after executing the BARDSP statement.• control-name is the name of the bar graph display name or the ID-type variable indicating the bar graph display.• bar-number indicates which bar data is to be modified when two or more bars are displayed in one bar graph display. The bar number is integer value data starting at 1.• display-data is the numeric data indicating the size of the bar graph.
Related Item	BARDSP, PRDSP

Example of Program

```
evnt
  BARSET .buhin.gpaph , 3 , 20.1
  var@ = .buhin.graph
  no = 4
  value = 23
  barset var@ , no , value
  prdsp var@
end evnt
```

BARSHIFT

Function

Function The BARSHIFT function shifts bar graph data left or right and displays it.

Format DATA% = BARSHIFT (control-name, shift-direction, display-data)

Example of Use DATA% = BARSHIFT (..BAR000, 1, 30)

Description

- When two or more bars are being displayed in one bar graph display, the BARSHIFT statement shifts the bars constituting the graph left or right by one bar and displays the bars.
- When the BARSHIFT function is executed, the values of the bars purged from the graph are returned as a result of the shifting.
- The variable indicating the graph name or ID is set in **control-name**.
- When **shift-direction** is 1, bar graph data is shifted left and above. When **shift-direction** is -1, bar graph data is shifted right and below.
- **display-data** indicates the data to be displayed in the vacant area produced as a result of the shifting.

Related Item BARDSP, BARCOLOR

Example of Program

```

evnt
  input type%, id@, data%
  if data% > 0 then
    abc% = barshift ( ..BAR000, 1, 0)
  else
    abc% = barshift ( ..BAR000, -1, 100)
  endif
end evnt

```

BCD2BIN

Function

Function	The BCD2BIN function converts BCD data to binary data.
Format	BCD2BIN (numerical-expression)
Example of Use	BINDATA% = BCD2BIN (BCDDATA%)
Description	The BCD2BIN function converts the entered BCD data to binary data.
Related Item	BIN2BCD

Example of Program

```
conf
  cyclic 00~D10
end conf
evnt
  input type%, id@, data%
  if type% = 16 then
    data% = BCD2BIN(data%)
    numdsp ..NUM000, data%
  endif
end evnt
```

BEEP

Statement

Function	The BEEP statement performs buzzer ON/OFF control.
Format	BEEP command-value
Example of Use	BEEP 1
Description	<ul style="list-style-type: none">• The BEEP statement is a command that sounds and stops the buzzer.• When command-value is 1, the buzzer sounds; when 0, the buzzer stops.• The SETBEEP statement can be used to set the buzzer ON/OFF time.
Related Item	SETBEEP

Example of Program

```
conf
  SETBEEP 50,20,3
end conf
evnt
  input type%, id@, data%
  if id@ = ..SWT000 then
    BEEP 1
  else
    BEEP 0
  endif
end evnt
```

BIN2BCD

Function

Function	The BIN2BCD function converts binary data to BCD data.
Format	BIN2BCD (numerical-expression)
Example of Use	BCDDATA% = BIN2BCD (BINDATA%)
Description	<ul style="list-style-type: none">• The BIN2BCD function converts binary data to BCD data.• If the binary data to converted to BCD data is greater than 99999999, it is fixed at 99999999.
Related Item	BCD2BIN

Example of Program

```
evnt
  input type%, id@, data%
  data% = BIN2BCD ( data% )
  00~D10 = data%
end evnt
```

BITSET

Statement

- **Function** The BITSET statement sets the specified bit of a variable to ON or OFF.
- **Format** BITSET variable-name, set-position, ON/OFF-value
- **Example of Use** BITSET VARIABLE%, 10, 1
- **Description**

 - The BITSET statement sets the specified bit of the specified variable to 0 or 1.
 - **variable-name** specifies the name of the variable where the specified bit is set to 0 or 1; it must be an integer- or floating-point-type variable.
 - **set-position** specifies where in the variable the specified bit is to be set with a value from 0 to 31; it must be a variable or constant.
 - When 1 is set in the variable, ON/OFF-value also specifies 1. When 0 is set, ON/OFF-value also specifies 0. It must be a variable or constant.
- **Related Item** BITTEST
- **Example of Program**

```

conf
end conf
evnt
    input type% , id@ , data%
    numdsp ..NUM000 , data%
    if bittest ( data% , 31 ) = 1 then
        bitset data% , 31 , 0
    else
        bitset data% , 31 , 1
    endif
    numdsp ..NUM000 , data%
end evnt

```

BITTEST

Function

- **Function** The BITTEST function tests the specified bit of a variable.
- **Format** BITTEST (variable-name, test-position)
- **Example of Use** ONOFF% = BITTEST (VARIABLE%, 10)
- **Description**
- The BITTEST function tests whether the value of the specified bit in the specified variable is 1 or 0. When the value of the specified bit is 1 as a result of the test, the function returns 1. When the value is 0, the function returns 0.
 - **variable-name** specifies the name of the variable where the value of the specified bit is to be tested; it must be an integer- or floating-point-type variable.
 - **test-position** specifies where in the variable the specified bit is to be tested with a value from 0 to 31; it must be a variable or constant.
- **Related Item** BITSET
- **Example of Program**

```
conf
end conf
evnt
    input type% , id@ , data%
    if bittest ( data% , 0 ) = 1 then
        strdsp ..STR000 , ``bit is ON``
    else
        strdsp ..STR000 , ``bit is OFF``
    endif
end evnt
```

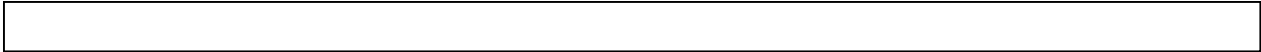

BLCTL

Statement

Function	The BLCTL statement performs back light ON/OFF control.
Format	BLCTL status
Example of Use	BLCTL 1
Description	<ul style="list-style-type: none">• The BLCTL statement performs back light ON/OFF control.• status indicates whether to turn on or off the back light with the following numeric values:<ul style="list-style-type: none">0: The back light is turned off.1: The back light is turned on.
Related Item	BLSTAT

Example of Program

```
evnt
  ret =blstat()
  if ret = 0 then BLCTL 1
end evnt
```

BLSTAT

Function

Function	The BLSTAT function reads the back light status.
Format	BLSTAT ()
Example of Use	
Description	The BLSTAT function reads the current back light status (ON/OFF). The return values of this function are as follows: 0: The back light is off. 1: The back light is on.
Related Item	BLCTL

Example of Program

```
conf
  ret = BLSTAT()
  if ret = 0 then blctl 1
end conf
```

BLTCOLOR

Statement

Function	The BLTCOLOR statement changes the tile and color of a belt graph display.
Format	BLTCOLOR control-name, zone-position, tile, display-color, background-color
Example of Use	BLTCOLOR ..BLT000, 2, 1, 2, 3
Description	<ul style="list-style-type: none"> • The BLTCOLOR statement changes the tile and color of the specified zone of a belt graph display. -1 indicates that the color and tile for which -1 was specified remain unchanged. • control-name is the bar graph name or the ID-type variable indicating the bar graph. • The value indicating the zone number to be changed is set in zone-position. The zone position can be specified with a constant or variable. The zone position starts at 1. • tile indicates the tiling figure of the zone. Specify this tiling figure with a numeric value from 0 to 15. • display-color is a numeric value indicating the color number of the tile display section. Specify this color number with a numeric value from 0 to 15. • background-color is a numeric value indicating the color number of the tile background section. Specify this color number with a numeric value from 0 to 15.
Related Item	BLTDSP

Example of Program

```

evnt
  input type%, id@, zone%, tile%
  BLTCOLOR ..BLT000, zone%, tile%, -1, -1
end evnt

```

BLTDSP

Statement

Function	The BLTDSP statement displays data on a belt graph display.
Format	BLTDSP control-name, zone-number, display-value
Example of Use	BLTDSP ..BLT000, 1, 30
Description	<ul style="list-style-type: none"> • The BLTDSP statement displays data in the specified zone of a belt graph display. • control-name is the name of the graph or the ID-type variable. • The value indicating the zone number in the 100 percent bar chart to be displayed is set in zone-position. The zone position can be specified with a constant or variable. The zone position starts at 1. • display-value is the numeric data indicating the size of the data to be displayed in the 100 percent bar chart. • display-value cannot be changed even if this statement is issued to the display for which operation parameters are set to “effective” in the control.
Related Item	BLTCOLOR

Example of Program

```

conf
  static name@
  name@ = ..BLT000
end conf
evnt
  input type%, id@, zone%, data%
  BLTDSP ..BLT000, zone%, data%
end evnt

```

BLTSET

Statement

Function	The BLTSET statement sets data in a belt graph display.
Format	BLTSET control-name, zone-number, display-data
Example of Use	BLTSET .BUHIN.GRAPH, 2, 30.0
Description	<ul style="list-style-type: none">• The BLESET statement sets the data to be displayed in the 100 percent bar chart display. The speed of executing the PRDSP (display) statement after setting data in each zone is faster than that of modifying all zone values after executing the BLTDSP statement.• control-name is the name of the belt graph display or the ID-type variable.• zone-number indicates which zone data is to be modified. The zone number is integer value data starting at 1.• display-data is the numeric data indicating the size of each zone in the 100 percent bar chart.
Related Item	BLTDSP, PRDSP

Example of Program

```
evnt
  BLTSET .buhin.gpaph , 3 , 20.1
  var@ = .buhin.graph
  no = 4
  value = 23
  BLTSET var@ , no , value
  prdsp var@
end evnt
```

BREAD

Function

Function The BREAD function reads the contents of the specified device or memory table in blocks.

Format BREAD device-name, data-read-count, array-variable-to-which-read-data-is-written
BREAD memory-table-name, data-read-count, array-variable-to-which-read-data-is-written

Example of use BREAD 00~D0001, 10, VARI(2)

BREAD 00~MTBL(5), NUMS, VARI(X)

Description

- The BREAD function reads the contents of the specified device or memory table in blocks.
- This function collectively reads data from the specified device by the specified data read count.
- **device-name** indicates the name of the device to be read (device name indicating the read start address).
- **data-read-count** specifies the number of data to be continuously read from the specified device.
- The data read from the specified device is set in **array-variable-to-which-read-data-is-written**. This variable must be a one-dimensional array-type variable. The data read from the specified device is continuously written, starting from the location specified by this variable.
- When the array variable is smaller than the data read count, the data that cannot be written to the array is discarded.
- The number of data that can be read depends on the type of PLC. (Refer to “Serial Communication Manual.”)
- For memory link, a variable can be used as a table number.

Related Item BWRITE

Example of Program

```
conf
  cyclic 00~M01
  static PARAM%(10)
end conf

evnt
  input type%, id@, data%
  if id@ = 00~M01 and data% = 1 then
    BREAD 00~D10, 5, PAARAM%(3)
  endif
end evnt
```

BWRITE

Function

Function	The BWRITE function writes data to the specified device or memory table in blocks.
Format	BWRITE device-name, data-write-count, write-data-variable BWRITE memory-table-name, data-write-count, write-data-variable
Example of use	BWRITE 00~D0001, 10, VAR%(1) BWRITE 00~MTBL(20), NUM, VAA(1)
Description	<ul style="list-style-type: none"> • The BWRITE function writes data to the specified device or memory table in blocks. • This function collectively write data to the specified device by the specified data write count. • device-name indicates the name of the device to be written (device name indicating the write start address). • data-write-count specifies the number of data to be continuously written to the specified device. • write-data-variable is the variable containing the value to be written to the specified device. This variable must be a one-dimensional array-type variable. Data is continuously written to the specified device, starting from the location specified by this variable. • When the array variable is smaller than the data write count, 0 is written to the remaining area. When the array variable is greater than the data write count, the larger part is ignored. • The number of data that can be written depends on the type of PLC. (Refer to “Serial Communication Manual.”) • For memory link, a variable can be used as a table number.

Related Item BREAD

Example of Program

```

conf
  cyclic 00~M01
  static PARAM%(10)
end conf

evnt
  input type%, id@, data%
  if id@ = 00~M01 and data% = 1 then
    BWRITE 00~D10, 5, PAARAM%(3)
  endif
end evnt

```

CHDIR

Statement

Function	The CHDIR statement changes a directory and/or a drive.
Format	CHDIR directory-name
Example of Use	CHDIR "C:TEST"
Description	<ul style="list-style-type: none"> • The CHDIR statement is an instruction that changes the current directory and a drive. • Specify the directory to be changed with a character string constant or variable. • directory-name can be specified, starting from a drive name.
Related Item	MKDIR, RMDIR

Example of Program

```

conf
end conf
evnt
    .....
    CHDIR ``C:``           ’ Changes the drive.
    CHDIR ``TEST``       ’ Changes the directory.
    CHDIR ``E:ABC``     ’ Changes both the drive and directory.
    .....
end evnt

```

CHKTIM

Function

Function	The CHKTIM function checks the status of the specified timer.
Format	RET = CHKTIM (timer-number)
Example of Use	RET = CHKTIM (14)
Description	<ul style="list-style-type: none">• The CHKTIM function checks whether the specified timer is being used (opened).• timer-number indicates the number of the timer to be checked; it must be an integer-type value from 0 to 15.• As a result of executing this function, any of the following values is returned:<ul style="list-style-type: none">0: The timer is not being used.1: The timer is being used by the local program.2: The timer is being used by a remote program.
Related Item	CLOSETIM, STARTTIM, STOPTIM, CONTTIM, SETTIM, READTIM, OPENTIM, OPENTIM2

Example of Program

```
evnt
  for i = 0 to 15
    ret = CHKTIM (i)
    if ret = 0 then i = 15
  next
end evnt
```

CHR\$

Function

Function The CHR\$ function assigns the character corresponding to the specified numeric value (character code).

Format CHR\$ (character-code)

Example of Use MOJI\$ = CHR\$(&H30)

Description

- The CHR\$ function assigns the character (1-byte character) corresponding to the character specified by character-code.
- character-code must be an integer from 1 to 255.
- As a result of executing this function, the character corresponding to character-code is returned.

Related Item ASC

Example of Program

```
evnt
  input type%, id@ data%
  moji$ = CHR$(data%)
  strdsp ..STR000, moji$
end evnt
```

CINT

Function

Function The CINT function rounds off a real number and converts it to an integer.

Format CINT (numerical-expression)

Example of Use A% = CINT (FLOAT)

Description • The CINT function rounds off the value indicated by numerical-expression and converts it to an integer.
• The conversion result range becomes the integer range.

Related Item INT

Example of Program

```
evnt
  input type%, id@, data
  intvar% = CINT ( data )
  numdsp ..NUM000, intvar%
end evnt
```

CIRCOLOR

Statement

Function The CIRCOLOR statement changes the tile and colors of the pie chart display.

Format CIRCOLOR control-name, zone-position, tile, display-color, background-color

Example of Use CIRCOLOR ..CIR000, 2, 1, 2, 3

Description

- The CIRCOLOR statement changes the tile and colors of the the pie chart display. -1 indicates that the color and tile for which -1 was specified remain unchanged.
- control-name is the pie chart name or the ID-type variable indicating the pie chart.
- The value indicating the number of the zone in the pie chart to be changed is set in zone-position. The zone position starts at 1.
- tile indicates the tiling figure of the zone. Specify this tiling figure with a numeric value from 0 to 15.
- display-color is a numeric value indicating the color number of the tile display section. Specify this color number with a numeric value from 0 to 15.
- background-color is a numeric value indicating the color number of the tile background section. Specify this color number with a numeric value from 0 to 15.

Related Item CIRDSP

Example of Program

```

evnt
  input type%, id@, zone%, tile%
  CIRCOLOR ..CIR000, zone%, tile%, -1, -1
end evnt

```

CIRDSP

Statement

Function	The CIRDSP statement displays data in the zone where the pie chart display was specified.
Format	CIRDSP control-name, zone-number, display-value
Example of Use	CIRDSP ..CIR000, 1, 30
Description	<ul style="list-style-type: none"> • The CIRDSP statement displays data in the zone where the pie chart display was specified. • control-name is the pie chart name or the ID-type variable indicating the pie chart. • The value indicating the zone number in the pie chart to be displayed is set in zone-number. The zone number can be specified with a constant or variable. The zone number starts at 1. • display-value is the numeric data indicating the size of the pie chart to be displayed. • display-value cannot be changed even if this statement is issued to the display for which operation parameters are set to “effective” in the control.
Related Item	CIRCOLOR

Example of Program

```

conf
    static name@
    name@ = ..CIR000
end conf
evnt
    input type%, id@, zone%, data%
    CIRDSP ..CIR000, zone%, data%
end evnt

```

CIRSET

Statement

Function	The CIRSET statement sets data in the pie chart display.
Format	CIRSET control-name, zone-number, display-data
Example of Use	CIRSET .BUHIN.GRAPH, 2, 30.0
Description	<ul style="list-style-type: none">• The CIRSET statement sets the data to be displayed in the pie chart display. The speed of executing the PRDSP (display) statement after setting data in each zone is faster than that of modifying all zone values after executing the CIRDSP statement.• control-name is the name of the pie chart display or the ID-type variable indicating the pie chart display.• zone-number indicates which zone data is to be modified. The zone number is integer value data starting at 1.• display-data is the numeric data indicating the size of each zone of the pie chart.
Related Item	CIRDSP, PRDSP

Example of Program

```
evnt
  CIRSET .buhin.gpaph , 3 , 20.1
  var@ = .buhin.graph
  no = 4
  value = 23
  CIRSET var@ , no , value
  prdsp var@
end evnt
```

CLEAR

Statement

Function	The CLEAR statement clears the display of the specified display.
Format	CLEAR control-name
Example of Use	CLEAR ..NUM000
Description	<ul style="list-style-type: none">• The CLEAR statement clears the display of the specified display, leaving only the background color.• When the slide display is specified, the CLEAR statement clears the pointer graphic.• When the meter display is specified, the CLEAR statement clears the needle.• When the clock display is specified, the CLEAR statement clears nothing.• control-name is the graph name or the ID-type variable indicating the graph. display-name.
Related Item	NUMDSP, STRDSP, FIGDSP, SLDDSP, MTRDSP, FREDSP, PLTDSP, BARDSP, BLTDSP, CIRDSP, LNE DSP

Example of Program

```
evnt
  input type%, id@, data%
  if data% = 1 then
    CLEAR ..NUM000
  end if
end evnt
```

CLOSE

Statement

Function	The CLOSE statement closes the specified part.
Format	CLOSE part-name
Example of Use	CLOSE .B000.
Description	<ul style="list-style-type: none">• The CLOSE statement closes the part displayed on the screen. The undisplayed status is called the close status.• Nothing is performed even if the CLOSE statement is executed for the closed part.• The program is started if the closed part receives a message.• part-name is the name or ID of the part to be closed.
Related Item	OPEN

Example of Program

```
evnt
  input type% , id@ , data%
  if pstat(..) = 0 then
    close ..
  endif
end evnt
```

CLOSECOM

Statement

Function	The CLOSECOM statement temporarily stops the use of a serial line.
Format	CLOSECOM device-name
Example of Use	CLOSECOM HST
Description	<ul style="list-style-type: none">• The CLOSECOM statement is a command that temporarily inhibits a program from receiving data from an external connecting device using the OPENCOM instruction.• HST (host computer), BCR (bar code reader), or TKY (ten-key pad) can be specified in device-name.
Related Item	OPENCOM

Example of Program

```
conf
  OPENCOM HST
end conf
evnt
  input type% , id@ , data%
  if type% = 3 and data% = 1 then
    CLOSECOM HST
  else if type% = 3 and data% = 0 then
    REOPENCOM HST
  endif
end evnt
```

CLOSEPARALLEL

Statement

Function	The CLOSEPARALLEL statement temporarily stops data input from a parallel port.
Format	CLOSEPARALLEL input-bit
Example of Use	CLOSEPARALLEL 3
Description	<ul style="list-style-type: none">• The CLOSEPARALLEL statement is an instruction that temporarily inhibits a program from receiving data as a message from the parallel port specification bit using the OPENPARALLEL instruction.• input-bit specifies the bit for inhibiting data reception.
Related Item	OPENPARALLEL, REOPENPARALLEL

Example of Program

```
conf
    OPENPARALLEL 3
end conf
evnt
    input type% , id@ , data%
    if type% = 3 and data% = 1 then
        CLOSEPARALLEL 3
    else if type% = 3 and data% = 0 then
        REOPENPARALLEL 3
    endif
end evnt
```

CLOSESIO

Statement

- **Function** The CLOSESIO statement closes a non-procedural communication port.
- **Format** CLOSESIO port-number
- **Example of Use** CLOSESIO 2
- **Description**

 - The CLOSESIO statement closes the port for stopping non-procedural communication.
 - port-number specifies a channel for stopping non-procedural communication. CH1 to CH3 correspond to 1 to 3, respectively.
 - The port to be closed must be opened in advance by the OPENSIO statement to be explained later.
- **Related Item** OPENSIO, SETSIO, WRITESIO, WRITWSIOB, FLUSH
- **Example of Program**

```

conf
  global buf$ * 200
  opensio 2 , 1 , buf$
  setsio 2 , &HD
end conf
evnt
  strdsp ..STR000 , buf$
  CLOSESIO 2
end evnt

```

CLOSETIM

Statement

Function	The CLOSETIM statement stops the user of the specified timer.
Format	CLOSETIM timer-number
Example of Use	CLOSETIM TIMID@ CLOSETIM VAR
Description	<ul style="list-style-type: none"> • The CLOSETIM statement returns the timer allocated by the OPENTIM, OPENTIM2, or OPENTIM3 function to the system. • The system can use up to 16 timers. The timers not to be used must be returned to the system. If allocating more than 16 timers is attempted, an error occurs. • timer-number indicates the number of the timer to be stopped and returned to the system. Whether the timer number is an ID- or integer-type value depends on how the timer is opened. (See “OPENTIM”, “OPENTIM2”, and “OPENTIM3.”)
Related Item	OPENTIM, OPENTIM2, OPENTIM3, STARTTIM, STOPTIM, CONTTIM, SETTIM, READTIM

Example of Program

```

conf
  static timid@
  timid@ = opentim()
  setim timid@, 20, 0
  starttim timid@
end conf
evnt
  input type% , id@ , data%
  if type% = 3 and id@ = ..SWT000 then
    stoptim timid@
  else if id@ = ..SWT001 then
    closetim timid@
  end if
end evnt

```

COLOR

Statement

Function	The COLOR statement sets the color, type, and size of a straight line or a dot.
Format	COLOR display-color, line-type, line-thickness or dot-size
Example of Use	COLOR 1, 0, 2
Description	<ul style="list-style-type: none"> • The COLOR statement sets the colors, types, and sizes of a straight line and a dot. The values specified in the LINE and DOT statements have priority over those to be specified in this statement. • display-color indicates the display color of the straight line or dot. Specify this display color with a numeric value from 0 to 15. The specified display color becomes the color pallet number of the tool. • line-type indicates the type of line to be drawn (for example, solid line and dotted line). Specify this line type with a numeric value from 0 to 3. For the types of line, see “Plotting” to “Straight Line” of the tool. • line-thickness indicates the thickness of the line. dot-size indicates the size of the dot. Specify both the line thickness and dot size with a numeric value from 0 to 2.
Related Item	LINE, DOT

Example of Program

```

conf
  color 1 , 0 , 3
end conf
evnt
  ....
  dot 100,200
  dot 100,300
  color 1 , 0 , 0
  line 100,200,100,300
  ....
end evnt

```

CONF ... END CONF

Statement

Function The CONF ... END CONF statements declare the configuration block area.

Format CONF

 END CONF

Example of Use CONF
 static VAR%
 END CONF

Description

- The configuration block written in a screen and a part is executed only once when the screen is displayed. This block is not executed when the screen is being displayed. It is executed once again when the screen is redisplayed after another screen has been displayed.
- The configuration block for global screens and parts is executed only once when the system is started.
- Initialization blocks (INIT) are used to write processing such as initialization.
- Only the configuration block for closed parts is not executed even if a screen is displayed. This configuration block is executed when a part is opened. (See "OPEN Instruction.")

Related Item EVNT ... END EVNT, INIT ... END INIT

Example of Program

```
CONF
  static moji$
END CONF
evnt
  input ty%, id@, dat$
end evnt
```

CONST

Statement

Function	The CONST statement declares a constant.
Format	CONST constant name = constant
Example of Use	CONST #MAX#=10
Description	<ul style="list-style-type: none">• The constant name should be enclosed in a pair of # marks according to the variable name generation rule.• If a constant is declared in a program, the constant name is replaced with a declared constant value.• The CONST statement cannot be used in a global screen program.• Constant declaration is one of the new features of Screen Creator 5.

Related Item

Example of Program

```
conf
  global L%
  const #MAXLENGTH#=100
  if L > #MAXLENGTH# then
    L = #MAXLENGTH#
  end if
end conf
```

CONTTIM

Statement

Function	The CONTTIM statement restarts the stopped timer.
Format	CONTTIM timer-number
Example of Use	CONTTIM TIMID@ CONTIM 4
Description	<ul style="list-style-type: none"> • The CONTTIM statement restarts the timer stopped by the STOPTIM instruction. The internal counter in the timer is continued from the timer stop status. • timer-number indicates the number of the timer to be restarted. Whether the timer number is an ID- or integer-type value depends on how the timer is opened. (See “OPENTIM”, “OPENTIM2”, and “OPENTIM3.”)
Related Item	OPENTIM, OPENTIM2, OPENTIM3, STARTTIM, STOPTIM, CLOSETIM, SETTIM, READTIM

Example of Program

```

conf
  static timid@
  opentim2(3)
  settim 3, 20, 0
  starttim 3
end conf
evnt
  input type% , id@ , data%
  if type% = 3 and id@ = ..SWT000 then
    stoptim 3
  else if id@ = ..SWT001 then
    conttim 3
  end if
end evnt

```

COPY

Statement

Function	The COPY statement makes a hardcopy of a screen.
Format	COPY color-number
Example of use	COPY 5
Description	<ul style="list-style-type: none">• The COPY statement makes a hard copy of a displayed screen. In the "Color Number" field, a color specified on the color palette of Screen Creator 5 is printed black.• If color palette number 16 is specified, in addition to color palette numbers from 0 and 15, colors of even color palette numbers are printed black. If 17 is selected, the print colors of number 16 are inversed, i.e., colors of odd color palette numbers are printed black.• If an even color palette number is specified in monochrome printing, the print color is the same as in the case where color palette number 2 is selected. If an odd color palette number is specified, the print color is the same as in the case where color palette number 1 is selected.• The "Color Number" can be specified only when "Select Color" is selected in "Screen Print Mode" of "Printer Setup" of "System Setup" on the OIP system screen.

Related Item

Example of Program

```
evnt
  input ty%,id@
  if id@ = ..SWT000 then COPY 8
end evnt
```

COS

Function

Function The COS function calculates a cosine for the specified numerical expression.

Format COS (numerical-expression)

Example of Use X = COS (ANGLE)

Description The COS function calculates a cosine value for the specified numerical expression. The unit for the numerical expression is radian.

Related Item ATN, SIN, TAN

Example of Program

```
evnt
  angle = 3.141592/3
  x = COS ( angle )
end evnt
```

CURDIR

Statement

Function	The CURDIR statement makes a character string indicating the current directory path name into a character string variable.
Format	CURDIR character string variable
Example of Use	CURDIR PATH\$
Description	A full path name including a drive name should be written.
Related Item	DIR,CHDIR,MKDIR,RMDIR

Example of Program

```
conf
  strdsp ..str, "curdir"
end conf
evnt
  input type%, id@, data%
  if data% = 1 then
    curdir path$
    strdsp .dsp.str, path$
  end if
end evnt
```

CVB

Function

Function The CVB function allocates data from any position of a character string variable.

Format CVB (character-string-variable-name, allocation-position)

Example of Use VAR% = CVB (MOJI\$, 5)

Description

- The CVB function allocates data one byte from the specified allocation- position of the specified character variable name. The allocated data is regarded as an integer value.
- allocation-position must be an integer- or floating-point-type variable or constant. 1 specifies the beginning of the character string variable.

Related Item MKS, MKB, MKW, MKI, MKF, MKID, CVW, CVI, CVF, CVID

Example of Program

```

conf
end conf
evnt
  org$ = ``1234567``
  data% = CVB ( org$, 3 )
  numdsp ..NUM000, data%      ' Displays 51(&H33).
end evnt

```

CVF

Function

Function	The CVF function allocates data from any position of a character string variable.
Format	CVF (character-string-variable-name, allocation-position)
Example of Use	VAR = CVF (MOJIS, 5)
Description	<ul style="list-style-type: none"> • The CVF function allocates data four bytes from the specified allocation- position of the specified character variable name. The allocated data is regarded as a real value. • allocation-position must be an integer- or floating-point-type variable or constant. 1 specifies the beginning of the character string variable. • The CVF function returns a real number. • A cut-out value is converted into a 86 series boundary.
Related Item	MKS, MKB, MKW, MKI, MKF, MKID, CVB, CVW, CVI, CVID

Example of Program

```

conf
end conf
evnt
  org$ = ``1234567``
  strdsp ..STR000, org$
  mkf org$, 2, 1.23
  strdsp ..STR001, org$      ' The character string will not be displayed correctly.
  data% = CVF ( org$, 2 )
  numdsp ..NUM000, data%    ' Displays 1.23.
end evnt

```

CVI

Function

Function The CVI function allocates data from any position of a character string variable.

Format CVI (character-string-variable-name, allocation-position)

Example of Use VAR% = CVI (MOJI\$, 5)

Description

- The CVI function allocates data four bytes from the specified allocation- position of the specified character variable name. The allocated data is regarded as an integer value.
- allocation-position must be an integer- or floating-point-type variable or constant. 1 specifies the beginning of the character string variable.
- A cut-out value is converted into a 86 series boundary.

Related Item MKS, MKB, MKW, MKI, MKF, MKID, CVB, CVW, CVF, CVID

Example of Program

```

conf
end conf
evnt
  org$ = ``1234567``
  data% = CVI ( org$, 3 )
  numdsp ..NUM000, data%      ' Displays &H36353433.
end evnt

```



CVID

Function

Function	The CVID function allocates data from any position of a character string variable.
Format	CVID (character-string-variable-name, allocation-position)
Example of Use	VAR@ = CVID (MOJI\$, 5)
Description	<ul style="list-style-type: none"> • The CVID function allocates data six bytes from the specified allocation- position of the specified character variable name. The allocated data is regarded as an ID value. • allocation-position must be an integer- or floating-point-type variable or constant. 1 specifies the beginning of the character string variable. • The CVID function returns an ID-type value. • A cut-out value is converted into a 86 series boundary (by 2 bytes).
Related Item	MKS, MKB, MKW, MKI, MKF, MKID, CVB, CVW, CVI, CVIF

Example of Program

```

conf
end conf
evnt
  org$ = ``1234567``
  data@ = CVID ( org$, 1 )
end evnt

```

CVW

Function

Function	The CVW function allocates data from any position of a character string variable.
Format	CVW (character-string-variable-name, allocation-position)
Example of Use	VAR% = CVW (MOJI\$, 5)
Description	<ul style="list-style-type: none"> • The CVW function allocates data two bytes from the specified allocation-position of the specified character variable name. The allocated data is regarded as an integer value. • allocation-position must be an integer- or floating-point-type variable or constant. 1 specifies the beginning of the character string variable. • A cut-out value is converted into a 86 series boundary.
Related Item	MKS, MKB, MKW, MKI, MKF, MKID, CVB, CVI, CVF, CVID

Example of Program

```

conf
end conf
evnt
  org$ = ``1234567``
  data% = CVW ( org$, 3 )
  numdsp ..NUM000, data%      ' Displays &H3433.
end evnt

```

CYCLIC

Statement

Function	The CYCLIC statement declares that the contents of the specified device or memory table are periodically read.
Format	CYCLIC device-name, device-name, device-name, *number CYCLIC memory-table-name, memory-table-name, memory-table-name, *number
Example of Use	CYCLIC 00~D01, 00~D10 * 5 CYCLIC 00~MTBL(100), 00~MTBL(200) * 10
Description	<ul style="list-style-type: none">• The CYCLIC statement periodically reads the contents of the declared PLC device through communication. If the previously read contents do not match the contents read by this statement (change of contents), a messages is transmitted to the declaring operation program. This statement never operates during execution of the operation program because it makes a declaration.• This declaration must be made before the device is used in the program.• Communication occurs when data is read from the device (example: A=00~D0001) for which CYCLIC is not declared.• To declare CYCLIC for the memory table, the table number must be specified with an integer value.• In the cyclic operation of the memory table, a message is issued when data is written from the host computer or operation program to the memory table. (This message is issued even if the contents do not change.)• Specifying “*number” following device-name or memory-table-name enables CYCLIC to be continuously declared.• When the screen is switched, a message is issued to all the parts for which CYCLIC is declared.
Related Item	INPUT

Example of Program

```
conf
  cyclic 00~d01 , 00~d4 * 3
  cyclic 00~mtbl(20), 00~mtbl(100)
end conf
evnt
  input ty%,id@,dat%
  if id@ = 00~mtbl(20) then
    numdsp ..num , dat%
  end if
  .....
end evnt
```

CYCLIC2

Statement

Function	The CYCLIC2 statement declares that the contents of the specified device are periodically read as a doubleword.
Format	CYCLIC2 device-name, device-name, device-name, *number
Example of Use	CYCLIC2 00~D01, 00~D10 * 5
Description	<ul style="list-style-type: none"> • The CYCLIC2 statement is the same as the CYCLIC statement except that the contents of the device are read as a doubleword. • The word having a larger device number is the high-order word. • No memory table can be declared. • When the screen is switched, a message is issued to all the parts for which CYCLIC2 is declared.
Related Item	INPUT, CYCLIC

Example of Program

```

conf
  cyclic2 00~d01 , 00~d7 * 3
end conf
evnt
  input ty%,id@,dat%
  if id@ = 00~d01 then
    numdsp ..num , dat%
  end if
  .....
end evnt

```

DATE\$

Function

Function	The DATE\$ function reads the current date.
Format	DATE\$
Example of Use	MOJI\$ = DATE\$
Description	<ul style="list-style-type: none"> • The year, month, and day of the current date to be read are each represented in two digits like YY/MM/DD. • The DATE\$ function cannot be used to set a date. • Once date is set using the SETDATE command in a model with a battery backup calendar IC (GC56LC or GC55EM), the date is updated even while the power is off. If a model with no calendar IC (GC53LC or GC53LM) is turned off, the date is initialized to 98-01-01 and the time to 00:00:00 when it is turned on again. The date and time are updated while the power is on.
Related Item	GETDATE,GETTIME,SETDATE,SETTIME,TIME\$

Example of Program

```

conf
    moji$ = DATE$
    strdsp ..STR000 , moji$
end conf

```

DECLARE

Statement

Function	The DECLARE statement declares a function.
Format	DECLARE function name [type declaration character](variable declaration[, variable declaration] ...)
Example of Use	DECLARE ADD\%(A\%,B\%)
Description	<ul style="list-style-type: none">• The DECLARE statement declares a type of a function used in a program. (Such declaration is called prototype declaration.)• A function itself is declared in one of the three manners as shown below:<ul style="list-style-type: none">- Local function: Defined in a program other than a global screen program.- Global function: Defined in a global screen program.- Library function: Defined in a library.• The declared type of a function (in the prototype declaration) must be the same as the type of the function itself.• This is one of the new features of Screen Creator 5.
Related Item	FUNCTION, FUNCTIONCHECK

Example of Program

```
DECLARE my_add(a%,b%)
conf
  global x%,y%
  local sum%
  sum% = my_add(x%,y%)
end conf
```

DEV RD

Statement

Function	The DEV RD statement reads the contents of the specified device.
Format	DEV RD device-name, offset-value, variable-name
Example of Use	DEV RD 00~D10, 10, VALUE%
Description	<ul style="list-style-type: none"> • The DEV RD statement reads data from the device that is offset-value away from the device specified in device-name. • offset-value specifies the distance from the device specified in device-name. The DEV RD statement reads data from the device corresponding to the specified distance. offset-value must be an integer- or floating-point-type variable or constant. • variable-name specifies the variable that stores the read data; it must be an integer- or floating-point-type variable. • The DEV RD statement is used for the device (e.g., CYCLIC 00~D10 * 10) where “continuous cycle” is declared in the CYCLIC or CYCLIC2 statement. • If the device from which data is to be read does not exist, an error occurs. • Be sure to use this command in an event block. The value 0 is set in the variable, since an initialization block or configuration block is executed before reading device data.
Related Item	CYCLIC, EVENTWR, DEVWR

Example of Program

```

conf
  cyclic 00~D10 * 5      ' Declares that data is read from the device that is 5
end conf                ' away from D10.
evnt
  input type% , id@ , data%      ' Reads and displays the continu-
  if id@ = ..SWT000 and data% = 1 then ' ous device value when a switch
    for i% = 0 to 4              ' is pressedfor the continuous-
      id@ = getid ( ..NUM000, i%+1) ' stage numeric display.
      DEV RD 00~D10, i% , data%
      numdsp ..NUM000, data%
    next
  endif
end evnt

```

DEVWR

Statement

Function	The DEVWR statement writes data to the specified device.
Format	DEVWR device-name, offset-value, write-value
Example of Use	DEVWR 00~D10, 10, 5
Description	<ul style="list-style-type: none"> • The DEVWR statement writes data to the device that is offset-value away from the device specified in device-name. • offset-value specifies the distance from the device specified in device-name. The DEVWR statement writes data to the device corresponding to the specified distance. offset-value must be an integer- or floating-point-type variable or constant. • write-value specifies the data to be written to the specified device; it must be an integer- or floating-point-type variable or constant. • The DEVWR statement is used for the device (e.g., EVENTWR 00~D10 * 10) where “continuous write” is declared in the EVENTWR statement. • If the device to which data is to be written does not exist, an error occurs.
Related Item	CYCLIC, EVENTWR, DEVRD

Example of Program

```

conf
    eventwr 00~D10 * 5      ' Declares that data is to be written to the device that is
end conf                  ' 5 away from D10.
evnt
    input type% , id@ , data%      '          Writes 10 to the
device whose              '
    DEVWR 00~D10, data% , 10      '          offset value is
data%.
end evnt

```

DIM

Statement

Function	The DIM statement defines an array.
Format	DIM variable-name (maximum-subscript-value [, maximum-subscript-value] ...)
Example of Use	DIM ABC\$(20), XYZ%(4,4,3), LOC!
Description	<ul style="list-style-type: none"> • The DIM statement defines the variable defined in variable-name as an local variable. • A local variable can be read and written only in a program where it is declared. The compiler gives a warning if an undefined local variable is used. Each local variable is initialized every time the block is executed. • If a variable has a subscript enclosed in parentheses, an arrangement variable is declared. • The number of maximum subscript values in parentheses indicates that of array dimensions. In arrays of two dimensions or higher, subscripts are specified, delimited by a comma (,). • maximum-subscript-value indicates the maximum value of subscript that can be specified. The subscript starts at 0. • A variable can be used as an array variable even if it is not declared in the DIM statement. In this case, the maximum value of the subscript is 10. • When a character variable is declared in an array, the element size can be declared. • Defining many arrays makes it impossible to display many screens because the OIP work area becomes small. • Screen Creator 5 has a new function for declaring local variables other than arrangement variables distinctively. • The DIM statement is provided to maintain the compatibility with GCSGP3. Use LOCAL, instead of DIM, to declare a local variable. • When a DIM statement is used to declare an arrangement variable, compatibility with GCSGP3 is maintained.
Related Item	AUTO, BACKUP, GLOBAL, LOCAL, STATIC, STRING

Example of Program

```
conf
  DIM FLOAT(10),ID@(5),MOJI$(10) * 40
  for i% = 1 to 5
    FLOAT(i%) = i*3
  next
end conf
```

DIR

Function

Function The DIR function makes a list of directory or file data into character string variables and returns the number of created data (i.e., the number of entries in the directory or file).

Format DIR (directory name, file attribute value, offset value, and character string variable)

Example of Use NUM% = DIR("A:SUBDIR", &H20, 6, LIST\$)

- Description**
- A directory name can be specified in a full path name including a drive name or in an abbreviated name beginning with a current directory name.
Example: A:\SUBDIR1\SUBDIR2 SUBDIR2\SUBDIR3
 - A file name, instead of a directory name, should be specified to create data of a single file.
 - A file attribute value for selecting data to be created should be specified in a logical OR of the flags shown below:
&H01: Read-only file
&H02: Hidden file
&H04: System file
&H08: Volume label
&H10: Sub-directory
&H20: Standard file
 - An offset value is specified in order to exclude the first "n" data from data to be created.
 - Each created data consists of a 40-byte record of the fixed length. It is followed by detailed data as shown below:

Name	Extension	Size	Day of updating	Time of updating
DISK_1	.	<VOL>	87-01-15	15:25
SAMPLE	.EXE	98765	92-11-03	9:12
ABCDEFGF	.	123456	94-03-21	11:34
TEST2	.C	256	93-05-05	12:07
DOWNLOAD	.OIP	<DIR>	87-02-14	21:13
KBASIC	.	<DIR>	93-12-24	8:25
DATA_007	.	32	89-10-10	10:42

In this example, seven data are created in character strings of 280 bytes in all. The label is shown for convenience only.

The number of data to be created depends on the size of the character string variable. As much data as possible is created.

Related Item DIR,CHDIR,MKDIR,RMDIR

Example of Program

```
conf
  global dname$(13), pname1$(13), pname2$(13)
  global dsel%, p1sel%, p2sel%
  static list$*2000
  strdsp ..str, "dir"
end conf
evnt
  input type%, id@, data%
  if data% = 1 then
    path$ = dname$(dsel%) + pname1$(p1sel%) + pname2$(p2sel%)
    strdsp .dsp.str, path$
    num% = dir(path$, &H3F, 0, list$)
    strdsp .dsp.str, list$
    numdsp ..num000,num%
  end if
end evnt
```

DINV

Statement

Function	Inverses the color in a specified screen area.
Format	DINV upper-left-X-coordinate, upper-left-Y-coordinate, lower-right-X-coordinate, lower-right-Y-coordinate
Example of Use	DINV 10, 10, 30, 30
Description	<ul style="list-style-type: none"> • Inverses the color in a rectangular area having opposite points of specified coordinates. • The upper left corner of the panel has the coordinates (0, 0). The horizontal direction (toward the right) corresponds to the X axis, and the vertical direction (toward below) corresponds to the Y axis. • Color is inverted as shown below. In color display, the palette values (0 to 15) are inversed. In other words, 0 is changed into 15, 1 is changed into 14, 7 is changed into 8, and so forth. In monochrome display, activated color is changed into deactivated color, deactivated color is changed into activated color, and transparent color is changed into activated color. • If this is used in an initialization block or configuration block, drawing is executed after executing this block and accordingly color is not inversed. Be sure to use this in an event block.
Related Item	None

Example of Program

```

evnt
  input ty,id@,dat
  if ty = 3 and id@ = ..SWT000 then
    DINV 0,0,639,399
  endif
end evnt

```

DOT

Statement

Function	The DOT statement displays dots on a screen.
Format	DOT X1, Y1
Example of Use	DOT 20,300
Description	<ul style="list-style-type: none">• The DOT statement displays a dot in the specified coordinate (X1,Y1).• X1 must be a numeric value from 0 to 639. Y1 must be a numeric value from 0 to 399 (GC55EM) or 0 to 479 (GC56LC).• Dots are directly displayed as the background of a screen. When a part is opened or closed in the area where dots are displayed or when a control is displayed, the dots may be cleared. The cleared dots are not redisplayed.• The size and color of a dot are specified by the COLOR statement.• If this is used in an initialization block or configuration block, drawing is executed after executing this block and accordingly points are not plotted. Be sure to use this in an event block.
Related Item	COLOR

Example of Program

```
conf
  color 1 , 0 , 3
end conf
evnt
  ....
  dot 100,200
  dot 100,300
  color 1 , 0 , 0
  line 100,200,100,300
  ....
end evnt
```

DSPMODE

Statement

Function	The DSPMODE statement changes the display mode of the control.
Format	DSPMODE control-name, display-mode
Example of Use	DSPMODE ..NUM000, 2
Description	<ul style="list-style-type: none">• The DSPMODE statement is a command that changes the display mode of the control.• control-name is the control name or the ID-type variable indicating control name.• control-mode specifies the mode in which the control is displayed. The display mode is specified with any of the following numeric values:<ul style="list-style-type: none">0: Normal display mode1: Inverse display mode2: Blink display mode. (The display color is replaced with the background color.)3: On-and-off display mode. (The display status and nondisplay status are repeatedly displayed.)
Related Item	NUMDSP, STRDSP, FIGDSP, SLDDSP, MTRDSP, FREDSP, PLTDSP, BARDSP, BLTDSP, CIRDSP, LNE DSP

Example of Program

```
evnt
  input ty,id@,data
  if id@ = ..SWT000 then
    DSPMODE ..NUM000 , 3
  endif
end evnt
```

EOF

Function

Function	The EOF function checks whether the end of the file was reached.
Format	EOF (file-number)
Example of Use	AAA = EOF (file-number)
Description	<ul style="list-style-type: none"> • <code>file-number</code> specifies the number of the file for which whether the end of the file was reached is to be checked. This file number must match the number of the file opened by the FOPEN statement. • Return value 1 indicates that the end of the file was reached. Return value 0 indicates that the end of the file is not reached.
Related Item	FOPEN, FIELD, FCLOSE, FPUT, FGET

Example of Program

```

conf
  field 5
    global no%
    global moji1$ , moji2$
  end field
  global sum%
  fopen ``C:TEST'', 2 , 5
  .....
end conf
evnt
  while EOF(5) = 0
    fget 5, i
    numdsp ..NUM000, no%
    strdsp ..STR000, moji1$
    strdsp ..STR001, moji2$
  wend
  fclose (5)
end evnt

```

ERRCTL

Statement

Function	The ERRCTL statement controls the error number display position.
Format	ERRCTL mode
Example of Use	ERRCTL 0
Description	<ul style="list-style-type: none"> • The ERRCTL statement controls the error number display position. • The error display position conforms with the value specified in mode. <ul style="list-style-type: none"> When mode is 0: An error number is displayed below a screen. When mode is 1: A message is issued to the error display. <ul style="list-style-type: none"> – When mode is 1, messages of error numbers 4000 to 4499 and 5000 to 5999 are issued to the error display (part ERRPTS on global screen). – Messages of error numbers 2000 to 2999 are issued only to the error display. – Following the type and issuer ID of an error, the error code, the number of the screen where the error occurred, and the number of the part where the error occurred are issued to the error display. (If a screen program error occurs, -1 is set as the part number.) – If part ERRPTS does not exist in the global screen, the error is displayed in the lowest line of the window screen.

Related Item ERRSTAT

Example of Program

```

evnt
  input ty%,id@,dat%
  if id@ = ..sw1 then
    if errstat () = 1 then
      errctl 0
    else
      errctl 1
    endif
  endif
end evnt

```

ERRSTAT

Function

Function	The ERRSTAT function reads the error display position.
Format	ERRSTAT
Example of Use	ERRSTAT()
Description	<ul style="list-style-type: none">• The ERRSTAT function reads the current error display position.• When this function is executed, any of the following numeric values indicating the display position is returned:<ul style="list-style-type: none">When 0 is returned, the error is displayed below the screen.When 1 is returned, the error is displayed in the error display.
Related Item	ERRCTL

Example of Program

```
evnt
  input ty%,id@,dat%
  if id@ = ..sw1 then
    if errstat () = 1 then
      errctl 0
    else
      errctl 1
    endif
  endif
end evnt
```

EVENTWR

Statement

Function The EVENTWR statement declares the device(s) to which data is to be written.

Format EVENTWR device-name, device-name, device-name *number,,,

Example of Use EVENTWR 00~D01, 00~D10 * 5

Description

- The EVENTWR statement declares the device(s) in a part or screen to which data is to be written. This statement only declares the devices to which data is to be written; it does not actually write data to the devices.
- Specifying *number enables two or more devices to be continuously declared. This continuous declaration, however, does not mean that data is written to all the declared devices at a time.
- The DEVWR statement is used to actually write data to the declared devices.
- The devices to which data is to be written must be declared before the DEVWR statement is executed.

Related Item CYCLIC, DEVRD, DEVWR

Example of Program

```

conf
    EVENTWR 00~D10 * 5
end conf
evnt
    input type% , id@ , data%
    devwr 00~D10, data% , 10
end evnt

```

' Declares that data is to be written to
' five devices from D10.

' Writes 10 to the device whose offset
' value is data%.



EVNT ... END EVNT

Statement

Function	The EVNT...END EVNT statements declares the event block area.
Format	EVNT END EVNT
Example of Use	EVNT input ty,id@,data END EVNT
Description	<ul style="list-style-type: none"> The event block is a program block that operates when it receives a message. The contents executed when a switch is pressed or a message is received are written in these statements.
Related Item	CONF ... END CONF, INIT ... END INIT

Example of Program

```

conf
    static moji$
end conf
evnt
    input ty%, id@, dat$
end evnt

```

EXECPRCODE

Statement

Function	The EXECPRCODE statement executes primitive data operation.
Format	EXECPRCODE control-name, type, operation-data, variable-name
Example of Use	EXECPRCODE ..NUM000, 0, 20, VAR%
Description	<ul style="list-style-type: none"> • When a control in a part is used to validate an operation parameter, the EXECPRCODE statement executes data operation set in the part operation parameter specification. • type is usually 0. When the specified primitive is the plot display and type is 0, the EXECPRCODE statement executes X data operation. When type is 1, the statement executes Y data operation. • control-name must be the control in the local part. • operation-data specifies the value to be operated; it must be an integer- or floating-point-type variable or constant. • variable-name specifies the variable to which the operation result is to be written; it must be an integer- or floating-point-type variable. • If no operation code is written in the specified control, the value specified in operation-data is set in the specified variable.
Related Item	None

Example of Program

```

conf

end conf
evnt
  input type% , id@ , data%
  EXECPRCODE ..NUM000, 0, data%, data1%
  numdsp ..NUM001, data1%
end evnt

```

EXIT FUNCTION

Statement

Function	The EXIT FUNCTION statement exits a function forcedly.
Format	EXIT FUNCTION
Example of Use	FUNCTION DIV%(A%,B%) IF B%=0 THEN EXIT FUNCTION DIV%=A%/B% END FUNCTION
Description	<ul style="list-style-type: none">• The EXIT FUNCTION statement gives an instruction to exit a function forcedly in a function block where the function itself is defined and returns the control to the side which called the function.• This statement is one of the new features of Screen Creator 5.
Related Item	DECLARE, FUNCTION, FUNCTIONCHECK

Example of Program

```
declare my_div%(a%,b%)
conf
  global x%,y%
  local share%
  share% = my_div(x%,y%)
end conf
function my_div%(a%,b%)
  if b%=0 then EXIT FUNCTION
  my_div%=a%/b%
end function
```

EXP

Function

Function	The EXP function calculates the value of an exponential function for the base of a natural logarithm.
Format	EXP (numerical-expression)
Example of Use	VAR = EXP (A/2)
Description	The EXP function returns the result of exponent operation for the base (E) of the natural logarithm.
Related Item	LOG

Example of Program

```
evnt
  input ty,id@,data
  if ty = 3 then
    numdsp ..NUM000, EXP(10)
  else
    numdsp ..NUM000, EXP(5)
  endif
end evnt
```



FCLOSE

Statement

Function	The FCLOSE statement closes the specified file.
Format	FCLOSE file-number
Example of Use	FCLOSE 5
Description	<ul style="list-style-type: none"> • The FCLOSE statement closes the file specified by file-number. • file-number must match the number of the file opened by the FOPEN statement to be explained later. If another file number is specified, an error occurs. Specify file-number directly with a numeric value from 1 to 16.
Related Item	FOPEN, FIELD, FPUT, FGET

Example of Program

```

conf
  field 5
    global no%
    global moji1$ , moji2$
  end field
  fopen ``MEMORY``, 2 , 5
  .....
end conf
evnt
  .....

  FCLOSE 5
end evnt

```

FGET

Statement

Function	The FGET statement reads data from the specified file.
Format	FGET file-number, record-number
Example of Use	FGET 5, 3
Description	<ul style="list-style-type: none"> • The FGET statement reads the contents of the specified record (record-number) in the specified file (file-number) into the variable group declared by FIELD...END FIELD. • file-number specifies the number of the file to be read. This file number must match the number of the file opened by the FOPEN statement. • record-number specifies which record in the file is to be read first. In this case, the variable group included in FIELD declared in file-number is used as one unit. record-number is 1 when data is read from the beginning of the file.
Related Item	FOPEN, FIELD, FCLOSE, FPUT

Example of Program

```

conf
  field 5
    global no%
    global moji1$ , moji2$
  end field
  fopen ``MEMORY``, 2 , 5
  .....
end conf
evnt
  FGET 5 , 3
  numdsp ..NUM000 , no%
  strdsp ..STR000 , moji1$
  strdsp ..STR001 , moji2$
  fclose 5
end evnt

```

FIELD ... END FIELD

Statement

Function	FIELD ... END FIELD sets a file read/write unit.
Format	FIELD file-number variable-list variable-list END FIELD
Example of Use	FIELD 5 global abcd , xyz% static dddd(10,10) backup moji\$ END FIELD
Description	<ul style="list-style-type: none"> • FIELD ... END FIELD declares the unit for reading the file by the FGET statement or that for writing the file by the FPUT statement. • file-number specifies the number of the file onto or into which the variable group in the field is to be written or read. This file number must match the number of the file opened by the FOPEN statement; it is a value from 1 to 16. • The variable list that can be written between FIELD and END FIELD must be the GLOBAL, STATIC, or BACKUP variable. The method for declaring variable lists is the same as that for declaring the GLOBAL, STATIC, and BACKUP variables. • The FIELD declared in the program where the FOPEN statement was executed is the default read/write unit. • When a file is read or written by a part that differs from the part opened by the FOPEN statement, the FIELD declared in that part is used. If this FIELD is not declared, the default FIELD is used. • If two or more FIELDS are declared in the same file-number in one program, the last declared FIELD is valid. • FIELD ... END FIELD cannot be written in the global screen program.
Related Item	FOPEN, FCLOSE, FPUT, FGET

Example of Program

```
conf
  field 5
    global no%
    global moji1$ , moji2$
  end field
  fopen ``MEMORY'', 2 , 5
```

```
.....  
end conf  
evnt  
  no% = 1  
  moji1$ = ``product-name``  
  moji2$ = ``product-number``  
  fput 5 , 3  
  fclose 5  
end evnt
```

FIGCOLOR

Statement

Function	The FIGCOLOR statement changes the tile and colors of the graphic display.
Format	FIGCOLOR control-name, tile, display-color, background-color
Example of Use	FIGCOLOR .B000.FIG000, 1, 2, 3
Description	<ul style="list-style-type: none"> • The FIGCOLOR statement changes the tile and colors of the the graphic display. -1 indicates that the color and tile for which -1 was specified remain unchanged. • control-name is the graphic display name or the ID-type variable indicating the graphic display. • tile indicates a tiling figure. Specify this tiling figure with a numeric value from 0 to 15. • display-color is a numeric value indicating the color number of the tile display section. Specify this color number with a numeric value from 0 to 15. • background-color is a numeric value indicating the color number of the tile background section. Specify this color number with a numeric value from 0 to 15.
Related Item	FIGDSP

Example of Program

```

evnt
  input type%, id@, tile%
  FIGCOLOR ..FIG000, tile%, -1, -1
end evnt

```

FIGDSP

Statement

Function	The FIGDSP statement texture the graphic specified in the graphic display.
Format	FIGDSP control-name, texture-name
Example of Use	FIGDSP .B000.FIG000, SWFIG
Description	<ul style="list-style-type: none"> • The FIGDSP statement displays the texture specified in the texture display. This texture name must be the one created by the plotting tool. • control-name is the graphic display name or the ID-type variable indicating the graphic display. • texture-name is the variable indicating the name or ID of the texture to be displayed in the texture display or the registered graphic number (integer type). • display-value cannot be changed even if this statement is issued to the display for which operation parameters are set to “effective” in the control.
Related Item	FIGCOLOR, FIGFORM

Example of Program

```

evnt
  input ty , id@, figno%
  FIGDSP ..FIG000 , figno%
end evnt

```

FIGFORM

Statement

Function	The FIGFORM statement changes the display format of the texture display.
Format	FIGFORM control-name, resize-specification
Example of Use	FIGFORM ..HYOJIKI, 0
Description	<ul style="list-style-type: none"> • When the size of the texture display differs from that of the texture to be control in the control, the FIGFORM statement specifies whether to perform resize (magnification/reduction). Resize is performed to make the size of the texture to be displayed match that of the texture display. • control-name is the graphic display name or the ID-type variable indicating the graphic display. • The integer-type value indicating whether to perform resize is set in resize-specification. <ul style="list-style-type: none"> 0: Resize is not performed. 1: Resize is performed.
Related Item	FIGCOLOR, FIGDSP

Example of Program

```

evnt
  input ty , id@, data
  if ty = 3 and data = 1 then
    FIGFORM ..FIG000, 1
  else
    FIGFORM ..FIG000, 2
  endif
  figdsp ..FIG000, figno
end evnt

```

FINPUT

Statement

Function	The FINPUT statement reads data from the specified file.
Format	FINPUT file-number, variable, variable, ...
Example of Use	FINPUT 12, VAR% , STRING\$
Description	<ul style="list-style-type: none"> • The FINPUT statement reads data from the file specified by file-number into the specified variable. • A numeric or character string variable can be specified in variable. • The following delimiters can be used when data is read into the specified variable. They are not included in the variable. <ul style="list-style-type: none"> – Only comma “,” and carriage return (CR) can be used as delimiters. Line feed (LF) following CR is ignored. – When a numeric variable is specified, a blank can also be used as a delimiter. – When a character string variable is specified, the character string between double quotation marks (“”) is to be read. – If the type of data written to the specified file does not match that of the specified read variable, the contents of the variable are undefined. • file-number must match the number of the file opened by the FOPEN statement.
Related Item	FOPEN, FCLOSE, FPRINT, FWRITE, LINPUT

Example of Program

```

conf
  fopen  ``C:TEST``, 2 , 5
end conf
evnt
  var% = -2
  fwrite 5, 123, var%, ``ABCD``, ``XYZ``
  fseek(5, 0, 0)
  finput 5, VAR1%, VAR2%, VSTR1$, VSTR2$
end evnt

```

Data is written to the specified file as follows:

```
123,-2,``ABCD``,``XYZ`` CR/LF
```

When data is read, the variables change as follows:

VAR1%	123	VSTR1\$	ABCD
VAR2%	-2	VSTR2\$	XYZ

FLUSH

Statement

Function	The FLUSH statement returns the write position of a non-procedural communication reception buffer to the beginning of the variable.
Format	FLUSH port-number
Example of Use	FLUSH 2
Description	<ul style="list-style-type: none"> • The FLUSH statement enables received data to be written from the beginning of the variable to which the write position of the non-procedural communication reception buffer was returned. • port-number specifies the port (CH1 to CH3) to be flushed with a value from 1 to 3. • Execute the FLUSH statement when a reception completion message is received. Unless the FLUSH statement is executed, the reception buffer may become full. This statement only returns the write position of the reception buffer to the beginning of the variable; it does not clear data in the buffer. • The port to be flushed must be opened in advance by the OPENSIO statement to be explained later.
Related Item	OPENSIO, CLOSESIO, WRITESIO, WRITWSIOB, SETSIO

Example of Program

```

conf
  global buf$ * 200
  opensio 2 , 1 , buf$
  setsio 2 , &HD
end conf
evnt
  strdsp ..STR000 , buf$
  FLUSH 2
  closesio 2
end evnt

```

FOPEN

Statement

- Function** The FOPEN statement opens the specified file.
- Format** FOPEN file-name, mode, file-number
- Example of Use** FOPEN "MEMORY", 2, 5
- Description**
- The FOPEN statement opens the file to be read or written.
 - **file-name** specifies the name of the file to be opened. The file having the name enclosed in double quotation marks is to be opened. Specify the name of the file to be opened with up to eight characters. When MEMORY is specified in file-name, internal memory is handled as a file. (Currently, only "MEMORY" can be specified in file-name.)
 - **mode** specifies the type of the file to be opened with one of the following numeric values:
 - 0: Read-only file
 - 1: Write-only file
 - 2: Read/write file
 When file-name is "MEMORY", the read/write file is opened regardless of what value is specified in mode.
 - **file-number** is used when a file is read or written or when a record is set. Specify file-number directly with a numeric value from 1 to 16; it cannot be specified by a variable.
 - To handle internal memory as a file, the capacity of that memory must be set on the system mode screen in advance.
 - Attempting to execute the FOPEN statement for an unformatted file causes an error.

Related Item FCLOSE, FIELD, FPUT, FGET, FORMAT

Example of Program

```

conf
  field 5
    global no%
    global moji1$ , moji2$
  end field
  FOPEN ``MEMORY'', 2 , 5
  .....
end conf
evnt
  .....
end evnt

```

FOR ... TO ... NEXT

Statement

Function	The instructions between the FOR statement and NEXT statements are repeatedly executed by the specified count.
Format	FOR variable-name = start-value TO end-value [STEP increment] ... NEXT
Example of Use	FOR I = 1 TO 10 A(I) = 3 NEXT
Description	<ul style="list-style-type: none">• variable-name after the FOR statement specifies the variable used to count how many times the FOR to NEXT loop is repeated. variable-name must be an integer- or floating-point-type variable.• start-value indicates the initial value. The value of the variable increases by the value specified in increment each time the FOR to NEXT loop is repeated. (No negative value can be specified in increment.) When the increased value of the variable is greater than end-value, the statement following the NEXT statement is executed.• One FOR to NEXT loop can be nested.
Related Item	WHILE ... WEND, SELECT CASE

Example of Program

```
conf
  static VAR%(10)
  for i% = 0 to 10
    VAR%(i%) = i% * 3
  next
end conf
```

FORMAT

Statement

Function	The FORMAT statement initializes (formats) the specified file.
Format	FORMAT file-name
Example of Use	FORMAT "A:"
Description	<ul style="list-style-type: none"> • file-name specifies the name of the file to be initialized. • "A:", "E:" or "MEMORY" can be specified as the drive name. • When "MEMORY" is specified in drive-name, the contents of the file are filled with 0. • Be sure to execute the FORMAT statement when using the file for the first time.
Related Item	FOPEN, FIELD, FCLOSE, FPUT, FGET

Example of Program

```

conf
  field 5
    global no%
    global moji1$ , moji2$
  end field
  global sum%
  FORMAT ``MEMORY``
  fopen ``MEMORY``, 2 , 5
  .....
end conf
evnt
  no% = 1
  moji1$ = ``product-name``
  moji2$ = ``product-number``
  fput 5 , 3
  fclose 5
end evnt

```

FPRINT

Statement

Function	The FPRINT statement writes data to the specified file.
Format	FPRINT file-number, expression, expression, ...
Example of Use	FPRINT 12, 100, "ABCD", VAR%, STRING\$
Description	<ul style="list-style-type: none"> • The FPRINT statement writes the numeric value, variable or character defined in <i>expression</i> to the file specified by <i>file-number</i>. • A numeric value, a character, or a numeric or character variable can be specified in <i>expression</i>. • A numeric expression is converted to a numeric string and written to the specified file. When the data to be written is positive, a blank is written before it. When the data is negative, a minus sign (-) is written before it. A blank is also written after the written numeric string. • When a character string is written, no delimiter is inserted. • <i>file-number</i> must match the number of the file opened by the FOPEN statement.
Related Item	FOPEN, FCLOSE, FPUT, WRITE

Example of Program

```

conf
  fopen  ``C:TEST``, 2 , 5
end conf
evnt
  var% = -2
  fprint 5, 123, 45, var%, ``ABCD``, ``XYZ``
end evnt

```

Data is written to the specified file as follows:

```

123   45  -2 ABCDXYZ ( indicates a blank.)

```

FPUT

Statement

Function	The FPUT statement writes data to the specified file.
Format	FPUT file-number, record-number
Example of Use	FPUT 5, 3
Description	<ul style="list-style-type: none"> • The FPUT statement writes the contents of the variable group declared by FIELD...END FIELD to the specified record (record-number) in the specified file (file-number). • file-number specifies the number of the file to be written. This file number must match the number of the file opened by the FOPEN statement. • record-number specifies the record in the file to which the contents of the declared variable group is to be written. In this case, the variable group included in FIELD is used as one unit. record-number is 1 when data is written to the beginning of the file.
Related Item	FOPEN, FIELD, FCLOSE, FGET

Example of Program

```

conf
  field 5
    global no%
    global moji1$ , moji2$
  end field
  fopen ``MEMORY``, 2 , 5
  .....
end conf
evnt
  no% = 1
  moji1$ = ``product-name``
  moji2$ = ``product-number``
  FPUT 5 , 3
  fclose 5
end evnt

```

FRECOLOR

Statement

Function	The FRECOLOR statement changes the tiles and colors of the free graph display.
Format	FRECOLOR control-name, tile-1, display-color-1, background-color-1, tile-2, display-color-2, background-color-2
Example of Use	FRECOLOR ..FRE000, 2, 1, 4, 5, 2, 1
Description	<ul style="list-style-type: none">• The FRECOLOR statement changes the tiles and colors of the free graph display and the background tiles and colors of the entire display. tile-1 indicates that the color and tile for which 1 was specified remain unchanged.• control-name is the free graph name or the ID-type indicating the free graph name.• tile-1 indicates the tiling figure of the tile display section. Specify this tiling figure with a numeric value from 0 to 15.• display-color-1 is a numeric value indicating the color number of the tile display section. Specify this color number with a numeric value from 0 to 15.• background-color-1 is a numeric value indicating the color number of the tile background section. Specify this color number with a numeric value from 0 to 15.• tile-2 indicates the background tiling figure of the free graph. Specify this tiling figure with a numeric value from 0 to 15.• display-color-2 is a numeric value indicating the color number of the tile display section of the background. Specify this color number with a numeric value from 0 to 15.• background-color-2 is a numeric value indicating the color number of the tile background section of the background. Specify this color number with a numeric value from 0 to 15.
Related Item	FREDSP

Example of Program

```
conf
  static name@
  name@ = ..FRE000
end conf
evnt
  input type%, id@, data%
  if type% = 3 then
    FRECOLOR name@, 2, 3, 1, 4, 5, 2
  endif
end evnt
```

FREDSP

Statement

Function	The FREDSP statement specifies the value to be displayed in the free graph display.
Format	FREDSP control-name, display-value
Example of Use	FREDSP .B000.FRE000, 50
Description	<ul style="list-style-type: none"> • The FREDSP statement specifies the value to be displayed in the free graph. • control-name is the name of the free graph display or the ID-type variable indicating the free graph display. • display-value is the value specifying the filling range in the free graph display. • display-value cannot be changed even if this statement is issued to the display for which operation parameters are set to “effective” in the primitive.
Related Item	FRECOLOR

Example of Program

```

conf
    static name@
    name@ = ..FRE000
end conf
evnt
    input type%, id@, data%
    FREDSP name@, data%
end evnt

```

FSEEK

Function

Function	The FSEEK function changes the read/write position of a file.
Format	FSEEK (file-number, reference-position, offset)
Example of Use	AAA% = FSEEK (12, 0, 0)
Description	<ul style="list-style-type: none">• The FSEEK function moves the read/write position of the file by the value specified by offset, starting from reference-position.• file-number specifies the number of the file opened by the FOPEN statement.• 0, 1, and 2 can be specified in reference-position. When 0 is specified, the FSEEK function moves the read/write position, starting from the beginning of the file. When 1 is specified, the function moves the read/write position, starting from the current position. When 2 is specified, it moves the read/write position, starting from the end of the file.• Specify offset in bytes. Specify a positive value in offset when moving the read/write position to the end of the file.• The read/write position obtained as a result of executing the FSEEK function is returned.
Related Item	FOPEN, FCLOSE, FPRINT, FWRITE, FINPUT

Example of Program

```
conf
  fopen  ``C:TEST`` , 2 , 5
end conf
evnt
  AAA$ = ``12345``
  fwrite 5, AAA$, ``ABCD``
  fseek(5, 0, 0)
  finput 5, VSTR$
end evnt
```

FSUM

Function

Function	The FSUM function calculates the sum of the variable group in the specified field.
Format	FSUM (file-number)
Example of Use	SUM = FSUM (5)
Description	<ul style="list-style-type: none"> • The FSUM function calculates the sum (eight low-order bits) of the variable group included in the FIELD specified by file-number by incrementing the contents of the group for each byte. The function calculates the area where no character code is defined in the character string variable as 0. • The FSUM function returns the calculation result as an integer-type value within the range from 0 to 255. • If the FIELD specified by file-number does not exist, an error occurs.
Related Item	FOPEN, FIELD, FCLOSE, FPUT, FGET

Example of Program

```

conf
  field 5
    global no%
    global moji1$ , moji2$
  end field
  global sum%
  fopen ``MEMORY``, 2 , 5
  .....
end conf
evnt
  fget 5 , 3
  if sum% = FSUM(5) then
    numdsp ..NUM000 , no%
    strdsp ..STR000 , moji1$
    strdsp ..STR001 , moji2$
  else
    strdsp ..STR002 , ``SUM-error``
  fclose 5
end evnt

```

FUNCTION ... END FUNCTION

Statement

Function The FUNCTION ... END FUNCTION statement declares a function block.

Format FUNCTION function name [type declaration character](variable declaration[, variable declaration] ...)
 ...
 END FUNCTION

Example of Use FUNCTION ADD%(A%,B%)
 ADD%=A%+B%
 END FUNCTION

Description

- The FUNCTION ... END FUNCTION statement declares a function block where the function itself is defined.
- A defined function can be referenced in three ways as shown below according to the position where it is declared:
 - Local function: Defined in a program other than a global screen program.
 - Global function: Defined in a global screen program.
 - Library function: Defined in a library.
- The declared type of a function (in the prototype declaration) must be the same as the defined type of the function itself.
- Like a variable, a function has a return value of a type determined by the type declaration character (\$, % or !).
 A function with no type declaration character is a real number function.
- The return value of a function depends on a value substituted for the function name including the type declaration character.
- Variable declaration is an argument of a function.
 A variable with no argument declaring a variable type is regarded as a real number variable.
- An argument of a function is given when referenced. Therefore, if a value is changed by substituting it for an argument in the function or the like, the variable itself given as the argument by the caller is also changed.
- Type declaration using DECLARE is needed to call a function declared in a function block.
- To exit a function in a function block forcedly, use EXIT FUNCTION.
- This is one of the new features of Screen Creator 5.

Related Item DECLARE, EXIT FUNCTION, FUNCTIONCHECK

Example of Program

```
declare my_add%(a%,b%)
conf
  global x%,y%
  local sum%
  sum% = my_add(x%,y%)
end conf
FUNCTION my_add%(a%,b%)
  my_add%=a%+b%
END FUNCTION
```

FWRITE

Statement

Function	The FWRITE statement writes data to the specified file.
Format	FWRITE file-number, expression, expression, ...
Example of Use	FWRITE 12, 100, "ABCD", VAR%, STRING\$
Description	<ul style="list-style-type: none">• The FWRITE statement writes the numeric value or character defined in expression to the file specified by file-number.• A numeric value, a character, or a numeric or character variable can be specified in expression.• When writing two or more expressions to the file, delimit them with a comma (.). Add the code indicating carriage return (CR) or line feed (LF) to the end of expression description.• A numeric expression is converted to a numeric string and written to the specified file. When the numeric string is negative, a minus sign (-) is inserted before it.• When writing a character string, enclose it in double quotation marks ("").• file-number must match the number of the file opened by the FOPEN statement.
Related Item	FOPEN, FCLOSE, FPUT, FPRINT

Example of Program

```
conf
  fopen  ``C:TEST``, 2 , 5
end conf
evnt
  var% = -2
  fwrite 5, 123, var%, ``ABCD``, ``XYZ``
end evnt
```

Data is written to the specified file as follows:

```
123,-2,``ABCD``,``XYZ`` CR/LF
```

GETBLIGHT

Statement

Function	The GETBLIGHT statement reads the time that lasts till the back light is turned off.
Format	GETBLIGHT variable-name
Example of Use	GETBLIGHT VAR
Description	variable-name specifies the variable used to write the time that lasts till the back light is turned off. The unit for the read values is minute. When 0 is specified, the back light is not turned off.
Related Item	SETBLIGHT

Example of Program

```
conf
  GETBLIGHT var
  var = var*2
  setblight var
end conf
```

GETDATE

Statement

- Function** The GETDATE statement obtains the data representing a date.
- Format** GETDATE year-read-variable, month-read-variable, day-read-variable, day-of-week-read-variable
- Example of Use** GETDATE YEAR%, MONTH%, DATE%, DAY%
- Description**
- The GETDATE statement writes the current date value to year-read-variable, month-read-variable, day-read-variable, and day-of-week-read-variable.
 - Year is the low-order two digits of A.D. Month is a numeric value from 1 to 12. Day is a numeric value from 1 to 31. The day of the week is a numeric value from 0 to 6 (Sunday to Saturday).
 - Read variables must be integer-type variables.
 - Once date is set using the SETDATE command in a model with a battery backup calendar IC (GC56LC or GC55EM), the date is updated even while the power is off. If a model with no calendar IC (GC53LC or GC53LM) is turned off, the date is initialized to January 1, 1998 (Thursday) and the time to 00:00:00 when it is turned on again. The date and time are updated while the power is on.
- Related Item** DATE\$, GETTIME, SETDATE, SETTIME, TIME\$

Example of Program

```
conf
  GETDATE yr%, mt%, d%, dd%
  numdsp ..NUM000, yr%
  numdsp ..NUM001, mt%
  numdsp ..NUM002, d%
end conf
```



GETGID

Function

Function	The GETGID function obtains the ID of the local screen currently being displayed.
Format	GETGID()
Example of Use	VAR@ = GETGID()
Description	<ul style="list-style-type: none">• The GETGID function obtains the ID of the local screen currently being displayed.• This function cannot be used to obtain the ID of a global screen.
Related Item	GETGNO

Example of Program

```
evnt
  input type%, id@, data%
  if type% = 3 then
    VAR@ = GETGID()
    NO% = GETGNO(VAR@)
    00~D100 = NO%
  end if
end evnt
```

GETGNO

Function

Function	The GETGNO function obtains the registration number of the screen currently being displayed.
Format	GETGNO (screen-ID)
Example of Use	NO = GETGNO (ID@)
Description	<ul style="list-style-type: none">• The GETGNO function obtains the registration number of the screen specified in screen-ID.• screen-ID specifies a screen name or an ID-type variable.
Related Item	GETGID

Example of Program

```
evnt
  input type%, id@, data%
  if type% = 3 then
    VAR@ = GETGID()
    NO% = GETGNO(VAR@)
    00~D100 = NO%
  end if
end evnt
```

GETID

Function

Function The GETID function obtains the value of the ID separate from the reference ID by offset.

Format GETID (object-indicated-by-reference-ID, offset-value)

Example of Use ID@ = GETID (VARID@, 10)

Description

- The GETID function obtains the ID-type value separate from the reference ID-type value by the specified offset value.
- **object-indicated-by-reference-ID** specifies an ID-type variable name, a screen name, a part name, a registration character string/graphic name, or a device name.
- **offset-value** is the integer or real value indicating the offset from the reference ID to the ID to be obtained. When 0 is specified in offset-value, the reference ID value is obtained.
- When 1 is specified in **offset-value**, the ID of the first element of a continuous-stage-type control is obtained.

Related Item GETOFFSET

Example of Program

```

conf
  cyclic 00~d0001 * 30
end conf
evnt
  input ty%,id@,dat%
  offset = getoffset(00~d0001,id@)
  ...
  Error processing corresponding to the offset value, etc.
  ...
  id@ = getid (00~d0001,offset)
  ....
end evnt

```

GETOFFSET

Function

Function	The GETOFFSET function calculates the offset between the reference ID and specified ID.
Format	GETOFFSET (reference-ID, ID-to-be-specified)
Example of Use	OFFSET% = GETOFFSET (00~D0001, ID@)
Description	<ul style="list-style-type: none"> • The GETOFFSET function calculates the offset indicating how long the specified ID is separate from the reference ID. • reference-ID specifies the ID-type variable, screen name, part name, registration character string/graphic name, or device name used as the reference offset. • ID-to-be-specified specifies the ID-type variable, screen name, part name, registration character string/graphic name, or device name used to calculate the offset. • When the GETOFFSET function applies to the device declared in CYCLIC2, the offset value is a multiple of 2.
Related Item	GETID

Example of Program

```

conf
  cyclic 00~d0001 * 30
end conf
evnt
  input ty%,id@,dat%
  offset = GETOFFSET(00~d0001,id@)
  ...
  Error processing corresponding to the offset value, etc.
  ...
  id@ = getid (00~d0001,offset)
  ....
end evnt

```

GETTIME

Statement

Function	The GETTIME statement obtains the data indicating time.
Format	GETTIME hour-read-variable, minute-read-variable, second-read-variable
Example of Use	GETTIME HOUR%, MIN%, SEC%
Description	<ul style="list-style-type: none">• The GETTIME statement writes the current value (time) to hour-read-variable, minute-read-variable, and second-read-variable.• Hour is a numeric value from 0 to 23. Minute is a numeric value from 0 to 59. Second is a numeric value from 0 to 59.• Read variables must be integer-type variables.• Once date is set using the SETDATE command in a model with a battery backup calendar IC (GC56LC or GC55EM), the date is updated even while the power is off. If a model with no calendar IC (GC53LC or GC53LM) is turned off, the date is initialized to January 1, 1998 (Thursday) and the time to 00:00:00 when it is turned on again. The date and time are updated while the power is on.
Related Item	DATE\$, GETDATE, SETDATE, SETTIME, TIME\$

Example of Program

```
conf
  GETTIME H% ,M% ,S%
  numdsp ..NUM000, H%
  numdsp ..NUM001, M%
  numdsp ..NUM002, S%
end conf
```

GLOBAL

Statement

Function	The GLOBAL statement declares that global variables are to be used.
Format	GLOBAL variable-name [, variable-name ...]
Example of Use	GLOBAL VAR, XYZ(2,3), MOJI\$ * 20
Description	<ul style="list-style-type: none">• The GLOBAL statement declares that global variables are to be used. Global variables can be read and written from all programs. Global variables must be declared before they are used in a program. These variables are initialized once when the power supply is turned on. The values of global variables used after the power supply has been turned on are retained.• A normal variable, an array variable, or a character string variable can be written in variable-name.• When an array or character variable is declared, the DIM and STRING statements need not be declared.• Use the DIM or STRING statement to specify a non-global array and a character string type.
Related Item	AUTO, BACKUP, DIM, LOCAL, STATIC, STRING

Example of Program

```
conf
  GLOBAL var%, float
  GLOBAL moji$ * 50
  GLOBAL xyz@(10,10)
end conf
```

GOSUB

Statement

Function	The GOSUB statement executes the specified subroutine.
Format	GOSUB subroutine-name
Example of Use	GOSUB SUB001
Description	<ul style="list-style-type: none">• Control is transferred to the subroutine specified after the GOSUB statement.• Subroutine names written in the global screen and those in the program containing the GOSUB statement can be specified. Use the RETURN statement to return control.• If the same name exists both in the global and local subroutines, the global subroutine is called.
Related Item	RETURN

Example of Program

```
evnt
  X = 10
  GOSUB SUB001
  numdsp ..NUM000, X
end evnt
SUB001:
  ab = X+3
  RETURN
```

GOTO

Statement

Function The GOTO statement unconditionally moves control to the specified line.

Format GOTO label-name

Example of Use GOTO LABEL1

Description The GOTO statement unconditionally moves control to the line specified by label-name. Execution is continued from the line to which control was moved.

Related Item None

Example of Program

```
evnt
  if a = 1 then goto L1
  a = 3
  L1: numdsp ..NUM000 , a
end evnt
```

HEX\$

Function

Function	The HEX\$ function converts a decimal character string to a hexadecimal character string.
Format	HEX\$ (numerical-expression)
Example of Use	HEX\$ (123)
Description	<ul style="list-style-type: none"> • The HEX\$ function converts a decimal character string to a hexadecimal character string. • When a floating-point type is specified in numerical-expression, the decimal character string (numeric value) is converted to an integer type, then converted to a hexadecimal character string. • Specify the decimal character string (numeric value) within the range from -2147483648 to 2147483647.
Related Item	OCT\$, VAL

Example of Program

```

evnt
  input type , id@ , data
  moji$ = HEX$(data)
  strdsp ..STR000, moji$
end evnt

```

IF ... THEN ... ELSE

Statement

Function Condition judgment is performed to select the next program to be executed.

Format IF conditional expression THEN statement [ELSE statement]
 IF conditional-expression THEN
 statement-list
 [ELSEIF conditional-expression THEN
 statement-list]
 [ELSE
 statement-list]
 END IF

Example of Use IF TYPE% = 1 THEN VALUE = 10

Description

- conditional-expression is the relational operation expression obtained when the operation result is true (other than 0) or false (0).
- When the operation result is true as a result of executing a conditional expression, the THEN and subsequent statements are executed. When the operation result is false, the ELSE and subsequent statements are executed.
- The ELSE, ELSEIF and subsequent statements can also be omitted.
- Up to 50 ELSEIF statements can be used in IF THEN...END IF.

Related Item None

Example of Program

```

evnt
  if a = 2 then x = 3
  if x = 5 then
    a = 1
  elseif x = 6 then
    a = 2
  else
    a = 3
  end if
end evnt

```



INIT ... END INIT

Statement

Function	The INIT ... END INIT statement declares an area of an initialization block.
Format	INIT END INIT
Example of Use	INIT static VAR\% END INIT
Description	<ul style="list-style-type: none"> • An initialization block written in a screen program or part program is executed first only once when the program including the block is executed. • Write processing which should be executed first only once such as initialization or the like.
Related Item	CONF END CONF, EVNT END EVNT

Example of Program

```

INIT
  global moji$
  moji$="initial value"
END INIT

```

INP

Function

Function	The INP function reads 2-byte data from the specified parallel I/O port.
Format	INP (port-number)
Example of Use	VAR = INP (0)
Description	<ul style="list-style-type: none">• The INP function reads data from the specified parallel I/O port.• The port-number to be specified depends on the option board inserted into the option bus. A numeric value from 0 to 3 can be specified in port-number.
Related Item	OUT

Example of Program

```
evnt
  var% = inp (0)
  if (var% and 1) = 1 then var% = 0
  OUT 0,var%
end evnt
```

INPBIT

Function

Function	The INPBIT function reads the specified BIT number from the specified input port.
Format	INPBIT (port-number, BIT-number)
Example of Use	DATA% = INPBIT (0,10)
Description	<ul style="list-style-type: none">• The INPBIT function reads the specified BIT number from the specified input port.• Specify port-number and BIT-number with an integer value relative to 0.• The lowest-order bit number of the parallel IO is 0 and the next lowest-order bit number is 1. That is, the BIT number is sequentially incremented.• If an unexisting port or BIT number is specified, 0 is returned.
Related Item	INP, OUT, OUTBIT, OUTBITSTAT, OUTSTAT

Example of Program

```
evnt
  data% = INPBIT(0,3)
  if data% = 0 then
    outbit 0,3,1
  endif
end evnt
```

INPUT

Statement

- Function** The INPUT statement reads the data transmitted to a screen or part into the specified variable(s).
- Format** INPUT variable-name [, variable-name]
- Example of Use** INPUT V1, ID@, DATA
- Description**
- The INPUT statement reads the data transmitted to a screen or part.
 - The integer value indicating the type of the sender that transmitted data is set in the first variable-name. The value indicating the ID of the sender is set in the second variable-name, which is followed by data.

Sender	Type	ID	Contents of data
Screen	1	Optional	Item written in the PRINT statement
Part	2		Item written in the PRINT statement
Switch (single)	1		1 when ON, 0 when OFF
Switch (multi)			Switch number: 1 when ON, 0 when OFF
Selector switch			Number of activated switch
Timer	4		Value indicating the ON (1) or OFF (0) status
Alarm	5		Value indicating the ON (1) status
Parallel port	6		BIT number, BIT value, or channel number satisfying the condition
Non-procedural	7		The port number, status, and number of received bytes are set in this order.
Sampling	9	Control	Sampled data
PLC	16		Integer value indicating the device value
Bar code reader	18		Bar code value
Magnetic card	19		
Ten-key pad	20		Code of pressed key
Memory card	21		
Host	22		Optional data to be determined by the user

INPUT

--

bytes written to the reception buffer). For the text mode, a terminator code is also read. (When the status is 1 or -1, the number of received data is read.)

- The numbers of multi-switches and selector switches are counted as 1, 2, 3 and so forth from the upper left switch. When all switches are counted in the X direction, the switches on the lower Y line are counted in the same way. They are integers.

Related Item

PRINT, CYCLIC, OPENPARALLEL, OPENCOM, OPENSIO

Example of Program

```
conf
  global buffer$
  opensio 2 , 0, buffer$
  setsio 2, 10
end conf
evnt
  input type, id@, port%, status%, bytes%
  if type = 7 then
    moji$ = left(buffer$, bytes% - 1)
    strdsp ..STR000 , moji$
  end if
end evnt
```

INSTR

Function

Function	The INSTR function retrieves character strings to find the specified character string. When the specified character string is found, the function notifies the system of the start position of the character string.	
Format	INSTR	(start-position, character-strings-to-be-retrieved, character-string-to-be-found)
Example of Use	A = INSTR (10. MOJI1\$, MOJI2\$)	
Description	<ul style="list-style-type: none"> • The INSTR function retrieves the character strings specified in character-strings-to-be-retrieved to find the character string specified in character-string-to-be-found. This retrieval starts at the start position specified in start-position. When the specified character string is found, the function notifies the system of the position in a number of bytes relative to the beginning of the character strings to be retrieved. If the specified character string is not found, 0 is set. • start-position is 1 when retrieval starts at the beginning of character strings. • Character string variables, direct character strings, registration character string names, and registration character string numbers can be specified in character-strings-to-be-retrieved. 	
Related Item	None	

Example of Program

```

evnt
  a$ = "this is oip."
  p = instr (1, a$, "company")      ' When a character string variable is
specified
  p = instr (1, num,"ab")          ' When a registration character
string number
end evnt                               is specified

```

INT

Function

Function The INT function omits the fraction of the value specified in numerical-expression to create an integer.

Format INT (numerical-expression)

Example of Use A = INT (30.1)

Description

- The INT function omits the fraction of the numerical-expression enclosed in parentheses in the negative direction.
- The INT function calculates the maximum integer that does not exceed the value specified in numerical-expression when omitting the decimal point.
- When the value specified in numerical-expression is negative, the INT function omits the figures below the decimal point as follows:
INT (1.4) 1
INT (-1.4) -2

Related Item CINT

Example of Program

```
evnt
  input type%, id@, data
  intvar% = INT ( data )
  numdsp ..NUM000, intvar%
end evnt
```

INTERLOCK

Statement

Function	The INTERLOCK statement controls transition to the system mode screen.
Format	INTERLOCK mode
Example of Use	INTERLOCK 1
Description	<ul style="list-style-type: none"> • When mode is 1, the INTERLOCK statement sets the interlock to ON. When 0, the INTERLOCK statement sets the interlock to OFF. • When the interlock is ON, the system mode screen is not displayed even if two dots on a diagonal line are pressed. When power is ON, the system mode screen is not displayed even if the upper left edge on the screen is pressed. • When lock is activated, it must be reset by a program. Make a program so that it resets lock securely. • A mode specified using the INTERLOCK command in a model with a battery backup calendar IC (GC56LC or GC55EM) is maintained even while the power is off. A mode specified using the INTERLOCK command in a model with no calendar IC (GC53LC or GC53LM) is lost when the power is turned off. Therefore, a mode must be specified in a program which is always executed when the power is turned on.
Related Item	None

Example of Program

```

conf
  INTERCLOCK 1
end conf
evnt
  input tp%,id@,dat%
  if id@ = ..sw the interlock 0
  .....
end evnt

```

IOCTL

Statement

Function	The IOCTL statement controls the I/O device connected to the OIP.
Format	IOCTL I/O-type, mode
Example of Use	IOCTL 0, 0
Description	<ul style="list-style-type: none"> • Write the integer value indicating the I/O device to be controlled in I/O-type. Currently, the type of I/O device that can be controlled are the PLC, switch, and non-procedure transmission buffer. • mode is the integer value indicating how the I/O device is controlled. • When controlling the PLC, specify one of the following values indicating how the PLC is controlled in mode. The value used to determine the IO type is 0. <ul style="list-style-type: none"> 0: The PLC is write- and read-enabled. 1: The PLC is write-inhibited. <ul style="list-style-type: none"> – If write is executed when the PLC is write-inhibited, an error will occur. • Switches are controlled as follows: The value used to determine the IO type is &H60. <ul style="list-style-type: none"> – When switches are simultaneously pressed, the number of switches to be assumed ON can be controlled. – Specify the number of switches that can be simultaneously recognized in mode with a numeric value from 0 to 640. – Specifying 0 inhibits switch input. The switch cannot be used in this case. Thus, be sure to make a program in another way so that it resets prohibition of turning on the switch. – The number of switches specified using this command in a model with a battery backup calendar IC (GC56LC or GC55EM) is maintained even while the power is off. The number of switches specified using this command in a model with no calendar IC (GC53LC or GC53LM) is lost when the power is turned off. Therefore, the number of switches must be specified in a program which is always executed when the power is turned on. • A non-procedure type send buffer is cleared as shown below. The value for deciding the I/O type is &H41. <ul style="list-style-type: none"> - Specify a port (CH1 to CH3) for clearing the send buffer in "mode". Input a number between 1 and 3.
Related Item	IOSTAT

Example of Program

```
evnt
  input ty%,id@,dat%
  if id@ = ..sw1 and dat% = 1 then
    ioctl 0,0
  else
    ioctl 0,1
  endif
end evnt
```

IOCTL2

Statement

Function	The IOCTL2 statement controls PLC cyclic communication.
Format	IOCTL2 device-name, code, data
Example of Use	IOCTL2 00~D10, 0, 0
Description	<ul style="list-style-type: none"> • Executing the IOCTL2 statement executes the cyclic communication specified by device-name. The cyclic communication to be specified by device-name must be declared in the CYCLIC or CYCLIC2 statement in advance. • Set 0 in code and data.
Related Item	None

Example of Program

```

conf
  cyclic 00~D10
end conf
evnt
  input ty%,id@,dat%
  if id@ = ..sw1 then
    00~D11 = 1
    ioctl2 00~D10 ,0 ,0
  endif
end evnt

```

IOSTAT

Function

Function	The IOSTAT function reads the status of the I/O device connected to the OIP.
Format	IOSTAT (I/O-type)
Example of Use	IOSTAT (0)
Description	<ul style="list-style-type: none">• Write the integer value indicating the I/O device whose status is to be read in I/O-type. Currently, the type of I/O device that can be controlled are the PLC and switch.• To read the PLC status, specify 0 in I/O-type.<ul style="list-style-type: none">0: The PLC is write- and read-enabled.1: The PLC is write-inhibited.• To read the switch status, specify &H60 in I/O-type.<ul style="list-style-type: none">– The number of switches that can be recognized when they are pressed simultaneously is returned (0 to 640).
Related Item	IOCTL

Example of Program

```
evnt
  input ty%,id@,dat%
  if id@ = ..sw1 then
    if iostat(0) then
      ioctl 0,0
    else
      ioctl 0,1
    end if
  endif
end evnt
```

JUMP

Statement

Function	The JUMP statement displays the specified screen.
Format	JUMP screen-name
Example of Use	JUMP 10
Description	<ul style="list-style-type: none">• The JUMP statement displays the screen specified in screen-name.• screen-name is the name of the screen to be displayed or the ID-type variable indicating the screen to be displayed. Alternatively, screen-name specifies the screen number stored in screen registration.• When this statement is executed, the subsequently coded program is not executed.• If a non-existent screen is specified, a system error occurs.
Related Item	None

Example of Program

```
evnt
  input type , id@ , data
  if type = 3 and id@ = ..SWT000 then
    JUMP GAMEN..
  end if
end evnt
```

KILL

Statement

Function	The KILL statement deletes the specified file.
Format	KILL file-name
Example of Use	KILL "C:ABC.DOC"
Description	<ul style="list-style-type: none">• The KILL statement deletes the file specified by file-name.• A wild card (*) can be specified in file-name.

Related Item

Example of Program

```
conf
end conf

evnt
    .....
    KILL ``ABC.*''
    .....
end evnt
```

LAMPCOLOR

Statement

Function The LAMPCOLOR statement changes the ON display color of the lamp display.

Format LAMPCOLOR display-name, color-number

Example of Use LAMPCOLOR .BUHIN.GRAPH, 5

Description The LAMPCOLOR statement changes the ON display color of the lamp display.

- **display-name** is the name of lamp display or the ID-type variable indicating the lamp display.
- **color-number** indicates the color displayed when the lamp display is ON. Specify this color number with a numeric value from 0 to 15.

Related Item LAMPDSP

Example of Program

```
conf
  lampdsp .buhin.gpaph , 0
  LAMPCOLOR .buhin.gpaph , 7
  lampdsp .buhin.gpaph , 1
end conf
```

LAMPDSP

Statement

Function	The LAMPDSP statement indicates whether the lamp display is ON or OFF.
Format	LAMPDSP control-name, lamp-mode
Example of Use	LAMPDSP .BUHIN.GRAPH, 1
Description	<p>The LAMPDSP statement indicates whether the lamp display is ON or OFF.</p> <ul style="list-style-type: none">• control-name is the name of lamp display or the ID-type variable indicating the lamp display.• lamp-mode indicates whether the lamp display is ON or OFF. When lamp-mode is 0, the lamp display is OFF. When 1, the lamp display is ON.• display-value cannot be changed even if this statement is issued to the control for which operation parameters are set to “effective” in the control.
Related Item	LAMPCOLOR

Example of Program

```
evnt
  input type,id@,data
  var@ = .buhin.graph
  LAMPDSP var@ , data
end evnt
```

LEFT\$

Function

Function The LEFT\$ function returns a character string the specified number of characters, starting from the left of the specified character string.

Format LEFT\$ (character-string, number-of-characters)
 LEFT\$ (registered-character-string-number, number-of-characters)
 LEFT\$ (registered-character-string-name, number-of-characters)

Example of Use A\$ = LEFT\$ (MOJI\$, 5)
 A\$ = LEFT\$ (4, 10)
 A\$ = LEFT\$ (TOROKU, 8)

Description

- The LEFT\$ function returns a character string the number of bytes specified in `number-of-characters`, starting from the left of the specified character string.
- `number-of-characters` specifies the number of bytes of the character string to be fetched with a numeric value from 0 to 255. When `number-of-characters` is 0, a null character string is returned.
- `character-string` is a direct character string or a character string variable.
- `registered-character-string-number` is the numerical expression indicating the number registered by GCSGP3.
- `registered-character-string-name` is the name of the character string created by GCSGP3 or the ID-type variable indicating the name of the character string.

Related Item MID\$, RIGHT\$

Example of Program

```

evnt
  b$ = "12345678"
  a$ = LEFT$(b$ , 3)
  c$ = LEFT$ (no , 3)
  c$ = LEFT$ (id@ , 4)
end evnt

```

LEN

Function

Function The LEN function returns the length of the specified character string in a number of bytes.

Format LEN (character-string)
LEN (registered-character-string-number)
LEN (registered-character-string-name)

Example of Use A = LEN (B\$)
A = LEN (MOJI)

Description

- The LEN function returns the length of the character string specified by character-string, registered-character-string-number, or registered-character-string-name in a number of bytes.
- character-string is a direct character string or a character string variable.
- registered-character-string-number is the numerical expression indicating the number registered by GCSGP3.
- registered-character-string-name is the name of the character string created by GCSGP3 or the ID-type variable indicating the name of the character string.

Related Item None

Example of Program

```
conf
  a = len (b$)
  a = len ("abcdefg")
  a = len ( toroku )
  a = le (1)
end conf
```

LINE

Statement

Function	The LINE statement draws a straight line on a screen.
Format	LINE X1, Y1, X2, Y2
Example of Use	LINE 20,30,100,200
Description	<p>The LINE statement draws a straight line between the specified two coordinates ((X1,Y1) and (X2,Y2)).</p> <ul style="list-style-type: none">• X1 and X2 must be a numeric value from 0 to 639. Y1 and Y2 must be a numeric value from 0 to 399 (GC55EM) or 0 to 479 (GC56LC).• A straight line is directly displayed as the background of a screen. When a part is opened or closed in the area where a straight line was displayed or when a primitive is displayed, the straight line may be cleared. The cleared straight line is not redisplayed.• The type and color of the straight line are specified by COLOR.• If this is used in an initialization block or configuration block, drawing is executed after executing this block and accordingly lines are not drawn. Be sure to use this in an event block.

Related Item COLOR

Example of Program

```
conf
  color 1 , 0 , 3
end conf
evnt
....
  dot 100,200
  dot 100,300
  color 1 , 0 , 0
  line 100,200,100,300
....
end evnt
```



LINPUT

Statement

Function	The LINPUT statement reads data from the specified file.
Format	LINPUT file-number, character-string-variable
Example of Use	LINPUT 12, STRING\$
Description	<ul style="list-style-type: none"> • The LINPUT statement reads data from the file specified by file-number into the character string defined by character-string-variable. • The data between the current file position and carriage return (CR) or line feed (LF) is assigned to character-string-variable. (CR and LF, however, are not assigned.) • file-number must match the number of the file opened by the FOPEN statement.
Related Item	FOPEN, FCLOSE, FPRINT, FWRITE, FINPUT

Example of Program

```

conf
  fopen 'C:TEST', 2 , 5
end conf
evnt
  AAA$ = '12345'
  fwrite 5, AAA$, 'ABCD'
  fseek(5, 0, 0)
  linput 5, VSTR$
end evnt

```

The file is written as follows:

```
'12345', 'ABCD' CR/LF
```

When data is read, the variables change as follows:

```
VSTR$ '12345', 'ABCD'
```

LNECOLOR

Statement

Function The LNECOLOR statement changes the line colors and figure of the line chart display.

Format LNECOLOR control-name, line-number, line-type, line-color, tile, display-color, background-color

Example of Use LNECOLOR ..LNE000, 1, 2, 1, 4, 5, 2

Description

- The LNECOLOR statement changes the line colors and figure of the line chart display and the background tile and color of the entire display.
- **control-name** is the name of a line chart or the ID-type variable indicating the chart.
- **line-number** is the integer value indicating the number of the line to be changed. The line number starts at 1.
- **line-type** is the numeric value indicating the type of the line. Specify this line type with a numeric value from 0 to 3.
- **tile** indicates the tiling figure of the bar. Specify this tiling figure with a numeric value from 0 to 15.
- **display-color** is the numeric value indicating the color number of the tile display section. Specify this color number with a numeric value from 0 to 15.
- **background-color** is the numeric value indicating the color number of the tile background section. Specify this color number with a numeric value from 0 to 15.

Related Item LNECOLOR, LNECOLOR, LNECOLOR

Example of Program

```

conf
  static name@
  name@ = ..LNE000
end conf
evnt
  input type%, id@, data%
  if type% = 3 then
    LNECOLOR name@, 2, 3, 1, 4, 5, 2
  endif
end evnt

```

LNEDSP

Statement

Function	The LNEDSP statement displays data in the line chart display.
Format	LNEDSP control-name, line-number, point-number, display-data
Example of Use	LNEDSP .BUHIN.GRAPH, 2, 2, 30.0
Description	<ul style="list-style-type: none"> • The LNEDSP statement displays line data in the line chart display. • control-name is the name of a line chart or the ID-type variable indicating the chart. • line-number is the value indicating the line number in the line chart to be displayed. The line number starts at 1. • point-number specifies the data point to be changed in the line chart; it is the integer-type value starting at 1. The maximum point value depends on what line chart is placed. • display-value is the numeric data indicating the size of the specified line chart point. • display-value cannot be changed even if this statement is issued to the display for which operation parameters are set to “effective” in the control.
Related Item	LNECOLOR, LNESHIFT

Example of Program

```

conf
  static name@
  name@ = ..LNE000
end conf
evnt
  input type%, id@, data%
  lnedsp name@, 2, 2, data%
end evnt

```

LNESET

Statement

Function	The LNESET statement sets data in the line chart display.
Format	LNESET control-name, line-number, point-number, display-data
Example of Use	LNESET .BUHIN.GRAPH 2, 4, 30.0
Description	<ul style="list-style-type: none"> • The LNESET statement sets the data to be displayed in the line chart display. The speed of executing the PRDSP (display) statement after setting data in two or more points is faster than that of modifying all the line point values after executing the LNESET statement. • control-name is the name of the line chart display or the ID-type variable indicating the line chart display. • line-number specifies which line data is to be displayed when two or more lines are displayed in one line chart display. This line number is the integer value data starting at 1. • point-number specifies which point value on the specified line is to be changed. This point number is the integer value data starting at 1. • display-data is the numeric data indicating the size of the line chart.
Related item	LNEDSP, PRDSP

Example of Program

```

evnt
  lneset .buhin.graph , 3 , 8 , 20.1
  var@ = .buhin.graph
  no = 4
  value = 23
  point = 4
  LNESET var@ , no , point , value
  prdsp var@
end evnt

```

LNESHIFT

Statement

Function	The LNESHIFT statement shifts the display data of a line chart left or right.
Format	LNESHIFT (control-name, line-number, shift-direction, display-data)
Example of Use	A = LNESHIFT (..LNE000, 1, 1, 30)
Description	<ul style="list-style-type: none"> • The LNESHIFT statement is a function that shifts each of the points constituting the line chart in the line chart display left or right by one point and displays the points. • When this statement is executed, the values of the points purged from the line chart are returned as a result of the shifting. • control-name is the line chart name or the ID-type variable indicating the line chart. • line-number is the value indicating which line in the line chart display is to be shifted. This line number starts at 1. • When shift-direction is 1, line chart data is shifted left and above. When shift-direction is -1, line chart data is shifted right and below. • display-data indicates the data to be displayed in the vacant area produced as a result of the shifting.
Related Item	LNEDSP, LNECOLOR, LNESHIFT2

Example of Program

```

evnt
  input type%, id@, data%
  if data% > 0 then
    abc% = lneshift ( ..LNE000, 1, 1, 0)
  else
    abc% = lneshift ( ..LNE000, 1, -1, 100)
  endif
end evnt

```

LNESHIFT2

Statement

Function The LNESHIFT2 statement shifts the display data of a line chart left or right.

Format LNESHIFT2 (control-name, line-number, shift-direction, display-data)

Example of Use A = LNESHIFT2 (..LNE000, 1, 1, 30)

Description

- Different from the LNESHIFT statement, the LNESHIFT2 statement shifts line chart data but does not display it. To display line chart data, execute the PRDSP statement.
- The LNESHIFT2 statement is a function that shifts each of the points constituting the line chart in the line chart display left or right by one point.
- When this statement is executed, the values of the points purged from the line chart are returned as a result of the shifting.
- **control-name** is the line chart name or the ID-type variable indicating the line chart.
- **line-number** is the value indicating which line in the line chart display is to be shifted. This line number starts at 1.
- When **shift-direction** is 1, line chart data is shifted left and above. When shift-direction is -1, line chart data is shifted right and below.
- **display-data** indicates the data to be displayed in the vacant area produced as a result of the shifting.

Related Item LINEDSP, LNECOLOR, LNESHIFT, PRDSP

Example of Program

```

evnt
  input type%, id@ data%
  if data% > 0 then
    abc% = lneshift2 ( ..LNE000, 1, 1, 0)
  else
    abc% = lneshift2 ( ..LNE000, 1, -1, 100)
  endif
  prdsp ..LNE000
end evnt

```

LOCAL

Statement

Function	The LOCAL statement defines a local variable.
Format	LOCAL variable name [, variable name ...]
Example of Use	LOCAL VAR , XYZ(2,3) , MOJI\$ * 20
Description	<ul style="list-style-type: none">• The LOCAL statement defines a variable defined in "variable name" as a local variable.• A local variable can be read and written only in a program where it is declared. The compiler gives a warning if an undefined local variable is used. Each local variable is initialized every time the block is executed.• A variable name can be specified in a normal variable, arrangement variable or character string variable.• DIM declaration or STRING declaration is not needed to declare an arrangement variable or character variable.• The LOCAL statement is one of the new features of Screen Creator 5 added for distinctive declaration of local variables.• DIM can substitute for LOCAL. However, use LOCAL as far as possible in Screen Creator 5.• STRING can be used, instead of LOCAL, to specify a size of a character string variable. However, use LOCAL as far as possible in Screen Creator 5.
Related Item	AUTO,BACKUP,DIM,FUNCTION,GLOBAL,STATIC,STRING

Example of Program

```
conf
  global float(5)
  LOCAL i%
  for i% = 0 to 5
    float(i%) = i%*3
  next
end conf
```

LOCALCHECK

Statement

Function	The LOCALCHECK statement controls the level of warning messages output by the compiler.
Format	LOCALCHECK warning level
Example of Use	LOCALCHECK 1
Description	<ul style="list-style-type: none">• The LOCALCHECK statement specifies whether or not to output a warning if local and global variables, functions and/or subroutines are used vaguely in a program.• Two warning levels are available as shown below:<ul style="list-style-type: none">1: A warning is output.0: No warning is output.• Three types of warnings are available as shown below:<ol style="list-style-type: none">(1) If a variable not declared is used in a program In this case, the compiler regards such a variable as a local variable. It regards such a variable as a global variable in a global screen program.(2) If global and local variable names or subroutine names are duplicate In this case, such variables or subroutines are regarded as global variables or subroutines.(3) If two or more global, local and/or library function names are duplicate In this case, the priority is given to a library function, if any. If no library functions are used, the functions are regarded as global functions.• The warning level is set to 0 unless the LOCALCHECK statement is written.• The warning level is changed from the position where the LOCALCHECK statement is written in the program.• The LOCALCHECK statement is one of the new features of Screen Creator 5.
Related Item	BACKUP,DECLARE,DIM,FUNCTION,GLOBAL,LOCAL



Example of Program

```
conf
  local newvar3$
  newvar1$ = "no warning"
  LOCALCHECK 1
  newvar2$ = "warning is given!"
  newvar3$ = "no warning"
end conf
```

LOF

Function

Function	The LOF function calculates the size of the specified file.
Format	LOF (file-number)
Example of Use	AAA = LOF (file-number)
Description	<ul style="list-style-type: none"> file-number specifies the number of the file whose size is to be calculated. This file number must match the number of the file opened by the FOPEN statement. The size of the specified file is calculated in bytes.
Related Item	FOPEN, FIELD, FCLOSE, FPUT, FGET, EOF

Example of Program

```

conf
  field 5
    global no%
    global moji1$ , moji2$
  end field
  global sum%
  fopen ``MEMORY``, 2 , 5
  .....
end conf
evnt
  no% = 1
  moji1$ = ``product-name``
  moji2$ = ``product-number``
  fput 5 , 3
  if LOF(5) > 100 then
    fclose 5
  end if
end evnt

```

--

LOG

Function

Function The LOG function calculates the natural logarithm specified in numerical-expression.

Format LOG (numerical-expression)

Example of Use A = LOG (B*C)

Description • numerical-expression must be a numeric value greater than 0.

Related Item EXP

Example of Program

```
conf
  la = log ( 10 )
  lb = log ( a * b )
end conf
```

MCPY

Statement

Function	The MCPY statement copies the contents of a field to a character string variable.
Format	1:MCPY file-number, character-string-variable 2:MCPY character-string-variable, file-number
Example of Use	MCPY 5, moji\$
Description	<ul style="list-style-type: none"> • The MCPY statement copies the contents of the variable group in a field to a character string variable or the contents of a character string variable to the variable group in a field. That is, the MCPY statement in the first example (1:MCPY) copies the contents of the character string variable to the variable group in the field specified by file-number. The MCPY statement in the second example (2:MCPY) copies the contents of the variable group in the specified field to the character string variable. • file-number specifies the file number defined in the FIELD declaration. • When the contents of the variable group or character string variable are copied, the size is used, whichever is smaller.
Related Item	FOPEN, FIELD, FCLOSE, FPUT, FGET, EOF, SOF

Example of Program

```

conf
  field 5
    global no%
    global moji1$ , moji2$
  end field
  global buff$ * 50
  opensio 1 , 0 , buff$
  fopen ``MEMORY``, 2 , 5
end conf
evnt
  no% = 1
  moji1$ = ``product-name``
  moji2$ = ``product-number``
  size% = sof(5)
  MCPY 5 , buff$
  writesiob 1 , size% , buff$
end evnt

```

MEDIACHK

Function

Function	The MEDIACHK function checks whether a medium exists in the drive and returns the check result.
Format	MEDIACHK (drive name)
Example of Use	STATUS\% = MEDIACHK("E:")
Description	<ul style="list-style-type: none">The return value is as shown below: 0: No medium 1: Medium exists.
Related Item	MEDIASIZE

Example of Program

```
conf
  global dname$(13)
  global dsel%
  strdsp ..str, "mediachk"
end conf
evnt
  input type%, id@, data%
  if data% = 1 then
    strdsp .dsp.str, dname$(dsel%)
    num% = mediachk(dname$(dsel%))
    if num% = 1 then
      strdsp ..str, "valid"
    else
      strdsp ..str, "invalid"
    end if
  end if
end evnt
```

MEDIASIZE

Function

Function	The MEDIASIZE function checks the size of a medium in the drive and returns the number of bytes.
Format	MEDIASIZE (drive name, calculation method)
Example of Use	SIZE% = MEDIASIZE("E:", 0)
Description	<ul style="list-style-type: none"> The calculation method is as shown below: <ul style="list-style-type: none"> 0: Full space 1: Free space <p>When the full space is specified, the medium size is calculated from the number of all clusters.</p> <p>When the free space is specified, free clusters are checked and the medium size is calculated from the total number of free clusters.</p>
Related Item	MEDIACHK

Example of Program

```

conf
  global dname$(13)
  global dsel%
  static mode%
  mode% = 0
  strdsp ..str, "mediasize"
  numdsp ..num001, mode%
end conf
evnt
  input type%, id@, data%
  if data% = 1 then
    if mode% = 1 then
      mode% = 0
    else
      mode% = 1
    end if
    numdsp ..num001,mode%
    strdsp .dsp.str, dname$(dsel%)
    num% = mediasize(dname$(dsel%),mode%)
    numdsp ..num000,num%
  end if
end evnt

```

MID\$

Statement

Function	The MID\$ statement replaces part of a character string with another character string.
Format	MID\$ (character-string-variable, start-position, number-of-characters) = replacing-character-string
Example of Use	MID\$ (x\$, 1, 1) = "A"
Description	<ul style="list-style-type: none">• The MID\$ statement replaces the character string specified in character-string-variable with the character string specified in replacing-character-string the specified number-of-characters (bytes), starting from the specified start-position.• If the specified number-of-characters is greater than the specified character-string-variable, the character string is replaced only by the size of the variable. For this reason, the size of the character string variable remains unchanged even if the character string is replaced.• The start position of the character string to be replaced starts at 1.• When number-of-characters is negative and start-position is 0 or negative, an error occurs.
Related Item	LEFT\$, RIGHT\$, MID\$

Example of Program

```
conf
  static moji$
  moji$ = "ABCDEFGH"
end conf
evnt
  input type, id@, data$
  mid$(moji$, 4, 3) = data$
end evnt
```

MID\$

Function

Function The MID\$ function returns a character string the specified number of characters.

Format MID\$ (character-string, start-position, number-of-character)
MID\$
(registered-character-string-number, start-position, number-of-characters)
MID\$
(registered-character-string-name, start-position, number-of-characters)

Example of Use A\$ = MID\$ (X\$, 2, 3)
A\$ = MID\$ (10, 2, 3)
A\$ = MID\$ (NAME, 2, 3)

Description

- The MID\$ function fetches the specified number-of-characters (bytes) from the specified character-string, starting from the position specified in start-position.
- character-string is a direct character string or a character string variable.
- registered-character-string-number is the numerical expression indicating the number registered by GCSGP3.
- registered-character-string-name is the name of the character string created by GCSGP3 or the ID-type variable indicating the name of the character string.
- When number-of-characters is 0 or when start-position is greater than the number of bytes of the specified character string, a null character string is returned.

Related Item LEFT\$, RIGHT\$

Example of Program

```

evnt
  input type,id@,data$
  a$ = mid$(data$ , 3 , 3)
  strdsp ..STR000,a$
end evnt

```

MKB

Statement

Function	The MKB statement stores data in any position of a character string variable.
Format	MKB character-string-variable-name, storage-position, integer-value
Example of Use	MKB MOJI\$, 5, VAR
Description	<ul style="list-style-type: none"> • The MKB statement stores one low-order byte of integer-value in the position specified by storage-position, starting from the beginning of the specified character-string-variable-name. • storage-position must be a integer- or floating-point-type variable or constant. 1 specifies the beginning of the character string variable. • integer-value specifies an overwriting value; it must be an integer- or floating-point-type variable or constant. When specified in integer-value, a floating-point-type variable or constant is converted to an integer. One low-order byte of this value overwrites the specified character-string-variable-name.
Related Item	MKS, MKW, MKI, MKF, MKID, CVB, CVW, CVI, CVF, CVID

Example of Program

```

conf
end conf
evnt
    org$ = ``1234567``
    strdsp ..STR000, org$
    MKB org$, 2, &H39
    strdsp ..STR001, org$
end evnt

```

MKDIR

Statement

Function	The MKDIR statement creates a directory.
Format	MKDIR directory-name
Example of Use	MKDIR "TEST"
Description	<ul style="list-style-type: none">• The MKDIR statement is an instruction for creating a subdirectory.• Specify the directory to be created with a character string constant or variable.• The directory to be created can be specified in directory-name together with a drive name.
Related Item	RMDIR, CHDIR, DIR

Example of Program

```
conf
end conf
evnt
    .....
    MKDIR ``C:TEST``
    .....
end evnt
```

MKF

Statement

Function	The MKF statement stores data in any position of a character string variable.
Format	MKF character-string-variable-name, storage-position, real-value
Example of Use	MKF MOJIS, 5, VAR
Description	<ul style="list-style-type: none"> • The MKF statement stores four bytes of real-value in the position specified by <code>storage-position</code>, starting from the beginning of the specified <code>character-string-variable-name</code>. • <code>storage-position</code> must be an integer- or floating-point-type variable or constant. 1 specifies the beginning of the character string variable. • <code>real-value</code> specifies an overwriting value; it must be an integer- or floating-point-type variable or constant. When specified in <code>real-value</code>, an integer-type variable or constant is converted to a real number. This value overwrites the specified <code>character-string-variable-name</code>. • The value is converted into a 86 series boundary and saved.
Related Item	MKS, MKB, MKW, MKI, MKID, CVB, CVW, CVI, CVF, CVID

Example of Program

```

conf
end conf
evnt
  org$ = ``1234567``
  strdsp ..STR000, org$
  MKF org$, 2, 1.23
  strdsp ..STR001, org$
end evnt

```

' The character string will not be displayed
' correctly.

MKI

Statement

Function	The MKI statement stores data in any position of a character string variable.
Format	MKI character-string-variable-name, storage-position, integer-value
Example of Use	MKI MOJIS, 5, VAR
Description	<ul style="list-style-type: none"> • The MKI statement stores four bytes of integer-value in the position specified by storage-position, starting from the beginning of the specified character-string-variable-name. • storage-position must be a integer- or floating-point-type variable or constant. 1 specifies the beginning of the character string variable. • integer-value specifies an overwriting value; it must be an integer- or floating-point-type variable or constant. When specified in integer-value, a floating-point-type variable or constant is converted to an integer. This value overwrites the specified character-string-variable-name. • The value is converted into a 86 series boundary and saved.
Related Item	MKS, MKB, MKW, MKF, MKID, CVB, CVW, CVI, CVF, CVID

Example of Program

```

conf
end conf
evnt
  org$ = ``1234567``
  strdsp ..STR000, org$
  MKI org$, 2, &H39404142
  strdsp ..STR001, org$
end evnt

```

MKID

Statement

Function	The MKID statement stores data in any position of a character string variable.
Format	MKID character-string-variable-name, storage-position, ID-value
Example of Use	MKID MOJIS, 5, VAR
Description	<ul style="list-style-type: none"> • The MKID statement stores six bytes of ID-value in the position specified by storage-position, starting from the beginning of the specified character-string-variable-name. • storage-position must be a integer- or floating-point-type variable or constant. 1 specifies the beginning of the character string variable. • ID-value specifies an overwriting value; it must be an ID-type variable or constant. If an integer or constant of non-ID type is specified, an error occurs. This value overwrites the specified character-string-variable-name. • The value is converted into a 86 series boundary (by 2 bytes) and then saved.
Related Item	MKS, MKB, MKW, MKI, MKF, CVB, CVW, CVI, CVF, CVID

Example of Program

```

conf
end conf
evnt
  input type%, id@, data%
  org$ = ``1234567``
  strdsp ..STR000, org$
  MKF org$, 2, id@
  strdsp ..STR001, org$
end evnt

```

' The character string will not be displayed
' correctly.

MKS

Statement

Function	The MKS statement stores data in any position of a character string variable.
Format	MKS character-string-variable-name, storage-position, character-string
Example of Use	MKS MOJIS, 5, "ABCD"
Description	<ul style="list-style-type: none">• The MKS statement stores a character string (<code>character-string</code>) in the position specified by <code>storage-position</code>, starting from the beginning of the specified <code>character-string-variable-name</code>.• <code>storage-position</code> must be a integer- or floating-point-type variable or constant. 1 specifies the beginning of the character string variable.• <code>character-string</code> specifies an overwriting character string; it must be a variable or constant.
Related Item	MKB, MKW, MKI, MKF, MKID, CVB, CVW, CVI, CVF, CVID

Example of Program

```
conf
end conf
evnt
  org$ = ``1234567''
  strdsp ..STR000, org$
  MKS org$, 2, ``76543''
  strdsp ..STR001, org$
end evnt
```

MKW

Statement

Function	The MKW statement stores data in any position of a character string variable.
Format	MKW character-string-variable-name, storage-position, integer-value
Example of Use	MKW MOJI\$, 5, VAR
Description	<ul style="list-style-type: none"> • The MKW statement stores two bytes of integer-value in the position specified by storage-position, starting from the beginning of the specified character-string-variable-name. • storage-position must be an integer- or floating-point-type variable or constant. 1 specifies the beginning of the character string variable. • integer-value specifies an overwriting value; it must be an integer- or floating-point-type variable or constant. When specified in integer-value, a floating-point-type variable or constant is converted to an integer. The two low-order bytes of this value overwrites the specified character-string-variable- name. • The value is converted into a 86 series boundary and saved.
Related Item	MKS, MKB, MKI, MKF, MKID, CVB, CVW, CVI, CVF, CVID

Example of Program

```

conf

end conf
evnt
    org$ = ``1234567``
    strdsp ..STR000, org$
    MKW org$, 2, &H3940
    strdsp ..STR001, org$
end evnt

```

MOVE

Statement

Function	The MOVE statement moves the specified part.
Format	MOVE part-name, X-direction-move-quantity, Y-direction-move-quantity, move-method
Example of Use	MOVE .BUHIN., 100, 20, 0
Description	<ul style="list-style-type: none"> part-name is the name of the part to be moved or the ID-type variable indicating the part to be moved. X-direction-move-quantity and Y-direction-move-quantity are the values indicating the distance in which the part is moved. When the upper left end on the display screen is (0,0), the coordinates in the right direction are X coordinates and those in the downward direction are Y coordinates. The move unit is specified in dots. X must be a numeric value from 0 to 639. Y must be a numeric value from 0 to 399 (GC55EM) or 0 to 479 (GC56LC). For absolute move, move-method is 0. For relative move, move-method is 1. Absolute move is referenced to the upper left end on the display screen. Relative move is referenced to the position of the current part.
Related Item	None

Example of Program

```

evnt
  input type,id@,data
  if type = 3 then
    buhin@ = .buhin2.
    MOVE buhin@ , 10 , 10 , 0
  endif
end evnt

```

MTRCOLOR

Statement

Function	The MTRCOLOR statement changes the needle color of the meter display.
Format	MTRCOLOR display-name, color-number
Example of Use	MTRCOLOR ..MTR000, 1
Description	<ul style="list-style-type: none">• The MTRCOLOR statement changes the needle color of the meter display.• control-name is the meter display name or the ID-type variable indicating the meter display.• color-number is the number indicating the needle color. Specify this color number with a numeric value from 0 to 15.
Related Item	MTRDSP

Example of Program

```
evnt
  input type%, id@, mcolor%
  MTRCOLOR ..MTR000, mcolor%
end evnt
```

MTRDSP

Statement

Function	The MTRDSP statement displays data in the meter display.
Format	MTRDSP control-name, display-data
Example of Use	MTRDSP .BUHIN.GRAPH, 30.0
Description	<ul style="list-style-type: none">• The MTRDSP statement displays data (value) in the meter display.• control-name is the meter display name or the ID-type variable indicating the meter display.• display-data is the numeric data to be displayed in the meter display.• display-value cannot be changed even if this statement is issued to the display for which operation parameters are set to “effective” in the primitive.
Related Item	MTRCOLOR

Example of Program

```
conf
  static name@
  name@ = ..MTR000
end conf
evnt
  input type%, id@, data%
  MTRDSP name@, data%
end evnt
```

NUMCOLOR

Statement

Function	The NUMCOLOR statement changes the colors and background figure of the numeric display.
Format	NUMCOLOR control-name, numeric-value-display-color, tile, display-color, background-color
Example of Use	NUMCOLOR ..GRAPH, 1, 2, 5, 2
Description	<ul style="list-style-type: none"> • The NUMCOLOR statement changes the display and background colors and tile in the numeric display. -1 indicates that the color and tile for which -1 was specified remain unchanged. • control-name is the numeric display name or the ID-type variable indicating the numeric display. • numeric-value-display-color is the numeric value indicating the color number of the numeric value display section. Specify this color number with a numeric value from 0 to 15. • tile indicates the tiling figure. Specify this tiling figure with a numeric value from 0 to 15. • display-color is the numeric value indicating the color number of the tile display section. Specify this color number with a numeric value from 0 to 15. • background-color is the numeric value indicating the color number of the tile background section. Specify this color number with a numeric value from 0 to 15.
Related Item	NUMDSP, NUMFORM

Example of Program

```

conf
  static name@
  name@ = ..NUM000
end conf
evnt
  input type%, id@, data%
  if type% = 3 then
    NUMCOLOR name@, 2, -1,-1,-1
  endif
end evnt

```

NUMDSP

Statement

Function	The NUMDSP statement displays data in the numeric display.
Format	NUMDSP control-name, display-data
Example of Use	NUMDSP .BUHIN.GRAPH, 30.0
Description	<ul style="list-style-type: none"> • The NUMDSP statement displays data (value) in the numeric display. • control-name is the numeric display name or the ID-type variable indicating the numeric display. • display-data is the numeric data to be displayed in the numeric display. • Specifying a primitive name in display-name when the numeric display is of continuous stage type enables the same data to be displayed for all the elements. When setting a value for each element, use the <i>GETID</i> function to obtain the control ID and specify this ID in control-name. • display-value cannot be changed even if this statement is issued to the display for which operation parameters are set to “effective” in the control.
Related Item	NUMCOLOR, NUMFORM

Example of Program

```

conf
  static name@
  name@ = ..NUM000
end conf
evnt
  input type%, id%, data%
  NUMDSP name@, data%
end evnt

```

NUMFORM

Statement

Function	The NUMFORM statement changes the display format of the numeric display.
Format	NUMFORM control-name, display-method, decimal-point-position
Example of Use	NUMFORM ..HYOJIKI, 0, 0
Description	<ul style="list-style-type: none"> • The NUMFORM statement changes the display method of the numeric display. This statement can also specify a display method and a decimal-point display position. • control-name is the numeric display name or the ID-type variable indicating the numeric display. • display-method is the numeric value indicating any of the following seven display methods: <ul style="list-style-type: none"> 0: Floating-point display method 1: Integer display method 2: Fixed-point display method 3: Binary fixed-point representation 4: Binary representation 5: Octal representation 6: Hexadecimal representation • decimal-point-position specifies where the decimal point is displayed when display-method is 2 (fixed-point display method). To display the decimal point in the first position from the right, specify 1. To display it in the second position from the right, specify 2. • Binary fixed-point representation is the method for writing a decimal point in the specified integer data position. • Be sure to execute the NUMDSP statement after executing this statement. Otherwise, display may be disordered.

Related Item NUMCOLOR, NUMDSP

Example of Program

```

evnt
  input type , id@,data
  var@ = .buhin.gamen
  NUMFORM var@ , data , 2
  numdsp var@ , 30.1
end evnt

```

OCT\$

Function

Function	The OCT\$ function converts a decimal character string to an octal character string.
Format	OCT\$ (numerical-expression)
Example of Use	OCT\$ (134)
Description	<ul style="list-style-type: none">• The OCT\$ function converts a decimal character string to an octal character string.• When a floating-point type is specified in numerical-expression, the decimal character string (numeric value) is converted to an integer type, then converted to an octal character string.• Specify the decimal character string (numeric value) within the range from -2147483648 to 2147483647.
Related Item	HEX\$, VAL

Example of Program

```
evnt
  input type , id@ , data
  moji$ = OCT$(data)
  strdsp ..STR000, moji$
end evnt
```



ONFERR

Statement

Function	The ONFERR statement specifies the destination to which error messages are to be transmitted.
Format	ONFERR destination
Example of Use	ONFERR .B000.
Description	<ul style="list-style-type: none"> • The ONFERR statement specifies the destination to which file operation function error messages are to be transmitted. • destination is a screen or part name or the ID-type variable indicating the screen or part name. • When data is received by INPUT, the screen or part to which a file operation function error message was transmitted can receive information such as a type (8) and data (error number).
Related Item	FOPEN, FCLOSE, FPRINT, FWRITE, FINPUT

Example of Program

```

conf
  ONFERR ..
end conf
evnt
  input ty%, id@, dat1%
  .....
end evnt

```

When an error occurs, 8 is set in ty% and an error code (number) is set in dat1%.

OPEN

Statement

Function	The OPEN statement opens (displays) the specified part.
Format	OPEN part-name, mode
Example of Use	OPEN .BUHIN., 1
Description	<ul style="list-style-type: none">• The OPEN statement opens (displays) the closed part on the screen.• part-name is the name of the part to be opened or the variable indicating the ID of the part to be opened.• mode specifies whether to execute the configuration block of the program attached to the part when the part is opened.<ul style="list-style-type: none">0: The configuration block is not executed.1: The configuration block is executed.
Related Item	CLOSE

Example of Program

```
evnt
  input type% , id@ , data%
  if pstat(.BUHIN.) = 3 then
    OPEN .BUHIN., 0
  endif
end evnt
```

OPENCOM

Statement

Function	The OPENCOM statement declares that the program receives data from a serial line.
Format	OPENCOM logical-device-name
Example of Use	OPENCOM HST
Description	<ul style="list-style-type: none"> The OPENCOM statement declares that the program receives data from the specified external connecting device. (When the host computer transmits data, this statement need not be declared.) logical-device-name specifies any of the following external connecting devices: <ul style="list-style-type: none"> HST: Host computer BCR: Bar code reader TKY: Ten-key pad
Related Item	CLOSE COM, REOPENCOM

Example of Program

```

conf
  OPENCOM HST
end conf
evnt
  input type% , id@ , data%
  if type% = 3 and data% = 1 then
    CLOSECOM HST
  else if type% = 3 and data% = 0 then
    REOPENCOM HST
  endif
end evnt

```

OPENPARALLEL

Statement

Function	The OPENPARALLEL statement declares that the program receives data from a parallel port.
Format	OPENPARALLEL input-bit, mode
Example of Use	OPENPARALLEL 3, 1
Description	<ul style="list-style-type: none"> • The OPENPARALLEL statement declares that the program receives data when the bit for specifying a parallel input port changes. • input-bit indicates the bit used to transmit data when the value changes. Specify this input bit with a numeric value from 0 to 15. • mode specifies the time when data is transmitted. The time when data is transmitted depends on how the bit changes. <ol style="list-style-type: none"> 1: Data is transmitted when the bit goes High. 2: Data is transmitted when the bit goes Low. 3: Data is transmitted when the bit goes High or Low.
Related Item	CLOSEPARALLEL, REOPENPARALLEL

Example of Program

```

conf
    OPENPARALLEL 3
end conf
evnt
    input type% , id@ , data%
    if type% = 3 and data% = 1 then
        CLOSEPARALLEL 3
    else if type% = 3 and data% = 0 then
        REOPENPARALLEL 3
    endif
end evnt

```

OPENSIO

Statement

Function	The OPENSIO statement opens a non-protocol communication port.
Format	OPENSIO port-number, mode, reception-buffer
Example of Use	OPENSIO 1, 1, moji\$
Description	<ul style="list-style-type: none"> • The OPENSIO statement opens a port for starting non-procedural communication. • port-number specifies a channel that performs non-procedural communication. CH1 to CH3 correspond to 1 to 3, respectively. • mode specifies the type of non-procedural communication. Specify 0 (binary mode) or 1 (text mode). • reception-buffer specifies the name of the variable to which the data to be received from an external device is to be written. The variable to be specified must be a global or static character string variable. • When the condition is satisfied after data has been received from a connecting device, a reception completion message is issued to the part or screen that executed this statement. Two or more parts cannot execute the OPENSIO statement for the same port. <p>Binary mode: In the binary mode, all codes from 0 to 0FFh can be transmitted and received. In this mode, read and write are also enabled by specifying the length of received data.</p> <p>Text mode: In the text mode, codes from 1 to 0FFh can be transmitted and received. In this mode, the end codes of texts are also set and used. The end codes are used to judge the data to be received.</p>
Related Item	CLOSESIO, SETSIO, WRITESIO, WRITWSIOB, FLUSH, IOCTL

Example of Program

```

conf
  global buf$ * 200
  OPENSIO 2 , 1 , buf$
  setsio 2 , &HD
end conf
evnt
  strdsp ..STR000 , buf$
  closesio 2
end evnt

```

OPENTIM

Function

Function	The OPENTIM function allocates timer resources.
Format	OPENTIM ()
Example of Use	VAR@ = OPENTIM ()
Description	<ul style="list-style-type: none"> • The OPENTIM function allocates the resources necessary to use a timer. • The OPENTIM function must be an ID-type variable because it returns the ID of the timer to be used. • The allocated ID can be used to set the timer. • The system can use up to 16 timers. The timers not to be used must be returned to the system. (See “CLOSETIM.”) • The OPENTIM function can be used by the screen or part program being displayed. (If this function is executed on an undisplayed rear screen, an error occurs.) • The allocated timer is not deallocated even if one screen changes to another. If the timer is being used by the event type, a message is also issued to the rear screen.
Related Item	CLOSETIM, STARTTIM, STOPTIM, CONTTIM, WRITETIM, READTIM

Example of Program

```

conf
  static timid@
  timid@ = OPENTIM()
  settim timid@, 20, 0
  starttim timid@
end conf
evnt
  input type% , id@ , data%
  if type% = 3 and id@ = ..SWT000 then
    stoptim timid@
  else if id@ = ..SWT001 then
    closetim timid@
  end if
end evnt

```

OPENTIM2

Function

Function	The OPENTIM2 function allocates (opens) the timer to be used.
Format	RET = OPENTIM2 (timer-number)
Example of Use	RET = OPENTIM2 (14)
Description	<ul style="list-style-type: none"> • The OPENTIM2 function opens the timer specified in timer-number. • timer-number specifies the number of the timer to be used. Specify this timer number with an integer-type value from 0 to 15. • When the OPENTIM2 function is executed, any of the following value is returned: <ul style="list-style-type: none"> 0: The timer could be opened. 1: The timer could not be opened. • The OPENTIM2 function can be used by the screen or part program being displayed. (If this function is executed on an undisplayed rear screen, an error occurs.) • The allocated timer is not deallocated even if one screen changes to another. If the timer is being used by the event type, a message is also issued to the rear screen.
Related Item	CLOSETIM, STARTTIM, STOPTIM, CONTTIM, SETTIM, READTIM, OPENTIM

Example of Program

```

conf
  static timid@
  ret=OPENTIM2(5)
  setim 5, 20, 0
  starttim 5
end conf
evnt
  input type% , id@ , data%
  if type% = 3 and id@ = ..SWT000 then
    stoptim 5
  else if id@ = ..SWT001 then
    closetim 5
  end if
end evnt

```

OPENTIM3

Function

Function	The OPENTIM3 function allocates (opens) the timer to be used.
Format	RET = OPENTIM3 (timer-number)
Example of Use	RET = OPENTIM3 (14)
Description	<ul style="list-style-type: none">• The OPENTIM3 function opens the timer specified in timer-number.• timer-number specifies the number of the timer to be used. Specify this timer number with an integer-type value from 0 to 15.• When the OPENTIM2 function is executed, any of the following value is returned:<ul style="list-style-type: none">0: The timer could be opened.1: The timer could not be opened.• When the screen for which “open” was declared changes to another, the opened timer is automatically closed.• The OPENTIM3 function can be used by the screen or part program being displayed. (If this function is executed on an undisplayed rear screen, an error occurs.)
Related Item	CLOSETIM, STARTTIM, STOPTIM, CONTTIM, SETTAM, READTIM, OPENTIM

Example of Program

```
conf
  ret = opentim3 (3)
  settim 3 , 20, 1
  stoptim 3
  closetim 3
end conf
```

OUT

Statement

Function	The OUT statement writes 2-byte data to an I/O port.
Format	OUT port-number, output-data
Example of Use	OUT 0, &H20
Description	<ul style="list-style-type: none">• Currently, data can be written only to parallel I/O ports.• port-number specifies the number of the I/O port inserted into the option bus. (For the color/plasma, this port number is fixed at 0.)
Related Item	INP

Example of Program

```
evnt
  input type,id@,data
  out 0, data
end evnt
```

OUTBIT

Statement

Function	The OUTBIT statement rewrites the specified BIT number of the specified output port.
Format	OUTBIT port-number, BIT-number, write-data
Example of Use	OUTBIT 0, 10, 1
Description	<ul style="list-style-type: none">• The OUTBIT statement rewrites the specified BIT number of the specified output port.• Specify port-number and BIT-number with an integer value relative to 0.• When write-data is 0, the output is set to OFF. When 1, the output is set to ON.• The lowest-order bit number of the parallel IO is 0 and the next lowest-order bit number is 1. That is, the BIT number is sequentially incremented.• If an unexisting port or BIT number is specified, an error occurs.
Related Item	INP, OUT, INPBIT, OUTBITSTAT, OUTSTAT

Example of Program

```
evnt
DATA% = INPBIT(0,3)
  if data% = 0 then
    outbit 0,3,1
  endif
end evnt
```

OUTBITSTAT

Function

Function	The OUTBITSTAT function reads the specified BIT number of the specified output port.
Format	OUTBITSTAT (port-number, BIT-number)
Example of Use	DATA% = OUTBITSTAT (0,10)
Description	<ul style="list-style-type: none">• The OUTBITSTAT function reads the specified BIT number of the specified output port.• Specify port-number and BIT-number with an integer value relative to 0.• The lowest-order bit number of the parallel IO is 0 and the next lowest-order bit number is 1. That is, the BIT number is sequentially incremented.• If an unexisting port or BIT number is specified, 0 is returned.
Related Item	INP, OUT, INPBIT, OUTBIT, OUTSTAT

Example of Program

```
evnt
  data% = outbitstat(0,3)
  if data% = 0 then
    outbit 0,3,1
  endif
end evnt
```

OUTSTAT

Function

Function	The OUTSTAT function reads the value of the specified output port.
Format	OUTSTAT (port-number)
Example of Use	DATA% = OUTSTAT (0)
Description	<ul style="list-style-type: none">• The OUTSTAT function reads the value of the specified output port.• Specify port-number with an integer value relative to 0.• If an unexisting port number is specified, 0 is returned.
Related Item	INP, OUT, INPBIT, OUTBIT, OUTBITSTAT

Example of Program

```
evnt
  data% = outstat(0)
  if data% = 0 then
    out 0,&hffff
  endif
end evnt
```

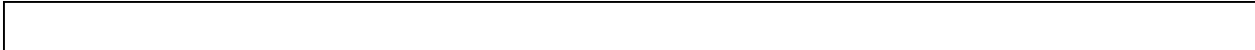

PIPCOLOR

Statement

Function The PIPCOLOR statement changes the OFF, ON1, and ON2 colors of the pipe display.

Format LAMPCOLOR display-name, ON-OFF-number, color-number

Example of Use LAMPCOLOR .BUHIN.GRAPH, 5

Description The PIPCOLOR statement changes the OFF, ON1, and ON2 colors of the pipe display.

- **display-name** is the name of the pipe display or the variable indicating the ID of the pipe display.
- **ON-OFF-number** specifies 0, 1, or 2 for OFF, ON1, or ON2.
- **color-number** specifies the color to be displayed when the lamp display is on with a numeric value from 0 to 15.

Related Item PIPDSP

Example of Program

```
conf
  pipdsp .buhin.graph , 0
  PIPCOLOR .buhin.graph ,1 ,7
  lampdsp .buhin.graph , 1
end conf
```

PIPDSP

Statement

Function	The PIPDSP statement displays data in the pipe display.
Format	PIPDSP control-name, pipe-mode
Example of Use	PIPDSP .BUHIN.GRAPH, 1
Description	<p>The PIPDSP statement sets the pipe display to OFF, ON1, or ON2 for data display.</p> <ul style="list-style-type: none">• control-name is the name of the pipe display or the variable indicating the ID of the pipe display.• pipe-mode sets the pipe display to OFF, ON1, or ON2; it specifies 0, 1, or 2 for OFF, ON1, or ON2.• Display cannot be changed even if the PIPDSP statement is issued to the display for which the operation parameters of the control are set to “effective.”
Related Item	PIPCOLOR

Example of Program

```
conf
  pipdsp .buhin.pip , 0
  PIPCOLOR .buhin.pip ,1 ,7
  pipdsp .buhin.pip , 1
end conf
```

PLTCOLOR

Statement

Function	The PLTCOLOR statement changes the colors and background figure of the plot display.
Format	PLTCOLOR control-name, plot-color, tile, display-color, background-color
Example of Use	PLTCOLOR ..GRAPH, 1, 1, 2, 1
Description	<ul style="list-style-type: none"> • The PLTCOLOR statement changes the background tile and colors of the plot display. -1 indicates that the color and tile for which -1 was specified remain unchanged. • control-name is the plot display name or the ID-type variable indicating the plot display. • plot-color indicates the display color of a dot. Specify this plot color with a numeric value from 0 to 15. • tile indicates the background tiling figure of the graph. • Specify this tiling figure with a numeric value from 0 to 15. • display-color is the numeric value indicating the color number of the tile display section. Specify this color number with a numeric value from 0 to 15. • background-color is the numeric value indicating the color number of the tile background section. Specify this color number with a numeric value from 0 to 15.
Related Item	PLTDSP

Example of Program

```

conf
    static name@
    name@ = ..PLT000
end conf
evnt
    input type%, id@, data%
    if type% = 3 then
        PLTCOLOR name@, 2, 3, 1, 4
    endif
end evnt

```

PLTDSP

Statement

Function	The PLTDSP statement displays data in the plot display.
Format	PLTDSP control-name, display-coordinate-X, display-coordinate-Y
Example of Use	PLTDSP .BUHIN.GRAPH, 15, 30
Description	<ul style="list-style-type: none"> • The PLTDSP statement displays data in the plot display. • display-name is the plot display name or the ID-type variable indicating the plot display. • display-coordinate-X and display-coordinate-Y are the numeric data indicating the coordinates to be displayed in the plot display. • display-value cannot be changed even if this statement is issued to the display for which operation parameters are set to “effective” in the control.
Related Item	PLTCOLOR

Example of Program

```

conf
  static name@
  name@ = ..PLT000
end conf
evnt
  input type%, id@, x%,y%
  if type% = 3 then
    PLTDSP name@, x%, y%
  endif
end evnt

```



PMODE

Statement

Function The PMODE statement changes the status of the specified part.

Format PMODE part-name, mode

Example of Use PMODE .BUHIN., 3

Description

- **part-name** is the name of the part whose status is to be modified or the ID-type variable indicating the part.
- **mode** indicates the status to be modified.
 - 0: Normal status
 - 1: Switch input disable status
 - 2: Half tone status

Related Item PSTAT

Example of Program

```

evnt
  input type% , id@ , data%
  if pstat(.BUHIN.) = 0 then
    PMODE .BUHIN., 1
  endif
end evnt

```

PRDSP

Statement

Function	The PRDSP statement redisplay the specified control.
Format	PRDSP control-name
Example of Use	PRDSP .BUHIN.PRIM
Description	<ul style="list-style-type: none">control-name is the name of the control to be redisplayed or the ID-type variable indicating the control.
Related Item	BARSET, CIRSET, BLTSET, LNESET

Example of Program

```
evnt
  lneset .buhin.graph , 3 , 8 , 20.1
  lneset .buhin.graph , 3 , 8 , 20.1
  PRDSP .buhin.graph
end evnt
```

--

PREVJUMP

Statement

Function	The PREVJUMP statement jumps to the immediately preceding screen.
Format	PREVJUMP
Example of Use	PREVJUMP
Description	<ul style="list-style-type: none">• The PREVJUMP statement jumps to the screen displayed before the current screen according to the recorded screen transition path.• Up to 30 screens can be recorded. The PREVJUMP statement cannot jump to a screen before the recorded 30 screens.
Related Item	JUMP

Example of Program

```
conf
end conf
evnt
    input type% , id@ , data%
    if id@ = ..SWT000 then PREVJUMP
end evnt
```

PRINT

Statement

Function	The PRINT statement writes messages.
Format	PRINT expression [, expression]
Example of Use	PRINT 23, "ABCD", XYZ, MOJIS
Description	<ul style="list-style-type: none">• The PRINT statement writes the messages to be output the screen, part, serial port, or parallel port.• When two or more messages are written, delimit them in commas (,).• Messages are not output when the PRINT statement is executed; they are output for the first time when the SEND command is executed.• When messages are output to the host computer, commas (,) are inserted to delimit data.
Related Item	INPUT, SEND

Example of Program

```
evnt
  input type% , id@ , data%
  if type% = 3 then
    PRINT "ABCD", data%
    send .B000.
  endif
end evnt
```

PRMCTL

Statement

Function	The PRMCTL statement changes the attributes of the specified primitive.
Format	PRMCTL1 control-name, request-code, control-value-1 PRMCTL2 control-name, request-code, type-1, control-value-1 PRMCTL3 control-name, request-code, type-1, control-value-2 PRMCTL4 control-name, request-code, type-1, type-2, control-value-1
Example of Use	PRMCTL1 ..NUM000, _PD_STAT, 3 PRMCTL2 ..NUM000, _PD_DCOLOR, 3, 4 PRMCTL3 ..LNE000, _PD_RANGE, 0, 2.5 PRMCTL4 ..BAR000, _PD_PTRN, 1, 0, 12
Description	<ul style="list-style-type: none"> • The PRMCTL statement changes the attributes of the specified control. This statement is classified into four types: PRMCTL1, PRMCTL2, PRMCTL3, and PRMCTL4. • control-name is the constant indicating the control to be changed or the ID-type variable indicating the ID of the control. • request-code specifies what attribute changes is to be performed. The types of request codes are shown on the next and subsequent pages. • type-1 and type-2 depend on the request code to be specified. • control-value-1 specifies the value corresponding to the specified request code; it must be an integer-type constant or variable. • control-value-2 specifies the value corresponding to the specified request code; it must be a floating-point constant or variable.
Related Item	PRMCTL1, PRMCTL2, PRMCTL3, PRMCTL4, PRMSTAT1, PRMSTAT2, PRMSTAT3, PRMSTAT4

Example of Program

```

conf
end conf
evnt
    status% = prmstat1(..NUM000, _PD_STAT)
    if status% = 0 then
        PRMCTL1 ..NUM000, _PD_STAT, 2
    endif
end evnt

```

- The types and usage of the request codes that can be used by PRMCTL1 are explained below.

1._PD_STAT

Function: _PD_STAT changes the display format (normal/reversal video/blinking/on-and-off) of a control.

Range: _PD_STAT is applicable to all controls.

Control-value: Set one of the following numeric values indicating the display format:

- 0: Normal display
- 1: Reversal video display
- 2: Blinking
- 3: On-and-off display

2._PD_DSPFMT

Function: _PD_DSPFMT changes the display format of a control.

Range: _PD_DSPFMT is applicable to numeric and character displays.

Control-value: The control value depends on whether the numeric or character display is used.

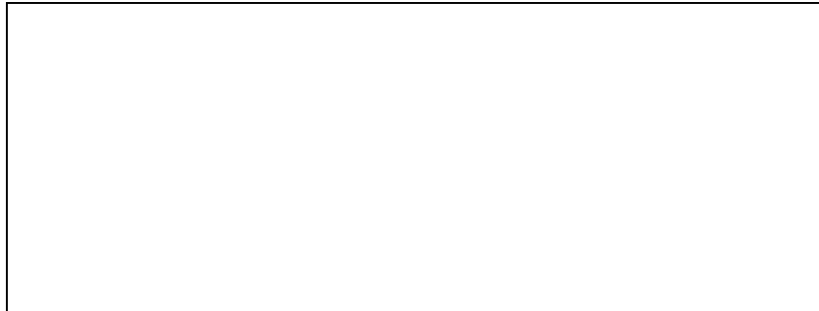

3._PD_PTPOS

Function: _PD_PTPOS changes the position of a decimal point.

Range: _PD_PTPOS is applicable only to numeric displays.

Control-value: Set a value indicating the position of a decimal point. If a negative value is set, PRMCTL1 forcibly changes it to 0.

4._PD_ZSPRS

Function: _PD_ZSPRS sets zero suppression operation.

Range: _PD_ZSPRS is applicable only to numeric displays.

Control-value: When not perform zero suppression, set 0. When performing zero suppression, set 1.

5._PD_FIGMD

Function: _PD_FIGMD sets whether to match the size of the graphic to be displayed on a graphic display with that of the display.

Range: _PD_FIGMD is applicable only to graphic displays.

Control-value: When not matching the size of the graphic with that of the graphic display, set 0. When matching the size of the graphic with that of the graphic display, set 1.

6._PD_WSIZ

Function: _PD_WSIZ changes the dot size or line width of a display.
 Range: _PD_WSIZ is applicable to plot, meter, and pipe displays.
 Control-value: For a plot display, set the dot size (small to large) with a numeric value from 0 to 2. For a meter display, set the line width (narrow to wide) with a numeric value from 0 to 2. For a pipe display, set the thickness (1, 3, 5, or 7) with a numeric value from 0 to 3.

7._PD_PIPSTAT

Function: _PD_PIPSTAT changes the ON or OFF status of a lamp or pipe display.
 Range: _PD_PIPSTAT is applicable to lamp and pipe displays.
 Control-value: Set the ON and OFF statuses of the lamp and pipe displays as follows:

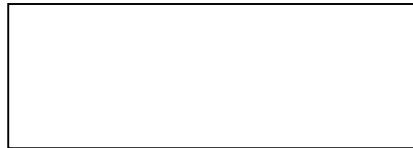

8._PL_FIRST

Function: _PL_FIRST changes the start registration number of the registration graphic or character string to be displayed.
 Range: _PL_FIRST is applicable to character and graphic displays.
 Control-value: Set the value you want to use as the start registration number.

9._PL_SMPMSG

Function: _PL_SMPMSG specifies whether to issue messages to the part on which the control is placed when sampling is performed by the control.
 Range: _PL_SMPMSG is applicable to plot, bar graph, and line chart displays.
 Control-value: When issuing messages to the part, set 1. When not issuing messages, set 0.

10._PL_SMPCTL

Function: _PL_SMPCTL controls sampling. (“Stop”, “start”, and “reset”)
 Range: _PL_SMPCTL is applicable to plot, bar graph, and line chart displays.
 Control-value: “Stop” stops sampling. “Start” starts sampling from the stop status. “Reset” clears display and starts sampling from the beginning.
 0: Sampling is stopped.
 1: Sampling is started.
 2: Sampling is reset.

11._PL_SMPTME

Function: _PL_SMPTME changes a sampling time.
 Range: _PL_SMPTME is applicable to plot, bar graph, and line chart displays.
 Control-value: Set a value indicating the sampling time (setting value* 0.5 second). When the sampling time is changed, sampling is started after it has been reset (see “_PL_SMPCLT”).

12._PL_DIRECT

Function: _PL_DIRECT changes the display direction of a line chart.
 Range: _PLI_DIRECT is applicable only to line chart displays.
 Control-value: When changing the display direction of the line chart from right to left, set 0. When changing the display direction from left to right, set 1. This direction change is meaningless if sampling is not performed. When the display direction is changed, sampling is started after it has been reset (see “_PL_SMPCLT”).

13._SW_RACT

Function: _SW_RACT sets whether to perform reverse operation when a switch is ON.
 Range: _SW_RACT is applicable to switches and selector switches.
 Control-value: To perform reverse operation when a switch is ON, set 1. Not to perform reverse operation, set 0.

14._SW_BZER

Function: _SW_BZER sets whether to sound the buzzer when a switch is ON.
 Range: _SW_BZER is applicable to switches and selector switches.
 Control-value: To sound the buzzer when a switch is pressed, set 1. Not to sound the buzzer, set 0.

15._SW_STAT

Function: _SW_STAT changes the status (normal operation/ input disable/half-tone) of a switch.
 Range: _SW_STAT is applicable to switches and selector switches.
 Control-value: Set one of the following numeric values indicating the switch status:
 0: Normal operation status
 1: Input disable status
 2: Half-tone status

16._SW_BMODE

Function: _SW_BMODE changes the switch background color display method.
 Range: _SW_BMODE is applicable to switches and selector switches.
 Control-value: When changing the switch background color display method to “direct display”, set 0. When changing the display method to “replacement display”, set 1.

17._SW_ONCOLOR

Function: _SW_ONCOLOR sets a switch-ON background color.
 Range: _SW_ONCOLOR is applicable to switches and selector switches.
 Control-value: Set the number of the switch-ON background color to be used with a numeric value from 0 to 15.

18. `_SW_OFFCOLOR`

Function: `_SW_OFFCOLOR` sets a switch-OFF background color.
 Range: `_SW_OFFCOLOR` is applicable to switches and selector switches.
 Control-value: Set the number of the switch-OFF background color to be used with a numeric value from 0 to 15.

19. `_SW_ONOFF`

Function: `_SW_ONOFF` changes the ON/OFF status of a switch. (Executing `_SW_ONOFF` for the switch for synchronous operation causes an error.)
 Range: `_SW_ONOFF` is applicable to switches and selector switches.
 Control-value: When changing a switch to the OFF status, set 0. When changing a switch to the ON status, set 1. When changing all selector switches to the OFF status, set 0. When changing one of the selector switches to the ON status, set the corresponding element number.

- The types and usage of the request codes that can be used by PRMCTL2 are explained below.

1. `_PD_DCOLOR`

Function: `_PD_COLOR` changes the display color of a display.
 Range: `_PD_DCOLOR` is applicable to the ON color specification of numeric, character, clock, plot, free graph, meter, and lamp displays.
 Type: Specify one of the following:
 0: Figure change
 1: Fore color change
 2: Back color change
 3: Display color change
 Control-value: Set the number of the display color to be changed with a numeric value from 0 to 15.

2. `_PD_BCOLOR`

Function: `_PD_BCOLOR` changes the background color of a control.
 Range: `_PD_BCOLOR` is applicable to numeric, character, clock, plot, bar graph, line chart, and free graph displays.
 Type: Specify one of the following:
 0: Figure change
 1: Fore color change
 2: Back color change
 Control-value: Set the number of the background color to be changed with a numeric value from 0 to 15.

3. `_PD_PIPCOLOR`

Function: `_PD_PIPCOLOR` changes the internal color of a pipe or lamp display.
 Range: `_PD_PIPCOLOR` is applicable to pipe and lamp displays.
 Type: Specify one of the following:
 0: Change of OFF display color (valid for pipe and lamp displays)
 1: Change of ON1 display color (valid for pipe and lamp displays)
 2: Change of ON2 display color (valid for pipe displays)
 Control-value: Set the number of the internal color to be changed with a numeric value from 0 to 15.

4. **_PD_BSLNE**
Function: **_PD_BSLNE** changes the type of a base line or a reference line.
Range: **_PD_BSLNE** is applicable to bar graphs and line charts.
Type: Specify one of the following:
 0: Change of base line type
 1: Change of reference line 1 type
 2: Change of reference line 2 type
Control-value: Set the number of the line type to be changed with a numeric value from 0 to 3.
5. **_PD_BSCOLOR**
Function: **_PD_BSCOLOR** changes the color of a base line or a reference line.
Range: **_PD_BSCOLOR** is applicable to bar graphs and line charts.
Type: Specify one of the following:
 0: Change of base line color
 1: Change of reference line 1 color
 2: Change of reference line 2 color
Control-value: Set the number of the line color to be changed with a numeric value from 0 to 15.
6. **_SW_ONFIG**
Function: **_SW_ONFIG** changes a switch-ON display graphic.
Range: **_SW_ONFIG** is applicable to switches and selector switches.
Type: For a switch, specify 1. For a selector switch, specify the element number of the switch whose ON graphic is to be changed. The element number starts at 1.
Control-value: Specify the registration graphic number displayed when a switch is ON.
7. **_SW_OFFFIG**
Function: **_SW_OFFFIG** changes a switch-OFF display graphic.
Range: **_SW_OFFFIG** is applicable to switches and selector switches.
Type: For a switch, specify 1. For a selector switch, specify the element number of the switch whose OFF graphic is to be changed. The element number starts at 1.
Control-value: Specify the registration graphic number displayed when a switch is OFF.

- The types and usage of the request codes that can be used by PRMCTL3 are explained below.

1. `_PD_RANGE`

Function: `_PD_RANGE` sets the display range of a display.
 Range: `_PD_RANGE` is applicable to bar graph, line chart, free graph, slide, meter, and plot displays.
 Type: When the plot display is used, specify 0 (Xmin change), 1 (Xmax change), 2 (Ymin change), or 3 (Ymax change). When the bar graph, line chart, free graph, slide, or meter display is used, specify 2 (minimum change) or 3 (maximum change).
 Control-value: Set the value (display range) to be changed.

2. `_PD_BSVL`

Function: `_PD_BSVL` changes the setting value of a base or reference line.
 Range: `_PD_BSVL` is applicable to bar graph and line chart displays.
 Type: Specify 0 (base line change), 1 (change of reference line 1), or 2 (change of reference line 2).
 Control-value: Set the value to be changed.

- The types and usage of the request codes that can be used by PRMCTL4 are explained below.

1. `_PD_PTRN`

Function: `_PD_PTRN` changes the display color of a control.
 Range: `_PD_PTRN` is applicable to bar graph, 100 percent bar chart, and pie chart displays.
 Type-1: Specify the number of the bar or zone whose display color is to be changed.
 Type-2: Specify one of the following:
 0: Figure change
 1: Fore color change
 2: Back color change
 Control-value: Set the number of the display color to be changed with a numeric value from 0 to 15.

2. `_PD_LNE`

Function: `_PD_LNE` changes the display color of a line chart.
 Range: `_PD_LNE` is applicable only to line charts.
 Type-1: Specify the number of the line whose display color is to be changed.
 Type-2: Specify one of the following:
 0: Line type change
 1: Line color change
 Control-value: Set the number of the display color to be changed with a numeric value from 0 to 15.

PRMSTAT

Function

Function	The PRMSTAT function reads the attributes of the specified primitive.
Format	<pre>return-value-1 = PRMSTAT1 (control-name, request-code) return-value-1 = PRMSTAT2 (control-name, request-code, type-1) return-value-2 = PRMSTAT3 (control-name, request-code, type-1) return-value-1 = PRMSTAT4 (control-name, request-code, type-1, type-2)</pre>
Example of Use	<pre>VAL% = PRMSTAT1 (..NUM000, _PD_STAT) VAL% = PRMSTAT2 (..NUM000, _PD_DCOLOR, 3) VALF! = PRMSTAT3 (..LNE000, _PD_RANGE, 0) VAL% = PRMSTAT4 (..BAR000, _PD_PTRN, 1, 0)</pre>
Description	<ul style="list-style-type: none"> • The PRMSTAT function reads the attributes of the specified primitive. This function is classified into four types: PRMSTAT1, PRMSTAT2, PRMSTAT3, and PRMSTAT4. • control-name is the constant indicating the primitive to be read or the ID-type variable indicating the ID of the control. • request-code specifies the attributes to be read. The types of request codes are shown on the next and subsequent pages. • type-1 and type-2 depend on the request code to be specified. • return-value-1 is the return value of the function corresponding to the specified request code; it must be an integer-type constant or variable. • return-value-2 is the return value of the function corresponding to the specified request code; it must be a floating-point constant or variable.
Related Item	PRMCTL1, PRMCTL2, PRMCTL3, PRMCTL4, PRMSTAT1, PRMSTAT2, PRMSTAT3, PRMSTAT4

Example of Program

```
conf
end conf
evnt
    status% = prmstat1(..NUM000, _PD_STAT)
    if status% = 0 then
        PRMCTL1 ..NUM000, _PD_STAT, 2
    endif
end evnt
```



- The types and usage of the request codes that can be used by PRMSTAT1 are explained below.

1. `_PD_NUMS`

Function: `_PD_NUMS` reads the number of control elements.

Range: `_PD_NUMS` is applicable to all display controls.

Return-value-1: The value indicating the display format is set. When the display format is not “continuous-stage type”, 1 is always set.

2. `_PD_ROTATE`

Function: `_PD_ROTATE` reads the rotation direction of a control .

Range: `_PD_ROTATE` is applicable to all display controls.

Return-value-1: For 0 degree, 0 is returned. For 90 degrees, 1 is returned. For 180 degrees, 2 is returned. For 270 degrees, 3 is returned. For pie chart, meter, lamp, and pipe displays, 0 is always returned.

3. `_PD_STAT`

Function: `_PD_STAT` reads the display format (normal/reverse video display/blinking/on-and-off display) of a control.

Range: `_PD_STAT` is applicable to all controls.

Return-value: One of the following values is returned:

0: Normal display

1: Reverse video display

2: Blinking

3: On-and-off display

4. `_PD_DSPFMT`

Function: `_PD_DSPFMT` reads the display format of a control.

Range: `_PD_DSPFMT` is applicable to numeric and character controls.

Return-value-1: The value to be returned depends on whether the numeric or character display is used.



5. `_PD_DATFMT`

Function: `_PD_DATFMT` reads the display data format.

Range: `_PD_DATFMT` is applicable to all controls except for clock displays.

Return-value: For a real number, 0 is returned. For an integer, 1 is returned. For an unsigned integer, 2 is returned. For a BCD, 3 is returned. (For the lamp primitive, 2 is always returned.)

6. `_PD_FONT`
 - Function: `_PD_FONT` reads the type of the font displayed on the control.
 - Range: `_PD_FONT` is applicable to numeric and clock displays.
 - Return-value: For half-size character display, 0 is returned. For full-size character display, 1 is returned.
7. `_PD_XFSZ`
 - Function: `_PD_XFSZ` reads the horizontal-direction size of the font displayed on the control.
 - Range: `_PD_XFSZ` is applicable to numeric, character, and clock displays.
 - Return-value: For 1 magnification, 0 is returned. For 2 magnifications, 1 is returned. For 4 magnifications, 2 is returned. For 8 magnifications, 3 is returned. For 16 magnifications, 4 is returned.
8. `_PD_YFSZ`
 - Function: `_PD_YFSZ` reads the vertical-direction size of the font displayed on the control.
 - Range: `_PD_YFSZ` is applicable to numeric, character, and clock displays.
 - Return-value: For 1 magnification, 0 is returned. For 2 magnifications, 1 is returned. For 4 magnifications, 2 is returned. For 8 magnifications, 3 is returned. For 16 magnifications, 4 is returned. For 32 magnifications, 5 is returned.
9. `_PD_PTPOS`
 - Function: `_PD_PTPOS` reads the position of a decimal point.
 - Range: `_PD_PTPOS` is applicable only to numeric displays.
 - Return-value: The position of the decimal point is returned.
10. `_PD_ZSPRS`
 - Function: `_PD_ZSPRS` reads whether to perform zero suppression.
 - Range: `_PD_ZSPRS` is applicable only to numeric displays.
 - Return-value: When zero suppression is not performed, 0 is returned. When zero suppression is performed, 1 is returned.
11. `_PD_XNUM`
 - Function: `_PD_XNUM` reads the number of horizontal-direction display digits.
 - Range: `_PD_XNUM` is applicable to numeric and character displays.
 - Return-value: The number of characters that can be displayed when horizontal-direction half-size conversion is performed is returned.
12. `_PD_YNUM`
 - Function: `_PD_YNUM` reads the number of vertical-direction display digits.
 - Range: `_PD_YNUM` is applicable only to character displays.
 - Return-value: The number of characters that can be displayed in the vertical direction is returned.
13. `_PD_DIRECT`
 - Function: `_PD_DIRECT` reads the display direction of a character display.
 - Range: `_PD_DIRECT` is applicable only to character displays.
 - Return-value: For horizontal writing, 0 is returned. For columnar writing, 1 is returned.

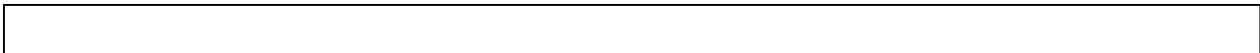

14. **_PD_PLTNUM**
 Function: **_PD_PLTNUM** reads the maximum number of plots that can be displayed on the control.
 Range: **_PD_PLTNUM** is applicable to plot and line chart displays.
 Return-value: The maximum number of plots that can be displayed is returned.
15. **_PD_LNENUM**
 Function: **_PD_LNENUM** reads the number of bars and lines that can be displayed on the control.
 Range: **_PD_LNENUM** is applicable to plot and line chart displays.
 Return-value: The maximum number of bars and lines that can be displayed is returned.
16. **_PD_ZNNUM**
 Function: **_PD_ZNNUM** reads the number of zones that can be displayed on the control.
 Range: **_PD_ZNNUM** is applicable to pie chart and 100 percent bar chart displays.
 Return-value: The number of zones that can be displayed is returned.
17. **_PD_FIGMD**
 Function: **_PD_FIGMD** reads whether to match the size of the graphic to be displayed on a graphic display with that of the display.
 Range: **_PD_FIGMD** is applicable only to graphic displays.
 Return-value: When matching the size of the graphic with that of the graphic display, set 1. When not matching the size of the graphic with that of the graphic display, set 1.
18. **_PD_WSIZ**
 Function: **_PD_WSIZ** reads the dot size or line width of a control.
 Range: **_PD_WSIZ** is applicable to plot, meter, and pipe displays.
 Return-value: For a plot display, the numeric value (0 to 2) indicating the dot size (small to large) is returned. For a meter display, the numeric value (0 to 2) indicating the line width (narrow to wide) is returned. For a pipe display, the numeric value (0 to 3) indicating the thickness (1, 3, 5, or 7) is returned.
19. **_PD_PIPSTAT**
 Function: **_PD_PIPSTAT** reads the ON or OFF status of a lamp or pipe display.
 Range: **_PD_PIPSTAT** is applicable to lamp and pipe displays.
 Return-value: Any of the following values indicating the ON or OFF status of the lamp or pipe display is returned:

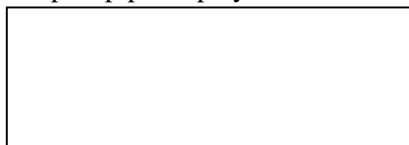

20. `_PL_NUMS`
Function: `_PL_NUMS` reads the number of devices being used.
Range: `_PL_NUMS` is applicable to all controls except for clock displays.
Return-value: The number of devices being used is returned. (When a doubleword is specified for a numeric display, the number of devices is doubled.)
21. `_PL_FIRST`
Function: `_PL_FIRST` reads the start registration number of the registration graphic or character string to be displayed.
Range: `_PL_FIRST` is applicable to character and graphic displays.
Return-value: The start registration number to be displayed is returned.
22. `_PL_DVTYP`
Function: `_PL_DVTYP` reads the type of the device being used by the control.
Range: `_PL_DVTYP` is applicable only to numeric displays.
Return-value: For a doubleword, 0 is returned. For a single word, 1 is returned.
23. `_PL_ENDI`
Function: `_PL_ENDI` reads the doubleword display method.
Range: `_PL_ENDI` is applicable only to numeric displays.
Return-value: When doublewords are displayed from downward to upward, 0 is returned. When doublewords are displayed from upward to downward, 1 is returned.
24. `_PL_SMPMSG`
Function: `_PL_SMPMSG` reads whether to issue messages to the part on which the control is placed when sampling is performed by the control.
Range: `_PL_SMPMSG` is applicable to plot, bar graph, and line chart displays.
Return-value: When messages are issued to the part, 1 is returned. When no message is issued, 0 is returned.
25. `_PL_SMPTME`
Function: `_PL_SMPTME` reads a sampling time.
Range: `_PL_SMPTME` is applicable to plot, bar graph, and line chart displays.
Return-value: A value indicating the sampling time (read value* 0.5 second) is returned.
26. `_PL_DIRECT`
Function: `_PL_DIRECT` reads the display direction of a line chart.
Range: `_PLI_DIRECT` is applicable only to line chart displays.
Return-value: When line charts are displayed from right to left, 0 is returned. When they are displayed from left to right, 1 is returned.
27. `_SW_NUMS`
Function: `_SW_NUMS` reads the number of switch elements.
Range: `_SW_NUMS` is applicable to switches and selector switches.
Return-value: For a switch, 1 is always returned. For a selector switch, the number of elements is returned.

28. **_SW_TYPE**
Function: `_SW_TYPE` reads a switch type.
Range: `_SW_TYPE` is applicable to switches and selector switches.
Return-value: For the momentary switch, 0 is returned. For the alternate switch, 1 is returned. For the auto-repeat switch, 2 is returned. For a selector switch, 3 is returned.
29. **_SW_ONCOLOR**
Function: `_SW_ONCOLOR` reads a switch-ON background color.
Range: `_SW_ONCOLOR` is applicable to switches and selector switches.
Return-value: The number (0 to 15) of the read switch-ON background color is returned.
30. **_SW_OFFCOLOR**
Function: `_SW_OFFCOLOR` reads a switch-OFF background color.
Range: `_SW_OFFCOLOR` is applicable to switches and selector switches.
Return-value: The number (1 to 15) of the read switch-OFF background color is returned.
31. **_SW_BMODE**
Function: `_SW_BMODE` reads the switch background color display method.
Range: `_SW_BMODE` is applicable to switches and selector switches.
Return-value: When the switch background color display method is “direct display”, 0 is returned. When the display method is “replacement display”, 1 is returned.
32. **_SW_RACT**
Function: `_SW_RACT` reads whether to perform reverse operation when a switch is ON.
Range: `_SW_RACT` is applicable to switches and selector switches.
Return-value: If reverse operation is performed when a switch is ON, 1 is returned. If reverse operation is not performed, 0 is returned.
33. **_SW_BZER**
Function: `_SW_BZER` reads whether to sound the buzzer when a switch is ON.
Range: `_SW_BZER` is applicable to switches and selector switches.
Return-value: If the buzzer is sounded when a switch is pressed, 1 is returned. If the buzzer is not sounded, 0 is returned.
34. **_SW_STAT**
Function: `_SW_STAT` reads the status (normal operation/ input disable/halftone) of a switch.
Range: `_SW_STAT` is applicable to switches and selector switches.
Return-value: One of the following numeric values indicating the switch status is returned:
0: Normal operation status
1: Input disable status

2: Halftone status

35. `_SW_ONOFF`

Function: `_SW_ONOFF` reads the ON/OFF status of a switch.

Range: `_SW_ONOFF` is applicable to switches and selector switches.

Return-value: When a switch is in the OFF status, 0 is returned. When a switch is in the ON status, 1 is returned. When all the selector switches are in the OFF status, 0 is returned. When one of the selector switches is in the ON status, the corresponding element number is returned.

36. `_SL_SYNC`

Function: `_SL_SYNC` reads the synchronous operation of a switch.

Range: `_SL_SYNC` is applicable to switches and selector switches.

Return-value: When the synchronous operation is not performed, 0 is returned. When the synchronous operation is performed, 1 is returned.

37. `_SL_BORW`

Function: `_SL_BORW` reads the switch device write method.

Range: `_SL_BORW` is applicable to selector switches.

Return-value: When the switch device write method is the bit type write method, 0 is returned. When it is the word type write method, 1 is returned.

- The types and usage of the request codes that can be used by PRMSTAT2 are explained below.

1. `_PD_DCOLOR`

Function: `_PD_DCOLOR` reads the display color of a control.

Range: `_PD_DCOLOR` is applicable to the ON color specification of numeric, character, clock, plot, free graph, meter, and lamp displays.

Type: Specify one of the following:

- 0: Figure read
- 1: Fore color read
- 2: Back color read
- 3: Display color read

Return-value: The number (0 to 15) of the read display color is returned.

2. `_PD_BCOLOR`

Function: `_PD_BCOLOR` reads the background color of a control.

Range: `_PD_BCOLOR` is applicable to numeric, character, clock, plot, bar graph, line chart, and free graph displays.

Type: Specify one of the following:

- 0: Figure read
- 1: Fore color read
- 2: Back color read

Return-value: The number (0 to 15) of the read background color is returned.

3. `_PD_PIPCOLOR`

Function: `_PD_PIPCOLOR` reads the internal color of a pipe or lamp display.
 Range: `_PD_PIPCOLOR` is applicable to pipe and lamp displays.
 Type: Specify one of the following:
 0: Read of OFF display color (valid for pipe and lamp displays)
 1: Read of ON1 display color (valid for pipe and lamp displays)
 2: Read of ON2 display color (valid for pipe displays)
 Return-value: The number (0 to 15) of the read internal color is returned.

4. `_PD_BSLNE`

Function: `_PD_BSLNE` reads the type of a base line or a reference line.
 Range: `_PD_BSLNE` is applicable to bar graphs and line charts.
 Type: Specify one of the following:
 0: Read of base line type
 1: Read of reference line 1 type
 2: Read of reference line 2 type
 Return-value: The number (0 to 3) of the read line type is returned.

5. `_PD_BSCOLOR`

Function: `_PD_BSCOLOR` reads the color of a base line or a reference line.
 Range: `_PD_BSCOLOR` is applicable to bar graphs and line charts.
 Type: Specify one of the following:
 0: Read of base line color
 1: Read of reference line 1 color
 2: Read of reference line 2 color
 Return-value: The number (0 to 15) of the read line color is returned.

6. `_SW_ONFIG`

Function: `_SW_ONFIG` reads the graphic number displayed when a switch is ON.
 Range: `_SW_ONFIG` is applicable to switches and selector switches.
 Type: For a switch, specify 1. For a selector switch, specify the element number of the switch whose ON graphic is to be changed. The element number starts at 1.
 Return-value: The read graphic number is returned.

7. `_SW_OFFFIG`

Function: `_SW_OFFFIG` reads the graphic number displayed when a switch is OFF.
 Range: `_SW_OFFFIG` is applicable to switches and selector switches.
 Type: For a switch, specify 1. For a selector switch, specify the element number of the switch whose OFF graphic is to be changed. The element number starts at 1.
 Return-value: The read graphic number is returned.

8. `_SL_WRITE`

Function: `_SL_WRITE` reads the switch write value.
 Range: `_SL_WRITE` is applicable to switches.
 Type: To read the write value when a switch is ON, specify 1. To read the write value when a switch is OFF, specify 0.
 Return-value: The read write value is returned.

9. `_PD_PLOTRNG`

Function: `PD PLOTRNG` writes the start and end points of displaying a line chart.
 Range: `PD PLOTRNG` is applicable to line charts.
 Type: Specify one of the following:
 0: Indicates reading of the display start point.
 1: Indicates reading of the display end point.

- The types and usage of the request codes that can be used by `PRSTAT3` are explained below.

1. `_PD_RANGE`

Function: `_PD_RANGE` reads the display range of a control.
 Range: `_PD_RANGE` is applicable to bar graph, line chart, free graph, slide, meter, and plot displays.
 Type: When reading Xmin, specify 0. When reading Xmax, specify 1. When reading Ymin, specify 2. When reading Ymax, specify 3.
 Return-value: A value indicating the display range is returned.

2. `_PD_BSVVAL`

Function: `_PD_BSVVAL` reads the setting value of a base or reference line.
 Range: `_PD_BSVVAL` is applicable to bar graph and line chart displays.
 Type: When changing a base line, specify 0. When changing reference line 1, specify 1. When changing reference line 2, specify 2.
 Return-value: A value indicating the display range is returned.

- The types and usage of the request codes that can be used by `PRMSTAT4` are explained below.

1. `_PD_PTRN`

Function: `_PD_PTRN` reads the display color of a control.
 Range: `_PD_PTRN` is applicable to bar graph, 100 percent bar chart, and pie chart displays.
 Type-1: Specify the number of the bar or zone whose display color is to be changed.
 Type-2: Specify one of the following:
 0: Figure read
 1: Fore color read
 2: Back color read
 Return-value: The values indicating the read figure and color number are returned.



2. `_PD_LNE`

- Function: `_PD_LNE` reads the display color of a line chart.
- Range: `_PD_LNE` is applicable to line charts.
- Type-1: Specify the number of the line whose display color is to be changed.
- Type-2: Specify one of the following:
 - 0: Line type read
 - 1: Line color read
- Return-value: The values indicating the read line type and color are returned.

PSTAT

Function

Function	The PSTAT function reads the status of the specified part.
Format	PSTAT (part-name)
Example of Use	MODE = PSTAT (.BUHIN.)
Description	<ul style="list-style-type: none">• The PSTAT function reads the status of the part specified in part-name.• part-name is the name of the part whose status is to be read or the ID-type variable indicating the part.• The value indicating the mode of the part can be obtained by executing this function. The following numeric values indicate modes.<ul style="list-style-type: none">1: Switch input disable status2: Half tone status3: Close status
Related Item	PMODE

Example of Program

```
evnt
  input type% , id@ , data%
  if PSTAT(.BUHIN.) = 0 then
    pmode .BUHIN. , 1
  endif
end evnt
```

RANGE

Statement

Function The RANGE function modifies the area(s) of the control for which the maximum and minimum display data values were specified.

Format RANGE control-name, area-1, area-2, area-3, area-4

Example of Use RANGE ..GRAPH, 0, 0, 100, 100

Description

- control-name is the graph name or the ID-type variable indicating the graph.
- The maximum and minimum area values in the control can be set for each display as follows:

	Area 1	Area 2	Area 3	Area 4	
Plot display		Minimum horizontal value	Maximum horizontal value	Minimum vertical value	Maximum vertical value
Bar graph display		Minimum value	Maximum value	Base value	–
Line chart display		Minimum value	Maximum value	–	–
Free graph display		Minimum value	Maximum value	–	–
Slide display		Minimum value	Maximum value	–	–
Meter display		Minimum value	Maximum value	–	–

“–” is ignored even if it is specified.

Related Item None

Example of Program

```

evnt
  input type% , id@ , min%,max%
  if type% = 3 then
    range ..MTR000 , min% , max% , 0 , 0
  endif
end evnt

```

READTIM

Function

Function	The READTIM function reads the current value of the specified timer.
Format	READTIM (timer-number)
Example of Use	DD = READTIM (TNO@) DD = READTIM (VAR)
Description	<ul style="list-style-type: none"> • The READTIM function reads the current elapse time of the operating timer. This time is read in units of 100 milliseconds. • timer-value is the ID-type variable indicating the number of the timer to be read or an integer-type value from 0 to 15.
Related Item	OPENTIM, STARTTIM, STOPTIM, CLOSETIM, CONTTIM, WRITETIM

Example of Program

```

conf
  static timid@
  timid@ = OPENTIM()
  settim timid@, 20, 0
  starttim timid@
end conf
evnt
  input type% , id@ , data%
  if type% = 3 then
    tim% = READTIM(timid@)
    numdsp ..NUM000,tim%*100
  end if
end evnt

```

RENAME

Statement

Function	The RENAME statement changes a file name or directory name.
Format	RENAME old file name, new file name
Example of Use	RENAME "A:\SUBDIR\FILE1", "FILE2"
Description	<ul style="list-style-type: none"> • A file name can be specified in a full path name including a drive name or in an abbreviated name beginning with a current directory name. Example: A:\SUBDIR\FILE1 FILE1 • A new file name must not contain a path name. • To change a directory name, specify a directory name, instead of a file name.
Related Item	FOPEN,KILL,MKDIR,RMDIR

Example of Program

```

conf
  global dname$(13), pname1$(13), pname2$(13), pname3$(13)
  global dsel%, p1sel%, p2sel%, p3sel%
  strdsp ..str, "rename"
end conf
evnt
  input type%, id@, data%
  if data% = 1 then
    path$ = dname$(dsel%) + pname1$(p1sel%) + pname2$(p2sel%)
    strdsp .dsp.str, path$
    rename path$, pname3$(p3sel%)
  end if
end evnt

```

REOPENCOM

Statement

Function	The REOPENCOM statement reopens the temporarily closed serial line.
Format	REOPENCOM logical-device-name
Example of Use	REOPENCOM HST
Description	<ul style="list-style-type: none">• The REOPENCOM statement permits the program, whose data reception from an external connecting device was temporarily inhibited by the CLOSECOM statement, to receive data again.• logical-device-name specifies any of the following external connecting devices:<ul style="list-style-type: none">HST: Host computerBCR: Bar code readerTKY: Ten-key pad
Related Item	OPENCOM, CLOSECOM

Example of Program

```
conf
  OPENCOM HST
end conf
evnt
  input type% , id@ , data%
  if type% = 3 and data% = 1 then
    CLOSECOM HST
  else if type% = 3 and data% = 0 then
    REOPENCOM HST
  endif
end evnt
```

REOPENPARALLEL

Statement

Function	The REOPENPARALLEL statement permits data re-reception from the temporarily closed parallel port.
Format	REOPENPARALLEL input-bit
Example of Use	REOPENPARALLEL 3
Description	<ul style="list-style-type: none"> • The REOPENPARALLEL statement permits the script, whose data reception from the parallel port was temporarily inhibited by the CLOSEPARALLEL statement, to re-receive data. • input-bit is the bit for restarting data reception. This input bit is the same as the bit specified by the CLOSEPARALLEL statement.
Related Item	OPENPARALLEL, CLOSEPARALLEL

Example of Program

```

conf
    OPENPARALLEL 3
end conf
evnt
    input type% , id@ , data%
    if type% = 3 and data% = 1 then
        CLOSEPARALLEL 3
    else if type% = 3 and data% = 0 then
        REOPENPARALLEL 3
    endif
end evnt

```

RESETALARM

Statement

Function	The RESETALARM statement resets the specified alarm.
Format	RESETALARM alarm-number
Example of Use	RESETALARM (NO@)
Description	<ul style="list-style-type: none">• alarm-number is the number of the alarm set by the SETALARM statement; it must be an ID-type variable.• This statement resets the setting for posting an alarm ON to the program when a specified time is reached.
Related Item	SETALARM

Example of Program

```
conf
  static alid@
  alid@ = setalarm(10,0)
end conf
evnt
  input type% , id@ , data%
  if type% = 3 then
    RESETALARM(alid@)
  end if
end evnt
```

RETURN

Statement

Function	The RETURN statement returns control from the subroutine to the original program.
Format	RETURN
Example of Use	RETURN
Description	<ul style="list-style-type: none">• The RETURN statement returns control to the statement following the statement called by the GOSUB statement.
Related Item	GOSUB

Example of Program

```
evnt
  X = 10
  GOSUB SUB001
  numdsp ..NUM000, X
end evnt
SUB001:
  X = X+3
  RETURN
```

RIGHT\$

Function

Function The RIGHT\$ function returns a character string the specified number of characters, starting from the left of the specified character string.

Format RIGHT\$ (character-string, number-of-characters)
RIGHT\$ (registered-character-string-number, number-of-characters)
RIGHT\$ (registered-character-string-name, number-of-characters)

Example of Use A\$ = RIGHT\$ (MOJI\$, 5)
A\$ = RIGHT\$ (4, 10)
A\$ = RIGHT\$ (TOROKU, 8)

Description

- The RIGHT\$ function returns a character string the specified number of characters (bytes), starting from the right of the specified character-string.
- **number-of-characters** specifies the number of bytes of the character string to be fetched with a numeric value from 0 to 255. When number-of-characters is 0, a null character string is returned.
- **character-string** is a direct character string or a character string variable.
- **registered-character-string-number** is the numerical expression indicating the number registered by Screen Creator.
- **registered-character-string-name** is the name of the character string created by Screen Creator or the ID-type variable indicating the name of the character string.

Related Item MID\$, LEFT\$

Example of Program

```
evnt
  b$ = "12345678"
  a$ = RIGHT$(b$ , 3)
  c$ = RIGHT$ (no , 3)
  c$ = RIGHT$ (id@ , 4)
end evnt
```



RMDIR

Statement

Function	The RMDIR statement deletes a directory.
Format	RMDIR directory-name
Example of Use	RMDIR "TEST"
Description	<ul style="list-style-type: none">• The RMDIR statement is an instruction for deleting a subdirectory.• Specify the directory to be deleted with a character string constant or variable.• The directory to be deleted can be specified in directory-name together with a drive name.
Related Item	MKDIR, CHDIR

Example of Program

```
conf
end conf
evnt
    .....
    RMDIR ``C:TEST``
    .....
end evnt
```

ROTATE

Statement

Function The ROTATE function rotates the figure displayed in the graphic display.

Format ROTATE control-name, angle-of-rotation

Example of Use ROTATE ..FIG000, 2

Description

- **control-name** is the graphic display name or the ID-type variable indicating the graphic display.
- **angle-of-rotation** specifies the angle of rotation with one of the following numeric values:
 - 0: Rotation of 0 degree
 - 1: Rotation of 90 degrees
 - 2: Rotation of 180 degrees
 - 3: Rotation of 270 degrees

Related Item FIGDSP

Example of Program

```
evnt
  input ty , id@, fig%
  ROTATE ..FIG000 , fig%
end evnt
```

RSTAT

Function

Function	The RSTAT function checks the status of registered objects.
Format	RSTAT (registration-name, type, option)
Example of Use	VAR@ = RSTAT (GAMEN1..., 0, 1)
Description	<ul style="list-style-type: none"> • Of registered objects, the RSTAT function obtains the number of the object that is “number specified by option” away from the specified registration name. • A variable or constant representing a screen name, registration character string name, or registration graphic name can be specified in registration-name. • Specify 0 in type. • When option is a positive value, the RSTAT function checks the registered objects in ascending order of their numbers. When option is a negative value, the RSTAT function checks the objects in descending order of their numbers. • If there is no object that is “number specified by option” away from the specified registration name, the RSTAT function returns -1.
Related Item	GETGID, GETGNO

Example of Program

```

conf
end conf
evnt
    id@ = getgid()
    no% = RSTAT ( id@, 0, 1)           ' Checks the next registered screen
    if no% <> -1 then jump no%       ' number.
end evnt

```

RUN

Statement

Function	The RUN statement runs the specified program.
Format	RUN execution-part/screen
Example of Use	RUN .BUHIN.
Description	<ul style="list-style-type: none">• The RUN statement issues a message to the part/screen specified in execution-part/screen and runs the part/screen program. (The message to be issued contains the message type and ID. It, however, does not contain the issued data.)• The program to which a command was issued is not run when the RUN command is issued; it is run when the program that issued the RUN command terminates.• execution-part/screen is a screen name, a part name, or an ID-type variable.
Related Item	INPUT, PRINT, SEND

Example of Program

```
evnt
  input ty , id@, fig%
  if ty = 3 and id@ = ..SWT000 then
    RUN .B000.
  endif
end evnt
```

SELECT CASE ... END SELECT

Statement

Function	The statements satisfying the specified condition are executed.
Format	<pre> SELECT CASE CASE statement-list CASE statement-list CASE ELSE statement-list END SELECT </pre>
Example of Use	See “Example of Program” below.
Description	<ul style="list-style-type: none"> • The SELECT CASE statement executes the CASE statement list satisfying the specified conditional expression. • When CASE, CASE ELSE, and END SELECT appear after the statements satisfying the specified condition have been executed, the SELECT CASE statement executes the statement following END SELECT. • Condition judgment can be performed up to 50 times.
Related Item	IF ... THEN ... ELSE

Example of Program

```

evnt
  input ty , id@, dat%
  select case dat%
    case 1                ' When dat% is 1
      aaa = 1
    case 2,3              ' When dat% is 2 or 3
      aaa = 2
    case 4 to 10          ' When dat% is 4 to 10
      aaa = 3
    case else              ' When dat% is another value
      aaa =4
  end select
end evnt

```

SEND

Statement

Function	The SEND statement sends data to the specified screen, part, or logical connecting device.
Format	SEND send-destination-name
Example of Use	SEND .BUHIN.
Description	<ul style="list-style-type: none">• The SEND statement sends the data written by the PRINT statement to the specified send destination.• send-destination-name is the name of the screen or part to which data is to be sent, the ID-type variable indicating the name, or one of the following logical connecting devices:<ul style="list-style-type: none">HST: Host computerPRN: Printer• The screen or part script that received data is not executed when the SEND command is issued; it is executed when the program that issued the SEND command terminates.
Related Item	RUN, PRINT

Example of Program

```
evnt
  input ty , id@, dat%
  if ty = 3 and id@ = ..SWT000 then
    print "BUHIN1",dat%
    send .B0000.
  endif
end evnt
```

SETALARM

Statement

Function	The SETALARM statement sets an alarm time.
Format	SETALARM (hour, minute)
Example of Use	ID@ = SETALARM (13, 30)
Description	<ul style="list-style-type: none">• The SETALARM statement sets an alarm time in the OIP built-in clock. When the set alarm time is reached, the data indicating this effect is transmitted to the set screen or part program. Up to 16 alarms can be used.• hour specifies the hour(s) to be set with a numeric value from 0 to 23.• minute specifies the minute(s) to be set with a numeric value from 0 to 59.• When the SETALARM function is executed, the alarm number is returned. The alarm number to be returned is an ID-type variable.• This function can be used by the screen or part program being displayed.
Related Item	RESETALARM

Example of Program

```
conf
  static alid@
  alid@ = SETALARM(10,0)
end conf
evnt
  input type% , id@ , data%
  if type% = 3 then
    resetalarm(alid@)
  end if
end evnt
```

SETBEEP

Statement

Function	The SETBEEP statement specifies the tone of a buzzer.
Format	SETBEEP ON-time, OFF-time, sound-count
Example of Use	SETBEEP 10, 5, 3
Description	<ul style="list-style-type: none">• The SETBEEP statement sets the tone color of the buzzer to be sounded by the BEEP command• ON-time specifies the time during which the buzzer continues to sound in units of 100 milliseconds.• OFF-time specifies the time during which the buzzer continues not to sound in units of 100 milliseconds.• sound-count indicates the number of times the buzzer sounds and does not sound. It is impossible to specify 0.• When OFF-time is 0, the buzzer continues to sound.
Related Item	BEEP

Example of Program

```
conf
  SETBEEP 50,20,3
end conf
evnt
  input type%, id@, data%
  if id@ = ..SWT000 then
    BEEP 1
  else
    BEEP 0
  endif
end evnt
```

SETBLIGHT

Statement

Function	The SETBLIGHT statement sets the time that lasts till the back light is turned off.
Format	SETBLIGHT OFF-time
Example of Use	SETBLIGHT 20
Description	<ul style="list-style-type: none">• OFF-time indicates the time that lasts till the back light is turned off; it is an integer-type variable or a numeric value. OFF-time is set in minutes. When OFF-time is 0, the back light is not turned off.
Related Item	GETBLIGHT

Example of Program

```
conf
  getblight var
  var = var*2
  SETBLIGHT var
end conf
```

SETDATE

Statement

Function	The SETDATE statement sets the date of the built-in clock.
Format	SETDATE year, month, day
Example of Use	SETDATE 92, 12, 1
Description	<ul style="list-style-type: none">• year is the low-order two digits of A.D (0 to 99).• month is a numeric value from 1 to 12.• day is a numeric value from 1 to 31.• If an unexisting year, month, or day is specified, an error occurs.• The day of the week is automatically set based on preset year, month and day.• Once date is set using the SETDATE command in a model with a battery backup calendar IC (GC56LC or GC55EM), the date is updated even while the power is off. If a model with no calendar IC (GC53LC or GC53LM) is turned off, the date is initialized to January 1, 1998 (Thursday) and the time to 00:00:00 when it is turned on again. The date and time are updated while the power is on.
Related Item	DATE\$, GETDATE, GETDATE, SETTIME, TIME\$

Example of Program

```
evnt
  input type,id@,dat
  if type = 3 then
    y = 94
    m = 12
    d = 1
    setdate y, m, d
  endif
end evnt
```

SETLNEPLOT

Statement

Function	The SETLNEPLOT statement sets the display range of a line chart.
Format	SETLNEPLOT display-start-point, display-end-point
Example of Use	SETLNEPLOT 10, 50
Description	<ul style="list-style-type: none">• The SETLNEPLOT statement sets the display range of a line chart. Executing LINEDSP, LNEShift, or PRDSP after this display range has been set displays the line chart within the set range.• After LINEDSP, LNEShift, or PRDSP has been executed, the set display range is released and the entire range display status is set.• Line charts for which “Blink” or “On-and-Off” is specified are displayed within the entire range.• When different ranges are set for two or more line charts within 100 milliseconds, the last set range corresponds to the first line chart to be displayed. All other line charts are displayed.
Related Item	LINEDSP, LNEShift, PRDSP

Example of Program

```
evnt
  input type,id@,data
  SETLNEPLOT 20, 30
  lneshift (..lnegraph , 1,1, 40)
end evnt
```

SETSIO

Statement

Function	The SETSIO statement sets a non-protocol communication reception method.
Format	SETSIO port-number, value
Example of Use	SETSIO 2 , &HD
Description	<ul style="list-style-type: none"> • The SETSIO statement sets the condition for issuing messages to BASIC of the part/screen when data is received in the non-procedural communication mode. • port-number specifies the port for which the non-procedural communication mode is to be set. • When the port specified in port-number is in the binary mode, value specifies the number of data to be received (in bytes). (0 cannot be specified.) When the port is in the text mode, value specifies a terminator code (1 to 0FFh) of the received data. • For the binary mode, specify the number of bytes to be received from the connecting device. When the specified number of bytes are received, a message is transmitted to the part/screen. • For the text mode, when a terminator code is received, a message is transmitted to the part/screen. A terminator code can be specified only by one byte. • The port to be set must be opened by the OPENSIO statement in advance.
Related Item	OPENSIO, CLOSESIO, WRITESIO, WRITWSIOB, FLUSH, IOCTL

Example of Program

```

conf
  global buf$ * 200
  opensio 2 , 1 , buf$
  SETSIO 2 , &HD
end conf
evnt
  strdsp ..STR000 , buf$
  closesio 2
end evnt

```

SETTIM

Statement

Function	The SETTIM statement sets the limit time of the specified timer.
Format	SETTIM timer-number, time-limit, timer-type
Example of Use	SETTIM ID@, 100, 0 SETTIM VAR, 200, 1
Description	<ul style="list-style-type: none"> • The SETTIM statement determines the operation of the specified timer. The timer must be stopped when it is set. • timer-number is the ID-type variable indicating the number of the timer whose operation is to be set or an integer-type value from 0 to 15. • The time specified in time-limit starts to be counted when operation of the specified timer is started. It is specified in units of 100 milliseconds. • timer-type specifies the type of timer to be set. Timers are classified into two types: normal and interval. The normal timer stops when the specified time limit is reached once. The interval timer restarts counting from 0 when the specified time limit is reached once. <ul style="list-style-type: none"> 0: Normal timer 1: Interval timer • If one second or lower is set as the time limit in the interval timer, messages may be accumulated to cause an error.
Related Item	OPENTIM, STARTTIM, STOPTIM, CLOSETIM, CONTTIM, READTIM

Example of Program

```

conf
  static timid@
  timid@ = opentim()
  SETTIM timid@, 20, 0
  starttim timid@
end conf
evnt
  input type% , id@ , data%
  if type% = 3 then
    tim% = readtim(timid@)
    numdsp ..NUM000,tim%*100
  end if
end evnt

```

SETTIME

Statement

Function	The SETTIME statement sets the time of the built-in clock.
Format	SETTIME hour, minute, second
Example of Use	SETTIME 12, 0, 0
Description	<ul style="list-style-type: none">• hour is a numeric value from 0 to 23.• minute is a numeric value from 0 to 59.• second is a numeric value from 0 to 59.• If an unexisting hour, minute, or second is specified, an error occurs.• Once time is set using the SETTIME command in a model with a battery backup calendar IC (GC56LC or GC55EM), time is updated even while the power is off. If a model with no calendar IC (GC53LC or GC53LM) is turned off, the date is initialized to January 1, 1998 (Thursday) and the time to 00:00:00 when it is turned on again. The date and time are updated while the power is on.
Related Item	DATE\$, GETDATE, GETDATE, SETDATE, TIME\\$_

Example of Program

```
evnt
  input type% , id@ , h% , m% , s%
  settime h% , m% , s%
end evnt
```

SHIFT

Statement

Function	The SHIFT statement shifts the contents of the specified variable left or right.
Format	SHIFT variable-name, shift-amount
Example of Use	SHIFT VARIABLE% , 1
Description	<ul style="list-style-type: none">• The SHIFT statement shifts the contents (bit string) of the specified variable by the specified amount left or right.• 0 is set in the positions of the bits vacated as a result of the shifting.• variable-name specifies the variable name used to shift the bit string; it must be an integer-type variable.• shift-amount specifies how much the bit string in the variable is to be shifted. A numeric value from 31 to -31 can be specified in shift-amount. When the specified shift amount is positive, the SHIFT statement shifts the bit string left. When it is negative, the SHIFT statement shifts the bit string right.
Related Item	None

Example of Program

```
conf
end conf
evnt
    input type% , id@ , data%
    numdsp ..NUM000 , data%
    shift data% , 1
    numdsp ..NUM000 , data%
end evnt
```

SIN

Function

Function	The SIN function calculates a sine for the specified numerical expression.
Format	SIN (numerical-expression)
Example of Use	X = SIN (ANGLE)
Description	<ul style="list-style-type: none">• The SIN function calculates a sine value for the specified numerical expression. The unit for the numeric expression is radian.
Related Item	ATN, COS, TAN

Example of Program

```
evnt
  angle = 3.141592/3
  x = SIN ( angle )
  numdsp ..num000,x
end evnt
```

SLDDSP

Statement

Function	The SLDDSP statement displays data in the slide display.
Format	SLDDSP control-name, display-data
Example of Use	SLDDSP .BUHIN.GRAPH, 30.0
Description	<ul style="list-style-type: none">• control-name is the slide display name or the ID-type variable indicating the slide display.• display-data is numeric data indicating the display position of the point graphic to be displayed in the slide display.• display-value cannot be changed even if this statement is issued to the display for which operation parameters are set to “effective” in the control.
Related Item	None

Example of Program

```
evnt
  input type,id@,data
  SLDDSP ..SLD000, data
end evnt
```

SOF

Function

Function	The SOF function calculates the size of a field.
Format	SOF (file-number)
Example of Use	AAA = SOF (file-number)
Description	<ul style="list-style-type: none"> file-number is the file number defined in the FIELD declaration. This size becomes the size of the file to be actually read or written. The size is calculated in bytes.
Related Item	FOPEN, FIELD, FCLOSE, FPUT, FGET, EOF

Example of Program

```

conf
  field 5
    global no%
    global moji1$ , moji2$
  end field
  global buff$ * 50
  opensio 1 , 0 , buff$
  fopen ``C:TEST', 2 , 5
end conf
evnt
  no% = 1
  moji1$ = ``product-name''
  moji2$ = ``product-number''
  size% = SOF(5)
  mcpy 5 , buff$
  writesiob 1 , size% , buff$
end evnt

```

SQR

Function

Function	The SQR function calculates a square.
Format	SQR (numerical-expression)
Example of Use	X = SQR (Y)
Description	<ul style="list-style-type: none">• The SQR function calculates a square for the specified numerical expression. numerical-expression must be a numeric value greater than or equal to 0.
Related Item	None

Example of Program

```
evnt
  x = SQR ( a^2 + b^2 )
  numdsp ..NUM000, X
end evnt
```

STARTTIM

Statement

Function	The STARTTIM statement starts the operation of the specified timer.
Format	STARTTIM timer-number
Example of Use	STARTTIM ID@ STARTTIM VAR
Description	<ul style="list-style-type: none"> • The STARTTIM statement starts the operation of the specified timer. (The timer starts increment from 0.) • timer-number is the ID-type variable indicating the number of the timer that starts increment or an integer-type variable from 0 to 15.
Related Item	OPENTIM, STOPTIM, CONTTIM, CLOSETIM, SETTIM, READTIM

Example of Program

```

conf
  static timid@
  timid@ = opentim()
  settim timid@, 20, 0
  STARTTIM timid@
end conf
evnt
  input type% , id@ , data%
  if type% = 3 then
    tim% = readtim(timid@)
    numdsp ..NUM000,tim%*100
  end if
end evnt

```

STATIC

Statement

Function	The <code>STATIC</code> statement declares that static variables are to be used.
Format	<code>STATIC variable-name [, variable-name ...]</code>
Example of Use	<code>STATIC VAR, XYZ(2,3), MOJI\$ * 20</code>
Description	<ul style="list-style-type: none">• The <code>STATIC</code> statement declares that static variables are to be used. Static variables can be used only the declared program. These variables are initialized once when the power supply is turned on. The values of static variables used after the power supply has been turned on are retained.• A normal variable, an array variable, or a character string variable can be written in variable-name.• When an array or character variable is declared, the <code>DIM</code> and <code>STRING</code> statements need not be declared.

Related Item `AUTO, BACKUP, DIM, GLOBAL, LOCAL, STRING`

Example of Program

```
conf
  STATIC var%, float
  STATIC moji$ * 50, moji2(10) * 3
  STATIC xyz@(10,10)
end conf
```

STOP

Statement

Function	The STOP statement stops the execution of the program.
Format	STOP
Example of Use	STOP
Description	<ul style="list-style-type: none">• The STOP statement stops the execution of the program following this statement.
Related Item	RUN

Example of Program

```
evnt
  input type , id@, data
  if type = 3 and data = 0 then STOP
  numdsp ..NUM000, data
end evnt
```

STOPTIM

Statement

Function	The STOPTIM statement stops the increment operation of the specified timer.
Format	STOPTIM timer-number
Example of Use	STOPTIM ID@ STOPTIM VAR
Description	<ul style="list-style-type: none"> • The STOPTIM statement stops the increment operation of the specified timer. • timer-number is the ID-type variable indicating the number of the timer that stops increment or an integer-type variable from 0 to 15.
Related Item	OPENTIM, STARTTIM, CONTTIM, CLOSETIM, SETTIM, READTIM

Example of Program

```

conf
    static timid@
    timid@ = opentim()
    settim timid@, 20, 0
    starttim timid@
end conf
evnt
    input type% , id@ , data%
    if type% = 3 and data% = 1 then
        tim% = readtim(timid@)
        numdsp ..NUM000,tim%*100
    else
        STOPTIM timid@
    end if
end evnt

```

STR\$

Function

Function	The STR\$ function converts the specified numeric value to a character string.
Format	STR\$ (numerical-expression)
Example of Use	A\$ = STR\$(123)
Description	<ul style="list-style-type: none">• An integer- or floating point-type numerical expression can be specified in numerical-expression.• When the numeric value specified in numerical-expression is negative, “-“ is added to the beginning of the character string.
Related Item	VAL

Example of Program

```
evnt
  input type, id@,data
  a$ = STR$ ( data )
  strdsp ..hyojiki , a$
end evnt
```

STRCOLOR

Statement

Function	The STRCOLOR statement changes the colors and background figure of the character display.
Format	STRCOLOR control-name, character-display-color, tile, display-color, background-color
Example of Use	STRCOLOR ..GRAPH, 1, 2, 5, 2
Description	<ul style="list-style-type: none"> • The STRCOLOR statement changes the background tile and colors of the character display. -1 indicates that the color and tile for which -1 was specified remain unchanged. • control-name is the character display name or the ID-type variable indicating the character display. • character-display-color indicates the color in which characters are displayed. Specify this character display color with a numeric value from 0 to 15. • tile indicates the background tiling figure of the character display. Specify this tiling figure with a numeric value from 0 to 15. • display-color is the numeric value indicating the color number of the tile display section. Specify this color number with a numeric value from 0 to 15. • background-color is the numeric value indicating the color number of the tile background section. Specify this color number with a numeric value from 0 to 15.
Related Item	STRDSP, STRFORM

Example of Program

```

conf
  static name@
  name@ = ..STR000
end conf
evnt
  input type%, id@, data%
  if type% = 3 then
    STRCOLOR name@, 2, -1,-1,-1
  endif
end evnt

```

STRDSP

Statement

Function	The STRDSP statement displays data in the character display.
Format	STRDSP control-name, display-data
Example of Use	STRDSP .BUHIN.GRAPH, "ABCDEF"
Description	<ul style="list-style-type: none">• The STRDSP statement displays data in the character display.• control-name is the character display name or the ID-type variable indicating the character display.• display-data is character data to be displayed in the character display.• display-value cannot be changed even if this statement is issued to the display for which operation parameters are set to "effective" in the control.
Related Item	STRCOLOR, STRFORM

Example of Program

```
conf
  static name@
  name@ = ..STR000
end conf
evnt
  input type%, id@, data$
  STRDSP name@, data$
end evnt
```

STRFORM

Statement

Function	The STRFORM statement changes the display method of the character display.
Format	STRFORM control-name, display-method
Example of Use	STRFORM ..HYOJIKI, 0
Description	<ul style="list-style-type: none">• The STRFORM statement changes the display method of the character display.• control-name is the character display name or the ID-type variable indicating the character display.• display-method is the numeric value indicating any of the following three display methods:<ul style="list-style-type: none">0: Left-justification method1: Centering method2: Right-justification method
Related Item	STRCOLOR, STRDSP

Example of Program

```
evnt
  input type , id@,data
  var@ = .buhin.moji
  STRFORM var@ , data
  strdsp var@ , "ABCDEFGG"
end evnt
```

STRING

Statement

Function The STRING statement specifies the size of the character string variable to be used.

Format STRING variable-name * size [variable-name * size]

Example of Use STRING MOJI\$ * 50

Description

- The STRING statement is used to specify a size of a local character string variable.
- The STRING statement is adopted to maintain the compatibility with GCSGP3. Use LOCAL, instead of STRING, in Screen Creator 5.
- The default size of the character string variable is 20 bytes. Use the STRING statement to use a variable whose size is greater than 20 bytes. The character string variable must be declared before it is used.
- variable-name must end with \$.
- Specify size with an integer value.
- Two or more character string variable can be specified in one line, delimited by a comma (,).

Related Item GLOBAL, STATIC, BACKUP, LOCAL

Example of Program

```
conf
  string xxx$ * 40
  string moji$ * 50
end conf
```

SWFIG

Statement

Function	The SWFIG statement sets the graphic to be displayed when the status of the specified switch changes.
Format	SWFIG switch-name, display-graphic, status, sub-ID
Example of Use	SWFIG ..SW1, FIG3, 0, 0
Description	<ul style="list-style-type: none"> • The SWFIG statement specifies the graphic to be displayed in the specified switch when the switch changes from the ON status to the OFF status. Both the unit switch and selector switch can be used. When the selector switch is used, its sub-ID must be specified. • switch-name is the name assigned to the switch or the ID-type variable indicating the name. • display-graphic is the graphic name or the ID-type variable indicating the name. • status is the integer value indicating whether the graphic is displayed when the switch status is ON or OFF. <ul style="list-style-type: none"> 0: The graphic is displayed when the switch status is OFF. 1: The graphic is displayed when the switch status is ON. • sub-ID is required when the selector switch is used. Specify the sub-switch number of the selector switch in sub-ID. The sub-switch number in the upper left end is assigned 1. The sub-switch numbers increase in the right direction. They decrease in the downward direction. (Specify 0 in sub-ID when the selector switch is not used.)
Related Item	None

Example of Program

```

conf
    static figid@,subid,onoff
    figid@ = FIG03
    subid = 3
    onoff = 1
end conf
evnt
    input type,id@,data
    if type = 3 and id@ = ..SWT000 then
        SWFIG id@ , figid@ , onoff , subid
    endif
end evnt

```

SWMODE

Statement

Function	The SWMODE statement modifies the status of the specified switch.
Format	SWMODE switch-name, mode
Example of Use	SWMODE ..SW1, 2
Description	<ul style="list-style-type: none">• switch-name is the name of the switch whose status is to be modified or the ID-type variable indicating the switch.• mode indicates the status to be modified.<ul style="list-style-type: none">0: Normal status1: Input disable status2: Half tone status
Related Item	None

Example of Program

```
evnt
  input type,id@,data
  if type = 3 then
    SWMODE ..sw2 , 1
    SWMODE var@ ,2
  end if
end evnt
```

SWREAD

Function

Function	The SWREAD function reads the status of the specified switch.
Format	SWREAD (switch-name)
Example of Use	STATE = SWREAD (..SW1)
Description	<ul style="list-style-type: none"> • The SWREAD function reads the status (ON or OFF) of the specified switch. • switch-name is the name assigned to the switch or the ID-type variable indicating the name. • The CONF and part CONF block of the global screen cannot be used in the switch primitive where operation parameters are valid. • The SWREAD statement cannot read the synchronous switch status of an undisplayed screen. • As a result of executing this function, the status of normal switches is indicated by the following numeric values: <ul style="list-style-type: none"> 0: OFF status 1: ON status • As a result of executing this function, the status of selector switches is indicated by the following numeric values: <ul style="list-style-type: none"> 0: All selector switches are OFF. Other values: Numbers of the sub-switches that are ON. (The sub-switch number in the upper left end is 1. The sub-switch numbers increase in the right direction. They decrease in the downward direction.)
Related Item	SWWRITE

Example of Program

```

evnt
  input type,id@,data
  id@ = ..SW2
  state = SWREAD (ID@)
  if state = 0 then
    swwrite id@,1
  endif
end evnt

```

SWREV

Statement

Function	The SWREV statement sets whether to reverse the display of the specified switch when the switch status changes.
Format	SWREV switch-name, operation
Example of Use	SWREV ..SW2, 0
Description	<ul style="list-style-type: none"> • The SWREV statement sets whether to reverse the display of the specified switch when the switch on the touch panel is pressed or the status is changed. • switch-name is the name assigned to the switch or the ID-type variable indicating the name. • The CONF and part CONF block of the global screen cannot be used in the switch primitive where operation parameters are valid. • operation indicates whether to reverse the display of the switch with the following numeric values: <ul style="list-style-type: none"> 0: The display of the switch is not reversed. 1: The display of the switch is reversed.
Related Item	None

Example of Program

```

evnt
  input type,id@,data
  if type = 3 and id@ = ..SWT000 then
    id@ = ..SW2
    SWREV id@,1
  endif
end evnt

```



SWWRITE

Statement

Function	The SWWRITE statement changes the status of the specified switch.
Format	SWWRITE switch-name, status
Example of Use	SWWRITE ..SW1, 1
Description	<ul style="list-style-type: none"> • The SWWRITE statement changes the status (ON or OFF) of the specified switch even if the switch on the touch panel is not pressed. When the status is changed, the data indicating the status is transmitted to the part program on which the switch is placed. • switch-name is the name assigned to the switch or the ID-type variable indicating the name. For multi-switches, it is necessary to set switch numbers in the offset and to get switch IDs using the GETID command. • status indicates that the normal switches are in any of the following statuses: <ul style="list-style-type: none"> 0: OFF status 1: ON status • status indicates that the selector switches are in any of the following statuses: <ul style="list-style-type: none"> 0: All selector switches are OFF. Other values: Numbers of the sub-switches that are ON. (The sub-switch number in the upper left end is 1. The sub-switch numbers increase in the right direction. They decrease in the downward direction.) • The numbers of multi-switches and selector switches are counted as 1, 2, 3 and so forth from the upper left switch. When all switches are counted in the X direction, the switches on the lower Y line are counted in the same way. They are integers. • When this statement is executed, a message is issued as a switch is pressed. • Executing the SWWRITE statement for the switch where synchronous operation is valid causes an error. • The SWWRITE statement is invalid for the switch of the momentary type.
Related Item	GETID,SWREAD

Example of Program

```
evnt
  input type,id@,data
  id@ = ..SW2
  state = swread (ID@)
  if state = 0 then
    SWWRITE id@,1
  endif
end evnt
```

TAN

Function

Function	The TAN function calculates a tangent for the specified numerical expression.
Format	TAN (numerical-expression)
Example of Use	X = TAN (ANGLE)
Description	<ul style="list-style-type: none">• The TAN function calculates a tangent value for the specified numerical expression. The unit for the numeric expression is radian.
Related Item	ATN, SIN, COS

Example of Program

```
evnt
  angle = 3.141592/3
  x = TAN ( angle )
  numdsp ..num000,x
end evnt
```

TIME\\$

Statement

Function	The TIME\$ statement reads the current time.
Format	TIME\$
Example of Use	A\$ = TIME\$
Description	<ul style="list-style-type: none">• The TIME\$ statement reads the current time with a character string of H:M:S format.• This statement cannot be used to set the current time.• Once time is set using the SETTIME command in a model with a battery backup calendar IC (GC56LC or GC55EM), time is updated even while the power is off. If a model with no calendar IC (GC53LC or GC53LM) is turned off, the date is initialized to 98-01-01 and the time to 00:00:00 when it is turned on again. The date and time are updated while the power is on.
Related Item	DATE\$, GETDATE, GETTIME, SETDATE, SETTIME

Example of Program

```
conf
  moji$ = TIME$
  strdsp ..STR000 , moji$
end conf
```

TIMID

Function

Function	The TIMID function changes an integer-type timer number to an ID-type timer number.
Format	TIMID (number)
Example of Use	AA@ = TIMID (VAR)
Description	<ul style="list-style-type: none">• number is the timer number (integer value) to be changed to an ID-type timer number.
Related Item	TIMINT, OPENTIM2

Example of Program

```
conf
  opentim2(2)
  settim 2 , 20, 0
  starttim 2
end conf
evnt
  input type,id@
  if id@ = timid(2) then
    .....
  end if
end evnt
```

TIMINT

Function

Function The TIMINT function changes an ID-type timer number to an an integer-type timer number.

Format TIMINT (ID-number)

Example of Use VAR = TIMINT (ID@)

Description • ID-number is the ID-type timer number to be changed to to an integer-type timer number.

Related Item TIMID, OPENTIM

Example of Program

```
evnt
.....
id@=opentim()
no = TIMINT (id@)
chktim ( no )
....
end evnt
```

VAL/VAL2

Function

Function The VAL/VAL2 function converts the number specified in character-string to a numeric value.

Format VAL (character-string)
VAL2 (character-string)

Example of Use A = VAL ("123")
A = VAL2 ("123.45")

Description

- When the specified character string begins with a character other than +, -, 0 to 9, E and ., the VAL/VAL2 function returns 0.
- If the specified character string contains an unconvertible character, the VAL/VAL2 function converts the characters before it.
- When the VAL function is used to convert the number specified in character-string to a numeric value, the result becomes real type.
- When the VAL2 function is used to convert the number specified in character-string to a numeric value, the result becomes integer type.

Related Item STR\$

Example of Program

```
conf
  var = VAL ( "234" )
  numdsp ..NUM000 , var
end conf
```

WHILE ... WEND

Statement

Function The instructions between the WHILE and WEND statements are executed while the specified conditional expression is true (satisfactory).

Format WHILE conditional-expression
.....
WEND

Example of Use WHILE X > 0
....
WEND

Description

- When the specified conditional expression is true, the instructions between the WHILE and WEND statements are executed. When it becomes false, the instructions following the WEND statement are executed.

Related Item IF ... THEN ... ELSE

Example of Program

```
conf
  static var(10)
  WHILE i% < 10
    var(i%) = i% * 5
  WEND
end conf
```

WRITESIO/WRITESIOB

Statement

Function	The WRITESIO and WRITESIOB statements write transmission data to a non-procedural communication transmission buffer.
Format	WRITESIO port-number, variable-name WRITESIOB port-number, number-of bytes, variable-name
Example of Use	WRITESIO 2 , moji\$ WRITESIOB 2 , 20 , moji\$
Description	<ul style="list-style-type: none"> • The WRITESIO statement writes transmission data to a non-procedural communication transmission buffer (serial port) in the text mode. The WRITESIOB statement writes transmission data to the same buffer (serial port) in the binary mode. • port-number specifies the channel (CH1 to CH3) to which transmission data is to be written with a numeric value from 1 to 3. • Of the transmission data written to the variable specified by variable-name, number-of-bytes specifies the number of bytes to be transmitted (valid when the binary mode is used). • variable-name specifies the name of the variable to which transmission data is written. • In the text mode, the written data is transmitted till the code (0h) indicating the end of the character string is detected. (That is, data from 1 to 0FFh can be transmitted. No terminator code is automatically inserted into the end of data.) • In the binary mode, all data (0 to 0FFh) can be transmitted. • The port to which transmission data is to be written must be opened by the OPENSIO statement in advance.
Related Item	OPENSIO, CLOSESIO, WRITESIO, WRITWSIOB, SETSIO

Example of Program

```

conf
  global buf$ * 200
  opensio 2 , 1 , buf$
  setsio 2 , &HD
end conf
evnt
  sendbuf$ = ``ABCDEFGF``
  WRITESIO 2 , sendbuf$
  closesio 2
end evnt

```

--

CHAPTER 4

INSTRUCTION REFERENCE

4-1 Instruction Reference

ABS	4-10	CVW	4-59
ADDCYC	4-11	CYCLIC	4-60
ADDCYC2	4-12	CYCLIC2	4-62
ADDCYCID	4-13		
ASC	4-14	DATE\$	4-63
ATN	4-15	DECLARE	4-64
AUTO	4-16	DEVRD	4-65
		DEVWR	4-66
BACKUP	4-17	DIM	4-67
BARCOLOR	4-18	DIR	4-69
BARDSP	4-20	DINV	4-71
BARSET	4-21	DOT	4-72
BARSHIFT	4-22	DSPMODE	4-73
BCD2BIN	4-23		
BEEP	4-24	EOF	4-74
BIN2BCD	4-25	ERRCTL	4-75
BITSET	4-26	ERRSTAT	4-76
BITTEST	4-27	EVENTWR	4-77
BLCTL	4-28	EVNT ... END EVNT	4-78
BLSTAT	4-29	EXECPRCODE	4-79
BLTCOLOR	4-30	EXIT FUNCTION	4-80
BLTDSP	4-31	EXP	4-81
BLTSET	4-32		
BREAD	4-33	FCLOSE	4-82
BWRITE	4-34	FGET	4-83
		FIELD ... END FIELD	4-84
CHDIR	4-35	FIGCOLOR	4-86
CHKTIM	4-36	FIGDSP	4-87
CHR\$	4-37	FIGFORM	4-88
CINT	4-38	FINPUT	4-89
CIRCOLOR	4-39	FLUSH	4-90
CIRDSP	4-40	FOPEN	4-91
CIRSET	4-41	FOR ... TO ... NEXT	4-92
CLEAR	4-42	FORMAT	4-93
CLOSE	4-43	FPRINT	4-94
CLOSECOM	4-44	FPUT	4-95
CLOSEPARALLEL	4-45	FRECOLOR	4-96
CLOSESIO	4-46	FREDSP	4-98
CLOSETIM	4-47	FSEEK	4-99
COLOR	4-48	FSUM	4-100
CONF ... END CONF	4-49	FUNCTION ... END FUNCTION	4-101
CONST	4-50	FWRITE	4-103
CONTTIM	4-51		
COPY	4-52	GETBLIGHT	4-104
COS	4-53	GETDATE	4-105
CURDIR	4-54	GETGID	4-106
CVB	4-55	GETGNO	4-107
CVF	4-56	GETID	4-108
CVI	4-57	GETOFFSET	4-109
CVID	4-58	GETTIME	4-110

GLOBAL.....	4-111		
GOSUB	4-112	NUMCOLOR	4-161
GOTO.....	4-113	NUMDSP.....	4-162
		NUMFORM.....	4-163
HEX\$.....	4-114		
		OCT\$	4-164
IF ... THEN ... ELSE	4-115	ONFERR.....	4-165
INIT ... END INIT.....	4-116	OPEN.....	4-166
INP	4-117	OPENCOM.....	4-167
INPBIT	4-118	OPENPARALLEL.....	4-168
INPUT	4-119	OPENSIO	4-169
INSTR	4-121	OPENTIM.....	4-170
INT	4-122	OPENTIM2.....	4-171
INTERLOCK	4-123	OPENTIM3.....	4-172
IOCTL	4-124	OUT	4-173
IOCTL2	4-126	OUTBIT.....	4-174
IOSTAT.....	4-127	OUTBITSTAT.....	4-175
		OUTSTAT	4-176
JUMP.....	4-128		
		PIPCOLOR.....	4-177
KILL.....	4-129	PIPDSP	4-178
		PLTCOLOR.....	4-179
LAMPCOLOR	4-130	PLTDSP.....	4-180
LAMPDSP	4-131	PMODE	4-181
LEFT\$	4-132	PRDSP	4-182
LEN	4-133	PREVJUMP	4-183
LINE.....	4-134	PRINT	4-184
LINPUT.....	4-135	PRMCTL	4-185
LNECOLOR.....	4-136	PRMSTAT	4-192
LNEDSP.....	4-137	PSTAT	4-202
LNESET	4-138		
LNESHIFT	4-139	RANGE.....	4-203
LNESHIFT2	4-140	READTIM	4-204
LOCAL.....	4-141	RENAME	4-205
LOCALCHECK	4-142	REOPENCOM.....	4-206
LOF	4-144	REOPENPARALLEL	4-207
LOG.....	4-145	RESETALARM.....	4-208
		RETURN	4-209
MCPY.....	4-146	RIGHT\$	4-210
MEDIACHK	4-147	RMDIR	4-211
MEDIASIZE	4-148	ROTATE.....	4-212
MID\$	4-149	RSTAT.....	4-213
MID\$	4-149	RUN.....	4-214
MKB.....	4-151		
MKDIR.....	4-152	SELECT CASE ... END SELECT.....	4-215
MKF	4-153	SEND.....	4-216
MKI	4-154	SETALARM.....	4-217
MKID	4-155	SETBEEP	4-218
MKS	4-156	SETBLIGHT.....	4-219
MKW.....	4-157	SETDATE.....	4-220
MOVE	4-158	SETLNEPLOT	4-221
MTRCOLOR.....	4-159	SETSIO.....	4-222
MTRDSP	4-160	SETTIM.....	4-223

SETTIME	4-224
SHIFT	4-225
SIN.....	4-226
SLDDSP	4-227
SOF.....	4-228
SQR	4-229
STARTTIM.....	4-230
STATIC	4-231
STOP	4-232
STOPTIM.....	4-233
STR\$.....	4-234
STRCOLOR	4-235
STRDSP	4-236
STRFORM	4-237
STRING.....	4-238
SWFIG.....	4-239
SWMODE	4-240
SWREAD	4-241
SWREV	4-242
SWWRITE	4-243
TAN.....	4-245
TIMES\$	4-246
TIMID	4-247
TIMINT	4-248
VAL/VAL2.....	4-249
WHILE ... WEND	4-250
WRITESIO/WRITESIOB	4-251

--

Type conversion

BCD2BIN.....	4-23
BIN2BCD.....	4-25
GETGID.....	4-106
GETGNO.....	4-107
GETID.....	4-108
GETOFFSET.....	4-109
TIMID.....	4-247
TIMINT.....	4-248

Screen/part control

CLOSE.....	4-43
JUMP.....	4-128
MOVE.....	4-158
OPEN.....	4-166
PMODE.....	4-181
PREVJUMP.....	4-183
PSTAT.....	4-202
RSTAT.....	4-213

Switch control

SWFIG.....	4-239
SWMODE.....	4-240
SWREAD.....	4-241
SWREV.....	4-242
SWWRITE.....	4-243

Numeric displays

NUMCOLOR.....	4-161
NUMDSP.....	4-162
NUMFORM.....	4-163

Character string displays

STRCOLOR.....	4-235
STRDSP.....	4-236
STRFORM.....	4-237

Graphic displays

FIGCOLOR.....	4-86
FIGDSP.....	4-87
FIGFORM.....	4-88
ROTATE.....	4-212

Plot displays

PLTCOLOR.....	4-179
PLTDSP.....	4-180

Bar graph displays

BARCOLOR.....	4-18
BARDSP.....	4-20
BARSET.....	4-21
BARSHIFT.....	4-22

Line chart displays

LNECOLOR.....	4-136
LNEDSP.....	4-137
LNESSET.....	4-138
LNESHIFT.....	4-139
LNESHIFT2.....	4-140
SETLNEPLOT.....	4-221

100 percent bar chart displays

BLTCOLOR.....	4-30
BLTDSP.....	4-31
BLTSET.....	4-32

Pie chart displays

CIRCOLOR.....	4-39
CIRDSP.....	4-40
CIRSET.....	4-41

Free graph displays

FRECOLOR.....	4-96
FREDSP.....	4-98

Slide displays

SLDDSP.....	4-227
-------------	-------

Meter displays

MTRCOLOR.....	4-159
MTRDSP.....	4-160

Lamp displays

LAMPCOLOR.....	4-130
LAMPDSP.....	4-131

Pipe displays

PIPCOLOR.....	4-177
PIPDSP.....	4-178

Control control

CLEAR.....	4-42
DSPMODE.....	4-73
EXECPCODE.....	4-79
PRDSP.....	4-182
PRMCTL.....	4-185
PRMSTAT.....	4-192
RANGE.....	4-203

Serial control

CLOSECOM.....	4-44
CLOSESIO.....	4-46
FLUSH.....	4-90
OPENCOM.....	4-167
OPENSIO.....	4-169
REOPENCOM.....	4-206
SETSIO.....	4-222
WRITESIO.....	4-251

Parallel control

CLOSEPARALLEL.....	4-45
INP.....	4-117
INPBIT.....	4-118
OPENPARALLEL.....	4-168
OUT.....	4-173
OUTBIT.....	4-174
OUTBITSTAT.....	4-175
OUTSTAT.....	4-176
REOPENPARALLEL.....	4-207

Timers/alarms

CHKTIM.....	4-36
CLOSETIM.....	4-47
CONTTIM.....	4-51
OPENTIM.....	4-170
OPENTIM2.....	4-171
OPENTIM3.....	4-172
READTIM.....	4-204
RESETALARM.....	4-208
SETALARM.....	4-217
SETTIM.....	4-223
STARTTIM.....	4-230
STOPTIM.....	4-233

--

PLC/memory link communication

ADDCYC	4-11
ADDCYC2	4-12
ADDCYCID	4-13
BREAD	4-33
BWRITE	4-34
CYCLIC	4-60
CYCLIC2	4-62
DEV RD	4-65
DEV WR	4-66
EVENTWR	4-77

Hardcopy

COPY	4-52
------------	------

Drawing

COLOR	4-48
DINV	4-71
DOT	4-72
LINE	4-134

Back light control

BLCTL	4-28
BLSTAT	4-29
GETBLIGHT	4-104
SETBLIGHT	4-219

Buzzer control

BEEP	4-24
SETBEEP	4-218

Time/date

DATE\$	4-63
GETDATE	4-105
GETTIME	4-110
SETDATE	4-220
SETTIME	4-224
TIME\$	4-246

File control

CURDIR	4-54
DIR	4-69
EOF	4-74
FCLOSE	4-82
FGET	4-83
FIELD	4-84
FINPUT	4-89
FOPEN	4-91
FORMAT	4-93
FPRINT	4-94
FPUT	4-95
FSEEK	4-99
FWRITE	4-103
KILL	4-129
LINPUT	4-135
LOF	4-144
MEDIACHK	4-147
MEDIASIZE	4-148
MKDIR	4-152
ONFERR	4-165
RENAME	4-205
RMDIR	4-211
SOF	4-228
SUM	4-100

--

System control

Compiler control
LOCALCHECK.....4-142

ABS

Function

Function	The ABS function calculates an absolute value.
Format	ABS (numerical-expression)
Example of Use	AA = ABS (-50) AA = ABS (Var)
Description	The ABS function calculates the absolute value of the numerical expression (numeric constant, integer-type variable, or floating-point-type variable) enclosed in parentheses.
Related Item	None

Example of Program

```
evnt
  input type% , id@ , data%
  if data% < 0 then data% = abs(data%)
  numdsp ..num000 , data%
end evnt
```

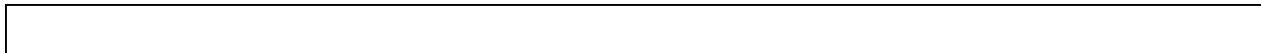

ADDCYC

Statement

Function The ADDCYC statement enables even BASIC of a part to read the device declared in control-name.

Format ADDCYC control-name

Example of Use ADDCYC ..NUM000

Description

- When a control in a part is used to validate an operation parameter, the ADDCYC statement enables even a part program to cyclically communicate with the PLC device/memory table set in the part operation parameter specification.
- The number of devices must match that of devices to be used by the control. (The devices placed in consecutive stages are used only the number of elements.)
- control-name must be the primitive in the local part.
- If the specified control is not using the PLC device/memory table, an error occurs.
- When the control is specified in a numeric display in a doubleword, the ADDCYC statement also reads it in a doubleword.

Related Item CYCLIC, CYCLIC2, ADDCYCID

Example of Program

```

conf
  ADDCYC ..NUM000          ' Uses 2X2 as a consecutive-stage display.
end conf
evnt
  input type% , id@ , data% ' Displays data on the corresponding display.
  id1@ = addcycid ( ..NUM000) ' Indicates the ID of the device being used.
  i% = getoffset (id1@, id@)+1 ' Indicates the device to be used relative to the first
device.
  id1@ = getid(..NUM000, i%) ' Obtains the ID of the corresponding display.
  numdsp id1@, data%       ' Displays the ID on the display.
end evnt

```

ADDCYC2

Statement

Function	The ADDCYC2 statement enables even BASIC of a part to read the device declared in primitive-name.
Format	ADDCYC2 primitive-name
Example of Use	ADDCYC2 ..NUM000
Description	<ul style="list-style-type: none"> • The ADDCYC2 statement is almost equivalent to the ADDCYC statement. • The only difference between these two statements is that the PLC device declared in the ADDCYC2 statement can communicate to obtain data even if the screen showing the declared part is not being displayed (when another screen is being displayed). Usually, the declared PLC device communicates to obtain data only when the screen showing the declared part is being displayed.
Related Item	ADDCYC, ADDCYCID

Example of Program

```

conf
  ADDCYC2 ..NUM000           ' Uses 2X2 as a consecutive-stage display.
end conf
evnt
  input type% , id@ , data%   ' Displays data on the corresponding display.
  id1@ = addcycid ( ..NUM000) ' Indicates the ID of the device being used.
  i% = getoffset (id1@, id@)+1 ' Indicates the device to be used relative to the first
device.
  id1@ = getid(..NUM000, i%)  ' Obtains the ID of the corresponding display.
  numdsp id1@, data%         ' Displays the ID on the display.
end evnt

```

ADDCYCID

Function

Function	The ADDCYCID function obtains the ID of the device that was declared in control-name and enabled to be read by even part programs.
Format	ADDCYCID (control-name)
Example of Use	ID@ = ADDCYCID (..NUM000)
Description	<ul style="list-style-type: none"> • The ADDCYCID function obtains the ID of the device being used by the control enabled to be read by even part programs and returns the ID type. To enable this operation, however, the operation parameters of the control in the part must be set to “effective” and the PLC device must be set in the associated operation parameter in advance. • control-name must be the primitive in the local part. • If the specified primitive is not using the PLC device/memory table, an error occurs.
Related Item	ADDCYC, ADDCYC2

Example of Program

```

conf
  addcyc ..NUM000          ' Uses 2X2 as a consecutive-stage display.
end conf
evnt
  input type% , id@ , data%  ' Displays data on the corresponding display.
  id1@ = ADDCYCID ( ..NUM000) ' Indicates the ID of the device being used.
  i% = getoffset (id1@, id@)+1 ' Indicates the device to be used relative to the first
device.
  id1@ = getid(..NUM000, i%) ' Obtains the ID of the corresponding display.
  numdsp id1@, data%        ' Displays the ID on the display.
end evnt

```

ASC

Function

Function	The ASC function specifies the first 1-byte character code of a character string.
Format	ASC (character-string)
Example of Use	AA = ASC ("AABCD") AA = ASC (MOJI\$)
Description	<ul style="list-style-type: none">• The ASC function specifies the first character code of the character expression (character string constant or variable) enclosed in parentheses with a decimal number.• The ASC function specifies only the initial 1-byte code of a character expression which begins with a Kanji character.
Related Item	CHR\$

Example of Program

```
evnt
  input type, id@, data$
  num = ASC (data$)
  numdsp ..NUM000, num
end evnt
```

ATN

Function

Function	The ATN function calculates the inverse tangent for the numerical expression.
Format	ATN (numerical-expression)
Example of Use	ANGLE = ATN (X/Y)
Description	The ATN function calculates the inverse tangent value for the numerical expression. The result must be a value from $-\pi/2$ to $\pi/2$. The unit is radian.
Related Item	TAN

Example of Program

```
evnt
.....
pi = 3.141592
angle% = atn( pi/4)
numdsp ..num000 , angle%
end evnt
```

AUTO

Statement

Function

The AUTO statement declares an auto variable.

Format

AUTO variable name [, variable name ...]

Example of Use

AUTO VAR, XYZ(2,3), MOJI\$ * 20

Description

- The AUTO statement declares that the variable is an auto variable. An auto variable can be declared and referenced in a function only.
- The value of an auto variable stays valid only while the function of that variable is called and executed.
- The value of an auto variable is initialized when the function is called and execution starts.
- A variable name can be specified in a normal variable, arrangement variable or character string variable.
- DIM declaration or STRING declaration is not needed to declare an arrangement variable or character variable.
- The auto variable type is one of the new features of Screen Creator 5.

Related Item**Example of Program**

```
function userfunc%(a%, b%)
    AUTO c%
    c% = a% + b%
    userfunc% = c% / 2
end function
```

BACKUP

Statement

Function	The BACKUP statement declares a backup variable.
Format	BACKUP variable-name [,variable-name ...]
Example of Use	BACKUP VAR, XYZ(2,3), MOJI\$*20
Description	<ul style="list-style-type: none">• The BACKUP statement declares a backup variable. Besides the characteristics of a global variable, a backup variable has a function to retain its value even if the power supply is turned off.• A normal variable, an array variable, or a character string variable can be specified in variable-name.• In order to declare arrays and character string type, no DIM and STRING declarations are required.
Related Item	AUTO, DIM, GLOBAL, LOCAL, STATIC, STRING

Example of Program

```
conf
  BACKUP a , x(2,3) , moji$ * 40
  .....
end conf
```

BARCOLOR

Statement

Function	The BARCOLOR statement changes the bar color and figure of the bar graph display.
Format	BARCOLOR display-name, bar-number, tile-1, display-color-1, background-color-1, tile-2, display-color-2, background-color-2
Example of Use	BARCOLOR ..BAR000, 2, 3, 1, 4, 5, 2, 1
Description	<ul style="list-style-type: none"> • The BARCOLOR statement changes the bar tiles and colors of the bar graph display and the background tiles and colors of the entire display. -1 indicates that the color and tile for which -1 was specified remain unchanged. • control-name is the name of a bar graph or the ID-type variable indicating the graph. • The value indicating the bar number in the bar graph to be changed is set in bar-number. The bar number can be specified with a constant or variable. The bar number starts at 1. • tile-1 indicates the tiling figure of the bar. Specify this tiling figure with a numeric value from 0 to 15. • display-color-1 is a numeric value indicating the color number of the tile display section. Specify this color number with a numeric value from 0 to 15. • background-color-1 is a numeric value indicating the color number of the tile background section. Specify this color number with a numeric value from 0 to 15. • tile-2 indicates the background tiling figure of the bar graph. Specify this tiling figure with a numeric value from 0 to 15. • display-color-2 is a numeric value indicating the color number of the tile display section of the background. Specify this color number with a numeric value from 0 to 15. • background-color-2 is a numeric value indicating the color number of the tile background section of the background. Specify this color number with a numeric value from 0 to 15.
Related Item	BARDSP, BARSHIFT

Example of Program

```
conf
  static name@
  name@ = ..BAR000
end conf
evnt
  input type%, id@, data%
  if type% = 3 then
    barcolor name@, 2, 2, 3, 1, 4, 5, 2
  end if
end evnt
```

BARDSP

Statement

Function	The BARDSP statement displays data in the bar graph display.
Format	BARDSP control-name, bar-number, display-value
Example of Use	BARDSP ..BAR000, 1, 30
Description	<ul style="list-style-type: none">• The BARDSP statement displays bar data in the bar graph display.• control-name is the name of a bar graph or the ID-type variable indicating the graph.• The value indicating the bar number in the bar graph to be displayed is set in bar-number. The bar number starts at 1.• display-value is the numeric data indicating the size of the bar graph.• display-value cannot be changed even if this statement is issued to the display for which operation parameters are set to “effective” in the control.
Related Item	BARCOLOR, BARSHIFT

Example of Program

```
conf
    static name@
    name@ = ..BAR000
end conf
evnt
    input type%, id@, data%
    bardsp name@, 2, data%
end evnt
```

BARSET

Statement

Function	The BARSET statement sets data in the bar graph display.
Format	BARSET, control-name, bar-number, display-data
Example of Use	BARSET .BUHIN.GRAPH, 2, 30.0
Description	<ul style="list-style-type: none">• The BARSET statement sets the data to be displayed in the bar graph display. The speed of executing the PRDSP (display) statement after setting data in each bar is faster than that of modifying all bar values after executing the BARDSP statement.• control-name is the name of the bar graph display name or the ID-type variable indicating the bar graph display.• bar-number indicates which bar data is to be modified when two or more bars are displayed in one bar graph display. The bar number is integer value data starting at 1.• display-data is the numeric data indicating the size of the bar graph.
Related Item	BARDSP, PRDSP

Example of Program

```
evnt
  BARSET .buhin.gpaph , 3 , 20.1
  var@ = .buhin.graph
  no = 4
  value = 23
  barset var@ , no , value
  prdsp var@
end evnt
```

BARSHIFT

Function

Function The BARSHIFT function shifts bar graph data left or right and displays it.

Format DATA% = BARSHIFT (control-name, shift-direction, display-data)

Example of Use DATA% = BARSHIFT (..BAR000, 1, 30)

Description

- When two or more bars are being displayed in one bar graph display, the BARSHIFT statement shifts the bars constituting the graph left or right by one bar and displays the bars.
- When the BARSHIFT function is executed, the values of the bars purged from the graph are returned as a result of the shifting.
- The variable indicating the graph name or ID is set in **control-name**.
- When **shift-direction** is 1, bar graph data is shifted left and above. When **shift-direction** is -1, bar graph data is shifted right and below.
- **display-data** indicates the data to be displayed in the vacant area produced as a result of the shifting.

Related Item BARDSP, BARCOLOR

Example of Program

```

evnt
  input type%, id@, data%
  if data% > 0 then
    abc% = barshift ( ..BAR000, 1, 0)
  else
    abc% = barshift ( ..BAR000, -1, 100)
  endif
end evnt

```

BCD2BIN

Function

Function	The BCD2BIN function converts BCD data to binary data.
Format	BCD2BIN (numerical-expression)
Example of Use	BINDATA% = BCD2BIN (BCDDATA%)
Description	The BCD2BIN function converts the entered BCD data to binary data.
Related Item	BIN2BCD

Example of Program

```
conf
  cyclic 00~D10
end conf
evnt
  input type%, id@, data%
  if type% = 16 then
    data% = BCD2BIN(data%)
    numdsp ..NUM000, data%
  endif
end evnt
```

BEEP

Statement

Function	The BEEP statement performs buzzer ON/OFF control.
Format	BEEP command-value
Example of Use	BEEP 1
Description	<ul style="list-style-type: none">• The BEEP statement is a command that sounds and stops the buzzer.• When command-value is 1, the buzzer sounds; when 0, the buzzer stops.• The SETBEEP statement can be used to set the buzzer ON/OFF time.
Related Item	SETBEEP

Example of Program

```
conf
  SETBEEP 50,20,3
end conf
evnt
  input type%, id@, data%
  if id@ = ..SWT000 then
    BEEP 1
  else
    BEEP 0
  endif
end evnt
```

BIN2BCD

Function

Function	The BIN2BCD function converts binary data to BCD data.
Format	BIN2BCD (numerical-expression)
Example of Use	BCDDATA% = BIN2BCD (BINDATA%)
Description	<ul style="list-style-type: none">• The BIN2BCD function converts binary data to BCD data.• If the binary data to converted to BCD data is greater than 99999999, it is fixed at 99999999.
Related Item	BCD2BIN

Example of Program

```
evnt
  input type%, id@, data%
  data% = BIN2BCD ( data% )
  00~D10 = data%
end evnt
```



BITSET

Statement

- Function** The BITSET statement sets the specified bit of a variable to ON or OFF.

- Format** BITSET variable-name, set-position, ON/OFF-value

- Example of Use** BITSET VARIABLE%, 10, 1

- Description**
 - The BITSET statement sets the specified bit of the specified variable to 0 or 1.
 - **variable-name** specifies the name of the variable where the specified bit is set to 0 or 1; it must be an integer- or floating-point-type variable.
 - **set-position** specifies where in the variable the specified bit is to be set with a value from 0 to 31; it must be a variable or constant.
 - When 1 is set in the variable, ON/OFF-value also specifies 1. When 0 is set, ON/OFF-value also specifies 0. It must be a variable or constant.

- Related Item** BITTEST

- Example of Program**

```

conf
end conf
evnt
    input type% , id@ , data%
    numdsp ..NUM000 , data%
    if bittest ( data% , 31 ) = 1 then
        bitset data% , 31 , 0
    else
        bitset data% , 31 , 1
    endif
    numdsp ..NUM000 , data%
end evnt

```

BITTEST

Function

- **Function** The BITTEST function tests the specified bit of a variable.
- **Format** BITTEST (variable-name, test-position)
- **Example of Use** ONOFF% = BITTEST (VARIABLE%, 10)
- **Description**
- The BITTEST function tests whether the value of the specified bit in the specified variable is 1 or 0. When the value of the specified bit is 1 as a result of the test, the function returns 1. When the value is 0, the function returns 0.
 - **variable-name** specifies the name of the variable where the value of the specified bit is to be tested; it must be an integer- or floating-point-type variable.
 - **test-position** specifies where in the variable the specified bit is to be tested with a value from 0 to 31; it must be a variable or constant.
- **Related Item** BITSET
- **Example of Program**

```
conf
end conf
evnt
    input type% , id@ , data%
    if bittest ( data% , 0 ) = 1 then
        strdsp ..STR000 , ``bit is ON``
    else
        strdsp ..STR000 , ``bit is OFF``
    endif
end evnt
```



BLCTL

Statement

Function	The BLCTL statement performs back light ON/OFF control.
Format	BLCTL status
Example of Use	BLCTL 1
Description	<ul style="list-style-type: none">• The BLCTL statement performs back light ON/OFF control.• status indicates whether to turn on or off the back light with the following numeric values:<ul style="list-style-type: none">0: The back light is turned off.1: The back light is turned on.
Related Item	BLSTAT

Example of Program

```
evnt
  ret =blstat()
  if ret = 0 then BLCTL 1
end evnt
```

BLSTAT

Function

Function	The BLSTAT function reads the back light status.
Format	BLSTAT ()
Example of Use	
Description	The BLSTAT function reads the current back light status (ON/OFF). The return values of this function are as follows: 0: The back light is off. 1: The back light is on.
Related Item	BLCTL

Example of Program

```
conf
  ret = BLSTAT()
  if ret = 0 then blctl 1
end conf
```

BLTCOLOR

Statement

Function	The BLTCOLOR statement changes the tile and color of a belt graph display.
Format	BLTCOLOR control-name, zone-position, tile, display-color, background-color
Example of Use	BLTCOLOR ..BLT000, 2, 1, 2, 3
Description	<ul style="list-style-type: none"> • The BLTCOLOR statement changes the tile and color of the specified zone of a belt graph display. -1 indicates that the color and tile for which -1 was specified remain unchanged. • control-name is the bar graph name or the ID-type variable indicating the bar graph. • The value indicating the zone number to be changed is set in zone-position. The zone position can be specified with a constant or variable. The zone position starts at 1. • tile indicates the tiling figure of the zone. Specify this tiling figure with a numeric value from 0 to 15. • display-color is a numeric value indicating the color number of the tile display section. Specify this color number with a numeric value from 0 to 15. • background-color is a numeric value indicating the color number of the tile background section. Specify this color number with a numeric value from 0 to 15.
Related Item	BLTDSP

Example of Program

```

evnt
  input type%, id@, zone%, tile%
  BLTCOLOR ..BLT000, zone%, tile%, -1, -1
end evnt

```

BLTDSP

Statement

Function	The BLTDSP statement displays data on a belt graph display.
Format	BLTDSP control-name, zone-number, display-value
Example of Use	BLTDSP ..BLT000, 1, 30
Description	<ul style="list-style-type: none"> • The BLTDSP statement displays data in the specified zone of a belt graph display. • control-name is the name of the graph or the ID-type variable. • The value indicating the zone number in the 100 percent bar chart to be displayed is set in zone-position. The zone position can be specified with a constant or variable. The zone position starts at 1. • display-value is the numeric data indicating the size of the data to be displayed in the 100 percent bar chart. • display-value cannot be changed even if this statement is issued to the display for which operation parameters are set to “effective” in the control.
Related Item	BLTCOLOR

Example of Program

```

conf
  static name@
  name@ = ..BLT000
end conf
evnt
  input type%, id@, zone%, data%
  BLTDSP ..BLT000, zone%, data%
end evnt

```

BLTSET

Statement

Function	The BLTSET statement sets data in a belt graph display.
Format	BLTSET control-name, zone-number, display-data
Example of Use	BLTSET .BUHIN.GRAPH, 2, 30.0
Description	<ul style="list-style-type: none"> • The BLESET statement sets the data to be displayed in the 100 percent bar chart display. The speed of executing the PRDSP (display) statement after setting data in each zone is faster than that of modifying all zone values after executing the BLTDSP statement. • control-name is the name of the belt graph display or the ID-type variable. • zone-number indicates which zone data is to be modified. The zone number is integer value data starting at 1. • display-data is the numeric data indicating the size of each zone in the 100 percent bar chart.
Related Item	BLTDSP, PRDSP

Example of Program

```

evnt
  BLTSET .buhin.gpaph , 3 , 20.1
  var@ = .buhin.graph
  no = 4
  value = 23
  BLTSET var@ , no , value
  prdsp var@
end evnt

```

BREAD

Function

Function The BREAD function reads the contents of the specified device or memory table in blocks.

Format BREAD device-name, data-read-count, array-variable-to-which-read-data-is-written
 BREAD memory-table-name, data-read-count, array-variable-to-which-read-data-is-written

Example of use BREAD 00~D0001, 10, VARI(2)

BREAD 00~MTBL(5), NUMS, VARI(X)

Description

- The BREAD function reads the contents of the specified device or memory table in blocks.
- This function collectively reads data from the specified device by the specified data read count.
- **device-name** indicates the name of the device to be read (device name indicating the read start address).
- **data-read-count** specifies the number of data to be continuously read from the specified device.
- The data read from the specified device is set in **array-variable-to-which-read-data-is-written**. This variable must be a one-dimensional array-type variable. The data read from the specified device is continuously written, starting from the location specified by this variable.
- When the array variable is smaller than the data read count, the data that cannot be written to the array is discarded.
- The number of data that can be read depends on the type of PLC. (Refer to “Serial Communication Manual.”)
- For memory link, a variable can be used as a table number.

Related Item BWRITE

Example of Program

```

conf
  cyclic 00~M01
  static PARAM%(10)
end conf

evnt
  input type%, id@, data%
  if id@ = 00~M01 and data% = 1 then
    BREAD 00~D10, 5, PAARAM%(3)
  endif
end evnt

```

BWRITE

Function

Function	The BWRITE function writes data to the specified device or memory table in blocks.
Format	BWRITE device-name, data-write-count, write-data-variable BWRITE memory-table-name, data-write-count, write-data-variable
Example of use	BWRITE 00~D0001, 10, VAR%(1) BWRITE 00~MTBL(20), NUM, VAA(1)
Description	<ul style="list-style-type: none"> • The BWRITE function writes data to the specified device or memory table in blocks. • This function collectively write data to the specified device by the specified data write count. • device-name indicates the name of the device to be written (device name indicating the write start address). • data-write-count specifies the number of data to be continuously written to the specified device. • write-data-variable is the variable containing the value to be written to the specified device. This variable must be a one-dimensional array-type variable. Data is continuously written to the specified device, starting from the location specified by this variable. • When the array variable is smaller than the data write count, 0 is written to the remaining area. When the array variable is greater than the data write count, the larger part is ignored. • The number of data that can be written depends on the type of PLC. (Refer to “Serial Communication Manual.”) • For memory link, a variable can be used as a table number.

Related Item BREAD

Example of Program

```

conf
  cyclic 00~M01
  static PARAM%(10)
end conf

evnt
  input type%, id@, data%
  if id@ = 00~M01 and data% = 1 then
    BWRITE 00~D10, 5, PAARAM%(3)
  endif
end evnt

```

CHDIR

Statement

Function	The CHDIR statement changes a directory and/or a drive.
Format	CHDIR directory-name
Example of Use	CHDIR "C:TEST"
Description	<ul style="list-style-type: none"> • The CHDIR statement is an instruction that changes the current directory and a drive. • Specify the directory to be changed with a character string constant or variable. • directory-name can be specified, starting from a drive name.
Related Item	MKDIR, RMDIR

Example of Program

```

conf
end conf
evnt
    .....
    CHDIR ``C:``           ' Changes the drive.
    CHDIR ``TEST``       ' Changes the directory.
    CHDIR ``E:ABC``     ' Changes both the drive and directory.
    .....
end evnt

```

CHKTIM

Function

Function	The CHKTIM function checks the status of the specified timer.
Format	RET = CHKTIM (timer-number)
Example of Use	RET = CHKTIM (14)
Description	<ul style="list-style-type: none">• The CHKTIM function checks whether the specified timer is being used (opened).• timer-number indicates the number of the timer to be checked; it must be an integer-type value from 0 to 15.• As a result of executing this function, any of the following values is returned:<ul style="list-style-type: none">0: The timer is not being used.1: The timer is being used by the local program.2: The timer is being used by a remote program.
Related Item	CLOSETIM, STARTTIM, STOPTIM, CONTTIM, SETTIM, READTIM, OPENTIM, OPENTIM2

Example of Program

```
evnt
  for i = 0 to 15
    ret = CHKTIM (i)
    if ret = 0 then i = 15
  next
end evnt
```

CHR\$

Function

Function The CHR\$ function assigns the character corresponding to the specified numeric value (character code).

Format CHR\$ (character-code)

Example of Use MOJI\$ = CHR\$(&H30)

Description

- The CHR\$ function assigns the character (1-byte character) corresponding to the character specified by character-code.
- character-code must be an integer from 1 to 255.
- As a result of executing this function, the character corresponding to character-code is returned.

Related Item ASC

Example of Program

```
evnt
  input type%, id@ data%
  moji$ = CHR$(data%)
  strdsp ..STR000, moji$
end evnt
```

CINT

Function

Function The CINT function rounds off a real number and converts it to an integer.

Format CINT (numerical-expression)

Example of Use A% = CINT (FLOAT)

Description • The CINT function rounds off the value indicated by numerical-expression and converts it to an integer.
• The conversion result range becomes the integer range.

Related Item INT

Example of Program

```
evnt
  input type%, id@, data
  intvar% = CINT ( data )
  numdsp ..NUM000, intvar%
end evnt
```

CIRCOLOR

Statement

Function The CIRCOLOR statement changes the tile and colors of the pie chart display.

Format CIRCOLOR control-name, zone-position, tile, display-color, background-color

Example of Use CIRCOLOR ..CIR000, 2, 1, 2, 3

Description

- The CIRCOLOR statement changes the tile and colors of the the pie chart display. -1 indicates that the color and tile for which -1 was specified remain unchanged.
- control-name is the pie chart name or the ID-type variable indicating the pie chart.
- The value indicating the number of the zone in the pie chart to be changed is set in zone-position. The zone position starts at 1.
- tile indicates the tiling figure of the zone. Specify this tiling figure with a numeric value from 0 to 15.
- display-color is a numeric value indicating the color number of the tile display section. Specify this color number with a numeric value from 0 to 15.
- background-color is a numeric value indicating the color number of the tile background section. Specify this color number with a numeric value from 0 to 15.

Related Item CIRDSP

Example of Program

```

evnt
  input type%, id@, zone%, tile%
  CIRCOLOR ..CIR000, zone%, tile%, -1, -1
end evnt

```

CIRDSP

Statement

Function	The CIRDSP statement displays data in the zone where the pie chart display was specified.
Format	CIRDSP control-name, zone-number, display-value
Example of Use	CIRDSP ..CIR000, 1, 30
Description	<ul style="list-style-type: none"> • The CIRDSP statement displays data in the zone where the pie chart display was specified. • control-name is the pie chart name or the ID-type variable indicating the pie chart. • The value indicating the zone number in the pie chart to be displayed is set in zone-number. The zone number can be specified with a constant or variable. The zone number starts at 1. • display-value is the numeric data indicating the size of the pie chart to be displayed. • display-value cannot be changed even if this statement is issued to the display for which operation parameters are set to “effective” in the control.
Related Item	CIRCOLOR

Example of Program

```

conf
    static name@
    name@ = ..CIR000
end conf
evnt
    input type%, id@, zone%, data%
    CIRDSP ..CIR000, zone%, data%
end evnt

```

CIRSET

Statement

Function	The CIRSET statement sets data in the pie chart display.
Format	CIRSET control-name, zone-number, display-data
Example of Use	CIRSET .BUHIN.GRAPH, 2, 30.0
Description	<ul style="list-style-type: none"> • The CIRSET statement sets the data to be displayed in the pie chart display. The speed of executing the PRDSP (display) statement after setting data in each zone is faster than that of modifying all zone values after executing the CIRDSP statement. • control-name is the name of the pie chart display or the ID-type variable indicating the pie chart display. • zone-number indicates which zone data is to be modified. The zone number is integer value data starting at 1. • display-data is the numeric data indicating the size of each zone of the pie chart.
Related Item	CIRDSP, PRDSP

Example of Program

```

evnt
  CIRSET .buhin.gpaph , 3 , 20.1
  var@ = .buhin.graph
  no = 4
  value = 23
  CIRSET var@ , no , value
  prdsp var@
end evnt

```

CLEAR

Statement

Function	The CLEAR statement clears the display of the specified display.
Format	CLEAR control-name
Example of Use	CLEAR ..NUM000
Description	<ul style="list-style-type: none">• The CLEAR statement clears the display of the specified display, leaving only the background color.• When the slide display is specified, the CLEAR statement clears the pointer graphic.• When the meter display is specified, the CLEAR statement clears the needle.• When the clock display is specified, the CLEAR statement clears nothing.• control-name is the graph name or the ID-type variable indicating the graph. display-name.
Related Item	NUMDSP, STRDSP, FIGDSP, SLDDSP, MTRDSP, FREDSP, PLTDSP, BARDSP, BLTDSP, CIRDSP, LNE DSP

Example of Program

```
evnt
  input type%, id@, data%
  if data% = 1 then
    CLEAR ..NUM000
  end if
end evnt
```

CLOSE

Statement

Function	The CLOSE statement closes the specified part.
Format	CLOSE part-name
Example of Use	CLOSE .B000.
Description	<ul style="list-style-type: none">• The CLOSE statement closes the part displayed on the screen. The undisplayed status is called the close status.• Nothing is performed even if the CLOSE statement is executed for the closed part.• The program is started if the closed part receives a message.• part-name is the name or ID of the part to be closed.
Related Item	OPEN

Example of Program

```
evnt
  input type% , id@ , data%
  if pstat(..) = 0 then
    close ..
  endif
end evnt
```

--

CLOSECOM

Statement

Function	The CLOSECOM statement temporarily stops the use of a serial line.
Format	CLOSECOM device-name
Example of Use	CLOSECOM HST
Description	<ul style="list-style-type: none"> • The CLOSECOM statement is a command that temporarily inhibits a program from receiving data from an external connecting device using the OPENCOM instruction. • HST (host computer), BCR (bar code reader), or TKY (ten-key pad) can be specified in device-name.
Related Item	OPENCOM

Example of Program

```

conf
    OPENCOM HST
end conf
evnt
    input type% , id@ , data%
    if type% = 3 and data% = 1 then
        CLOSECOM HST
    else if type% = 3 and data% = 0 then
        REOPENCOM HST
    endif
end evnt

```

CLOSEPARALLEL

Statement

Function	The CLOSEPARALLEL statement temporarily stops data input from a parallel port.
Format	CLOSEPARALLEL input-bit
Example of Use	CLOSEPARALLEL 3
Description	<ul style="list-style-type: none">• The CLOSEPARALLEL statement is an instruction that temporarily inhibits a program from receiving data as a message from the parallel port specification bit using the OPENPARALLEL instruction.• input-bit specifies the bit for inhibiting data reception.
Related Item	OPENPARALLEL, REOPENPARALLEL

Example of Program

```
conf
    OPENPARALLEL 3
end conf
evnt
    input type% , id@ , data%
    if type% = 3 and data% = 1 then
        CLOSEPARALLEL 3
    else if type% = 3 and data% = 0 then
        REOPENPARALLEL 3
    endif
end evnt
```

CLOSESIO

Statement

- **Function** The CLOSESIO statement closes a non-procedual communication port.
- **Format** CLOSESIO port-number
- **Example of Use** CLOSESIO 2
- **Description** • The CLOSESIO statement closes the port for stopping non-procedual communication.
• port-number specifies a channel for stopping non-procedual communication. CH1 to CH3 correspond to 1 to 3, respectively.
• The port to be closed must be opened in advance by the OPENSIO statement to be explained later.
- **Related Item** OPENSIO, SETSIO, WRITESIO, WRITWSIOB, FLUSH
- **Example of Program**

```
conf
  global buf$ * 200
  opensio 2 , 1 , buf$
  setsio 2 , &HD
end conf
evnt
  strdsp ..STR000 , buf$
  CLOSESIO 2
end evnt
```

CLOSETIM

Statement

Function	The CLOSETIM statement stops the user of the specified timer.
Format	CLOSETIM timer-number
Example of Use	CLOSETIM TIMID@ CLOSETIM VAR
Description	<ul style="list-style-type: none"> • The CLOSETIM statement returns the timer allocated by the OPENTIM, OPENTIM2, or OPENTIM3 function to the system. • The system can use up to 16 timers. The timers not to be used must be returned to the system. If allocating more than 16 timers is attempted, an error occurs. • timer-number indicates the number of the timer to be stopped and returned to the system. Whether the timer number is an ID- or integer-type value depends on how the timer is opened. (See “OPENTIM”, “OPENTIM2”, and “OPENTIM3.”)
Related Item	OPENTIM, OPENTIM2, OPENTIM3, STARTTIM, STOPTIM, CONTTIM, SETTIM, READTIM

Example of Program

```

conf
  static timid@
  timid@ = opentim()
  setim timid@, 20, 0
  starttim timid@
end conf
evnt
  input type% , id@ , data%
  if type% = 3 and id@ = ..SWT000 then
    stoptim timid@
  else if id@ = ..SWT001 then
    closetim timid@
  end if
end evnt

```

COLOR

Statement

Function	The COLOR statement sets the color, type, and size of a straight line or a dot.
Format	COLOR display-color, line-type, line-thickness or dot-size
Example of Use	COLOR 1, 0, 2
Description	<ul style="list-style-type: none"> • The COLOR statement sets the colors, types, and sizes of a straight line and a dot. The values specified in the LINE and DOT statements have priority over those to be specified in this statement. • display-color indicates the display color of the straight line or dot. Specify this display color with a numeric value from 0 to 15. The specified display color becomes the color pallet number of the tool. • line-type indicates the type of line to be drawn (for example, solid line and dotted line). Specify this line type with a numeric value from 0 to 3. For the types of line, see “Plotting” to “Straight Line” of the tool. • line-thickness indicates the thickness of the line. dot-size indicates the size of the dot. Specify both the line thickness and dot size with a numeric value from 0 to 2.
Related Item	LINE, DOT

Example of Program

```

conf
  color 1 , 0 , 3
end conf
evnt
  ....
  dot 100,200
  dot 100,300
  color 1 , 0 , 0
  line 100,200,100,300
  ....
end evnt

```

CONF ... END CONF

Statement

Function The CONF ... END CONF statements declare the configuration block area.

Format CONF

 END CONF

Example of Use CONF
 static VAR%
 END CONF

Description

- The configuration block written in a screen and a part is executed only once when the screen is displayed. This block is not executed when the screen is being displayed. It is executed once again when the screen is redisplayed after another screen has been displayed.
- The configuration block for global screens and parts is executed only once when the system is started.
- Initialization blocks (INIT) are used to write processing such as initialization.
- Only the configuration block for closed parts is not executed even if a screen is displayed. This configuration block is executed when a part is opened. (See "OPEN Instruction.")

Related Item EVNT ... END EVNT, INIT ... END INIT

Example of Program

```
CONF
  static moji$
END CONF
evnt
  input ty%, id@, dat$
end evnt
```

CONST

Statement

Function	The CONST statement declares a constant.
Format	CONST constant name = constant
Example of Use	CONST #MAX#=10
Description	<ul style="list-style-type: none">• The constant name should be enclosed in a pair of # marks according to the variable name generation rule.• If a constant is declared in a program, the constant name is replaced with a declared constant value.• The CONST statement cannot be used in a global screen program.• Constant declaration is one of the new features of Screen Creator 5.

Related Item

Example of Program

```
conf
  global L%
  const #MAXLENGTH#=100
  if L > #MAXLENGTH# then
    L = #MAXLENGTH#
  end if
end conf
```

CONTTIM

Statement

Function	The CONTTIM statement restarts the stopped timer.
Format	CONTTIM timer-number
Example of Use	CONTTIM TIMID@ CONTIM 4
Description	<ul style="list-style-type: none"> • The CONTTIM statement restarts the timer stopped by the STOPTIM instruction. The internal counter in the timer is continued from the timer stop status. • timer-number indicates the number of the timer to be restarted. Whether the timer number is an ID- or integer-type value depends on how the timer is opened. (See “OPENTIM”, “OPENTIM2”, and “OPENTIM3.”)
Related Item	OPENTIM, OPENTIM2, OPENTIM3, STARTTIM, STOPTIM, CLOSETIM, SETTIM, READTIM

Example of Program

```

conf
  static timid@
  opentim2(3)
  settim 3, 20, 0
  starttim 3
end conf
evnt
  input type% , id@ , data%
  if type% = 3 and id@ = ..SWT000 then
    stoptim 3
  else if id@ = ..SWT001 then
    conttim 3
  end if
end evnt

```

COPY

Statement

Function	The COPY statement makes a hardcopy of a screen.
Format	COPY color-number
Example of use	COPY 5
Description	<ul style="list-style-type: none">• The COPY statement makes a hard copy of a displayed screen. In the "Color Number" field, a color specified on the color palette of Screen Creator 5 is printed black.• If color palette number 16 is specified, in addition to color palette numbers from 0 and 15, colors of even color palette numbers are printed black. If 17 is selected, the print colors of number 16 are inversed, i.e., colors of odd color palette numbers are printed black.• If an even color palette number is specified in monochrome printing, the print color is the same as in the case where color palette number 2 is selected. If an odd color palette number is specified, the print color is the same as in the case where color palette number 1 is selected.• The "Color Number" can be specified only when "Select Color" is selected in "Screen Print Mode" of "Printer Setup" of "System Setup" on the OIP system screen.

Related Item

Example of Program

```
evnt
  input ty%,id@
  if id@ = ..SWT000 then COPY 8
end evnt
```

COS

Function

Function The COS function calculates a cosine for the specified numerical expression.

Format COS (numerical-expression)

Example of Use X = COS (ANGLE)

Description The COS function calculates a cosine value for the specified numerical expression. The unit for the numerical expression is radian.

Related Item ATN, SIN, TAN

Example of Program

```
evnt
  angle = 3.141592/3
  x = COS ( angle )
end evnt
```

CURDIR

Statement

Function	The CURDIR statement makes a character string indicating the current directory path name into a character string variable.
Format	CURDIR character string variable
Example of Use	CURDIR PATH\$
Description	A full path name including a drive name should be written.
Related Item	DIR,CHDIR,MKDIR,RMDIR

Example of Program

```
conf
  strdsp ..str, "curdir"
end conf
evnt
  input type%, id@, data%
  if data% = 1 then
    curdir path$
    strdsp .dsp.str, path$
  end if
end evnt
```

CVB

Function

Function The CVB function allocates data from any position of a character string variable.

Format CVB (character-string-variable-name, allocation-position)

Example of Use VAR% = CVB (MOJI\$, 5)

Description

- The CVB function allocates data one byte from the specified allocation- position of the specified character variable name. The allocated data is regarded as an integer value.
- allocation-position must be an integer- or floating-point-type variable or constant. 1 specifies the beginning of the character string variable.

Related Item MKS, MKB, MKW, MKI, MKF, MKID, CVW, CVI, CVF, CVID

Example of Program

```

conf
end conf
evnt
  org$ = ``1234567``
  data% = CVB ( org$, 3 )
  numdsp ..NUM000, data%      ' Displays 51(&H33).
end evnt

```

CVF

Function

Function	The CVF function allocates data from any position of a character string variable.
Format	CVF (character-string-variable-name, allocation-position)
Example of Use	VAR = CVF (MOJIS, 5)
Description	<ul style="list-style-type: none"> • The CVF function allocates data four bytes from the specified allocation- position of the specified character variable name. The allocated data is regarded as a real value. • allocation-position must be an integer- or floating-point-type variable or constant. 1 specifies the beginning of the character string variable. • The CVF function returns a real number. • A cut-out value is converted into a 86 series boundary.
Related Item	MKS, MKB, MKW, MKI, MKF, MKID, CVB, CVW, CVI, CVID

Example of Program

```

conf
end conf
evnt
  org$ = ``1234567``
  strdsp ..STR000, org$
  mkf org$, 2, 1.23
  strdsp ..STR001, org$      ' The character string will not be displayed correctly.
  data% = CVF ( org$, 2 )
  numdsp ..NUM000, data%    ' Displays 1.23.
end evnt

```

CVI

Function

Function	The CVI function allocates data from any position of a character string variable.
Format	CVI (character-string-variable-name, allocation-position)
Example of Use	VAR% = CVI (MOJI\$, 5)
Description	<ul style="list-style-type: none"> • The CVI function allocates data four bytes from the specified allocation- position of the specified character variable name. The allocated data is regarded as an integer value. • allocation-position must be an integer- or floating-point-type variable or constant. 1 specifies the beginning of the character string variable. • A cut-out value is converted into a 86 series boundary.
Related Item	MKS, MKB, MKW, MKI, MKF, MKID, CVB, CVW, CVF, CVID

Example of Program

```

conf
end conf
evnt
  org$ = ``1234567``
  data% = CVI ( org$, 3 )
  numdsp ..NUM000, data%      ' Displays &H36353433.
end evnt

```

CVID

Function

Function	The CVID function allocates data from any position of a character string variable.
Format	CVID (character-string-variable-name, allocation-position)
Example of Use	VAR@ = CVID (MOJI\$, 5)
Description	<ul style="list-style-type: none"> • The CVID function allocates data six bytes from the specified allocation- position of the specified character variable name. The allocated data is regarded as an ID value. • allocation-position must be an integer- or floating-point-type variable or constant. 1 specifies the beginning of the character string variable. • The CVID function returns an ID-type value. • A cut-out value is converted into a 86 series boundary (by 2 bytes).
Related Item	MKS, MKB, MKW, MKI, MKF, MKID, CVB, CVW, CVI, CVIF

Example of Program

```

conf
end conf
evnt
  org$ = ``1234567``
  data@ = CVID ( org$, 1 )
end evnt

```

CVW

Function

Function The CVW function allocates data from any position of a character string variable.

Format CVW (character-string-variable-name, allocation-position)

Example of Use VAR% = CVW (MOJI\$, 5)

Description

- The CVW function allocates data two bytes from the specified allocation-position of the specified character variable name. The allocated data is regarded as an integer value.
- allocation-position must be an integer- or floating-point-type variable or constant. 1 specifies the beginning of the character string variable.
- A cut-out value is converted into a 86 series boundary.

Related Item MKS, MKB, MKW, MKI, MKF, MKID, CVB, CVI, CVF, CVID

Example of Program

```

conf
end conf
evnt
  org$ = ``1234567``
  data% = CVW ( org$, 3 )
  numdsp ..NUM000, data%      ' Displays &H3433.
end evnt

```

CYCLIC

Statement

Function	The CYCLIC statement declares that the contents of the specified device or memory table are periodically read.
Format	CYCLIC device-name, device-name, device-name, *number CYCLIC memory-table-name, memory-table-name, memory-table-name, *number
Example of Use	CYCLIC 00~D01, 00~D10 * 5 CYCLIC 00~MTBL(100), 00~MTBL(200) * 10
Description	<ul style="list-style-type: none">• The CYCLIC statement periodically reads the contents of the declared PLC device through communication. If the previously read contents do not match the contents read by this statement (change of contents), a messages is transmitted to the declaring operation program. This statement never operates during execution of the operation program because it makes a declaration.• This declaration must be made before the device is used in the program.• Communication occurs when data is read from the device (example: A=00~D0001) for which CYCLIC is not declared.• To declare CYCLIC for the memory table, the table number must be specified with an integer value.• In the cyclic operation of the memory table, a message is issued when data is written from the host computer or operation program to the memory table. (This message is issued even if the contents do not change.)• Specifying “*number” following device-name or memory-table-name enables CYCLIC to be continuously declared.• When the screen is switched, a message is issued to all the parts for which CYCLIC is declared.
Related Item	INPUT

Example of Program

```
conf
  cyclic 00~d01 , 00~d4 * 3
  cyclic 00~mtbl(20), 00~mtbl(100)
end conf
evnt
  input ty%,id@,dat%
  if id@ = 00~mtbl(20) then
    numdsp ..num , dat%
  end if
  .....
end evnt
```

CYCLIC2

Statement

Function	The CYCLIC2 statement declares that the contents of the specified device are periodically read as a doubleword.
Format	CYCLIC2 device-name, device-name, device-name, *number
Example of Use	CYCLIC2 00~D01, 00~D10 * 5
Description	<ul style="list-style-type: none"> • The CYCLIC2 statement is the same as the CYCLIC statement except that the contents of the device are read as a doubleword. • The word having a larger device number is the high-order word. • No memory table can be declared. • When the screen is switched, a message is issued to all the parts for which CYCLIC2 is declared.
Related Item	INPUT, CYCLIC

Example of Program

```

conf
  cyclic2 00~d01 , 00~d7 * 3
end conf
evnt
  input ty%,id@,dat%
  if id@ = 00~d01 then
    numdsp ..num , dat%
  end if
  .....
end evnt

```

DATE\$

Function

Function	The DATE\$ function reads the current date.
Format	DATE\$
Example of Use	MOJI\$ = DATE\$
Description	<ul style="list-style-type: none"> • The year, month, and day of the current date to be read are each represented in two digits like YY/MM/DD. • The DATE\$ function cannot be used to set a date. • Once date is set using the SETDATE command in a model with a battery backup calendar IC (GC56LC or GC55EM), the date is updated even while the power is off. If a model with no calendar IC (GC53LC or GC53LM) is turned off, the date is initialized to 98-01-01 and the time to 00:00:00 when it is turned on again. The date and time are updated while the power is on.
Related Item	GETDATE,GETTIME,SETDATE,SETTIME,TIME\$

Example of Program

```

conf
    moji$ = DATE$
    strdsp ..STR000 , moji$
end conf

```

DECLARE

Statement

Function	The DECLARE statement declares a function.
Format	DECLARE function name [type declaration character](variable declaration[, variable declaration] ...)
Example of Use	DECLARE ADD\%(A\%,B\%)
Description	<ul style="list-style-type: none">• The DECLARE statement declares a type of a function used in a program. (Such declaration is called prototype declaration.)• A function itself is declared in one of the three manners as shown below:<ul style="list-style-type: none">- Local function: Defined in a program other than a global screen program.- Global function: Defined in a global screen program.- Library function: Defined in a library.• The declared type of a function (in the prototype declaration) must be the same as the type of the function itself.• This is one of the new features of Screen Creator 5.
Related Item	FUNCTION, FUNCTIONCHECK

Example of Program

```
DECLARE my_add(a%,b%)
conf
  global x%,y%
  local sum%
  sum% = my_add(x%,y%)
end conf
```

DEV RD

Statement

Function	The DEV RD statement reads the contents of the specified device.
Format	DEV RD device-name, offset-value, variable-name
Example of Use	DEV RD 00~D10, 10, VALUE%
Description	<ul style="list-style-type: none"> • The DEV RD statement reads data from the device that is offset-value away from the device specified in device-name. • offset-value specifies the distance from the device specified in device-name. The DEV RD statement reads data from the device corresponding to the specified distance. offset-value must be an integer- or floating-point-type variable or constant. • variable-name specifies the variable that stores the read data; it must be an integer- or floating-point-type variable. • The DEV RD statement is used for the device (e.g., CYCLIC 00~D10 * 10) where “continuous cycle” is declared in the CYCLIC or CYCLIC2 statement. • If the device from which data is to be read does not exist, an error occurs. • Be sure to use this command in an event block. The value 0 is set in the variable, since an initialization block or configuration block is executed before reading device data.
Related Item	CYCLIC, EVENTWR, DEVWR

Example of Program

```

conf
  cyclic 00~D10 * 5      ' Declares that data is read from the device that is 5
end conf                ' away from D10.
evnt
  input type% , id@ , data%      ' Reads and displays the continu-
  if id@ = ..SWT000 and data% = 1 then ' ous device value when a switch
    for i% = 0 to 4              ' is pressedfor the continuous-
      id@ = getid ( ..NUM000, i%+1) ' stage numeric display.
      DEV RD 00~D10, i% , data%
      numdsp ..NUM000, data%
    next
  endif
end evnt

```

DEVWR

Statement

Function	The DEVWR statement writes data to the specified device.
Format	DEVWR device-name, offset-value, write-value
Example of Use	DEVWR 00~D10, 10, 5
Description	<ul style="list-style-type: none"> • The DEVWR statement writes data to the device that is offset-value away from the device specified in device-name. • offset-value specifies the distance from the device specified in device-name. The DEVWR statement writes data to the device corresponding to the specified distance. offset-value must be an integer- or floating-point-type variable or constant. • write-value specifies the data to be written to the specified device; it must be an integer- or floating-point-type variable or constant. • The DEVWR statement is used for the device (e.g., EVENTWR 00~D10 * 10) where “continuous write” is declared in the EVENTWR statement. • If the device to which data is to be written does not exist, an error occurs.
Related Item	CYCLIC, EVENTWR, DEVRD

Example of Program

```

conf
    eventwr 00~D10 * 5      ' Declares that data is to be written to the device that is
end conf                  ' 5 away from D10.
evnt
    input type% , id@ , data%          '           Writes 10 to the
device whose
    DEVWR 00~D10, data% , 10          '           offset value is
data%.

end evnt

```

DIM

Statement

Function	The DIM statement defines an array.
Format	DIM variable-name (maximum-subscript-value [, maximum-subscript-value] ...)
Example of Use	DIM ABC\$(20), XYZ%(4,4,3), LOC!
Description	<ul style="list-style-type: none"> • The DIM statement defines the variable defined in variable-name as an local variable. • A local variable can be read and written only in a program where it is declared. The compiler gives a warning if an undefined local variable is used. Each local variable is initialized every time the block is executed. • If a variable has a subscript enclosed in parentheses, an arrangement variable is declared. • The number of maximum subscript values in parentheses indicates that of array dimensions. In arrays of two dimensions or higher, subscripts are specified, delimited by a comma (,). • maximum-subscript-value indicates the maximum value of subscript that can be specified. The subscript starts at 0. • A variable can be used as an array variable even if it is not declared in the DIM statement. In this case, the maximum value of the subscript is 10. • When a character variable is declared in an array, the element size can be declared. • Defining many arrays makes it impossible to display many screens because the OIP work area becomes small. • Screen Creator 5 has a new function for declaring local variables other than arrangement variables distinctively. • The DIM statement is provided to maintain the compatibility with GCSGP3. Use LOCAL, instead of DIM, to declare a local variable. • When a DIM statement is used to declare an arrangement variable, compatibility with GCSGP3 is maintained.
Related Item	AUTO, BACKUP, GLOBAL, LOCAL, STATIC, STRING

**Example of Program**

```
conf
  DIM FLOAT(10),ID@(5),MOJI$(10) * 40
  for i% = 1 to 5
    FLOAT(i%) = i*3
  next
end conf
```

DIR

Function

Function The DIR function makes a list of directory or file data into character string variables and returns the number of created data (i.e., the number of entries in the directory or file).

Format DIR (directory name, file attribute value, offset value, and character string variable)

Example of Use NUM% = DIR("A:SUBDIR", &H20, 6, LIST\$)

- Description**
- A directory name can be specified in a full path name including a drive name or in an abbreviated name beginning with a current directory name.
Example: A:\SUBDIR1\SUBDIR2 SUBDIR2\SUBDIR3
 - A file name, instead of a directory name, should be specified to create data of a single file.
 - A file attribute value for selecting data to be created should be specified in a logical OR of the flags shown below:
&H01: Read-only file
&H02: Hidden file
&H04: System file
&H08: Volume label
&H10: Sub-directory
&H20: Standard file
 - An offset value is specified in order to exclude the first "n" data from data to be created.
 - Each created data consists of a 40-byte record of the fixed length. It is followed by detailed data as shown below:

Name	Extension	Size	Day of updating	Time of updating
DISK_1	.	<VOL>	87-01-15	15:25
SAMPLE	.EXE	98765	92-11-03	9:12
ABCDEFGF	.	123456	94-03-21	11:34
TEST2	.C	256	93-05-05	12:07
DOWNLOAD	.OIP	<DIR>	87-02-14	21:13
KBASIC	.	<DIR>	93-12-24	8:25
DATA_007	.	32	89-10-10	10:42

In this example, seven data are created in character strings of 280 bytes in all. The label is shown for convenience only.

The number of data to be created depends on the size of the character string variable. As much data as possible is created.

Related Item DIR,CHDIR,MKDIR,RMDIR

Example of Program

```
conf
  global dname$(13), pname1$(13), pname2$(13)
  global dsel%, p1sel%, p2sel%
  static list$*2000
  strdsp ..str, "dir"
end conf
evnt
  input type%, id@, data%
  if data% = 1 then
    path$ = dname$(dsel%) + pname1$(p1sel%) + pname2$(p2sel%)
    strdsp .dsp.str, path$
    num% = dir(path$, &H3F, 0, list$)
    strdsp .dsp.str, list$
    numdsp ..num000,num%
  end if
end evnt
```

DINV

Statement

Function	Inverses the color in a specified screen area.
Format	DINV upper-left-X-coordinate, upper-left-Y-coordinate, lower-right-X-coordinate, lower-right-Y-coordinate
Example of Use	DINV 10, 10, 30, 30
Description	<ul style="list-style-type: none"> • Inverses the color in a rectangular area having opposite points of specified coordinates. • The upper left corner of the panel has the coordinates (0, 0). The horizontal direction (toward the right) corresponds to the X axis, and the vertical direction (toward below) corresponds to the Y axis. • Color is inverted as shown below. In color display, the palette values (0 to 15) are inversed. In other words, 0 is changed into 15, 1 is changed into 14, 7 is changed into 8, and so forth. In monochrome display, activated color is changed into deactivated color, deactivated color is changed into activated color, and transparent color is changed into activated color. • If this is used in an initialization block or configuration block, drawing is executed after executing this block and accordingly color is not inversed. Be sure to use this in an event block.
Related Item	None

Example of Program

```

evnt
  input ty,id@,dat
  if ty = 3 and id@ = ..SWT000 then
    DINV 0,0,639,399
  endif
end evnt

```

DOT

Statement

Function	The DOT statement displays dots on a screen.
Format	DOT X1, Y1
Example of Use	DOT 20,300
Description	<ul style="list-style-type: none">• The DOT statement displays a dot in the specified coordinate (X1,Y1).• X1 must be a numeric value from 0 to 639. Y1 must be a numeric value from 0 to 399 (GC55EM) or 0 to 479 (GC56LC).• Dots are directly displayed as the background of a screen. When a part is opened or closed in the area where dots are displayed or when a control is displayed, the dots may be cleared. The cleared dots are not redisplayed.• The size and color of a dot are specified by the COLOR statement.• If this is used in an initialization block or configuration block, drawing is executed after executing this block and accordingly points are not plotted. Be sure to use this in an event block.
Related Item	COLOR

Example of Program

```
conf
  color 1 , 0 , 3
end conf
evnt
  ....
  dot 100,200
  dot 100,300
  color 1 , 0 , 0
  line 100,200,100,300
  ....
end evnt
```

DSPMODE

Statement

Function	The DSPMODE statement changes the display mode of the control.
Format	DSPMODE control-name, display-mode
Example of Use	DSPMODE ..NUM000, 2
Description	<ul style="list-style-type: none"> • The DSPMODE statement is a command that changes the display mode of the control. • control-name is the control name or the ID-type variable indicating control name. • control-mode specifies the mode in which the control is displayed. The display mode is specified with any of the following numeric values: <ul style="list-style-type: none"> 0: Normal display mode 1: Inverse display mode 2: Blink display mode. (The display color is replaced with the background color.) 3: On-and-off display mode. (The display status and nondisplay status are repeatedly displayed.)
Related Item	NUMDSP, STRDSP, FIGDSP, SLDDSP, MTRDSP, FREDSP, PLTDSP, BARDSP, BLTDSP, CIRDSP, LNE DSP

Example of Program

```

evnt
  input ty,id@,data
  if id@ = ..SWT000 then
    DSPMODE ..NUM000 , 3
  endif
end evnt

```

EOF

Function

Function	The EOF function checks whether the end of the file was reached.
Format	EOF (file-number)
Example of Use	AAA = EOF (file-number)
Description	<ul style="list-style-type: none"> • <code>file-number</code> specifies the number of the file for which whether the end of the file was reached is to be checked. This file number must match the number of the file opened by the FOPEN statement. • Return value 1 indicates that the end of the file was reached. Return value 0 indicates that the end of the file is not reached.
Related Item	FOPEN, FIELD, FCLOSE, FPUT, FGET

Example of Program

```

conf
  field 5
    global no%
    global moji1$ , moji2$
  end field
  global sum%
  fopen ``C:TEST'', 2 , 5
  .....
end conf
evnt
  while EOF(5) = 0
    fget 5, i
    numdsp ..NUM000, no%
    strdsp ..STR000, moji1$
    strdsp ..STR001, moji2$
  wend
  fclose (5)
end evnt

```

ERRCTL

Statement

Function	The ERRCTL statement controls the error number display position.
Format	ERRCTL mode
Example of Use	ERRCTL 0
Description	<ul style="list-style-type: none"> • The ERRCTL statement controls the error number display position. • The error display position conforms with the value specified in mode. <ul style="list-style-type: none"> When mode is 0: An error number is displayed below a screen. When mode is 1: A message is issued to the error display. <ul style="list-style-type: none"> – When mode is 1, messages of error numbers 4000 to 4499 and 5000 to 5999 are issued to the error display (part ERRPTS on global screen). – Messages of error numbers 2000 to 2999 are issued only to the error display. – Following the type and issuer ID of an error, the error code, the number of the screen where the error occurred, and the number of the part where the error occurred are issued to the error display. (If a screen program error occurs, -1 is set as the part number.) – If part ERRPTS does not exist in the global screen, the error is displayed in the lowest line of the window screen.

Related Item ERRSTAT

Example of Program

```

evnt
  input ty%,id@,dat%
  if id@ = ..sw1 then
    if errstat () = 1 then
      errctl 0
    else
      errctl 1
    endif
  endif
end evnt

```

ERRSTAT

Function

Function	The ERRSTAT function reads the error display position.
Format	ERRSTAT
Example of Use	ERRSTAT()
Description	<ul style="list-style-type: none">• The ERRSTAT function reads the current error display position.• When this function is executed, any of the following numeric values indicating the display position is returned:<ul style="list-style-type: none">When 0 is returned, the error is displayed below the screen.When 1 is returned, the error is displayed in the error display.
Related Item	ERRCTL

Example of Program

```
evnt
  input ty%,id@,dat%
  if id@ = ..sw1 then
    if errstat () = 1 then
      errctl 0
    else
      errctl 1
    endif
  endif
end evnt
```

EVENTWR

Statement

Function The EVENTWR statement declares the device(s) to which data is to be written.

Format EVENTWR device-name, device-name, device-name *number,,,

Example of Use EVENTWR 00~D01, 00~D10 * 5

Description

- The EVENTWR statement declares the device(s) in a part or screen to which data is to be written. This statement only declares the devices to which data is to be written; it does not actually write data to the devices.
- Specifying *number enables two or more devices to be continuously declared. This continuous declaration, however, does not mean that data is written to all the declared devices at a time.
- The DEVWR statement is used to actually write data to the declared devices.
- The devices to which data is to be written must be declared before the DEVWR statement is executed.

Related Item CYCLIC, DEVRD, DEVWR

Example of Program

```

conf
    EVENTWR 00~D10 * 5           ' Declares that data is to be written to
end conf                       ' five devices from D10.
evnt
    input type% , id@ , data%   ' Writes 10 to the device whose offset
    devwr 00~D10, data% , 10    ' value is data%.
end evnt

```



EVNT ... END EVNT

Statement

Function	The EVNT...END EVNT statements declares the event block area.
Format	EVNT END EVNT
Example of Use	EVNT input ty,id@,data END EVNT
Description	<ul style="list-style-type: none"> The event block is a program block that operates when it receives a message. The contents executed when a switch is pressed or a message is received are written in these statements.
Related Item	CONF ... END CONF, INIT ... END INIT

Example of Program

```

conf
    static moji$
end conf
evnt
    input ty%, id@, dat$
end evnt

```

EXECPRCODE

Statement

Function	The EXECPRCODE statement executes primitive data operation.
Format	EXECPRCODE control-name, type, operation-data, variable-name
Example of Use	EXECPRCODE ..NUM000, 0, 20, VAR%
Description	<ul style="list-style-type: none"> • When a control in a part is used to validate an operation parameter, the EXECPRCODE statement executes data operation set in the part operation parameter specification. • type is usually 0. When the specified primitive is the plot display and type is 0, the EXECPRCODE statement executes X data operation. When type is 1, the statement executes Y data operation. • control-name must be the control in the local part. • operation-data specifies the value to be operated; it must be an integer- or floating-point-type variable or constant. • variable-name specifies the variable to which the operation result is to be written; it must be an integer- or floating-point-type variable. • If no operation code is written in the specified control, the value specified in operation-data is set in the specified variable.
Related Item	None

Example of Program

```

conf

end conf
evnt
  input type% , id@ , data%
  EXECPRCODE ..NUM000, 0, data%, data1%
  numdsp ..NUM001, data1%
end evnt

```

EXIT FUNCTION

Statement

Function	The EXIT FUNCTION statement exits a function forcedly.
Format	EXIT FUNCTION
Example of Use	FUNCTION DIV%(A%,B%) IF B%=0 THEN EXIT FUNCTION DIV%=A%/B% END FUNCTION
Description	<ul style="list-style-type: none">• The EXIT FUNCTION statement gives an instruction to exit a function forcedly in a function block where the function itself is defined and returns the control to the side which called the function.• This statement is one of the new features of Screen Creator 5.
Related Item	DECLARE, FUNCTION, FUNCTIONCHECK

Example of Program

```
declare my_div%(a%,b%)
conf
  global x%,y%
  local share%
  share% = my_div(x%,y%)
end conf
function my_div%(a%,b%)
  if b%=0 then EXIT FUNCTION
  my_div%=a%/b%
end function
```

EXP

Function

Function	The EXP function calculates the value of an exponential function for the base of a natural logarithm.
Format	EXP (numerical-expression)
Example of Use	VAR = EXP (A/2)
Description	The EXP function returns the result of exponent operation for the base (E) of the natural logarithm.
Related Item	LOG

Example of Program

```
evnt
  input ty,id@,data
  if ty = 3 then
    numdsp ..NUM000, EXP(10)
  else
    numdsp ..NUM000, EXP(5)
  endif
end evnt
```



FCLOSE

Statement

Function	The FCLOSE statement closes the specified file.
Format	FCLOSE file-number
Example of Use	FCLOSE 5
Description	<ul style="list-style-type: none"> • The FCLOSE statement closes the file specified by file-number. • file-number must match the number of the file opened by the FOPEN statement to be explained later. If another file number is specified, an error occurs. Specify file-number directly with a numeric value from 1 to 16.
Related Item	FOPEN, FIELD, FPUT, FGET

Example of Program

```

conf
  field 5
    global no%
    global moji1$ , moji2$
  end field
  fopen ``MEMORY``, 2 , 5
  .....
end conf
evnt
  .....

  FCLOSE 5
end evnt

```

FGET

Statement

Function	The FGET statement reads data from the specified file.
Format	FGET file-number, record-number
Example of Use	FGET 5, 3
Description	<ul style="list-style-type: none"> • The FGET statement reads the contents of the specified record (record-number) in the specified file (file-number) into the variable group declared by FIELD...END FIELD. • file-number specifies the number of the file to be read. This file number must match the number of the file opened by the FOPEN statement. • record-number specifies which record in the file is to be read first. In this case, the variable group included in FIELD declared in file-number is used as one unit. record-number is 1 when data is read from the beginning of the file.
Related Item	FOPEN, FIELD, FCLOSE, FPUT

Example of Program

```

conf
  field 5
    global no%
    global moji1$ , moji2$
  end field
  fopen ``MEMORY``, 2 , 5
  .....
end conf
evnt
  FGET 5 , 3
  numdsp ..NUM000 , no%
  strdsp ..STR000 , moji1$
  strdsp ..STR001 , moji2$
  fclose 5
end evnt

```

FIELD ... END FIELD

Statement

Function	FIELD ... END FIELD sets a file read/write unit.
Format	FIELD file-number variable-list variable-list END FIELD
Example of Use	FIELD 5 global abcd , xyz% static dddd(10,10) backup moji\$ END FIELD
Description	<ul style="list-style-type: none"> • FIELD ... END FIELD declares the unit for reading the file by the FGET statement or that for writing the file by the FPUT statement. • file-number specifies the number of the file onto or into which the variable group in the field is to be written or read. This file number must match the number of the file opened by the FOPEN statement; it is a value from 1 to 16. • The variable list that can be written between FIELD and END FIELD must be the GLOBAL, STATIC, or BACKUP variable. The method for declaring variable lists is the same as that for declaring the GLOBAL, STATIC, and BACKUP variables. • The FIELD declared in the program where the FOPEN statement was executed is the default read/write unit. • When a file is read or written by a part that differs from the part opened by the FOPEN statement, the FIELD declared in that part is used. If this FIELD is not declared, the default FIELD is used. • If two or more FIELDS are declared in the same file-number in one program, the last declared FIELD is valid. • FIELD ... END FIELD cannot be written in the global screen program.
Related Item	FOPEN, FCLOSE, FPUT, FGET

Example of Program

```
conf
  field 5
    global no%
    global moji1$ , moji2$
  end field
  fopen ``MEMORY'', 2 , 5
```

```
.....  
end conf  
evnt  
  no% = 1  
  moji1$ = ``product-name``  
  moji2$ = ``product-number``  
  fput 5 , 3  
  fclose 5  
end evnt
```

FIGCOLOR

Statement

Function	The FIGCOLOR statement changes the tile and colors of the graphic display.
Format	FIGCOLOR control-name, tile, display-color, background-color
Example of Use	FIGCOLOR .B000.FIG000, 1, 2, 3
Description	<ul style="list-style-type: none"> • The FIGCOLOR statement changes the tile and colors of the the graphic display. -1 indicates that the color and tile for which -1 was specified remain unchanged. • control-name is the graphic display name or the ID-type variable indicating the graphic display. • tile indicates a tiling figure. Specify this tiling figure with a numeric value from 0 to 15. • display-color is a numeric value indicating the color number of the tile display section. Specify this color number with a numeric value from 0 to 15. • background-color is a numeric value indicating the color number of the tile background section. Specify this color number with a numeric value from 0 to 15.
Related Item	FIGDSP

Example of Program

```

evnt
  input type%, id@, tile%
  FIGCOLOR ..FIG000, tile%, -1, -1
end evnt

```

FIGDSP

Statement

Function	The FIGDSP statement texture the graphic specified in the graphic display.
Format	FIGDSP control-name, texture-name
Example of Use	FIGDSP .B000.FIG000, SWFIG
Description	<ul style="list-style-type: none"> • The FIGDSP statement displays the texture specified in the texture display. This texture name must be the one created by the plotting tool. • control-name is the graphic display name or the ID-type variable indicating the graphic display. • texture-name is the variable indicating the name or ID of the texture to be displayed in the texture display or the registered graphic number (integer type). • display-value cannot be changed even if this statement is issued to the display for which operation parameters are set to “effective” in the control.
Related Item	FIGCOLOR, FIGFORM

Example of Program

```

evnt
  input ty , id@, figno%
  FIGDSP ..FIG000 , figno%
end evnt

```

FIGFORM

Statement

Function	The FIGFORM statement changes the display format of the texture display.
Format	FIGFORM control-name, resize-specification
Example of Use	FIGFORM ..HYOJIKI, 0
Description	<ul style="list-style-type: none"> • When the size of the texture display differs from that of the texture to be control in the control, the FIGFORM statement specifies whether to perform resize (magnification/reduction). Resize is performed to make the size of the texture to be displayed match that of the texture display. • control-name is the graphic display name or the ID-type variable indicating the graphic display. • The integer-type value indicating whether to perform resize is set in resize-specification. <ul style="list-style-type: none"> 0: Resize is not performed. 1: Resize is performed.
Related Item	FIGCOLOR, FIGDSP

Example of Program

```

evnt
  input ty , id@, data
  if ty = 3 and data = 1 then
    FIGFORM ..FIG000, 1
  else
    FIGFORM ..FIG000, 2
  endif
  figdsp ..FIG000, figno
end evnt

```

FINPUT

Statement

Function	The FINPUT statement reads data from the specified file.
Format	FINPUT file-number, variable, variable, ...
Example of Use	FINPUT 12, VAR% , STRING\$
Description	<ul style="list-style-type: none"> • The FINPUT statement reads data from the file specified by file-number into the specified variable. • A numeric or character string variable can be specified in variable. • The following delimiters can be used when data is read into the specified variable. They are not included in the variable. <ul style="list-style-type: none"> – Only comma “,” and carriage return (CR) can be used as delimiters. Line feed (LF) following CR is ignored. – When a numeric variable is specified, a blank can also be used as a delimiter. – When a character string variable is specified, the character string between double quotation marks (“”) is to be read. – If the type of data written to the specified file does not match that of the specified read variable, the contents of the variable are undefined. • file-number must match the number of the file opened by the FOPEN statement.
Related Item	FOPEN, FCLOSE, FPRINT, FWRITE, LINPUT

Example of Program

```

conf
  fopen  ``C:TEST``, 2 , 5
end conf
evnt
  var% = -2
  fwrite 5, 123, var%, ``ABCD``, ``XYZ``
  fseek(5, 0, 0)
  finput 5, VAR1%, VAR2%, VSTR1$, VSTR2$
end evnt

```

Data is written to the specified file as follows:

```
123,-2,``ABCD``,``XYZ`` CR/LF
```

When data is read, the variables change as follows:

```

VAR1%  123          VSTR1$  ABCD
VAR2%  -2           VSTR2$  XYZ

```

FLUSH

Statement

Function	The FLUSH statement returns the write position of a non-procedural communication reception buffer to the beginning of the variable.
Format	FLUSH port-number
Example of Use	FLUSH 2
Description	<ul style="list-style-type: none"> • The FLUSH statement enables received data to be written from the beginning of the variable to which the write position of the non-procedural communication reception buffer was returned. • port-number specifies the port (CH1 to CH3) to be flushed with a value from 1 to 3. • Execute the FLUSH statement when a reception completion message is received. Unless the FLUSH statement is executed, the reception buffer may become full. This statement only returns the write position of the reception buffer to the beginning of the variable; it does not clear data in the buffer. • The port to be flushed must be opened in advance by the OPENSIO statement to be explained later.
Related Item	OPENSIO, CLOSESIO, WRITESIO, WRITWSIOB, SETSIO

Example of Program

```

conf
  global buf$ * 200
  opensio 2 , 1 , buf$
  setsio 2 , &HD
end conf
evnt
  strdsp ..STR000 , buf$
  FLUSH 2
  closesio 2
end evnt

```

FOPEN

Statement

Function	The FOPEN statement opens the specified file.
Format	FOPEN file-name, mode, file-number
Example of Use	FOPEN "MEMORY", 2, 5
Description	<ul style="list-style-type: none"> • The FOPEN statement opens the file to be read or written. • file-name specifies the name of the file to be opened. The file having the name enclosed in double quotation marks is to be opened. Specify the name of the file to be opened with up to eight characters. When MEMORY is specified in file-name, internal memory is handled as a file. (Currently, only "MEMORY" can be specified in file-name.) • mode specifies the type of the file to be opened with one of the following numeric values: <ul style="list-style-type: none"> 0: Read-only file 1: Write-only file 2: Read/write file <p>When file-name is "MEMORY", the read/write file is opened regardless of what value is specified in mode.</p> • file-number is used when a file is read or written or when a record is set. Specify file-number directly with a numeric value from 1 to 16; it cannot be specified by a variable. • To handle internal memory as a file, the capacity of that memory must be set on the system mode screen in advance. • Attempting to execute the FOPEN statement for an unformatted file causes an error.

Related Item FCLOSE, FIELD, FPUT, FGET, FORMAT

Example of Program

```

conf
  field 5
    global no%
    global moji1$ , moji2$
  end field
  FOPEN ``MEMORY'', 2 , 5
  .....
end conf
evnt
  .....
end evnt

```

FOR ... TO ... NEXT

Statement

Function	The instructions between the FOR statement and NEXT statements are repeatedly executed by the specified count.
Format	FOR variable-name = start-value TO end-value [STEP increment] ... NEXT
Example of Use	FOR I = 1 TO 10 A(I) = 3 NEXT
Description	<ul style="list-style-type: none">• variable-name after the FOR statement specifies the variable used to count how many times the FOR to NEXT loop is repeated. variable-name must be an integer- or floating-point-type variable.• start-value indicates the initial value. The value of the variable increases by the value specified in increment each time the FOR to NEXT loop is repeated. (No negative value can be specified in increment.) When the increased value of the variable is greater than end-value, the statement following the NEXT statement is executed.• One FOR to NEXT loop can be nested.
Related Item	WHILE ... WEND, SELECT CASE

Example of Program

```
conf
  static VAR%(10)
  for i% = 0 to 10
    VAR%(i%) = i% * 3
  next
end conf
```

FORMAT

Statement

Function	The FORMAT statement initializes (formats) the specified file.
Format	FORMAT file-name
Example of Use	FORMAT "A:"
Description	<ul style="list-style-type: none"> • file-name specifies the name of the file to be initialized. • "A:", "E:" or "MEMORY" can be specified as the drive name. • When "MEMORY" is specified in drive-name, the contents of the file are filled with 0. • Be sure to execute the FORMAT statement when using the file for the first time.
Related Item	FOPEN, FIELD, FCLOSE, FPUT, FGET

Example of Program

```

conf
  field 5
    global no%
    global moji1$ , moji2$
  end field
  global sum%
  FORMAT ``MEMORY``
  fopen ``MEMORY``, 2 , 5
  .....
end conf
evnt
  no% = 1
  moji1$ = ``product-name``
  moji2$ = ``product-number``
  fput 5 , 3
  fclose 5
end evnt

```

FPRINT

Statement

Function	The FPRINT statement writes data to the specified file.
Format	FPRINT file-number, expression, expression, ...
Example of Use	FPRINT 12, 100, "ABCD", VAR%, STRING\$
Description	<ul style="list-style-type: none"> • The FPRINT statement writes the numeric value, variable or character defined in <i>expression</i> to the file specified by <i>file-number</i>. • A numeric value, a character, or a numeric or character variable can be specified in <i>expression</i>. • A numeric expression is converted to a numeric string and written to the specified file. When the data to be written is positive, a blank is written before it. When the data is negative, a minus sign (-) is written before it. A blank is also written after the written numeric string. • When a character string is written, no delimiter is inserted. • <i>file-number</i> must match the number of the file opened by the FOPEN statement.
Related Item	FOPEN, FCLOSE, FPUT, WRITE

Example of Program

```

conf
  fopen  ``C:TEST``, 2 , 5
end conf
evnt
  var% = -2
  fprint 5, 123, 45, var%, ``ABCD``, ``XYZ``
end evnt

```

Data is written to the specified file as follows:

```

123   45  -2 ABCDXYZ (   indicates a blank.)

```

FPUT

Statement

Function	The FPUT statement writes data to the specified file.
Format	FPUT file-number, record-number
Example of Use	FPUT 5, 3
Description	<ul style="list-style-type: none"> • The FPUT statement writes the contents of the variable group declared by FIELD...END FIELD to the specified record (record-number) in the specified file (file-number). • file-number specifies the number of the file to be written. This file number must match the number of the file opened by the FOPEN statement. • record-number specifies the record in the file to which the contents of the declared variable group is to be written. In this case, the variable group included in FIELD is used as one unit. record-number is 1 when data is written to the beginning of the file.
Related Item	FOPEN, FIELD, FCLOSE, FGET

Example of Program

```

conf
  field 5
    global no%
    global moji1$ , moji2$
  end field
  fopen ``MEMORY'', 2 , 5
  .....
end conf
evnt
  no% = 1
  moji1$ = ``product-name''
  moji2$ = ``product-number''
  FPUT 5 , 3
  fclose 5
end evnt

```

FRECOLOR

Statement

Function	The FRECOLOR statement changes the tiles and colors of the free graph display.
Format	FRECOLOR control-name, tile-1, display-color-1, background-color-1, tile-2, display-color-2, background-color-2
Example of Use	FRECOLOR ..FRE000, 2, 1, 4, 5, 2, 1
Description	<ul style="list-style-type: none">• The FRECOLOR statement changes the tiles and colors of the free graph display and the background tiles and colors of the entire display. tile-1 indicates that the color and tile for which 1 was specified remain unchanged.• control-name is the free graph name or the ID-type indicating the free graph name.• tile-1 indicates the tiling figure of the tile display section. Specify this tiling figure with a numeric value from 0 to 15.• display-color-1 is a numeric value indicating the color number of the tile display section. Specify this color number with a numeric value from 0 to 15.• background-color-1 is a numeric value indicating the color number of the tile background section. Specify this color number with a numeric value from 0 to 15.• tile-2 indicates the background tiling figure of the free graph. Specify this tiling figure with a numeric value from 0 to 15.• display-color-2 is a numeric value indicating the color number of the tile display section of the background. Specify this color number with a numeric value from 0 to 15.• background-color-2 is a numeric value indicating the color number of the tile background section of the background. Specify this color number with a numeric value from 0 to 15.
Related Item	FREDSP

Example of Program

```
conf
  static name@
  name@ = ..FRE000
end conf
evnt
  input type%, id@, data%
  if type% = 3 then
    FRECOLOR name@, 2, 3, 1, 4, 5, 2
  endif
end evnt
```

FREDSP

Statement

Function	The FREDSP statement specifies the value to be displayed in the free graph display.
Format	FREDSP control-name, display-value
Example of Use	FREDSP .B000.FRE000, 50
Description	<ul style="list-style-type: none">• The FREDSP statement specifies the value to be displayed in the free graph.• control-name is the name of the free graph display or the ID-type variable indicating the free graph display.• display-value is the value specifying the filling range in the free graph display.• display-value cannot be changed even if this statement is issued to the display for which operation parameters are set to “effective” in the primitive.
Related Item	FRECOLOR

Example of Program

```
conf
  static name@
  name@ = ..FRE000
end conf
evnt
  input type%, id@, data%
  FREDSP name@, data%
end evnt
```

FSEEK

Function

Function	The FSEEK function changes the read/write position of a file.
Format	FSEEK (file-number, reference-position, offset)
Example of Use	AAA% = FSEEK (12, 0, 0)
Description	<ul style="list-style-type: none">• The FSEEK function moves the read/write position of the file by the value specified by offset, starting from reference-position.• file-number specifies the number of the file opened by the FOPEN statement.• 0, 1, and 2 can be specified in reference-position. When 0 is specified, the FSEEK function moves the read/write position, starting from the beginning of the file. When 1 is specified, the function moves the read/write position, starting from the current position. When 2 is specified, it moves the read/write position, starting from the end of the file.• Specify offset in bytes. Specify a positive value in offset when moving the read/write position to the end of the file.• The read/write position obtained as a result of executing the FSEEK function is returned.
Related Item	FOPEN, FCLOSE, FPRINT, FWRITE, FINPUT

Example of Program

```
conf
  fopen  ``C:TEST``, 2 , 5
end conf
evnt
  AAA$ = ``12345``
  fwrite 5, AAA$, ``ABCD``
  fseek(5, 0, 0)
  finput 5, VSTR$
end evnt
```

FSUM

Function

Function	The FSUM function calculates the sum of the variable group in the specified field.
Format	FSUM (file-number)
Example of Use	SUM = FSUM (5)
Description	<ul style="list-style-type: none"> • The FSUM function calculates the sum (eight low-order bits) of the variable group included in the FIELD specified by file-number by incrementing the contents of the group for each byte. The function calculates the area where no character code is defined in the character string variable as 0. • The FSUM function returns the calculation result as an integer-type value within the range from 0 to 255. • If the FIELD specified by file-number does not exist, an error occurs.
Related Item	FOPEN, FIELD, FCLOSE, FPUT, FGET

Example of Program

```

conf
  field 5
    global no%
    global moji1$ , moji2$
  end field
  global sum%
  fopen ``MEMORY``, 2 , 5
  .....
end conf
evnt
  fget 5 , 3
  if sum% = FSUM(5) then
    numdsp ..NUM000 , no%
    strdsp ..STR000 , moji1$
    strdsp ..STR001 , moji2$
  else
    strdsp ..STR002 , ``SUM-error``
  fclose 5
end evnt

```

FUNCTION ... END FUNCTION

Statement

Function The FUNCTION ... END FUNCTION statement declares a function block.

Format FUNCTION function name [type declaration character](variable declaration[, variable declaration] ...)
 ...
 END FUNCTION

Example of Use FUNCTION ADD%(A%,B%)
 ADD%=A%+B%
 END FUNCTION

Description

- The FUNCTION ... END FUNCTION statement declares a function block where the function itself is defined.
- A defined function can be referenced in three ways as shown below according to the position where it is declared:
 - Local function: Defined in a program other than a global screen program.
 - Global function: Defined in a global screen program.
 - Library function: Defined in a library.
- The declared type of a function (in the prototype declaration) must be the same as the defined type of the function itself.
- Like a variable, a function has a return value of a type determined by the type declaration character (\$, % or !).
 A function with no type declaration character is a real number function.
- The return value of a function depends on a value substituted for the function name including the type declaration character.
- Variable declaration is an argument of a function.
 A variable with no argument declaring a variable type is regarded as a real number variable.
- An argument of a function is given when referenced. Therefore, if a value is changed by substituting it for an argument in the function or the like, the variable itself given as the argument by the caller is also changed.
- Type declaration using DECLARE is needed to call a function declared in a function block.
- To exit a function in a function block forcedly, use EXIT FUNCTION.
- This is one of the new features of Screen Creator 5.

Related Item DECLARE, EXIT FUNCTION, FUNCTIONCHECK

Example of Program

```
declare my_add%(a%,b%)
conf
  global x%,y%
  local sum%
  sum% = my_add(x%,y%)
end conf
FUNCTION my_add%(a%,b%)
  my_add%=a%+b%
END FUNCTION
```

FWRITE

Statement

Function	The FWRITE statement writes data to the specified file.
Format	FWRITE file-number, expression, expression, ...
Example of Use	FWRITE 12, 100, "ABCD", VAR%, STRING\$
Description	<ul style="list-style-type: none"> • The FWRITE statement writes the numeric value or character defined in expression to the file specified by file-number. • A numeric value, a character, or a numeric or character variable can be specified in expression. • When writing two or more expressions to the file, delimit them with a comma (.). Add the code indicating carriage return (CR) or line feed (LF) to the end of expression description. • A numeric expression is converted to a numeric string and written to the specified file. When the numeric string is negative, a minus sign (-) is inserted before it. • When writing a character string, enclose it in double quotation marks (""). • file-number must match the number of the file opened by the FOPEN statement.
Related Item	FOPEN, FCLOSE, FPUT, FPRINT

Example of Program

```

conf
  fopen  ``C:TEST``, 2 , 5
end conf
evnt
  var% = -2
  fwrite 5, 123, var%, ``ABCD``, ``XYZ``
end evnt

```

Data is written to the specified file as follows:

```
123,-2,``ABCD``,``XYZ`` CR/LF
```



GETBLIGHT

Statement

Function	The GETBLIGHT statement reads the time that lasts till the back light is turned off.
Format	GETBLIGHT variable-name
Example of Use	GETBLIGHT VAR
Description	variable-name specifies the variable used to write the time that lasts till the back light is turned off. The unit for the read values is minute. When 0 is specified, the back light is not turned off.
Related Item	SETBLIGHT

Example of Program

```
conf
  GETBLIGHT var
  var = var*2
  setblight var
end conf
```

GETDATE

Statement

- Function** The GETDATE statement obtains the data representing a date.
- Format** GETDATE year-read-variable, month-read-variable, day-read-variable, day-of-week-read-variable
- Example of Use** GETDATE YEAR%, MONTH%, DATE%, DAY%
- Description**
- The GETDATE statement writes the current date value to year-read-variable, month-read-variable, day-read-variable, and day-of-week-read-variable.
 - Year is the low-order two digits of A.D. Month is a numeric value from 1 to 12. Day is a numeric value from 1 to 31. The day of the week is a numeric value from 0 to 6 (Sunday to Saturday).
 - Read variables must be integer-type variables.
 - Once date is set using the SETDATE command in a model with a battery backup calendar IC (GC56LC or GC55EM), the date is updated even while the power is off. If a model with no calendar IC (GC53LC or GC53LM) is turned off, the date is initialized to January 1, 1998 (Thursday) and the time to 00:00:00 when it is turned on again. The date and time are updated while the power is on.
- Related Item** DATE\$, GETTIME, SETDATE, SETTIME, TIME\$

Example of Program

```
conf
  GETDATE yr%, mt%, d%, dd%
  numdsp ..NUM000, yr%
  numdsp ..NUM001, mt%
  numdsp ..NUM002, d%
end conf
```



GETGID

Function

Function	The GETGID function obtains the ID of the local screen currently being displayed.
Format	GETGID()
Example of Use	VAR@ = GETGID()
Description	<ul style="list-style-type: none">• The GETGID function obtains the ID of the local screen currently being displayed.• This function cannot be used to obtain the ID of a global screen.
Related Item	GETGNO

Example of Program

```
evnt
  input type%, id@, data%
  if type% = 3 then
    VAR@ = GETGID()
    NO% = GETGNO(VAR@)
    00~D100 = NO%
  end if
end evnt
```

GETGNO

Function

Function	The GETGNO function obtains the registration number of the screen currently being displayed.
Format	GETGNO (screen-ID)
Example of Use	NO = GETGNO (ID@)
Description	<ul style="list-style-type: none">• The GETGNO function obtains the registration number of the screen specified in screen-ID.• screen-ID specifies a screen name or an ID-type variable.
Related Item	GETGID

Example of Program

```
evnt
  input type%, id@, data%
  if type% = 3 then
    VAR@ = GETGID()
    NO% = GETGNO(VAR@)
    00~D100 = NO%
  end if
end evnt
```

GETID

Function

Function The GETID function obtains the value of the ID separate from the reference ID by offset.

Format GETID (object-indicated-by-reference-ID, offset-value)

Example of Use ID@ = GETID (VARID@, 10)

Description

- The GETID function obtains the ID-type value separate from the reference ID-type value by the specified offset value.
- **object-indicated-by-reference-ID** specifies an ID-type variable name, a screen name, a part name, a registration character string/graphic name, or a device name.
- **offset-value** is the integer or real value indicating the offset from the reference ID to the ID to be obtained. When 0 is specified in offset-value, the reference ID value is obtained.
- When 1 is specified in **offset-value**, the ID of the first element of a continuous-stage-type control is obtained.

Related Item GETOFFSET

Example of Program

```

conf
  cyclic 00~d0001 * 30
end conf
evnt
  input ty%,id@,dat%
  offset = getoffset(00~d0001,id@)
  ...
  Error processing corresponding to the offset value, etc.
  ...
  id@ = getid (00~d0001,offset)
  ....
end evnt

```

GETOFFSET

Function

Function	The GETOFFSET function calculates the offset between the reference ID and specified ID.
Format	GETOFFSET (reference-ID, ID-to-be-specified)
Example of Use	OFFSET% = GETOFFSET (00~D0001, ID@)
Description	<ul style="list-style-type: none"> • The GETOFFSET function calculates the offset indicating how long the specified ID is separate from the reference ID. • reference-ID specifies the ID-type variable, screen name, part name, registration character string/graphic name, or device name used as the reference offset. • ID-to-be-specified specifies the ID-type variable, screen name, part name, registration character string/graphic name, or device name used to calculate the offset. • When the GETOFFSET function applies to the device declared in CYCLIC2, the offset value is a multiple of 2.
Related Item	GETID

Example of Program

```

conf
  cyclic 00~d0001 * 30
end conf
evnt
  input ty%,id@,dat%
  offset = GETOFFSET(00~d0001,id@)
  ...
  Error processing corresponding to the offset value, etc.
  ...
  id@ = getid (00~d0001,offset)
  ....
end evnt

```

GETTIME

Statement

Function	The GETTIME statement obtains the data indicating time.
Format	GETTIME hour-read-variable, minute-read-variable, second-read-variable
Example of Use	GETTIME HOUR%, MIN%, SEC%
Description	<ul style="list-style-type: none">• The GETTIME statement writes the current value (time) to hour-read-variable, minute-read-variable, and second-read-variable.• Hour is a numeric value from 0 to 23. Minute is a numeric value from 0 to 59. Second is a numeric value from 0 to 59.• Read variables must be integer-type variables.• Once date is set using the SETDATE command in a model with a battery backup calendar IC (GC56LC or GC55EM), the date is updated even while the power is off. If a model with no calendar IC (GC53LC or GC53LM) is turned off, the date is initialized to January 1, 1998 (Thursday) and the time to 00:00:00 when it is turned on again. The date and time are updated while the power is on.
Related Item	DATE\$, GETDATE, SETDATE, SETTIME, TIME\$

Example of Program

```
conf
  GETTIME H%,M%,S%
  numdsp ..NUM000, H%
  numdsp ..NUM001, M%
  numdsp ..NUM002, S%
end conf
```

GLOBAL

Statement

Function	The GLOBAL statement declares that global variables are to be used.
Format	GLOBAL variable-name [, variable-name ...]
Example of Use	GLOBAL VAR, XYZ(2,3), MOJI\$ * 20
Description	<ul style="list-style-type: none">• The GLOBAL statement declares that global variables are to be used. Global variables can be read and written from all programs. Global variables must be declared before they are used in a program. These variables are initialized once when the power supply is turned on. The values of global variables used after the power supply has been turned on are retained.• A normal variable, an array variable, or a character string variable can be written in variable-name.• When an array or character variable is declared, the DIM and STRING statements need not be declared.• Use the DIM or STRING statement to specify a non-global array and a character string type.
Related Item	AUTO, BACKUP, DIM, LOCAL, STATIC, STRING

Example of Program

```
conf
  GLOBAL var%, float
  GLOBAL moji$ * 50
  GLOBAL xyz@(10,10)
end conf
```

GOSUB

Statement

Function	The GOSUB statement executes the specified subroutine.
Format	GOSUB subroutine-name
Example of Use	GOSUB SUB001
Description	<ul style="list-style-type: none">• Control is transferred to the subroutine specified after the GOSUB statement.• Subroutine names written in the global screen and those in the program containing the GOSUB statement can be specified. Use the RETURN statement to return control.• If the same name exists both in the global and local subroutines, the global subroutine is called.
Related Item	RETURN

Example of Program

```
evnt
  X = 10
  GOSUB SUB001
  numdsp ..NUM000, X
end evnt
SUB001:
  ab = X+3
  RETURN
```

GOTO

Statement

Function The GOTO statement unconditionally moves control to the specified line.

Format GOTO label-name

Example of Use GOTO LABEL1

Description The GOTO statement unconditionally moves control to the line specified by label-name. Execution is continued from the line to which control was moved.

Related Item None

Example of Program

```
evnt
  if a = 1 then goto L1
  a = 3
  L1: numdsp ..NUM000 , a
end evnt
```

HEX\$

Function

Function	The HEX\$ function converts a decimal character string to a hexadecimal character string.
Format	HEX\$ (numerical-expression)
Example of Use	HEX\$ (123)
Description	<ul style="list-style-type: none"> • The HEX\$ function converts a decimal character string to a hexadecimal character string. • When a floating-point type is specified in numerical-expression, the decimal character string (numeric value) is converted to an integer type, then converted to a hexadecimal character string. • Specify the decimal character string (numeric value) within the range from -2147483648 to 2147483647.
Related Item	OCT\$, VAL

Example of Program

```

evnt
  input type , id@ , data
  moji$ = HEX$(data)
  strdsp ..STR000, moji$
end evnt

```

IF ... THEN ... ELSE

Statement

Function Condition judgment is performed to select the next program to be executed.

Format IF conditional expression THEN statement [ELSE statement]
 IF conditional-expression THEN
 statement-list
 [ELSEIF conditional-expression THEN
 statement-list]
 [ELSE
 statement-list]
 END IF

Example of Use IF TYPE% = 1 THEN VALUE = 10

Description

- conditional-expression is the relational operation expression obtained when the operation result is true (other than 0) or false (0).
- When the operation result is true as a result of executing a conditional expression, the THEN and subsequent statements are executed. When the operation result is false, the ELSE and subsequent statements are executed.
- The ELSE, ELSEIF and subsequent statements can also be omitted.
- Up to 50 ELSEIF statements can be used in IF THEN...END IF.

Related Item None

Example of Program

```

evnt
  if a = 2 then x = 3
  if x = 5 then
    a = 1
  elseif x = 6 then
    a = 2
  else
    a = 3
  end if
end evnt

```



INIT ... END INIT

Statement

Function	The INIT ... END INIT statement declares an area of an initialization block.
Format	INIT END INIT
Example of Use	INIT static VAR\% END INIT
Description	<ul style="list-style-type: none"> • An initialization block written in a screen program or part program is executed first only once when the program including the block is executed. • Write processing which should be executed first only once such as initialization or the like.
Related Item	CONF END CONF, EVNT END EVNT

Example of Program

```
INIT
  global moji$
  moji$="initial value"
END INIT
```

INP

Function

Function	The INP function reads 2-byte data from the specified parallel I/O port.
Format	INP (port-number)
Example of Use	VAR = INP (0)
Description	<ul style="list-style-type: none">• The INP function reads data from the specified parallel I/O port.• The port-number to be specified depends on the option board inserted into the option bus. A numeric value from 0 to 3 can be specified in port-number.
Related Item	OUT

Example of Program

```
evnt
  var% = inp (0)
  if (var% and 1) = 1 then var% = 0
  OUT 0,var%
end evnt
```

INPBIT

Function

Function	The INPBIT function reads the specified BIT number from the specified input port.
Format	INPBIT (port-number, BIT-number)
Example of Use	DATA% = INPBIT (0,10)
Description	<ul style="list-style-type: none">• The INPBIT function reads the specified BIT number from the specified input port.• Specify port-number and BIT-number with an integer value relative to 0.• The lowest-order bit number of the parallel IO is 0 and the next lowest-order bit number is 1. That is, the BIT number is sequentially incremented.• If an unexisting port or BIT number is specified, 0 is returned.
Related Item	INP, OUT, OUTBIT, OUTBITSTAT, OUTSTAT

Example of Program

```
evnt
  data% = INPBIT(0,3)
  if data% = 0 then
    outbit 0,3,1
  endif
end evnt
```

INPUT

Statement

Function The INPUT statement reads the data transmitted to a screen or part into the specified variable(s).

Format INPUT variable-name [, variable-name]

Example of Use INPUT V1, ID@, DATA

Description

- The INPUT statement reads the data transmitted to a screen or part.
- The integer value indicating the type of the sender that transmitted data is set in the first variable-name. The value indicating the ID of the sender is set in the second variable-name, which is followed by data.

Sender	Type	ID	Contents of data
Screen	1	Optional	Item written in the PRINT statement
Part	2		Item written in the PRINT statement
Switch (single)	1		1 when ON, 0 when OFF
Switch (multi)			Switch number: 1 when ON, 0 when OFF
Selector switch			Number of activated switch
Timer	4		Value indicating the ON (1) or OFF (0) status
Alarm	5		Value indicating the ON (1) status
Parallel port	6		BIT number, BIT value, or channel number satisfying the condition
Non-procedural	7		The port number, status, and number of received bytes are set in this order.
Sampling	9	Control	Sampled data
PLC	16		Integer value indicating the device value
Bar code reader	18		Bar code value
Magnetic card	19		
Ten-key pad	20		Code of pressed key
Memory card	21		
Host	22		Optional data to be determined by the user

INPUT

--

bytes written to the reception buffer). For the text mode, a terminator code is also read. (When the status is 1 or -1, the number of received data is read.)

- The numbers of multi-switches and selector switches are counted as 1, 2, 3 and so forth from the upper left switch. When all switches are counted in the X direction, the switches on the lower Y line are counted in the same way. They are integers.

Related Item

PRINT, CYCLIC, OPENPARALLEL, OPENCOM, OPENSIO

Example of Program

```
conf
  global buffer$
  opensio 2 , 0, buffer$
  setsio 2, 10
end conf
evnt
  input type, id@, port%, status%, bytes%
  if type = 7 then
    moji$ = left(buffer$, bytes% - 1)
    strdsp ..STR000 , moji$
  end if
end evnt
```

INSTR

Function

Function	The INSTR function retrieves character strings to find the specified character string. When the specified character string is found, the function notifies the system of the start position of the character string.
Format	INSTR (start-position, character-strings-to-be-retrieved, character-string-to-be-found)
Example of Use	A = INSTR (10. MOJI1\$, MOJI2\$)
Description	<ul style="list-style-type: none"> • The INSTR function retrieves the character strings specified in character-strings-to-be-retrieved to find the character string specified in character-string-to-be-found. This retrieval starts at the start position specified in start-position. When the specified character string is found, the function notifies the system of the position in a number of bytes relative to the beginning of the character strings to be retrieved. If the specified character string is not found, 0 is set. • start-position is 1 when retrieval starts at the beginning of character strings. • Character string variables, direct character strings, registration character string names, and registration character string numbers can be specified in character-strings-to-be-retrieved.
Related Item	None

Example of Program

```

evnt
  a$ = "this is oip."
  p = instr (1, a$, "company")      ' When a character string variable is
specified
  p = instr (1, num,"ab")          ' When a registration character
string number
end evnt                             is specified

```

INT

Function

Function The INT function omits the fraction of the value specified in numerical-expression to create an integer.

Format INT (numerical-expression)

Example of Use A = INT (30.1)

Description

- The INT function omits the fraction of the numerical-expression enclosed in parentheses in the negative direction.
- The INT function calculates the maximum integer that does not exceed the value specified in numerical-expression when omitting the decimal point.
- When the value specified in numerical-expression is negative, the INT function omits the figures below the decimal point as follows:
INT (1.4) 1
INT (-1.4) -2

Related Item CINT

Example of Program

```
evnt
  input type%, id@, data
  intvar% = INT ( data )
  numdsp ..NUM000, intvar%
end evnt
```

INTERLOCK

Statement

Function	The INTERLOCK statement controls transition to the system mode screen.
Format	INTERLOCK mode
Example of Use	INTERLOCK 1
Description	<ul style="list-style-type: none"> • When mode is 1, the INTERLOCK statement sets the interlock to ON. When 0, the INTERLOCK statement sets the interlock to OFF. • When the interlock is ON, the system mode screen is not displayed even if two dots on a diagonal line are pressed. When power is ON, the system mode screen is not displayed even if the upper left edge on the screen is pressed. • When lock is activated, it must be reset by a program. Make a program so that it resets lock securely. • A mode specified using the INTERLOCK command in a model with a battery backup calendar IC (GC56LC or GC55EM) is maintained even while the power is off. A mode specified using the INTERLOCK command in a model with no calendar IC (GC53LC or GC53LM) is lost when the power is turned off. Therefore, a mode must be specified in a program which is always executed when the power is turned on.
Related Item	None

Example of Program

```

conf
  INTERCLOCK 1
end conf
evnt
  input tp%,id@,dat%
  if id@ = ..sw the interlock 0
  .....
end evnt

```

IOCTL

Statement

Function	The IOCTL statement controls the I/O device connected to the OIP.
Format	IOCTL I/O-type, mode
Example of Use	IOCTL 0, 0
Description	<ul style="list-style-type: none"> • Write the integer value indicating the I/O device to be controlled in I/O-type. Currently, the type of I/O device that can be controlled are the PLC, switch, and non-procedure transmission buffer. • mode is the integer value indicating how the I/O device is controlled. • When controlling the PLC, specify one of the following values indicating how the PLC is controlled in mode. The value used to determine the IO type is 0. <ul style="list-style-type: none"> 0: The PLC is write- and read-enabled. 1: The PLC is write-inhibited. <ul style="list-style-type: none"> – If write is executed when the PLC is write-inhibited, an error will occur. • Switches are controlled as follows: The value used to determine the IO type is &H60. <ul style="list-style-type: none"> – When switches are simultaneously pressed, the number of switches to be assumed ON can be controlled. – Specify the number of switches that can be simultaneously recognized in mode with a numeric value from 0 to 640. – Specifying 0 inhibits switch input. The switch cannot be used in this case. Thus, be sure to make a program in another way so that it resets prohibition of turning on the switch. – The number of switches specified using this command in a model with a battery backup calendar IC (GC56LC or GC55EM) is maintained even while the power is off. The number of switches specified using this command in a model with no calendar IC (GC53LC or GC53LM) is lost when the power is turned off. Therefore, the number of switches must be specified in a program which is always executed when the power is turned on. • A non-procedure type send buffer is cleared as shown below. The value for deciding the I/O type is &H41. <ul style="list-style-type: none"> - Specify a port (CH1 to CH3) for clearing the send buffer in "mode". Input a number between 1 and 3.
Related Item	IOSTAT

Example of Program

```
evnt
  input ty%,id@,dat%
  if id@ = ..sw1 and dat% = 1 then
    ioctl 0,0
  else
    ioctl 0,1
  endif
end evnt
```

IOCTL2

Statement

Function	The IOCTL2 statement controls PLC cyclic communication.
Format	IOCTL2 device-name, code, data
Example of Use	IOCTL2 00~D10, 0, 0
Description	<ul style="list-style-type: none">• Executing the IOCTL2 statement executes the cyclic communication specified by device-name. The cyclic communication to be specified by device-name must be declared in the CYCLIC or CYCLIC2 statement in advance.• Set 0 in code and data.
Related Item	None

Example of Program

```
conf
  cyclic 00~D10
end conf
evnt
  input ty%,id@,dat%
  if id@ = ..sw1 then
    00~D11 = 1
    ioctl2 00~D10 ,0 ,0
  endif
end evnt
```



IOSTAT

Function

Function	The IOSTAT function reads the status of the I/O device connected to the OIP.
Format	IOSTAT (I/O-type)
Example of Use	IOSTAT (0)
Description	<ul style="list-style-type: none"> • Write the integer value indicating the I/O device whose status is to be read in I/O-type. Currently, the type of I/O device that can be controlled are the PLC and switch. • To read the PLC status, specify 0 in I/O-type. <ul style="list-style-type: none"> 0: The PLC is write- and read-enabled. 1: The PLC is write-inhibited. • To read the switch status, specify &H60 in I/O-type. <ul style="list-style-type: none"> – The number of switches that can be recognized when they are pressed simultaneously is returned (0 to 640).
Related Item	IOCTL

Example of Program

```

evnt
  input ty%,id@,dat%
  if id@ = ..sw1 then
    if iostat(0) then
      ioctl 0,0
    else
      ioctl 0,1
    end if
  endif
end evnt

```

JUMP

Statement

Function	The JUMP statement displays the specified screen.
Format	JUMP screen-name
Example of Use	JUMP 10
Description	<ul style="list-style-type: none">• The JUMP statement displays the screen specified in screen-name.• screen-name is the name of the screen to be displayed or the ID-type variable indicating the screen to be displayed. Alternatively, screen-name specifies the screen number stored in screen registration.• When this statement is executed, the subsequently coded program is not executed.• If a non-existent screen is specified, a system error occurs.
Related Item	None

Example of Program

```
evnt
  input type , id@ , data
  if type = 3 and id@ = ..SWT000 then
    JUMP GAMEN..
  end if
end evnt
```

KILL

Statement

Function	The KILL statement deletes the specified file.
Format	KILL file-name
Example of Use	KILL "C:ABC.DOC"
Description	<ul style="list-style-type: none">• The KILL statement deletes the file specified by file-name.• A wild card (*) can be specified in file-name.

Related Item

Example of Program

```
conf
end conf

evnt
    .....
    KILL ``ABC.*''
    .....
end evnt
```

LAMPCOLOR

Statement

Function	The LAMPCOLOR statement changes the ON display color of the lamp display.
Format	LAMPCOLOR display-name, color-number
Example of Use	LAMPCOLOR .BUHIN.GRAPH, 5
Description	<p>The LAMPCOLOR statement changes the ON display color of the lamp display.</p> <ul style="list-style-type: none">• display-name is the name of lamp display or the ID-type variable indicating the lamp display.• color-number indicates the color displayed when the lamp display is ON. Specify this color number with a numeric value from 0 to 15.
Related Item	LAMPDSP

Example of Program

```
conf
  lampdsp .buhin.gpaph , 0
  LAMPCOLOR .buhin.gpaph , 7
  lampdsp .buhin.gpaph , 1
end conf
```

LAMPDSP

Statement

Function	The LAMPDSP statement indicates whether the lamp display is ON or OFF.
Format	LAMPDSP control-name, lamp-mode
Example of Use	LAMPDSP .BUHIN.GRAPH, 1
Description	<p>The LAMPDSP statement indicates whether the lamp display is ON or OFF.</p> <ul style="list-style-type: none">• control-name is the name of lamp display or the ID-type variable indicating the lamp display.• lamp-mode indicates whether the lamp display is ON or OFF. When lamp-mode is 0, the lamp display is OFF. When 1, the lamp display is ON.• display-value cannot be changed even if this statement is issued to the control for which operation parameters are set to “effective” in the control.
Related Item	LAMPCOLOR

Example of Program

```
evnt
  input type,id@,data
  var@ = .buhin.graph
  LAMPDSP var@ , data
end evnt
```

LEFT\$

Function

Function The LEFT\$ function returns a character string the specified number of characters, starting from the left of the specified character string.

Format LEFT\$ (character-string, number-of-characters)
 LEFT\$ (registered-character-string-number, number-of-characters)
 LEFT\$ (registered-character-string-name, number-of-characters)

Example of Use A\$ = LEFT\$ (MOJI\$, 5)
 A\$ = LEFT\$ (4, 10)
 A\$ = LEFT\$ (TOROKU, 8)

Description

- The LEFT\$ function returns a character string the number of bytes specified in `number-of-characters`, starting from the left of the specified character string.
- `number-of-characters` specifies the number of bytes of the character string to be fetched with a numeric value from 0 to 255. When `number-of-characters` is 0, a null character string is returned.
- `character-string` is a direct character string or a character string variable.
- `registered-character-string-number` is the numerical expression indicating the number registered by GCSGP3.
- `registered-character-string-name` is the name of the character string created by GCSGP3 or the ID-type variable indicating the name of the character string.

Related Item MID\$, RIGHT\$

Example of Program

```

evnt
  b$ = "12345678"
  a$ = LEFT$(b$ , 3)
  c$ = LEFT$ (no , 3)
  c$ = LEFT$ (id@ , 4)
end evnt

```

LEN

Function

Function The LEN function returns the length of the specified character string in a number of bytes.

Format LEN (character-string)
LEN (registered-character-string-number)
LEN (registered-character-string-name)

Example of Use A = LEN (B\$)
A = LEN (MOJI)

Description

- The LEN function returns the length of the character string specified by character-string, registered-character-string-number, or registered-character-string-name in a number of bytes.
- character-string is a direct character string or a character string variable.
- registered-character-string-number is the numerical expression indicating the number registered by GCSGP3.
- registered-character-string-name is the name of the character string created by GCSGP3 or the ID-type variable indicating the name of the character string.

Related Item None

Example of Program

```
conf
  a = len (b$)
  a = len ("abcdefg")
  a = len ( toroku )
  a = le (1)
end conf
```

LINE

Statement

Function	The LINE statement draws a straight line on a screen.
Format	LINE X1, Y1, X2, Y2
Example of Use	LINE 20,30,100,200
Description	<p>The LINE statement draws a straight line between the specified two coordinates ((X1,Y1) and (X2,Y2)).</p> <ul style="list-style-type: none">• X1 and X2 must be a numeric value from 0 to 639. Y1 and Y2 must be a numeric value from 0 to 399 (GC55EM) or 0 to 479 (GC56LC).• A straight line is directly displayed as the background of a screen. When a part is opened or closed in the area where a straight line was displayed or when a primitive is displayed, the straight line may be cleared. The cleared straight line is not redisplayed.• The type and color of the straight line are specified by COLOR.• If this is used in an initialization block or configuration block, drawing is executed after executing this block and accordingly lines are not drawn. Be sure to use this in an event block.

Related Item COLOR

Example of Program

```
conf
  color 1 , 0 , 3
end conf
evnt
....
  dot 100,200
  dot 100,300
  color 1 , 0 , 0
  line 100,200,100,300
....
end evnt
```



LINPUT

Statement

Function	The LINPUT statement reads data from the specified file.
Format	LINPUT file-number, character-string-variable
Example of Use	LINPUT 12, STRING\$
Description	<ul style="list-style-type: none"> • The LINPUT statement reads data from the file specified by file-number into the character string defined by character-string-variable. • The data between the current file position and carriage return (CR) or line feed (LF) is assigned to character-string-variable. (CR and LF, however, are not assigned.) • file-number must match the number of the file opened by the FOPEN statement.
Related Item	FOPEN, FCLOSE, FPRINT, FWRITE, FINPUT

Example of Program

```

conf
  fopen 'C:TEST', 2 , 5
end conf
evnt
  AAA$ = '12345'
  fwrite 5, AAA$, 'ABCD'
  fseek(5, 0, 0)
  linput 5, VSTR$
end evnt

```

The file is written as follows:

```
'12345', 'ABCD' CR/LF
```

When data is read, the variables change as follows:

```
VSTR$ '12345', 'ABCD'
```

LNECOLOR

Statement

Function The LNECOLOR statement changes the line colors and figure of the line chart display.

Format LNECOLOR control-name, line-number, line-type, line-color, tile, display-color, background-color

Example of Use LNECOLOR ..LNE000, 1, 2, 1, 4, 5, 2

Description

- The LNECOLOR statement changes the line colors and figure of the line chart display and the background tile and color of the entire display.
- **control-name** is the name of a line chart or the ID-type variable indicating the chart.
- **line-number** is the integer value indicating the number of the line to be changed. The line number starts at 1.
- **line-type** is the numeric value indicating the type of the line. Specify this line type with a numeric value from 0 to 3.
- **tile** indicates the tiling figure of the bar. Specify this tiling figure with a numeric value from 0 to 15.
- **display-color** is the numeric value indicating the color number of the tile display section. Specify this color number with a numeric value from 0 to 15.
- **background-color** is the numeric value indicating the color number of the tile background section. Specify this color number with a numeric value from 0 to 15.

Related Item LNECOLOR, LNECOLOR, LNECOLOR

Example of Program

```

conf
  static name@
  name@ = ..LNE000
end conf
evnt
  input type%, id@, data%
  if type% = 3 then
    LNECOLOR name@, 2, 3, 1, 4, 5, 2
  endif
end evnt

```

LNEDSP

Statement

Function	The LNEDSP statement displays data in the line chart display.
Format	LNEDSP control-name, line-number, point-number, display-data
Example of Use	LNEDSP .BUHIN.GRAPH, 2, 2, 30.0
Description	<ul style="list-style-type: none"> • The LNEDSP statement displays line data in the line chart display. • control-name is the name of a line chart or the ID-type variable indicating the chart. • line-number is the value indicating the line number in the line chart to be displayed. The line number starts at 1. • point-number specifies the data point to be changed in the line chart; it is the integer-type value starting at 1. The maximum point value depends on what line chart is placed. • display-value is the numeric data indicating the size of the specified line chart point. • display-value cannot be changed even if this statement is issued to the display for which operation parameters are set to “effective” in the control.
Related Item	LNECOLOR, LNESHIFT

Example of Program

```

conf
  static name@
  name@ = ..LNE000
end conf
evnt
  input type%, id@, data%
  lnedsp name@, 2, 2, data%
end evnt

```

LNESET

Statement

Function	The LNESET statement sets data in the line chart display.
Format	LNESET control-name, line-number, point-number, display-data
Example of Use	LNESET .BUHIN.GRAPH 2, 4, 30.0
Description	<ul style="list-style-type: none"> • The LNESET statement sets the data to be displayed in the line chart display. The speed of executing the PRDSP (display) statement after setting data in two or more points is faster than that of modifying all the line point values after executing the LNESET statement. • control-name is the name of the line chart display or the ID-type variable indicating the line chart display. • line-number specifies which line data is to be displayed when two or more lines are displayed in one line chart display. This line number is the integer value data starting at 1. • point-number specifies which point value on the specified line is to be changed. This point number is the integer value data starting at 1. • display-data is the numeric data indicating the size of the line chart.
Related item	LNEDSP, PRDSP

Example of Program

```

evnt
  lneset .buhin.graph , 3 , 8 , 20.1
  var@ = .buhin.graph
  no = 4
  value = 23
  point = 4
  LNESET var@ , no , point , value
  prdsp var@
end evnt

```

LNESHIFT

Statement

Function	The LNESHIFT statement shifts the display data of a line chart left or right.
Format	LNESHIFT (control-name, line-number, shift-direction, display-data)
Example of Use	A = LNESHIFT (..LNE000, 1, 1, 30)
Description	<ul style="list-style-type: none"> • The LNESHIFT statement is a function that shifts each of the points constituting the line chart in the line chart display left or right by one point and displays the points. • When this statement is executed, the values of the points purged from the line chart are returned as a result of the shifting. • control-name is the line chart name or the ID-type variable indicating the line chart. • line-number is the value indicating which line in the line chart display is to be shifted. This line number starts at 1. • When shift-direction is 1, line chart data is shifted left and above. When shift-direction is -1, line chart data is shifted right and below. • display-data indicates the data to be displayed in the vacant area produced as a result of the shifting.
Related Item	LNEDSP, LNECOLOR, LNESHIFT2

Example of Program

```

evnt
  input type%, id@, data%
  if data% > 0 then
    abc% = lneshift ( ..LNE000, 1, 1, 0)
  else
    abc% = lneshift ( ..LNE000, 1, -1, 100)
  endif
end evnt

```

LNESHIFT2

Statement

Function The LNESHIFT2 statement shifts the display data of a line chart left or right.

Format LNESHIFT2 (control-name, line-number, shift-direction, display-data)

Example of Use A = LNESHIFT2 (..LNE000, 1, 1, 30)

Description

- Different from the LNESHIFT statement, the LNESHIFT2 statement shifts line chart data but does not display it. To display line chart data, execute the PRDSP statement.
- The LNESHIFT2 statement is a function that shifts each of the points constituting the line chart in the line chart display left or right by one point.
- When this statement is executed, the values of the points purged from the line chart are returned as a result of the shifting.
- **control-name** is the line chart name or the ID-type variable indicating the line chart.
- **line-number** is the value indicating which line in the line chart display is to be shifted. This line number starts at 1.
- When **shift-direction** is 1, line chart data is shifted left and above. When shift-direction is -1, line chart data is shifted right and below.
- **display-data** indicates the data to be displayed in the vacant area produced as a result of the shifting.

Related Item LINEDSP, LNECOLOR, LNESHIFT, PRDSP

Example of Program

```

evnt
  input type%, id@ data%
  if data% > 0 then
    abc% = lneshift2 ( ..LNE000, 1, 1, 0)
  else
    abc% = lneshift2 ( ..LNE000, 1, -1, 100)
  endif
  prdsp ..LNE000
end evnt

```

LOCAL

Statement

Function	The LOCAL statement defines a local variable.
Format	LOCAL variable name [, variable name ...]
Example of Use	LOCAL VAR , XYZ(2,3) , MOJI\$ * 20
Description	<ul style="list-style-type: none">• The LOCAL statement defines a variable defined in "variable name" as a local variable.• A local variable can be read and written only in a program where it is declared. The compiler gives a warning if an undefined local variable is used. Each local variable is initialized every time the block is executed.• A variable name can be specified in a normal variable, arrangement variable or character string variable.• DIM declaration or STRING declaration is not needed to declare an arrangement variable or character variable.• The LOCAL statement is one of the new features of Screen Creator 5 added for distinctive declaration of local variables.• DIM can substitute for LOCAL. However, use LOCAL as far as possible in Screen Creator 5.• STRING can be used, instead of LOCAL, to specify a size of a character string variable. However, use LOCAL as far as possible in Screen Creator 5.
Related Item	AUTO,BACKUP,DIM,FUNCTION,GLOBAL,STATIC,STRING

Example of Program

```
conf
  global float(5)
  LOCAL i%
  for i% = 0 to 5
    float(i%) = i%*3
  next
end conf
```

LOCALCHECK

Statement

Function	The LOCALCHECK statement controls the level of warning messages output by the compiler.
Format	LOCALCHECK warning level
Example of Use	LOCALCHECK 1
Description	<ul style="list-style-type: none">• The LOCALCHECK statement specifies whether or not to output a warning if local and global variables, functions and/or subroutines are used vaguely in a program.• Two warning levels are available as shown below:<ul style="list-style-type: none">1: A warning is output.0: No warning is output.• Three types of warnings are available as shown below:<ol style="list-style-type: none">(1) If a variable not declared is used in a program In this case, the compiler regards such a variable as a local variable. It regards such a variable as a global variable in a global screen program.(2) If global and local variable names or subroutine names are duplicate In this case, such variables or subroutines are regarded as global variables or subroutines.(3) If two or more global, local and/or library function names are duplicate In this case, the priority is given to a library function, if any. If no library functions are used, the functions are regarded as global functions.• The warning level is set to 0 unless the LOCALCHECK statement is written.• The warning level is changed from the position where the LOCALCHECK statement is written in the program.• The LOCALCHECK statement is one of the new features of Screen Creator 5.
Related Item	BACKUP,DECLARE,DIM,FUNCTION,GLOBAL,LOCAL



Example of Program

```
conf
  local newvar3$
  newvar1$ = "no warning"
  LOCALCHECK 1
  newvar2$ = "warning is given!"
  newvar3$ = "no warning"
end conf
```

LOF

Function

Function	The LOF function calculates the size of the specified file.
Format	LOF (file-number)
Example of Use	AAA = LOF (file-number)
Description	<ul style="list-style-type: none"> file-number specifies the number of the file whose size is to be calculated. This file number must match the number of the file opened by the FOPEN statement. The size of the specified file is calculated in bytes.
Related Item	FOPEN, FIELD, FCLOSE, FPUT, FGET, EOF

Example of Program

```

conf
  field 5
    global no%
    global moji1$ , moji2$
  end field
  global sum%
  fopen ``MEMORY``, 2 , 5
  .....
end conf
evnt
  no% = 1
  moji1$ = ``product-name``
  moji2$ = ``product-number``
  fput 5 , 3
  if LOF(5) > 100 then
    fclose 5
  end if
end evnt

```

--

LOG

Function

Function The LOG function calculates the natural logarithm specified in numerical-expression.

Format LOG (numerical-expression)

Example of Use A = LOG (B*C)

Description • numerical-expression must be a numeric value greater than 0.

Related Item EXP

Example of Program

```
conf
  la = log ( 10 )
  lb = log ( a * b )
end conf
```

MCPY

Statement

Function	The MCPY statement copies the contents of a field to a character string variable.
Format	1:MCPY file-number, character-string-variable 2:MCPY character-string-variable, file-number
Example of Use	MCPY 5, moji\$
Description	<ul style="list-style-type: none"> • The MCPY statement copies the contents of the variable group in a field to a character string variable or the contents of a character string variable to the variable group in a field. That is, the MCPY statement in the first example (1:MCPY) copies the contents of the character string variable to the variable group in the field specified by file-number. The MCPY statement in the second example (2:MCPY) copies the contents of the variable group in the specified field to the character string variable. • file-number specifies the file number defined in the FIELD declaration. • When the contents of the variable group or character string variable are copied, the size is used, whichever is smaller.
Related Item	FOPEN, FIELD, FCLOSE, FPUT, FGET, EOF, SOF

Example of Program

```

conf
  field 5
    global no%
    global moji1$ , moji2$
  end field
  global buff$ * 50
  opensio 1 , 0 , buff$
  fopen ``MEMORY``, 2 , 5
end conf
evnt
  no% = 1
  moji1$ = ``product-name``
  moji2$ = ``product-number``
  size% = sof(5)
  MCPY 5 , buff$
  writesiob 1 , size% , buff$
end evnt

```

MEDIACHK

Function

Function	The MEDIACHK function checks whether a medium exists in the drive and returns the check result.
Format	MEDIACHK (drive name)
Example of Use	STATUS\% = MEDIACHK("E:")
Description	<ul style="list-style-type: none"> The return value is as shown below: <ul style="list-style-type: none"> 0: No medium 1: Medium exists.
Related Item	MEDIASIZE

Example of Program

```

conf
    global dname$(13)
    global dsel%
    strdsp ..str, "mediachk"
end conf
evnt
    input type%, id@, data%
    if data% = 1 then
        strdsp .dsp.str, dname$(dsel%)
        num% = mediachk(dname$(dsel%))
        if num% = 1 then
            strdsp ..str, "valid"
        else
            strdsp ..str, "invalid"
        end if
    end if
end evnt

```

MEDIASIZE

Function

Function	The MEDIASIZE function checks the size of a medium in the drive and returns the number of bytes.
Format	MEDIASIZE (drive name, calculation method)
Example of Use	SIZE% = MEDIASIZE("E:", 0)
Description	<ul style="list-style-type: none"> The calculation method is as shown below: <ul style="list-style-type: none"> 0: Full space 1: Free space <p>When the full space is specified, the medium size is calculated from the number of all clusters.</p> <p>When the free space is specified, free clusters are checked and the medium size is calculated from the total number of free clusters.</p>
Related Item	MEDIACHK

Example of Program

```

conf
  global dname$(13)
  global dsel%
  static mode%
  mode% = 0
  strdsp ..str, "mediasize"
  numdsp ..num001, mode%
end conf
evnt
  input type%, id@, data%
  if data% = 1 then
    if mode% = 1 then
      mode% = 0
    else
      mode% = 1
    end if
    numdsp ..num001,mode%
    strdsp .dsp.str, dname$(dsel%)
    num% = mediasize(dname$(dsel%),mode%)
    numdsp ..num000,num%
  end if
end evnt

```

MID\$

Statement

Function	The MID\$ statement replaces part of a character string with another character string.
Format	MID\$ (character-string-variable, start-position, number-of-characters) = replacing-character-string
Example of Use	MID\$ (x\$, 1, 1) = "A"
Description	<ul style="list-style-type: none">• The MID\$ statement replaces the character string specified in character-string-variable with the character string specified in replacing-character-string the specified number-of-characters (bytes), starting from the specified start-position.• If the specified number-of-characters is greater than the specified character-string-variable, the character string is replaced only by the size of the variable. For this reason, the size of the character string variable remains unchanged even if the character string is replaced.• The start position of the character string to be replaced starts at 1.• When number-of-characters is negative and start-position is 0 or negative, an error occurs.
Related Item	LEFT\$, RIGHT\$, MID\$

Example of Program

```
conf
  static moji$
  moji$ = "ABCDEFGH"
end conf
evnt
  input type, id@, data$
  mid$(moji$, 4, 3) = data$
end evnt
```

MID\$

Function

Function The MID\$ function returns a character string the specified number of characters.

Format MID\$ (character-string, start-position, number-of-character)
 MID\$
 (registered-character-string-number, start-position, number-of-characters)
 MID\$
 (registered-character-string-name, start-position, number-of-characters)

Example of Use A\$ = MID\$ (X\$, 2, 3)
 A\$ = MID\$ (10, 2, 3)
 A\$ = MID\$ (NAME, 2, 3)

Description

- The MID\$ function fetches the specified number-of-characters (bytes) from the specified character-string, starting from the position specified in start-position.
- character-string is a direct character string or a character string variable.
- registered-character-string-number is the numerical expression indicating the number registered by GCSGP3.
- registered-character-string-name is the name of the character string created by GCSGP3 or the ID-type variable indicating the name of the character string.
- When number-of-characters is 0 or when start-position is greater than the number of bytes of the specified character string, a null character string is returned.

Related Item LEFT\$, RIGHT\$

Example of Program

```

evnt
  input type,id@,data$
  a$ = mid$(data$ , 3 , 3)
  strdsp ..STR000,a$
end evnt

```

MKB

Statement

Function	The MKB statement stores data in any position of a character string variable.
Format	MKB character-string-variable-name, storage-position, integer-value
Example of Use	MKB MOJI\$, 5, VAR
Description	<ul style="list-style-type: none"> • The MKB statement stores one low-order byte of integer-value in the position specified by storage-position, starting from the beginning of the specified character-string-variable-name. • storage-position must be a integer- or floating-point-type variable or constant. 1 specifies the beginning of the character string variable. • integer-value specifies an overwriting value; it must be an integer- or floating-point-type variable or constant. When specified in integer-value, a floating-point-type variable or constant is converted to an integer. One low-order byte of this value overwrites the specified character-string-variable-name.
Related Item	MKS, MKW, MKI, MKF, MKID, CVB, CVW, CVI, CVF, CVID

Example of Program

```

conf
end conf
evnt
    org$ = ``1234567``
    strdsp ..STR000, org$
    MKB org$, 2, &H39
    strdsp ..STR001, org$
end evnt

```

MKDIR

Statement

Function	The MKDIR statement creates a directory.
Format	MKDIR directory-name
Example of Use	MKDIR "TEST"
Description	<ul style="list-style-type: none">• The MKDIR statement is an instruction for creating a subdirectory.• Specify the directory to be created with a character string constant or variable.• The directory to be created can be specified in directory-name together with a drive name.
Related Item	RMDIR, CHDIR, DIR

Example of Program

```
conf
end conf
evnt
    .....
    MKDIR ``C:TEST``
    .....
end evnt
```

MKF

Statement

Function	The MKF statement stores data in any position of a character string variable.
Format	MKF character-string-variable-name, storage-position, real-value
Example of Use	MKF MOJI\$, 5, VAR
Description	<ul style="list-style-type: none"> • The MKF statement stores four bytes of real-value in the position specified by <code>storage-position</code>, starting from the beginning of the specified <code>character-string-variable-name</code>. • <code>storage-position</code> must be an integer- or floating-point-type variable or constant. 1 specifies the beginning of the character string variable. • <code>real-value</code> specifies an overwriting value; it must be an integer- or floating-point-type variable or constant. When specified in <code>real-value</code>, an integer-type variable or constant is converted to a real number. This value overwrites the specified <code>character-string-variable-name</code>. • The value is converted into a 86 series boundary and saved.
Related Item	MKS, MKB, MKW, MKI, MKID, CVB, CVW, CVI, CVF, CVID

Example of Program

```

conf
end conf
evnt
  org$ = ``1234567``
  strdsp ..STR000, org$
  MKF org$, 2, 1.23
  strdsp ..STR001, org$
end evnt

```

' The character string will not be displayed
' correctly.

MKI

Statement

Function	The MKI statement stores data in any position of a character string variable.
Format	MKI character-string-variable-name, storage-position, integer-value
Example of Use	MKI MOJIS, 5, VAR
Description	<ul style="list-style-type: none"> • The MKI statement stores four bytes of integer-value in the position specified by storage-position, starting from the beginning of the specified character-string-variable-name. • storage-position must be a integer- or floating-point-type variable or constant. 1 specifies the beginning of the character string variable. • integer-value specifies an overwriting value; it must be an integer- or floating-point-type variable or constant. When specified in integer-value, a floating-point-type variable or constant is converted to an integer. This value overwrites the specified character-string-variable-name. • The value is converted into a 86 series boundary and saved.
Related Item	MKS, MKB, MKW, MKF, MKID, CVB, CVW, CVI, CVF, CVID

Example of Program

```

conf
end conf
evnt
  org$ = ``1234567``
  strdsp ..STR000, org$
  MKI org$, 2, &H39404142
  strdsp ..STR001, org$
end evnt

```

MKID

Statement

Function	The MKID statement stores data in any position of a character string variable.
Format	MKID character-string-variable-name, storage-position, ID-value
Example of Use	MKID MOJIS, 5, VAR
Description	<ul style="list-style-type: none"> • The MKID statement stores six bytes of ID-value in the position specified by storage-position, starting from the beginning of the specified character-string-variable-name. • storage-position must be a integer- or floating-point-type variable or constant. 1 specifies the beginning of the character string variable. • ID-value specifies an overwriting value; it must be an ID-type variable or constant. If an integer or constant of non-ID type is specified, an error occurs. This value overwrites the specified character-string-variable-name. • The value is converted into a 86 series boundary (by 2 bytes) and then saved.
Related Item	MKS, MKB, MKW, MKI, MKF, CVB, CVW, CVI, CVF, CVID

Example of Program

```

conf

end conf
evnt
    input type%, id@, data%
    org$ = ``1234567``
    strdsp ..STR000, org$
    MKF org$, 2, id@
    strdsp ..STR001, org$
end evnt

```

' The character string will not be displayed
' correctly.

MKS

Statement

Function	The MKS statement stores data in any position of a character string variable.
Format	MKS character-string-variable-name, storage-position, character-string
Example of Use	MKS MOJIS, 5, "ABCD"
Description	<ul style="list-style-type: none">• The MKS statement stores a character string (<code>character-string</code>) in the position specified by <code>storage-position</code>, starting from the beginning of the specified <code>character-string-variable-name</code>.• <code>storage-position</code> must be a integer- or floating-point-type variable or constant. 1 specifies the beginning of the character string variable.• <code>character-string</code> specifies an overwriting character string; it must be a variable or constant.
Related Item	MKB, MKW, MKI, MKF, MKID, CVB, CVW, CVI, CVF, CVID

Example of Program

```
conf
end conf
evnt
  org$ = ``1234567''
  strdsp ..STR000, org$
  MKS org$, 2, ``76543''
  strdsp ..STR001, org$
end evnt
```

MKW

Statement

Function	The MKW statement stores data in any position of a character string variable.
Format	MKW character-string-variable-name, storage-position, integer-value
Example of Use	MKW MOJI\$, 5, VAR
Description	<ul style="list-style-type: none"> • The MKW statement stores two bytes of integer-value in the position specified by storage-position, starting from the beginning of the specified character-string-variable-name. • storage-position must be an integer- or floating-point-type variable or constant. 1 specifies the beginning of the character string variable. • integer-value specifies an overwriting value; it must be an integer- or floating-point-type variable or constant. When specified in integer-value, a floating-point-type variable or constant is converted to an integer. The two low-order bytes of this value overwrites the specified character-string-variable- name. • The value is converted into a 86 series boundary and saved.
Related Item	MKS, MKB, MKI, MKF, MKID, CVB, CVW, CVI, CVF, CVID

Example of Program

```

conf

end conf
evnt
    org$ = ``1234567``
    strdsp ..STR000, org$
    MKW org$, 2, &H3940
    strdsp ..STR001, org$
end evnt

```

MOVE

Statement

Function	The MOVE statement moves the specified part.
Format	MOVE part-name, X-direction-move-quantity, Y-direction-move-quantity, move-method
Example of Use	MOVE .BUHIN., 100, 20, 0
Description	<ul style="list-style-type: none"> part-name is the name of the part to be moved or the ID-type variable indicating the part to be moved. X-direction-move-quantity and Y-direction-move-quantity are the values indicating the distance in which the part is moved. When the upper left end on the display screen is (0,0), the coordinates in the right direction are X coordinates and those in the downward direction are Y coordinates. The move unit is specified in dots. X must be a numeric value from 0 to 639. Y must be a numeric value from 0 to 399 (GC55EM) or 0 to 479 (GC56LC). For absolute move, move-method is 0. For relative move, move-method is 1. Absolute move is referenced to the upper left end on the display screen. Relative move is referenced to the position of the current part.
Related Item	None

Example of Program

```

evnt
  input type,id@,data
  if type = 3 then
    buhin@ = .buhin2.
    MOVE buhin@ , 10 , 10 , 0
  endif
end evnt

```

MTRCOLOR

Statement

Function	The MTRCOLOR statement changes the needle color of the meter display.
Format	MTRCOLOR display-name, color-number
Example of Use	MTRCOLOR ..MTR000, 1
Description	<ul style="list-style-type: none">• The MTRCOLOR statement changes the needle color of the meter display.• control-name is the meter display name or the ID-type variable indicating the meter display.• color-number is the number indicating the needle color. Specify this color number with a numeric value from 0 to 15.
Related Item	MTRDSP

Example of Program

```
evnt
  input type%, id@, mcolor%
  MTRCOLOR ..MTR000, mcolor%
end evnt
```

MTRDSP

Statement

Function	The MTRDSP statement displays data in the meter display.
Format	MTRDSP control-name, display-data
Example of Use	MTRDSP .BUHIN.GRAPH, 30.0
Description	<ul style="list-style-type: none">• The MTRDSP statement displays data (value) in the meter display.• control-name is the meter display name or the ID-type variable indicating the meter display.• display-data is the numeric data to be displayed in the meter display.• display-value cannot be changed even if this statement is issued to the display for which operation parameters are set to “effective” in the primitive.
Related Item	MTRCOLOR

Example of Program

```
conf
  static name@
  name@ = ..MTR000
end conf
evnt
  input type%, id@, data%
  MTRDSP name@, data%
end evnt
```



NUMCOLOR

Statement

Function	The NUMCOLOR statement changes the colors and background figure of the numeric display.
Format	NUMCOLOR control-name, numeric-value-display-color, tile, display-color, background-color
Example of Use	NUMCOLOR ..GRAPH, 1, 2, 5, 2
Description	<ul style="list-style-type: none"> • The NUMCOLOR statement changes the display and background colors and tile in the numeric display. -1 indicates that the color and tile for which -1 was specified remain unchanged. • control-name is the numeric display name or the ID-type variable indicating the numeric display. • numeric-value-display-color is the numeric value indicating the color number of the numeric value display section. Specify this color number with a numeric value from 0 to 15. • tile indicates the tiling figure. Specify this tiling figure with a numeric value from 0 to 15. • display-color is the numeric value indicating the color number of the tile display section. Specify this color number with a numeric value from 0 to 15. • background-color is the numeric value indicating the color number of the tile background section. Specify this color number with a numeric value from 0 to 15.
Related Item	NUMDSP, NUMFORM

Example of Program

```

conf
  static name@
  name@ = ..NUM000
end conf
evnt
  input type%, id@, data%
  if type% = 3 then
    NUMCOLOR name@, 2, -1,-1,-1
  endif
end evnt

```

NUMDSP

Statement

Function	The NUMDSP statement displays data in the numeric display.
Format	NUMDSP control-name, display-data
Example of Use	NUMDSP .BUHIN.GRAPH, 30.0
Description	<ul style="list-style-type: none"> • The NUMDSP statement displays data (value) in the numeric display. • control-name is the numeric display name or the ID-type variable indicating the numeric display. • display-data is the numeric data to be displayed in the numeric display. • Specifying a primitive name in display-name when the numeric display is of continuous stage type enables the same data to be displayed for all the elements. When setting a value for each element, use the <i>GETID</i> function to obtain the control ID and specify this ID in control-name. • display-value cannot be changed even if this statement is issued to the display for which operation parameters are set to “effective” in the control.
Related Item	NUMCOLOR, NUMFORM

Example of Program

```

conf
  static name@
  name@ = ..NUM000
end conf
evnt
  input type%, id%, data%
  NUMDSP name@, data%
end evnt

```

NUMFORM

Statement

Function	The NUMFORM statement changes the display format of the numeric display.
Format	NUMFORM control-name, display-method, decimal-point-position
Example of Use	NUMFORM ..HYOJIKI, 0, 0
Description	<ul style="list-style-type: none"> • The NUMFORM statement changes the display method of the numeric display. This statement can also specify a display method and a decimal-point display position. • control-name is the numeric display name or the ID-type variable indicating the numeric display. • display-method is the numeric value indicating any of the following seven display methods: <ul style="list-style-type: none"> 0: Floating-point display method 1: Integer display method 2: Fixed-point display method 3: Binary fixed-point representation 4: Binary representation 5: Octal representation 6: Hexadecimal representation • decimal-point-position specifies where the decimal point is displayed when display-method is 2 (fixed-point display method). To display the decimal point in the first position from the right, specify 1. To display it in the second position from the right, specify 2. • Binary fixed-point representation is the method for writing a decimal point in the specified integer data position. • Be sure to execute the NUMDSP statement after executing this statement. Otherwise, display may be disordered.

Related Item NUMCOLOR, NUMDSP

Example of Program

```

evnt
  input type , id@,data
  var@ = .buhin.gamen
  NUMFORM var@ , data , 2
  numdsp var@ , 30.1
end evnt

```

OCT\$

Function

Function	The OCT\$ function converts a decimal character string to an octal character string.
Format	OCT\$ (numerical-expression)
Example of Use	OCT\$ (134)
Description	<ul style="list-style-type: none">• The OCT\$ function converts a decimal character string to an octal character string.• When a floating-point type is specified in numerical-expression, the decimal character string (numeric value) is converted to an integer type, then converted to an octal character string.• Specify the decimal character string (numeric value) within the range from -2147483648 to 2147483647.
Related Item	HEX\$, VAL

Example of Program

```
evnt
  input type , id@ , data
  moji$ = OCT$(data)
  strdsp ..STR000, moji$
end evnt
```



ONFERR

Statement

Function	The ONFERR statement specifies the destination to which error messages are to be transmitted.
Format	ONFERR destination
Example of Use	ONFERR .B000.
Description	<ul style="list-style-type: none"> • The ONFERR statement specifies the destination to which file operation function error messages are to be transmitted. • destination is a screen or part name or the ID-type variable indicating the screen or part name. • When data is received by INPUT, the screen or part to which a file operation function error message was transmitted can receive information such as a type (8) and data (error number).
Related Item	FOPEN, FCLOSE, FPRINT, FWRITE, FINPUT

Example of Program

```

conf
  ONFERR ..
end conf
evnt
  input ty%, id@, dat1%
  .....
end evnt

```

When an error occurs, 8 is set in ty% and an error code (number) is set in dat1%.

OPEN

Statement

Function	The OPEN statement opens (displays) the specified part.
Format	OPEN part-name, mode
Example of Use	OPEN .BUHIN., 1
Description	<ul style="list-style-type: none">• The OPEN statement opens (displays) the closed part on the screen.• part-name is the name of the part to be opened or the variable indicating the ID of the part to be opened.• mode specifies whether to execute the configuration block of the program attached to the part when the part is opened.<ul style="list-style-type: none">0: The configuration block is not executed.1: The configuration block is executed.
Related Item	CLOSE

Example of Program

```
evnt
  input type% , id@ , data%
  if pstat(.BUHIN.) = 3 then
    OPEN .BUHIN., 0
  endif
end evnt
```

OPENCOM

Statement

Function	The OPENCOM statement declares that the program receives data from a serial line.
Format	OPENCOM logical-device-name
Example of Use	OPENCOM HST
Description	<ul style="list-style-type: none"> The OPENCOM statement declares that the program receives data from the specified external connecting device. (When the host computer transmits data, this statement need not be declared.) logical-device-name specifies any of the following external connecting devices: <ul style="list-style-type: none"> HST: Host computer BCR: Bar code reader TKY: Ten-key pad
Related Item	CLOSE COM, REOPENCOM

Example of Program

```

conf
  OPENCOM HST
end conf
evnt
  input type% , id@ , data%
  if type% = 3 and data% = 1 then
    CLOSECOM HST
  else if type% = 3 and data% = 0 then
    REOPENCOM HST
  endif
end evnt

```

OPENPARALLEL

Statement

Function	The OPENPARALLEL statement declares that the program receives data from a parallel port.
Format	OPENPARALLEL input-bit, mode
Example of Use	OPENPARALLEL 3, 1
Description	<ul style="list-style-type: none"> • The OPENPARALLEL statement declares that the program receives data when the bit for specifying a parallel input port changes. • input-bit indicates the bit used to transmit data when the value changes. Specify this input bit with a numeric value from 0 to 15. • mode specifies the time when data is transmitted. The time when data is transmitted depends on how the bit changes. <ol style="list-style-type: none"> 1: Data is transmitted when the bit goes High. 2: Data is transmitted when the bit goes Low. 3: Data is transmitted when the bit goes High or Low.
Related Item	CLOSEPARALLEL, REOPENPARALLEL

Example of Program

```

conf
  OPENPARALLEL 3
end conf
evnt
  input type% , id@ , data%
  if type% = 3 and data% = 1 then
    CLOSEPARALLEL 3
  else if type% = 3 and data% = 0 then
    REOPENPARALLEL 3
  endif
end evnt

```

OPENSIO

Statement

Function	The OPENSIO statement opens a non-protocol communication port.
Format	OPENSIO port-number, mode, reception-buffer
Example of Use	OPENSIO 1, 1, moji\$
Description	<ul style="list-style-type: none"> • The OPENSIO statement opens a port for starting non-procedural communication. • port-number specifies a channel that performs non-procedural communication. CH1 to CH3 correspond to 1 to 3, respectively. • mode specifies the type of non-procedural communication. Specify 0 (binary mode) or 1 (text mode). • reception-buffer specifies the name of the variable to which the data to be received from an external device is to be written. The variable to be specified must be a global or static character string variable. • When the condition is satisfied after data has been received from a connecting device, a reception completion message is issued to the part or screen that executed this statement. Two or more parts cannot execute the OPENSIO statement for the same port. <p>Binary mode: In the binary mode, all codes from 0 to 0FFh can be transmitted and received. In this mode, read and write are also enabled by specifying the length of received data.</p> <p>Text mode: In the text mode, codes from 1 to 0FFh can be transmitted and received. In this mode, the end codes of texts are also set and used. The end codes are used to judge the data to be received.</p>
Related Item	CLOSESIO, SETSIO, WRITESIO, WRITWSIOB, FLUSH, IOCTL

Example of Program

```

conf
    global buf$ * 200
    OPENSIO 2 , 1 , buf$
    setsio 2 , &HD
end conf
evnt
    strdsp ..STR000 , buf$
    closesio 2
end evnt

```

OPENTIM

Function

Function	The OPENTIM function allocates timer resources.
Format	OPENTIM ()
Example of Use	VAR@ = OPENTIM ()
Description	<ul style="list-style-type: none"> • The OPENTIM function allocates the resources necessary to use a timer. • The OPENTIM function must be an ID-type variable because it returns the ID of the timer to be used. • The allocated ID can be used to set the timer. • The system can use up to 16 timers. The timers not to be used must be returned to the system. (See “CLOSETIM.”) • The OPENTIM function can be used by the screen or part program being displayed. (If this function is executed on an undisplayed rear screen, an error occurs.) • The allocated timer is not deallocated even if one screen changes to another. If the timer is being used by the event type, a message is also issued to the rear screen.
Related Item	CLOSETIM, STARTTIM, STOPTIM, CONTTIM, WRITETIM, READTIM

Example of Program

```

conf
  static timid@
  timid@ = OPENTIM()
  settim timid@, 20, 0
  starttim timid@
end conf
evnt
  input type% , id@ , data%
  if type% = 3 and id@ = ..SWT000 then
    stoptim timid@
  else if id@ = ..SWT001 then
    closetim timid@
  end if
end evnt

```

OPENTIM2

Function

Function	The OPENTIM2 function allocates (opens) the timer to be used.
Format	RET = OPENTIM2 (timer-number)
Example of Use	RET = OPENTIM2 (14)
Description	<ul style="list-style-type: none"> • The OPENTIM2 function opens the timer specified in timer-number. • timer-number specifies the number of the timer to be used. Specify this timer number with an integer-type value from 0 to 15. • When the OPENTIM2 function is executed, any of the following value is returned: <ul style="list-style-type: none"> 0: The timer could be opened. 1: The timer could not be opened. • The OPENTIM2 function can be used by the screen or part program being displayed. (If this function is executed on an undisplayed rear screen, an error occurs.) • The allocated timer is not deallocated even if one screen changes to another. If the timer is being used by the event type, a message is also issued to the rear screen.
Related Item	CLOSETIM, STARTTIM, STOPTIM, CONTTIM, SETTIM, READTIM, OPENTIM

Example of Program

```

conf
  static timid@
  ret=OPENTIM2(5)
  setim 5, 20, 0
  starttim 5
end conf
evnt
  input type% , id@ , data%
  if type% = 3 and id@ = ..SWT000 then
    stoptim 5
  else if id@ = ..SWT001 then
    closetim 5
  end if
end evnt

```

OPENTIM3

Function

Function	The OPENTIM3 function allocates (opens) the timer to be used.
Format	RET = OPENTIM3 (timer-number)
Example of Use	RET = OPENTIM3 (14)
Description	<ul style="list-style-type: none">• The OPENTIM3 function opens the timer specified in timer-number.• timer-number specifies the number of the timer to be used. Specify this timer number with an integer-type value from 0 to 15.• When the OPENTIM2 function is executed, any of the following value is returned:<ul style="list-style-type: none">0: The timer could be opened.1: The timer could not be opened.• When the screen for which “open” was declared changes to another, the opened timer is automatically closed.• The OPENTIM3 function can be used by the screen or part program being displayed. (If this function is executed on an undisplayed rear screen, an error occurs.)
Related Item	CLOSETIM, STARTTIM, STOPTIM, CONTTIM, SETTAM, READTIM, OPENTIM

Example of Program

```
conf
  ret = opentim3 (3)
  settim 3 , 20, 1
  stoptim 3
  closetim 3
end conf
```

OUT

Statement

Function	The OUT statement writes 2-byte data to an I/O port.
Format	OUT port-number, output-data
Example of Use	OUT 0, &H20
Description	<ul style="list-style-type: none">• Currently, data can be written only to parallel I/O ports.• port-number specifies the number of the I/O port inserted into the option bus. (For the color/plasma, this port number is fixed at 0.)
Related Item	INP

Example of Program

```
evnt
  input type,id@,data
  out 0, data
end evnt
```

OUTBIT

Statement

Function	The OUTBIT statement rewrites the specified BIT number of the specified output port.
Format	OUTBIT port-number, BIT-number, write-data
Example of Use	OUTBIT 0, 10, 1
Description	<ul style="list-style-type: none">• The OUTBIT statement rewrites the specified BIT number of the specified output port.• Specify port-number and BIT-number with an integer value relative to 0.• When write-data is 0, the output is set to OFF. When 1, the output is set to ON.• The lowest-order bit number of the parallel IO is 0 and the next lowest-order bit number is 1. That is, the BIT number is sequentially incremented.• If an unexisting port or BIT number is specified, an error occurs.
Related Item	INP, OUT, INPBIT, OUTBITSTAT, OUTSTAT

Example of Program

```
evnt
DATA% = INPBIT(0,3)
  if data% = 0 then
    outbit 0,3,1
  endif
end evnt
```

OUTBITSTAT

Function

Function	The OUTBITSTAT function reads the specified BIT number of the specified output port.
Format	OUTBITSTAT (port-number, BIT-number)
Example of Use	DATA% = OUTBITSTAT (0,10)
Description	<ul style="list-style-type: none">• The OUTBITSTAT function reads the specified BIT number of the specified output port.• Specify port-number and BIT-number with an integer value relative to 0.• The lowest-order bit number of the parallel IO is 0 and the next lowest-order bit number is 1. That is, the BIT number is sequentially incremented.• If an unexisting port or BIT number is specified, 0 is returned.
Related Item	INP, OUT, INPBIT, OUTBIT, OUTSTAT

Example of Program

```
evnt
  data% = outbitstat(0,3)
  if data% = 0 then
    outbit 0,3,1
  endif
end evnt
```

OUTSTAT

Function

Function	The OUTSTAT function reads the value of the specified output port.
Format	OUTSTAT (port-number)
Example of Use	DATA% = OUTSTAT (0)
Description	<ul style="list-style-type: none">• The OUTSTAT function reads the value of the specified output port.• Specify port-number with an integer value relative to 0.• If an unexisting port number is specified, 0 is returned.
Related Item	INP, OUT, INPBIT, OUTBIT, OUTBITSTAT

Example of Program

```
evnt
  data% = outstat(0)
  if data% = 0 then
    out 0,&hffff
  endif
end evnt
```



PIPCOLOR

Statement

Function The PIPCOLOR statement changes the OFF, ON1, and ON2 colors of the pipe display.

Format LAMPCOLOR display-name, ON-OFF-number, color-number

Example of Use LAMPCOLOR .BUHIN.GRAPH, 5

Description The PIPCOLOR statement changes the OFF, ON1, and ON2 colors of the pipe display.

- **display-name** is the name of the pipe display or the variable indicating the ID of the pipe display.
- **ON-OFF-number** specifies 0, 1, or 2 for OFF, ON1, or ON2.
- **color-number** specifies the color to be displayed when the lamp display is on with a numeric value from 0 to 15.

Related Item PIPDSP

Example of Program

```
conf
  pipdsp .buhin.graph , 0
  PIPCOLOR .buhin.graph ,1 ,7
  lampdsp .buhin.graph , 1
end conf
```

PIPDSP

Statement

Function	The PIPDSP statement displays data in the pipe display.
Format	PIPDSP control-name, pipe-mode
Example of Use	PIPDSP .BUHIN.GRAPH, 1
Description	<p>The PIPDSP statement sets the pipe display to OFF, ON1, or ON2 for data display.</p> <ul style="list-style-type: none">• control-name is the name of the pipe display or the variable indicating the ID of the pipe display.• pipe-mode sets the pipe display to OFF, ON1, or ON2; it specifies 0, 1, or 2 for OFF, ON1, or ON2.• Display cannot be changed even if the PIPDSP statement is issued to the display for which the operation parameters of the control are set to “effective.”
Related Item	PIPCOLOR

Example of Program

```
conf
  pipdsp .buhin.pip , 0
  PIPCOLOR .buhin.pip ,1 ,7
  pipdsp .buhin.pip , 1
end conf
```

PLTCOLOR

Statement

Function	The PLTCOLOR statement changes the colors and background figure of the plot display.
Format	PLTCOLOR control-name, plot-color, tile, display-color, background-color
Example of Use	PLTCOLOR ..GRAPH, 1, 1, 2, 1
Description	<ul style="list-style-type: none"> • The PLTCOLOR statement changes the background tile and colors of the plot display. -1 indicates that the color and tile for which -1 was specified remain unchanged. • control-name is the plot display name or the ID-type variable indicating the plot display. • plot-color indicates the display color of a dot. Specify this plot color with a numeric value from 0 to 15. • tile indicates the background tiling figure of the graph. • Specify this tiling figure with a numeric value from 0 to 15. • display-color is the numeric value indicating the color number of the tile display section. Specify this color number with a numeric value from 0 to 15. • background-color is the numeric value indicating the color number of the tile background section. Specify this color number with a numeric value from 0 to 15.
Related Item	PLTDSP

Example of Program

```

conf
    static name@
    name@ = ..PLT000
end conf
evnt
    input type%, id@, data%
    if type% = 3 then
        PLTCOLOR name@, 2, 3, 1, 4
    endif
end evnt

```

PLTDSP

Statement

Function	The PLTDSP statement displays data in the plot display.
Format	PLTDSP control-name, display-coordinate-X, display-coordinate-Y
Example of Use	PLTDSP .BUHIN.GRAPH, 15, 30
Description	<ul style="list-style-type: none">• The PLTDSP statement displays data in the plot display.• display-name is the plot display name or the ID-type variable indicating the plot display.• display-coordinate-X and display-coordinate-Y are the numeric data indicating the coordinates to be displayed in the plot display.• display-value cannot be changed even if this statement is issued to the display for which operation parameters are set to “effective” in the control.
Related Item	PLTCOLOR

Example of Program

```
conf
  static name@
  name@ = ..PLT000
end conf
evnt
  input type%, id@, x%,y%
  if type% = 3 then
    PLTDSP name@, x%, y%
  endif
end evnt
```



PMODE

Statement

Function The PMODE statement changes the status of the specified part.

Format PMODE part-name, mode

Example of Use PMODE .BUHIN., 3

Description

- **part-name** is the name of the part whose status is to be modified or the ID-type variable indicating the part.
- **mode** indicates the status to be modified.
 - 0: Normal status
 - 1: Switch input disable status
 - 2: Half tone status

Related Item PSTAT

Example of Program

```

evnt
  input type% , id@ , data%
  if pstat(.BUHIN.) = 0 then
    PMODE .BUHIN., 1
  endif
end evnt

```

PRDSP

Statement

Function	The PRDSP statement redisplay the specified control.
Format	PRDSP control-name
Example of Use	PRDSP .BUHIN.PRIM
Description	<ul style="list-style-type: none">control-name is the name of the control to be redisplayed or the ID-type variable indicating the control.
Related Item	BARSET, CIRSET, BLTSET, LNESET

Example of Program

```
evnt
  lneset .buhin.graph , 3 , 8 , 20.1
  lneset .buhin.graph , 3 , 8 , 20.1
  PRDSP .buhin.graph
end evnt
```

--

PREVJUMP

Statement

Function	The PREVJUMP statement jumps to the immediately preceding screen.
Format	PREVJUMP
Example of Use	PREVJUMP
Description	<ul style="list-style-type: none">• The PREVJUMP statement jumps to the screen displayed before the current screen according to the recorded screen transition path.• Up to 30 screens can be recorded. The PREVJUMP statement cannot jump to a screen before the recorded 30 screens.
Related Item	JUMP

Example of Program

```
conf
end conf
evnt
    input type% , id@ , data%
    if id@ = ..SWT000 then PREVJUMP
end evnt
```

PRINT

Statement

Function	The PRINT statement writes messages.
Format	PRINT expression [, expression]
Example of Use	PRINT 23, "ABCD", XYZ, MOJIS
Description	<ul style="list-style-type: none">• The PRINT statement writes the messages to be output the screen, part, serial port, or parallel port.• When two or more messages are written, delimit them in commas (,).• Messages are not output when the PRINT statement is executed; they are output for the first time when the SEND command is executed.• When messages are output to the host computer, commas (,) are inserted to delimit data.
Related Item	INPUT, SEND

Example of Program

```
evnt
  input type% , id@ , data%
  if type% = 3 then
    PRINT "ABCD", data%
    send .B000.
  endif
end evnt
```

PRMCTL

Statement

Function	The PRMCTL statement changes the attributes of the specified primitive.
Format	PRMCTL1 control-name, request-code, control-value-1 PRMCTL2 control-name, request-code, type-1, control-value-1 PRMCTL3 control-name, request-code, type-1, control-value-2 PRMCTL4 control-name, request-code, type-1, type-2, control-value-1
Example of Use	PRMCTL1 ..NUM000, _PD_STAT, 3 PRMCTL2 ..NUM000, _PD_DCOLOR, 3, 4 PRMCTL3 ..LNE000, _PD_RANGE, 0, 2.5 PRMCTL4 ..BAR000, _PD_PTRN, 1, 0, 12
Description	<ul style="list-style-type: none"> • The PRMCTL statement changes the attributes of the specified control. This statement is classified into four types: PRMCTL1, PRMCTL2, PRMCTL3, and PRMCTL4. • control-name is the constant indicating the control to be changed or the ID-type variable indicating the ID of the control. • request-code specifies what attribute changes is to be performed. The types of request codes are shown on the next and subsequent pages. • type-1 and type-2 depend on the request code to be specified. • control-value-1 specifies the value corresponding to the specified request code; it must be an integer-type constant or variable. • control-value-2 specifies the value corresponding to the specified request code; it must be a floating-point constant or variable.
Related Item	PRMCTL1, PRMCTL2, PRMCTL3, PRMCTL4, PRMSTAT1, PRMSTAT2, PRMSTAT3, PRMSTAT4

Example of Program

```

conf
end conf
evnt
    status% = prmstat1(..NUM000, _PD_STAT)
    if status% = 0 then
        PRMCTL1 ..NUM000, _PD_STAT, 2
    endif
end evnt

```

- The types and usage of the request codes that can be used by PRMCTL1 are explained below.

1._PD_STAT

Function: _PD_STAT changes the display format (normal/reversal video/blinking/on-and-off) of a control.

Range: _PD_STAT is applicable to all controls.

Control-value: Set one of the following numeric values indicating the display format:

- 0: Normal display
- 1: Reversal video display
- 2: Blinking
- 3: On-and-off display

2._PD_DSPFMT

Function: _PD_DSPFMT changes the display format of a control.

Range: _PD_DSPFMT is applicable to numeric and character displays.

Control-value: The control value depends on whether the numeric or character display is used.

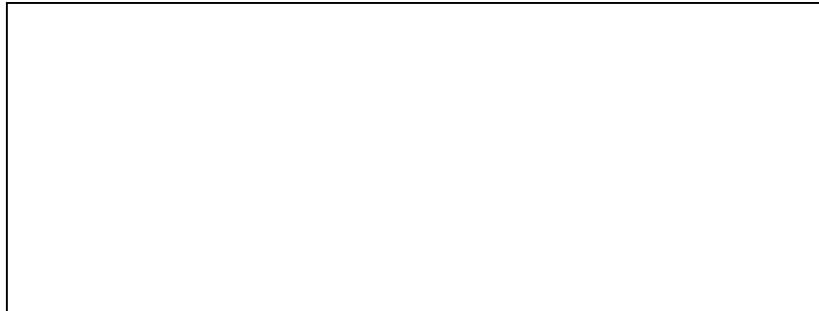

3._PD_PTPOS

Function: _PD_PTPOS changes the position of a decimal point.

Range: _PD_PTPOS is applicable only to numeric displays.

Control-value: Set a value indicating the position of a decimal point. If a negative value is set, PRMCTL1 forcibly changes it to 0.

4._PD_ZSPRS

Function: _PD_ZSPRS sets zero suppression operation.

Range: _PD_ZSPRS is applicable only to numeric displays.

Control-value: When not perform zero suppression, set 0. When performing zero suppression, set 1.

5._PD_FIGMD

Function: _PD_FIGMD sets whether to match the size of the graphic to be displayed on a graphic display with that of the display.

Range: _PD_FIGMD is applicable only to graphic displays.

Control-value: When not matching the size of the graphic with that of the graphic display, set 0. When matching the size of the graphic with that of the graphic display, set 1.

6._PD_WSIZ

Function: _PD_WSIZ changes the dot size or line width of a display.
 Range: _PD_WSIZ is applicable to plot, meter, and pipe displays.
 Control-value: For a plot display, set the dot size (small to large) with a numeric value from 0 to 2. For a meter display, set the line width (narrow to wide) with a numeric value from 0 to 2. For a pipe display, set the thickness (1, 3, 5, or 7) with a numeric value from 0 to 3.

7._PD_PIPSTAT

Function: _PD_PIPSTAT changes the ON or OFF status of a lamp or pipe display.
 Range: _PD_PIPSTAT is applicable to lamp and pipe displays.
 Control-value: Set the ON and OFF statuses of the lamp and pipe displays as follows:

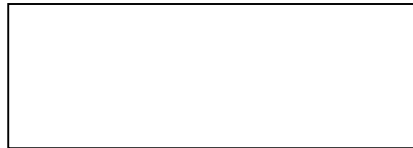

8._PL_FIRST

Function: _PL_FIRST changes the start registration number of the registration graphic or character string to be displayed.
 Range: _PL_FIRST is applicable to character and graphic displays.
 Control-value: Set the value you want to use as the start registration number.

9._PL_SMPMSG

Function: _PL_SMPMSG specifies whether to issue messages to the part on which the control is placed when sampling is performed by the control.
 Range: _PL_SMPMSG is applicable to plot, bar graph, and line chart displays.
 Control-value: When issuing messages to the part, set 1. When not issuing messages, set 0.

10._PL_SMPCTL

Function: _PL_SMPCTL controls sampling. (“Stop”, “start”, and “reset”)
 Range: _PL_SMPCTL is applicable to plot, bar graph, and line chart displays.
 Control-value: “Stop” stops sampling. “Start” starts sampling from the stop status. “Reset” clears display and starts sampling from the beginning.
 0: Sampling is stopped.
 1: Sampling is started.
 2: Sampling is reset.

11._PL_SMPTME

Function: _PL_SMPTME changes a sampling time.
 Range: _PL_SMPTME is applicable to plot, bar graph, and line chart displays.
 Control-value: Set a value indicating the sampling time (setting value* 0.5 second). When the sampling time is changed, sampling is started after it has been reset (see “_PL_SMPCLT”).

12._PL_DIRECT

Function: _PL_DIRECT changes the display direction of a line chart.
 Range: _PLI_DIRECT is applicable only to line chart displays.
 Control-value: When changing the display direction of the line chart from right to left, set 0. When changing the display direction from left to right, set 1. This direction change is meaningless if sampling is not performed. When the display direction is changed, sampling is started after it has been reset (see “_PL_SMPCLT”).

13._SW_RACT

Function: _SW_RACT sets whether to perform reverse operation when a switch is ON.
 Range: _SW_RACT is applicable to switches and selector switches.
 Control-value: To perform reverse operation when a switch is ON, set 1. Not to perform reverse operation, set 0.

14._SW_BZER

Function: _SW_BZER sets whether to sound the buzzer when a switch is ON.
 Range: _SW_BZER is applicable to switches and selector switches.
 Control-value: To sound the buzzer when a switch is pressed, set 1. Not to sound the buzzer, set 0.

15._SW_STAT

Function: _SW_STAT changes the status (normal operation/ input disable/half-tone) of a switch.
 Range: _SW_STAT is applicable to switches and selector switches.
 Control-value: Set one of the following numeric values indicating the switch status:
 0: Normal operation status
 1: Input disable status
 2: Half-tone status

16._SW_BMODE

Function: _SW_BMODE changes the switch background color display method.
 Range: _SW_BMODE is applicable to switches and selector switches.
 Control-value: When changing the switch background color display method to “direct display”, set 0. When changing the display method to “replacement display”, set 1.

17._SW_ONCOLOR

Function: _SW_ONCOLOR sets a switch-ON background color.
 Range: _SW_ONCOLOR is applicable to switches and selector switches.
 Control-value: Set the number of the switch-ON background color to be used with a numeric value from 0 to 15.

18. `_SW_OFFCOLOR`

Function: `_SW_OFFCOLOR` sets a switch-OFF background color.
 Range: `_SW_OFFCOLOR` is applicable to switches and selector switches.
 Control-value: Set the number of the switch-OFF background color to be used with a numeric value from 0 to 15.

19. `_SW_ONOFF`

Function: `_SW_ONOFF` changes the ON/OFF status of a switch. (Executing `_SW_ONOFF` for the switch for synchronous operation causes an error.)
 Range: `_SW_ONOFF` is applicable to switches and selector switches.
 Control-value: When changing a switch to the OFF status, set 0. When changing a switch to the ON status, set 1. When changing all selector switches to the OFF status, set 0. When changing one of the selector switches to the ON status, set the corresponding element number.

- The types and usage of the request codes that can be used by PRMCTL2 are explained below.

1. `_PD_DCOLOR`

Function: `_PD_COLOR` changes the display color of a display.
 Range: `_PD_DCOLOR` is applicable to the ON color specification of numeric, character, clock, plot, free graph, meter, and lamp displays.
 Type: Specify one of the following:
 0: Figure change
 1: Fore color change
 2: Back color change
 3: Display color change
 Control-value: Set the number of the display color to be changed with a numeric value from 0 to 15.

2. `_PD_BCOLOR`

Function: `_PD_BCOLOR` changes the background color of a control.
 Range: `_PD_BCOLOR` is applicable to numeric, character, clock, plot, bar graph, line chart, and free graph displays.
 Type: Specify one of the following:
 0: Figure change
 1: Fore color change
 2: Back color change
 Control-value: Set the number of the background color to be changed with a numeric value from 0 to 15.

3. `_PD_PIPCOLOR`

Function: `_PD_PIPCOLOR` changes the internal color of a pipe or lamp display.
 Range: `_PD_PIPCOLOR` is applicable to pipe and lamp displays.
 Type: Specify one of the following:
 0: Change of OFF display color (valid for pipe and lamp displays)
 1: Change of ON1 display color (valid for pipe and lamp displays)
 2: Change of ON2 display color (valid for pipe displays)
 Control-value: Set the number of the internal color to be changed with a numeric value from 0 to 15.

4. **_PD_BSLNE**
Function: **_PD_BSLNE** changes the type of a base line or a reference line.
Range: **_PD_BSLNE** is applicable to bar graphs and line charts.
Type: Specify one of the following:
 0: Change of base line type
 1: Change of reference line 1 type
 2: Change of reference line 2 type
Control-value: Set the number of the line type to be changed with a numeric value from 0 to 3.
5. **_PD_BSCOLOR**
Function: **_PD_BSCOLOR** changes the color of a base line or a reference line.
Range: **_PD_BSCOLOR** is applicable to bar graphs and line charts.
Type: Specify one of the following:
 0: Change of base line color
 1: Change of reference line 1 color
 2: Change of reference line 2 color
Control-value: Set the number of the line color to be changed with a numeric value from 0 to 15.
6. **_SW_ONFIG**
Function: **_SW_ONFIG** changes a switch-ON display graphic.
Range: **_SW_ONFIG** is applicable to switches and selector switches.
Type: For a switch, specify 1. For a selector switch, specify the element number of the switch whose ON graphic is to be changed. The element number starts at 1.
Control-value: Specify the registration graphic number displayed when a switch is ON.
7. **_SW_OFFFIG**
Function: **_SW_OFFFIG** changes a switch-OFF display graphic.
Range: **_SW_OFFFIG** is applicable to switches and selector switches.
Type: For a switch, specify 1. For a selector switch, specify the element number of the switch whose OFF graphic is to be changed. The element number starts at 1.
Control-value: Specify the registration graphic number displayed when a switch is OFF.

- The types and usage of the request codes that can be used by PRMCTL3 are explained below.

1. `_PD_RANGE`

Function: `_PD_RANGE` sets the display range of a display.
Range: `_PD_RANGE` is applicable to bar graph, line chart, free graph, slide, meter, and plot displays.
Type: When the plot display is used, specify 0 (Xmin change), 1 (Xmax change), 2 (Ymin change), or 3 (Ymax change). When the bar graph, line chart, free graph, slide, or meter display is used, specify 2 (minimum change) or 3 (maximum change).
Control-value: Set the value (display range) to be changed.

2. `_PD_BSVL`

Function: `_PD_BSVL` changes the setting value of a base or reference line.
Range: `_PD_BSVL` is applicable to bar graph and line chart displays.
Type: Specify 0 (base line change), 1 (change of reference line 1), or 2 (change of reference line 2).
Control-value: Set the value to be changed.

- The types and usage of the request codes that can be used by PRMCTL4 are explained below.

1. `_PD_PTRN`

Function: `_PD_PTRN` changes the display color of a control.
Range: `_PD_PTRN` is applicable to bar graph, 100 percent bar chart, and pie chart displays.
Type-1: Specify the number of the bar or zone whose display color is to be changed.
Type-2: Specify one of the following:
 0: Figure change
 1: Fore color change
 2: Back color change
Control-value: Set the number of the display color to be changed with a numeric value from 0 to 15.

2. `_PD_LNE`

Function: `_PD_LNE` changes the display color of a line chart.
Range: `_PD_LNE` is applicable only to line charts.
Type-1: Specify the number of the line whose display color is to be changed.
Type-2: Specify one of the following:
 0: Line type change
 1: Line color change
Control-value: Set the number of the display color to be changed with a numeric value from 0 to 15.

PRMSTAT

Function

- Function** The PRMSTAT function reads the attributes of the specified primitive.
- Format**
- ```
return-value-1 = PRMSTAT1 (control-name, request-code)
return-value-1 = PRMSTAT2 (control-name, request-code, type-1)
return-value-2 = PRMSTAT3 (control-name, request-code, type-1)
return-value-1 = PRMSTAT4 (control-name, request-code, type-1, type-2)
```
- Example of Use**
- ```
VAL% = PRMSTAT1 (..NUM000, _PD_STAT)
VAL% = PRMSTAT2 (..NUM000, _PD_DCOLOR, 3)
VALF! = PRMSTAT3 (..LNE000, _PD_RANGE, 0)
VAL% = PRMSTAT4 (..BAR000, _PD_PTRN, 1, 0)
```
- Description**
- The PRMSTAT function reads the attributes of the specified primitive. This function is classified into four types: PRMSTAT1, PRMSTAT2, PRMSTAT3, and PRMSTAT4.
 - **control-name** is the constant indicating the primitive to be read or the ID-type variable indicating the ID of the control.
 - **request-code** specifies the attributes to be read. The types of request codes are shown on the next and subsequent pages.
 - **type-1** and **type-2** depend on the request code to be specified.
 - **return-value-1** is the return value of the function corresponding to the specified request code; it must be an integer-type constant or variable.
 - **return-value-2** is the return value of the function corresponding to the specified request code; it must be a floating-point constant or variable.
- Related Item** PRMCTL1, PRMCTL2, PRMCTL3, PRMCTL4, PRMSTAT1, PRMSTAT2, PRMSTAT3, PRMSTAT4

Example of Program

```
conf
end conf
evnt
    status% = prmstat1(..NUM000, _PD_STAT)
    if status% = 0 then
        PRMCTL1 ..NUM000, _PD_STAT, 2
    endif
end evnt
```



- The types and usage of the request codes that can be used by PRMSTAT1 are explained below.

1. `_PD_NUMS`

Function: `_PD_NUMS` reads the number of control elements.

Range: `_PD_NUMS` is applicable to all display controls.

Return-value-1: The value indicating the display format is set. When the display format is not “continuous-stage type”, 1 is always set.

2. `_PD_ROTATE`

Function: `_PD_ROTATE` reads the rotation direction of a control .

Range: `_PD_ROTATE` is applicable to all display controls.

Return-value-1: For 0 degree, 0 is returned. For 90 degrees, 1 is returned. For 180 degrees, 2 is returned. For 270 degrees, 3 is returned. For pie chart, meter, lamp, and pipe displays, 0 is always returned.

3. `_PD_STAT`

Function: `_PD_STAT` reads the display format (normal/reverse video display/blinking/on-and-off display) of a control.

Range: `_PD_STAT` is applicable to all controls.

Return-value: One of the following values is returned:

- 0: Normal display
- 1: Reverse video display
- 2: Blinking
- 3: On-and-off display

4. `_PD_DSPFMT`

Function: `_PD_DSPFMT` reads the display format of a control.

Range: `_PD_DSPFMT` is applicable to numeric and character controls.

Return-value-1: The value to be returned depends on whether the numeric or character display is used.



5. `_PD_DATFMT`

Function: `_PD_DATFMT` reads the display data format.

Range: `_PD_DATFMT` is applicable to all controls except for clock displays.

Return-value: For a real number, 0 is returned. For an integer, 1 is returned. For an unsigned integer, 2 is returned. For a BCD, 3 is returned. (For the lamp primitive, 2 is always returned.)

6. `_PD_FONT`
 - Function: `_PD_FONT` reads the type of the font displayed on the control.
 - Range: `_PD_FONT` is applicable to numeric and clock displays.
 - Return-value: For half-size character display, 0 is returned. For full-size character display, 1 is returned.
7. `_PD_XFSZ`
 - Function: `_PD_XFSZ` reads the horizontal-direction size of the font displayed on the control.
 - Range: `_PD_XFSZ` is applicable to numeric, character, and clock displays.
 - Return-value: For 1 magnification, 0 is returned. For 2 magnifications, 1 is returned. For 4 magnifications, 2 is returned. For 8 magnifications, 3 is returned. For 16 magnifications, 4 is returned.
8. `_PD_YFSZ`
 - Function: `_PD_YFSZ` reads the vertical-direction size of the font displayed on the control.
 - Range: `_PD_YFSZ` is applicable to numeric, character, and clock displays.
 - Return-value: For 1 magnification, 0 is returned. For 2 magnifications, 1 is returned. For 4 magnifications, 2 is returned. For 8 magnifications, 3 is returned. For 16 magnifications, 4 is returned. For 32 magnifications, 5 is returned.
9. `_PD_PTPOS`
 - Function: `_PD_PTPOS` reads the position of a decimal point.
 - Range: `_PD_PTPOS` is applicable only to numeric displays.
 - Return-value: The position of the decimal point is returned.
10. `_PD_ZSPRS`
 - Function: `_PD_ZSPRS` reads whether to perform zero suppression.
 - Range: `_PD_ZSPRS` is applicable only to numeric displays.
 - Return-value: When zero suppression is not performed, 0 is returned. When zero suppression is performed, 1 is returned.
11. `_PD_XNUM`
 - Function: `_PD_XNUM` reads the number of horizontal-direction display digits.
 - Range: `_PD_XNUM` is applicable to numeric and character displays.
 - Return-value: The number of characters that can be displayed when horizontal-direction half-size conversion is performed is returned.
12. `_PD_YNUM`
 - Function: `_PD_YNUM` reads the number of vertical-direction display digits.
 - Range: `_PD_YNUM` is applicable only to character displays.
 - Return-value: The number of characters that can be displayed in the vertical direction is returned.
13. `_PD_DIRECT`
 - Function: `_PD_DIRECT` reads the display direction of a character display.
 - Range: `_PD_DIRECT` is applicable only to character displays.
 - Return-value: For horizontal writing, 0 is returned. For columnar writing, 1 is returned.

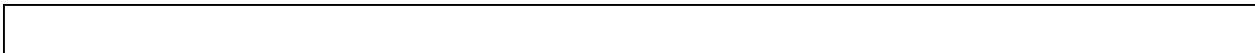

14. **_PD_PLTNUM**
 Function: **_PD_PLTNUM** reads the maximum number of plots that can be displayed on the control.
 Range: **_PD_PLTNUM** is applicable to plot and line chart displays.
 Return-value: The maximum number of plots that can be displayed is returned.
15. **_PD_LNENUM**
 Function: **_PD_LNENUM** reads the number of bars and lines that can be displayed on the control.
 Range: **_PD_LNENUM** is applicable to plot and line chart displays.
 Return-value: The maximum number of bars and lines that can be displayed is returned.
16. **_PD_ZNNUM**
 Function: **_PD_ZNNUM** reads the number of zones that can be displayed on the control.
 Range: **_PD_ZNNUM** is applicable to pie chart and 100 percent bar chart displays.
 Return-value: The number of zones that can be displayed is returned.
17. **_PD_FIGMD**
 Function: **_PD_FIGMD** reads whether to match the size of the graphic to be displayed on a graphic display with that of the display.
 Range: **_PD_FIGMD** is applicable only to graphic displays.
 Return-value: When matching the size of the graphic with that of the graphic display, set 1. When not matching the size of the graphic with that of the graphic display, set 1.
18. **_PD_WSIZ**
 Function: **_PD_WSIZ** reads the dot size or line width of a control.
 Range: **_PD_WSIZ** is applicable to plot, meter, and pipe displays.
 Return-value: For a plot display, the numeric value (0 to 2) indicating the dot size (small to large) is returned. For a meter display, the numeric value (0 to 2) indicating the line width (narrow to wide) is returned. For a pipe display, the numeric value (0 to 3) indicating the thickness (1, 3, 5, or 7) is returned.
19. **_PD_PIPSTAT**
 Function: **_PD_PIPSTAT** reads the ON or OFF status of a lamp or pipe display.
 Range: **_PD_PIPSTAT** is applicable to lamp and pipe displays.
 Return-value: Any of the following values indicating the ON or OFF status of the lamp or pipe display is returned:

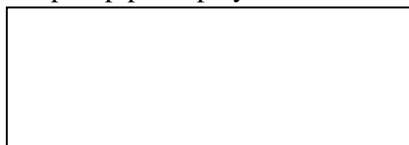

20. `_PL_NUMS`
Function: `_PL_NUMS` reads the number of devices being used.
Range: `_PL_NUMS` is applicable to all controls except for clock displays.
Return-value: The number of devices being used is returned. (When a doubleword is specified for a numeric display, the number of devices is doubled.)
21. `_PL_FIRST`
Function: `_PL_FIRST` reads the start registration number of the registration graphic or character string to be displayed.
Range: `_PL_FIRST` is applicable to character and graphic displays.
Return-value: The start registration number to be displayed is returned.
22. `_PL_DVTYP`
Function: `_PL_DVTYP` reads the type of the device being used by the control.
Range: `_PL_DVTYP` is applicable only to numeric displays.
Return-value: For a doubleword, 0 is returned. For a single word, 1 is returned.
23. `_PL_ENDI`
Function: `_PL_ENDI` reads the doubleword display method.
Range: `_PL_ENDI` is applicable only to numeric displays.
Return-value: When doublewords are displayed from downward to upward, 0 is returned. When doublewords are displayed from upward to downward, 1 is returned.
24. `_PL_SMPMSG`
Function: `_PL_SMPMSG` reads whether to issue messages to the part on which the control is placed when sampling is performed by the control.
Range: `_PL_SMPMSG` is applicable to plot, bar graph, and line chart displays.
Return-value: When messages are issued to the part, 1 is returned. When no message is issued, 0 is returned.
25. `_PL_SMPTME`
Function: `_PL_SMPTME` reads a sampling time.
Range: `_PL_SMPTME` is applicable to plot, bar graph, and line chart displays.
Return-value: A value indicating the sampling time (read value* 0.5 second) is returned.
26. `_PL_DIRECT`
Function: `_PL_DIRECT` reads the display direction of a line chart.
Range: `_PLI_DIRECT` is applicable only to line chart displays.
Return-value: When line charts are displayed from right to left, 0 is returned. When they are displayed from left to right, 1 is returned.
27. `_SW_NUMS`
Function: `_SW_NUMS` reads the number of switch elements.
Range: `_SW_NUMS` is applicable to switches and selector switches.
Return-value: For a switch, 1 is always returned. For a selector switch, the number of elements is returned.

- | |
|--|
| |
|--|
28. **_SW_TYPE**
Function: `_SW_TYPE` reads a switch type.
Range: `_SW_TYPE` is applicable to switches and selector switches.
Return-value: For the momentary switch, 0 is returned. For the alternate switch, 1 is returned. For the auto-repeat switch, 2 is returned. For a selector switch, 3 is returned.
29. **_SW_ONCOLOR**
Function: `_SW_ONCOLOR` reads a switch-ON background color.
Range: `_SW_ONCOLOR` is applicable to switches and selector switches.
Return-value: The number (0 to 15) of the read switch-ON background color is returned.
30. **_SW_OFFCOLOR**
Function: `_SW_OFFCOLOR` reads a switch-OFF background color.
Range: `_SW_OFFCOLOR` is applicable to switches and selector switches.
Return-value: The number (1 to 15) of the read switch-OFF background color is returned.
31. **_SW_BMODE**
Function: `_SW_BMODE` reads the switch background color display method.
Range: `_SW_BMODE` is applicable to switches and selector switches.
Return-value: When the switch background color display method is “direct display”, 0 is returned. When the display method is “replacement display”, 1 is returned.
32. **_SW_RACT**
Function: `_SW_RACT` reads whether to perform reverse operation when a switch is ON.
Range: `_SW_RACT` is applicable to switches and selector switches.
Return-value: If reverse operation is performed when a switch is ON, 1 is returned. If reverse operation is not performed, 0 is returned.
33. **_SW_BZER**
Function: `_SW_BZER` reads whether to sound the buzzer when a switch is ON.
Range: `_SW_BZER` is applicable to switches and selector switches.
Return-value: If the buzzer is sounded when a switch is pressed, 1 is returned. If the buzzer is not sounded, 0 is returned.
34. **_SW_STAT**
Function: `_SW_STAT` reads the status (normal operation/ input disable/halftone) of a switch.
Range: `_SW_STAT` is applicable to switches and selector switches.
Return-value: One of the following numeric values indicating the switch status is returned:
0: Normal operation status
1: Input disable status

2: Halftone status

35. `_SW_ONOFF`

Function: `_SW_ONOFF` reads the ON/OFF status of a switch.

Range: `_SW_ONOFF` is applicable to switches and selector switches.

Return-value: When a switch is in the OFF status, 0 is returned. When a switch is in the ON status, 1 is returned. When all the selector switches are in the OFF status, 0 is returned. When one of the selector switches is in the ON status, the corresponding element number is returned.

36. `_SL_SYNC`

Function: `_SL_SYNC` reads the synchronous operation of a switch.

Range: `_SL_SYNC` is applicable to switches and selector switches.

Return-value: When the synchronous operation is not performed, 0 is returned. When the synchronous operation is performed, 1 is returned.

37. `_SL_BORW`

Function: `_SL_BORW` reads the switch device write method.

Range: `_SL_BORW` is applicable to selector switches.

Return-value: When the switch device write method is the bit type write method, 0 is returned. When it is the word type write method, 1 is returned.

- The types and usage of the request codes that can be used by PRMSTAT2 are explained below.

1. `_PD_DCOLOR`

Function: `_PD_DCOLOR` reads the display color of a control.

Range: `_PD_DCOLOR` is applicable to the ON color specification of numeric, character, clock, plot, free graph, meter, and lamp displays.

Type: Specify one of the following:

- 0: Figure read
- 1: Fore color read
- 2: Back color read
- 3: Display color read

Return-value: The number (0 to 15) of the read display color is returned.

2. `_PD_BCOLOR`

Function: `_PD_BCOLOR` reads the background color of a control.

Range: `_PD_BCOLOR` is applicable to numeric, character, clock, plot, bar graph, line chart, and free graph displays.

Type: Specify one of the following:

- 0: Figure read
- 1: Fore color read
- 2: Back color read

Return-value: The number (0 to 15) of the read background color is returned.

3. `_PD_PIPCOLOR`

Function: `_PD_PIPCOLOR` reads the internal color of a pipe or lamp display.
 Range: `_PD_PIPCOLOR` is applicable to pipe and lamp displays.
 Type: Specify one of the following:
 0: Read of OFF display color (valid for pipe and lamp displays)
 1: Read of ON1 display color (valid for pipe and lamp displays)
 2: Read of ON2 display color (valid for pipe displays)
 Return-value: The number (0 to 15) of the read internal color is returned.

4. `_PD_BSLNE`

Function: `_PD_BSLNE` reads the type of a base line or a reference line.
 Range: `_PD_BSLNE` is applicable to bar graphs and line charts.
 Type: Specify one of the following:
 0: Read of base line type
 1: Read of reference line 1 type
 2: Read of reference line 2 type
 Return-value: The number (0 to 3) of the read line type is returned.

5. `_PD_BSCOLOR`

Function: `_PD_BSCOLOR` reads the color of a base line or a reference line.
 Range: `_PD_BSCOLOR` is applicable to bar graphs and line charts.
 Type: Specify one of the following:
 0: Read of base line color
 1: Read of reference line 1 color
 2: Read of reference line 2 color
 Return-value: The number (0 to 15) of the read line color is returned.

6. `_SW_ONFIG`

Function: `_SW_ONFIG` reads the graphic number displayed when a switch is ON.
 Range: `_SW_ONFIG` is applicable to switches and selector switches.
 Type: For a switch, specify 1. For a selector switch, specify the element number of the switch whose ON graphic is to be changed. The element number starts at 1.
 Return-value: The read graphic number is returned.

7. `_SW_OFFFIG`

Function: `_SW_OFFFIG` reads the graphic number displayed when a switch is OFF.
 Range: `_SW_OFFFIG` is applicable to switches and selector switches.
 Type: For a switch, specify 1. For a selector switch, specify the element number of the switch whose OFF graphic is to be changed. The element number starts at 1.
 Return-value: The read graphic number is returned.

8. `_SL_WRITE`

Function: `_SL_WRITE` reads the switch write value.
 Range: `_SL_WRITE` is applicable to switches.
 Type: To read the write value when a switch is ON, specify 1. To read the write value when a switch is OFF, specify 0.
 Return-value: The read write value is returned.

9. `_PD_PLOTRNG`

Function: `PD PLOTRNG` writes the start and end points of displaying a line chart.
 Range: `PD PLOTRNG` is applicable to line charts.
 Type: Specify one of the following:
 0: Indicates reading of the display start point.
 1: Indicates reading of the display end point.

- The types and usage of the request codes that can be used by `PRSTAT3` are explained below.

1. `_PD_RANGE`

Function: `_PD_RANGE` reads the display range of a control.
 Range: `_PD_RANGE` is applicable to bar graph, line chart, free graph, slide, meter, and plot displays.
 Type: When reading Xmin, specify 0. When reading Xmax, specify 1. When reading Ymin, specify 2. When reading Ymax, specify 3.
 Return-value: A value indicating the display range is returned.

2. `_PD_BSVVAL`

Function: `_PD_BSVVAL` reads the setting value of a base or reference line.
 Range: `_PD_BSVVAL` is applicable to bar graph and line chart displays.
 Type: When changing a base line, specify 0. When changing reference line 1, specify 1. When changing reference line 2, specify 2.
 Return-value: A value indicating the display range is returned.

- The types and usage of the request codes that can be used by `PRMSTAT4` are explained below.

1. `_PD_PTRN`

Function: `_PD_PTRN` reads the display color of a control.
 Range: `_PD_PTRN` is applicable to bar graph, 100 percent bar chart, and pie chart displays.
 Type-1: Specify the number of the bar or zone whose display color is to be changed.
 Type-2: Specify one of the following:
 0: Figure read
 1: Fore color read
 2: Back color read
 Return-value: The values indicating the read figure and color number are returned.



2. `_PD_LNE`

- Function: `_PD_LNE` reads the display color of a line chart.
- Range: `_PD_LNE` is applicable to line charts.
- Type-1: Specify the number of the line whose display color is to be changed.
- Type-2: Specify one of the following:
 - 0: Line type read
 - 1: Line color read
- Return-value: The values indicating the read line type and color are returned.

PSTAT

Function

Function	The PSTAT function reads the status of the specified part.
Format	PSTAT (part-name)
Example of Use	MODE = PSTAT (.BUHIN.)
Description	<ul style="list-style-type: none">• The PSTAT function reads the status of the part specified in part-name.• part-name is the name of the part whose status is to be read or the ID-type variable indicating the part.• The value indicating the mode of the part can be obtained by executing this function. The following numeric values indicate modes.<ul style="list-style-type: none">1: Switch input disable status2: Half tone status3: Close status
Related Item	PMODE

Example of Program

```
evnt
  input type% , id@ , data%
  if PSTAT(.BUHIN.) = 0 then
    pmode .BUHIN. , 1
  endif
end evnt
```

RANGE

Statement

Function The RANGE function modifies the area(s) of the control for which the maximum and minimum display data values were specified.

Format RANGE control-name, area-1, area-2, area-3, area-4

Example of Use RANGE ..GRAPH, 0, 0, 100, 100

Description

- control-name is the graph name or the ID-type variable indicating the graph.
- The maximum and minimum area values in the control can be set for each display as follows:

	Area 1	Area 2	Area 3	Area 4
Plot display	Minimum horizontal value	Maximum horizontal value	Minimum vertical value	Maximum vertical value
Bar graph display	Minimum value	Maximum value	Base value	–
Line chart display	Minimum value	Maximum value	–	–
Free graph display	Minimum value	Maximum value	–	–
Slide display	Minimum value	Maximum value	–	–
Meter display	Minimum value	Maximum value	–	–

“–” is ignored even if it is specified.

Related Item None

Example of Program

```

evnt
  input type% , id@ , min%,max%
  if type% = 3 then
    range ..MTR000 , min% , max% , 0 , 0
  endif
end evnt

```

READTIM

Function

Function	The READTIM function reads the current value of the specified timer.
Format	READTIM (timer-number)
Example of Use	DD = READTIM (TNO@) DD = READTIM (VAR)
Description	<ul style="list-style-type: none"> • The READTIM function reads the current elapse time of the operating timer. This time is read in units of 100 milliseconds. • timer-value is the ID-type variable indicating the number of the timer to be read or an integer-type value from 0 to 15.
Related Item	OPENTIM, STARTTIM, STOPTIM, CLOSETIM, CONTTIM, WRITETIM

Example of Program

```

conf
  static timid@
  timid@ = OPENTIM()
  settim timid@, 20, 0
  starttim timid@
end conf
evnt
  input type% , id@ , data%
  if type% = 3 then
    tim% = READTIM(timid@)
    numdsp ..NUM000,tim%*100
  end if
end evnt

```

RENAME

Statement

Function	The RENAME statement changes a file name or directory name.
Format	RENAME old file name, new file name
Example of Use	RENAME "A:\SUBDIR\FILE1", "FILE2"
Description	<ul style="list-style-type: none"> • A file name can be specified in a full path name including a drive name or in an abbreviated name beginning with a current directory name. Example: A:\SUBDIR\FILE1 FILE1 • A new file name must not contain a path name. • To change a directory name, specify a directory name, instead of a file name.
Related Item	FOPEN,KILL,MKDIR,RMDIR

Example of Program

```

conf
  global dname$(13), pname1$(13), pname2$(13), pname3$(13)
  global dsel%, p1sel%, p2sel%, p3sel%
  strdsp ..str, "rename"
end conf
evnt
  input type%, id@, data%
  if data% = 1 then
    path$ = dname$(dsel%) + pname1$(p1sel%) + pname2$(p2sel%)
    strdsp .dsp.str, path$
    rename path$, pname3$(p3sel%)
  end if
end evnt

```

REOPENCOM

Statement

Function	The REOPENCOM statement reopens the temporarily closed serial line.
Format	REOPENCOM logical-device-name
Example of Use	REOPENCOM HST
Description	<ul style="list-style-type: none">• The REOPENCOM statement permits the program, whose data reception from an external connecting device was temporarily inhibited by the CLOSECOM statement, to receive data again.• logical-device-name specifies any of the following external connecting devices:<ul style="list-style-type: none">HST: Host computerBCR: Bar code readerTKY: Ten-key pad
Related Item	OPENCOM, CLOSECOM

Example of Program

```
conf
  OPENCOM HST
end conf
evnt
  input type% , id@ , data%
  if type% = 3 and data% = 1 then
    CLOSECOM HST
  else if type% = 3 and data% = 0 then
    REOPENCOM HST
  endif
end evnt
```

REOPENPARALLEL

Statement

Function	The REOPENPARALLEL statement permits data re-reception from the temporarily closed parallel port.
Format	REOPENPARALLEL input-bit
Example of Use	REOPENPARALLEL 3
Description	<ul style="list-style-type: none"> • The REOPENPARALLEL statement permits the script, whose data reception from the parallel port was temporarily inhibited by the CLOSEPARALLEL statement, to re-receive data. • input-bit is the bit for restarting data reception. This input bit is the same as the bit specified by the CLOSEPARALLEL statement.
Related Item	OPENPARALLEL, CLOSEPARALLEL

Example of Program

```

conf
    OPENPARALLEL 3
end conf
evnt
    input type% , id@ , data%
    if type% = 3 and data% = 1 then
        CLOSEPARALLEL 3
    else if type% = 3 and data% = 0 then
        REOPENPARALLEL 3
    endif
end evnt

```

RESETALARM

Statement

Function	The RESETALARM statement resets the specified alarm.
Format	RESETALARM alarm-number
Example of Use	RESETALARM (NO@)
Description	<ul style="list-style-type: none">• alarm-number is the number of the alarm set by the SETALARM statement; it must be an ID-type variable.• This statement resets the setting for posting an alarm ON to the program when a specified time is reached.
Related Item	SETALARM

Example of Program

```
conf
  static alid@
  alid@ = setalarm(10,0)
end conf
evnt
  input type% , id@ , data%
  if type% = 3 then
    RESETALARM(alid@)
  end if
end evnt
```

RETURN

Statement

Function	The RETURN statement returns control from the subroutine to the original program.
Format	RETURN
Example of Use	RETURN
Description	<ul style="list-style-type: none">• The RETURN statement returns control to the statement following the statement called by the GOSUB statement.
Related Item	GOSUB

Example of Program

```
evnt
  X = 10
  GOSUB SUB001
  numdsp ..NUM000, X
end evnt
SUB001:
  X = X+3
  RETURN
```

RIGHT\$

Function

Function The RIGHT\$ function returns a character string the specified number of characters, starting from the left of the specified character string.

Format RIGHT\$ (character-string, number-of-characters)
 RIGHT\$ (registered-character-string-number, number-of-characters)
 RIGHT\$ (registered-character-string-name, number-of-characters)

Example of Use A\$ = RIGHT\$ (MOJI\$, 5)
 A\$ = RIGHT\$ (4, 10)
 A\$ = RIGHT\$ (TOROKU, 8)

Description

- The RIGHT\$ function returns a character string the specified number of characters (bytes), starting from the right of the specified character-string.
- **number-of-characters** specifies the number of bytes of the character string to be fetched with a numeric value from 0 to 255. When number-of-characters is 0, a null character string is returned.
- **character-string** is a direct character string or a character string variable.
- **registered-character-string-number** is the numerical expression indicating the number registered by Screen Creator.
- **registered-character-string-name** is the name of the character string created by Screen Creator or the ID-type variable indicating the name of the character string.

Related Item MID\$, LEFT\$

Example of Program

```

evnt
  b$ = "12345678"
  a$ = RIGHT$(b$ , 3)
  c$ = RIGHT$ (no , 3)
  c$ = RIGHT$ (id@ , 4)
end evnt

```

RMDIR

Statement

Function	The RMDIR statement deletes a directory.
Format	RMDIR directory-name
Example of Use	RMDIR "TEST"
Description	<ul style="list-style-type: none">• The RMDIR statement is an instruction for deleting a subdirectory.• Specify the directory to be deleted with a character string constant or variable.• The directory to be deleted can be specified in directory-name together with a drive name.
Related Item	MKDIR, CHDIR

Example of Program

```
conf
end conf
evnt
    .....
    RMDIR ``C:TEST``
    .....
end evnt
```

ROTATE

Statement

Function The ROTATE function rotates the figure displayed in the graphic display.

Format ROTATE control-name, angle-of-rotation

Example of Use ROTATE ..FIG000, 2

Description

- **control-name** is the graphic display name or the ID-type variable indicating the graphic display.
- **angle-of-rotation** specifies the angle of rotation with one of the following numeric values:
 - 0: Rotation of 0 degree
 - 1: Rotation of 90 degrees
 - 2: Rotation of 180 degrees
 - 3: Rotation of 270 degrees

Related Item FIGDSP

Example of Program

```
evnt
  input ty , id@, fig%
  ROTATE ..FIG000 , fig%
end evnt
```

RSTAT

Function

Function	The RSTAT function checks the status of registered objects.
Format	RSTAT (registration-name, type, option)
Example of Use	VAR@ = RSTAT (GAMEN1..., 0, 1)
Description	<ul style="list-style-type: none"> • Of registered objects, the RSTAT function obtains the number of the object that is “number specified by option” away from the specified registration name. • A variable or constant representing a screen name, registration character string name, or registration graphic name can be specified in registration-name. • Specify 0 in type. • When option is a positive value, the RSTAT function checks the registered objects in ascending order of their numbers. When option is a negative value, the RSTAT function checks the objects in descending order of their numbers. • If there is no object that is “number specified by option” away from the specified registration name, the RSTAT function returns -1.
Related Item	GETGID, GETGNO

Example of Program

```

conf
end conf
evnt
    id@ = getgid()
    no% = RSTAT ( id@, 0, 1)           ' Checks the next registered screen
    if no% <> -1 then jump no%       ' number.
end evnt

```

RUN

Statement

Function	The RUN statement runs the specified program.
Format	RUN execution-part/screen
Example of Use	RUN .BUHIN.
Description	<ul style="list-style-type: none">• The RUN statement issues a message to the part/screen specified in execution-part/screen and runs the part/screen program. (The message to be issued contains the message type and ID. It, however, does not contain the issued data.)• The program to which a command was issued is not run when the RUN command is issued; it is run when the program that issued the RUN command terminates.• execution-part/screen is a screen name, a part name, or an ID-type variable.
Related Item	INPUT, PRINT, SEND

Example of Program

```
evnt
  input ty , id@, fig%
  if ty = 3 and id@ = ..SWT000 then
    RUN .B000.
  endif
end evnt
```

SELECT CASE ... END SELECT

Statement

Function	The statements satisfying the specified condition are executed.
Format	<pre> SELECT CASE CASE statement-list CASE statement-list CASE ELSE statement-list END SELECT </pre>
Example of Use	See “Example of Program” below.
Description	<ul style="list-style-type: none"> • The SELECT CASE statement executes the CASE statement list satisfying the specified conditional expression. • When CASE, CASE ELSE, and END SELECT appear after the statements satisfying the specified condition have been executed, the SELECT CASE statement executes the statement following END SELECT. • Condition judgment can be performed up to 50 times.
Related Item	IF ... THEN ... ELSE

Example of Program

```

evnt
  input ty , id@, dat%
  select case dat%
    case 1                ' When dat% is 1
      aaa = 1
    case 2,3              ' When dat% is 2 or 3
      aaa = 2
    case 4 to 10          ' When dat% is 4 to 10
      aaa = 3
    case else              ' When dat% is another value
      aaa =4
  end select
end evnt

```

SEND

Statement

Function	The SEND statement sends data to the specified screen, part, or logical connecting device.
Format	SEND send-destination-name
Example of Use	SEND .BUHIN.
Description	<ul style="list-style-type: none">• The SEND statement sends the data written by the PRINT statement to the specified send destination.• send-destination-name is the name of the screen or part to which data is to be sent, the ID-type variable indicating the name, or one of the following logical connecting devices:<ul style="list-style-type: none">HST: Host computerPRN: Printer• The screen or part script that received data is not executed when the SEND command is issued; it is executed when the program that issued the SEND command terminates.
Related Item	RUN, PRINT

Example of Program

```
evnt
  input ty , id@, dat%
  if ty = 3 and id@ = ..SWT000 then
    print "BUHIN1",dat%
    send .B0000.
  endif
end evnt
```

SETALARM

Statement

Function	The SETALARM statement sets an alarm time.
Format	SETALARM (hour, minute)
Example of Use	ID@ = SETALARM (13, 30)
Description	<ul style="list-style-type: none">• The SETALARM statement sets an alarm time in the OIP built-in clock. When the set alarm time is reached, the data indicating this effect is transmitted to the set screen or part program. Up to 16 alarms can be used.• hour specifies the hour(s) to be set with a numeric value from 0 to 23.• minute specifies the minute(s) to be set with a numeric value from 0 to 59.• When the SETALARM function is executed, the alarm number is returned. The alarm number to be returned is an ID-type variable.• This function can be used by the screen or part program being displayed.
Related Item	RESETALARM

Example of Program

```
conf
  static alid@
  alid@ = SETALARM(10,0)
end conf
evnt
  input type% , id@ , data%
  if type% = 3 then
    resetalarm(alid@)
  end if
end evnt
```

SETBEEP

Statement

Function	The SETBEEP statement specifies the tone of a buzzer.
Format	SETBEEP ON-time, OFF-time, sound-count
Example of Use	SETBEEP 10, 5, 3
Description	<ul style="list-style-type: none">• The SETBEEP statement sets the tone color of the buzzer to be sounded by the BEEP command• ON-time specifies the time during which the buzzer continues to sound in units of 100 milliseconds.• OFF-time specifies the time during which the buzzer continues not to sound in units of 100 milliseconds.• sound-count indicates the number of times the buzzer sounds and does not sound. It is impossible to specify 0.• When OFF-time is 0, the buzzer continues to sound.
Related Item	BEEP

Example of Program

```
conf
  SETBEEP 50,20,3
end conf
evnt
  input type%, id@, data%
  if id@ = ..SWT000 then
    BEEP 1
  else
    BEEP 0
  endif
end evnt
```

SETBLIGHT

Statement

Function	The SETBLIGHT statement sets the time that lasts till the back light is turned off.
Format	SETBLIGHT OFF-time
Example of Use	SETBLIGHT 20
Description	<ul style="list-style-type: none">• OFF-time indicates the time that lasts till the back light is turned off; it is an integer-type variable or a numeric value. OFF-time is set in minutes. When OFF-time is 0, the back light is not turned off.
Related Item	GETBLIGHT

Example of Program

```
conf
  getblight var
  var = var*2
  SETBLIGHT var
end conf
```

SETDATE

Statement

Function	The SETDATE statement sets the date of the built-in clock.
Format	SETDATE year, month, day
Example of Use	SETDATE 92, 12, 1
Description	<ul style="list-style-type: none">• year is the low-order two digits of A.D (0 to 99).• month is a numeric value from 1 to 12.• day is a numeric value from 1 to 31.• If an unexisting year, month, or day is specified, an error occurs.• The day of the week is automatically set based on preset year, month and day.• Once date is set using the SETDATE command in a model with a battery backup calendar IC (GC56LC or GC55EM), the date is updated even while the power is off. If a model with no calendar IC (GC53LC or GC53LM) is turned off, the date is initialized to January 1, 1998 (Thursday) and the time to 00:00:00 when it is turned on again. The date and time are updated while the power is on.
Related Item	DATE\$, GETDATE, GETDATE, SETTIME, TIME\$

Example of Program

```
evnt
  input type,id@,dat
  if type = 3 then
    y = 94
    m = 12
    d = 1
    setdate y, m, d
  endif
end evnt
```

SETLNEPLOT

Statement

Function	The SETLNEPLOT statement sets the display range of a line chart.
Format	SETLNEPLOT display-start-point, display-end-point
Example of Use	SETLNEPLOT 10, 50
Description	<ul style="list-style-type: none">• The SETLNEPLOT statement sets the display range of a line chart. Executing LINEDSP, LNEShift, or PRDSP after this display range has been set displays the line chart within the set range.• After LINEDSP, LNEShift, or PRDSP has been executed, the set display range is released and the entire range display status is set.• Line charts for which “Blink” or “On-and-Off” is specified are displayed within the entire range.• When different ranges are set for two or more line charts within 100 milliseconds, the last set range corresponds to the first line chart to be displayed. All other line charts are displayed.
Related Item	LINEDSP, LNEShift, PRDSP

Example of Program

```
evnt
  input type,id@,data
  SETLNEPLOT 20, 30
  lneshift (..lnegraph , 1,1, 40)
end evnt
```

SETSIO

Statement

Function	The SETSIO statement sets a non-protocol communication reception method.
Format	SETSIO port-number, value
Example of Use	SETSIO 2 , &HD
Description	<ul style="list-style-type: none"> • The SETSIO statement sets the condition for issuing messages to BASIC of the part/screen when data is received in the non-procedural communication mode. • port-number specifies the port for which the non-procedural communication mode is to be set. • When the port specified in port-number is in the binary mode, value specifies the number of data to be received (in bytes). (0 cannot be specified.) When the port is in the text mode, value specifies a terminator code (1 to 0FFh) of the received data. • For the binary mode, specify the number of bytes to be received from the connecting device. When the specified number of bytes are received, a message is transmitted to the part/screen. • For the text mode, when a terminator code is received, a message is transmitted to the part/screen. A terminator code can be specified only by one byte. • The port to be set must be opened by the OPENSIO statement in advance.
Related Item	OPENSIO, CLOSESIO, WRITESIO, WRITWSIOB, FLUSH, IOCTL

Example of Program

```

conf
  global buf$ * 200
  opensio 2 , 1 , buf$
  SETSIO 2 , &HD
end conf
evnt
  strdsp ..STR000 , buf$
  closesio 2
end evnt

```

SETTIM

Statement

Function	The SETTIM statement sets the limit time of the specified timer.
Format	SETTIM timer-number, time-limit, timer-type
Example of Use	SETTIM ID@, 100, 0 SETTIM VAR, 200, 1
Description	<ul style="list-style-type: none"> • The SETTIM statement determines the operation of the specified timer. The timer must be stopped when it is set. • timer-number is the ID-type variable indicating the number of the timer whose operation is to be set or an integer-type value from 0 to 15. • The time specified in time-limit starts to be counted when operation of the specified timer is started. It is specified in units of 100 milliseconds. • timer-type specifies the type of timer to be set. Timers are classified into two types: normal and interval. The normal timer stops when the specified time limit is reached once. The interval timer restarts counting from 0 when the specified time limit is reached once. <ul style="list-style-type: none"> 0: Normal timer 1: Interval timer • If one second or lower is set as the time limit in the interval timer, messages may be accumulated to cause an error.
Related Item	OPENTIM, STARTTIM, STOPTIM, CLOSETIM, CONTTIM, READTIM

Example of Program

```

conf
  static timid@
  timid@ = opentim()
  SETTIM timid@, 20, 0
  starttim timid@
end conf
evnt
  input type% , id@ , data%
  if type% = 3 then
    tim% = readtim(timid@)
    numdsp ..NUM000,tim%*100
  end if
end evnt

```

SETTIME

Statement

Function	The SETTIME statement sets the time of the built-in clock.
Format	SETTIME hour, minute, second
Example of Use	SETTIME 12, 0, 0
Description	<ul style="list-style-type: none">• hour is a numeric value from 0 to 23.• minute is a numeric value from 0 to 59.• second is a numeric value from 0 to 59.• If an unexisting hour, minute, or second is specified, an error occurs.• Once time is set using the SETTIME command in a model with a battery backup calendar IC (GC56LC or GC55EM), time is updated even while the power is off. If a model with no calendar IC (GC53LC or GC53LM) is turned off, the date is initialized to January 1, 1998 (Thursday) and the time to 00:00:00 when it is turned on again. The date and time are updated while the power is on.
Related Item	DATE\$, GETDATE, GETDATE, SETDATE, TIME\%

Example of Program

```
evnt
  input type% , id@ , h% , m% , s%
  settime h% , m% , s%
end evnt
```

SHIFT

Statement

Function	The SHIFT statement shifts the contents of the specified variable left or right.
Format	SHIFT variable-name, shift-amount
Example of Use	SHIFT VARIABLE% , 1
Description	<ul style="list-style-type: none">• The SHIFT statement shifts the contents (bit string) of the specified variable by the specified amount left or right.• 0 is set in the positions of the bits vacated as a result of the shifting.• variable-name specifies the variable name used to shift the bit string; it must be an integer-type variable.• shift-amount specifies how much the bit string in the variable is to be shifted. A numeric value from 31 to -31 can be specified in shift-amount. When the specified shift amount is positive, the SHIFT statement shifts the bit string left. When it is negative, the SHIFT statement shifts the bit string right.
Related Item	None

Example of Program

```
conf
end conf
evnt
    input type% , id@ , data%
    numdsp ..NUM000 , data%
    shift data% , 1
    numdsp ..NUM000 , data%
end evnt
```

SIN

Function

Function	The SIN function calculates a sine for the specified numerical expression.
Format	SIN (numerical-expression)
Example of Use	X = SIN (ANGLE)
Description	<ul style="list-style-type: none">The SIN function calculates a sine value for the specified numerical expression. The unit for the numeric expression is radian.
Related Item	ATN, COS, TAN

Example of Program

```
evnt
  angle = 3.141592/3
  x = SIN ( angle )
  numdsp ..num000,x
end evnt
```

SLDDSP

Statement

Function	The SLDDSP statement displays data in the slide display.
Format	SLDDSP control-name, display-data
Example of Use	SLDDSP .BUHIN.GRAPH, 30.0
Description	<ul style="list-style-type: none">• control-name is the slide display name or the ID-type variable indicating the slide display.• display-data is numeric data indicating the display position of the point graphic to be displayed in the slide display.• display-value cannot be changed even if this statement is issued to the display for which operation parameters are set to “effective” in the control.
Related Item	None

Example of Program

```
evnt
  input type,id@,data
  SLDDSP ..SLD000, data
end evnt
```

SOF

Function

Function	The SOF function calculates the size of a field.
Format	SOF (file-number)
Example of Use	AAA = SOF (file-number)
Description	<ul style="list-style-type: none">file-number is the file number defined in the FIELD declaration. This size becomes the size of the file to be actually read or written.The size is calculated in bytes.
Related Item	FOPEN, FIELD, FCLOSE, FPUT, FGET, EOF

Example of Program

```
conf
  field 5
    global no%
    global moji1$ , moji2$
  end field
  global buff$ * 50
  opensio 1 , 0 , buff$
  fopen ``C:TEST', 2 , 5
end conf
evnt
  no% = 1
  moji1$ = ``product-name''
  moji2$ = ``product-number''
  size% = SOF(5)
  mcpy 5 , buff$
  writesiob 1 , size% , buff$
end evnt
```

SQR

Function

Function	The SQR function calculates a square.
Format	SQR (numerical-expression)
Example of Use	X = SQR (Y)
Description	<ul style="list-style-type: none">• The SQR function calculates a square for the specified numerical expression. numerical-expression must be a numeric value greater than or equal to 0.
Related Item	None

Example of Program

```
evnt
  x = SQR ( a^2 + b^2 )
  numdsp ..NUM000, X
end evnt
```

STARTTIM

Statement

Function	The STARTTIM statement starts the operation of the specified timer.
Format	STARTTIM timer-number
Example of Use	STARTTIM ID@ STARTTIM VAR
Description	<ul style="list-style-type: none"> • The STARTTIM statement starts the operation of the specified timer. (The timer starts increment from 0.) • timer-number is the ID-type variable indicating the number of the timer that starts increment or an integer-type variable from 0 to 15.
Related Item	OPENTIM, STOPTIM, CONTTIM, CLOSETIM, SETTIM, READTIM

Example of Program

```

conf
  static timid@
  timid@ = opentim()
  settim timid@, 20, 0
  STARTTIM timid@
end conf
evnt
  input type% , id@ , data%
  if type% = 3 then
    tim% = readtim(timid@)
    numdsp ..NUM000,tim%*100
  end if
end evnt

```

STATIC

Statement

Function	The STATIC statement declares that static variables are to be used.
Format	STATIC variable-name [, variable-name ...]
Example of Use	STATIC VAR, XYZ(2,3), MOJI\$ * 20
Description	<ul style="list-style-type: none">• The STATIC statement declares that static variables are to be used. Static variables can be used only the declared program. These variables are initialized once when the power supply is turned on. The values of static variables used after the power supply has been turned on are retained.• A normal variable, an array variable, or a character string variable can be written in variable-name.• When an array or character variable is declared, the DIM and STRING statements need not be declared.

Related Item AUTO, BACKUP, DIM, GLOBAL, LOCAL, STRING

Example of Program

```
conf
  STATIC var%, float
  STATIC moji$ * 50, moji2(10) * 3
  STATIC xyz@(10,10)
end conf
```

STOP

Statement

Function	The STOP statement stops the execution of the program.
Format	STOP
Example of Use	STOP
Description	<ul style="list-style-type: none">• The STOP statement stops the execution of the program following this statement.
Related Item	RUN

Example of Program

```
evnt
  input type , id@, data
  if type = 3 and data = 0 then STOP
  numdsp ..NUM000, data
end evnt
```

STOPTIM

Statement

Function	The STOPTIM statement stops the increment operation of the specified timer.
Format	STOPTIM timer-number
Example of Use	STOPTIM ID@ STOPTIM VAR
Description	<ul style="list-style-type: none"> • The STOPTIM statement stops the increment operation of the specified timer. • timer-number is the ID-type variable indicating the number of the timer that stops increment or an integer-type variable from 0 to 15.
Related Item	OPENTIM, STARTTIM, CONTTIM, CLOSETIM, SETTIM, READTIM

Example of Program

```

conf
  static timid@
  timid@ = opentim()
  settim timid@, 20, 0
  starttim timid@
end conf
evnt
  input type% , id@ , data%
  if type% = 3 and data% = 1 then
    tim% = readtim(timid@)
    numdsp ..NUM000,tim%*100
  else
    STOPTIM timid@
  end if
end evnt

```

STR\$

Function

Function	The STR\$ function converts the specified numeric value to a character string.
Format	STR\$ (numerical-expression)
Example of Use	A\$ = STR\$(123)
Description	<ul style="list-style-type: none">• An integer- or floating point-type numerical expression can be specified in numerical-expression.• When the numeric value specified in numerical-expression is negative, “-“ is added to the beginning of the character string.
Related Item	VAL

Example of Program

```
evnt
  input type, id@,data
  a$ = STR$ ( data )
  strdsp ..hyojiki , a$
end evnt
```

STRCOLOR

Statement

Function	The STRCOLOR statement changes the colors and background figure of the character display.
Format	STRCOLOR control-name, character-display-color, tile, display-color, background-color
Example of Use	STRCOLOR ..GRAPH, 1, 2, 5, 2
Description	<ul style="list-style-type: none"> • The STRCOLOR statement changes the background tile and colors of the character display. -1 indicates that the color and tile for which -1 was specified remain unchanged. • control-name is the character display name or the ID-type variable indicating the character display. • character-display-color indicates the color in which characters are displayed. Specify this character display color with a numeric value from 0 to 15. • tile indicates the background tiling figure of the character display. Specify this tiling figure with a numeric value from 0 to 15. • display-color is the numeric value indicating the color number of the tile display section. Specify this color number with a numeric value from 0 to 15. • background-color is the numeric value indicating the color number of the tile background section. Specify this color number with a numeric value from 0 to 15.
Related Item	STRDSP, STRFORM

Example of Program

```

conf
  static name@
  name@ = ..STR000
end conf
evnt
  input type%, id@, data%
  if type% = 3 then
    STRCOLOR name@, 2, -1,-1,-1
  endif
end evnt

```

STRDSP

Statement

Function	The STRDSP statement displays data in the character display.
Format	STRDSP control-name, display-data
Example of Use	STRDSP .BUHIN.GRAPH, "ABCDEF"
Description	<ul style="list-style-type: none">• The STRDSP statement displays data in the character display.• control-name is the character display name or the ID-type variable indicating the character display.• display-data is character data to be displayed in the character display.• display-value cannot be changed even if this statement is issued to the display for which operation parameters are set to "effective" in the control.
Related Item	STRCOLOR, STRFORM

Example of Program

```
conf
  static name@
  name@ = ..STR000
end conf
evnt
  input type%, id@, data$
  STRDSP name@, data$
end evnt
```

STRFORM

Statement

Function	The STRFORM statement changes the display method of the character display.
Format	STRFORM control-name, display-method
Example of Use	STRFORM ..HYOJIKI, 0
Description	<ul style="list-style-type: none">• The STRFORM statement changes the display method of the character display.• control-name is the character display name or the ID-type variable indicating the character display.• display-method is the numeric value indicating any of the following three display methods:<ul style="list-style-type: none">0: Left-justification method1: Centering method2: Right-justification method
Related Item	STRCOLOR, STRDSP

Example of Program

```
evnt
  input type , id@,data
  var@ = .buhin.moji
  STRFORM var@ , data
  strdsp var@ , "ABCDEFGF"
end evnt
```

STRING

Statement

Function The STRING statement specifies the size of the character string variable to be used.

Format STRING variable-name * size [variable-name * size]

Example of Use STRING MOJI\$ * 50

Description

- The STRING statement is used to specify a size of a local character string variable.
- The STRING statement is adopted to maintain the compatibility with GCSGP3. Use LOCAL, instead of STRING, in Screen Creator 5.
- The default size of the character string variable is 20 bytes. Use the STRING statement to use a variable whose size is greater than 20 bytes. The character string variable must be declared before it is used.
- variable-name must end with \$.
- Specify size with an integer value.
- Two or more character string variable can be specified in one line, delimited by a comma (,).

Related Item GLOBAL, STATIC, BACKUP, LOCAL

Example of Program

```
conf
  string xxx$ * 40
  string moji$ * 50
end conf
```

SWFIG

Statement

Function	The SWFIG statement sets the graphic to be displayed when the status of the specified switch changes.
Format	SWFIG switch-name, display-graphic, status, sub-ID
Example of Use	SWFIG ..SW1, FIG3, 0, 0
Description	<ul style="list-style-type: none"> • The SWFIG statement specifies the graphic to be displayed in the specified switch when the switch changes from the ON status to the OFF status. Both the unit switch and selector switch can be used. When the selector switch is used, its sub-ID must be specified. • switch-name is the name assigned to the switch or the ID-type variable indicating the name. • display-graphic is the graphic name or the ID-type variable indicating the name. • status is the integer value indicating whether the graphic is displayed when the switch status is ON or OFF. <ul style="list-style-type: none"> 0: The graphic is displayed when the switch status is OFF. 1: The graphic is displayed when the switch status is ON. • sub-ID is required when the selector switch is used. Specify the sub-switch number of the selector switch in sub-ID. The sub-switch number in the upper left end is assigned 1. The sub-switch numbers increase in the right direction. They decrease in the downward direction. (Specify 0 in sub-ID when the selector switch is not used.)
Related Item	None

Example of Program

```

conf
  static figid@,subid,onoff
  figid@ = FIG03
  subid = 3
  onoff = 1
end conf
evnt
  input type,id@,data
  if type = 3 and id@ = ..SWT000 then
    SWFIG id@ , figid@ , onoff , subid
  endif
end evnt

```

SWMODE

Statement

Function	The SWMODE statement modifies the status of the specified switch.
Format	SWMODE switch-name, mode
Example of Use	SWMODE ..SW1, 2
Description	<ul style="list-style-type: none">• switch-name is the name of the switch whose status is to be modified or the ID-type variable indicating the switch.• mode indicates the status to be modified.<ul style="list-style-type: none">0: Normal status1: Input disable status2: Half tone status
Related Item	None

Example of Program

```
evnt
  input type,id@,data
  if type = 3 then
    SWMODE ..sw2 , 1
    SWMODE var@ ,2
  end if
end evnt
```

SWREAD

Function

Function	The SWREAD function reads the status of the specified switch.
Format	SWREAD (switch-name)
Example of Use	STATE = SWREAD (..SW1)
Description	<ul style="list-style-type: none"> • The SWREAD function reads the status (ON or OFF) of the specified switch. • switch-name is the name assigned to the switch or the ID-type variable indicating the name. • The CONF and part CONF block of the global screen cannot be used in the switch primitive where operation parameters are valid. • The SWREAD statement cannot read the synchronous switch status of an undisplayed screen. • As a result of executing this function, the status of normal switches is indicated by the following numeric values: <ul style="list-style-type: none"> 0: OFF status 1: ON status • As a result of executing this function, the status of selector switches is indicated by the following numeric values: <ul style="list-style-type: none"> 0: All selector switches are OFF. Other values: Numbers of the sub-switches that are ON. (The sub-switch number in the upper left end is 1. The sub-switch numbers increase in the right direction. They decrease in the downward direction.)
Related Item	SWWRITE

Example of Program

```

evnt
  input type,id@,data
  id@ = ..SW2
  state = SWREAD (ID@)
  if state = 0 then
    swwrite id@,1
  endif
end evnt

```

SWREV

Statement

Function	The SWREV statement sets whether to reverse the display of the specified switch when the switch status changes.
Format	SWREV switch-name, operation
Example of Use	SWREV ..SW2, 0
Description	<ul style="list-style-type: none"> • The SWREV statement sets whether to reverse the display of the specified switch when the switch on the touch panel is pressed or the status is changed. • switch-name is the name assigned to the switch or the ID-type variable indicating the name. • The CONF and part CONF block of the global screen cannot be used in the switch primitive where operation parameters are valid. • operation indicates whether to reverse the display of the switch with the following numeric values: <ul style="list-style-type: none"> 0: The display of the switch is not reversed. 1: The display of the switch is reversed.
Related Item	None

Example of Program

```

evnt
  input type,id@,data
  if type = 3 and id@ = ..SWT000 then
    id@ = ..SW2
    SWREV id@,1
  endif
end evnt

```

SWWRITE

Statement

Function	The SWWRITE statement changes the status of the specified switch.
Format	SWWRITE switch-name, status
Example of Use	SWWRITE ..SW1, 1
Description	<ul style="list-style-type: none"> • The SWWRITE statement changes the status (ON or OFF) of the specified switch even if the switch on the touch panel is not pressed. When the status is changed, the data indicating the status is transmitted to the part program on which the switch is placed. • switch-name is the name assigned to the switch or the ID-type variable indicating the name. For multi-switches, it is necessary to set switch numbers in the offset and to get switch IDs using the GETID command. • status indicates that the normal switches are in any of the following statuses: <ul style="list-style-type: none"> 0: OFF status 1: ON status • status indicates that the selector switches are in any of the following statuses: <ul style="list-style-type: none"> 0: All selector switches are OFF. Other values: Numbers of the sub-switches that are ON. (The sub-switch number in the upper left end is 1. The sub-switch numbers increase in the right direction. They decrease in the downward direction.) • The numbers of multi-switches and selector switches are counted as 1, 2, 3 and so forth from the upper left switch. When all switches are counted in the X direction, the switches on the lower Y line are counted in the same way. They are integers. • When this statement is executed, a message is issued as a switch is pressed. • Executing the SWWRITE statement for the switch where synchronous operation is valid causes an error. • The SWWRITE statement is invalid for the switch of the momentary type.
Related Item	GETID,SWREAD

Example of Program

```
evnt
  input type,id@,data
  id@ = ..SW2
  state = swread (ID@)
  if state = 0 then
    SWWRITE id@,1
  endif
end evnt
```

TAN

Function

Function	The TAN function calculates a tangent for the specified numerical expression.
Format	TAN (numerical-expression)
Example of Use	X = TAN (ANGLE)
Description	<ul style="list-style-type: none">• The TAN function calculates a tangent value for the specified numerical expression. The unit for the numeric expression is radian.
Related Item	ATN, SIN, COS

Example of Program

```
evnt
  angle = 3.141592/3
  x = TAN ( angle )
  numdsp ..num000,x
end evnt
```

TIME\\$

Statement

Function	The TIME\$ statement reads the current time.
Format	TIME\$
Example of Use	A\$ = TIME\$
Description	<ul style="list-style-type: none">• The TIME\$ statement reads the current time with a character string of H:M:S format.• This statement cannot be used to set the current time.• Once time is set using the SETTIME command in a model with a battery backup calendar IC (GC56LC or GC55EM), time is updated even while the power is off. If a model with no calendar IC (GC53LC or GC53LM) is turned off, the date is initialized to 98-01-01 and the time to 00:00:00 when it is turned on again. The date and time are updated while the power is on.
Related Item	DATE\$, GETDATE, GETTIME, SETDATE, SETTIME

Example of Program

```
conf
  moji$ = TIME$
  strdsp ..STR000 , moji$
end conf
```

TIMID

Function

Function	The TIMID function changes an integer-type timer number to an ID-type timer number.
Format	TIMID (number)
Example of Use	AA@ = TIMID (VAR)
Description	<ul style="list-style-type: none"> number is the timer number (integer value) to be changed to an ID-type timer number.
Related Item	TIMINT, OPENTIM2

Example of Program

```

conf
  opentim2(2)
  settim 2 , 20, 0
  starttim 2
end conf
evnt
  input type,id@
  if id@ = timid(2) then
    .....
  end if
end evnt

```

TIMINT

Function

Function The TIMINT function changes an ID-type timer number to an integer-type timer number.

Format TIMINT (ID-number)

Example of Use VAR = TIMINT (ID@)

Description • ID-number is the ID-type timer number to be changed to an integer-type timer number.

Related Item TIMID, OPENTIM

Example of Program

```
evnt
  .....
  id@=opentim()
  no = TIMINT (id@)
  chktim ( no )
  ....
end evnt
```

VAL/VAL2

Function

Function The VAL/VAL2 function converts the number specified in character-string to a numeric value.

Format VAL (character-string)
VAL2 (character-string)

Example of Use A = VAL ("123")
A = VAL2 ("123.45")

Description

- When the specified character string begins with a character other than +, -, 0 to 9, E and ., the VAL/VAL2 function returns 0.
- If the specified character string contains an unconvertible character, the VAL/VAL2 function converts the characters before it.
- When the VAL function is used to convert the number specified in character-string to a numeric value, the result becomes real type.
- When the VAL2 function is used to convert the number specified in character-string to a numeric value, the result becomes integer type.

Related Item STR\$

Example of Program

```
conf
  var = VAL ( "234" )
  numdsp ..NUM000 , var
end conf
```

WHILE ... WEND

Statement

Function The instructions between the WHILE and WEND statements are executed while the specified conditional expression is true (satisfactory).

Format WHILE conditional-expression
.....
WEND

Example of Use WHILE X > 0
....
WEND

Description

- When the specified conditional expression is true, the instructions between the WHILE and WEND statements are executed. When it becomes false, the instructions following the WEND statement are executed.

Related Item IF ... THEN ... ELSE

Example of Program

```
conf
  static var(10)
  WHILE i% < 10
    var(i%) = i% * 5
  WEND
end conf
```

WRITESIO/WRITESIOB

Statement

Function	The WRITESIO and WRITESIOB statements write transmission data to a non-procedural communication transmission buffer.
Format	WRITESIO port-number, variable-name WRITESIOB port-number, number-of bytes, variable-name
Example of Use	WRITESIO 2 , moji\$ WRITESIOB 2 , 20 , moji\$
Description	<ul style="list-style-type: none"> • The WRITESIO statement writes transmission data to a non-procedural communication transmission buffer (serial port) in the text mode. The WRITESIOB statement writes transmission data to the same buffer (serial port) in the binary mode. • port-number specifies the channel (CH1 to CH3) to which transmission data is to be written with a numeric value from 1 to 3. • Of the transmission data written to the variable specified by variable-name, number-of-bytes specifies the number of bytes to be transmitted (valid when the binary mode is used). • variable-name specifies the name of the variable to which transmission data is written. • In the text mode, the written data is transmitted till the code (0h) indicating the end of the character string is detected. (That is, data from 1 to 0FFh can be transmitted. No terminator code is automatically inserted into the end of data.) • In the binary mode, all data (0 to 0FFh) can be transmitted. • The port to which transmission data is to be written must be opened by the OPENSIO statement in advance.
Related Item	OPENSIO, CLOSESIO, WRITESIO, WRITWSIOB, SETSIO

Example of Program

```

conf
  global buf$ * 200
  opensio 2 , 1 , buf$
  setsio 2 , &HD
end conf
evnt
  sendbuf$ = ``ABCDEFGF``
  WRITESIO 2 , sendbuf$
  closesio 2
end evnt

```

--