

---

# **E5810B**

## **LAN/GPIB/USB Gateway**

THIS PAGE HAS BEEN INTENTIONALLY LEFT BLANK.

## Table of Contents

Standard Shipped Items .....	5
Front Panel at a Glance .....	6
Back Panel at a Glance .....	6
Before Installing the E5810B .....	7
Check your PC .....	7
Rack-mount the E5810B (optional) .....	7
E5810B related documentation .....	8
Installing the E5810B .....	9
Connect the E5810B to the network .....	9
Network information .....	10
Power-on the E5810B .....	12
Configuring the E5810B .....	13
Display the E5810B Welcome page .....	13
Verify instrument communication .....	14
Configure the E5810B using a local network .....	15
Configuring Instruments via IO Libraries Suite .....	17
Install Keysight IO Libraries Suite .....	17
Configure a remote GPIB interface .....	18
Configure a remote USB interface .....	20
Configure a remote RS-232 serial interface .....	21
Verify instrument communication .....	22
Troubleshooting the E5810B .....	23
Check the E5810B LED indicators .....	23
Check the network .....	23
Check the connected instruments .....	24

THIS PAGE HAS BEEN INTENTIONALLY LEFT BLANK.

## Standard Shipped Items

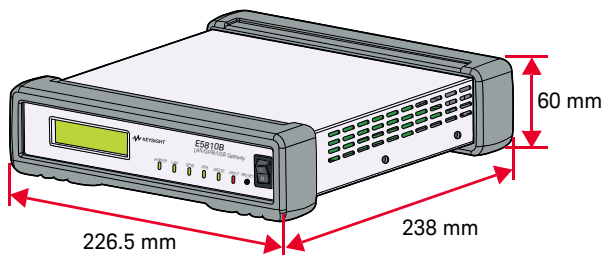

**Keysight E5810B LAN/GPIB/USB Gateway**



Power cord and adapter

Note: The shipped power adapter is with p/n 0950-6484.

# Front Panel at a Glance

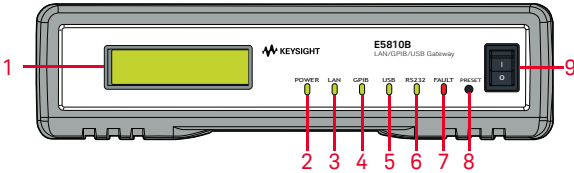

- |                              |                               |
|------------------------------|-------------------------------|
| <b>1</b> Front panel display | <b>6</b> RS-232 LED indicator |
| <b>2</b> Power LED indicator | <b>7</b> FAULT LED indicator  |
| <b>3</b> LAN LED indicator   | <b>8</b> Preset button        |
| <b>4</b> GPIB LED indicator  | <b>9</b> Power ON/OFF switch  |
| <b>5</b> USB LED indicator   |                               |

# Back Panel at a Glance

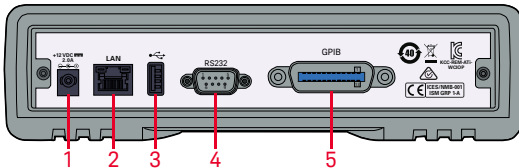

- |                        |                      |
|------------------------|----------------------|
| <b>1</b> DC power port | <b>4</b> RS-232 port |
| <b>2</b> LAN port      | <b>5</b> GPIB port   |
| <b>3</b> USB port      |                      |

**NOTE** For the complete list of all the functions and descriptions, refer to *Chapter 1, “E5810B Description”* in the *E5810B User’s Guide*.

# Before Installing the E5810B

## Check your PC

The E5810B is supported on the following operating systems.

- Windows® XP
- Windows Vista®
- Windows 7
- Windows 8
- Windows 10
- Windows 11
- Windows Server 2008 R2
- Windows Server 2012

Microsoft® Internet Explorer 6 or greater is required (Internet Explorer 7 or greater is recommended for Windows Vista, Windows 7, Windows 8, Windows 10, Windows 11, Windows Server 2008 R2, and Windows Server 2012).

## Rack-mount the E5810B (optional)

You can mount the E5810B on a standard EIA rack using the Rack Mount Kit (E5810-00100) or equivalent. The E5810B is one standard half-rack unit wide and one standard rack unit high. Refer to the *Rack Mount Installation Note* ([E5810-99100](#)) for more information.

## E5810B related documentation

- *Keysight E5810B LAN/GPIB/USB Gateway User's Guide (E5810-90004)* contains more detailed information on the E5810B configurations, installation process, and troubleshooting.
- *Keysight IO Libraries Suite Quick Start Guide*<sup>[1]</sup> provides a description of the Keysight IO Libraries Suite.
- *Keysight IO Libraries Suite Help*<sup>[1]</sup> provides detailed usage information on the Keysight IO Libraries Suite.
- *Keysight VISA Help*<sup>[1]</sup> describes the Keysight Virtual Instrument Software Architecture (VISA) library.
- *Keysight SICL Help*<sup>[1]</sup> describes the Keysight Standard Instrument Control Library (SICL) for Windows.

[1] Click the IO icon on the Windows taskbar notification area and select **Documentation** to obtain the related documentation.



# Installing the E5810B

Connect the E5810B to the network

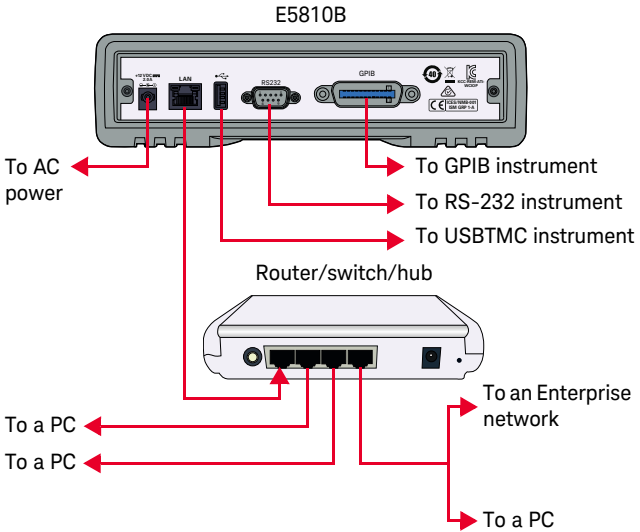

The figure above shows a typical network and instrument connections for the E5810B.

## NOTE

Before connecting the E5810B to an Enterprise network, you will need to get some network configuration and network addressing parameters from the system administrator in your IT department.

Refer to **“Network information”** on page 10 for the suggested steps.

## Network information

Before connecting the E5810B to an Enterprise network, obtain the E5810B serial number and Ethernet (MAC) address printed on a label at the bottom panel of the E5810B. Fill up the information in the **E5810B LAN/GPIB/USB Gateway Information** as shown below.

<b>E5810B LAN/GPIB/USB Gateway Information</b>	
<b>Serial number:</b>	_____
<b>Ethernet (MAC) address:</b>	_____
<b>Default values (for system administrator)</b>	<b>DHCP:</b> Enabled at power-on
	<b>Hostname:</b> No hostname configured

Provide this information to your system administrator and request for the Enterprise network information as shown below.

### Enterprise Network Information

Does the network support DHCP? Yes \_\_\_ No \_\_\_

If No, provide – IP address (static): \_\_\_\_\_

Subnet mask: \_\_\_\_\_

Gateway IP address: \_\_\_\_\_

Does the network support DNS? Yes \_\_\_ No \_\_\_

If Yes, provide – E5810B hostname: \_\_\_\_\_

DNS server (IP address) \_\_\_\_\_

#### NOTE

If the Enterprise network does not support DHCP, refer to “**Configure the E5810B using a local network**” on page 15 to configure the E5810B using a local network.

## Power-on the E5810B

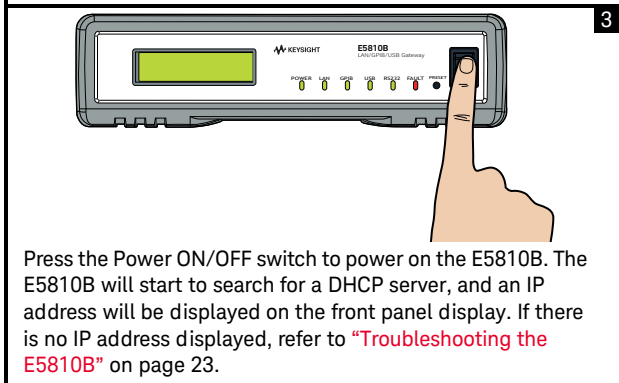
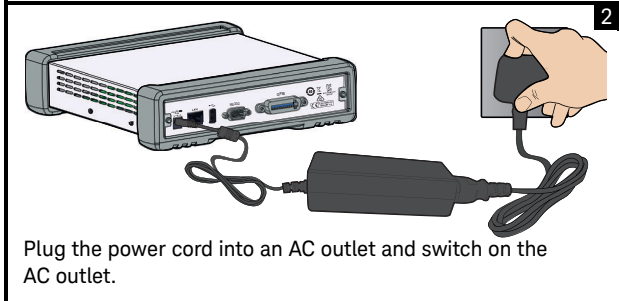
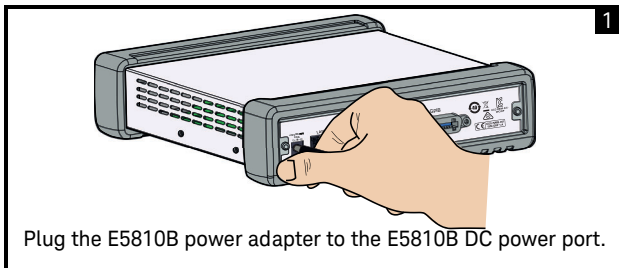

# Configuring the E5810B

Display the E5810B Welcome page

Go to your Web browser and type  
**http://<hostname>** or **http://<IP address>**  
at the address line.

**<hostname>** The host name (if known) of the E5810B.

**<IP address>** The current E5810B IP address (for example 169.254.58.10) is displayed on the E5810B front panel display.

Support | Products | Keysight Site

KEYSIGHT TECHNOLOGIES E5810B LAN/GPIB/USB Gateway

Another web-enabled product from Keysight Technologies

Welcome to your

### Web-Enabled E5810B LAN/GPIB/USB Gateway

Use the Navigation Bar on the left to access your E5810B

Your Current Settings are:

Ethernet (MAC) Address:	44:E8:A5:00:15:8D
Hostname:	Not Known
IP Address:	141.183.190.247
GPIB SIDL Interface Name:	gpib0
USB SIDL Interface Name:	usb0
RS-232 SIDL Interface Name:	COM1
Firmware Revision:	B.01.07_BETA_2
Serial Number:	MY54400014

E5810B Documentation:

- [Home](#)
- [User's Guide](#)

Supporting your I/O needs

## NOTE

If the E5810B Welcome page does not display correctly, you may need to change your Web browser settings.

Refer to *Chapter 4, "Checking the Web browser settings"* in the *E5810B User's Guide* for more information.

## Verify instrument communication

Select **Find & Query Instruments** from the E5810B Welcome page and enter the password. The default password is **E5810**.

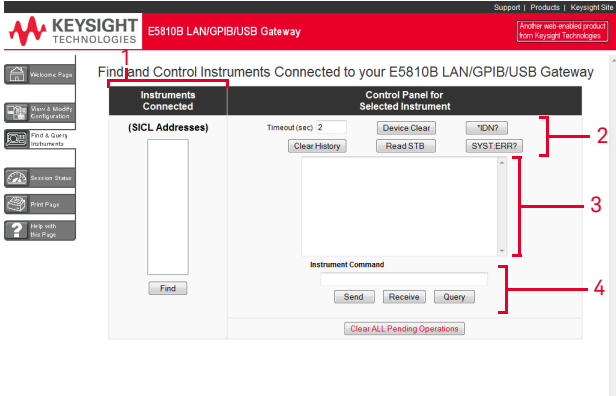

- 1 Select **Find** to list all the instruments connected to the E5810B. The selected connected instrument will be highlighted.
- 2 Select **Device Clear**, **\*IDN?**, **Read STB**, or **SYS:ERR?** to query the selected connected instrument.
- 3 Display the responses from the predefined queries and inputted commands.
- 4 Insert an instrument specific command in the **Instrument Command** line to interact with the connected instrument. Select **Send**, **Receive**, or **Query** as required.

## Configure the E5810B using a local network

If the Enterprise network does not support DHCP, the E5810B will use the default static IP address (169.254.58.10) when connected to the Enterprise network. This IP address may not be available on the Enterprise network.

For correct operation on a non-DHCP Enterprise network, you must first use a local network to configure the E5810B. There are two typical local network configurations as shown below.

### Local Network Using a Switch or Hub

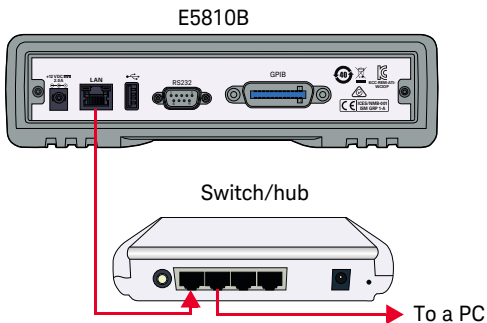

### Local Network Using a Crossover Cable

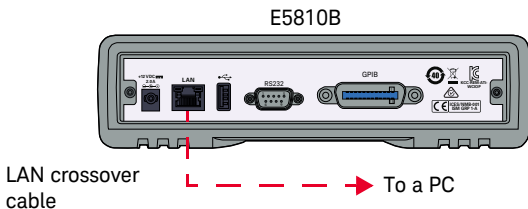

- 1 Select **View & Modify Configuration** from the E5810B Welcome page to display the E5810B current configuration.
- 2 Select **Modify Configuration** and enter the password to configure the E5810B. The default password is **E5810**.
- 3 Set the DHCP setting to **OFF**, and update the **IP Address**, **Subnet Mask**, and **Default Gateway** with the parameters provided by your system administrator in “**Network information**” on page 10.
- 4 If you are using Domain Name Server (DNS), enter the DNS IP address and hostname provided by your system administrator.
- 5 Select **Save** and then select **Reboot E5810B** to save the configuration.
- 6 Disconnect the E5810B from the local network and connect the E5810B to the Enterprise network.



# Configuring Instruments via IO Libraries Suite

## Install Keysight IO Libraries Suite

**NOTE**

**You must have Administrator privileges to install Keysight IO Libraries Suite Connection Expert.**

---

You should install the Keysight IO Libraries Suite as your first step before installing the hardware because it installs the necessary software and drivers to control your instruments.

If possible, always use the most recent version of the Keysight IO Libraries Suite. This version supports the newest interfaces and operating systems, and has the most advanced features.

- Refer to the IO Libraries Web page at [www.keysight.com/find/iosuite](http://www.keysight.com/find/iosuite) or the IO Libraries Suite Readme for the minimum system requirements.
- Download and install the IO Libraries software from [www.keysight.com/find/iosuite](http://www.keysight.com/find/iosuite).
- You will see the IO icon on the Windows taskbar notification area after the IO Libraries suite is successfully installed.

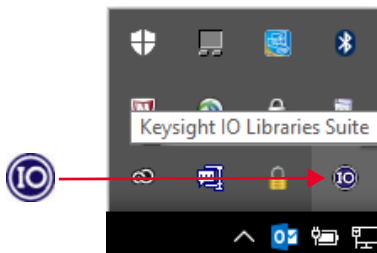

Configure a remote GPIB interface

- 1 Launch **Keysight Connection Expert** from the Start menu or the Start Screen.
- 2 Select **Add Interface > Remote GPIB** to display the Remote GPIB Interface dialog box.

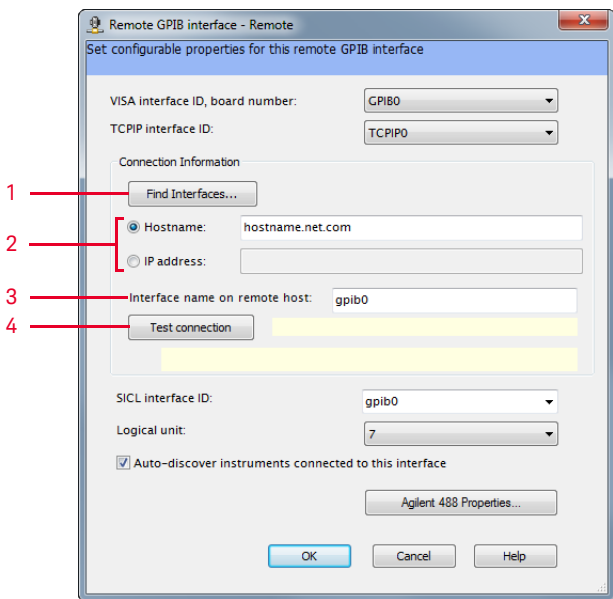

- 1 Locate the E5810B on the local subnet.
- 2 Insert the hostname or the IP address shown on the E5810B display to locate the E5810B if it is not located in the same subnet.
- 3 The interface name must be similar to the name shown in the GPIB SICL Interface Name at the E5810B Welcome page.
- 4 Verify the connectivity and configuration. A message will be displayed on the dialog box once the connection to the interface is established and verified.

## Configure a remote USB interface

- 1 Launch **Keysight Connection Expert** from the Start menu or the Start Screen.
- 2 Select **Add Interface > Remote USB** to display the Remote USB Interface dialog box.

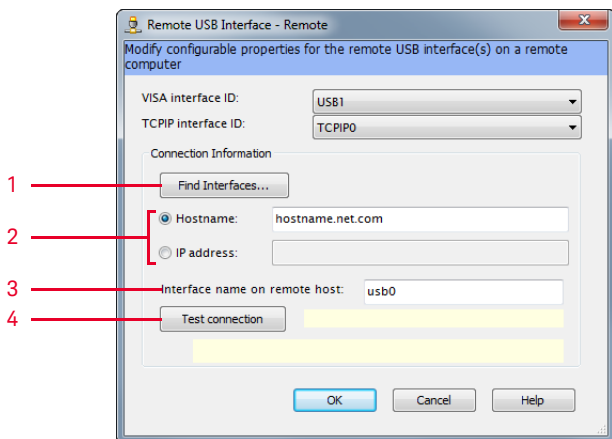

- 1 Locate the E5810B on the local subnet.
- 2 Insert the hostname or the IP address shown on the E5810B display to locate the E5810B if it is not located in the same subnet.
- 3 The interface name must be similar to the name shown in the USB SICL Interface Name at the E5810B Welcome page.
- 4 Verify the connectivity and configuration. A message will be displayed on the dialog box once the connection to the interface is established and verified.

## Configure a remote RS-232 serial interface

- 1 Launch **Keysight Connection Expert** from the Start menu or the Start Screen.
- 2 Select **Add Interface > Remote RS-232** to display the Remote RS-232 Serial Interface dialog box.

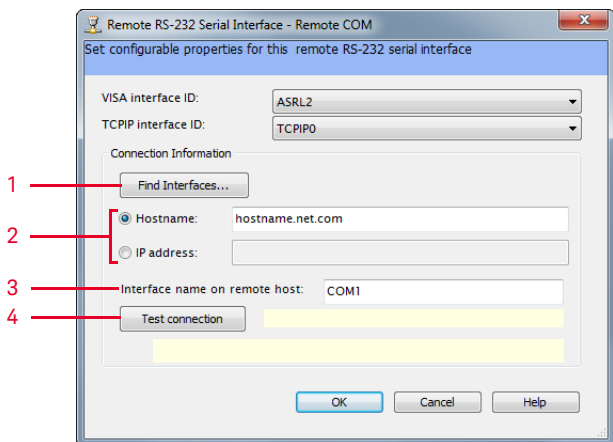

- 1 Locate the E5810B on the local subnet.
- 2 Insert the hostname or the IP address shown on the E5810B display to locate the E5810B if it is not located in the same subnet.
- 3 The interface name must be similar to the name shown in the RS-232 SICL Interface Name at the E5810B Welcome page.
- 4 Verify the connectivity and configuration. A message will be displayed on the dialog box once the connection to the interface is established and verified.

## Verify instrument communication

- 1 Launch **Keysight Connection Expert** from the Start menu or the Start Screen.
- 2 Right-click on the remote interface instrument and select **Send Commands To This Instrument** to display the Keysight Interactive IO dialog box.
- 3 Use the default command, **\*IDN?** and select **Send & Read** to query the remote interface instrument.
- 4 The remote interface instrument identification information will appear on the **Instrument Session History**.

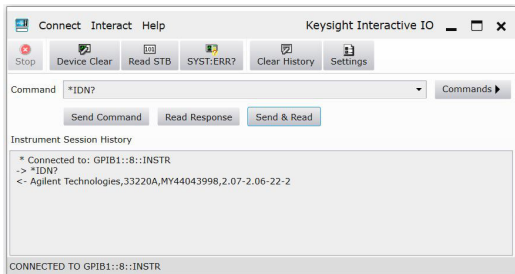

### NOTE

You can also program the remote interface instruments using Keysight VISA, VISA COM, or SIDL. Refer to [“E5810B related documentation”](#) on page 8 for more information.

# Troubleshooting the E5810B

## Check the E5810B LED indicators

Status	Possible cause	Corrective action
All LEDs OFF	No AC power to the E5810B.	Check the AC power connection.
Power – ON FAULT – ON	If the FAULT LED indicator is turned ON for more than 10 seconds, there may be hardware failure.	Contact Keysight for instructions to return the E5810B.
Power – ON LAN (back panel) – OFF	No communication from the PC to the E5810B using LAN.	Check the E5810B LAN connection.
Power – ON LAN – ON (flashes) GPIB, USB, and/or RS-232 – OFF (during instrument activity)	There is communication from the PC to the E5810B using LAN. However, there is no communication to the GPIB, USB, or RS-232 instruments.	Check the GPIB, USB, or RS-232 connection and configuration.

## Check the network

Symptom	Possible cause	Corrective action
Cannot access E5810B Web access	Improper network installation.	Check the network installation or contact your system administrator.
	Missing or improper setup of network addresses.	Refer to <b>“Network information”</b> on page 10.

Symptom	Possible cause	Corrective action
	Incorrect Web browser settings.	Refer to <i>Chapter 4, "Checking the Web browser settings"</i> in the <i>E5810B User's Guide</i> for more information.
Incorrect password.	Unknown or forgotten password.	Press the <b>Preset</b> button >10 seconds to reset the E5810B to the factory default settings.

### Check the connected instruments

Symptom	Possible cause	Corrective action
Unable to communicate from the E5810B Web access	Intermittent or missing GPIB, USB, and/or RS-232 connection.	Check the GPIB, USB, and/or RS-232 cable.
	GPIB, USB, and/or RS-232 device power is not turned on or a defective GPIB, USB, and/or RS-232 device.	Ensure that the GPIB, USB, and/or RS-232 device power is turned on and the device is operating properly.
	RS-232 interface is not configured for the attached device.	Change the E5810B RS-232 interface attributes to match the RS-232 device attributes (baud rate and parity).
Unable to communicate programmatically	VISA/SICL is not configured.	Refer to the <i>E5810B User's Guide</i> for more information.
	Incorrect VISA/SICL address.	Check the VISA/SICL address being used.



This information is subject to change without notice. Always refer to the Keysight website for the latest revision.

© Keysight Technologies  
2013, 2015, 2017, 2023  
Edition 4, November 2023

Printed in Malaysia



E5810-90002

[www.keysight.com](http://www.keysight.com)