

A Guide to Scanning Microscope Observation



A Guide to Scanning Microscope Observation

Table of contents

Preface	3
1. Types of Image Disturbances	4
2. Image Changes Caused by Interactions Between Electron Probe and Specimen	5
2-1 Influence of accelerating voltage on image quality	5
2-2 Probe current, probe diameter and image quality	8
2-3 Influence of edge effect on image quality	9
2-4 Use of specimen tilt	10
a) Dependence of image quality on tilt angle	10
b) Stereo micrographs	10
c) Detector position and specimen direction	11
2-5 Use of backscattered electron signals	12
2-6 Influence of charge-up on image quality	14
a) Charge-up and countermeasures against it	14
b) Prevention of charge-up by sampling	15
2-7 Specimen damage by electron beam	16
2-8 Contamination	17
3. The Influence on Images, of Operational Technique, Specimen Preparation Technique, External Disturbances, Etc	18
3-1 Working distance and objective aperture	18
a) Influence of working distance on images	18
b) Influence of objective aperture diameter on images	18
3-2 Influence of astigmatism	20
3-3 Optimum contrast and brightness of micrographs	22
3-4 Exposure time for X-ray images	23
3-5 Influence of external disturbances on images	24
3-6 Deformation and impurity precipitation during specimen preparation process	25
3-7 Image distortion and its cause	26
3-8 Coating	28
a) Sputtering device	28
b) Vacuum evaporator	28
4. Disturbances Caused by Instrumental Defects	30
4-1 Insufficient filament heating	30
4-2 In correct alignment and centering of objective aperture	31
4-3 10 kV discharge of detector	32
4-4 Burnt or dusty CRT	33
Technical terms	34
Closing words/References	35

Preface

Today, the scanning electron microscope (hereinafter abbreviated to SEM) is utilized not only in medical science and biology, but also in diverse fields such as materials development, metallic materials, ceramics, and semiconductors.

This instrument is getting easier to use with the progress of electronics and introduction of new techniques. Anybody can now take micrographs after short-time training in its operational procedure. However, when one has begun to use the instrument, he cannot always take satisfactory photos. When the photo is not sharp enough, or when necessary information cannot be obtained, it is necessary to think what causes it.

To help make a correct judgment in such a case, the first edition of "A Guide to Scanning Microscope Observation" was published and it has since been used by many people. Today, when several years have passed since the publication of the first edition, some parts of the edition need amendment with instrumental improvements. This is the reason why we bring this revised edition to you.

We included in this book as many application examples as possible so that they can be used as criteria for judging what causes unsatisfactory image factors (hereinafter referred to as image disturbances). Although this edition does not describe all about image disturbances, it carries application photos to allow you to consider their causes. It is also important to correctly select the optimum observation conditions for various specimens. For instance, this book carries matters which are considered to be useful for using the instrument, such as the accelerating voltage, probe current and working distance (hereinafter abbreviated to WD).

We shall be pleased if this publication is of help to people who are now using or going to use SEMS.

1. Types of Image Disturbances

Image disturbances, though diverse in types, can be classified by the following expressions:

- 1) Images lacking sharpness and contrast
- 2) Unstable images
- 3) Generally poor-quality images
- 4) Noisy images
- 5) Images showing jagged edges
- 6) Unusual-contrast images
- 7) Distorted or deformed images.

The above-listed image disturbances, besides being attributed to defects in the instrument itself, are occasionally caused by the operator's lack of experience, improper specimen preparation and external influences such as the installation room conditions. Table 1 shows various image disturbances and their causes.

In this booklet, how image disturbances appear is studied on

the basis of the data available at hand, for cases such as the following:

- 1) The mutual interaction between the specimen and the electron beam involves a problem.
- 2) Selection of observation conditions and specimen preparation involve a problem.
- 3) The instrument itself involves a problem.

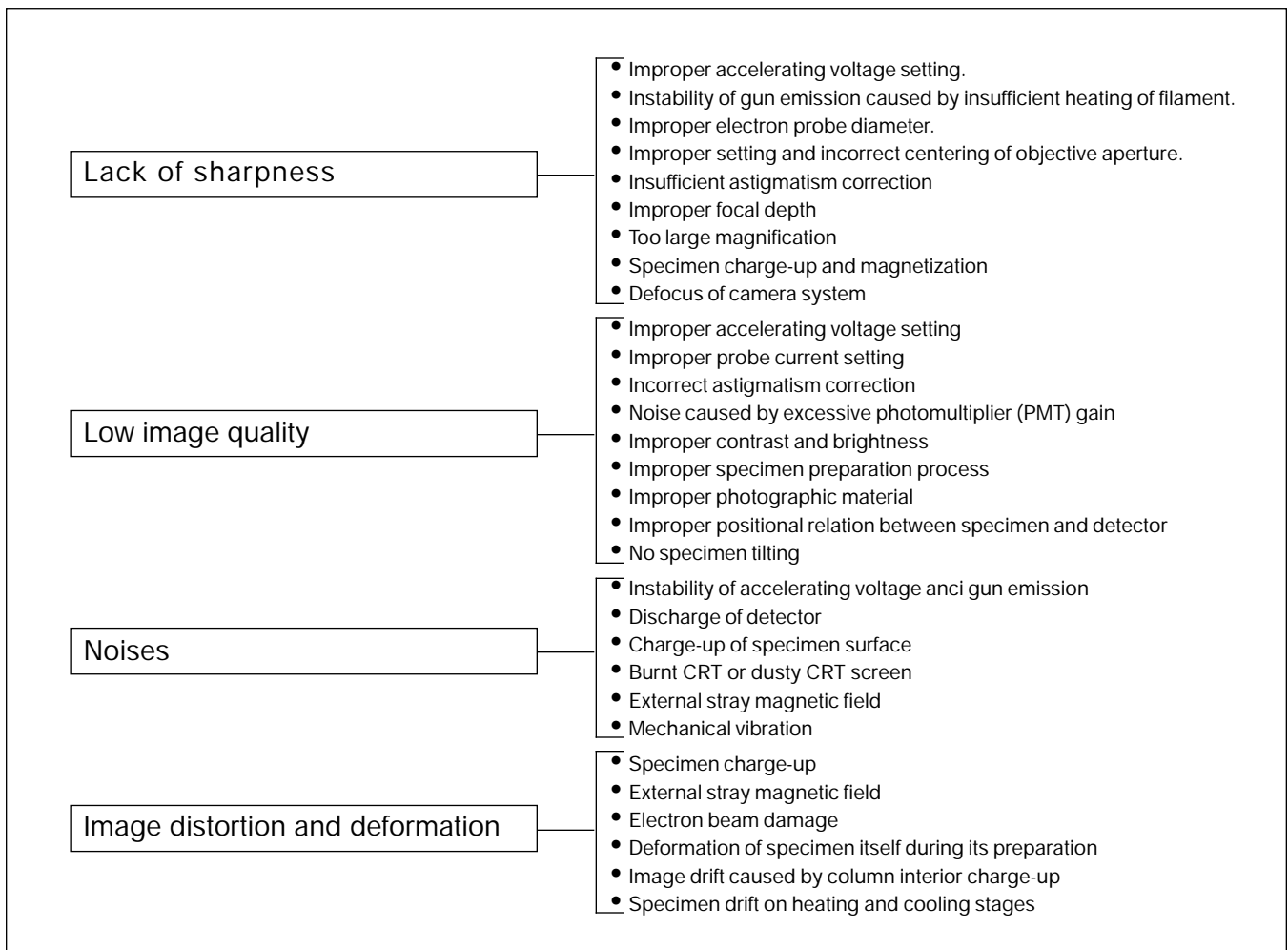

Table 1. Image Disturbances and Their Causes

2. Image Changes Caused by Interactions Between Electron Probe and Specimen

2-1. Influence of accelerating voltage on image quality

When theoretically considering the electron probe diameter alone, the higher the accelerating voltage, the smaller is the electron probe. However, there are some unnegligible demerits in increasing the accelerating voltage. They are mainly as follows:

- 1) Lack of detailed structures of specimen surfaces.
- 2) Remarkable edge effect.
- 3) Higher possibility of charge-up.
- 4) Higher possibility of specimen damage.

In SEM, finer surface structure images can generally be obtained with lower accelerating voltages. At higher accelerating voltages, the beam penetration and diffusion area become larger, resulting in unnecessary signals (e.g., backscattered electrons) being generated from within the specimen. And these signals reduce the image contrast and veils fine surface structures. It is especially desirable to use low accelerating voltage for observation of low-concentration substances.

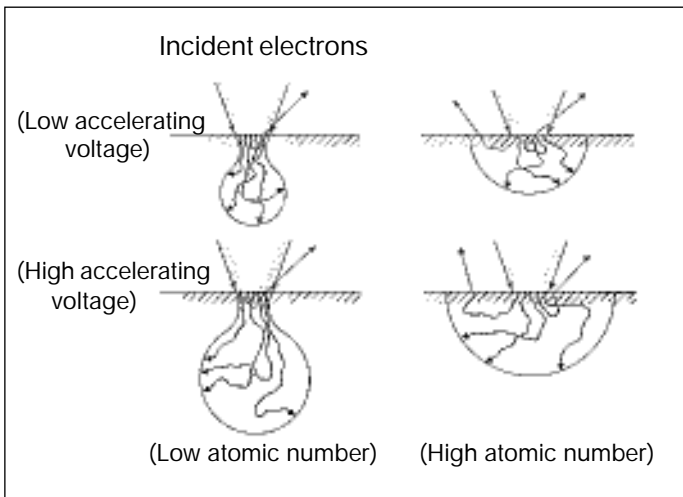

Fig. 1 Diffusion of incident electrons (after Ducumb and Shields).

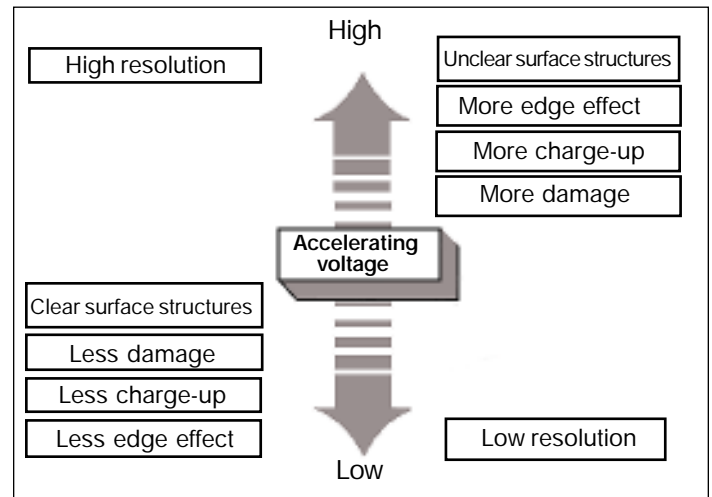

Fig. 2 Effect of accelerating voltage.

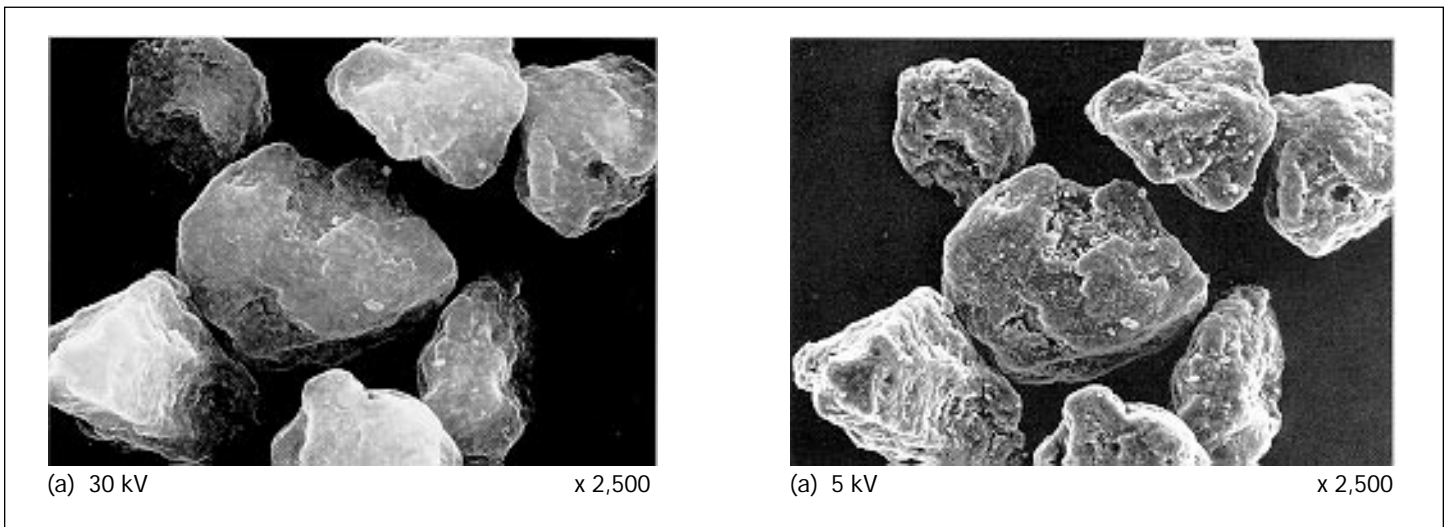
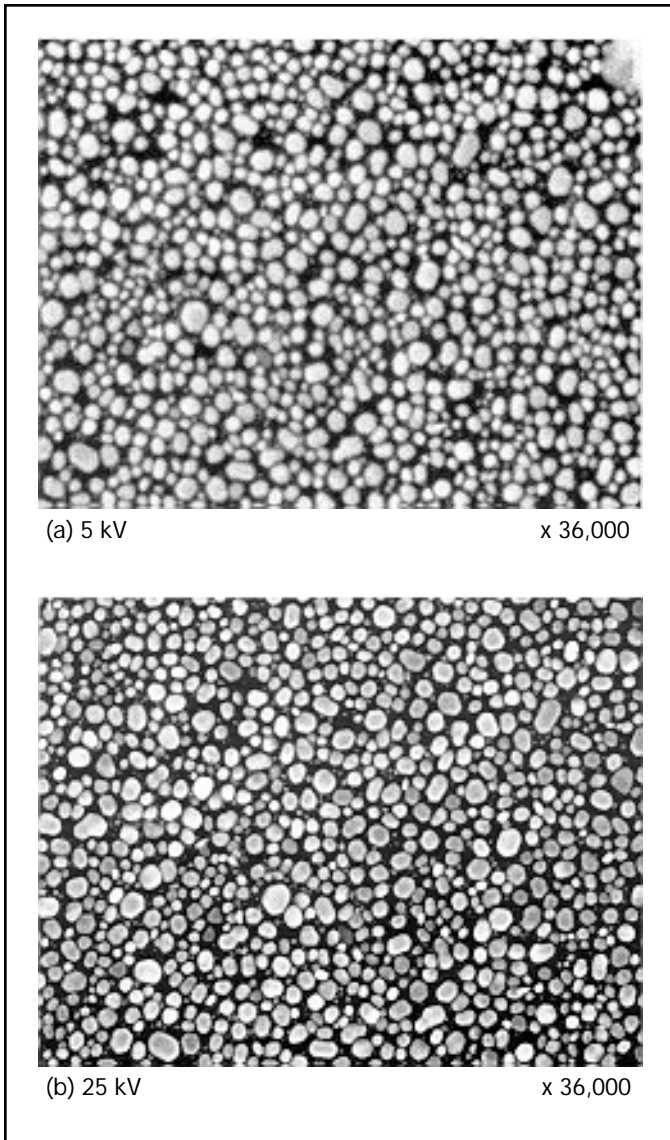
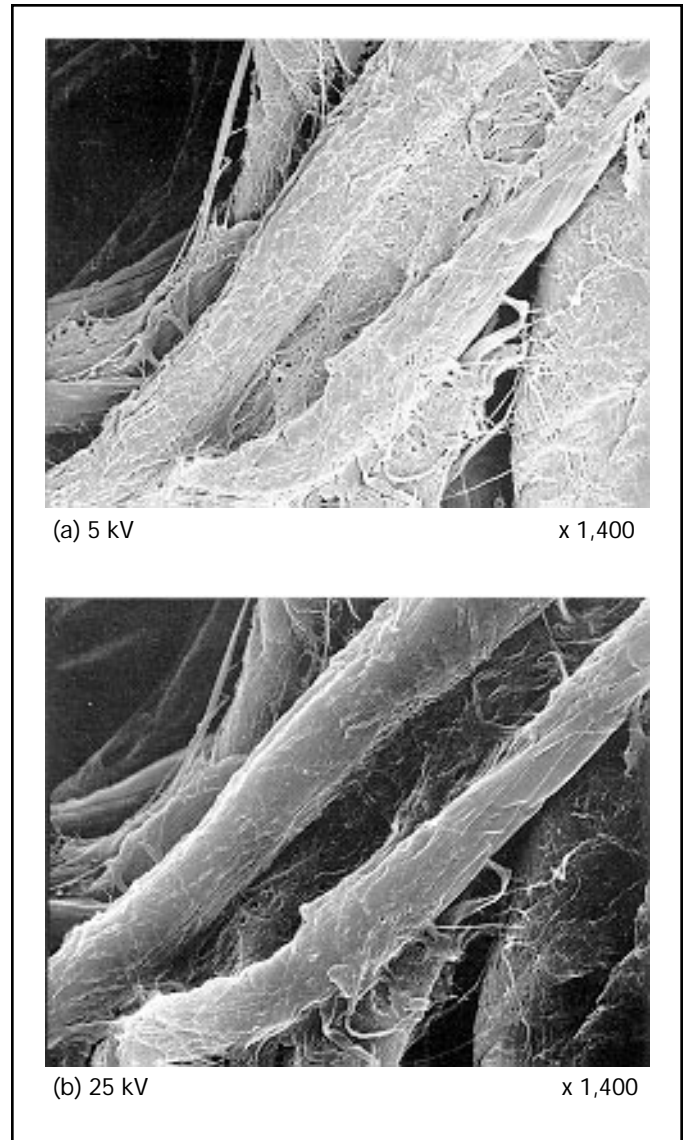

Fig. 3 Specimen: Toner
When high accelerating voltage is used as at (a), it is hard to obtain the contrast of the specimen surface structure. Besides, the specimen surface is easily charged up. The surface microstructures are easily seen at (b).



*Fig. 4 Specimen: Evaporated Au particles.
The image sharpness and resolution are better
at the higher accelerating voltage, 25 kV.*



*Fig. 5 Specimen: Filter paper.
At 5 kV, the microstructures of the specimen
surface are clearly seen as the penetration and
diffusion area of incident electrons is shallow.*

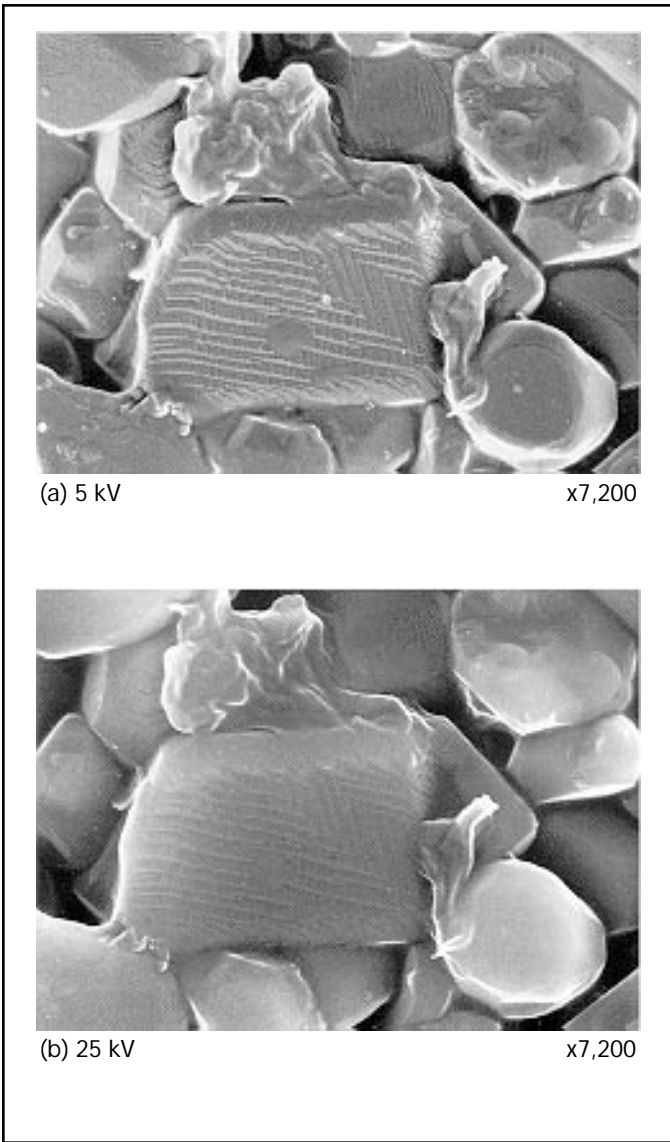

Fig. 6 Specimen: Sintered powder. At low accelerating voltage, while surface microstructures can be observed, it is difficult to obtain sharp micrographs at high magnifications. In such a case, clear images can be obtained by shortening the WD or reducing the electron probe diameter.

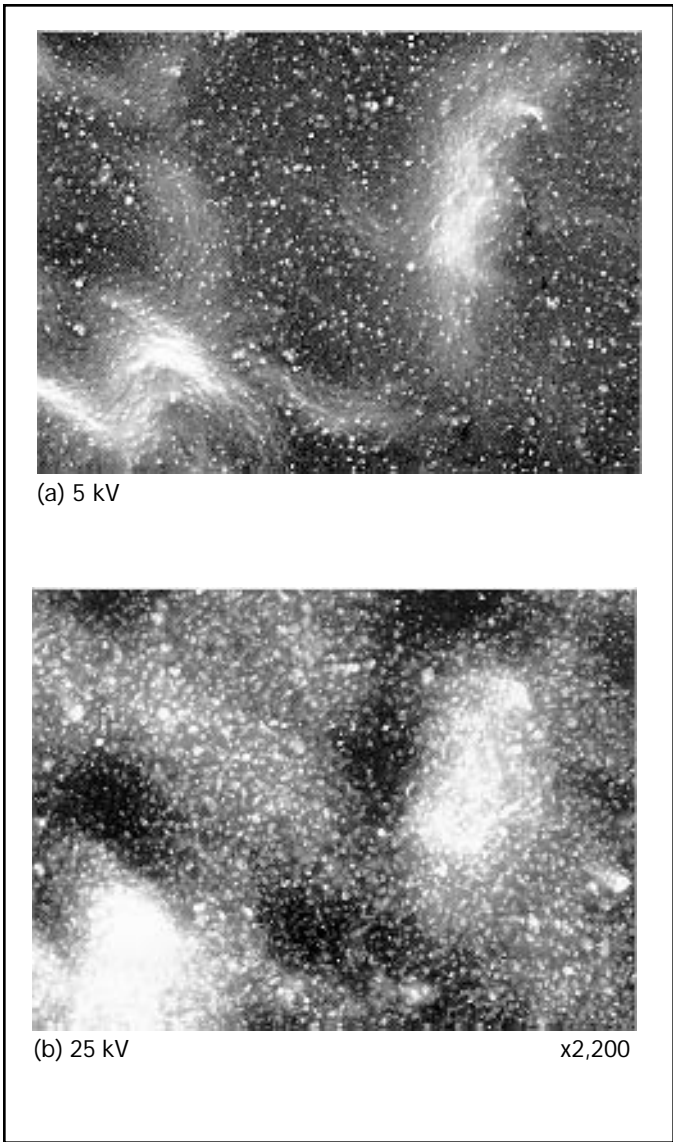

Fig. 7 Specimen: Paint coat. When a high accelerating voltage is used, more scattered electrons are produced from the constituent substances within the specimen. This not only eliminates the contrast of surface microstructures, but produces a different contrast due to backscattered electrons from the substances within the specimen.

2-2. Probe current, probe diameter, and image quality

In the SEM, the smaller the electron probe diameter on the specimen, the higher the magnification and resolution. However, the image smoothness, namely, the S/N ratio depends on the probe current. The probe current and the probe diameter are in the relation shown in Fig. 8. Namely, as the probe diameter is reduced, the probe current is reduced.

It is therefore necessary to select a probe current suited for the magnification and observation conditions (accelerating voltage, specimen tilt, etc.) and the specimen.

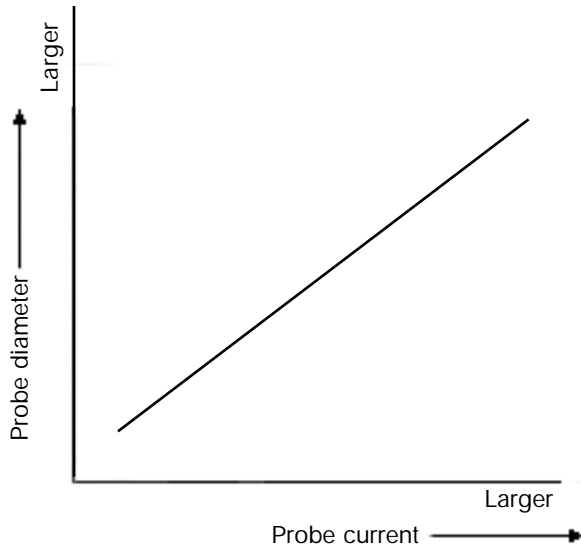
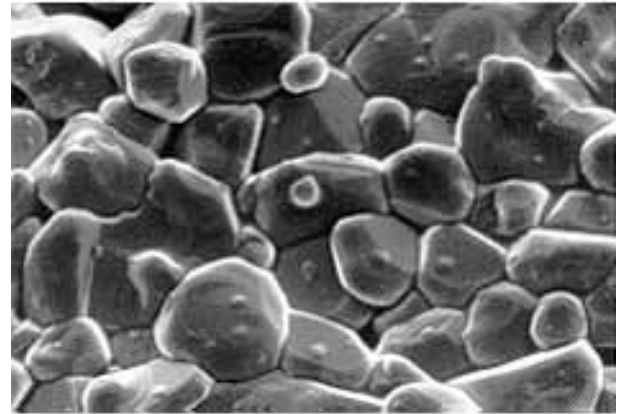
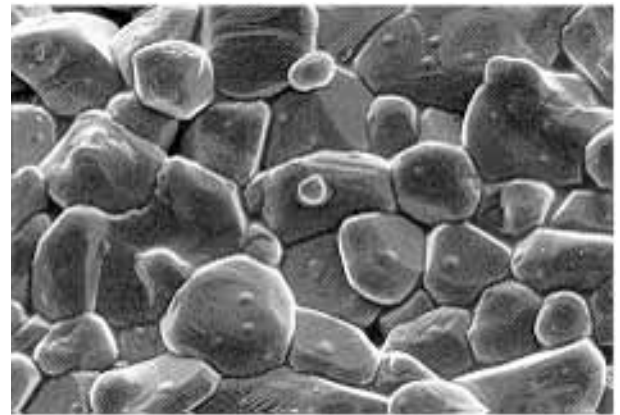

Fig. 8 Relationship between probe current and probe diameter.



(a) 1 nA



(b) 0.1 nA

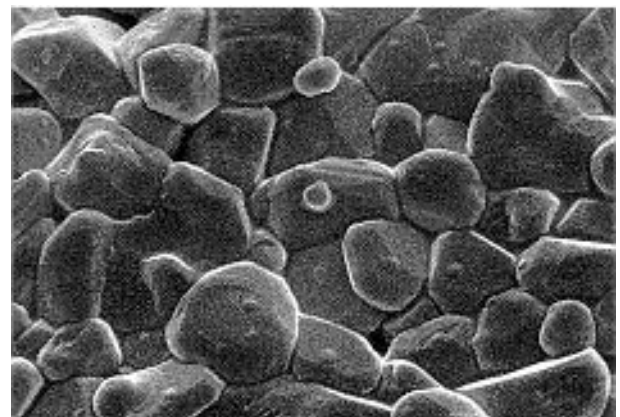

(c) 10 pA

Fig. 10. Specimen: Ceramic.
10 kV x 5,400
The smaller the probe current, the sharper is the image, but the surface smoothness is lost.

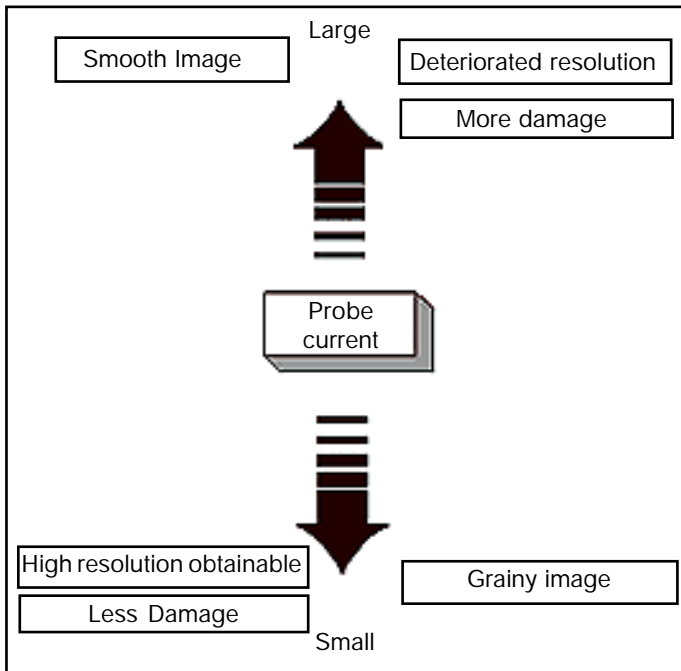

Fig. 9 Effect of probe current.

2-3. Influence of edge effect on image quality

Among the contrast factors for secondary electrons, the tilt effect and edge effect are both due to the specimen surface morphology. Secondary electron emission from the specimen surface depends largely on the probe's incident angle on the specimen surface, and the higher the angle, the larger emission is caused. The objects of the SEM generally have uneven surfaces. There are many slants all over them, which contribute most to the contrast of secondary electron images.

On the other hand, large quantities of secondary electrons are generated from the protrusions and the circumferences of objects on the specimen surface, causing them to appear brighter than even portions.

The degree of the edge effect depends on the accelerating voltage. Namely, the lower the accelerating voltage, the smaller the penetration depth of incident electrons into the specimen. This reduces bright edge portions, thus resulting in the microstructures present in them being seen more clearly.

Normally, secondary electron images contain some backscattered electron signals. Therefore, if the tilt direction of the specimen surface and the position of the secondary electron detector are geometrically in agreement with each other, more backscattered electrons from the tilted portions are mixed, causing them to be seen more brightly due to synergism.

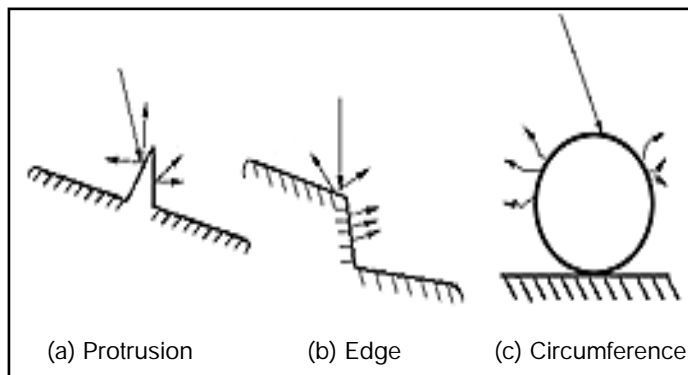

Fig. 11. Edge effect (secondary electron emission differing with surface condition).

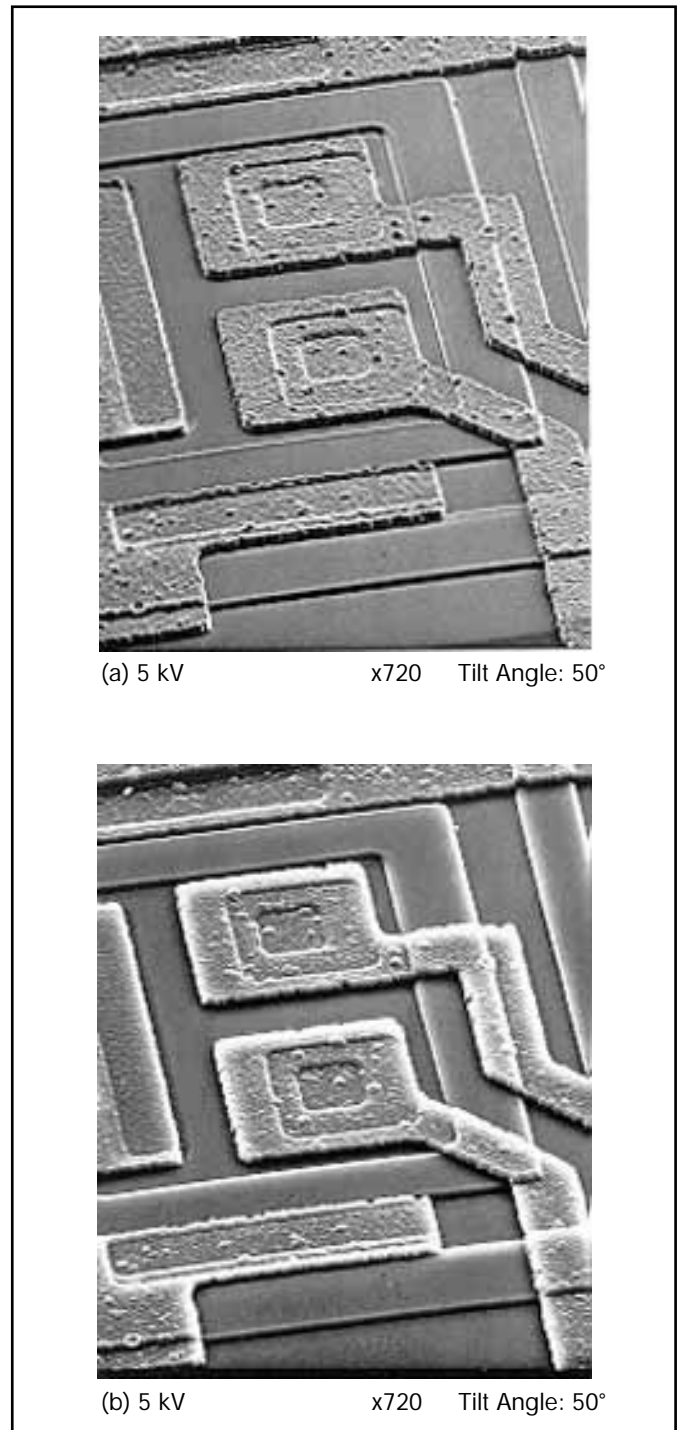

Fig. 12. Specimen IC chip.
The higher the accelerating voltage, the greater is the edge effect, making the edges brighter.

2-4. Use of specimen tilt

Specimen tilt is aimed at:

- 1) Improving the quality of secondary electron images
- 2) Obtaining information different from that obtained when the specimen is not tilted, that is, observing topographic features and observing specimen sides.
- 3) Obtaining stereo micrographs.

a) Dependence of image quality on tilt angle

Fig. 13 shows a photo taken at a tilt angle of 0° (a) and a photo taken at 45° (b). Their comparison shows that the latter is of smooth quality and stereoscopic as compared with the former. When the specimen is tilted, however lengths observed are different from their actual values. When measuring pattern widths, etc., therefore, it is necessary to measure without specimen tilting or to correct values obtained from a tilted state.

b) Stereo micrographs

With SEM images it is sometimes difficult to correctly judge their topographical features. In such a case observation of stereo SEM images makes it easy to understand the structure of the specimen. Besides, stereo observation allows unexpected information to be obtained even from specimens of simple structure.

In stereo observation, after a field of interest is photographed, the same field is photographed again with the specimen tilted from 5° to 15° . Viewing these two photos using stereo glasses with the tilting axis held vertically provides a stereo image.

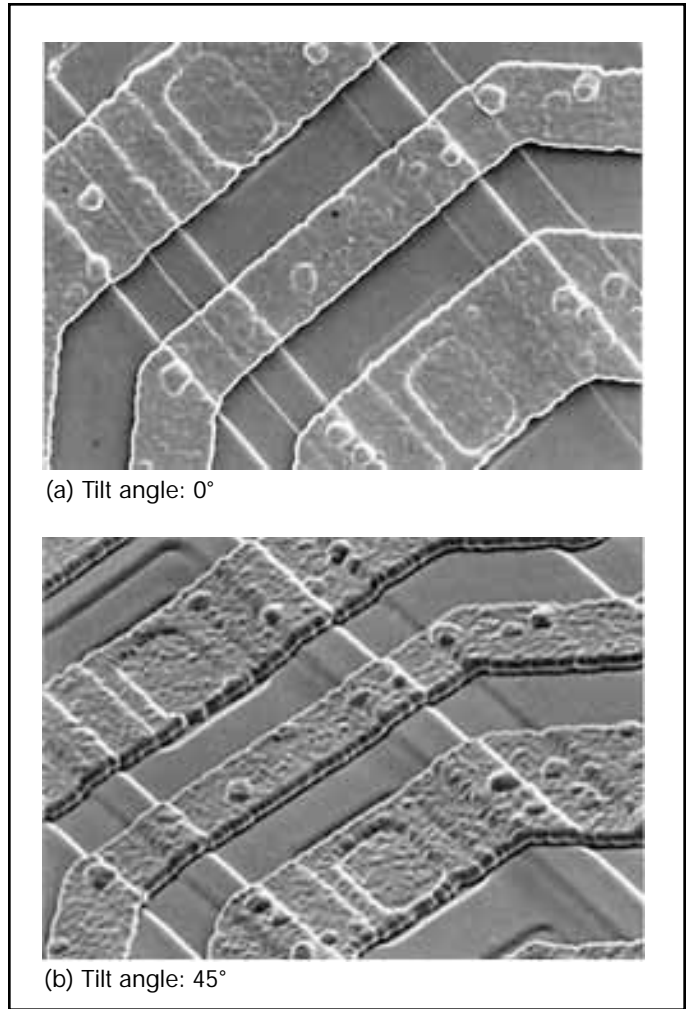

Fig. 13. Specimen: IC chip.
5 kV x1,100
The sides of patterns are viewed by tilting the specimen.
The amount of signals is increased.

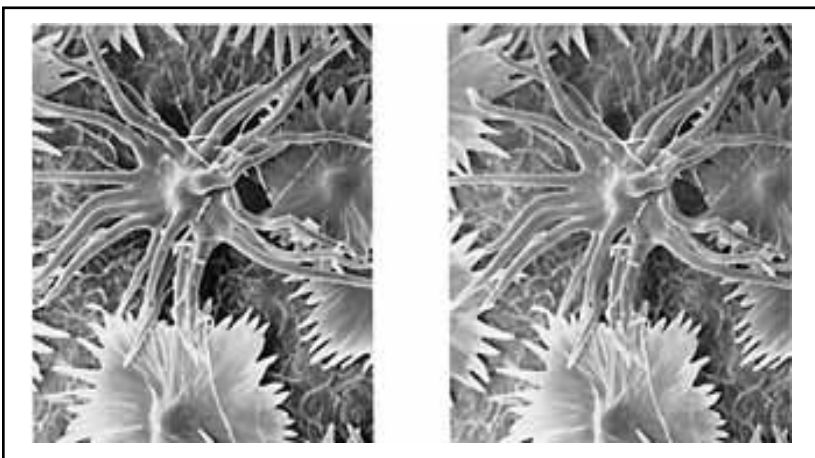

Fig. 14. Specimen: Back sides of oleaster leaves. More information is obtained from stereo-pair photos.

c) Detector position and specimen direction

The amount of secondary electrons produced when the specimen is illuminated with an electron beam, depends on the angle of incidence theoretically. However, there arises a difference in the image brightness depending on whether the tilted side of the specimen is directed to the secondary electron detector or the opposite side.

With a long specimen, for example, the brightness differs between the side facing the detector and the opposite side.

In such a case, directing the longitudinal axis of the specimen to the detector makes the brightness uniform.

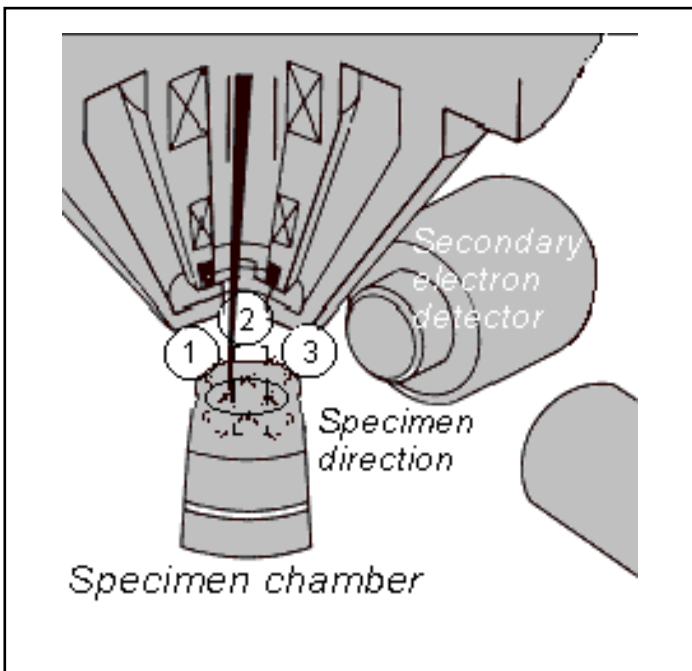
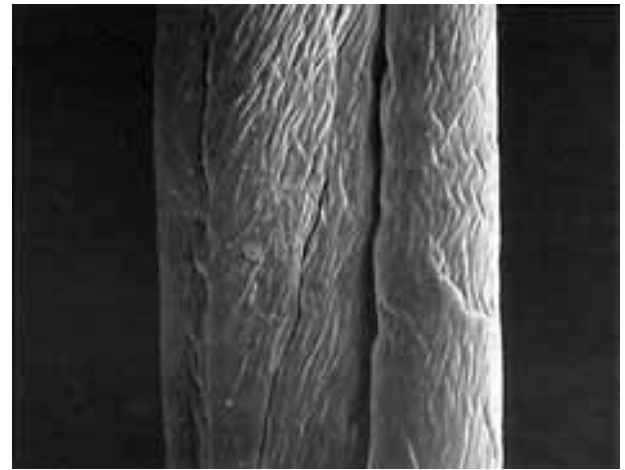
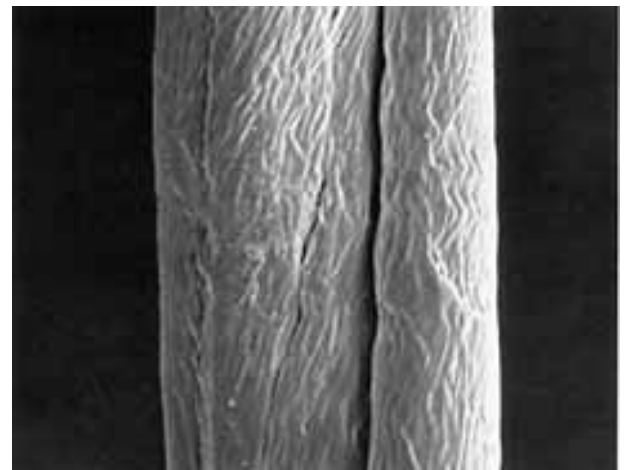

Fig. 15 Detector position and specimen direction.



(a) Specimen directed as at 1



(b) Specimen directed as at 2

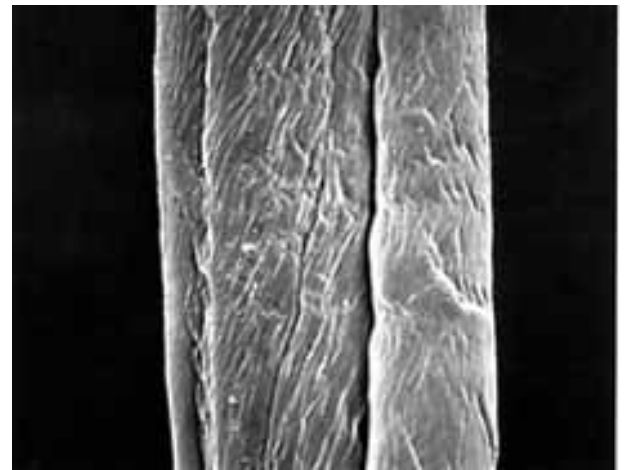

(c) Specimen directed as at 3

Fig. 16 Specimen: Fiber
7kV x2,200
Directing the longitudinal axis of the specimen to the secondary electron detector makes the right and left sides equally bright.
(An SRT unit is used to direct the image longitudinally.)

2-5. Use of backscattered electron signals

Although secondary electron images are obtained most frequently with the SEM, backscattered electron images also provide important information.

Backscattered electrons vary in their amount and direction with the composition, surface topography, crystallinity and magnetism of the specimen. The contrast of a backscattered electron image depends on (1) the backscattered electron generation rate that depends on the mean atomic number of the specimen, (2) angle dependence of backscattered electrons at the specimen surface, and (3) the change in the backscattered electron intensity when the electron probes incident angle upon a crystalline specimen is changed.

The backscattered electron image contains two types of information: one on specimen composition and the other on speci-

men topography. To separate these two types of information, a paired semiconductor detector is provided symmetrically with respect to the optical axis. Addition of them gives a composition image while subtraction gives a topography image. And with composition images of crystalline specimens, the difference in crystal orientation can be obtained as the so-called "channeling contrast," by utilizing the advantage that the backscattered electron intensity changes largely before and after Bragg's condition.

The generation region of backscattered electrons is larger than that of secondary electrons, namely, several tens of nm. Therefore, backscattered electrons give poorer spatial resolution than secondary electrons. But because they have a larger energy than secondary electrons, they are less influenced by charge-up and specimen contamination.

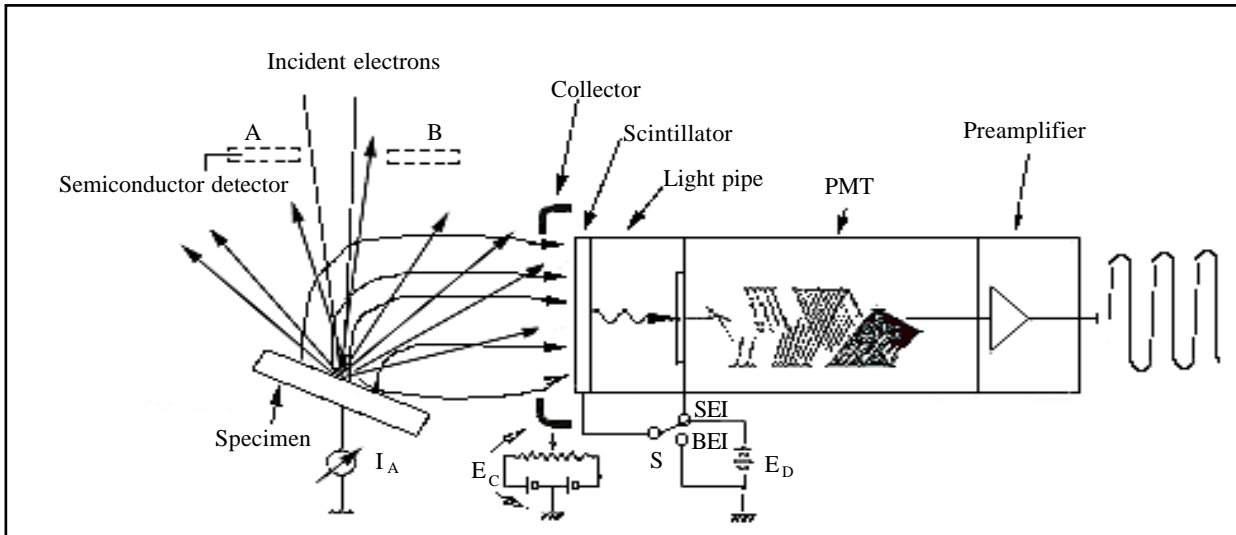

Fig. 17 Secondary electron detector

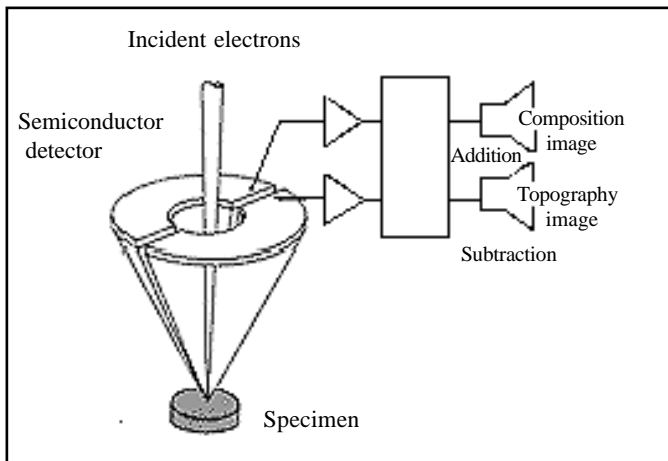

Fig. 18. Backscattered electron detector.

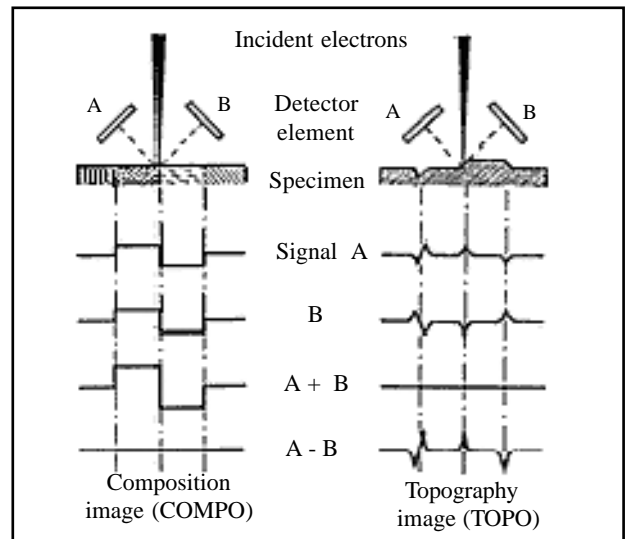

Fig. 19. Principles of composition image and topography image

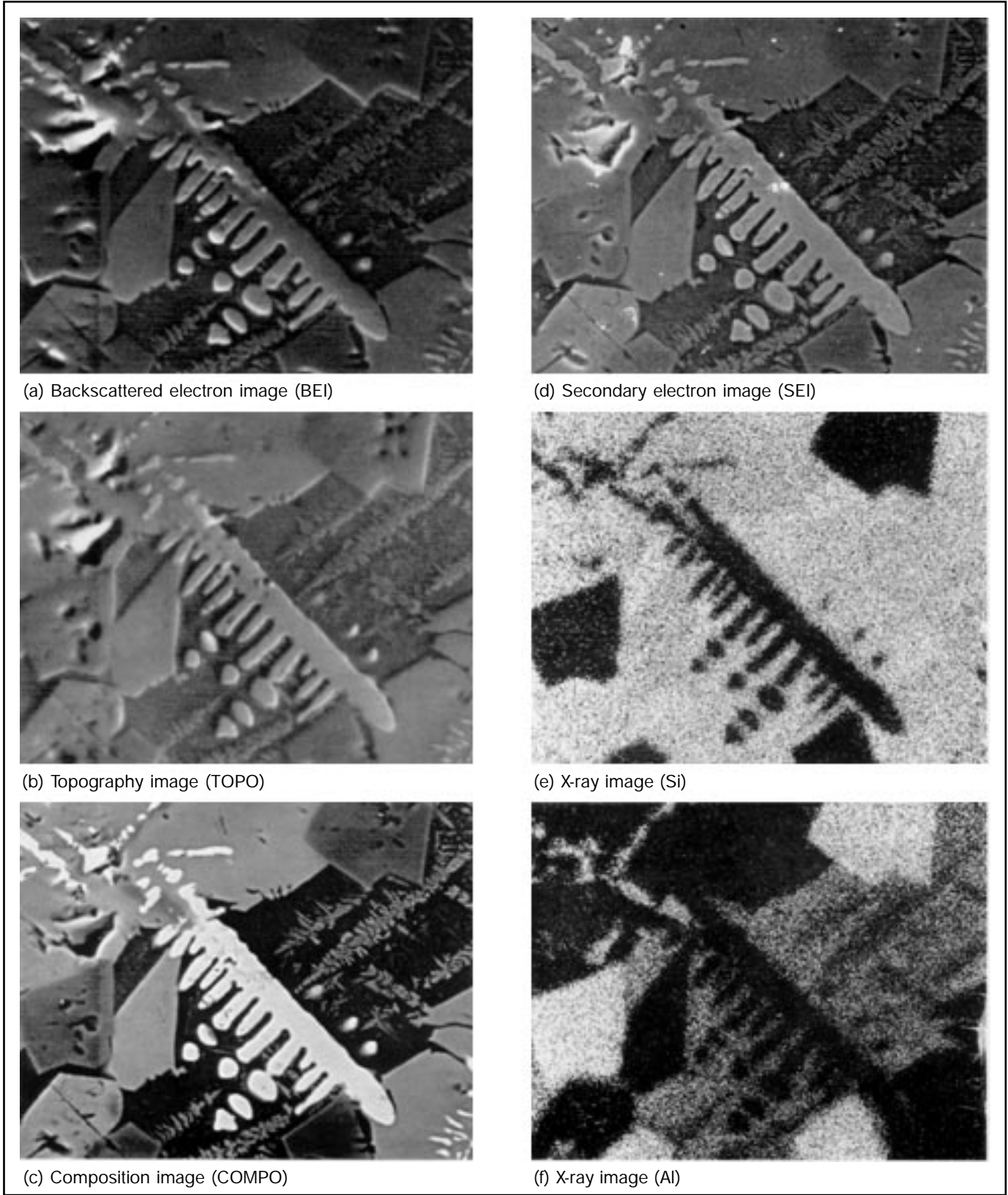

Fig. 20 Specimen: Slug
 20kV x1,100
 The backscattered electron image is important also
 as a supplementary means for x-ray analysis.

2-6. Influence of charge-up on image quality

a) Charge-up and countermeasure against it

When a nonconductive specimen is directly illuminated with an electron beam, its electrons with a negative charge collect locally (specimen charge-up), thus preventing normal emission of secondary electrons. This charge-up causes some unusual phenomena such as abnormal contrast and image deformation and shift.

Usually, the surface of a nonconductive specimen is coated with some conductive metal prior to observation. Rough surfaced specimens must be evenly coated from every direction. Recently, however, a method has been employed to observe specimens without coating, in order to know their true surface state.

Generally, the following methods are used to reduce specimen charge-up.

- 1) Reducing the probe current
- 2) Lowering the accelerating voltage
- 3) Tilting the specimen to find a balanced point between the amount of incident electrons and the amount of electrons that go out of the specimen (this point varies with the specimen).

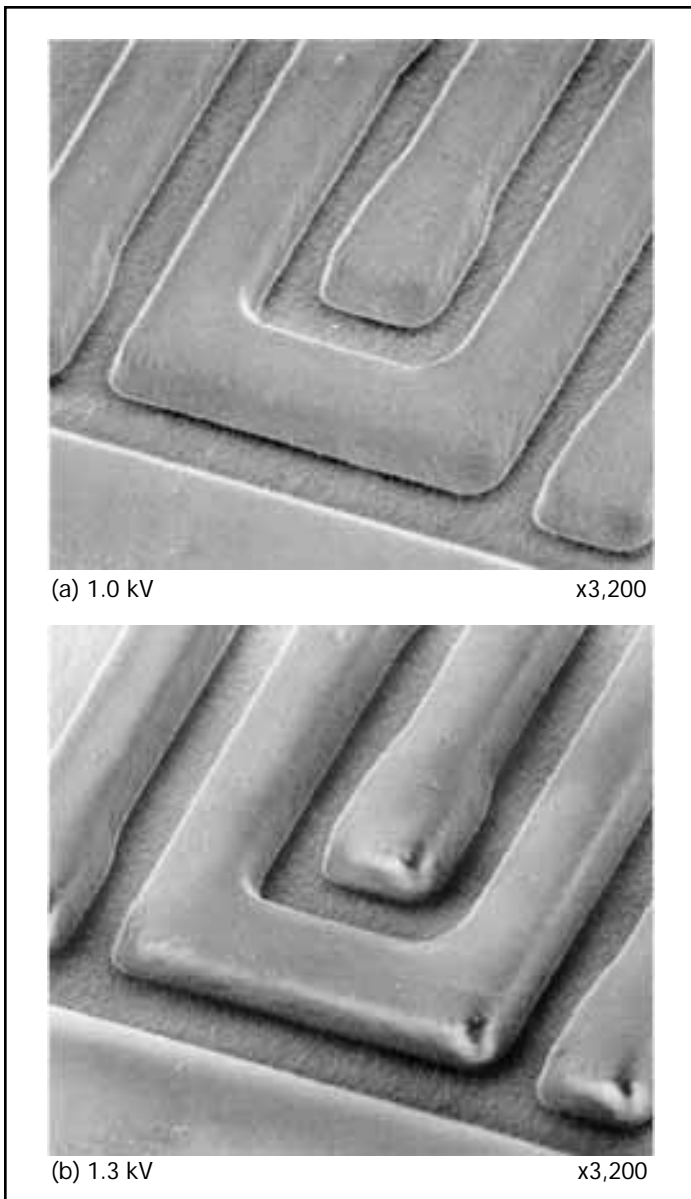

Fig. 21. Specimen: Resist.
Charge-up can be prevented by properly selecting the accelerating voltage.

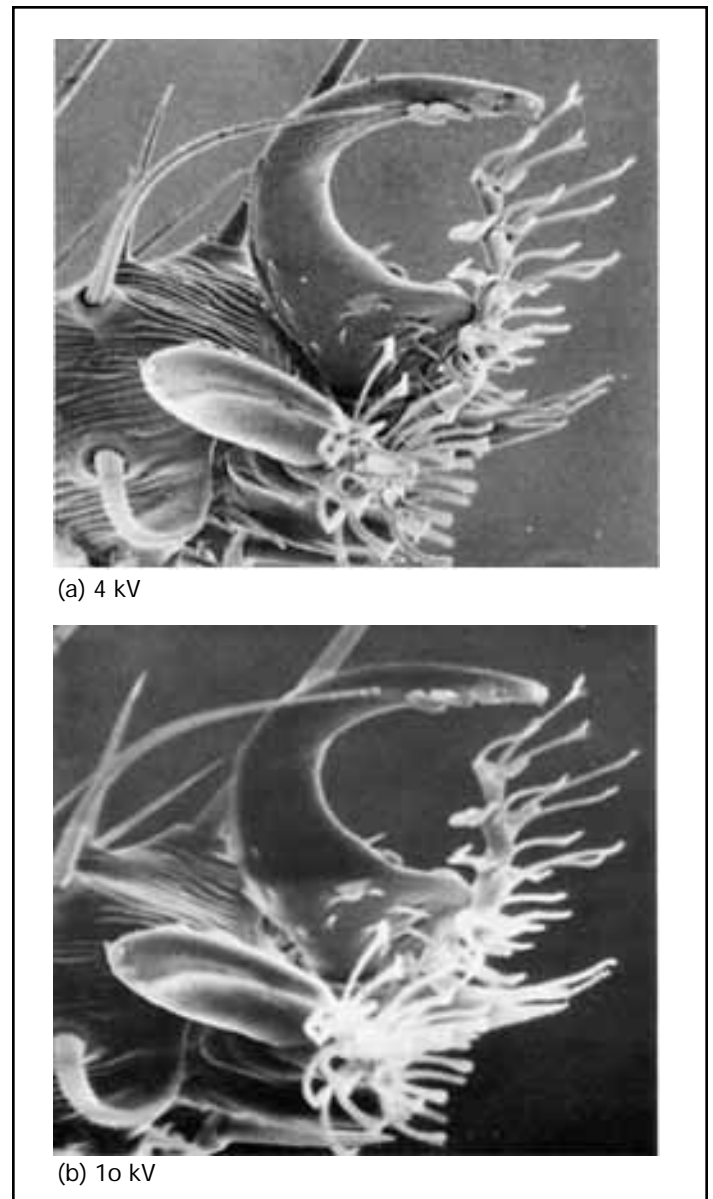

Fig. 22. Specimen: Fbreleg of vinegar fly.
Charge-up can be reduced by using low accelerating voltage.

b) Prevention of charge-up by sampling

Biological, cloth, and powder specimens cannot often be photographed clearly, with some portions looking too bright and some too dark. This is because those specimens are partly charged up.

To prevent this, it is necessary to give specimen surfaces uniform conductivity as follows:

- (1) When fixing the specimen on a specimen stub, apply conductive paint (carbon paint or the like) to specimen portions which are hard to coat.

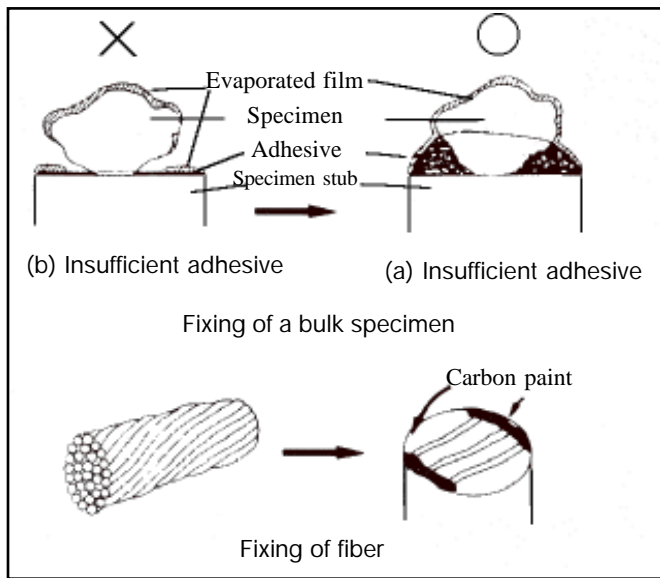

Fig. 23 Fixing the specimen.

- (2) In the case of powder, if its particles are piled on each other, charge-up easily takes place, causing them to move during observation. To prevent this, after the adhesive for fixing the powder is dried, blow the piled particles using a hand blower. Different adhesives need to be used depending on the size of particles. Mainly, double-sided adhesive tape, manicure liquid, and aluminum foil are used. When using double-sided tape, it is effective to apply conductive paint (carbon paint) to the four corners.

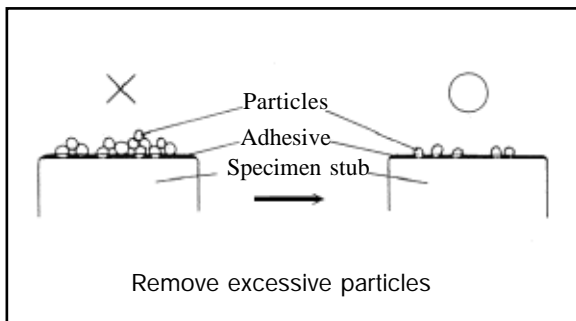
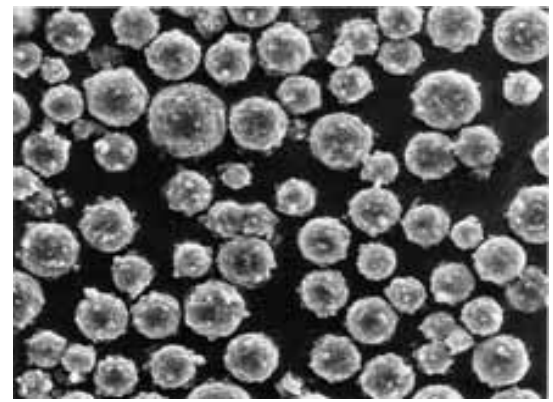
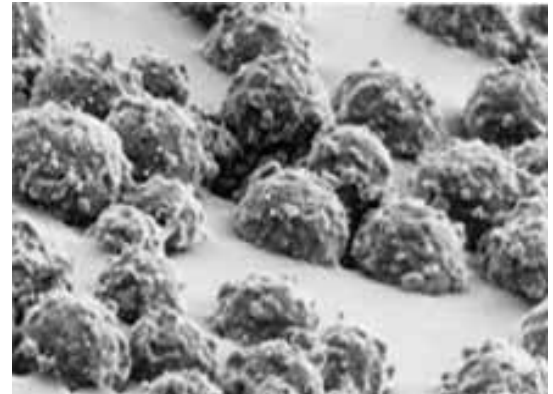

Fig. 24. Preparation of powder specimen.



(a) 15 kV Tilt angle: 0° x720



(b) 5 kV Tilt angle: 45° x1,400

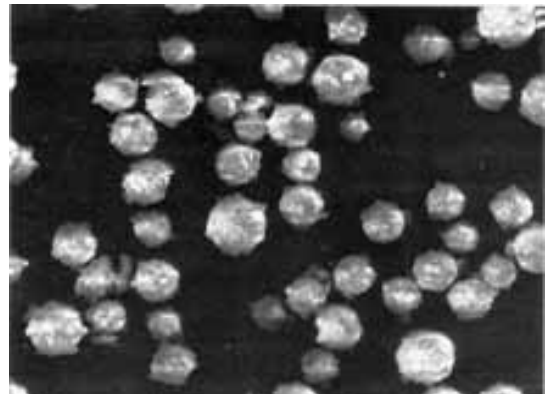

(c) 15 kV Tilt angle: 0° x720

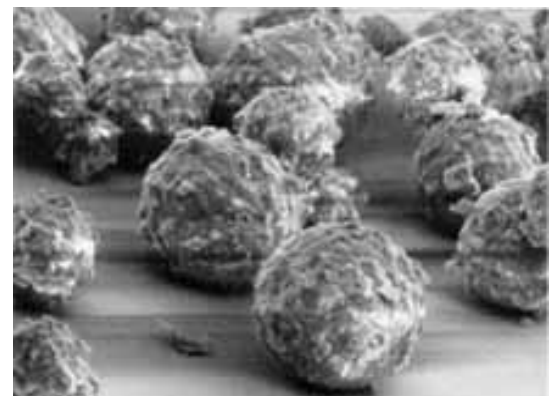

(d) 5 kV Tilt angle: 45° x1,400

Fig. 25. Specimen: Toner

Fig. 25 (a) and (b) show toner powder dispersed on double-sided tape and a little pressed. It is seen that no charge-up took place even when high accelerating voltage was used Fig. 25 (c) and (d) show toner powder fixed with manicure liquid. It is seen that charge up is caused as the powder is not sufficiently fixed.

2-7. Specimen damage by electron beam

The loss of electron beam energy in the specimen occurs mostly in the form of heat generation at the irradiated point. The temperature increase at an irradiated point is dependent on:

- 1) The electron beam accelerating voltage and dosage.
- 2) Scanning area.
- 3) Scanning time.
- 4) Heat conductivity of the specimen. Polymer materials and biological specimens, which are generally not resistant to heat, are easily damaged by the electron beam, because of their low heat conductivity.

To avoid this damage, the following should be taken into consideration:

- 1) To use low accelerating voltage.
- 2) To decrease electron beam intensity.
- 3) To shorten exposure time, even though this reduces photograph smoothness slightly.
- 4) To photograph large scanning areas with low magnifications.
- 5) To control the thickness of coating metal on the specimen surface. It is also advisable to adjust beforehand the astigmatism and brightness using another field of view and then photograph the actual field as quickly as possible.

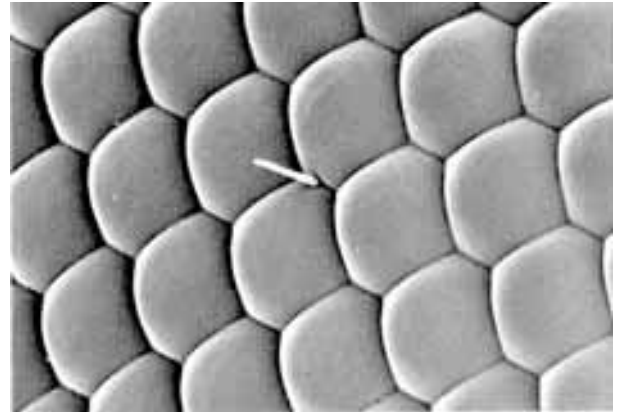

(a) Undamaged specimen

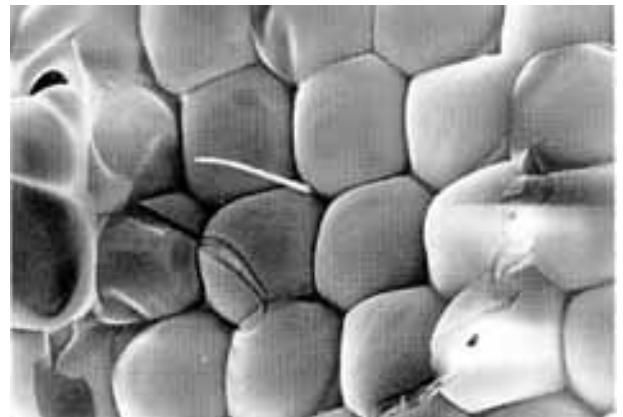

(b) Damaged specimen

Fig. 26. Specimen: Compound eye of fly.

5 kV x1,00

When a specimen area is irradiated with an electron probe for a long time at high magnification, it may be damaged as shown in Fig. 26 (b).

2-8. Contamination

When the electron probe is irradiated on a specimen portion for a long time, its image may lose sharpness and become dark. This is caused by the residual gas in the vicinity of the specimen being struck by the electron probe. This phenomenon is called specimen contamination.

The conceivable residual gases in the specimen chamber, which cause contamination are:

- 1) Gas caused from the instrument itself.
- 2) Gas that specimens bring into the instrument
- 3) Gas that the specimen itself gives off.

To prevent specimen contamination, special attention must be paid to the following matters:

- 1) Use the minimum amount of double-sided adhesive tape or conductive paint, and completely dry it before putting the specimen in the instrument.
- 2) In some cases, contamination can also be reduced by drying the adhesive with a drier or the like.
- 3) Use the smallest possible biological specimens.
- 4) Since some embedding agents and resins give off a large amount of gas, they need to be selected carefully. Also since organic gas is given off when the resin surface is irradiated with an electron probe, irradiate the smallest possible surface area or coat the surface with a conductive material.

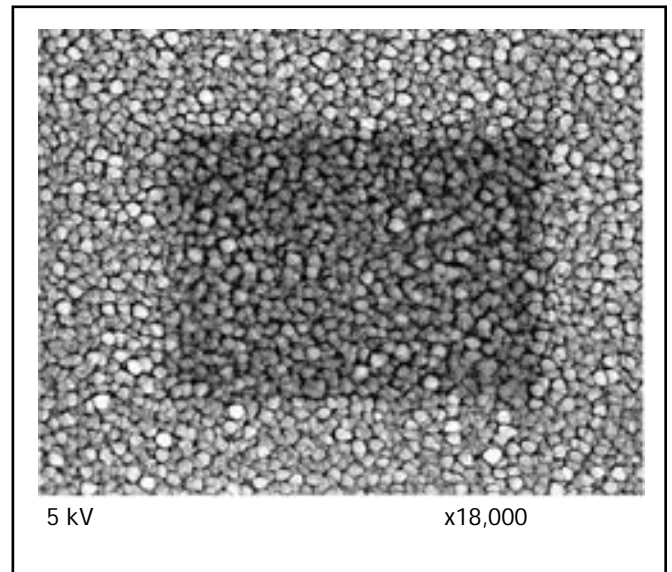

Fig. 27. Specimen: ITO.

A x18,000 photo taken after a long-time electron probe scanning at x36,000. As compared with the clear image of peripheral region, the middle region shows reduced contrast and lacks image sharpness.

3. The Influence on Images, of Operational Technique, Specimen Preparation Technique, External Disturbances, Etc.

3-1. Working distance and objective aperture

a) Influence of working distance (WD) on images

WD is changeable on many recently available SEM models. Fig. 28 shows what effect is produced on the image when WD is changed with other conditions kept unchanged.

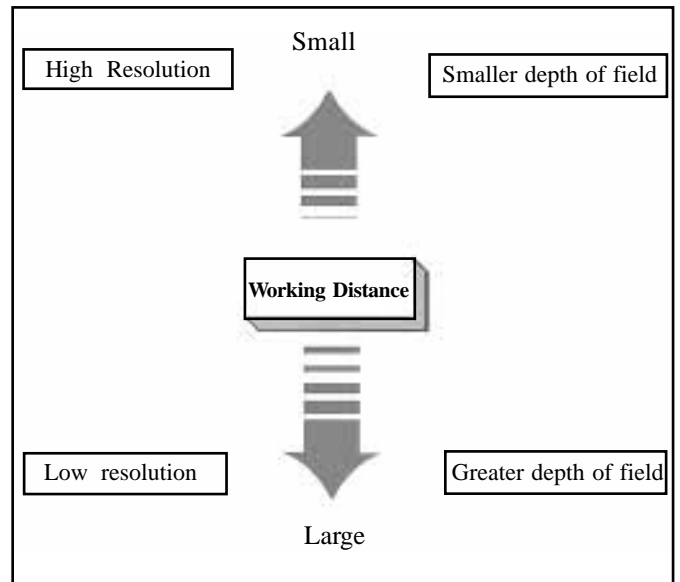

Fig. 28. Effect of working distance.

b) Influence of objective aperture diameter on images

The objective lens (OL) aperture set in the SEM as standard is of the optimum size selected considering various conditions. SEM images require not only a fine electron probe, but also a sufficient amount of signals for forming an image. The aperture cannot be reduced unnecessarily. The OL aperture must be selected with consideration given to the effect shown in Fig. 29.

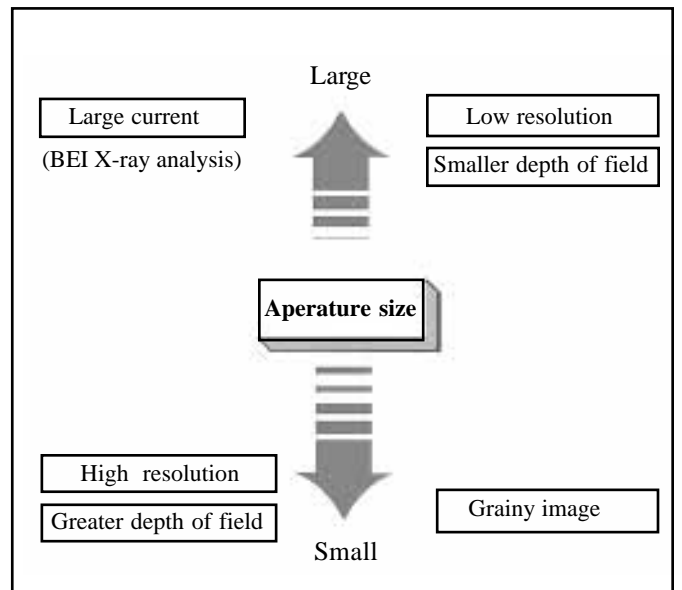
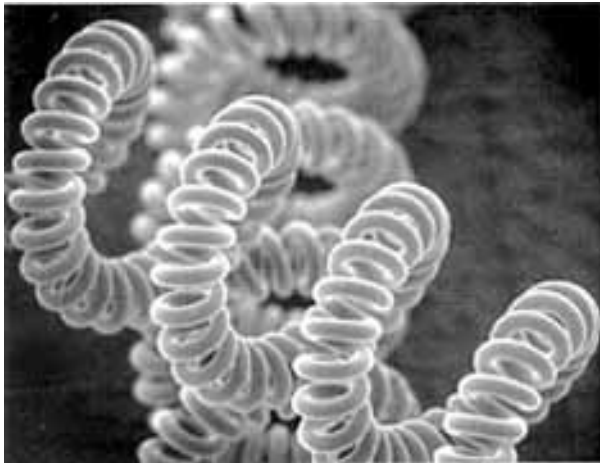
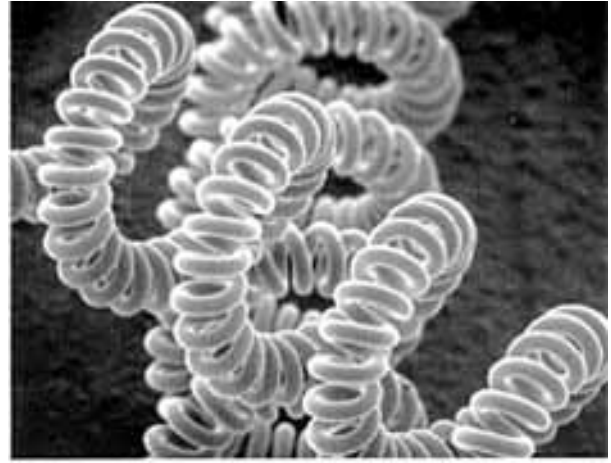

Fig. 29. Effect of OL aperture.



(a) OL aperture diameter: 600 μ m WD: 10mm



(b) OL aperture diameter: 200 μ m WD: 10mm

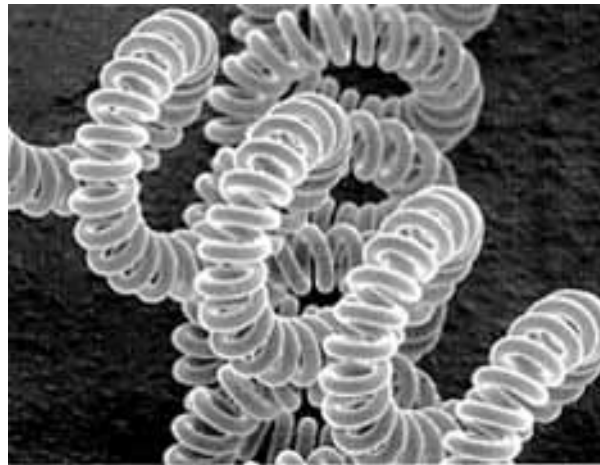

(c) OL aperture diameter: 200 μ m wd:20mm

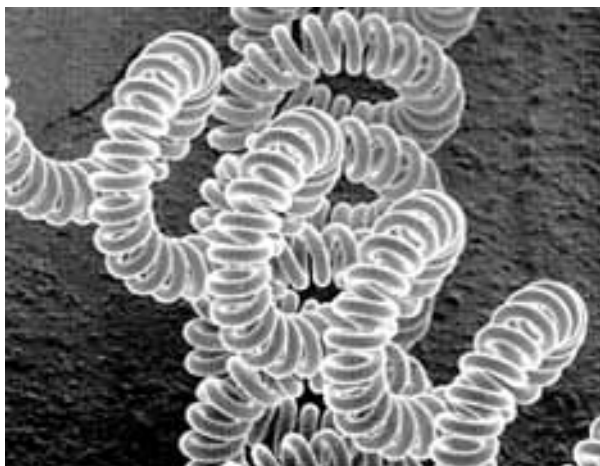

(d) OL aperture diameter: 200 μ m WD: 38mm

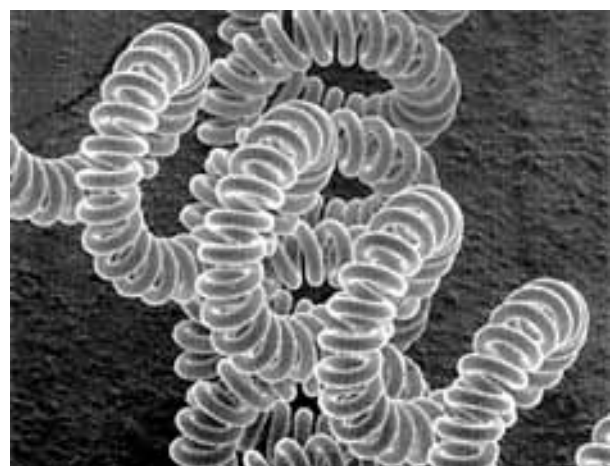

(e) OL aperture diameter: 100 μ m WD: 38mm

Fig. 30. Specimen Electric bulb coil.

5 kV x540

The smaller the OL aperture diameter and the longer the WD, the greater the depth of field.

3-2. Influence of astigmatism

The aberration caused by the machining accuracy and material of the polepiece is called "astigmatism." This astigmatism can be removed by adjusting the two knobs, X and Y, of the stigmator.

An image is judged as astigmatism-free if it has no unidirectional defocusing when the objective lens is changed to under or over-focus at a little high magnification (about x10000).

(A) Images before astigmatism correction

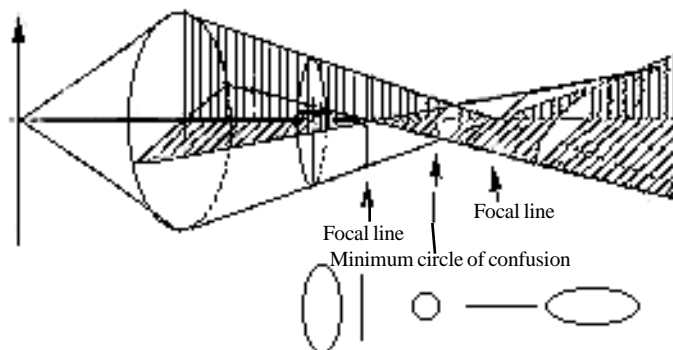
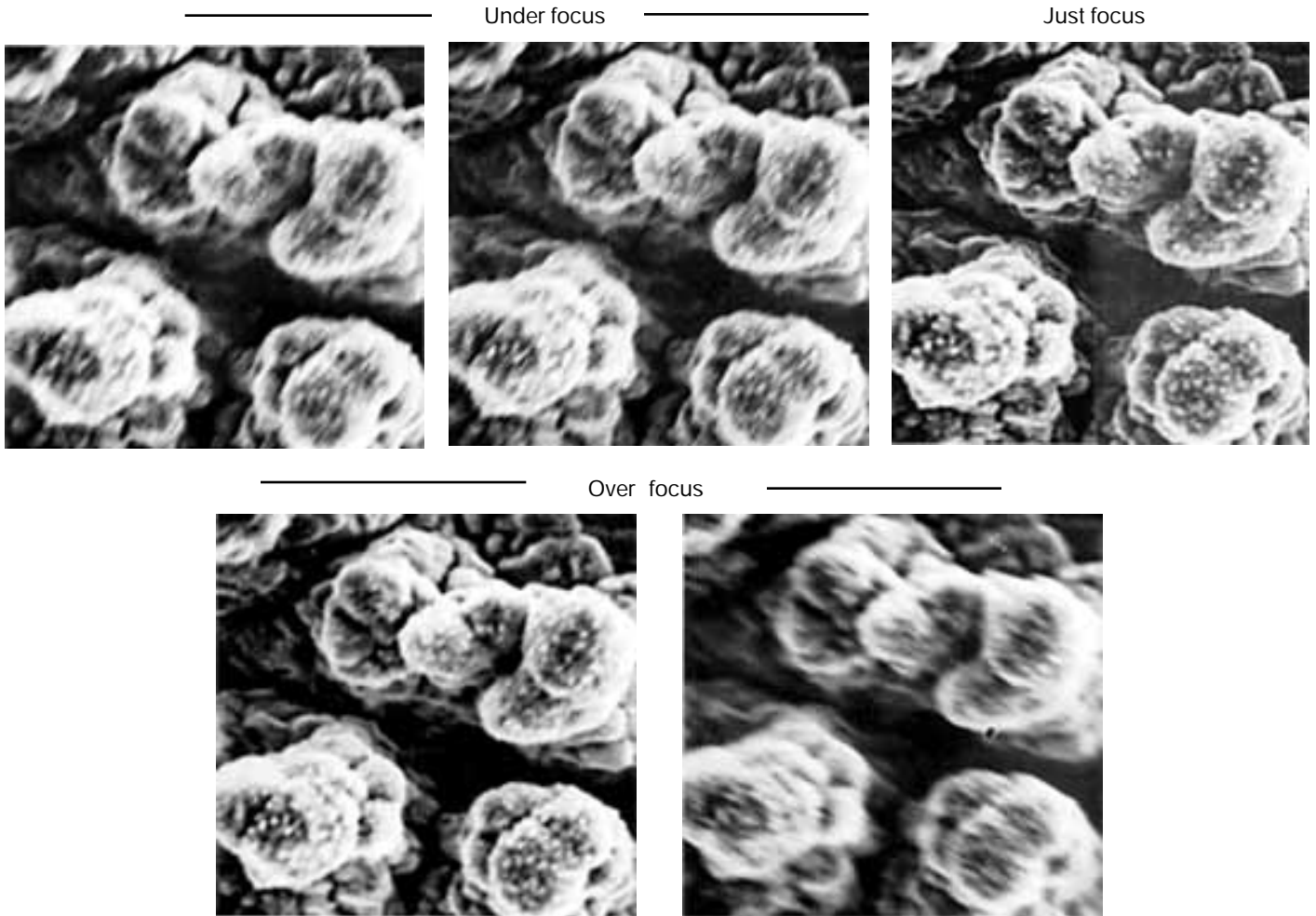

(a) Shape changes in electron beam when there is astigmatism

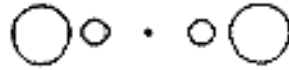
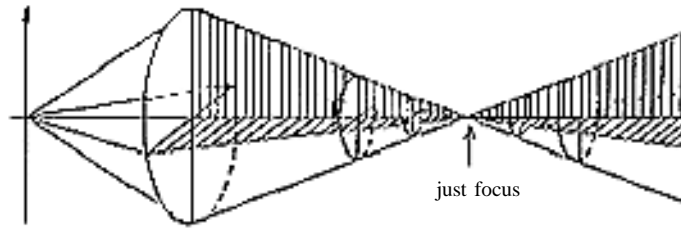

(b) Shape changes in electron beam when astigmatism is corrected

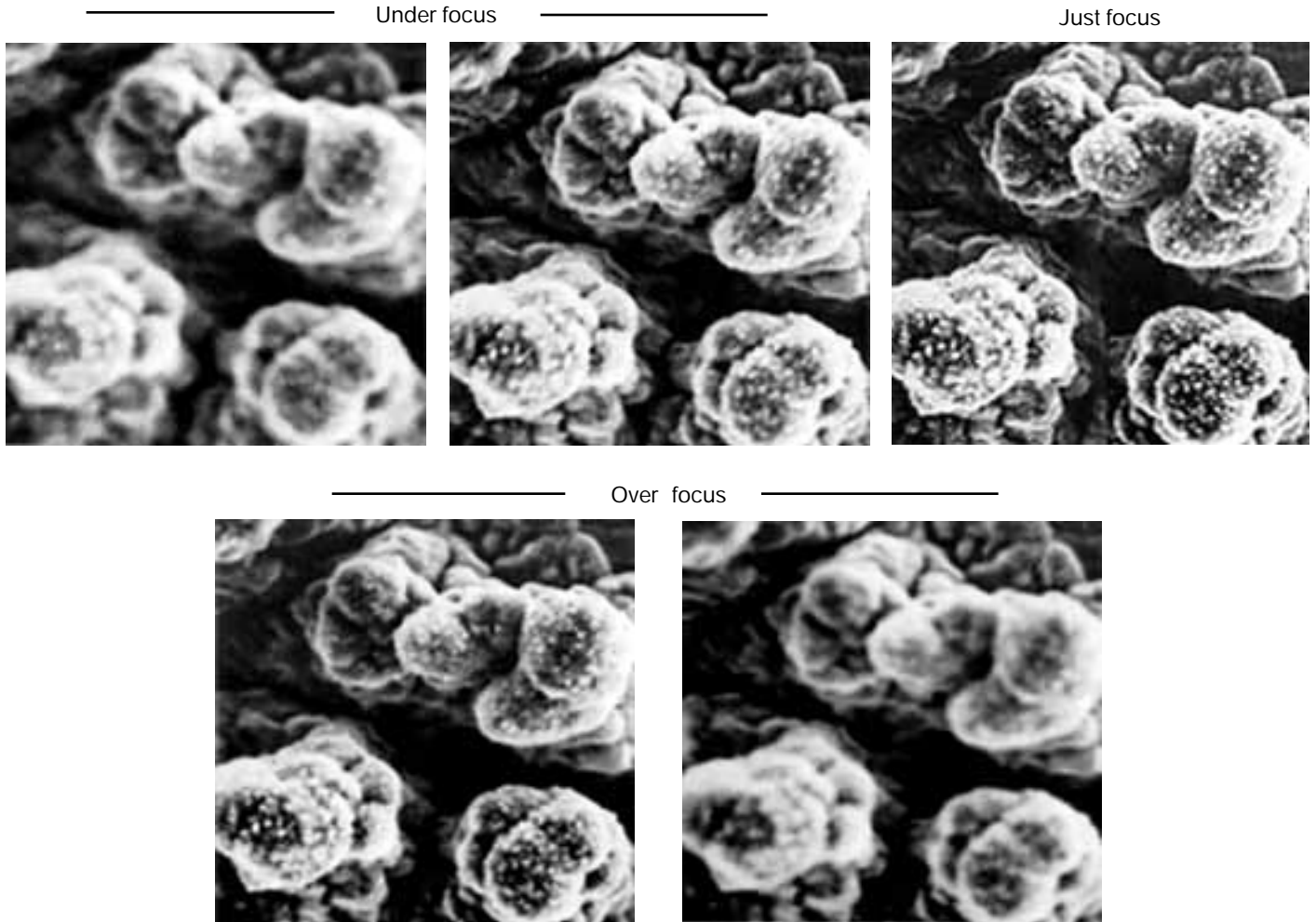

The micrographs (f) to (j) show stigmator-corrected images. Although blurring is noticed before and after the just-focus image, no unidirectional defocusing is seen.

The micrographs (a) to (e) do not provide images as sharp as the images (f) through (j) due to astigmatism.

3-3. Optimum contrast and brightness of micrographs

A good SEM microscope is sharp, noiseless and provides optimum contrast and brightness.

In JEOL SEMs, optimum contrast and brightness are adjusted automatically or by built in controls. In some cases, however, the contrast and brightness are adjusted optimally for the portion of interest only, and not for the image overall.

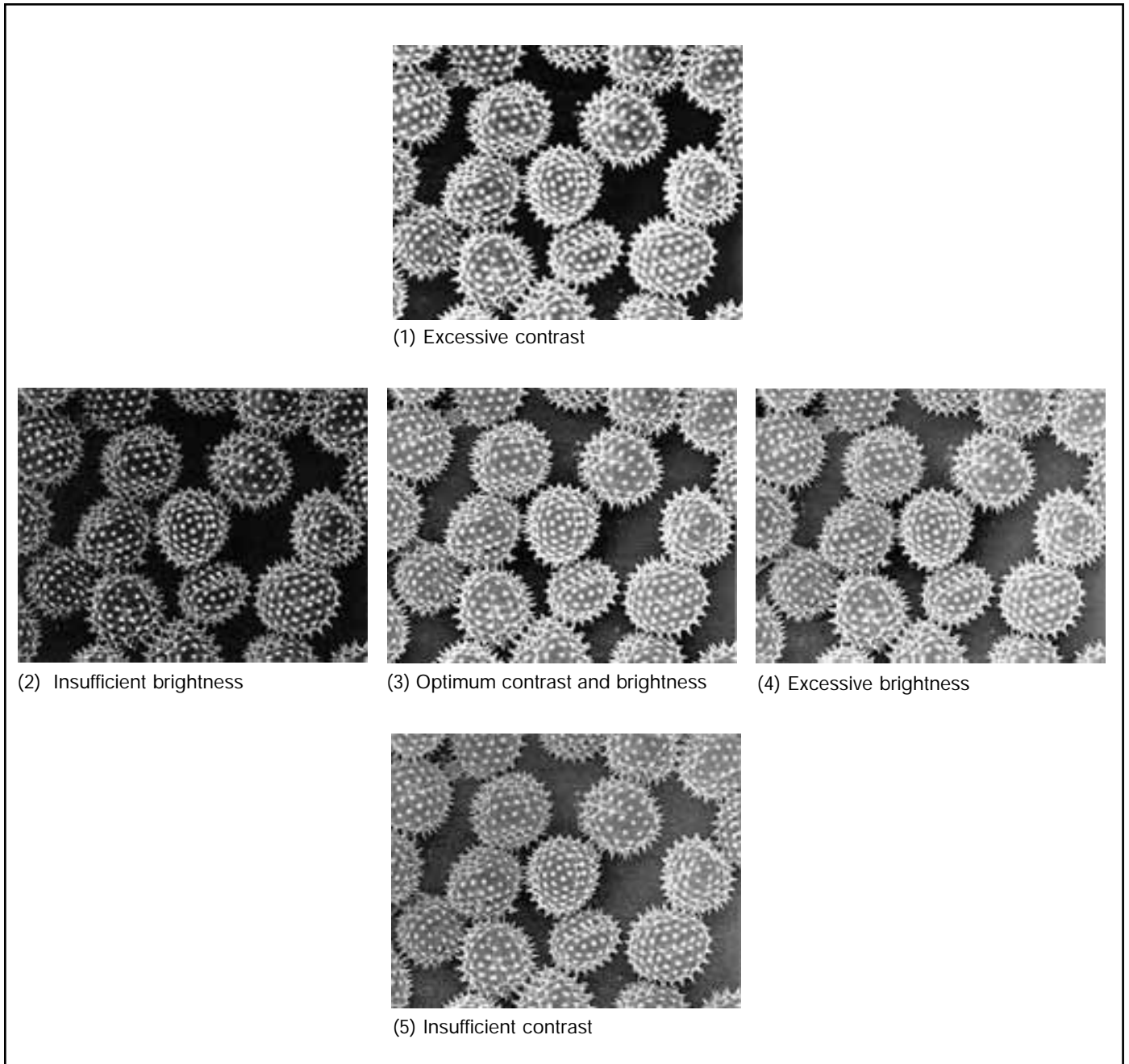

Fig. 33. Specimen: Pollen of marigold.
5 kV x360
The micrograph with optimum contrast and brightness is the most persuasive

3-4. Exposure time for X-ray image

SEI and BEI images are usually photographed by one scan of 50 to 100 seconds. However, since the signals for an X-ray image per unit time are small, they are often photographed by long-time exposure.

If the exposure time is not long enough, X-ray images may lack some information on element distribution. It is therefore necessary to carefully decide on the exposure time.

Generally, calculating the X-ray count as approx. 2,500 counts/cm² gives a good result.

When photographing the distribution of the specific elements in a certain phase, it is well to fix the electron probe at that portion, investigate the X-ray count rate (CPS) and the ratio of the phase to the whole image. The exposure time can then be decided upon.

Exposure time:	Time required for photographing
Picture elements	The area (cm ²) of interest
X-ray count rate:	X-ray count rate (CPS) during electron beam irradiation

How to decide exposure time

$$\text{Exposure time(s)} = 2500 (C/cm^2) \times \frac{\text{Picture elements(cm}^2\text{)}}{\text{X-ray count rate (CPS)}}$$



(a) Composition image (COMPO)



(b) X-ray image Ca 50 seconds



(c) X-ray image Ca 300 seconds

Fig. 34. Specimen: Aluminum alloy.
20 kV x580
Unless an X-ray image is given sufficient as well as necessary exposure, some information will be lost as at (b)

3-5. Influences of external disturbances on images

External disturbances such as a stray magnetic field, mechanical vibrations, etc. can cause image distortion, jagged edge lines and other phenomena. Often disturbances in SEM images are caused by structural or installation conditions such as:

- 1) Leakage:
 - Magnet field from distribution board
 - High-tension line located too close to the instrument
- 2) Low floor strength
- 3) Improper grounding

Installation conditions should be carefully checked in advance to avoid any problems after SEM installation.

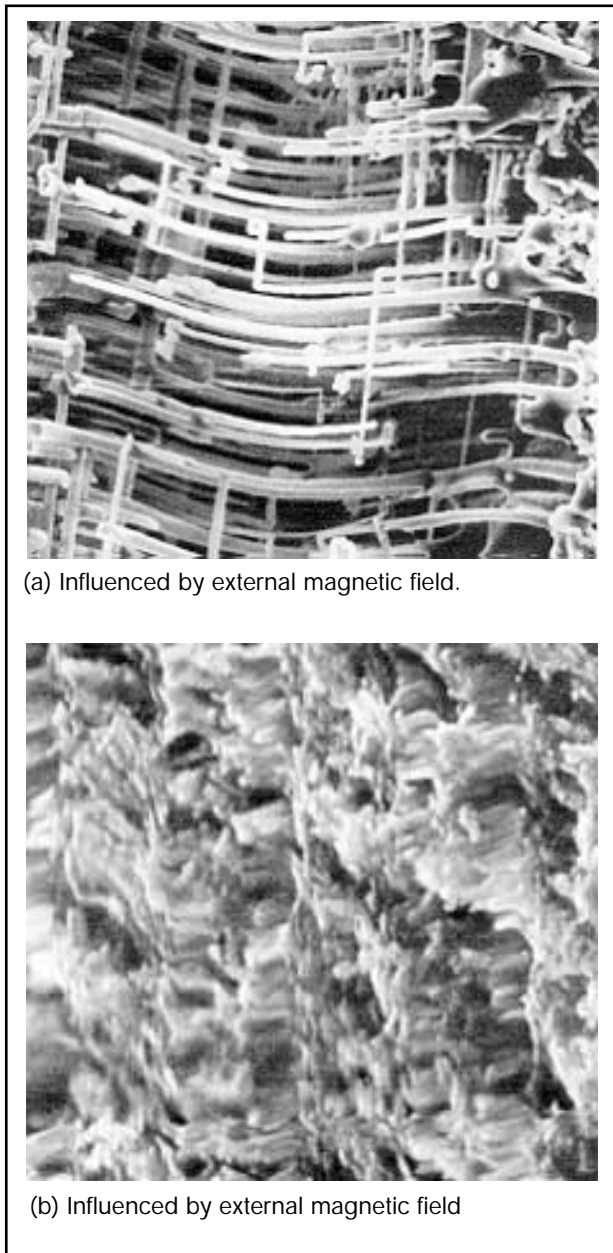

Fig. 35. Influence of external magnetic field on images

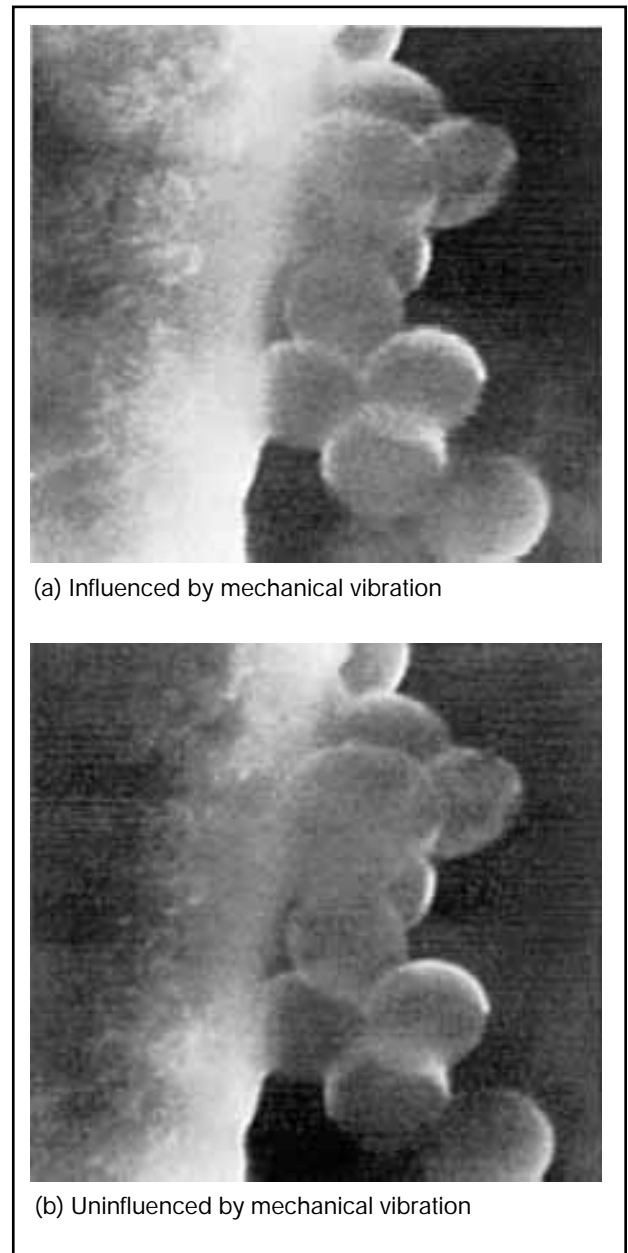

Fig. 36. Influence of mechanical vibration on images ($\times 50,000$) Micrograph (a) shows jagged edge lines due to external mechanical vibration Micrograph (b) has no mechanical vibration.

3-6 Deformation and impurity precipitation during specimen preparation process.

In the process of specimen preparation, biological specimens are apt to become defective because of required processes such as fixing, washing and dehydration. Their defects can be classified as follows:

- 1) Specimen deformation
- 2) Impurity precipitation
- 3) Impurity coating

To avoid deformation as much as possible, the critical point drying method is currently used instead of air drying.

Impurity precipitation is a phenomenon wherein the crystal material contained in the fixing, washing and dehydrating agents precipitates during the drying process. Sufficient care must be taken when handling the above-mentioned chemicals.



(a) Air drying

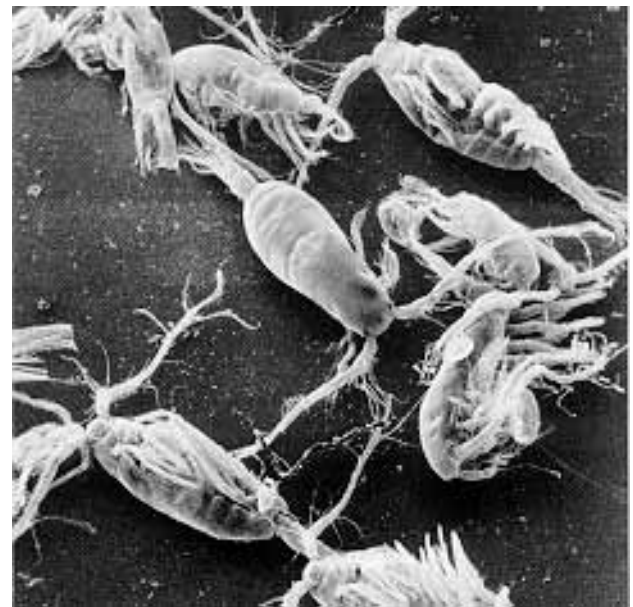

(b) Critical point drying

Fig. 37. Comparison between air drying and critical point drying: Air drying causes considerable specimen deformation as in (a), while critical point drying causes almost no deformation of specimens, which retain their original shapes as in (b).

3.7 Image distortion and its cause

If correct deflection magnification is lost horizontally or vertically, it results in image distortion. In some cases, latex particles must be used for checking purposes. Fig. 38 (b) shows a specimen tilted to 45°, its horizontal demagnification is approx. 70% of Fig. 38 (a). This demagnification can be compensated for with the Scan Rotation and Tilting Correction Unit (SRT)--a special attachment.

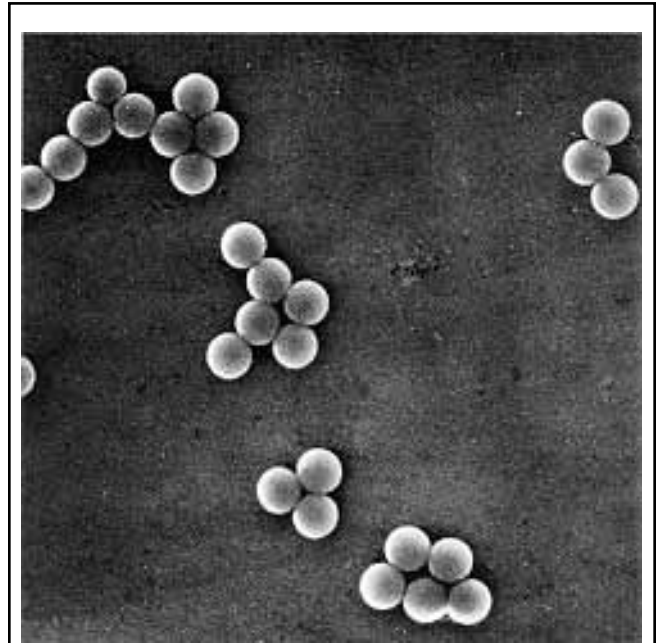

(a) Normal Image

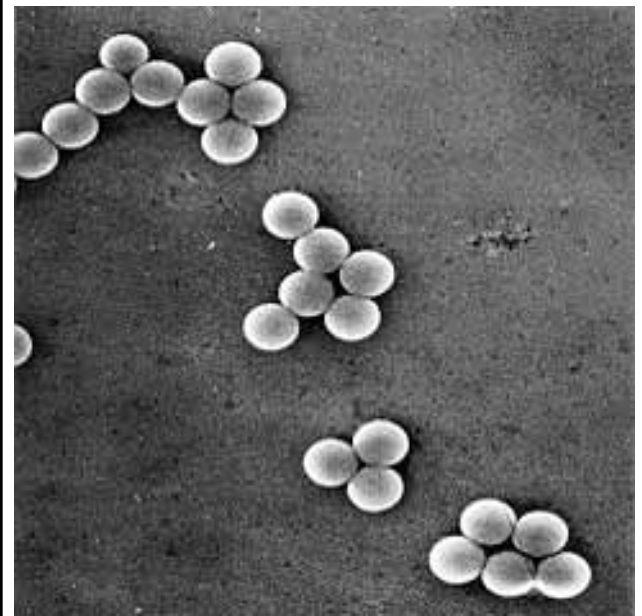

(b) Horizontally distorted image

Fig. 38. Image distortion due to incorrect horizontal deflection magnification

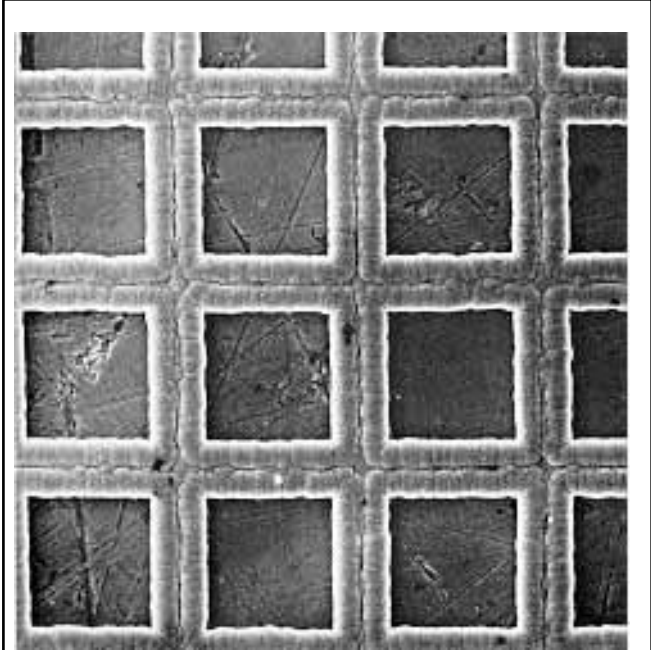

(a) Specimen tilt 0°

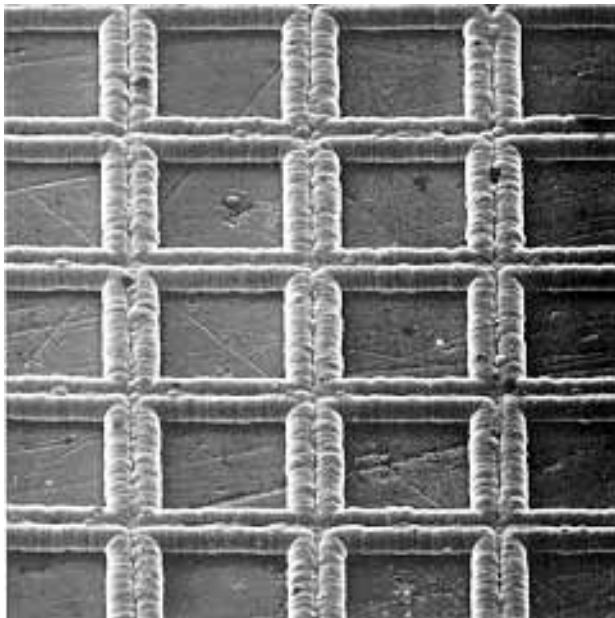

(b) Specimen tilt 45°

Fig. 39. Image distortion due to specimen tilt.
The image is horizontally demagnified by $1/\cos 45^\circ$ after specimen tilt.

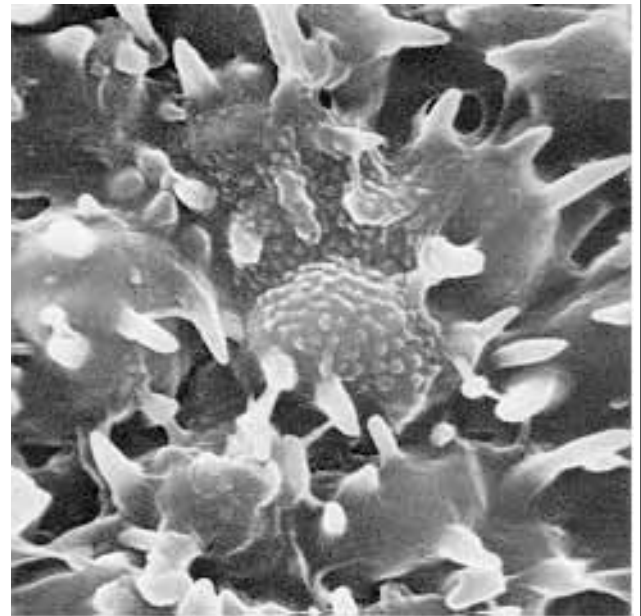

(a) Influenced by external field

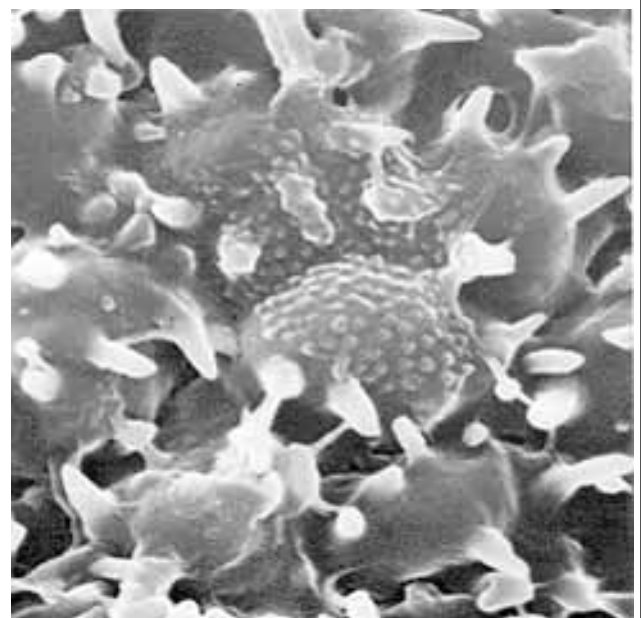

(b) Uninfluenced by external field

Fig. 40. Influence of external magnetic field on image.
Compared with (b), (a) is demagnified at the center and magnified at both sides, because of an intense magnetic field, 50 Hz.

3-8 Coating

Coating used in SEM analysis is aimed mainly at the following:

- 1) Preventing the charge-up on the specimen surface by covering it with a conductive material.
- 2) Increasing secondary electron emission by covering a specimen of low secondary electron emission with a metal of high secondary electron yield.

For coating, the vacuum evaporation method and the sputtering method are generally used. With the improved resolution of the SEM, coating techniques for high magnification are still under study. However, various substances are being used i.e., C (for general analysis), AU, AU-Pd, and Pt, which must be selected depending on the purpose and magnification. It is necessary to select a coating suitable for the observation magnification. If the coating is too thick, its particles become visible while at the same time the structures of interest are may be obscured.

a) Sputtering device

This device is most widely used for observing specimen surface morphology. When coating polymer materials that are easily damaged by ion irradiation and electron irradiation, the triode-type magnetron sputtering device is recommended over the diode sputtering.

As metals, AU and AU-pd are generally used because they are easily obtained and generate secondary electrons well. Recently, however, high-melting metals such as Pt and W have been used for high magnification observation, because of their high granularity.

Generally, the sputtering device is not used for carbon coating and is not suited for that purpose.

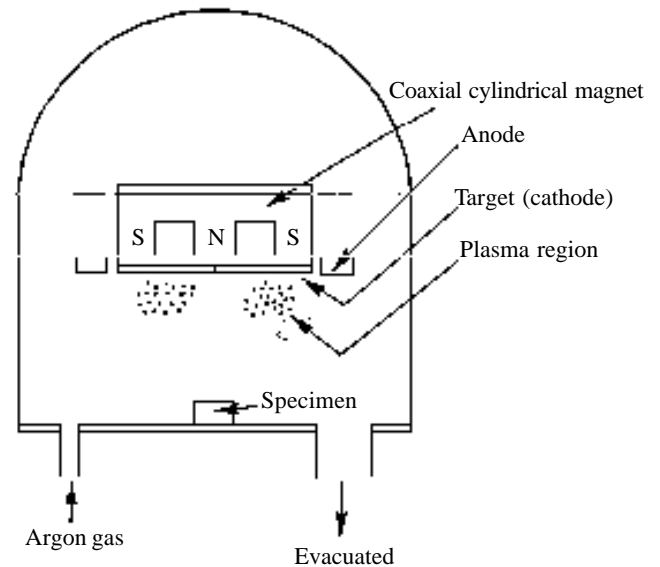

Fig. 41. Magnetron sputtering device.

b) Vacuum evaporator

When making surface observation and elementary analysis by X-ray detection, vacuum evaporation of carbon is carried out most generally for minimizing an evaporated substance's interference with detected elements.

Also, when the charge-up on the specimen surface cannot be prevented simply by coating with AU because of surface roughness, AU coating may be done after carbon evaporation. In either case, it is necessary to uniformly coat the specimen from all directions by rotating and tilting it during evaporation



Fig. 42. Vacuum evaporator.

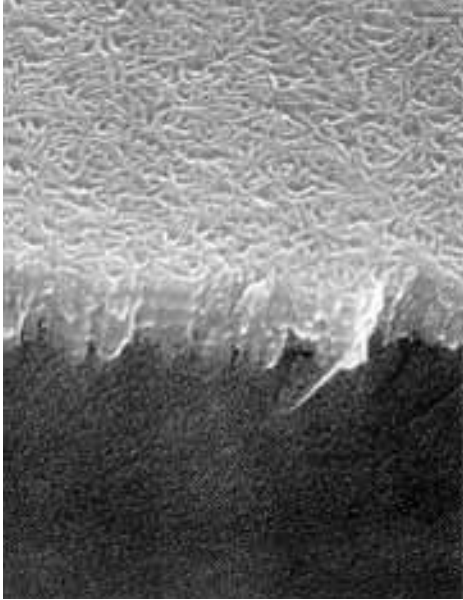

(a) Optimum coating

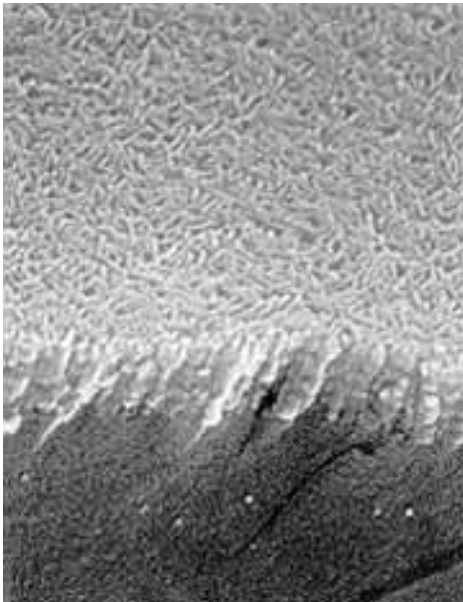

(b) Coating too thick

*Fig. 43. Specimen: Cross section of metal coating on glass surface.
15 kV x56,000*

A glass cross section needs to be coated with metal to prevent charge-up. This coating should not be too thick, however, as in Fig. 43 (b) where the columnar structure of the cross section as well as the surface are covered too thickly.

4. Disturbances Caused by Instrumental Defects

4-1. Insufficient filament heating

When the filament tip is not at a high enough temperature, due to insufficient filament heating, a proper cross over point may not be obtained, making a sharp image impossible to obtain.

If the filament is heated too much, the filament is evaporated excessively, which results in the generation of whiskers, instability of the electron probe, or in a shorter filament life. It is important to set the temperature optimumply.

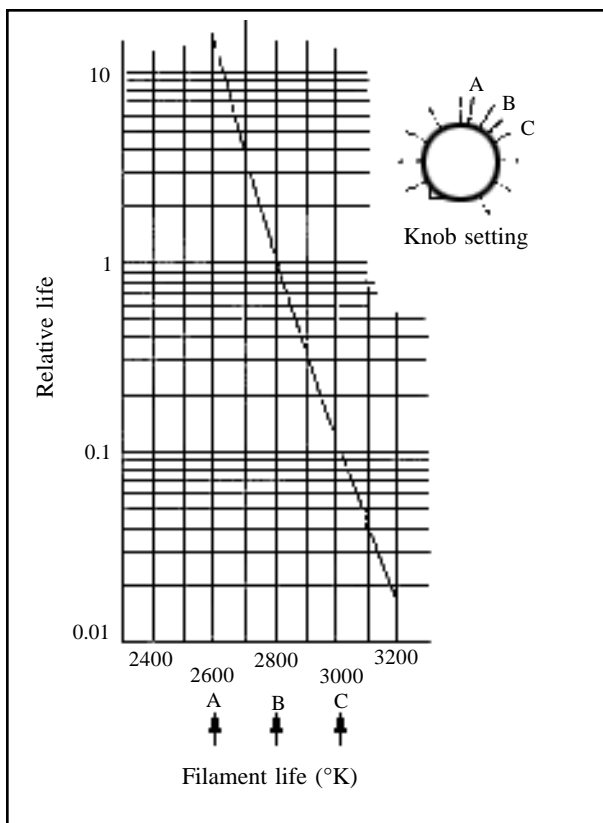

Fig. 44. Heating temperature and filament life.

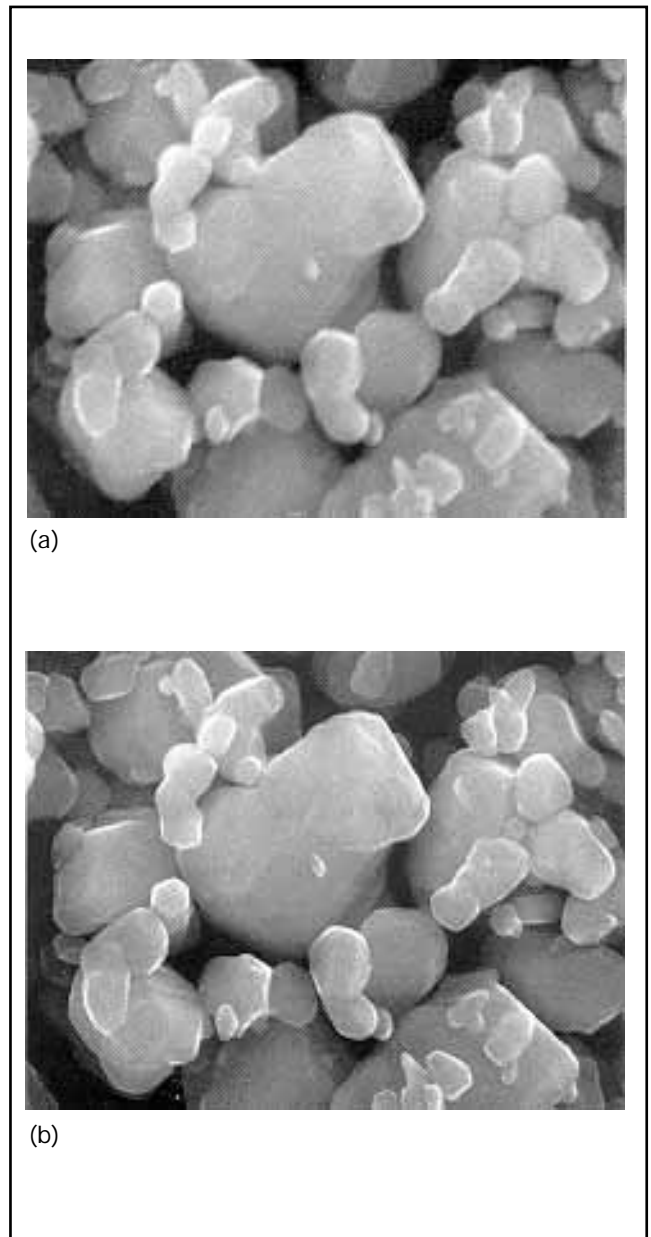

Fig. 45. Specimen: Zinc oxide.
25 kV x25,000
Change in image quality with filament heating temperature.

4-2 Incorrect alignment and centering of objective aperture

When the column is disassembled for cleaning or when the electron beam is lost, an operation called "alignment of the column" allows for the electron beam from the filament to be most effectively collected onto the specimen surface by means of mechanical and electrical alignment.

In this operation, the electron beam from the gun should first be aligned using a tilting correction knob, then the objective aperture should be adjusted to make the electron beam pass the objective lens center.

After replacing or cleaning the objective aperture, it is necessary to adjust the objective aperture position. It is ideal to set the objective aperture at the center of the objective polepiece. When the aperture shifts from this position, however, the astigmatism of the image becomes extremely high, making it impossible to obtain high-resolution images.

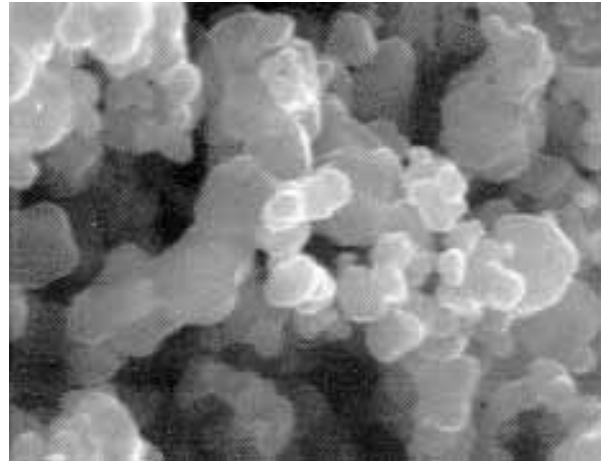

(a) Incorrect alignment

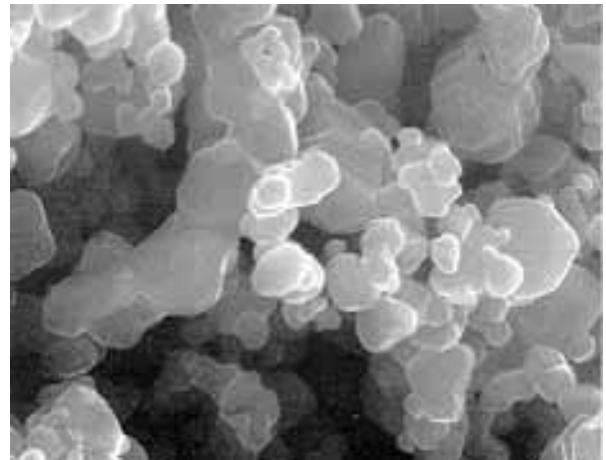

(b) Correct alignment

*Fig. 46. Specimen: Zinc oxide.
25 kV x21,000
Influence of alignment on the image*

4-3 10 kV discharge of detector

The secondary electron detector and CRT are supplied with a high voltage, 10 kV. The poor connection of cables, exfoliation of the fluorescent paint, and the presence of dust on the metal ring and fluorescent plane of the detector can all cause discharges.

The images below show images under a 10 kV discharge. The effect appears to be similar to those of unusual accelerating voltage unsatisfactory gun emission and specimen charge-up. The difference from their effect is that only brightness is changed, with no defocusing, image cut and image shift observed.

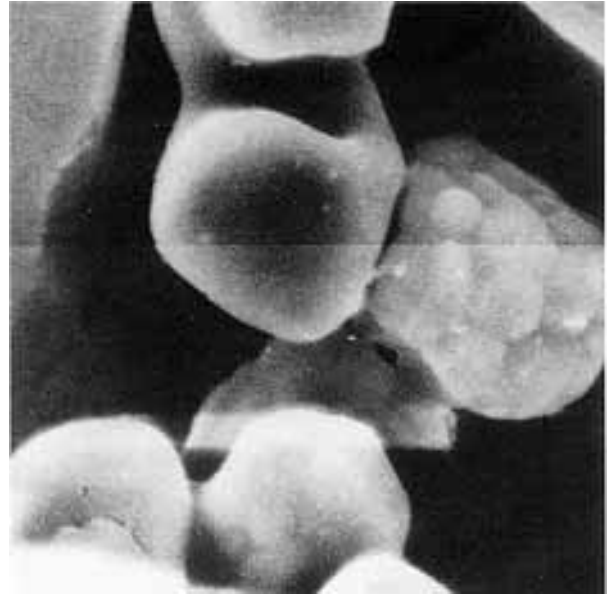

(a) Discharge of a detector

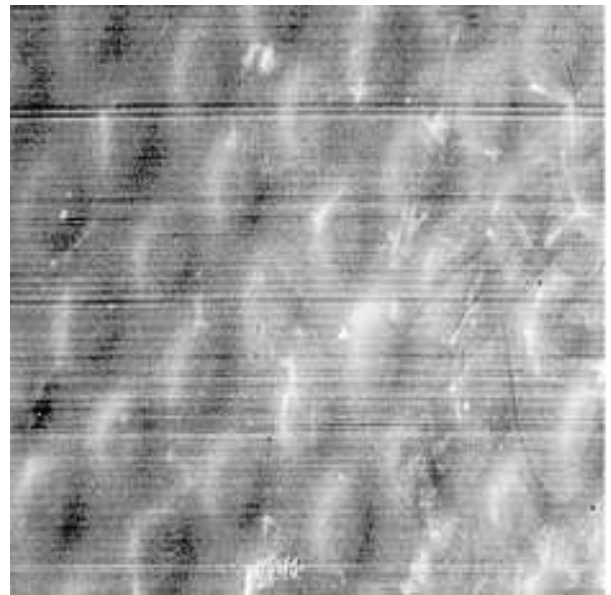

(b) Discharge of CRT

Fig. 47. 10 kV discharge of detector and CRT.

4-4 Burnt and dusty CRT surface

After long usage, the surface of the CRT becomes dusty and should be cleaned from time to time. The black dots and lines in the images below were caused by CRT burn-out due to excessive brightness or by dust.

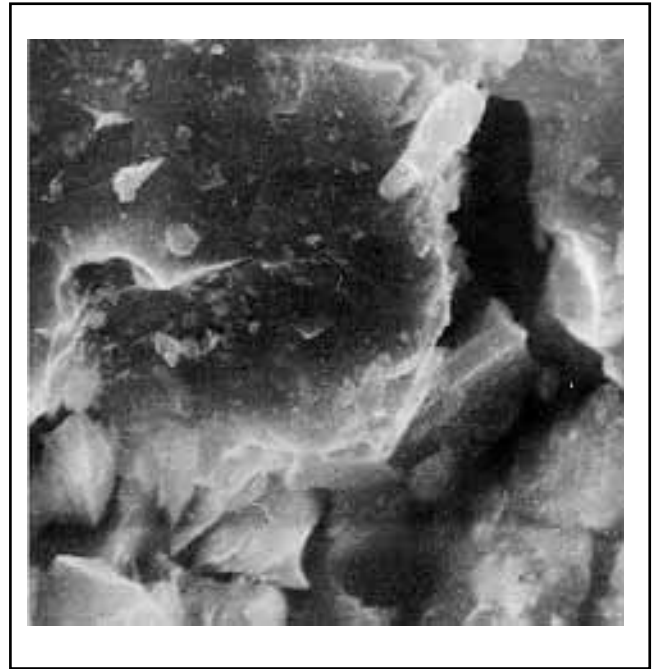

*Fig. 48. Burnt or dusty CRT
Stripes can be seen (lower) and several burnt traces (center).*



Fig. 49. The two black lines (center) are burnt traces of line scan.

Technical terms:

SEM:

Scanning electron microscope

Probe current:

The total amount of current to be irradiated on the specimen. It is controlled between approx. 10-12A to 10-6A. The control is done by varying the excitation of the SEM's condenser lens. The name of this knob with this function varies with the type of the instrument having that function, like CONDENSER LENS, PROBE CURRENT and SPOT SIZE.

SEI: Secondary Electron Image:

Secondary electrons are excited secondarily by electrons incident on the specimen. Since their generation region is as shallow as approx. 10 nm, the diffusion of incident electrons within the specimen has little influence on the image, thus allowing the best resolution to be obtained.

The contrast of secondary electron images depends mainly on the tilt angle and topography of the specimen surface.

BEI: Backscattered Electron Image:

After incident electrons are scattered within the specimen some of them are backscattered while keeping a relatively high energy and emitted again from the specimen surface. These electrons are called backscattered electrons. The contrast of the backscattered electron image depends on the topography of the specimen surface and on the mean atomic number of the substances which constitute the specimen. Use of a paired detector allows separate observation of a topography (TOPO) image and a composition (COMPO) image.

X-ray image:

A mapping image used to investigate the distribution of a characteristic X-ray image of a specific element.

Under-focus and over-focus:

When objective lens excitation is weakened below the just-focus position, the focal point position lowers below the specimen surface. This focus state is called "under-focus." "Over-focus" opposite to "under-focus," is caused when objective lens excitation is intensified.

CL and OL: Condenser lens and objective lens:

CL controls the probe current and OL focuses the electron probe on the specimen surface.

WD: Working distance:

The distance from the underside of the objective lens to the specimen surface.

Probe diameter:

Generally, this means the minimum probe diameter that depends on the accelerating voltage, probe current, and working distance.

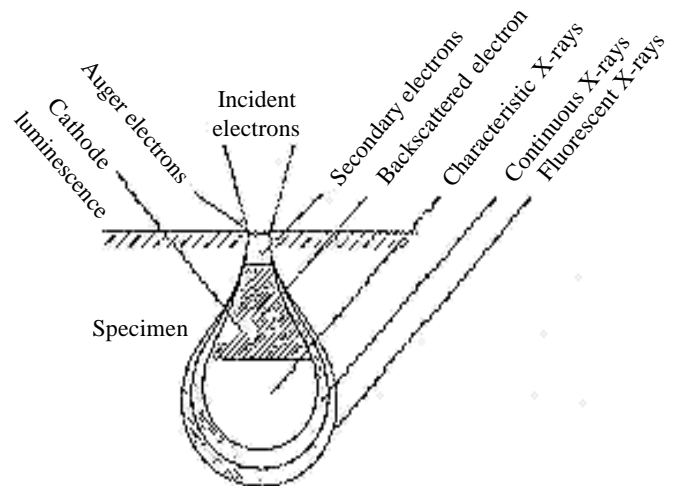

Fig. 50. Interaction between incident electrons and specimen.

Concluding Remarks

Today, as the SEM comes into wider usage, quality images can be obtained even with the minimum necessary operation skills and knowledge.

This publication is concerned primarily with issues related to image quality with the understanding that even beginners can understand matters concerning SEM images and take satisfactory photos.

Also, the photos in this publication were taken with various types of instruments.

References

1. *EPMA Specimen Preparation Technique*, (issued by JEOL DATUM)
2. *On the Preparation of Analytical SEM Specimens*, (published by JEOL DATUMN)
3. *Questions and Answers on Scanning Electron Microscopes*, Vol. 1.2. (published by JEOL LTD)
4. *Fundamentals and Applications of Scanning Electron Microscope*, (published by Kyoritsu Publishing Co., Ltd. and edited by the Kanto Branch of the Japanese Society of Electron Microscopy)

