

SEM **Q&A**

–Unauthorized use prohibited–
JEOL Ltd.

JEOL is always making efforts to meet the needs of our customers in all areas including hardware and software of our instruments. Our efforts to grasp customer requirements include question and answer opportunities during technical seminars and meetings. Based on these questions, we have published this Q&A book.

We hope this book will help you solve various problems encountered during your daily research. Also, we would appreciate it if you could give us constructive comments to refine the contents of this book.

JEOL Ltd.

JEOL DATUM Ltd.

Contents

Principle of SEM	5
Specimen Preparation Methods	
Q 1 . How to observe a biological specimen containing water?	6
Q 2 . In the observation of a water-containing specimen, what is the difference between the cryo method and the low vacuum (LV) method, and what is the maximum magnification in each method?	7
Q 3 . How to prepare a cross section of a specimen consisting of rubber sheets and resin layers that are glued together?	8
Q 4 . How to cut a thin metal film on an insulating substrate such as glass together with the substrate? How to observe the thin metal film without coating?	9
Q 5 . How to prepare a cross section of a Si wafer or other wafers?	10
Q 6 . How to mount powder sample on a specimen stub?	11
Q 7 . How to prevent the aggregation of particles when mounting the powder on the specimen stub using organic solvent?	12
Q 8 . What is the appropriate thickness of the coating?	13
Q 9 . What is the difference between sputtering device and vacuum evaporator?	14
Q10. Which coating material is best suitable for my application?	15
Principle and How To Use the SEM	
Q11. How to select the accelerating voltage? What are the merits of high accelerating voltage and what are the merits of low accelerating voltage?	16
Q12. What is the saturation of the electron gun? How to saturate it?	18
Q13. How to use the spot size?	20
Q14. How to distinguish charging?	22
Q15. Is it possible to observe a nonconductive specimen without coating?	23
Q16. How to prevent the charging and take a fine photo?	24
Q17. What is necessary to observe a beam sensitive specimen?	26
Q18. For a non-conductive specimen, what is the difference between observation at a low accelerating voltage and observation in the low vacuum (LV)?	27
Q19. How to observe an out-gassing specimen?	28
Q20. How high is the temperature rise of a specimen due to the electron beam irradiation during the observation?	29
Q21. What is specimen contamination? How to reduce contamination?	30
Elemental Analysis	
Q22. How to determine the exposure time of X-ray area analysis (mapping image)?	31
Q23. How to reduce analysis volume in elemental analysis?	32
Q24. How to obtain good qualitative analysis by EDS?	34
Q25. How to perform quantitative analysis?	36
Q26. How is the accuracy of quantitative analysis in elemental analysis by EDS?	37
Q27. What is the difference between elemental analysis by EDS and by WDS?	38
Q28. Is it possible to analyze foreign materials in resin?	39
Other	
Q29. How to perform a stereoscopic observation using a SEM?	40
Q30. How to quantitatively know the height difference on the specimen?	41

Principle of SEM

● Information obtained by electron beam irradiation

When a specimen is irradiated with an electron beam, interactions between the incident electrons and the constituent atoms in the specimen produce various signals, as shown in the following two figures. The left figure illustrates the kind of signals obtained, whereas the right figure indicates the volume within the specimen where these signals are generated.

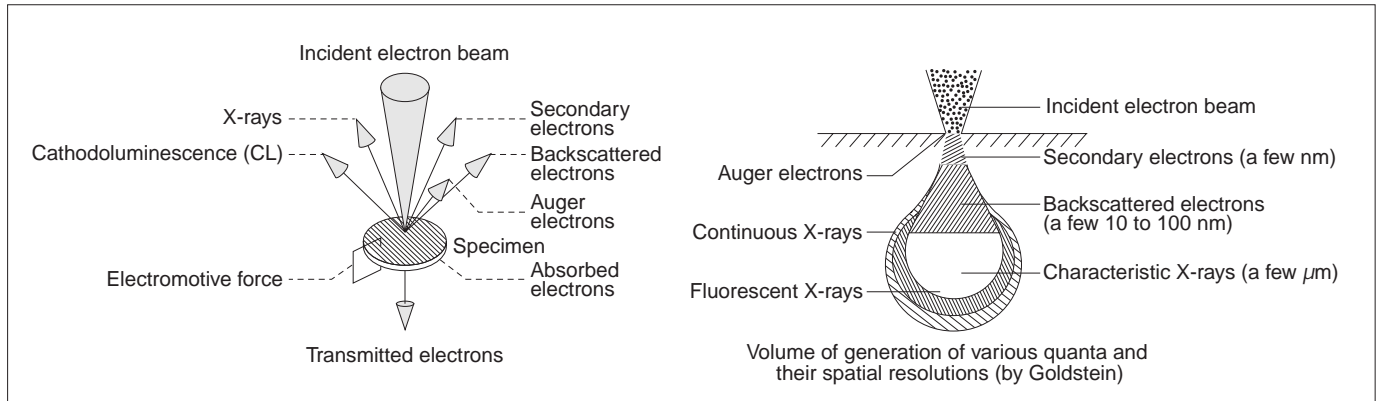

● Image enlargement

When scanning a finely focused electron beam (a few nm in diameter) on a specimen surface various signals (secondary electrons, backscattered electrons, etc.) are emitted from each irradiated point. These signals are detected, converted into electric signals, amplified, and then fed into a display unit (observation CRT or LCD monitor). These signals are used to modulate the intensity (brightness) of the CRT or LCD. Since the scanning on the display unit is synchronized with the electron beam (probe) scan, the irradiated point on the specimen corresponds to that on the display unit. The type of the obtained image (morphological or compositional image) can be changed by switching the signal. The magnification of the SEM image is determined by the ratio of the horizontal size of the monitor screen to the scan width of the electron probe.

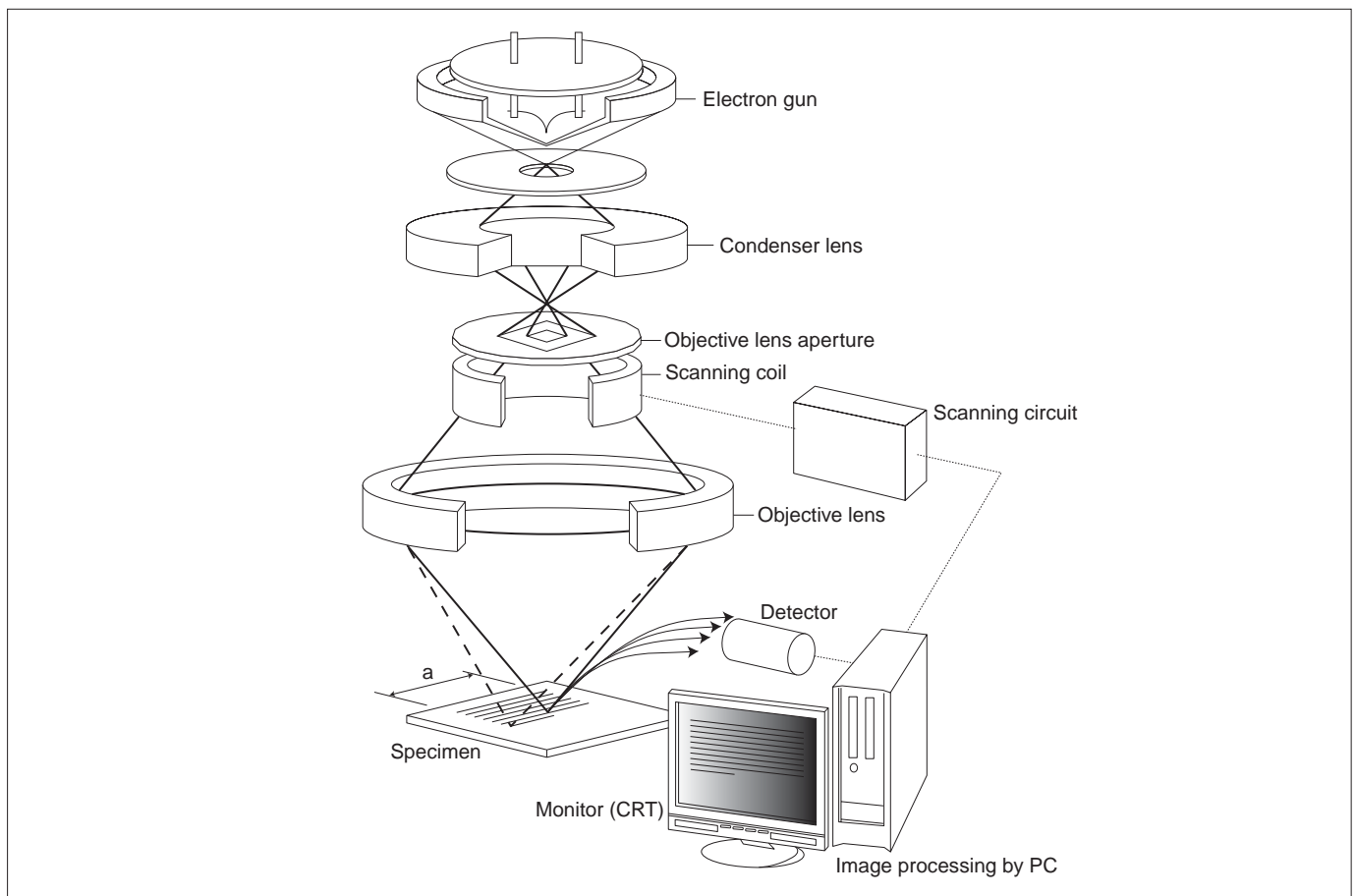

Specimen Preparation Methods

Q1 How to observe a biological specimen containing water?

A Methods of observing a biological specimen containing water are classified roughly into the following four ways. You should select the most appropriate method according to the purpose and the state of the specimen. The features of the methods are as follows.

(1) Observe a specimen in situ

When you only need to observe a live insect or a fresh pollen at a low magnification, you can observe it at a low accelerating voltage (1 to 2 kV) in a short time. Also, when you observe a specimen such as a cluster of fungi where it is undesirable to apply chemical processing (fixation), you can observe it in situ.

(2) Observe a specimen using the low vacuum (LV) method

Depending on a specimen, you may not be able to perform chemical fixation nor cryo observation. In such a case, you can observe the specimen by maintaining the specimen chamber at low vacuum.

(3) Observe a specimen using the cryo method

This method basically freezes the water content of a specimen to observe the specimen. You must pay attention to the formation of ice crystals.

(4) Observe a specimen using chemical fixation

In order to maintain the original shape of the specimen as far as possible while in the vacuum, perform the following processings.

Fixation: This process fixes protein and fat with glutaraldehyde and/or osmium tetroxide.

Dehydration: This process replaces water content in the specimen with ethanol.

Drying: This process removes organic solvent such as ethanol. It uses the critical point drying method or the freeze-drying method so that the deformation of the specimen due to surface tension does not occur during the drying process.

Although the time required to make such a specimen preparation differs depending on the specimen, it takes 2 to 3 hours for each process.

Each of the four methods enables you to obtain the highest magnification.

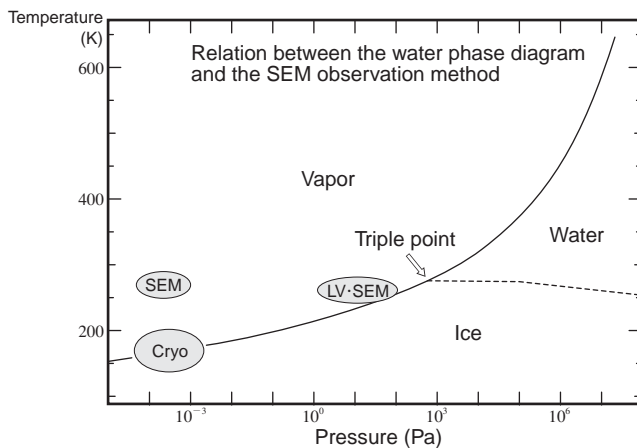

The figure above schematically shows the phase of water at different atmospheric pressures and temperatures.

The environments in specimen chamber for the SEM (including high and low accelerating voltages), Cryo-SEM and LV-SEM are marked.

As shown in the figure above, normally, you cannot observe water as a liquid in the SEM vacuum. Therefore, you must remove the water or perform physical fixation (freeze) of water. That corresponds to the process of Fixation → Dehydration → Drying or Cryo-SEM.

In exceptional cases, you can observe a specimen with a strong structure (no shrinkage when water evaporates) using an LV-SEM or observe it at a low accelerating voltage without coating.

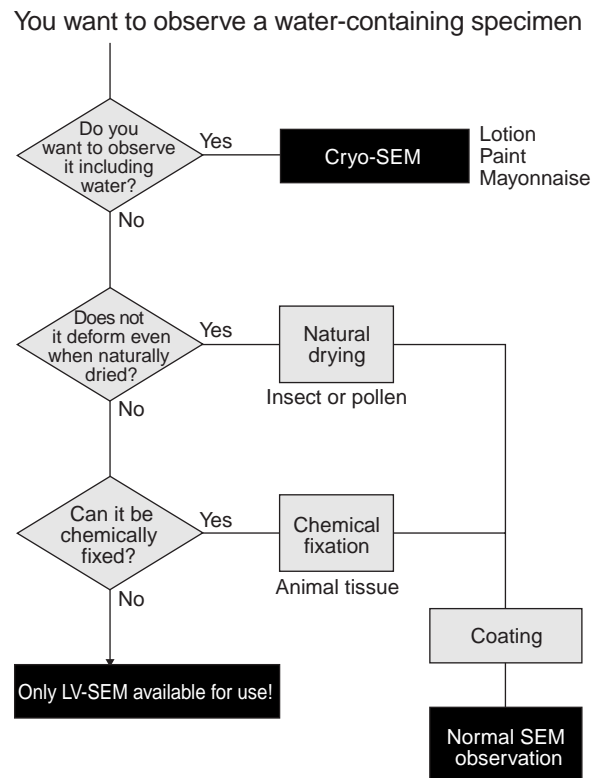

Q2 In the observation of a water-containing specimen, what is the difference between the cryo method and the low vacuum (LV) method, and what is the maximum magnification in each method?

A Decide which method you use according to the state of the specimen and the purpose of the observation.

Cryo method

- (1) You can obtain a good result for emulsion of cosmetic or paint. The magnification is normally up to a few tens of thousands times.
- (2) It is also effective when you need to analyze elements by freezing a liquid specimen.

Low vacuum (LV) method

- (1) You can relatively easily observe a specimen such as plant and analyze elements. You must observe in as short a time as possible. When you freeze the specimen, you can set the observable time longer.
- (2) You can observe in situ a specimen such as a biological specimen on a slide glass prepared (stained) for an light microscope. It is a feature of this method that you can easily compare an light microscope image with a SEM image.
- (3) Although the maximum observable magnification depends on the amount of backscattered electrons and the pressure of the low vacuum, it is possible to increase the magnification from a few thousands times to a few tens of thousands times.

It is not easy to observe gelatinous specimens such as soybean curd using either of the above methods. It is also necessary to obtain the most natural state by checking the results by means of various methods (such as the results observed using a transmission electron microscope after making a frozen replica).

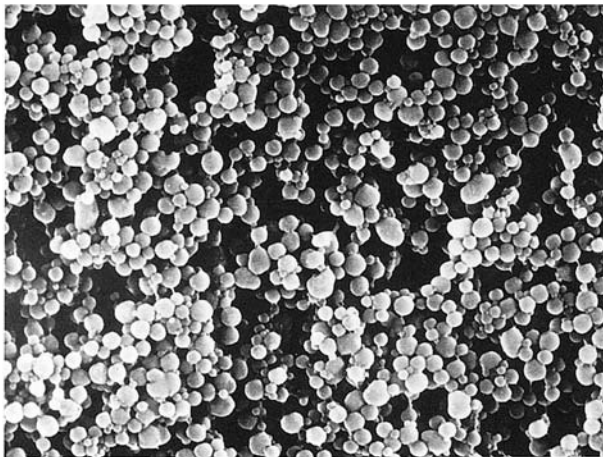

Lotion with the cryo method.

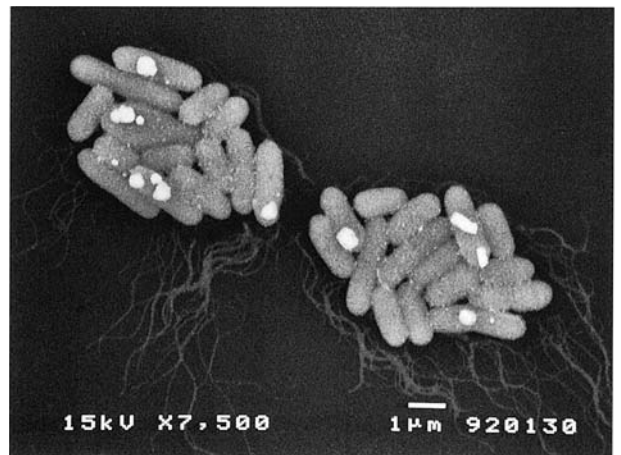

Bacteria on the slide glass stained for the light microscope at low vacuum (LV) without coating.

Q3 How to prepare a cross section of rubber sheets and resin layers that are glued together?

A Several methods are available.

(1) Preparing the cross section using a knife

Perform this method by taking the orientation of the specimen and the moving direction of the knife into account; align the same specimens with each other or stack several sheets cut from the same specimens together and cut the specimens. This method is simple and easy, but sometimes, you might have a knife mark on the specimens.

(2) Cutting the specimen in liquid nitrogen

If the specimen hardens in liquid nitrogen, make a cross section by cutting it with this method. You need not worry about leaving knife marks, but sometimes a slight unevenness might remain on the surface of the specimen (you can more easily observe the specimen with an uneven surface when using the SEM).

(3) Making a cross section using a microtome

You can make the clearest surface with this method. If there is a large difference in hardness between rubber sheet and a resin layer, this method might be difficult. In addition, if the specimen is soft, you must use a cryo microtome. Depending on a specimen, you need to embed the specimen. Some specimens need staining with osmium and ruthenium to increase the hardness of the specimen.

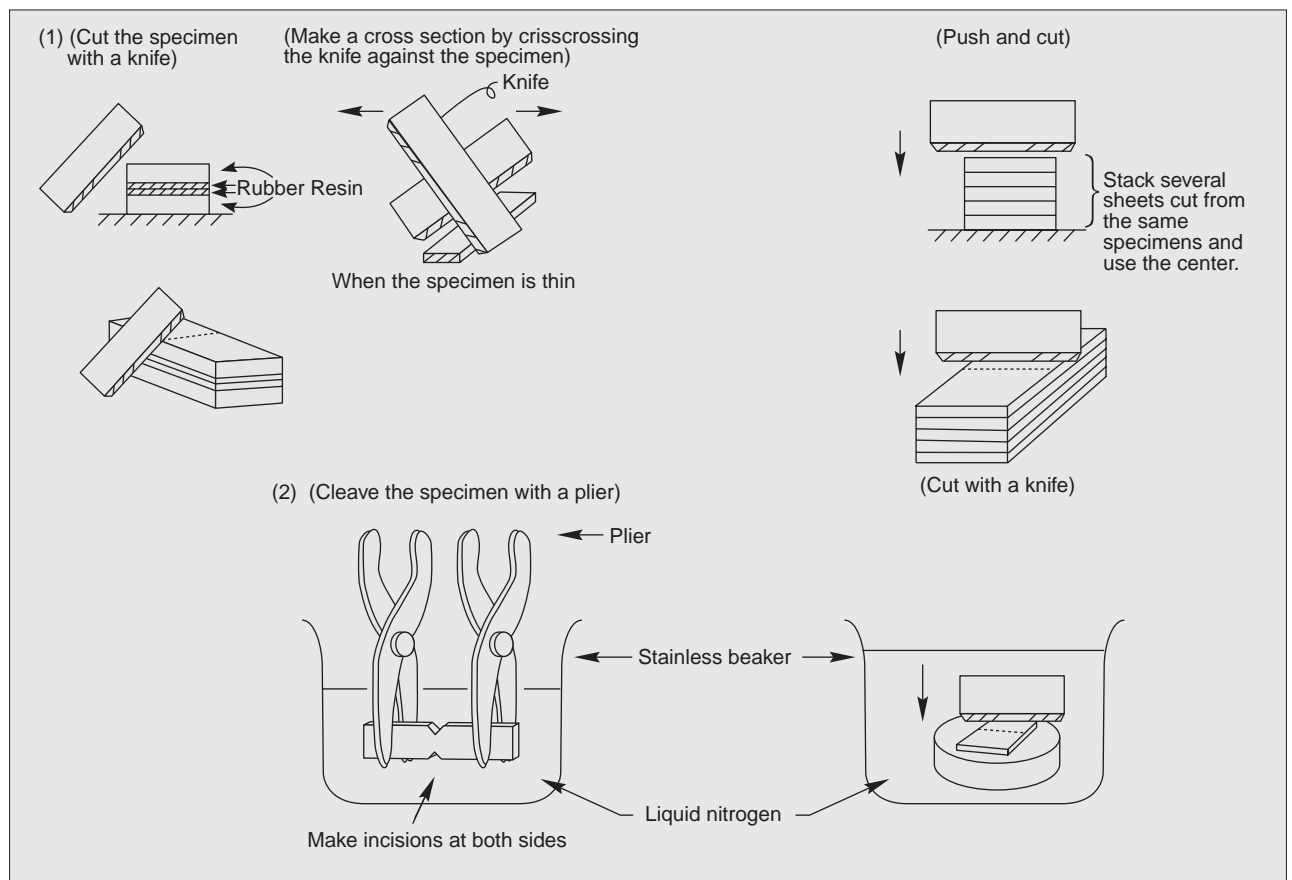

Q4 How to cut thin metal film on an insulating substrate such as glass together with the substrate?

How to observe the thin metal film without coating?

A (1) To prepare a cross section, there are two methods; one method is to scratch the surface of the substrate with a glass cutter and to cleave the substrate using a special plier. The other method is to place a fine wire beneath the scratch of the substrate and to cleave the substrate by pushing down on both sides of the wire. In either method, a large force is required to cleave the substrate when the glass is thick.

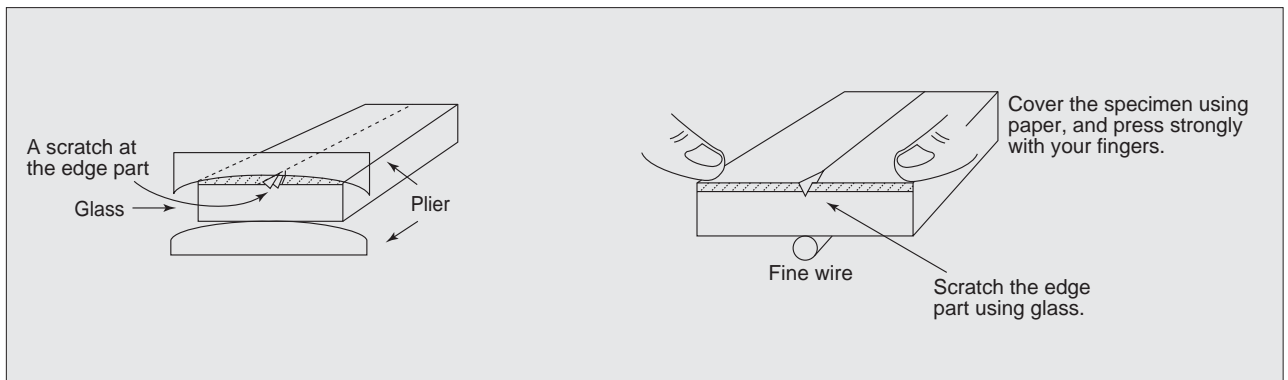

(2) When you observe the specimen, it is important to select an accelerating voltage that charges the specimen as little as possible. The electron-beam scans from the left top to the right bottom on the observation screen. If you consider the scan direction when you arrange the orientation of the specimen, you can suppress the distortion of the image due to charge-up at minimum. For example, it is useful to place the thin metal film part on the top of the monitor so that the electron beam irradiates this part first and then irradiates the insulator part.

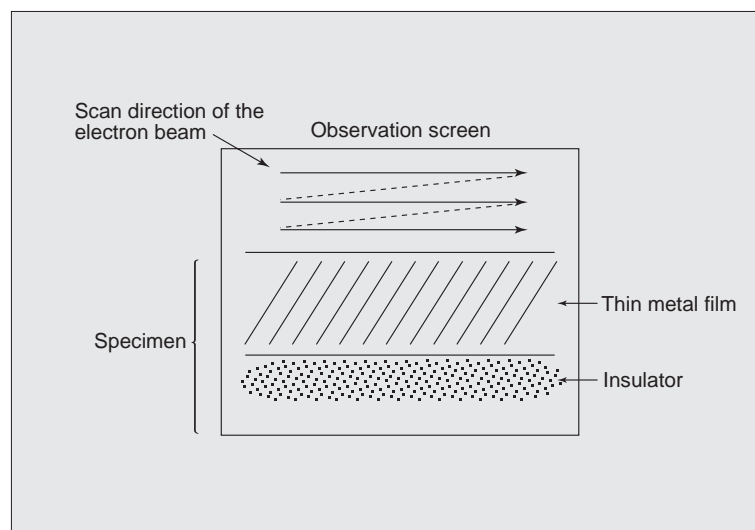

Q5 How to prepare a cross section of a Si wafer or other wafers?

A (1) For a Si substrate or the one with resist deposited, you can make a good cross section using the following method.

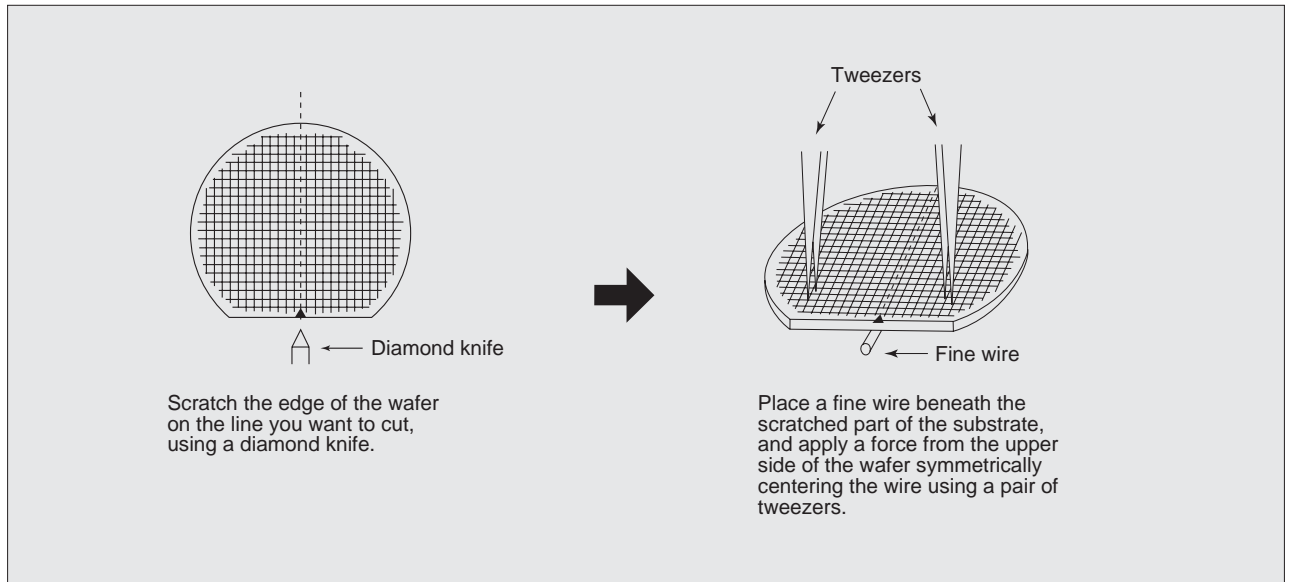

(2) If the specimen has wires or metal layers of Al, Cu, Au, etc., it is difficult to make a clear cross-sectional surface because these metals have ductibilities.

(3) According to the circumstances, you can use a microtome to make a cross section.

Q6 How to mount powder sample on a specimen stub?

A Various adhesive agents are used to mount a powder sample on a specimen stub. An adequate adhesive agent is one that has a strong adhesive power and is flat enough, and also generates secondary and backscattered electrons as few as possible.

(1) When the particle size is less than a few micrometers

Dry very thin layer of manicule, and sprinkle powder on the manicule. If you dry the manicule too much, the sample do not stick to the specimen stub; and if the drying is not enough, particles might be embedded in the manicule. In addition, if the manicule layer is too thick, the beam might damage the manicule, causing the manicule to crack during the observation at a high magnification.

- The particle might deform due to the influence of the manicule solvent.
- When particle is small, you can put a drop of liquid suspending powder directly on a sheet such as aluminum foil and mount it on a specimen stub.

(2) When the particle size is a few micrometers

Use a double-sided tape and sprinkle powder on the tape. Take care that the tape does not stick out the specimen stub (recently, a conductive double-sided tape became commercially available).

- You can spread powder on liner paper of a double-sided tape, and press it on the block of the specimen stub.

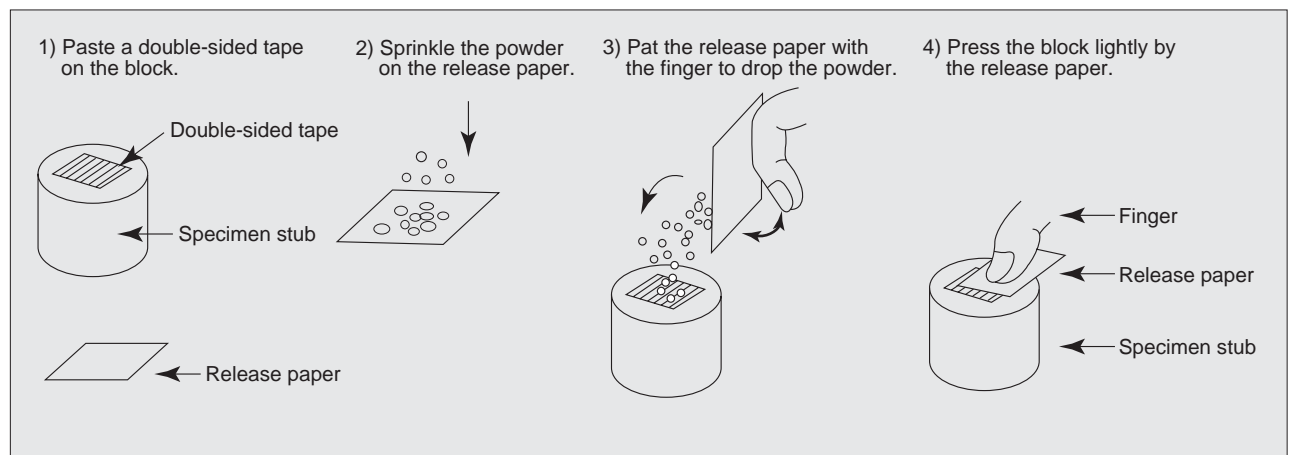

(3) When the particle size is a few 10 micrometers or more

Apply carbon paste uniformly on the block and sprinkle powder on it.

Silver paste is not suitable for fixing the powder, because the size of the silver particle is large and the generation of secondary electron is large.

After sprinkling the power, when you lightly press the powder using the liner paper of a double-sided tape (after blowing away the excess particles), you can decrease the charging on the specimen.

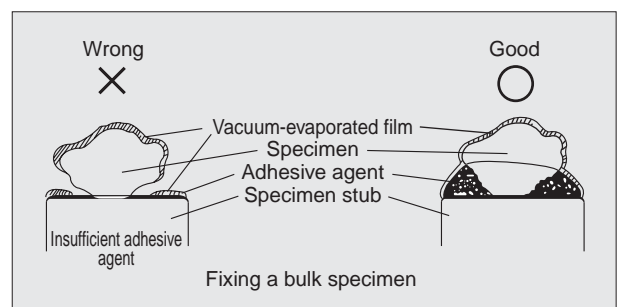
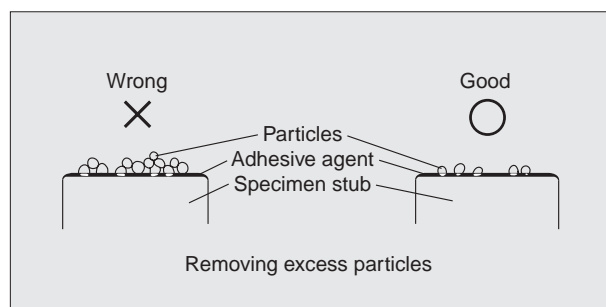

Q7 How to prevent the aggregation of particles when mounting the powder on the specimen stub using organic solvent?

A You need to treat a specimen stub to make it hydrophilic. The particles clump together when liquid is dried due to a hydrophobic specimen stub. You can make carbon film or the surface of a slide glass hydrophilic in glow discharge. In this treatment, the HDT-400 Hydrophilic Treatment Device is used.



HDT-400

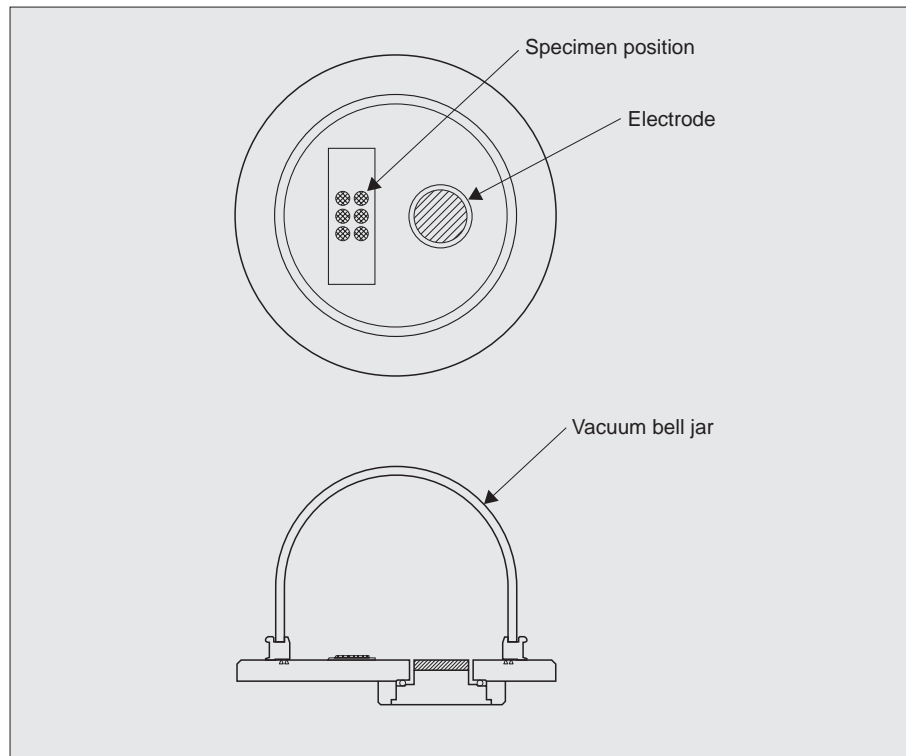

Q8 What is the appropriate thickness of the coating?

A Ideal thickness is 10 nm or less.

- Sputter coater -

- (1) The secondary electrons are generated from the region of about 10 nm deep from the specimen surface, so if the specimen is relatively flat and the coating thickness is 10 nm, you can obtain sufficient conductivity and the image contrast is enhanced.
- (2) If the surface is rough and you cannot suppress charging with a single 10 nm coating, apply additional coating two to three times by changing the orientation of the specimen to stop the charge-up (because the coating thickness is the value calibrated with a flat surface, a particularly uneven specimen surface requires two to three times of coatings).

- Vacuum evaporator -

- (1) The thickness of vacuum evaporated film is determined by the amount of evaporated metal and the distance from an evaporation source to a specimen.

$$t = \frac{d^2 \cdot \ell}{16R^2}$$

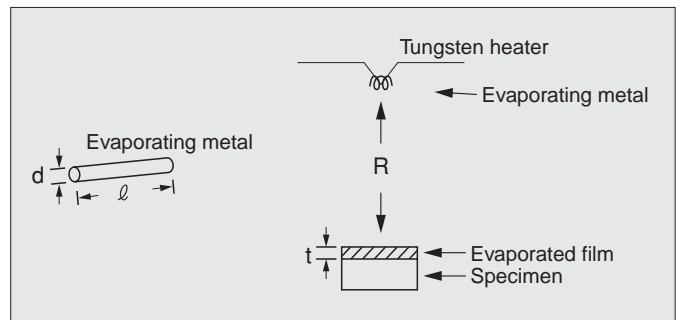

- (2) When you use a basket heater in place of a V-shaped tungsten heater, it becomes

$$t' = \frac{3}{4} \cdot t$$

Note) JEOL Datum provides the color sample for estimating the film thickness.

Q9 What is the difference between a sputtering device and a vacuum evaporator?

A There are two methods for making a non-conductive specimen conductive by putting a metal thin film on the specimen surface for the purpose of morphological observation using a SEM.

	Classification by structure	Coating material	Suitable for	Model name
Vacuum evaporation		C Au Al Cr	Elemental analysis, observation of backscattered image } Elemental analysis of carbon, etc.	JEE-420 JEE-420T
Sputtering	Counter electrode type	Au Au-Pd	General SEM observation	
	Magnetron type	Au Au-Pd Pt Pt-Pd	Specimens susceptible to thermal damage } The SEM observation at high magnifications (a few tens of thousands times)	JFC-1600
	Ion beam sputter	Au, Au-Pd Pt Pt-Pd Cr	The high magnification observation by FE-SEM (a few tens of thousands times to a few hundreds of thousands times) The high magnification observation by FE-SEM for the specimen with good granularity	

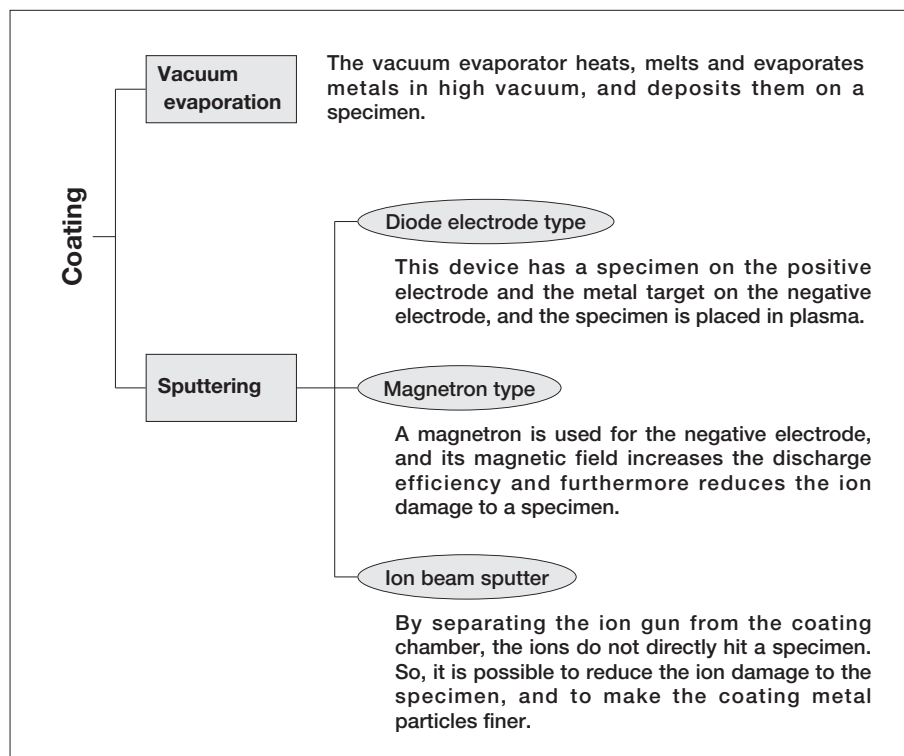

Q10 Which coating material is suitable for my application?

A Coating is applied to make a nonconductive specimen conductive and to increase the generation of secondary electrons. Therefore, select the appropriate coating material for the following reasons: good conductivity, good emission rate of secondary electron, chemical stability and low price.

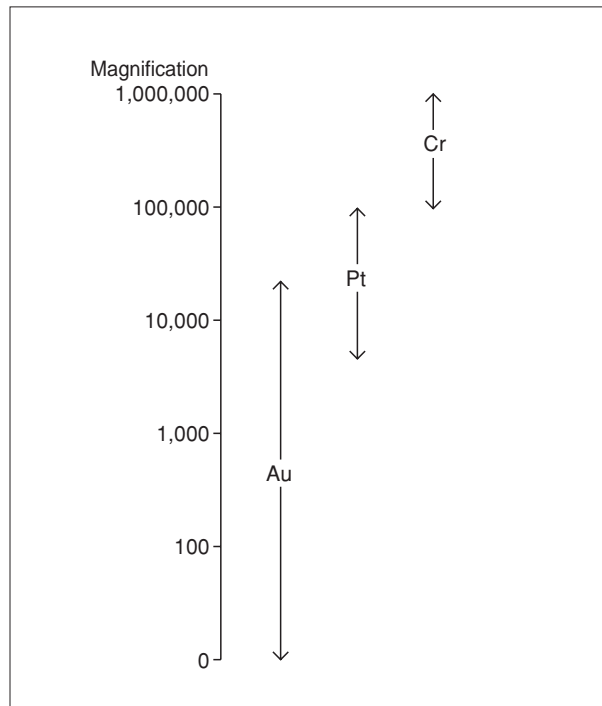

Fig.1 Usage of the coating material according to the granularity (for the SEM observation).

Purpose	Major coating material
SEM observation (secondary electron image)	Au, Pt, Au-Pd
Observation of backscattered electron image	C
Elemental analysis	C, Al, Au
Magnetic domain or channeling pattern of nonconductive specimens	C

Fig.2 Selection of the coating material according to the purpose.

Q11 How to select the accelerating voltage?

What are the merits of high accelerating voltage and what are the merits of low accelerating voltage?

A

- The accelerating voltage sets the energy of the incident electrons entering the specimen.
- Generally, a low accelerating voltage (5 to 10 kV as a guideline) is recommend for specimens having low density such as plastic, paper or a biological specimen, and a high accelerating voltage (15 kV as a guideline) for specimens having high density such as metal.
- When you need to analyze the elements of the specimen, you must use an accelerating voltage sufficient to generate the X-rays of the elements you want to detect.

Merits of high accelerating voltage

- (1) At a high accelerating voltage, it is easier to get finer electron beam and the resolution increases.
- (2) When the energy of the electron beam is high, it enters deeply inside the specimen; and it increase the edge effect and charge up on the specimen surface.
- (3) When there is a few 10 to a few 100 nm protective film (such as SiO₂) on the surface of a specimen such as an IC chip, charging might occur at a low accelerating voltage, however, if you use a accelerating voltage high enough to pass the beam through the protective film, you can observe the specimen without the effect of charge.

Merits of low accelerating voltage

- (1) When you set a low accelerating voltage, the electrons entering inside the specimen become shallow, and the information near the surface of the specimen is emphasized.
- (2) When you set an extremely low accelerating voltage (around 1 kV), you can observe a nonconductive specimen without conductive coating.
- (3) Generally, specimen damage is reduced at a low accelerating voltage.
- (4) The resolution at a low accelerating voltage is poor compared with that at a high accelerating voltage.

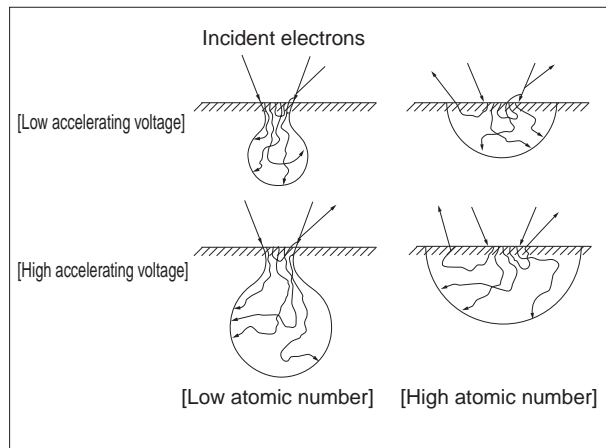

Fig.1 Diffusion of incident electrons (by Duncumb and Shields).

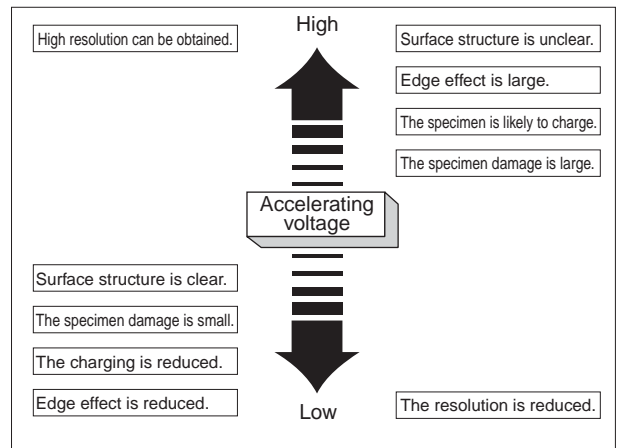
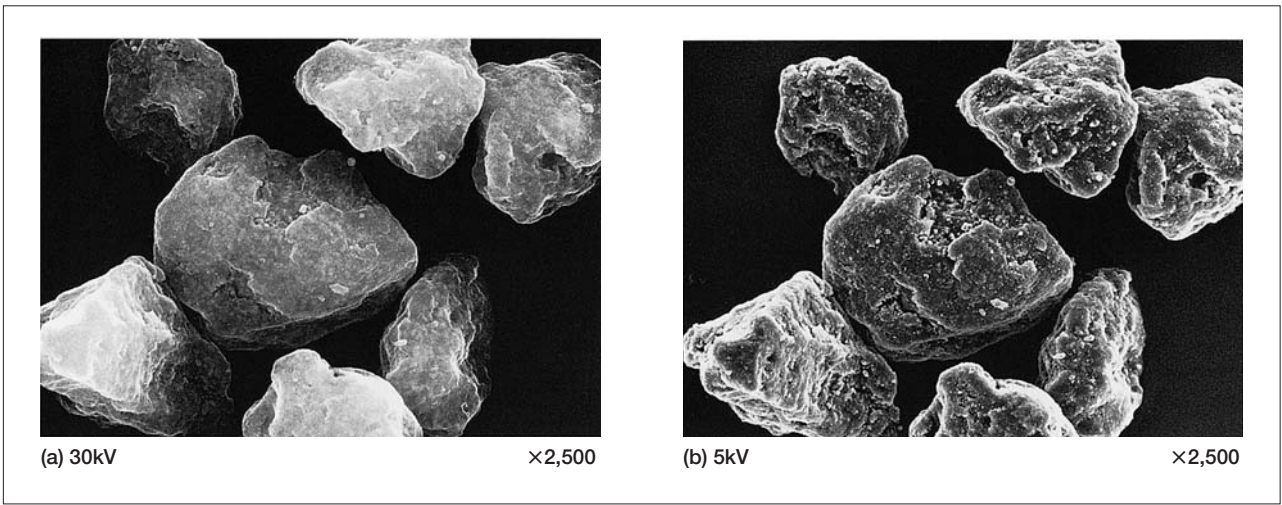
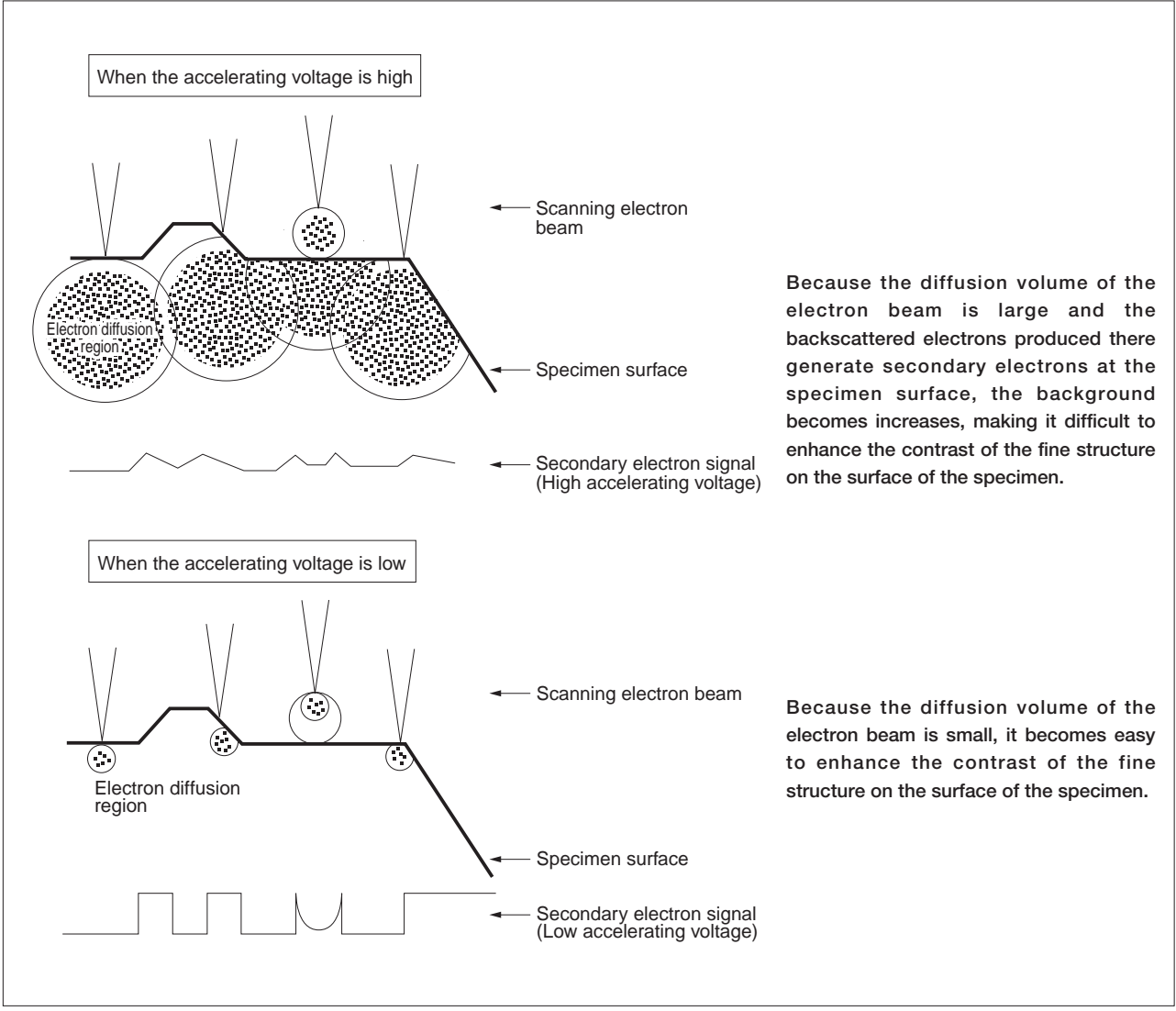

Fig.2 Effect of the accelerating voltage.



Specimen: Toner

(a) The use of a high accelerating voltage makes it difficult to enhance the contrast of the fine structure on the surface of the specimen. Also, charging is likely to occur.

(b) This figure clearly shows the fine structure on the surface of the specimen.

Q12 What is the saturation of the electron gun? How to saturate it?

A

- (1) When you heat the filament of the electron gun, the filament emits electrons; and when you increase the temperature of filament to a certain temperature, there is a state that the amount of emitted electrons becomes constant. This state is called the saturation state in which the electron beam is the most stable.
- (2) The electron gun generally used in SEM is a self-bias type electron gun, and the Figure 1 shows a schematic diagram. A negative voltage (bias voltage) is applied between the filament and the grid (Wehnelt) by means of the bias resistance between the filament and the grid.
- (3) Adjust the bias voltage so that the emission current becomes 50 to 100 μ A; however, the greater the emission current, the shorter the filament life.
- (4) For aligning the optical axis, align the optical axis so that the probe current changes as shown in Fig. 2 as you gradually increase the filament current, when the optical axis is not aligned, the probe current changes as shown in Fig. 3, so align the optical axis. Actually, set the filament current to position B and adjust the optical axis alignment knob so that the probe current becomes the maximum.
- (5) After aligning the optical axis, set the filament knob to the start point of saturation (S point in Fig. 2).

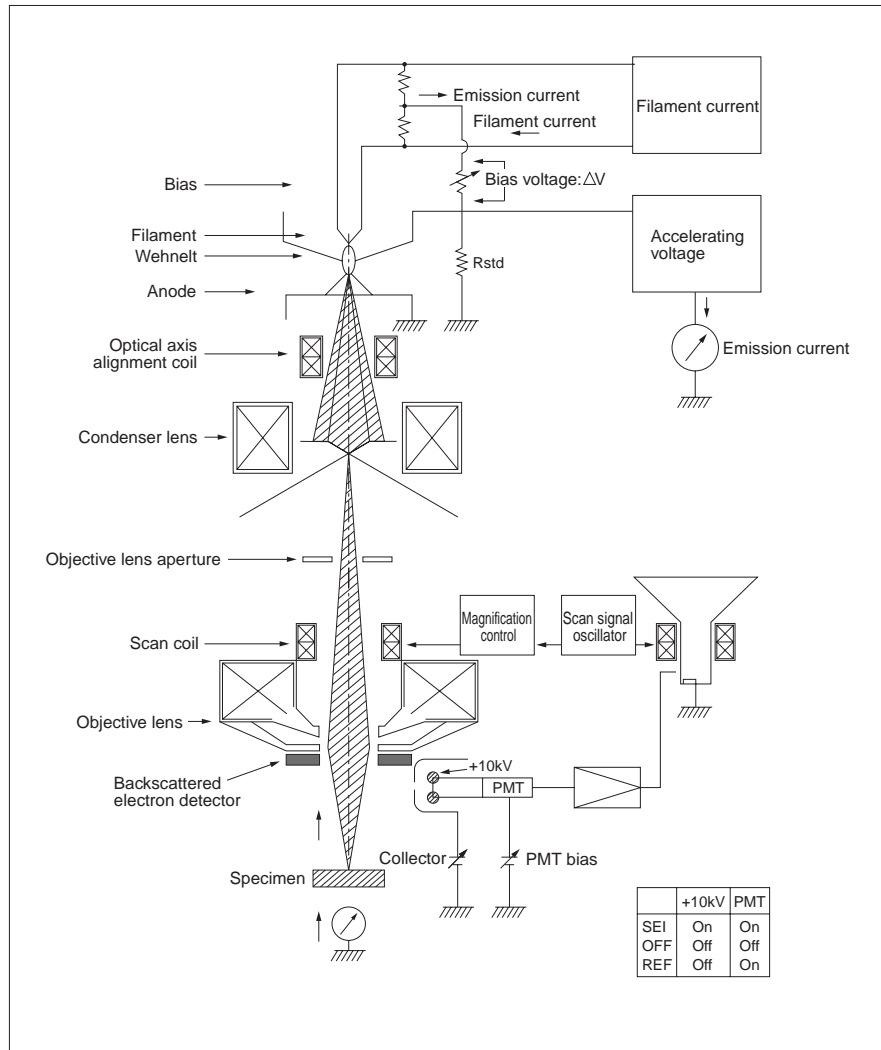

Fig.1

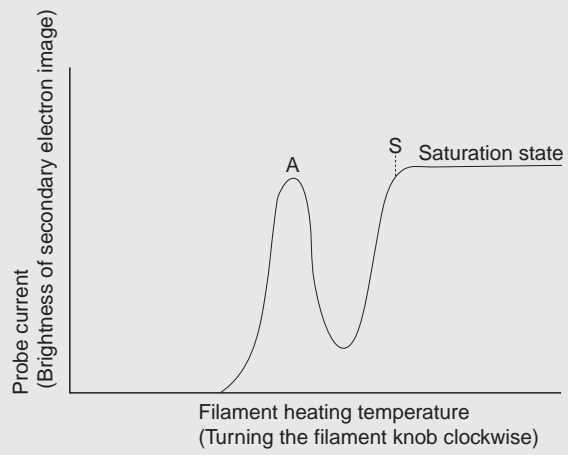

Fig. 2 Relation between the filament heating temperature and the probe current when the optical axis alignment has completed.

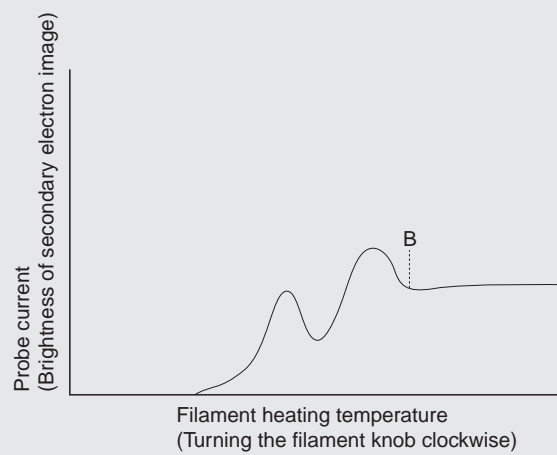

Fig. 3 Change of the probe current when the optical axis alignment is incomplete.

Set the filament current to near the filament heating temperature point B, and adjust the optical axis alignment knob so that the probe current becomes the maximum and that finally, the probe current changes as shown in Fig. 2.

Q13 How to set the spot size?

A The condenser lens converges the electron beam generated from the electron gun to a fine electron beam. The knob for changing the condenser lens is the "spot size". When you decrease the spot size, the electron beam diameter is reduced and the probe current is also reduced at the same time.

- (1) When you need a photo at a high magnification, use a small spot size that is enough to confirm the image with the slow scan (when you capture an image at the magnification of $\times 50,000$, set the spot size at 8 to 9 o'clock).
- (2) When you take a photo at a low magnification, you can obtain a clear image at a larger spot size. Normally, for the observation of a secondary electron image, it may be enough to set the spot size at 12 o'clock. However, if the specimen is damaged by the irradiation of the electron beam, use a smaller spot size.
- (3) When you analyze elements or observe a backscattered electron image, normally use a larger spot size than that for a secondary electron image.

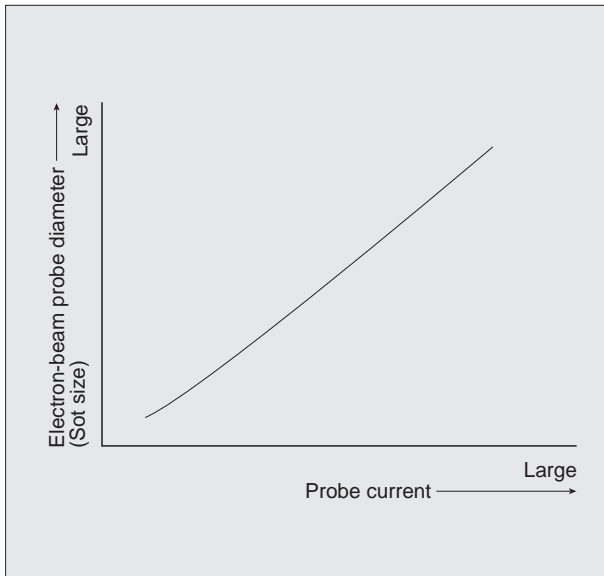

Fig.1 Relation between the probe current and the electron beam probe diameter.

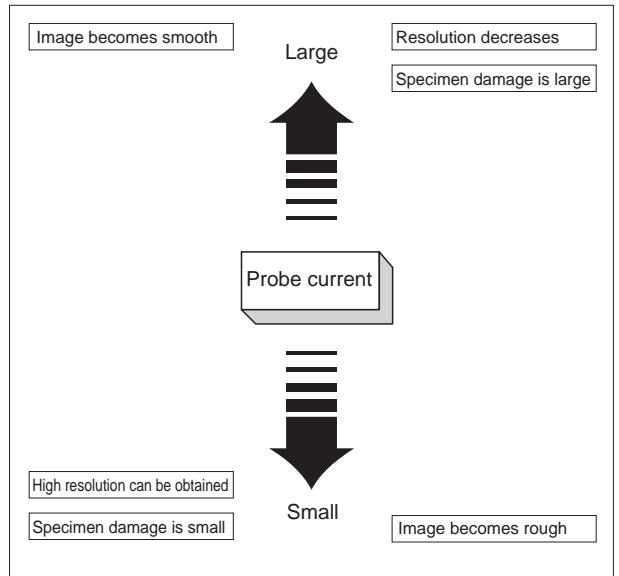

Fig.2 Effect of the probe current.

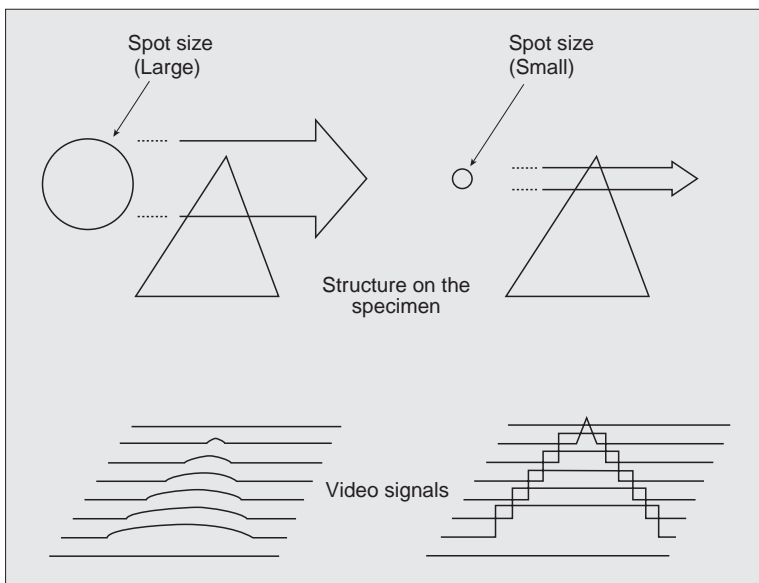
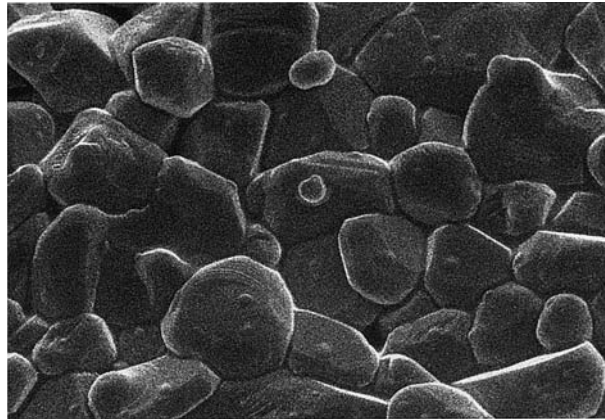

Fig.3

The upper figures shows the scanning of the electron beam.

The lower figures show the video signals change corresponding to the variations of the structure of the specimen. When the spot size is small, you can obtain clear signal change, making the contour of the structure clear.



(a) 10pA

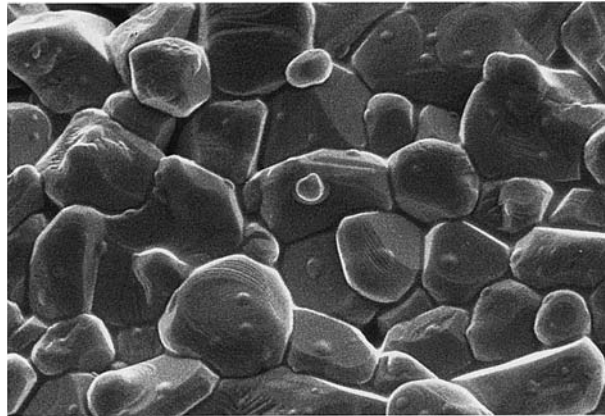

(b) 0.1nA

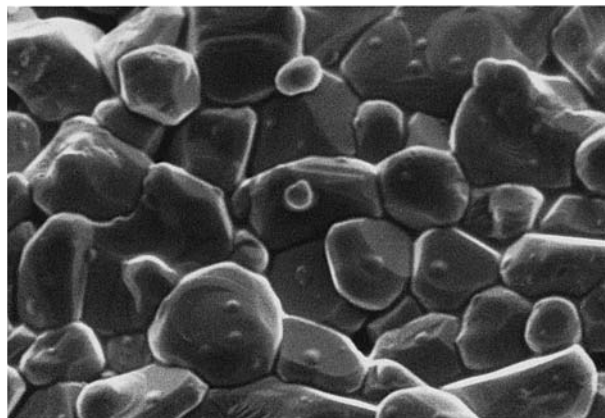

(c) 1nA

Fig.4 Specimen: Ceramics
10 kV $\times 5,400$
As you decrease the probe current, you can obtain a sharper image, but the surface smoothness is degraded.

Q14 How to distinguish charging?

A When you observe a powder sample or a biological tissue, sometimes you cannot take a fine photo because part of the image becomes excessively bright or dark. The reason why such a phenomenon occurs is that there is a nonconductive part on the surface of the specimen where the irradiated electrons are accumulated. This is called charge up. When an anomalous contrast appears, judge whether this contrast is caused by charging or caused by the fact that the contrast is simply high, in the following ways.

- (1) The contrast (bright and dark) changes as time passes, and these changes depend on the scan speed of the electron beam. Generally, charging increases more with the slower scan speed.
- (2) In the case of strong charging, sometimes, bright and dark bands appear in the horizontal direction (scan direction) of the screen, or an image shifts.

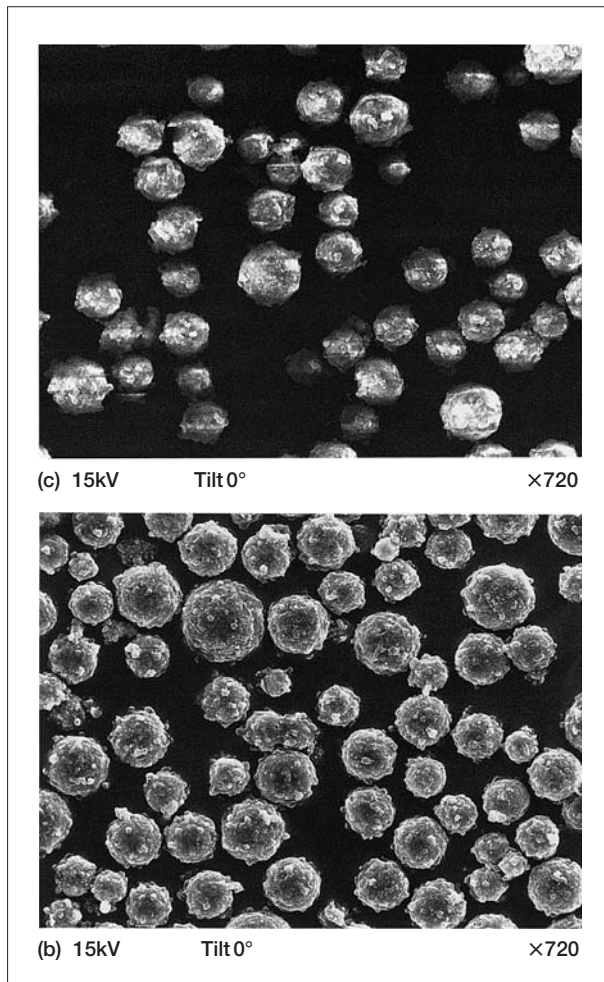

Fig.1 Specimen: Toner
The upper photo shows an example of a charged specimen, and image discontinuity and the variation of brightness occur. The lower photo shows an example of an uncharged specimen.

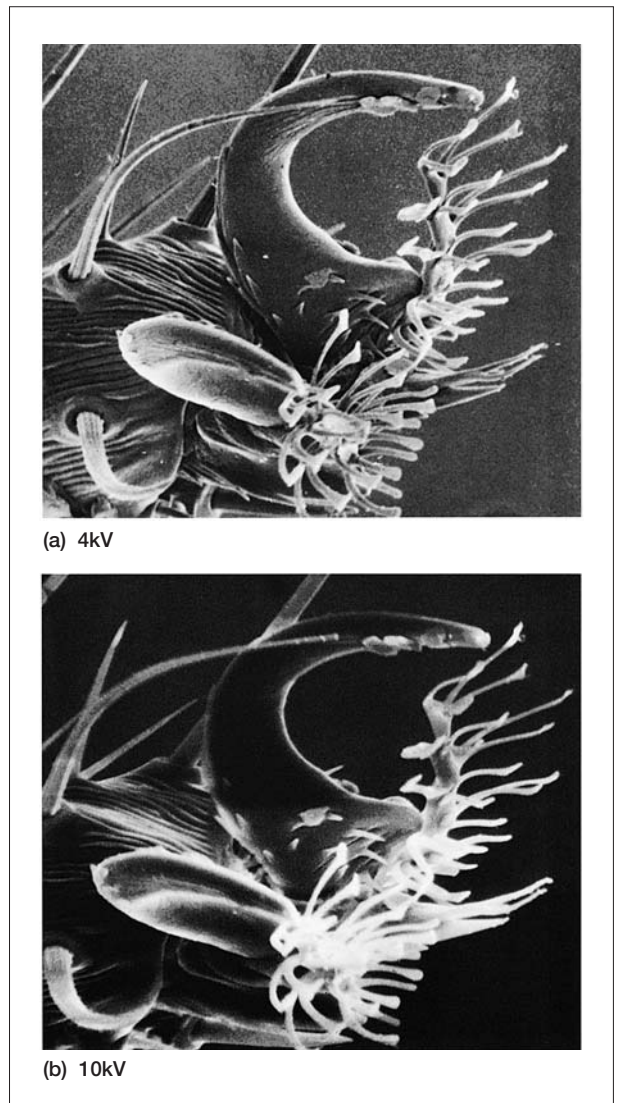

Fig.2 Anterior leg of drosophila.
By using a low accelerating voltage (upper photo), charging can be reduced.

Q15 Is it possible to observe a nonconductive specimen without coating?

A Although it depends on the material, shape and the tilt angle of the specimen surface, if you lower the accelerating voltage to around 1 kV, you can observe the specimen.

(1) Because there is no conductivity in the specimen, prevent the charging by equalizing the amount of the incident electrons to the amount of the secondary electrons generated from the specimen.

(2) The ratio of the generated secondary electrons (I_s) for the incident electrons (I_p) is called the secondary electron emission coefficient ($\delta = I_s/I_p$). Figure 1 shows the relation between the secondary electron emission coefficient (δ) and the accelerating voltage (V). The accelerating voltage at which the amount of the incident electrons and the amount of the secondary electrons are equalized depends also on the specimen and the tilt angle.

(3) Concerning the electrostatic charge, there are negative charges and positive charges.

The charge that occurs when the secondary electrons are emitted more than or less than the incident electrons is called a positive charge or negative charge, respectively.

In the positive charge, the brightness in the observation region is reduced as you increase the magnification, but it returns to the original brightness when you return the magnification to a low magnification.

In the negative charge, the opposite phenomenon occurs. Because charging occurs when the number of incident electrons and the secondary electrons are not same, you can find the equilibrium state by observing the phenomenon and adjusting the accelerating voltage.

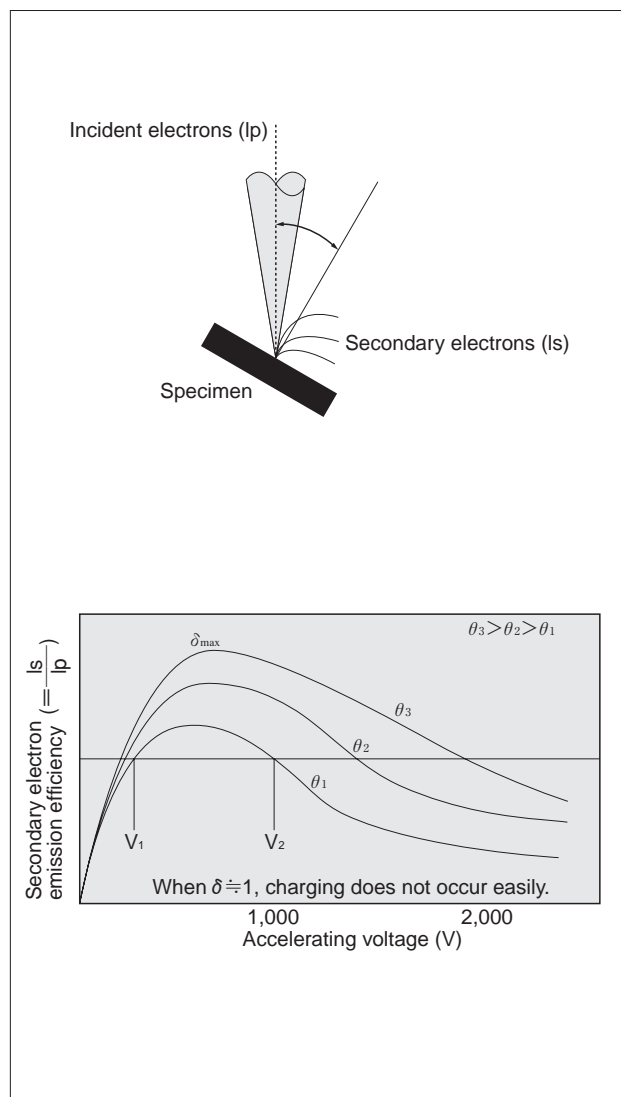

Fig.1

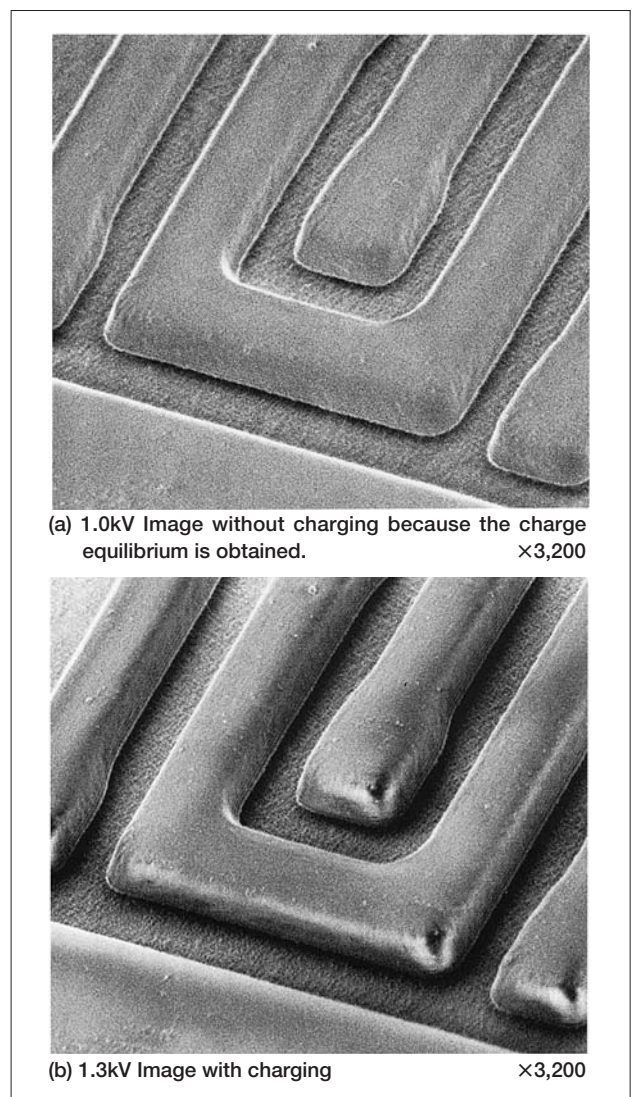

Fig.2 Specimen: Resist
Charging is prevented by selecting an accelerating voltage.

Q16 How to prevent the charging and take a fine image?

A Make uniform conductivity over the specimen surface .

(1) When you mount a specimen on a specimen stub, adjust the amount of adhesive agent so that you do not make a part where it is difficult to be coated (Fig. 1).

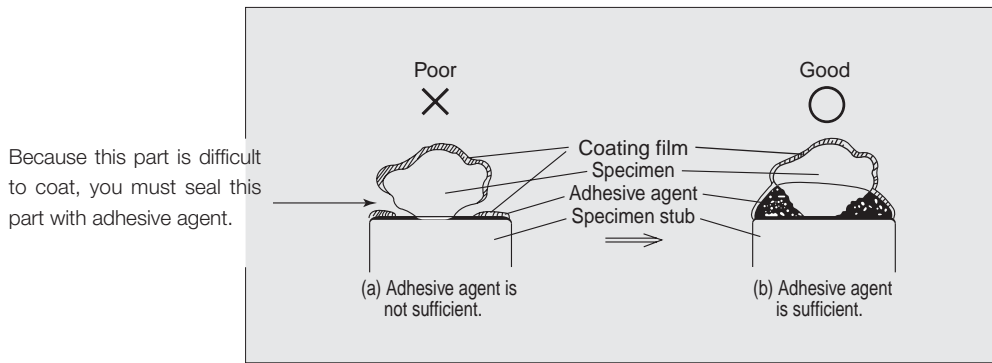

Fig.1 Fixing a bulk specimen on a specimen stub.

(2) When you perform evaporation using a vacuum evaporator, rotate and tilt the specimen so as to perform deposition from all directions. For an extremely uneven specimen, make the specimen be sufficiently coated on the lateral side.

(3) For a specimen like cloth, even if you make a thick coating, some parts of the specimen might remain at a poor conductivity (Fig. 2).

In such a case, sometimes, you can observe the specimen without coating by spraying an antistatic agent on the specimen. However, this method is not suitable for high a magnification (less than a few 100×).

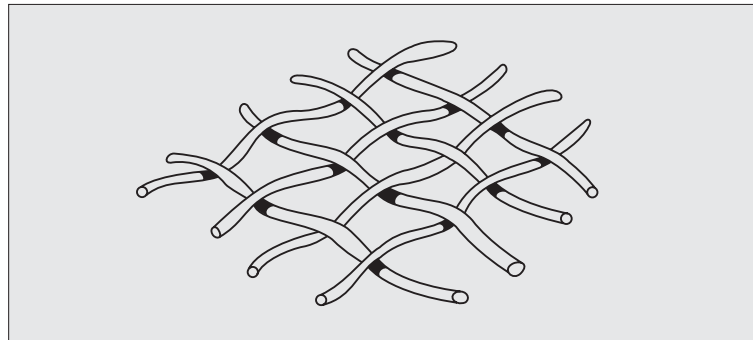

Fig.2 Evaporated film is not attached to the shadow parts.

(4) For a specimen like fine powder, do not accumulate the particles in many layers. Mount the powder on a specimen stub on which an adhesive agent is applied. After the adhesive agent has dried, blow off the loose powder on the specimen stub using an air blower such as a spray (Fig. 3).

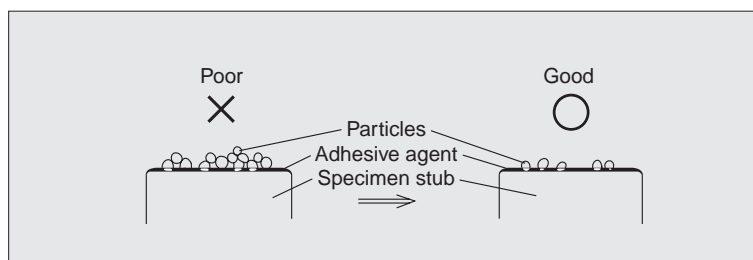

Fig.3 Removing the excess powder.

- (5) When you observe a string of the fiber of cloth or other materials, pick a few strings of the fiber, and arrange each string on a specimen stub, the fiber does not charge easily.

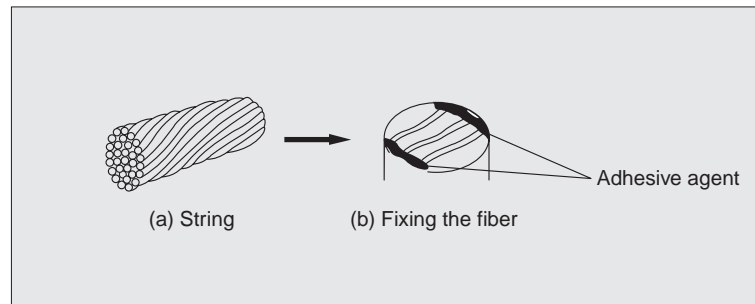

Fig.4 Fixing the fiber specimen.

- (6) For a biological specimen, charging does not occur easily if you perform a prior conductive staining.
- (7) If charging occurs in the first vacuum evaporation or sputter coating, sometimes, you can suppress the charging effect by changing the specimen orientation and performing the vacuum evaporation or sputter coating two or three times.

Q17 What is necessary to observe a beam sensitive specimen?

A To observe a beam sensitive specimen such as a biological specimen and a high-polymer material, you must pay attention to several problems.

1. Generally, you are inclined to increase the irradiation current because the emission of secondary electrons is small.
2. Thermal conductivity is poor.
3. As a result, the electron beam irradiation density increases locally, at a high magnification, thus damaging the specimen.

By taking the problems mentioned above into consideration, the following cares are necessary in order to suppress the specimen damage and take a good photo.

(1) Use a low accelerating voltage

At a high accelerating voltage the diffusion of the irradiation electron beam inside the specimen becomes large and the generation of heat also becomes large. Furthermore, the generation of the secondary electrons due to the backscattered electron from the inside of the specimen produce the background, causing various disadvantages such as that not only the fine structure of the surface of the specimen becomes difficult to observe, but also the contrast due to the edge effect becomes strong and charging is likely to occur.

Therefore, using as low an accelerating voltage as possible is recommended.

(2) Use a small probe current

When you use a large probe current to irradiate a specimen, the heat generated inside the specimen becomes large, increasing specimen damage. In addition, charging also becomes large.

When you observe a specimen with a low yield of secondary electrons, you tend to increase the probe current, because the image is difficult to see clearly, however, operating the instrument with as small a current as possible is a key point to reducing damage to a specimen (with a small spot size).

You tend to use a large current at TV rate, use a slow scan, so that you can observe the specimen with a small probe current with minor damage to the specimen.

(3) Protecting the observation point

When you find an observation point to capture an image, perform adjustments such as the astigmatism correction at another position beforehand, and then return to the observation point and capture the image immediately and obtain a good result. It also helps to protect a specimen by not increasing the magnification unnecessarily.

(4) If possible

Coating a specimen increases the generation of the secondary electrons, so that, enables you to observe the specimen with a small probe current, and helps to protect the specimen. The coating improves the thermal conductivity of the specimen and lowers the temperature of the specimen. Cooling the specimen is also effective.

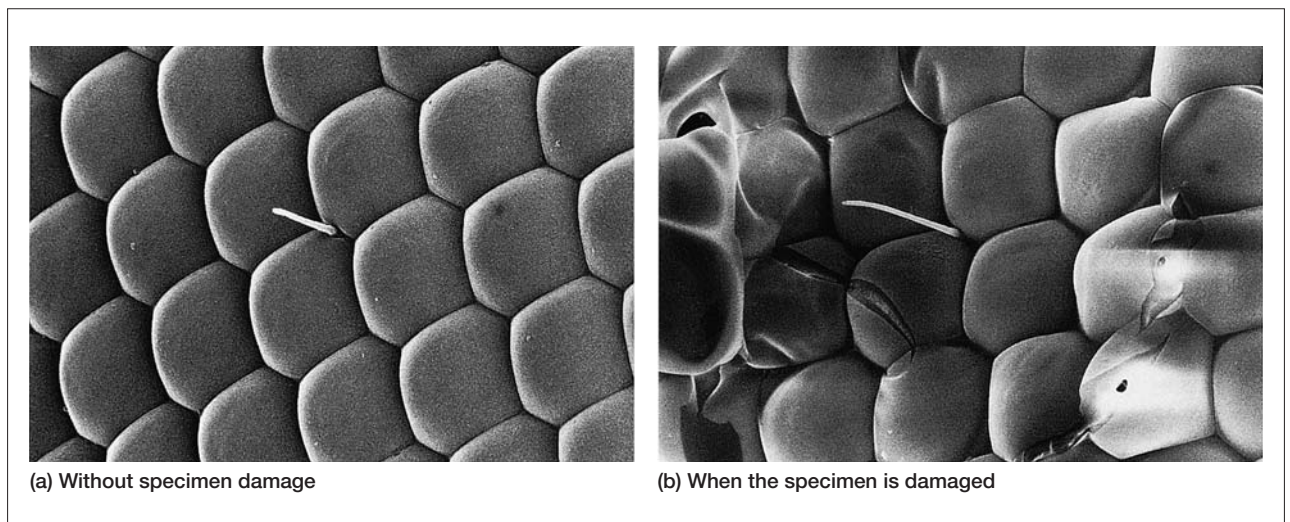

Specimen: Compound eye of a fly. Accelerating voltage: 5kV, Magnification:×1,100
When you irradiate the electron beam at one place on the specimen for a long time, the specimen might be damaged as shown in Fig. (b).

Q18 For a non-conductive specimen what is the difference between observation at a low accelerating (at high vacuum) and observation in a low vacuum (LV)?

A (1) For the morphological observation low accelerating voltage in the high vacuum is most suitable.

Because the depth of the generation of secondary electrons is about a few nm and that of backscattered electrons is about a few 10 nm, a low accelerating voltage (near 1 kV) is suited for the morphological observation of the top surface of the specimen. For organic material, in particular, if the accelerating voltage is high, the electron beam diffusion volume inside the specimen becomes large, and information not only from the surface but also from the inside are mixed together. The low vacuum (LV) observation by a backscattered-electron image, the accelerating voltage of about 5 to 15 kV is generally used.

(2) Use a low vacuum to observe a specimen that deforms in high vacuum.

When a liquid is in a specimen, the observable time in the low vacuum observation becomes long.

(3) When the surface morphology of the specimen is complex and hard to suppress charging, low vacuum is suited.

For a specimen with complex surface and hard to prevent charging even if you apply thick coating, the low vacuum observation is suitable.

(4) For elemental analysis without coating, the low vacuum is suitable.

For elemental analysis, you need a sufficiently high accelerating voltage to excite the characteristic X-rays. When you perform both observation and elemental analysis of the nonconductive specimen without coating, low vacuum is suitable.

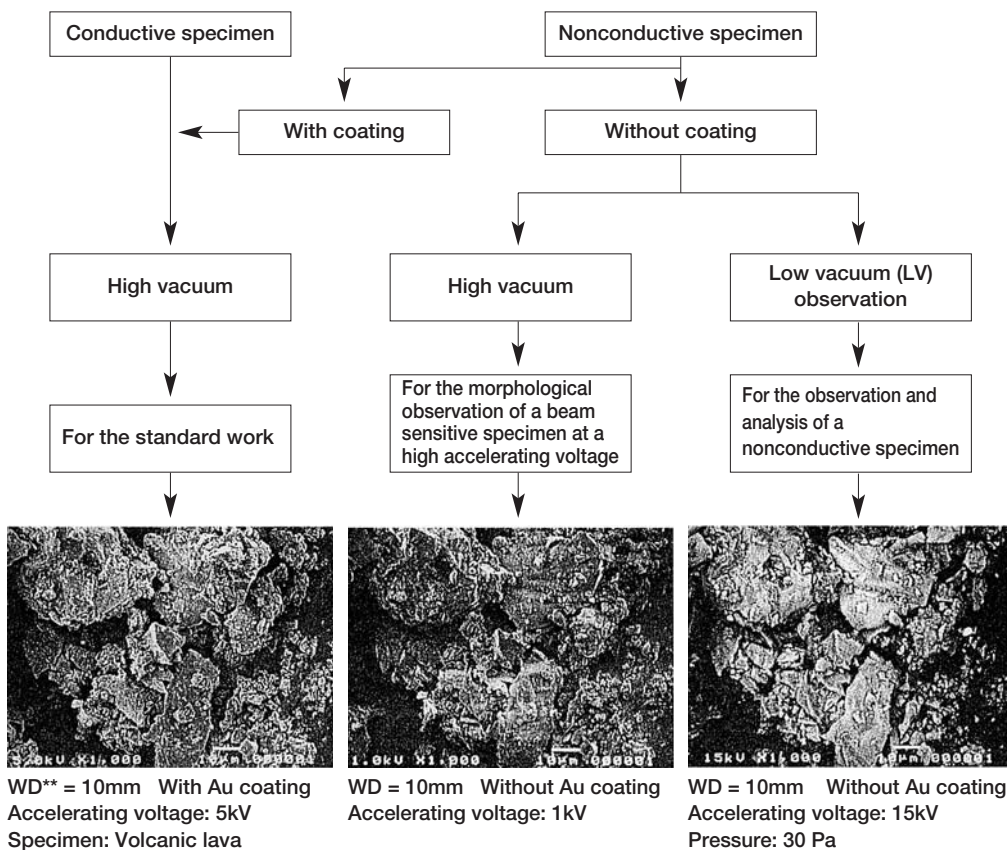

Fig.1 Observation at high vacuum and high accelerating voltage.

Fig.2 Observation at high vacuum and low accelerating voltage.

Fig.3 Observation at low vacuum.

**WD: Working distance (the distance from the bottom surface of the objective lens to the specimen)

Q19 How to observe an out-gassing specimen?

A

- (1) After embedding and polishing a specimen, you need to remove the embedding substance if you can.
- (2) Among various materials for embedding commercially available, wood metal has small out gas. You can apply it when you need a high vacuum such as when you use an FE SEM.
- (3) If you cannot prevent the degassing from the embedding material, observation in the low vacuum (LV) SEM is recommended.

Q20 How high the temperature rise of a specimen due to the electron beam irradiation during the SEM observation?

A The energy from most of the incident electrons that enter a specimen turns into heat. As a result, the temperature on a specimen at the irradiation position of the electron beam increases, causing thermal damage depending on the specimen. The temperature rise θ_m ($^{\circ}\text{C}$) at the irradiation point of the electron beam is given by Castaing et al.:

$$\theta_m = 1.14 \times \frac{I_a \cdot V}{C \cdot d} \text{ (}^{\circ}\text{C)}$$

where

I_a : Current absorbed by a specimen (μA)
 V : Accelerating voltage (kV)
 C : Thermal conductivity ($4.2\text{J} \cdot \text{cm}^{-1} \cdot \text{S}^{-1} \cdot ^{\circ}\text{C}^{-1}$)
 d : Probe diameter (μm)

When the probe diameter is fixed on a specimen at $0.1\mu\text{m}$, the temperature rise becomes as shown in the graph below. In this graph, the horizontal axis represents the thermal conductivity and the vertical axis represents the increase of temperature; and for mica as an example, the increase of temperature at 10pA is about 5°C , 2°C and 1°C at 30kV , 20kV and 10kV , respectively.

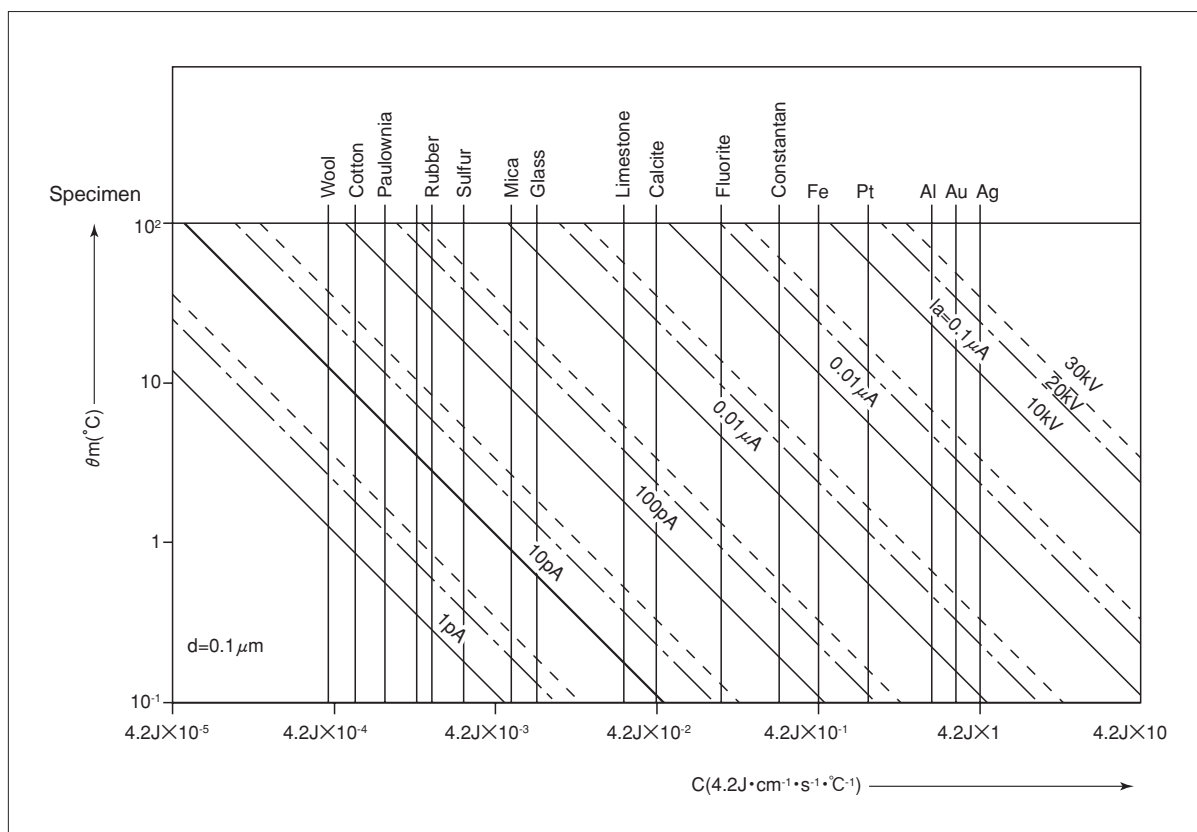

The thermal conductivity and the increase of temperature of the specimen.

Q21 What is specimen contamination? How to reduce contamination?

A When you observe a specimen at a high magnification, sometimes, the image becomes blurred, or when you decrease the magnification, the place you have observed appears darker compared with the surrounding part. This phenomenon is due to contamination caused when hydrocarbon gas molecules in the vicinity of the specimen are polymerized by the bombardment of the electron beam and deposited on the specimen surface. The reason why the image becomes blurred is because the surface structure is covered with the deposited material, and in a severe occasion, the surface structure might appear double. The reason why the image appears darker is that the deposited material covering the surface has secondary electron generation lower than that of the specimen (Fig. 1).

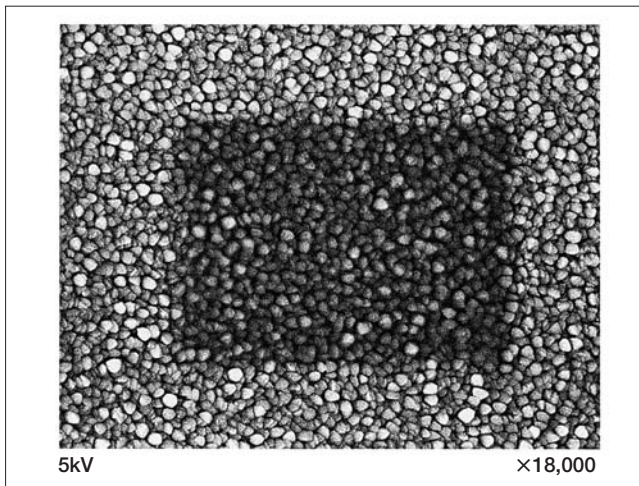

Fig.1 Specimen: ITO

This example shows that after scanning the electron beam for a long time at the magnification of $\times 36,000$, the magnification is lowered to $\times 18,000$ and an image is taken. Compared with the clear portion in the peripheral region, in the central region, the contrast is reduced and the image sharpness is lost.

Sometimes, the specimen contamination is attributed to the instrument, and at other times, it is caused by the specimen; but you can reduce it by using a little ingenuity.

- (1) Clean a specimen sufficiently using organic solvent. This method is effective in such a case as the specimen surface is stained with oil and you need to replace the solvent to clean the specimen a few times, and finally heat the specimen to sufficiently dry it.
- (2) In order to sufficiently degas the organic gas from the conductive paste for bonding the specimen, heat the specimen at 60 to 100°C. Sometimes it takes a few hours to heat the specimen itself at about 200°C to completely outgas. This method is effective for a thermally stable specimen.
- (3) It is also effective to heat a specimen at 110°C using the heating specimen holder in the specimen chamber of the SEM, however, because specimen drift occurs, it sometimes takes a few 10 minutes until the thermal equilibrium is attained.
- (4) You can reduce specimen contamination by installing a (optional) cold fin for preventing contamination in the instrument.
- (5) When the photographing region A is determined as shown in Fig. 2, perform the astigmatism correction and adjust the focus at the region B which is out side of the region A, and then return to the region A to take a photo.

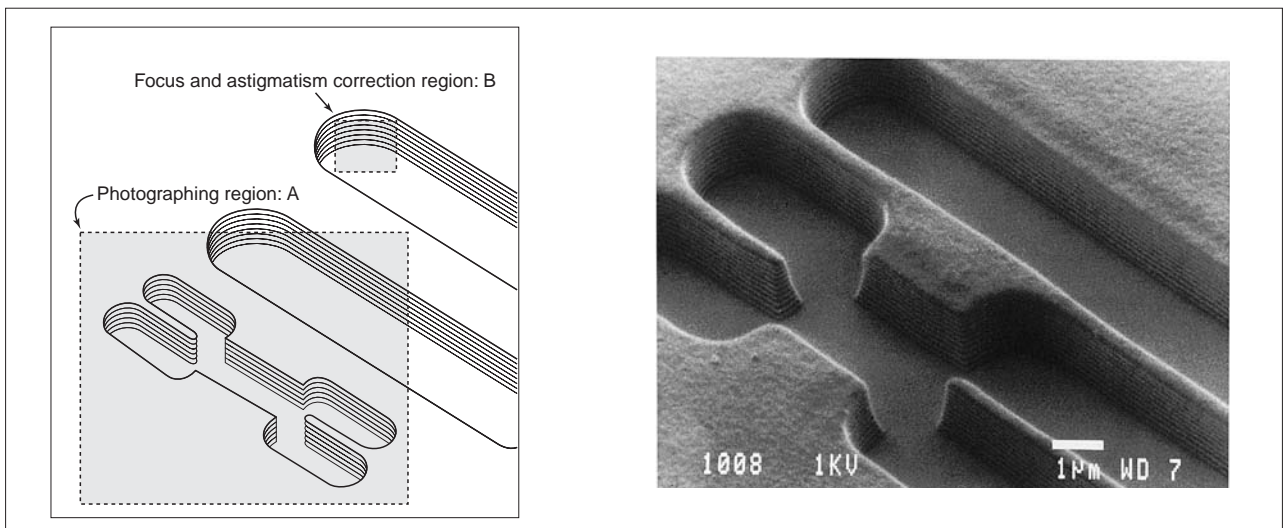

Fig. 2 Change the place for performing the astigmatism correction and adjusting the focus from the photographing region.

Q22 How to determine the exposure time of X-ray area analysis (mapping image)?

A The mapping image consists of an aggregation of white dots. The greater the density difference of the dots between the portion where dots are closely aggregated (portion where the concentration of the analyzed element is high) and the portion where very few dots exist (portion where the concentration of the analyzed element is low), the better the contrast of the image becomes. Therefore, the counting time (exposure time) is selected so that the density of white dots in the portion of high concentration become sufficiently high.

(1) Although the X-ray pulse required for one pixel is one count, the time required to give one count for each pixel is different depending on the counting rate of the X-ray of the analysis element. Therefore, the exposure time is calculated as follows.

For example, supposing that the pixel size on the photo is 0.2×0.2 mm, the total pixels of the photo ($90 \text{ mm} \times 120 \text{ mm}$) becomes 270,000. On the other hand, supposing that the X-ray counting rate at the portion where the analysis element is detected is 1000 cps (count per second), the time (t) required to cover the total pixels of the portion becomes as follows.

$$t = \text{Total pixels}/\text{X-ray counting rate} = 270,000/1,000 = (\text{sec})$$

Therefore, if the exposure time is 50 sec/frame, the multiple exposures of $270/50 \approx 5$ times is required, and if it is 100 sec/frame, the multiple exposures of about 3 times is required.

(2) Because the concentration difference is distinguished by the density of dots, the distinction of the concentration difference will be difficult unless the concentration difference is more than 20 to 30%. For example, the specimen is a standard specimen of cobalt (circular portion at the center) which is embedded in a brass (Cu/Zn alloy) holder. The X-ray intensity on the cobalt specimen is 2000 cps.

The photo at the left exposes 100 sec/frame 1 time ($2000 \text{ cps} \times 100 \text{ sec} = 200,000$ counts). From the practical viewpoint, this photo obtains a sufficient contrast.

The photo at the right shows an example exposing 5 times with the same conditions ($2000 \text{ cps} \times 500 \text{ sec} = 1,000,000$ counts). This photo reveals that the density of white dots increases further to improve the contrast. To distinguish a delicate concentration difference, line analysis is more suited than map analysis.

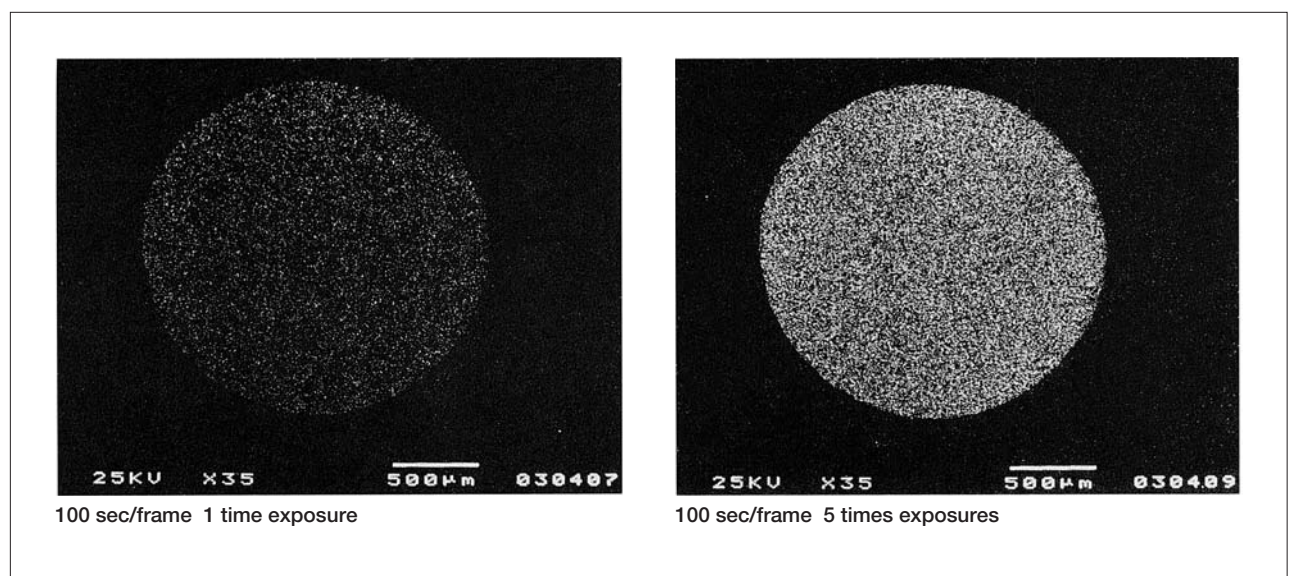

Q23 How to reduced analysis volume in elemental analysis?

A

(1) The SEM normally analyzes a bulk material.

Even if the diameter of the electron beam irradiating a bulk specimen is about 10 nm, the X-ray generation region is enlarged by the size of area where the electron beam is diffused in the specimen, and it becomes a few cubic micrometers. Figure 1 shows the electron scattering calculated by the Monte Carlo simulation. Electrons diffuse in the specimen by gradually losing energy.

Figure 2 schematically shows the diffusion area $D = E_0 + d$ of the electron beam, and the area $Z_m + d$ where the electron beam retains energy to generate characteristic x-ray of interest.

(2) With the theory mentioned above, when the density of a specimen and an accelerating voltage of electron beam are determined, the method to obtain the analysis area Z_m from the diffusion area D (E_0) is shown in Figs. 3 and 4.

(3) As an example, when you analyze a plastic ($\rho = 1$) at 15 kV, the analysis area becomes about $6 \mu\text{m}$.

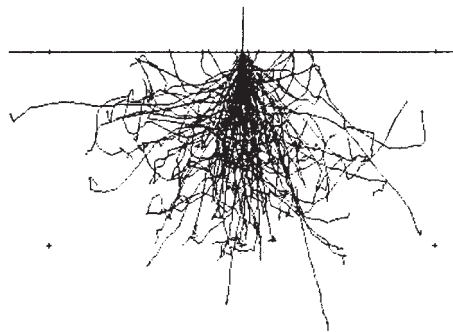

Fig. 1 Diffusion of electrons.

By Drs. K. Murata, T. Matsukawa, and R. Shimizu Osaka University.
Published in J. J. A. P. 10 (1971) 684

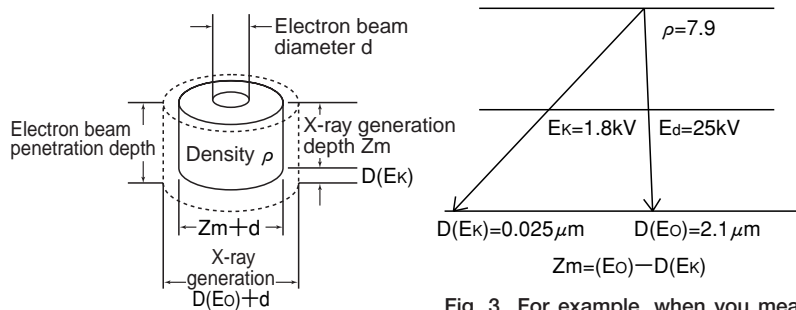

Fig. 2 Spread of the electron beam.

Fig. 3 For example, when you measure Si $K\alpha$ in Fe at the accelerating voltage of 25 KV, the X-ray generation depth becomes as shown in the figure above, $Z_n \approx 2.1 \mu\text{m}$.

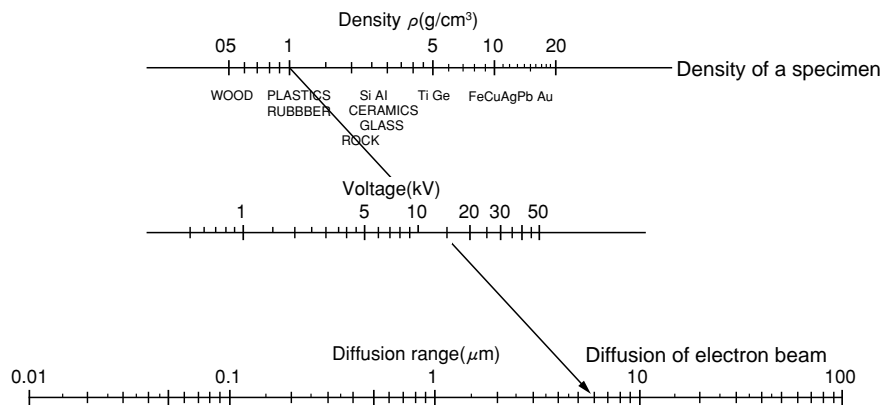

Fig. 4 Nomogram for deriving the diffusion area (refer to Fig. 3 for how to use).

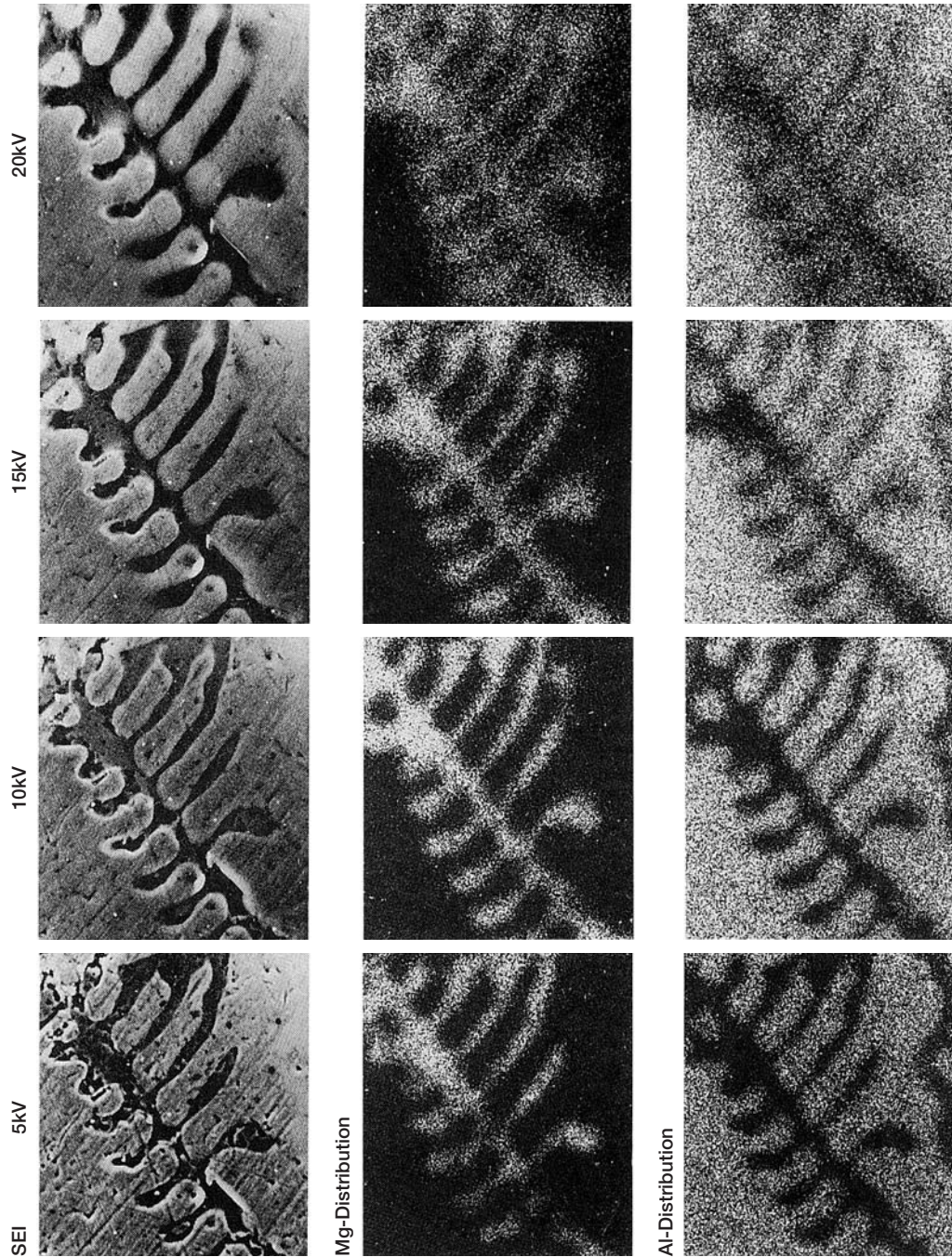

Fig. 5 Secondary electron images and the X-ray elemental maps of Mg and Al with diferent accelerating voltage.

Q24 How to obtain good qualitative analysis by EDS?

A

(1) Because the energy resolution is poor in EDS, peaks of different elements may overlap. The examples of the overlapping peaks include the following cases.

1. When the K line or the L line of an element overlaps with the K line or the L line of the element of adjacent atomic number

- | | |
|--------------------------------|-------------------------------------|
| Ti-K β and V-K α | Fe-K β and Co-K α |
| V-K β and Cr-K α | Co-K β and Ni-K α |
| Cr-K β and Mn-K α | Ni-K β and Cu-K α |
| Mn-K β and Fe-K α | Cu-K β and Zn-K α etc. |

2. When the K line of a light element overlaps with the L line or the M line of a heavy element

- | |
|--|
| Na-K α and Zn-L α |
| Si-K α and Sr-L α |
| S-K α and Mo-L α and Pb-M α |
| Ti-K α and Ba-L α etc. |

(2) When the overlapping is anticipated, judge the peak by watching the spectral lines with different energies. For example, you can judge whether or not S-K α overlaps with Pb-M α by observing whether or not Pb-L α can be detected by using a sufficiently high accelerating voltage.

In addition, the intensity ratio of Pb-M α and Pb-L α is determined if the accelerating voltage is given, so if you have obtained this ratio using a standard specimen beforehand, you can estimate the intensity ratio of S-K α and Pb-M α by observing the peak from the target specimen.

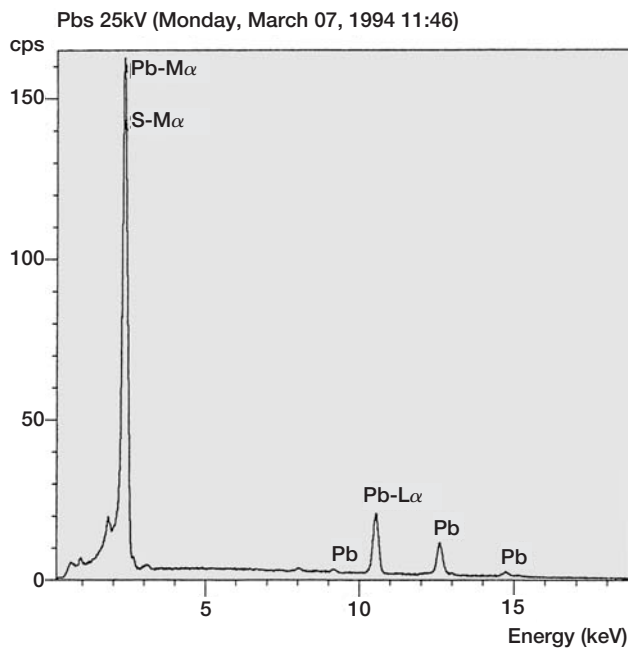

Example of an EDS spectrum analyzed at 25 kV

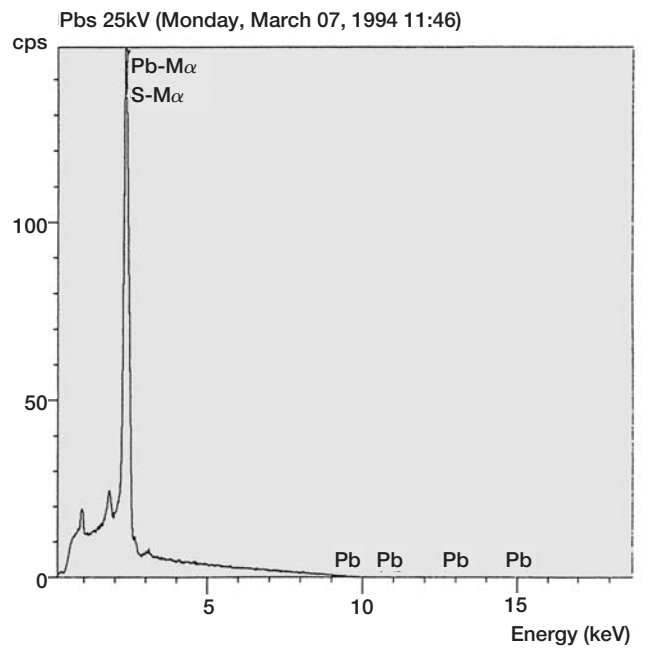

Example of an EDS spectrum analyzed at 10 kV

Major overlapping elements in EDS

Analysis X-ray in the left column and the interfering X-rays

Na-K α (1.041keV)	Ni-L α (0.849keV) Cu-L α (0.928keV) Zn-L α (1.009keV)
Mg-K α (1.254keV)	Ge-L α (1.186keV) As-L α (1.282keV) Tb-M α (1.24 keV)
Al-K α (1.487keV)	Br-L α (1.48 keV)
Si-K α (1.74 keV)	Rd-L α (1.694keV) Sr-L α (1.806keV) Ta-M α (1.71 keV) W-M α (1.775keV)
P-K α (2.015keV)	Zr-L α (2.042keV) Ir-M α (1.98 keV) Pt-M α (2.051keV) Au-M α (2.123keV)
S-K α (2.308keV)	Mo-L α (2.293keV) Pb-M α (2.346keV) Bi-M α (2.423keV)
C1-K α (2.622keV)	Ru-L α (2.558keV) Rh-L α (2.696keV)
K-K α (3.313keV)	In-L α (3.287keV) Cd-L β (3.316keV)
Ca-K β (3.691keV)	K-K β (3.589keV) Sb-L α (3.605keV) Te-L α (3.796keV) Sn-L β (3.662keV)
Sc-K α (4.090keV)	Ca-K β (4.012keV)
Ti-K α (4.510keV)	Ba-L α (4.467keV) La-L α (4.651keV)
V-K α (4.952keV)	Ti-K β (4.931keV)
Cr-K α (5.414keV)	V-K β (5.427keV)
Mn-K α (5.898keV)	Cr-K β (5.946keV)
Fe-K α (6.40 keV)	Mn-K β (6.490keV)
Co-K α (6.930keV)	Fe-K β (7.057keV)
Ni-K α (7.477keV)	Co-K β (7.649keV)
Cu-K α (8.047keV)	Ni-K β (8.264keV)
Zn-K α (8.638keV)	Cu-K β (8.904keV)

Q25 How to perform quantitative analysis?

A The ratio of the characteristic X-ray intensity from a test specimen to the characteristic X-ray intensity from a standard specimen is called relative intensity. The region of generating X-rays depends on the average atomic number of the constituent elements in the specimen. In addition, the X-rays generated inside the specimen undergo absorption, excite other elements to emit fluorescent X-rays, or cause other phenomena. Therefore, in order to obtain precise quantitative analysis it is necessary to apply the atomic number correction (Z), absorption correction (A) and the fluorescence correction (F) to the relative intensity.

1) Measurement of the standard specimens

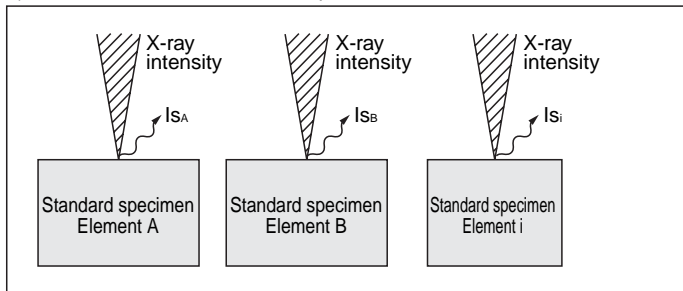

Let the X-ray intensities from the standard specimens (A, B, ..., i) be $(I_{SA}, I_{SB}, \dots, I_{Si})$.

2) Measurement of the test specimen

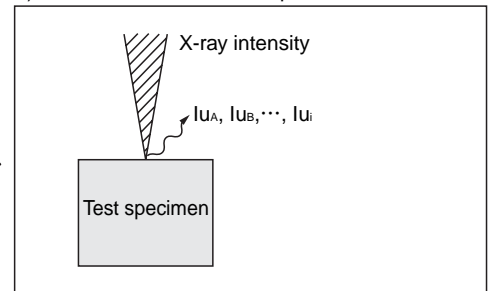

Let the X-ray intensities from the elements (A, B, ..., i) of the test specimen be $(I_{uA}, I_{uB}, \dots, I_{ui})$.

3) Correction calculation

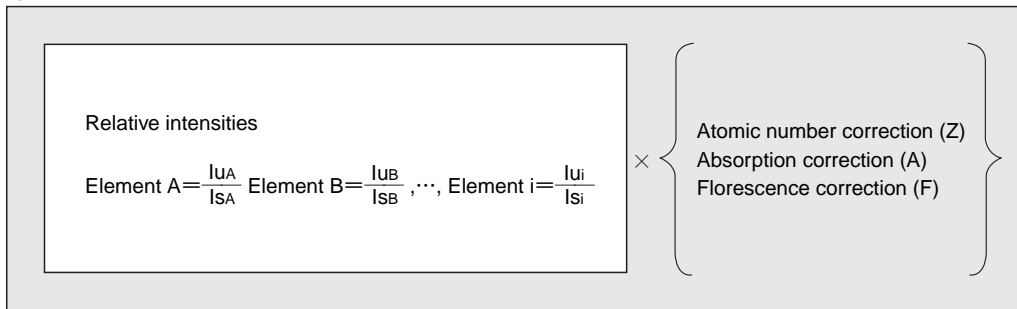

4) Result (weight concentration)

The items you must pay attention to when you perform quantitative analysis are as follows.

- (1) The composition in the specimen is homogeneous in the analysis area.
- (2) The specimen surface is flat.
- (3) The incident electron beam is perpendicular to the specimen surface.
- (4) The accelerating voltage, electron beam intensity and the X-ray take-off angle (the height and tilt of the specimen) are constant.

Q26 What is the accuracy of quantitative analysis in elemental analysis by EDS?**A**

- (1) Generally, quantitative analysis is performed by comparing the characteristic X-ray intensities from the standard specimens with those of the test specimen. Because the energy resolution of EDS is about 10 times poorer than that of WDS and because it is difficult to remove the background caused by the continuous X-rays, the accuracy of EDS quantitative analysis is influenced by whether or not the overlaps of spectral peaks can be well separated. In particular, when the content of an element is less than 1 to 2%, in particular, the accuracy of the quantitative analysis might become poor.
- (2) In EDS, there is a method of obtaining the relative intensities by storing the spectra (or theoretically calculated values) from the standard specimens into the memory and comparing the spectrum from the test specimen with them. For the elements with the content of 1 to 2% or more, the accuracy of the content becomes the same level as that obtained by EPMA.
- (3) The advantages of the quantitative analysis by EDS are as follows.
1. You can carry out the measurement in a short time because all of the constituent elements are detected at the same time.
 2. The damage to a specimen is small because you can measure the specimen with a small probe current compared with that required in WDS.
- (4) In the EDS analysis software for cold FE SEM, there is a function to correct the variation of the emission current, so you can obtain the same level of accuracy of quantitative analysis as that obtained using the thermionic gun SEM.

Oxide	Wet analysis	FE SEM analysis		Difference from the wet analysis	
		With correction	Without correction	With correction	Without correction
SiO ₂	64.30	64.70	64.65	+0.40	+0.35
Al ₂ O ₃	19.90	18.97	17.97	-0.93	-1.93
Na ₂ O	3.70	3.82	0.76	+0.12	-2.94
K ₂ O	11.40	11.40	11.42	0	+0.02
CaO	0.24	0.03	0.01	-0.21	-0.23
Total	99.54	98.92	94.81	-0.62	-4.73

Comparison of the weight concentration by EDS analysis with the wet analysis value (unit: %)
 (Comparison of the values when the correction for the variation of the current is provided or not)
 Specimen: Orthoclase Accelerating voltage: 15kV

Q27 What is the difference between elemental analysis by EDS and by WDS?

A (1) The features of EDS and WDS on SEM are shown in the table below.

Item	WDS	EDS
Measurable element range	${}_{4}\text{Be}$ to ${}_{92}\text{U}^{*1)}$	${}_{4}\text{Be}$ to ${}_{92}\text{U}^{*2)}$
Measurement method	Wavelength dispersive method using an analyzing crystal	Energy dispersive method using a Si (Li) semiconductor detector
Resolution	$\lambda \cong 0.7 \times 10^{-3} \text{ nm}$ ($E \cong 20 \text{ eV}$)	$E \cong 130 \text{ eV}$ ($\lambda \cong 0.6 \times 10^{-2} \text{ nm}$)
Measurement speed	Slow	Fast
Multi-element simultaneous measurement	Impossible	Possible
Damage and contamination of the specimen	More	Less
Detection limit	50 to 100 PPM	1500 to 2,000 PPM
X-ray detection per current	Small	Large

*1) For Be, an optional analyzing crystal is necessary.

*2) A detector that can detect elements from the light elements (from sB) is also available.

(2) Figure 1 compares the energy resolution and the P/B ratio of a typical EDS with those of WDS. In WDS, although the analyzing crystal for use differs according to the element to detect, you can obtain one digit higher resolution and P/B ratio than EDS.

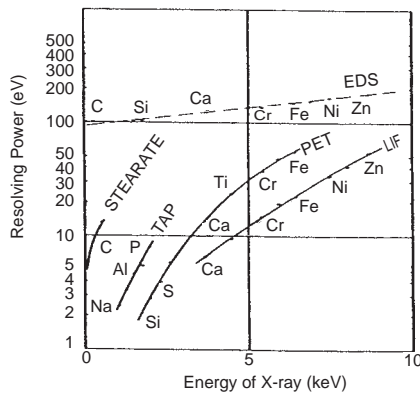

Fig.1a Comparison of energy resolution.

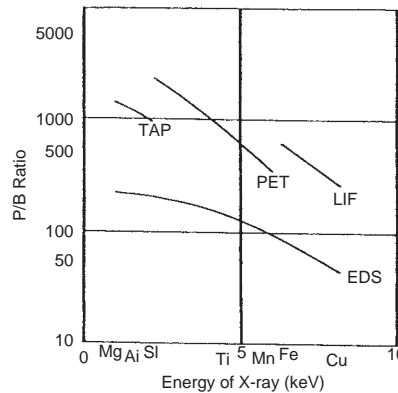

Fig.1b Comparison of P/B ratio.

(3) Owing to the fact that WDS has higher energy resolution and P/B ratio, WDS is more capable to detect a trace element.

Figure 2 shows the comparison of two spectra by EDS and WDS obtained from a steel specimen including a trace Cr; a clear peak is obtained by WDS and you can confirm the inclusion of Cr.

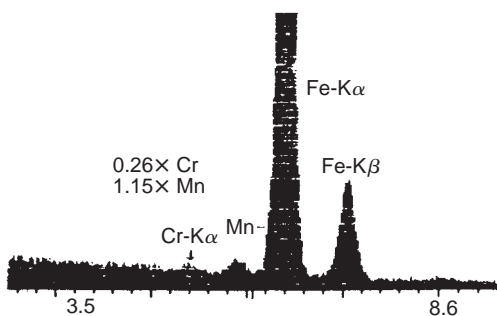

Fig.2a Analysis of a low alloy steel by EDS.

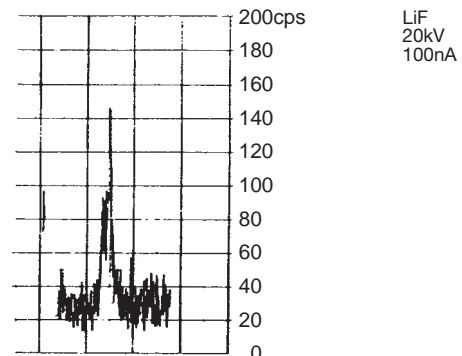

Fig.2b Cr analysis by WDS.

Q28 Is it possible to analyze foreign materials in resin?**A**

It depends on where the foreign materials are in a specimen.

(1) It is possible to analyze foreign materials if they are within the range (within a few μm) that the electron beam can reach.

It is necessary to expose foreign materials at a deep place.

(2) You can cut out a part of resin to expose foreign materials.

When foreign materials are scattered evenly in resin, you can also use the freeze-fracture technique in liquid nitrogen.

(3) When you analyze foreign materials, pay attention to its size. If the size is sufficiently larger than the diffusion region of the electron beam, you can analyze it without doing special treatment; however, if it is smaller than the diffusion region of the electron beam, you may detect the signals from the matrix material as well. It is necessary to judge the result by comparing it with the analysis value obtained from only the part of the matrix material.

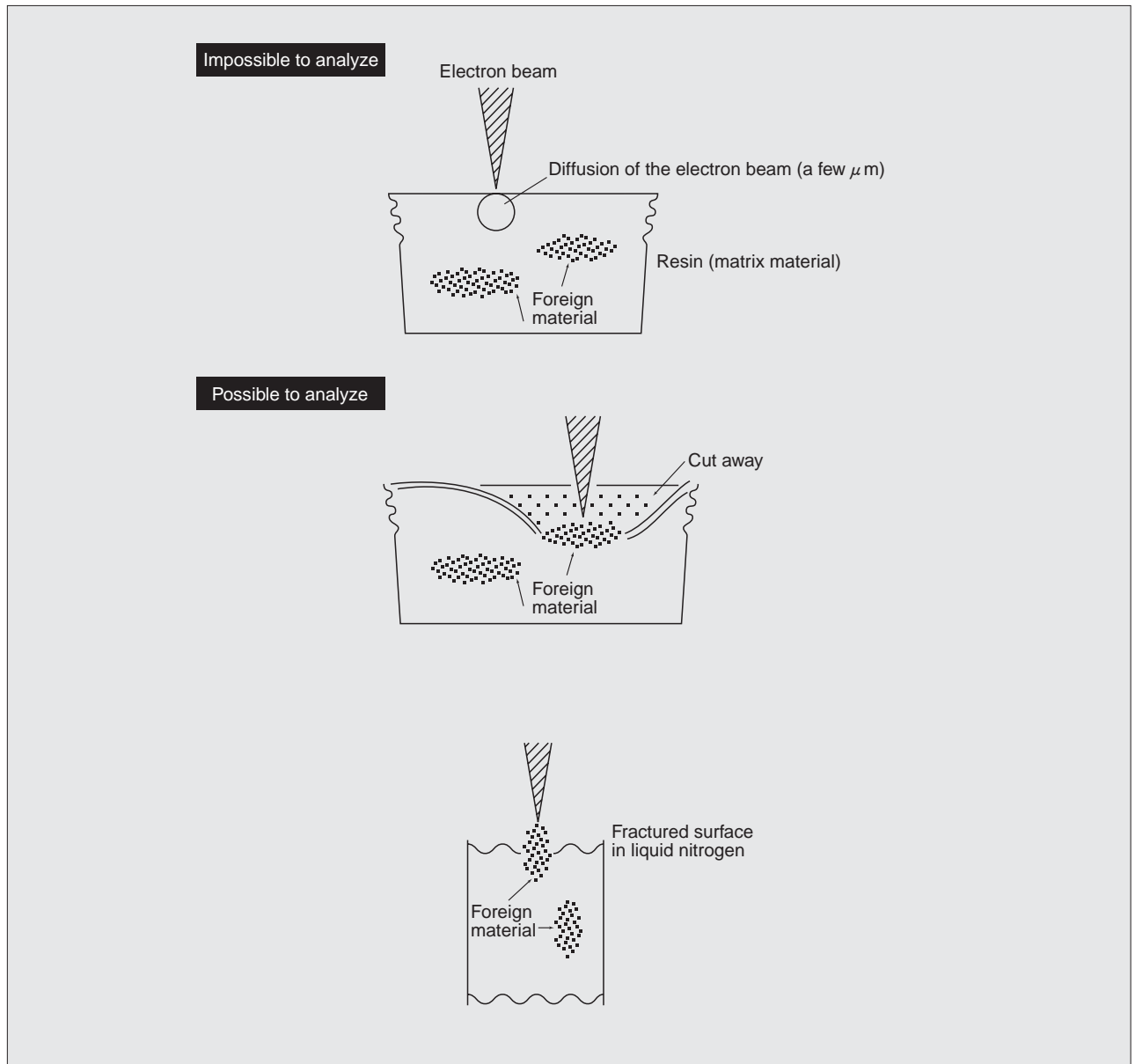

Q29 How to do a stereoscopic observation using a SEM?**A**

It is well known that when you observe, two photos captured in the different observation directions, one photo by left eye and the other photo by right eye, you can get a stereoscopic impression; and because the SEM has a very large focus depth and can change the observation direction using the tilt mechanism of the specimen stage, it is an instrument suitable for performing a stereoscopic observation. Areas of concern when you actually perform a stereoscopic observation are as follows.

1. How much to tilt the specimen stage

The tilt angle difference normally used when you take two photos is about 5 to 10°. If you increase the tilt angle difference, the stereoscopic effect is enhanced; and if you decrease the tilt angle difference, the stereoscopic effect is suppressed. Use a larger tilt angle difference for a specimen with small irregularity and use a smaller tilt angle difference for a specimen with large irregularity.

2. How to reduce the field shift when tilting the specimen stage

A trick for this is to align the tilt axis of the specimen stage with the specimen surface as closely as possible. If an SEM has a fine adjustment mechanism of the Z axis, use this mechanism. However, because the specimen you handle with an SEM generally has large irregularity and the specimen height varies with respect to each field, the field shift occurs by any means. In such a case, after taking the first photo, mark a target on the screen using a marking pen, and shift the field so that the target comes to the same position when you tilt the specimen stage.

3. How to arrange the two photos

When you see the photos to get stereoscopic impression, place the left photo that was tilted so that you see it with your left eye in the left side when you see the specimen with your naked eyes, and place the right photo that was tilted so that you see it with your right eye in the right side. That is to say, place the image that was tilted in the right direction in the left side. If you reverse the photos, the stereoscopic effect becomes reversed.

Align the direction of the tilt axis with the vertical direction correctly. When you rotate the image using the scan rotation unit, the tilt axis does not match with the vertical or horizontal side of the photo, so you must pay attention to this fact. If the direction of the tilt axis is misaligned, the stereoscopic effect might be faded.

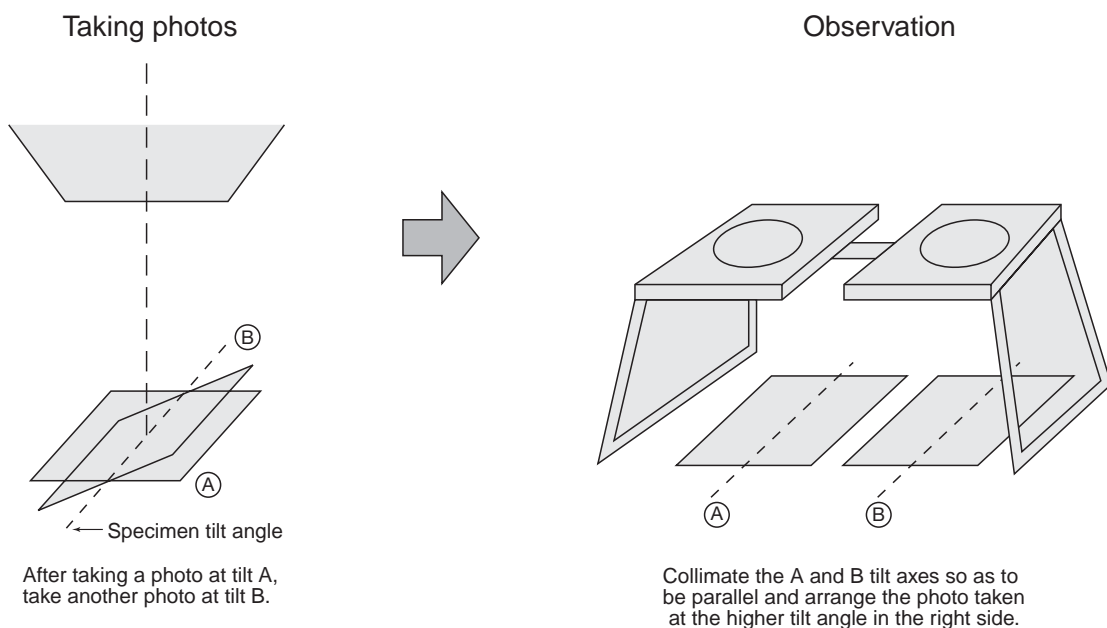

Q30 How to quantitatively measure the height difference on a specimen?

A There is a method for performing a three-dimensional measurement by using the intensity of secondary electrons or backscattered electrons. Here, a method for making it by using the stereo-pair photos is described.

To perform a three-dimensional measurement, find the corresponding points in the two stereo-pair photos and measure the distance from the reference point. As shown in the figure below, the height h of the point P (the height from the plane which is perpendicular to the electron probe and includes the reference point) in one photo is given by the following formula,

$$h = p' / \sin\theta - p / \tan\theta$$

where, p is the length between P and O on the photo, p' is the length between P' and O' on the other photo, and θ is the tilt angle. The line segments PO and $P'O'$ must be perpendicular to the tilt axis when the specimen is tilted. Also, because the height h obtained here is only a height on the photo, to convert it into the actual length of the specimen, you must divide it by the magnification. To increase the measurement accuracy, you must increase the angle θ , but when the surface irregularity is too large, sometimes you cannot find out the corresponding points.

If you perform such measurements for not only one point but also many points, you can obtain the three-dimensional coordinates for each point, and you will be able to make a three-dimensional display using an appropriate software.

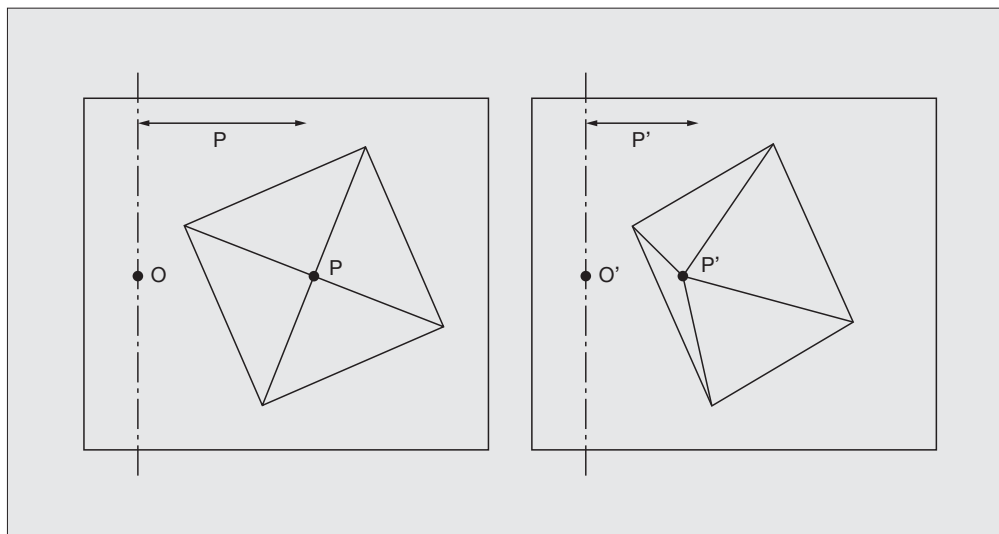

Published by: JEOL Ltd.
JEOL DATUM Ltd.

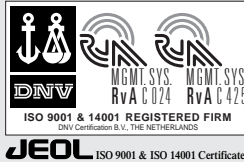

Certain products in this brochure are controlled under the "Foreign Exchange and Foreign Trade Law" of Japan in compliance with international security export control. JEOL Ltd. must provide the Japanese Government with "End-user's Statement of Assurance" and "End-use Certificate" in order to obtain the export license needed for export from Japan. If the product to be exported is in this category, the end user will be asked to fill in these certificate forms.

JEOL JEOL Ltd. 1-2 Musashino 3-chome Akishima Tokyo 196-8558 Japan Sales Division ☎(042)528-3381 ㊚(042)528-3386 <http://www.jeol.com/>

ARGENTINA
COASIN S.A.C.IyF.
Virrey del Pino 4071,
1430 Buenos Aires
Argentina
Telephone: 54-11-4552-3185
Facsimile: 54-11-4555-3321

AUSTRALIA & NEW ZEALAND
JEOL(AUSTRALASIA) Pty.Ltd.
Suite 1, L2 18 Aquatic Drive
- Frenchs Forest NSW 2086
Australia
Telephone: 61-2-9451-3855
Facsimile: 61-2-9451-3822

AUSTRIA
LABCO GmbH
Dr.-Tittremmel-Gasse 8,
A-3013 Pressbaum, Austria
Telephone: 43-2233-53838
Facsimile: 43-2233-53176

BANGLADESH
A.G. GHOWDHURY SCIENCE & SYNERGY PVT. LTD.
House No. 12, Road No. 5A
Sector No. 11, Uttara Dhaka - 1230
Bangladesh
Telephone: 880-2-9980790, 8953450, 8953501
Facsimile: 880-2-8854428

BELGIUM
JEOL (EUROPE) B.V.
Planet II, Gebouw B
Leuvensesteenweg 542,
B-1930 Zaventem
Belgium
Telephone: 32-2-720-0560
Facsimile: 32-2-720-6134

BRAZIL
FUGIWARA ENTERPRISES
INSTRUMENTOS CIENTIFICOS LTDA.
Avenida Itaberaba, 3563
02739-000 Sao Paulo, SPI Brazil
Telephone: 55-11-3983-8144
Facsimile: 55-11-3983-8140

CANADA
JEOL CANADA, INC.
(Represented by Soquelec, Ltd.)
5757 Cavendish Boulevard, Suite 540,
Montreal, Quebec H4W 2V8, Canada
Telephone: 1-514-482-6427
Facsimile: 1-514-482-1929

CHILE
TECSIS LTDA.
Avenida Kennedy 5454 - Piso 5
Vitacura, Santiago, Chile
Telephone: 56-2-401-8520
Facsimile: 56-2-410-8541

CHINA
JEOL LTD., BEIJING OFFICE
Room B1110/11, Wantong New World Plaza
No. 2 Fuchengmenwai Street, Xicheng District,
Beijing 100037, P.R.China
Telephone: 86-10-6804-6321/6322/6323
Facsimile: 86-10-6804-6324

JEOL LTD., SHANGHAI OFFICE
Shanghai Equatorial Hotel Office Building 803,
65 Yanan Road West, Shanghai 200040, P.R. China
Telephone: 86-21-6248-4066/4487/4537/4404
Facsimile: 86-21-6248-4075

JEOL LTD., GUANG ZHOU OFFICE
N3104, World Trade Center Building
371-375, Huan Shi East-Road, Guang Zhou,
510095, P.R.China
Telephone: 86-20-8778-7848
Facsimile: 86-20-8778-4268

JEOL LTD., WUHAN OFFICE
Room 3216, World Trading Bldg.
686 Jiefang Street, Hankou, Wuhan, Hubei 430032
P.R.China
Telephone: 86-27-8544-8953
Facsimile: 86-27-8544-8695

JEOL LTD., CHENGDU OFFICE
1807A Zongfu Building,
NO. 45 Zhongfu Road, Chengdu, Sichuan, 610016
P.R. China
Telephone: 86-28-86622554
Facsimile: 86-28-86622564

CYPRUS
JEOL (EUROPE) SAS
Espace Claude Monet, 1 Allée de Giverny
78290, Croissy-sur-Seine, France
Telephone: 33-13015-3737
Facsimile: 33-13015-3747

EGYPT
JEOL SERVICE BUREAU
3rd Fl. Nile Center Bldg., Nawal Street,
Dokki, (Cairo), Egypt
Telephone: 20-2-3335-7220
Facsimile: 20-2-3338-4186

FRANCE
JEOL (EUROPE) SAS
Espace Claude Monet, 1 Allée de Giverny
78290, Croissy-sur-Seine, France
Telephone: 33-13015-3737
Facsimile: 33-13015-3747

GERMANY
JEOL (GERMANY) GmbH
Oskar-Von-Miller-Strasse 1a, 85386
Eching, Germany
Telephone: 49-8165-77346
Facsimile: 49-8165-77512

GREAT BRITAIN & IRELAND
JEOL (U.K.) LTD.
JEOL House, Silver Court, Watchmead,
Welwyn Garden City, Herts AL7 1LT, U.K.
Telephone: 44-1707-377117
Facsimile: 44-1707-373254

GREECE
N. ASTERIADIS S.A.
56-58, S. Trikoupi Str. P.O. Box 26140
GR-10022, Athens, Greece
Telephone: 30-1-823-5383
Facsimile: 30-1-823-9567

HONG KONG
FARMING LTD.
Unit 1009, 10/F., MLC Millennium Plaza
663 King's Road, North Point, Hong Kong
Telephone: 852-2815-7299
Facsimile: 852-2581-4635

INDIA
BLUE STAR LTD. (HQ: Mumbai)
Analytical Instruments Department,
Sahas' 414/2 Veer Savarkar Marg
Prabhadey Mumbai 400 025, India
Telephone: 91-22-6666-4000
Facsimile: 91-22-6666-4001

BLUE STAR LTD. (Delhi)
Analytical Instruments Department,
E-44/12 Okhla Industrial Area,
Phase-II, New Delhi 110 020, India
Telephone: 91-11-4149-4000
Facsimile: 91-11-4149-4005

BLUE STAR LTD. (Calcutta)
Analytical Instruments Department,
7, Hare Street Calcutta 700 001, India
Telephone: 91-33-2213-4133
Facsimile: 91-33-2213-4102

BLUE STAR LTD. (Chennai)
Analytical Instruments Department,
Garuda Building,
46, Cathedral Road, Chennai 600 086, India
Telephone: 91-44-4244-4000
Facsimile: 91-44-4244-4190

INDONESIA
PT. TEKNOLABindo Penta Perkasa
Komplek Gading Bukit Indah Blok I/11
Jl. Bukit Gading Raya Kelapa Gading Permai,
Jakarta 14240, Indonesia
Telephone: 62-21-45847057/58/59
Facsimile: 62-21-45842729

ITALY
JEOL (ITALIA) S.p.A.
Centro Direzionale Green Office
Via dei Tulipani, 1
20090 Pieve Emanuele (MI) Italy
Telephone: 39-02-9041431
Facsimile: 39-02-90414343

KOREA
JEOL KOREA LTD.
Dongwoo Bldg. 7F, 458-5, Gil-Dong,
Gangdong-Gu, Seoul, 134-010, Korea
Telephone: 82-2-511-5501
Facsimile: 82-2-511-2635

KUWAIT
YIACO MEDICAL Co.K.S.C.C.
P.O. Box 435
13005-Safat, Kuwait
Telephone: 965-4832600/4814358
Facsimile: 965-4844954/4833612

MALAYSIA
JEOL(MALAYSIA) SDN.BHD.(359011-M)
205, Block A, Mezzanine Floor,
Kelana Business Center,
97, Jalan SS 7/2, Kelana Jaya,
47301 Petaling Jaya, Selangor, Malaysia
Telephone: 60-3-7492-7722
Facsimile: 60-3-7492-7723

MEXICO
JEOL DE MEXICO S.A. DE C.V.
Av. Amsterdam #46 DEPS. 402
Col Hipodromo, 06100, Mexico D.F.
Mexico
Telephone: 52-5-55-211-4511
Facsimile: 52-5-55-211-0720

PAKISTAN (Karachi)
ANALYTICAL MEASURING SYSTEM (PVT) LTD.(AMS LTD.)
14-C Main Sehar Commercial Avenue Lane 4,
Khayaban-e-Sehar,
D.H.A-VII, Karachi-75500, Pakistan
Telephone: 92-21-5345581/5340747
Facsimile: 92-21-5345582

PANAMA
PROMED S.A.
Parque Industrial Costa del Este
Urbanizacion Costa del Este
Apartado 0816-01755, Panama, Panama
Telephone: 507-303-3100
Facsimile: 507-303-3115

PHILIPPINES
PHILAB INDUSTRIES INC.
7487 Bagtikan Street, SAV Makati,
1203 Metro, Manila Philippines
Telephone: 63-2-896-7218
Facsimile: 63-2-897-7732

PORTUGAL
Izasa Portugal Lda.
R. do Proletariado, 1
2790-138 CARNAXIDE, Portugal
Telephone: 351-21-424-73-00
Facsimile: 351-21-418-60-20

RUSSIA
JEOL LTD Moscow Office
Pereulok Krasina 16, bld 1. Office 302,
Moscow, Russia
Telephone: 7-495-641-11-14
Facsimile: 7-495-641-11-23

SAUDI ARABIA
ABDULREHMAN ALGOSAIBI G.T.C (Riyadh)
King Abdulaziz Avenue,
P.O. Box 215, Riyadh 11411, Saudi Arabia
Telephone: 966-1-479-3000
Facsimile: 966-1-477-1374

SCANDINAVIA
JEOL (SKANDINAVISKA) A.B.
Hammarbacken 6A, Box 716, 191 27 Sollentuna
Sweden
Telephone: 46-8-28-2800
Facsimile: 46-8-29-1647

SERVICE & INFORMATION OFFICE
JEOL NORWAY
Ole Deviks vei 28, N-0614 Oslo, Norway
Telephone: 47-2-2-64-7930
Facsimile: 47-2-2-65-0619

JEOL FINLAND
Ylakaupinkuja 2, FIN-02360 Espoo, Finland
Telephone: 358-9-8129-0350
Facsimile: 358-9-8129-0351

JEOL DENMARK
Naverland 2, DK-2600 Glostrup, Denmark
Telephone: 45-4345-3434
Facsimile: 45-4345-3433

SINGAPORE
JEOL (ASIA) PTE. LTD.
2 Corporation Road #01-12 Corporation Place
Singapore 618494
Telephone: 65-6565-9989
Facsimile: 65-6565-7552

SOUTH AFRICA
ADI Scientific (Pty) Ltd.
370 Angus Crescent,
Northlands Business Park, 29 Newmarket Road
Northriding, Ranburg, Republic of South Africa
Telephone: 27-11-462-1363
Facsimile: 27-11-462-1466

SPAIN
IZASA. S.A.
Argoneses, 13, 28100 Alcobendas,
(Poligono Industrial), Madrid, Spain
Telephone: 34-91-663-0500
Facsimile: 34-91-663-0545

SWITZERLAND
JEOL (GERMANY) GmbH
Oskar-Von-Miller Strasse 1,
85386 Eching, Germany
Telephone: 49-8165-77346
Facsimile: 49-8165-77512

TAIWAN
JIE DONG CO., LTD.
7F., 112, Chung Hsiao East Road,
Section 1, Taipei, Taiwan 10023
Republic of China
Telephone: 886-2-2395-2978
Facsimile: 886-2-2322-4655

For Semiconductor Products:
JEOL TAIWAN SEMICONDUCTORS LTD.
11F., No. 346, Pei-Ta Road, Hsin-Chu City 300,
Taiwan, Republic of China
Telephone: 886-3-523-8490
Facsimile: 886-3-523-8503

THAILAND
BECTHAI BANGKOK EQUIPMENT & CHEMICAL CO., Ltd.
300 Phaholyothin Rd. Phayathai, Bangkok 10400,
Thailand
Telephone: 66-2-615-2929
Facsimile: 66-2-615-2300/2351

THE NETHERLANDS
JEOL (EUROPE) B.V.
Lireweg 4, NL-2153 PH Nieuw-Vennep,
The Netherlands
Telephone: 31-252-623500
Facsimile: 31-252-623501

TURKEY
TEKSER LTD.STL
Acoibadem Cad. Erdem Sok. N° 6/1
34660, Uskudar, Istanbul, Turkey
Telephone: 90-216-3274041
Facsimile: 90-216-3274046

UAE
BUSINESS COMMUNICATIONS LLC. (Abu Dhabi)
P.O. Box 2534, Abu Dhabi UAE
Telephone: 971-2-6348495
Facsimile: 971-2-6316465

BUSINESS COMMUNICATIONS LLC. (Dubai)
P.O. Box 233, Dubai, UAE
Telephone: 971-4-2220186
Facsimile: 971-4-2236193

USA
JEOL USA, INC.
11 Dearborn Road, Peabody, MA 01960, U.S.A.
Telephone: 1-978-535-5900
Facsimile: 1-978-536-2205/2206

JEOL USA, INC. WEST OFFICE
5653 Stoneridge Drive Suite #110
Pleasanton, CA 94588, U.S.A.
Telephone: 1-925-737-1740
Facsimile: 1-925-737-1749

VENEZUELA
GOMSA Service and Supply C.A.
Urbanizacion Montalban III
- Residencias Don Andres - Piso 7 - Apartamento 74
Avenida S. entre calles 7 y 6
Montalban, Caracas, Venezuela
Telephone: 58-2-12-443432
Facsimile: 58-212-443-4342

VIETNAM
TECHNICAL MATERIALS AND RESOURCES IMPORT-
EXPORT JOINT STOCK COMPANY(REXCO)
Hanoi Branch,
157 Lang Ha Road, Dong da District, Hanoi, Vietnam
Telephone: 84-4-562-0516, 17/562-0535
Facsimile: 84-4-853-2511