



InstruTech®















**Series 3000 - The *New* Generation of B-RAX™ Vacuum Gauge Controllers**

- ◆ 3 Channel Controller for one ionization and two convection gauges or one ionization, one convection and one alternate capacitance diaphragm gauge
- ◆ Various pressure measurement ranges from  $2 \times 10^{-11}$  to 1,000 Torr
- ◆ 3 analog outputs, 6 setpoint relays, RS232/RS485 serial communications, remote Digital I/O
- ◆ Compact space saving half rack design, bench top or panel/rack mount instrument
- ◆ Outstanding product warranty of 5 years



**Description**

The InstruTech series 3000 B-RAX is a highly versatile vacuum gauge controller capable of operating one hot or cold cathode ionization gauge (IG) and up to two CVG101 convection vacuum gauge sensors (CG), or one IG, one CG and one alternate gauge such as a capacitance diaphragm gauge (CDG). The ionization gauge on/off, degas functions and emission current selection can be controlled via front panel soft-keys, remote input signals (Digital I/O), or serial communications. IG sensor can also be automatically turned on/off using the measurements from one of the user selectable convection or alternate gauges. When using hot cathode IGs, the B-RAX can be set to automatically switch (auto-ranging) between various emission currents. This results in optimal and stable pressure readings over the entire measurement range from low to high vacuum. High efficiency power supply design and effective thermal management techniques are used to enable operation of the B-RAX without the need for air movement devices such as troublesome fans. The state of all setpoint relays, emission current, filament in use and error messages for all fault conditions are displayed on the easy to read OLED set-up screen. Filament operation including filament current, filament voltage, emission current and ion current can be displayed in real time to allow monitoring of filament condition.

B-RAX Controller	Ionization Gauge (IG) Compatibility		Convection Gauge (CG) Compatibility
<b>B-RAX 3500</b> 	One CC606 UHV Cold Cathode ( $7.5 \times 10^{-11}$ to $3.75 \times 10^{-3}$ Torr) 	or One CC605 Cold Cathode ( $1.5 \times 10^{-9}$ to $3.75 \times 10^{-3}$ Torr) 	Up to two CVG101 Convection Gauges ( $1 \times 10^{-4}$ to 1,000 Torr) 
<b>B-RAX 3400</b> 	One BA601 UHV Nude EB Hot Cathode ( $2 \times 10^{-11}$ to $1 \times 10^{-3}$ Torr) 	or One BA600 Mini IG Hot Cathode ( $1 \times 10^{-9}$ to $5 \times 10^{-2}$ Torr) 	Up to two CVG101 Convection Gauges ( $1 \times 10^{-4}$ to 1,000 Torr) 
<b>B-RAX 3300</b> 	One BA602 Nude I <sup>2</sup> R Hot Cathode ( $4 \times 10^{-10}$ to $1 \times 10^{-3}$ Torr) 	or One BA603 Glass I <sup>2</sup> R Hot Cathode ( $4 \times 10^{-10}$ to $1 \times 10^{-3}$ Torr) 	Up to two CVG101 Convection Gauges ( $1 \times 10^{-4}$ to 1,000 Torr) 
<b>B-RAX 3200</b> 	One IGM400 Hot Cathode ( $1 \times 10^{-9}$ to $5 \times 10^{-2}$ Torr) 		Up to two CVG101 Convection Gauges ( $1 \times 10^{-4}$ to 1,000 Torr) 

## Specifications

measurement range:	<b>B-RAX 3500:</b> $7.5 \times 10^{-11}$ to 1,000 Torr when used with the CC606 UHV cold cathode IG and CVG101 CG <b>B-RAX 3500:</b> $1.5 \times 10^{-9}$ to 1,000 Torr when used with the CC605 cold cathode IG and CVG101 CG
	<b>B-RAX 3400:</b> $2 \times 10^{-11}$ to 1,000 Torr when used with the BA601 UHV hot cathode IG and CVG101 CG <b>B-RAX 3400:</b> $1 \times 10^{-9}$ to 1,000 Torr when used with the BA600 hot cathode Mini IG and CVG101 CG
	<b>B-RAX 3300:</b> $4 \times 10^{-10}$ to 1,000 Torr when used with the BA602/603 hot cathode IG and CVG101 CG
	<b>B-RAX 3200:</b> $1 \times 10^{-9}$ to 1,000 Torr when used with the IGM400 hot cathode IG and CVG101 CG
display pressure indication programming & set-up screen	LED - 3 independent pressure display channels - 3 digit plus 2 digit exponent per channel OLED - displays state of all setpoint relays, IG emission current, error messages for fault conditions
units of measure	Torr, mbar, Pa - user selectable
functionality	IG powers & operates one of the InstruTech ionization vacuum gauges listed above <b>B-RAX 3400/3300</b> are also capable of operating other equivalent brands of nude/glass B-A hot cathode IG
	CG powers & operates up to 2 InstruTech CVG101 convection or Granville-Phillips® (GP) Convectron® gauges
	alternate gauge displays pressure from one alternate gauge such as a capacitance diaphragm gauge (CDG) or other InstruTech modules using the analog input (external power source for these alternate auxiliary devices will be required)
IG sensor control	IG sensor on/off, degas on/off and emission current (hot cathode IG) can all be controlled via front panel soft-keys, remote input signals (digital I/O) or serial communications. IG sensor can also be automatically turned on/off using the measurements from one of the user selectable convection or alternate gauges.
IG remote input signals (digital I/O)	IG sensor on/off, degas on/off and emission current (hot cathode IG) can also be set by applying momentary continuity to ground. Also the 9-pin D-sub remote input DIGITAL I/O connector provides pin-pin compatible signals with the GP 358 controller as well as compatible signals with the GP 307.
setpoint relays / relay contact rating	six single-pole, double-throw (SPDT) / 5 A at 30 Vdc, 5 A at 250 Vac, resistive load, user assignable to any of the gauges ( <b>Note-</b> Contact rating applies to units shipped after Nov 1, 2015, See User Manual for older units)
analog output	three analog outputs, user assignable to any of the gauges:
	IG log linear 0 to 10 Vdc, 1 V/decade, various scaling selections also provide analog output compatibility with Granville-Phillips® controller models 307, 350 and 358 controllers, or log Linear 1.7 V to 9.3 Vdc (nominal 1.8 to 8.7 Vdc) 0.8 V/decade, or linear 0 to 10 Vdc (useable over 3 decades, also compatible with GP 307 controller)
	combination IG + CG or IG + Alternate Gauge log linear 0.5 to 7 Vdc, 0.5 V/decade
	CG log linear 1 to 8 Vdc, 1 V/decade, or 0 to 7 Vdc, 1 V/decade (also compatible with GP 307, 350, 358), or non-linear analog S-curve 0.375 to 5.659 Vdc, or linear 0 to 10 Vdc (useable over 3 decades)
analog input	CDG 0-10 Vdc analog input signal from CDM900 or other brands of CDG when used as an alternate gauge to CG2, or InstruTech modules analog input from InstruTech gauges: CCM501,CCM502,CVM201,CVM211,IGM401,IGM402,PCM301,WGM701
serial communications	RS485 / RS232 - ASCII protocol - (command protocol provides compatibility with GP 307 and GP 358 controller GP350 command protocol compatibility is also available for all models except B-RAX 3500)
status output	IG sensor on/off status message is displayed on the front panel, by serial communications and by SPDT relay (DIGITAL I/O Connector) rated at 1 A at 30 Vdc resistive, or 1 A at 30 Vac non-inductive.  IG degas on/off status or IG error conditions are displayed on the front panel, by serial communications and by an open collector transistor output (ground emitter) rated at 40 V max. VCE, 50 mA IC max.
IG hot cathode filament switching	user selectable between filament 1 or 2 using the front panel soft-keys or RS232/485 serial communications
IG hot cathode emission current	<b>B-RAX 3400/3300:</b> 100 $\mu$ A, 4 mA, 10 mA or automatic switching (auto ranging) between 100 $\mu$ A, 4 mA, 10 mA <b>B-RAX 3200:</b> 100 $\mu$ A, 4 mA, or automatic switching (auto ranging) between 100 $\mu$ A and 4 mA
IG hot cathode degas	<b>B-RAX 3400:</b> 40 W, electron bombardment (EB) when used with BA601, 3 W, EB when used with BA600 <b>B-RAX 3300:</b> 40 W, resistive (I <sup>2</sup> R) <b>B-RAX 3200:</b> 3 W, EB <b>B-RAX 3500:</b> N/A
IG overpressure protection	IG sensor turns off if pressure exceeds maximum allowable pressure limit of IG
temperature	operating: 0 to + 40 °C storage: -40 to + 70 °C
humidity	0 to 95% relative humidity, non-condensing
weight	1.7 lb. (0.7 kg)
housing	aluminum extrusion - black powder paint finish

input power	<b>B-RAX 3400/3300:</b> 20 - 28 Vdc, 200 W when used with BA601, BA602 and BA603 IG <b>B-RAX 3400:</b> 20 - 28 Vdc, 36 W when used with BA600 Mini IG <b>B-RAX 3200:</b> 20 - 28 Vdc, 36 W <b>B-RAX 3500:</b> 20 - 28 Vdc, 12 W B-RAX circuitry is protected against power reversal and transient over-voltages
connectors	IG & CG gauge cable assemblies provided by InstruTech digital I/O 9-pin D-sub male serial communications RS232: 9-pin D-sub female, RS485: 9-pin D-sub male analog I/O, setpoint relays, power pluggable terminal block (mating connectors included)
CE compliance	EMC Directive 2014/30/EU, EN55011, EN61000-6-2, EN61000-6-4, EN61326-1, EN61010-1
environmental	RoHS Directive 2011/65/EU

**Front Panel Operation**

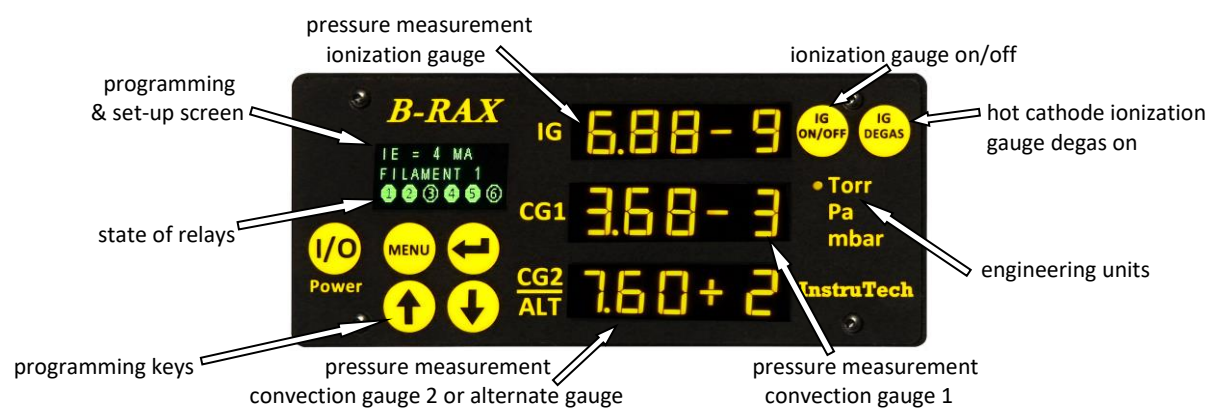

**Electrical Connections**

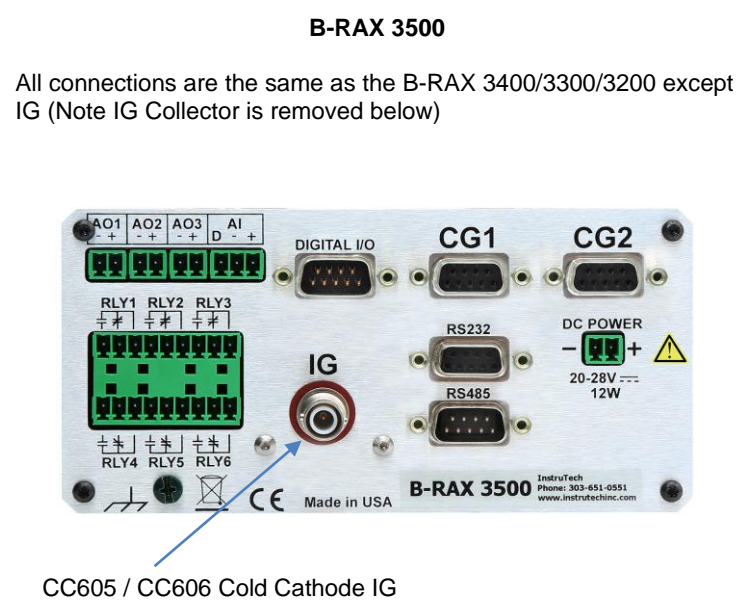
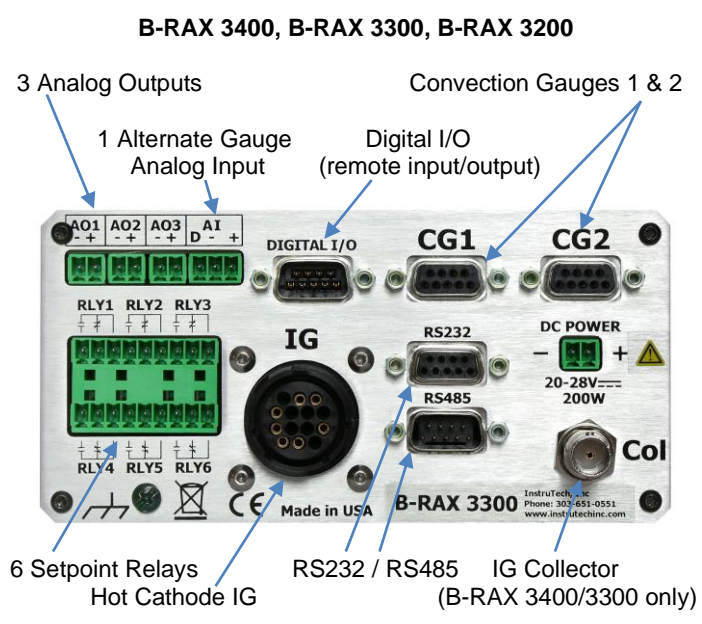

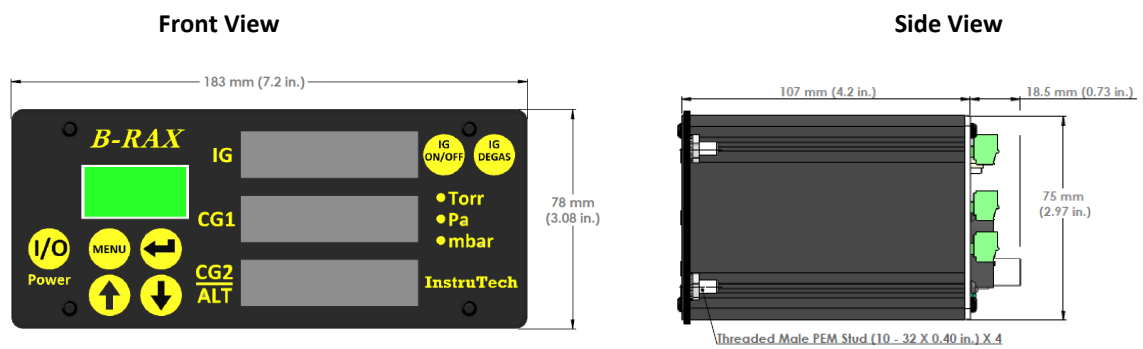

**Outline Drawing**



**Ordering Information**



**Part Numbers**

<p><b>B-RAX Vacuum Gauge Controller</b>                  3 channel pressure display vacuum gauge controller. Operates one ionization gauge (IG) plus up to two convection gauges (CG), or one IG, one CG and one analog input from an alternate gauge such as a CDG. Includes 6 setpoint relays, 3 analog outputs, Digital I/O, RS232/RS485 serial communications.</p>		
<p>B-RAX 3500: Operates one CC605 or one CC606 cold cathode IG plus up to two CGs                  B-RAX 3400: Operates one BA601 UHV nude EB-degas IG or one BA600 hot cathode Mini IG plus up to two CGs                  B-RAX 3300: Operates one BA602 nude or BA603 glass I<sup>2</sup>R hot cathode IG plus up to two CGs                  B-RAX 3200: Operates one IGM400 hot cathode plus up to two CGs</p>		<p>B-RAX 3500                  B-RAX 3400                  B-RAX 3300                  B-RAX 3200</p>

<p><b>Optional 24 Vdc Power Supply for B-RAX</b>                  Connector: 2-pin pluggable terminal block to mate with the B-RAX                  Compliance: CE, RoHS, UL (US/Canada), CCC (China)                  Power Input: 100 - 240 Vac, 50-60 Hz                  Power Output: PS330: 24 Vdc @ 9.16 A (220 W) see selection details below                  PS301: 24 Vdc @ 2.5 A (60 W) see selection details below</p>		
<p>For B-RAX 3400 / 3300 when used with BA601, BA602 and BA603 IG (Power cord with North American 115 Vac plug included)                  For B-RAX 3400 / 3300 when used with BA601, BA602 and BA603 IG (No power cord included*)</p>		<p>PS330-UA                  PS330-UX</p>
<p>For B-RAX 3400 when used with BA600 Mini IG, B-RAX 3500, B-RAX 3200 (Power cord with North American 115 Vac plug included)                  For B-RAX 3400 when used with BA600 Mini IG, B-RAX 3500, B-RAX 3200 (No power cord included*)</p>		<p>PS301-UA                  PS301-UX</p>
<p>* The conventional IEC60320 AC receptacle allows use with any user supplied AC mains power cord set available worldwide.</p>		

Gauge Cable	BA601/602 IG B-RAX 3400/3300 Bakeable, 200 °C	BA601/602 IG B-RAX 3400 B-RAX 3300	BA603 IG B-RAX 3300	BA600 IG B-RAX 3400	IGM400 IG CCM500 IG B-RAX 3200	CC605/CC606 IG B-RAX 3500 Bakeable, 250 °C	CC605 IG CC606 IG B-RAX 3500	CVG101 CG All B-RAX Models
10 ft. (3 m)	IRNBD441-1-10F	IRN441-1-10F	IRG441-1-10F	HMG441-1-10F	BXC400-1-10F	CCPB641-1-10F	CCP641-1-10F	CB421-1-10F
25 ft. (8 m)	IRNBD441-1-25F	IRN441-1-25F	IRG441-1-25F	HMG441-1-25F	BXC400-1-25F	CCPB641-1-25F	CCP641-1-25F	CB421-1-25F
50 ft. (15 m)	IRNBD441-1-50F	IRN441-1-50F	IRG441-1-50F	HMG441-1-50F	BXC400-1-50F	CCPB641-1-50F	CCP641-1-50F	CB421-1-50F
>50 ft.	Consult factory							

Note: The IRNBD441 bakeable Nude IG cable is provided with push-on sockets for connection to the Nude gauge pins (BA601/602 pins) and is bakeable to 200 °C. All other cables for hot cathode and convection gauges listed above are rated for 50 °C ambient temperature. All IG cables for hot cathode gauges listed above can be used with either single or dual filament ion gauges and filament switching is controlled from the B-RAX controller. The CCPB641 bakeable cold cathode IG cable is bakeable to 250 °C while the CCP641 cold cathode IG cable is rated to 80 °C.

<p><b>Optional Rack Mount Adapter</b> Aluminum - black powder paint finish                  Rack Mount adapter panel for installation of one B-RAX as a left-mount or right-mount in a 2U, 19 inch wide rack.</p> 	<p>IL000849</p>
<p>Rack Mount adapter panel for installation of two B-RAX side-by-side in a 2U, 19 inch wide rack.</p> 	<p>IL001007</p>

<p><b>BA600, BA601, BA602, BA603, IGM400, CCM500, CC605, CC606 ionization gauges</b></p>	<p>See data sheets for these IG products</p>
<p><b>CVG101 convection gauge</b></p>	<p>See CVG101 Worker Bee™ convection gauge data sheet</p>

Granville-Phillips® and Convection® are registered trademarks of MKS Instruments, Andover, MA.



**InstruTech®**  
 1475 S. Fordham Street  
 Longmont, CO 80503  
 USA

Phone +1-303-651-0551  
 Fax: +1-303-678-1754  
 E-mail info@instrutechinc.com  
 Web www.instrutechinc.com