

HARS-LX

Laboratory Standard Decade Resistance Substituter User and Service Manual



Copyright © 2014 IET Labs, Inc.
Visit www.ietlabs.com for manual revision updates

HARS-LX-im November 2014

◆ PRECISION INSTRUMENTS FOR TEST AND MEASUREMENT ◆



IET LABS, INC.

www.ietlabs.com
Email: info@ietlabs.com
TEL: (516) 334-5959 • FAX: (516) 334-5988

WARRANTY

We warrant that this product is free from defects in material and workmanship and, when properly used, will perform in accordance with applicable IET specifications. If within one year after original shipment, it is found not to meet this standard, it will be repaired or, at the option of IET, replaced at no charge when returned to IET. Changes in this product not approved by IET or application of voltages or currents greater than those allowed by the specifications shall void this warranty. IET shall not be liable for any indirect, special, or consequential damages, even if notice has been given to the possibility of such damages.

THIS WARRANTY IS IN LIEU OF ALL OTHER WARRANTIES, EXPRESSED OR IMPLIED, INCLUDING BUT NOT LIMITED TO, ANY IMPLIED WARRANTY OF MERCHANTABILITY OR FITNESS FOR ANY PARTICULAR PURPOSE.



WARNING



OBSERVE ALL SAFETY RULES
WHEN WORKING WITH HIGH VOLTAGES OR LINE VOLTAGES.

**Dangerous voltages may be present inside this instrument. Do not open the case
Refer servicing to qualified personnel**

HIGH VOLTAGES MAY BE PRESENT AT THE TERMINALS OF THIS INSTRUMENT

WHENEVER HAZARDOUS VOLTAGES (> 45 V) ARE USED, TAKE ALL MEASURES TO
AVOID ACCIDENTAL CONTACT WITH ANY LIVE COMPONENTS.

USE MAXIMUM INSULATION AND MINIMIZE THE USE OF BARE
CONDUCTORS WHEN USING THIS INSTRUMENT.

Use extreme caution when working with bare conductors or bus bars.

WHEN WORKING WITH HIGH VOLTAGES, POST WARNING SIGNS AND
KEEP UNREQUIRED PERSONNEL SAFELY AWAY.



CAUTION



DO NOT APPLY ANY VOLTAGES OR CURRENTS TO THE TERMINALS OF THIS
INSTRUMENT IN EXCESS OF THE MAXIMUM LIMITS INDICATED ON
THE FRONT PANEL OR THE OPERATING GUIDE LABEL.

Contents

Chapter 1 Introduction	1
1.1 Introduction.....	1
Chapter 2 Specifications	2
Specifications	2
Chapter 3 Installation	4
3.1 Initial Inspection	4
3.2 Installation.....	4
3.3 Repackaging for Shipment.....	4
3.4 Storage	4
Chapter 4 Operation	5
4.1 Initial Inspection and Setup	5
4.2 Connection.....	5
4.2.1 General Considerations.....	5
4.3 Electrical Considerations	5
4.3.1 Thermal emf Considerations.....	5
4.4 Dial Setting	6
4.5 Power Considerations	6
4.6 Environmental Conditions	6
4.7 Switch Conditioning	6
4.8 Meter Shunt Applications	7
4.9 Kelvin Bridge Applications.....	7
Chapter 5 Maintenance.....	8
5.1 Maintainability and Reliability	8
5.2 Preventive Maintenance.....	8
5.3 Calibration.....	8
5.3.1 Calibration Interval.....	8
5.3.2 General Considerations.....	9
5.3.3 Required Equipment	9
5.3.4 Calibration Procedure	9
5.4 Adjustments.....	10
5.4.1 Adjustment Considerations.....	10
5.4.2 Adjustment/Trimming Procedure	10
5.5 Replaceable Parts List.....	12

Figures and Tables

<i>Figure 1-1: HARS-LX Resistance Substituter</i>	<i>1</i>
<i>Figure 2-1: Typical Operating Guide Affixed to Unit.....</i>	<i>3</i>
<i>Figure 4-1: Kelvin Bridge Connections.....</i>	<i>7</i>
<i>Table 5-1: Trimming Potentiometers</i>	<i>11</i>
<i>Figure 5-1: Typical Trimmer Board.....</i>	<i>11</i>
<i>Table 5-2: Replaceable Parts List.....</i>	<i>12</i>
<i>Figure 5-2: HARS-LX Replaceable Parts</i>	<i>12</i>

Chapter 1

INTRODUCTION

1.1 Introduction

The HARS-LX Series Laboratory Standard Decade Resistance Substituter provides a very broad-range high-performance resistance source.

The HARS-LX Series substituter is a precision resistance source with excellent characteristics of accuracy, stability, temperature coefficient, and power coefficient. All these features serve to make it a laboratory resistance standard, exceeded in performance only by stand-alone standard resistors. The special design of the HARS-LX requires no zero resistance subtraction from settings.

Hermetically sealed wirewound resistors are used for 1 Ω steps and over. These resistors are carefully conditioned under power and temperature in order to develop the best stability characteristics. Actual experience has shown them to exhibit a storage stability of better than 5 ppm/year, improving as they age. The low-resistance resistors are constructed with resistance wire with a minimum of copper resistance in series to limit temperature coefficient effects.

The HARS-LX Series employs completely enclosed dust-tight very low contact resistance switches. They feature solid silver alloy contacts and quadruple-leaf silver alloy wipers which keep switch contact resistance to under 1 m Ω per decade, and more importantly, keep switch contact resistance *reproducible*, insuring repeatable instrument performance.

High-quality gold-plated tellurium-copper binding posts minimize the thermal emf effects which would artificially reflect a change in dc resistance measurements. All other conductors within the instrument, as well as the solder employed, contain no metals or junctions that contribute to thermal emf problems.

The HARS-LX is designed to allow very convenient maintenance of calibration over time. Most decades are adjustable without changing components or soldering resistors. The decades for the 100 Ω through 1 M Ω steps are adjusted with convenient trimmers. Trimming of the lower decades is also possible.

With a resolution as low as 1 m Ω and a maximum available resistance of over 12.2 M Ω , the HARS-LX Series may be employed for exacting precision measurement applications requiring high accuracy and stability. They can be used as components of dc and low frequency ac bridges, for calibration, as transfer standards, and as RTD simulators.



Figure 1-1: HARS-LX Laboratory Standard Decade Resistance Substituter 11 Dials with Rack Mount



Figure 1-2: HARS-LX Laboratory Standard Decade Resistance Substituter 2 Dials

Chapter 2

SPECIFICATIONS

For convenience to the user, the pertinent specifications are given in a typical **OPERATING GUIDE**, like the one shown in Figure 2.1, affixed to the case of the instrument.

SPECIFICATIONS

Resistance per step	Total decade resistance	Max current	Max power	Temperature coefficient (\pm ppm/ $^{\circ}$ C)	Power coefficient (\pm ppm/mW)	Accuracy*	Stability (\pm ppm/yr)	Decade positions	Resistor type	
		whichever applies first								
100 $\mu\Omega$ division 20 $\mu\Omega$ resolution (-RH Option)	10 m Ω	2 A	NA	20	1	\pm (20 ppm+0.5 m Ω)	20 ppm+0.5 m Ω	Continuous	Rheostat	
1 m Ω	10 m Ω	2 A	NA	20	1			11 positions "0"- "10"	Resistance wire	
10 m Ω	100 m Ω	2 A	NA	20	1			10 positions "1"- "10" (10 m Ω minimum reading)		
100 m Ω	1 Ω	2 A	NA	20	1			11 positions "0"- "10" (12 positions "0"- "11" for highest decade, where highest decade steps are 1 Ω , 10 Ω , 10 k Ω , 100 k Ω , 1 M Ω , and 10 M Ω .) See Ordering Information section below.	Wirewound hermetically sealed low-inductance	
1 Ω	10 Ω	1 A	5 W	20	0.4					
10 Ω	100 Ω	0.33 A	5 W	10	0.3					
100 Ω	1 k Ω	0.1 A	5 W	3	0.1					
1 k Ω	10 k Ω	33 mA	5 W	3	0.1					
10 k Ω	100 k Ω	10 mA	5 W	3	0.1					
100 k Ω	1 M Ω	3 mA	2,000 V peak	3	0.1					
1 M Ω	10 M Ω	1 mA	2,000 V peak	3	0.1					
10 M Ω	100 M Ω	2,000 V peak		15	0.2			\pm 0.02%	50 ppm	Metal oxide
Wiring and switch resistance	NA		50 $\mu\Omega$ / $^{\circ}$ C	0.2 $\mu\Omega$ /W	NA					

*At 23 $^{\circ}$ C "true ohm" measurement, 30-70% RH, absolute reading, SI traceable; no zero subtraction required

Minimum resistance:

With this design, absolute accuracy, *without* zero subtraction, is accomplished by having a minimum settable resistance, *which includes all contact and wiring resistances*. Absolute accuracy applies for every setting. The minimum resistance is determined by the lowest resolution of the unit and by internal resistance. See **Model Information** for the minimum settable resistance for any model. Minimum settable resistance is implemented by a mechanical stop in one of the decades.

Resistance repeatability:

Less than 100 $\mu\Omega$, short-term, average value.

Leakage resistance:

>10 G Ω

Environmental conditions:

Operating temperature: 0 $^{\circ}$ C to 55 $^{\circ}$ C

Storage temperature: -40 $^{\circ}$ C to 70 $^{\circ}$ C

Switch type:

Multiple solid silver contacts; dust-tight diallyl-phthalate body.

To allow continuous rotation, a blank position is added on most decades.

Resistor type:

Wirewound, hermetically sealed, low-inductance

Terminals:

Four, 5-way, gold-plated, tellurium-copper binding posts with low thermal emf and low resistance, for four-terminal Kelvin measurements, plus one binding post connected to case for shielding. Rear outputs are available as an option.

An additional Kel-F washer is added under the High and Low binding posts for decade boxes that have a 10 M Ω /step decade.

Range and resolution:

See Model Information

Mechanical Information:

Model	Dimensions	Nominal Weight
1 decade	7.7 cm W x 7.7 cm H x 8.4 cm D (3" W x 3" H x 3.3" D)	0.45 kg (1.0 lb)
3 decades	37.5 cm W x 8.9 cm H x 10.2 cm D (14.8" W x 3.5" H x 4" D)	2.0 kg (4.3 lb)
4-5 decades	43.9 cm W x 8.9 cm H x 10.2 cm D (17.3" W x 3.5" H x 4.0" D)	2.2 kg (4.8 lb)
6-10 decades	48.3 cm W x 17.8 cm H x 19.7 cm D (19" W x 7" H x 7.8" D)	5.1 kg (11 lb)
11 decades	48.3 cm W x 31 cm H x 19.7 cm D (19" W x 12.3" H x 7.8" D)	6.6 kg (14 lb)

MODEL INFORMATION

Model	Nominal total resistance	No. of decades	Resolution	Minimum settable resistance**
HARS-LX-1-0.001	10 mΩ	1	1 mΩ	1 mΩ
HARS-LX-1-0.01	100 mΩ	1	10 mΩ	10 mΩ
HARS-LX-1-0.1	1 Ω	1	100 mΩ	100 mΩ
HARS-LX-1-1	11 Ω	1	1 Ω	1 Ω
HARS-LX-1-10	110 Ω	1	10 Ω	10 Ω
HARS-LX-1-100	1.0 kΩ	1	100 Ω	100 Ω
HARS-LX-1-1k	10 kΩ	1	1 kΩ	1 kΩ
HARS-LX-1-10k	110 kΩ	1	10 kΩ	none
HARS-LX-1-100k	1.1 MΩ	1	100 kΩ	none
HARS-LX-1-1M	11 MΩ	1	1 MΩ	none
HARS-LX-1-10M	110 MΩ	1	10 MΩ	none
HARS-LX-2-0.001	110 mΩ	2	1 mΩ	2 mΩ
HARS-LX-2-0.01	1.10 Ω	2	10 mΩ	10 mΩ
HARS-LX-2-0.1	12.0 Ω	2	100 mΩ	100 mΩ
HARS-LX-2-1	120 Ω	2	1 Ω	1 Ω
HARS-LX-2-10	1.10 kΩ	2	10 Ω	10 Ω
HARS-LX-2-100	11.0 kΩ	2	100 Ω	100 Ω
HARS-LX-2-1k	120 kΩ	2	1 kΩ	1 kΩ
HARS-LX-2-10k	1.20 MΩ	2	10 kΩ	none
HARS-LX-2-100k	12.0 MΩ	2	100 kΩ	none
HARS-LX-2-1M	120 MΩ	2	1 MΩ	none
HARS-LX-3-0.001	1.110 Ω	3	1 mΩ	*
HARS-LX-3-0.01	12.10 Ω	3	10 mΩ	10 mΩ
HARS-LX-3-0.1	121.0 Ω	3	100 mΩ	100 mΩ
HARS-LX-3-1	1.110 kΩ	3	1 Ω	1 Ω
HARS-LX-3-10	11.10 kΩ	3	10 Ω	10 Ω
HARS-LX-3-100	121.0 kΩ	3	100 Ω	100 Ω
HARS-LX-3-1k	1.210 MΩ	3	1 kΩ	1 kΩ
HARS-LX-3-10k	12.10 MΩ	3	10 kΩ	none
HARS-LX-3-100k	121.0 MΩ	3	100 kΩ	none
HARS-LX-4-0.001	12.110 Ω	4	1 mΩ	*
HARS-LX-4-0.01	121.10 Ω	4	10 mΩ	10 mΩ
HARS-LX-4-0.1	1.111 0 kΩ	4	100 mΩ	100 mΩ
HARS-LX-4-1	11.110 kΩ	4	1 Ω	1 Ω
HARS-LX-4-10	121.10 kΩ	4	10 Ω	10 Ω
HARS-LX-4-100	1.211 0 MΩ	4	100 Ω	100 Ω
HARS-LX-4-1k	12.110 MΩ	4	1 kΩ	1 kΩ
HARS-LX-4-10k	121.10 MΩ	4	10 kΩ	none
HARS-LX-5-0.001	121.110 Ω	5	1 mΩ	*
HARS-LX-5-0.01	1.111 10 kΩ	5	10 mΩ	10 mΩ
HARS-LX-5-0.1	11.111 0 kΩ	5	100 mΩ	100 mΩ
HARS-LX-5-1	121.110 kΩ	5	1 Ω	1 Ω
HARS-LX-5-10	1.211 10 MΩ	5	10 Ω	10 Ω
HARS-LX-5-100	12.111 0 MΩ	5	100 Ω	100 Ω
HARS-LX-5-1k	121.110 MΩ	5	1 kΩ	1 kΩ
HARS-LX-6-0.001	1.111 110 kΩ	6	1 mΩ	*
HARS-LX-6-0.01	11.111 10 kΩ	6	10 mΩ	10 mΩ
HARS-LX-6-0.1	121.111 0 kΩ	6	100 mΩ	100 mΩ

Model	Nominal total resistance	No. of decades	Resolution	Minimum settable resistance**
HARS-LX-6-1	1.211 110 MΩ	6	1 Ω	1 Ω
HARS-LX-6-10	12.111 10 MΩ	6	10 Ω	10 Ω
HARS-LX-6-100	121.111 0 MΩ	6	100 Ω	100 Ω
HARS-LX-7-0.001	11.111 110 kΩ	7	1 mΩ	*
HARS-LX-7-0.01	121.111 10 kΩ	7	10 mΩ	10 mΩ
HARS-LX-7-0.1	1.211 111 0 MΩ	7	100 mΩ	100 mΩ
HARS-LX-7-1	12.111 110 MΩ	7	1 Ω	1 Ω
HARS-LX-7-10	121.111 10 MΩ	7	10 Ω	10 Ω
HARS-LX-8-0.001	121.111 110 kΩ	8	1 mΩ	*
HARS-LX-8-0.01	1.211 111 10 MΩ	8	10 mΩ	10 mΩ
HARS-LX-8-0.1	12.111 111 0 MΩ	8	100 mΩ	100 mΩ
HARS-LX-8-1	121.111 110 MΩ	8	1 Ω	1 Ω
HARS-LX-9-0.001	1.211 111 110 MΩ	9	1 mΩ	*
HARS-LX-9-0.01	12.111 111 10 MΩ	9	10 mΩ	10 mΩ
HARS-LX-9-0.1	121.111 111 0 MΩ	9	100 mΩ	100 mΩ
HARS-LX-10-0.001	12.111 111 110 MΩ	10	1 mΩ	*
HARS-LX-10-0.01	121.111 111 10 MΩ	10	10 mΩ	10 mΩ
HARS-LX-11-0.001	121.111 111 110 MΩ	11	1 mΩ	*

Options:

- RH: 10 mΩ rheostat for lowest decades, 20 μΩ resolution
- RO: Rear output binding posts
- RM: Rack-mountable case for standard 19" rack

*Customer Selection

**With this design, absolute accuracy, without zero subtraction, is accomplished by having a minimum settable resistance, which includes all contact and wiring resistances. Absolute accuracy applies for every setting. The minimum resistance is determined by the lowest resolution of the unit and by internal resistance. See Model Information for the minimum settable resistance for any model. Minimum settable resistance is implemented by a mechanical stop in one of the decades.

HARS-LX-5-100 OPERATING GUIDE

CONSULT INSTRUCTION MANUAL FOR PROPER INSTRUMENT OPERATION

Resistance per step	Total decade resistance	Max current whichever applies first	Max power	Temperature coefficient (ppm/°C)	Power coefficient (ppm/mW)	Stability (±ppm/yr)	Decade positions
100 Ω	1 kΩ	0.1 A	5 W	3	0.1	20 ppm+0.5 mΩ	10 positions "1"- "10" (100 Ω minimum reading)
1 kΩ	10 kΩ	33 mA	5 W	3	0.1		
10 kΩ	100 kΩ	10 mA	5 W	3	0.1	10 ppm (<5 ppm typical)	11 positions "0"- "10"
100 kΩ	1 MΩ	3 mA	5 W	3	0.1		
1 MΩ	11 MΩ	1 mA	1,500 V peak	3	0.1		12 positions "0"- "11"
Wiring and switch resistance		NA	NA	50 µΩ/°C	0.2 µΩ/W		NA

Accuracy:
±(20 ppm+0.5 mΩ)
*At 23°C "true ohm" measurement, 30-70% RH, absolute reading
No zero subtraction required

Minimum resistance:
100 Ω ± 0.5 mΩ; determined by the lowest settable position, "1", of the 100 Ω/step decade

Resistance repeatability:
Better than 100 µΩ, short-term, average value

Environmental Conditions:
Operating Temperature: 0°C to 55°C
Storage Temperature: -40°C to 70°C

Switch Type:
Multiple solid silver contacts; dust-tight diallyl-phthalate body. To allow continuous rotation, a blank position is added on most decades.

For Best Performance:
Whenever the unit has been idle, turn each switch 7-10 times both ways before using. This switch "break-in" procedure is standard metrology practice required for best accuracy to remove any silver oxide film on the contact surfaces, typically <1 mΩ.

Terminals:
Four, 5-way, gold-plated, tellurium-copper binding posts with low thermal emf and low resistance; for four-terminal Kelvin measurements, plus one binding post connected to case for shielding. Rear outputs are available as an option.

MODEL: HARS-LX-5-100 **SN: D5-1422571**



Observe all safety rules when working with high voltages or line voltages. Connect the (GND) terminal to earth ground in order to maintain the case at a safe voltage. Whenever hazardous voltages (>45 V) are used, take all measures to avoid accidental contact with any live components: a) Use maximum insulation and minimize the use of bare conductors. b) Remove power when adjusting switches. c) Post warning signs and keep personnel safely away.



IET LABS, INC.
CA GE CODE: E2015

• Long Island, NY • Email: info@ietlabs.com
• Tel: (516) 334-5959 • 800-899-8438 • Fax: (516) 334-5988

www.ietlabs.com

HARS-LX-5-100 BUS/2015

Figure 2-1: Typical Operating Guide Affixed to Unit (See label on your specific unit for actual specifications)

Chapter 3 Installation

3.1 Initial Inspection

IET instruments receive a careful mechanical and electrical inspection before shipment. Upon receipt, verify that the contents are intact and as ordered. The instrument should then be given a visual and operational inspection.

If any shipping damage is found, contact the carrier and IET Labs. If any operational problems are encountered, contact IET Labs and refer to the warranty at the beginning of this manual.

Save all original packing material for convenience in case shipping of the instrument should become necessary.

3.2 Installation

For a rack mounted model, installation in a 19 inch rack may be made using the slots in the rack mounting ears. A mounting location that does not expose the unit to excessive heat is recommended. For bench models there is no required installation.

Since this is a high accuracy instrument, it is recommended that a space be provided that would not expose it to mechanical abuse and keep it maintained at laboratory standard temperatures near 23°C.

3.3 Repackaging for Shipment

If the instrument is to be returned to IET Labs, contact the Service Department at the number or address, shown on the front cover of this manual, to obtain a “Returned Material Authorization” (RMA) number and any special shipping instructions or assistance.

Proceed as follows:

1. Attach a tag to the instrument identifying the owner and indicate the service or repair to be accomplished. Include the model number, the full serial number of the instrument, the RMA number, and shipping address.
2. Wrap the instrument in heavy paper or plastic.
3. Protect the front panel and any other protrusions with cardboard or foam padding.
4. Place instrument in original container or equally substantial heavy carton.
5. Use packing material around all sides of instrument.
6. Seal with strong tape or bands.
7. Mark shipping container “DELICATE INSTRUMENT,” “FRAGILE,” etc.

3.4 Storage

If this instrument is to be stored for any lengthy period of time, it should be sealed in plastic and stored in a dry location. It should not be subjected to temperature extremes beyond the specifications. Extended exposure to such temperatures can result in an irreversible change in resistance, and require recalibration.

Chapter 4

OPERATION

4.1 Initial Inspection and Setup

This instrument was carefully inspected before shipment. It should be in proper electrical and mechanical order upon receipt.

An OPERATING GUIDE is attached to the case of the instrument to provide ready reference to specifications.

4.2 Connection

Four insulated low-thermal-emf binding posts labeled **CURRENT HI**, **CURRENT LO**, **SENSE HI**, and **SENSE LO** provide two current and two potential terminals, respectively, for 4-terminal measurement. 2-terminal measurements may be made by shorting **CURRENT HI** to **SENSE HI**, and **CURRENT LO** to **SENSE LO**, preferably with shorting links or other substantial means. The four terminal connection is important of course for low resistances.

A fifth metal binding post labeled **GND** (Ground) is connected to the case and may be used as a guard or shield terminal. It may also be connected using the shorting link to either terminal to implement a 2-terminal as opposed to a 3-terminal measurement.

4.3 Electrical Considerations

In order to make proper use of the full performance capabilities of the HARS-LX unit, especially if low resistance or low resistance increments are important, care must be taken in connecting to the terminals of the decade box.

In particular, to keep contact resistance to a minimum, 4-terminal connections should be employed, and the most substantial and secure connection to the binding posts should be made. They accept banana plugs, telephone tips, spade lugs, alligator clips, and bare wire. The largest or heaviest mating connection should be made, and, where applicable, the binding posts should be securely tightened.

These considerations may be relaxed whenever single milliohms not considered significant for the task being performed.

4.3.1 Thermal emf Considerations

The highest quality low emf components are used in the HARS-LX series. In particular, the terminals are made of gold plated tellurium copper, which exhibits low emf and low resistance. There nevertheless may be some minute thermal emf generated at the user's test leads where they contact the HARS-LX binding posts. This will depend on the test lead material. Whenever this is critical, brass and iron materials should be avoided.

This emf will not manifest itself if an ac measurement instrument is employed. It will also be eliminated if a meter with so called "True Ohm" capability is used. Otherwise it may appear as a false component of the dc resistance measurement, and can be the order of milliohms.

4.4 Dial Setting

The resistance setting may be read directly from the dial settings. For additional flexibility and range, each decade provides a “10” position setting. This “10” position on any one decade equals the “1” position on the next higher decade if any. It adds about 11% to the nominal total decade resistance. The most significant decade also has an “11” position to extend the resistance range to over 1.2 MΩ. The 10 mΩ decade, however, does not go below the “1” position in order to maintain a precise and constant minimum resistance of 10 mΩ, so that no subtraction of zero resistance is required.

To determine the resistance obtained when any one or more “10” or “11” settings are used, simply add 1 to the next higher decade. For example, a setting of “10-11-10-10-10-10” becomes:

11	1	1	0	0	0	0
10	1	0	0	0	0	0
10		1	0	0	0	0
10			1	0	0	0
10				1	0	0
10					1	0
10						1
1						
<u>10</u>						
Total	1	2	1	1	1	1

In order to obtain a zero in the 1 Ω position, set the 1 Ω decade to the “10” position, i.e. 10 Ω, and take the 10 Ω setting, in the next decade, into consideration. To get 2 Ω, for example, the switches should be set to show “1-10”.

Since the highest decade has an additional “11” position, resistance values of over 1.2 times nominal maximum value can be obtained.

4.5 Power Considerations

To maintain the maximum possible accuracy and precision, power applied to the HARS-LX should be kept as low as possible, preferably below 0.1 W. For best protection of the instrument, it is advisable to limit the input power to 1 W. This may be implemented with a series resistor or fuse.

4.6 Environmental Conditions

For optimal accuracy, the decade box should be used in an environment of 23°C. It should be allowed to stabilize at that temperature for at least four hours after any significant temperature variation.

Humidity should be maintained at laboratory conditions of 30% to 70% RH.

4.7 Switch Conditioning

The switch wipers employed in this unit are self cleaning. They have solid silver alloy contacts. After being left idle, the wipers and contacts must be conditioned or “broken in” again to remove the film of silver oxide that develops over time. This is standard metrology practice when high accuracy is required. This effect is of the order of less than 1 mΩ, So it may be ignored whenever measurements of that magnitude are not important.

To perform this “breaking in,” simply rotate each switch seven to ten times in each direction.

4.8 Meter Shunt Applications

To measure the current in a 4-terminal resistor:

1. Measure the voltage drop between the two terminals of the resistor not connected to the current source.
2. Determine the current by the ratio of the measured voltage to the known resistance.

Using the 4-terminal technique helps avoid errors caused by the voltage drops in the current-carrying leads and contacts. Errors caused by lead and contact resistances in the voltage measuring circuit are negligible if the current in this circuit is small.

4.9 Kelvin Bridge Applications

Use 4-terminal resistance standard for all Kelvin bridge measurements. When connected as shown in Figure 4-1, errors caused by lead and contact resistances can be made negligible because they appear as part of the generator or yoke resistance, or in series with high resistance bridge arms.

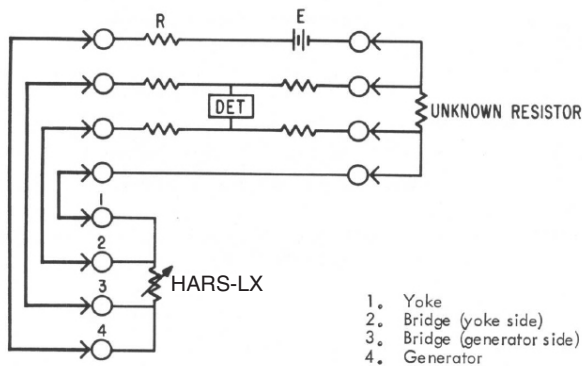

Figure 4-1: Kelvin Bridge Connections

For maximum protection and accuracy, limit power input to HARS-LX to 1 Watt. This may be accomplished by placing a resistor in series with the bridge generator or battery.

The value of this resistance can be calculated from the following formula:

$$R = \frac{E^2}{4}$$

where:

- R = value of the power-limiting resistor
- E = open circuit voltage of the generator

The protective resistor should have a power rating of 4 W or more. Input power should be limited to 1/10 W or less for most accurate measurements.

4.10 Rheostat Operation (-RH Option)

For high-resolution applications, an optional rheostat may be used. The rheostat provides up to 10 mΩ of resistance in 0.1 mΩ steps. To get the rheostat reading in milliohms, multiply the dial setting by 0.1. See Figure 4-1.

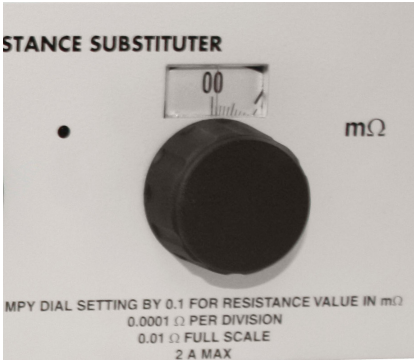

Figure 4-1: Rheostat Dial

In order to eliminate contact resistance and thermal emf, the HARS-LX integrates the rheostat as shown in Figure 4-2. This way, the wiper is in the low potential circuit, which is the high impedance lead. As a result, voltage and contact resistance effects are removed by being effectively added to the input impedance of the measuring instrument.

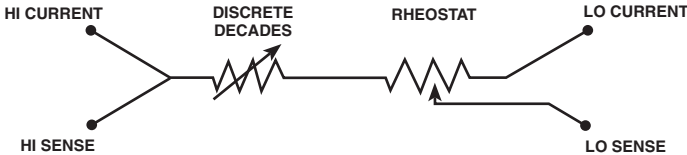

Figure 4-2: Rheostat Schematic

Chapter 5

MAINTENANCE

5.1 Maintainability and Reliability

It is possible to maintain Model HARS-LX indefinitely. It is reliable due to its closed design and sealed switches and resistors. It is possible to adjust the unit, if necessary, because it has adjustable decades for 1 Ω decades and above and resistance wire for lower decades which can be trimmed. The unit is resistant to electromagnetic interference (EMI) because of its metal enclosure.

5.2 Preventive Maintenance

Keep the unit in a clean environment. This will help prevent possible contamination.

The Model HARS-LX is packaged in a closed case and uses completely sealed switches. This limits the entry of contaminants and dust to the inside of the switches. If it is maintained in a clean or air-conditioned environment, cleaning will seldom be required.

Should cleaning be needed:

1. Remove the 4 housing screws from the side of the instrument, and remove the housing.
2. Remove any dust or debris using optical grade dry compressed air or a clean brush.
3. Replace the housing and reattach the 4 housing screws.

The front panel should be periodically cleaned to eliminate any leakage paths from near or around the binding posts. To clean the front panel:

Wipe the front panel clean using alcohol and a lint-free cloth.

5.3 Calibration

The Model HARS-LX may be employed as a stand-alone instrument or as an integral component of a system. If used as part of a system, it should be calibrated as part of the overall system to provide an optimum system calibration.

If the HARS-LX is employed as a stand alone device, the following should be observed:

- Calibration Interval
- General Considerations
- Required Equipment
- Calibration Procedure

5.3.1 Calibration Interval

The recommended HARS-LX Series calibration interval is twelve (12) months.

If the instrument is used to transfer resistance values only, recalibration is not required, assuming that there has been no drastic change in the deviations of any individual resistors.

5.3.2 General Considerations

Before starting the calibration procedure, you need to consider the following:

- Calibration environment should be 23°C and less than 50% relative humidity.
- Test instruments should be sufficiently more accurate than the HARS-LX unit, and/or the uncertainty of the measurement instrumentation has to be considered in the calibration Test Uncertainty Ratio (TUR).
- The testing equipment and the HARS-LX unit should stabilize at laboratory conditions for at least 24 hours.
- Kelvin type 4-wire test leads should be used to obtain accurate low resistance measurements.
- Steps should be taken to minimize thermal emf effects, such as using a meter with “True Ohm” capacity.
- Accepted metrology practices should be followed.

5.3.3 Required Equipment

Many combinations of standards, transfer standards, meters, and bridges may be used to calibrate this instrument. The following are some possible choices:

- Resistance Standards or Transfer Standards for 1 Ω, 10 Ω, 100 Ω, 1 kΩ, 10 kΩ, 100 kΩ, 1 MΩ, and 10 MΩ per step, calibrated to ±10 ppm. IET options include the following models:
 - HATS-LR
 - HATS-Y
 - SRL Series

The 1 Ω, and 10 Ω transfer standards are optional, and are only used to take advantage, if desired, of the adjustability of these two decades
- Precision resistance measurement bridge or multimeter, with a transfer accuracy of ±1 ppm. Options include:
 - Guildline Model 9975
 - Measurements International Model 6000A

- ESI model 242, 242A, 242C, or 242D
- A high-precision, high-stability digital multimeter (e.g. Fluke 8508A) along with a set of resistance standards for ratio mode.

5.3.4 Calibration Procedure

To calibrate the HARS-LX unit, proceed as follows:

1. Set up the calibration equipment in the resistance measurement mode and exercise the switches 10 times in each direction.
2. Allow the switches to cool for 15 minutes.
3. Confirm the minimum resistance of the unit.
Allow a confidence band for the uncertainty of the measuring instrument and setup.
4. Determine the allowable upper and lower limits for each resistance setting of each decade based on the specified accuracy and the confidence band.
*For the HARS-LX series, the limits for any resistance “R” are:
[R±(20 x 10⁻⁶R + 0.0005Ω)].*
5. Confirm that the resistances fall within these limits.
6. If any resistances fall outside these limits, the associated switch assembly may require service or replacement.

5.4 Adjustments

If one or more resistances fall outside the limits, the associated resistor should be adjusted. There is a trimming network provided for each resistance in these ranges. These may be accessed by removing the housing and accessing the particular decade PC board.

Adjust the resistors from lowest to highest. The order of decades does not matter.

Whereas it is possible to adjust any one resistance step, note that the n^{th} step of a decade is the sum of resistances 1 through n , so that errors are cumulative. It is therefore recommended that whenever any resistance of a particular decade is adjusted, that all the resistances of that decade be tested and adjusted as required.

To adjust any of the resistances, the following should be observed:

- Adjustment considerations
- Adjustment procedure

5.4.1 Adjustment Considerations

Before adjusting or trimming any resistances, observe the following:

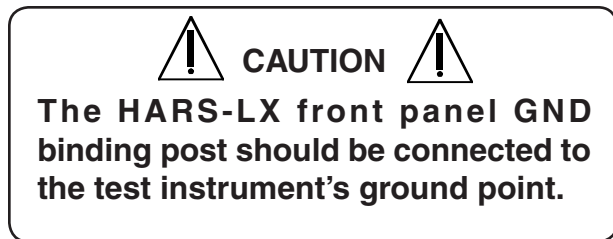

The equipment measuring the unit should conform to the guidelines provided in Section 5.3.

5.4.2 Adjustment/Trimming Procedure

To trim or adjust any resistances, **proceed as follows:**

1. Stabilize HARS-LX at laboratory temperature of 23 °C for at least 8 hours.
2. Remove the 4 housing screws from the sides of the instrument and remove the housing.
3. Using the binding posts in the 4-terminal connection, connect HARS-LX to a resistance meter.
4. Rotate all knobs approximately 10 times and be careful not to rotate the minimum setting decade beyond the stops.

Breaking in the switches helps eliminate any residual contact corrosion resistance.

5. Set all dials to 0, except for the minimum setting decade.

The minimum setting decade has a minimum stop at position 1.

6. Measure the minimum resistance setting
If an adjustment is needed, consult IET technical support.

7. Measure 1 mΩ, 10 mΩ, and 100 mΩ steps as applicable to the HARS-LX being trimmed.

If adjustment is needed, proceed as follows:

- If the resistance is **high**, reduce it by adding a small bit of solder to an exposed portion of the wire
- If the resistance is **low**, increase it by gently filing the wire in one spot.

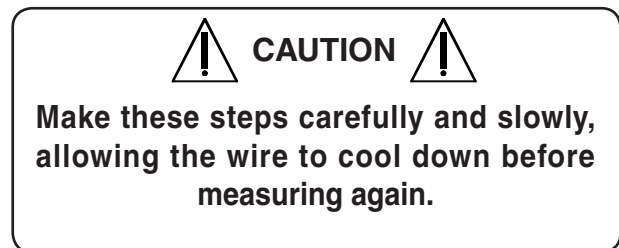

8. Measure the higher decades. If an adjustment is needed, proceed as follows:

Starting with the lowest setting, adjust the associated trim pots.

See Table 5-1 and Figure 5-1 for reference

9. Replace the housing and reinstall the 4 housing screws.

Switch Position	Potentiometer Designation All decades but 1 kΩ	Potentiometer Designation 1 kΩ decade
1	T0	T1
2	T1	T2
3	T2	T3
4	T3	T4
5	T4	T5
6	T5	T6
7	T6	T7
8	T7	T8
9	T8	T9
10	T9	T10
11	T10 (1 M steps only)	

Table 5-1: Trimming Potentiometers

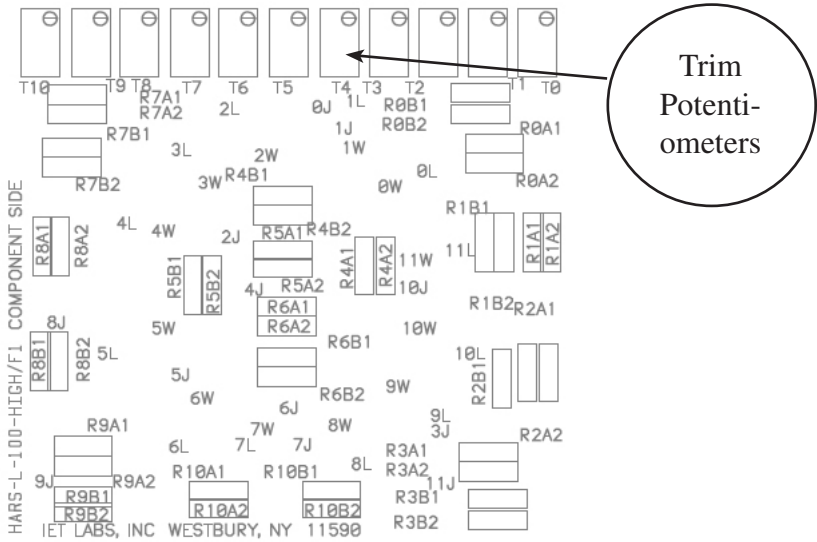

Figure 5-1: Typical Trimmer Board

5.5 Replaceable Parts List

Model Ref	IET Pt No	Description
1	BP-1000-RD	Binding Post, Red
2	BP-1000-BK	Binding Post, Black
3	BP-1000-GN	Binding Post, Green
4	HARS-LX-4300-KNB	Knob Assembly
5	RS-925D-RH	Rheostat Assembly
Not Shown	HARS-LX-3100	Foot
Not Shown	HARS-4000-LX-.001	1 m Ω /step Decade Switch Assembly
Not Shown	HARS-4000-LX-0.01	10 m Ω /step Decade Switch Assembly
Not Shown	HARS-4000-LX-0.1	100 m Ω /step Decade Switch Assembly
Not Shown	HARS-4000-LX-1	1 Ω /step Decade Switch Assembly
Not Shown	HARS-4000-LX-10	10 Ω /step Decade Switch Assembly
Not Shown	HARS-4000-LX-100	100 Ω /step Decade Switch Assembly
Not Shown	HARS-4000-LX-1k	1 k Ω /step Decade Switch Assembly
Not Shown	HARS-4000-LX-10k	10 k Ω /step Decade Switch Assembly
Not Shown	HARS-4000-LX-100k	100 k Ω /step Decade Switch Assembly
Not Shown	HARS-4000-LX-1M	1 M Ω /step Decade Switch Assembly
Not Shown	HARS-4000-LX-10M	10 M Ω /step Decade Switch Assembly

Table 5-2: Replaceable Parts List



Figure 5-2: HARS-LX Replaceable Parts

