



X-ray detectors

Contents

1. Si photodiodes

p.02

2. Si photodiode arrays

p.04

- 2-1 Features
- 2-2 Structure
- 2-3 Applications

3. Photodiode arrays with amplifiers

p.06

- 3-1 Features
- 3-2 Structure
- 3-3 Operating principle
- 3-4 Characteristics
- 3-5 How to use

4. CCD area image sensors

p.08

- 4-1 Direct CCD area image sensors
- 4-2 CCD area image sensors with scintillator
- 4-3 How to use
- 4-4 Applications

5. CMOS area image sensors

p.13

- 5-1 Features and structure
- 5-2 How to use
- 5-3 Applications

6. Flat panel sensors

p.16

- 6-1 Features
- 6-2 Structure
- 6-3 Operating principle
- 6-4 Characteristics
- 6-5 How to use
- 6-6 Applications

X-rays were first discovered by Dr. W. Roentgen in Germany in 1895 and have currently been utilized in a wide range of fields including physics, industry, and medical diagnosis. Detectors for X-ray applications span a broad range including a-Si detectors, single crystal detectors, and compound detectors. There are many kinds of detectors made especially of Si single crystals. For X-ray detectors, Hamamatsu offers Si photodiodes, Si APDs, CCD area image sensors, and CMOS area image sensors, flat panel sensors, etc. Applications of our X-ray detectors include dental X-ray imaging and X-ray CT (computer tomography) in medical equipment fields, as well as non-destructive inspection of luggage, foods, and industrial products; physics experiments; and the like.

In the low energy X-ray region called the soft X-ray region from a few hundred eV to about 20 keV, direct detectors such as Si PIN photodiodes, Si APDs, and CCD area image sensors are utilized. These detectors provide high detection efficiency and high energy resolution, and so are used in X-ray analysis, X-ray astronomical observation, physics experiments, etc.

The hard X-ray region with energy higher than soft X-rays is utilized in industrial and medical equipment because of high penetration efficiency through objects. Scintillator detectors are widely used in these applications. These detectors use scintillators to convert X-rays into visible light and detect this visible light to detect X-rays indirectly. Especially in the medical field, the digital X-ray method, which uses X-ray detectors with large photosensitive area, is becoming mainstream, replacing the conventional film-based method. In non-destructive inspection, dual energy imaging, which allows image capturing with deep tones by simultaneously detecting high- and low-energy X-rays, is becoming popular.

Hamamatsu X-ray detectors

Type		Features
Si photodiode		<ul style="list-style-type: none"> Products combined with CsI(Tl) or ceramic scintillator are available. Back-illuminated CSP photodiodes that can be tiled (two-dimensional array) are available.
Si photodiode array		<ul style="list-style-type: none"> A long, narrow image sensor can be configured by arranging multiple arrays in a row. Supports dual energy imaging
Image sensor	Photodiode array with amplifier	<ul style="list-style-type: none"> Allows configuring a long, narrow image sensor by use of multiple arrays
	CCD area image sensor	<ul style="list-style-type: none"> Coupling of FOS to FFT-CCD (CCD with scintillator) Front-illuminated CCD for direct X-ray detection are available.
	CMOS area image sensor	<ul style="list-style-type: none"> Coupling of FOS to CMOS image sensor
	Flat panel sensor	<ul style="list-style-type: none"> For large-area two-dimensional imaging Captures distortion-free, high-detail digital images in real time

Example of detectable photon energy and spectral response range

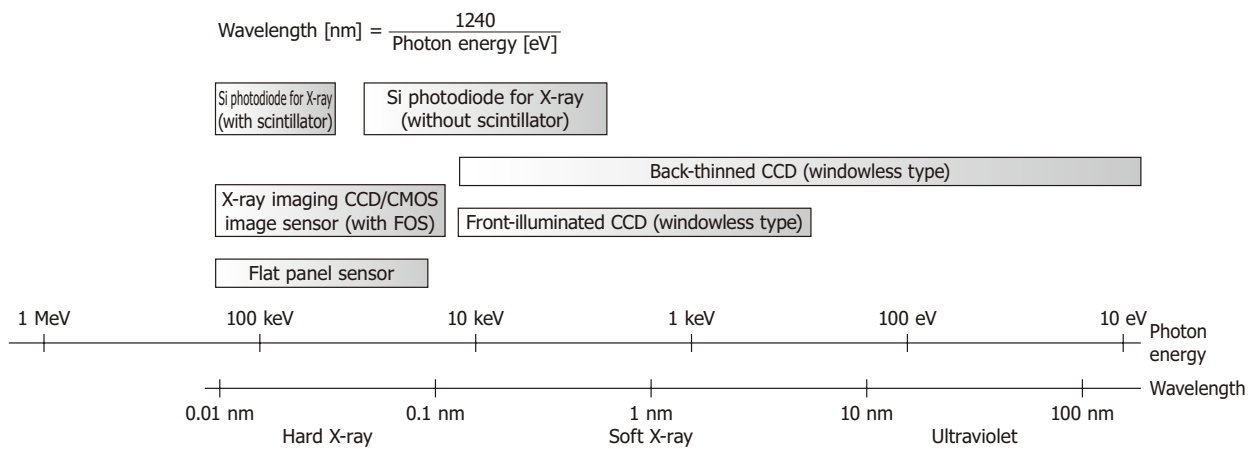

KMPDC0178EC

1. Si photodiodes

When used for X-ray detection, Si photodiodes are typically used with scintillators to form detectors for scintillator coupling. Hamamatsu offers two types of Si photodiodes for X-ray detection: Si photodiodes with scintillators and Si photodiodes without scintillators (which assume that users will bond the appropriate scintillators). In either case, Si photodiodes have a spectral response matching the emission band of scintillators.

Structure

Si photodiodes with scintillator

In the case of Si photodiodes with scintillators, CsI(Tl) scintillators or GOS ceramic scintillators are coupled with the Si photodiodes. The area around the scintillator is coated with a reflector to prevent the light emitted from the scintillator from escaping outside the photosensitive area [Figure 1-1].

[Figure 1-1] Si photodiode with scintillator

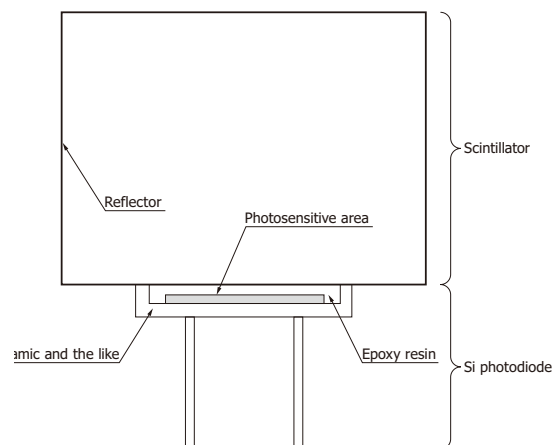

KSPDC0003ED

Back-illuminated Si photodiodes have the PN junction on the side opposite to (on the backside of) the light incident surface [Figure 1-2 (b)]. The photodiode surface bonded to the scintillator is flat and does not have wires. This prevents the photodiode from damage when the user attaches the scintillator. In addition, the detector can be made small because there is no area for wires as in a front-illuminated type. Furthermore, multiple photodiodes can be arranged with little dead space, so they can be used as a large-area X-ray detector.

[Figure 1-2] Examples of Si photodiodes combined with scintillator

(a) Front-illuminated Si photodiode

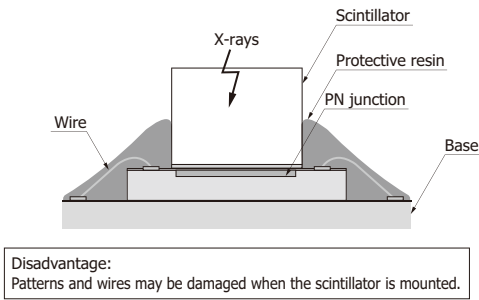

(b) Back-illuminated Si photodiode

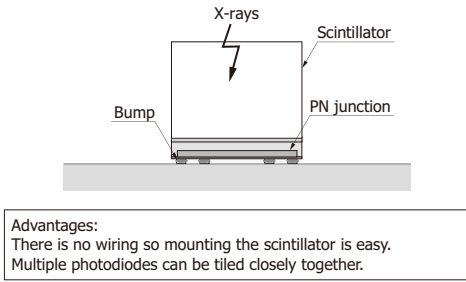

KPDC0037EA

Si direct photodiodes

Because X-rays have no electric charge, they do not directly create electron-hole pairs in a silicon crystal. However, the interaction of silicon atoms with X-rays causes the release from ground state of electrons whose energy equals that lost by irradiated X-rays. The Coulomb interaction of these electrons causes electron-hole pairs to be generated, and these pairs are captured to detect X-rays. The probability that X-rays will interact with silicon atoms is therefore a critical factor when detecting X-rays directly.

Si direct photodiodes can effectively detect X-rays at energy levels of 50 keV or less. Detection of X-rays less than 50 keV is dominated by the photoelectric effect that converts the X-ray energy into electron energy, so all energy of X-ray particles can then be detected by capturing the generated electrons with the Si photodiode.

Detection of X-rays and gamma-rays from 50 keV up to 5 MeV is dominated by the Compton scattering, and part of the X-ray and gamma-ray energy is transformed into electron energy. In this case, the probability that the attenuated X-rays and gamma-rays will further interact with silicon (by photoelectric effect and Compton scattering) also affects the detection probability, making the phenomenon more complicated.

Figure 1-3 shows the probabilities (dotted lines) of photoelectric effect and Compton scattering that may occur in a silicon substrate that is 200 μm thick, and the total interaction probabilities (solid lines) of silicon substrates that are 200 μm, 300 μm and 500 μm thick.

As can be seen from the figure, photodiodes created

with a thicker Si substrate provide higher detection probability. With a 500 μm thick Si substrate, the detection probability is nearly 100% at 10 keV, but falls to just a few percent at 100 keV. The approximate range of electrons inside a Si direct photodiode is 1 μm at 10 keV and 60 μm at 100 keV.

[Figure 1-3] Detection probabilities of Si direct photodiodes

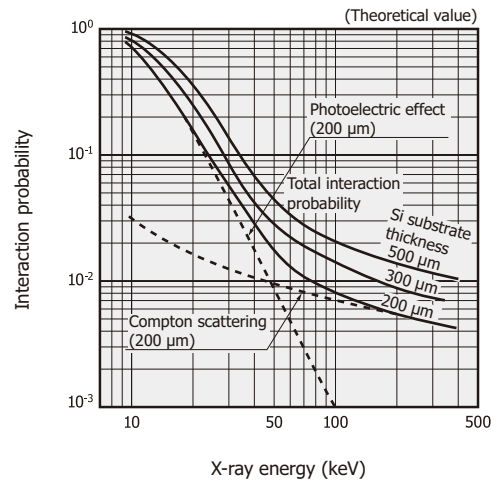

KSPD80018EA

2. Si photodiode arrays

Baggage inspection equipment for examining the shapes and materials of items in baggage are used in airports and other facilities. Recently, high-accuracy CT baggage inspection equipment are being developed. Hamamatsu Si photodiode arrays with scintillators are widely used in these types of baggage inspection equipment. X-rays directed at baggage pass through objects and are converted into light by a scintillator. Then, the converted light is detected by the Si photodiode array. Hamamatsu Si photodiode arrays for baggage inspection feature low noise and consistent sensitivity and other characteristics between individual elements. The photodiode chips are mounted with high accuracy allowing highly accurate detection. Moreover, their sensitivity range matches the emission wavelength of scintillators making them suitable for baggage inspection.

[Figure 2-1] Imaging example of baggage inspection equipment



2-1 Features

▶ Low cost

The adoption of a back-illuminated structure simplifies scintillator mounting and other processes, and this leads to shorter manufacturing process. Moreover, back-illuminated Si photodiode arrays use bumps for their electrodes. Bumps are used in the

manufacturing process of LCD monitors and the like and are suitable for high-volume production. The use of bumps has cut cost when compared with our previous products.

▶ Robustness

Through the adoption of a back-illuminated structure, the photodiode array's output terminals are connected to the circuit board electrodes using bumps without wires. Robustness is achieved by running the circuit wiring inside the board.

▶ High reliability

Since back-illuminated Si photodiode arrays do not have patterns or wires on the surface that scintillators are mounted on, scintillators can be mounted to the photodiode arrays without damaging the patterns and wires. High reliability is achieved since there are no wires, which could break due to temperature changes or be adversely affected in other ways.

▶ Superior sensitivity uniformity

In back-illuminated Si photodiode arrays (S11212/S11299 series), nonuniformity in sensitivity between elements are minimized, and the sensitivity variations at the sensor's end elements are suppressed.

[Figure 2-2] Sensitivity uniformity (S11212/S11299 series)

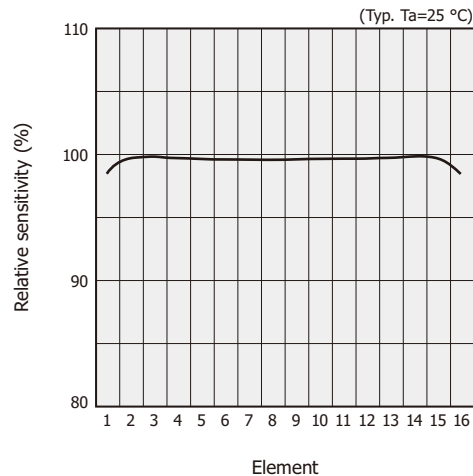

KPD80023EC

[Table 2-1] Scintillator comparison table

Parameter	Condition	CsI(Tl)	GOS ceramic	Unit
Peak emission wavelength		560	512	nm
X-ray absorption coefficient	100 keV	10	7	-
Refractive index	At peak emission wavelength	1.74	2.2	-
Decay constant		1	3	μs
Afterglow	100 ms after X-ray turn off	0.3	0.01	%
Density		4.51	7.34	g/cm ³
Color tone		Transparent	Light yellow-green	-
Sensitivity variation		±10	±5	%

► Allows tiling

Back-illuminated Si photodiodes do not have space for wires as shown in Figure 1-2 (b), so multiple photodiodes can be tiled close together.

[Figure 2-3] Tiling example (S13620-02)

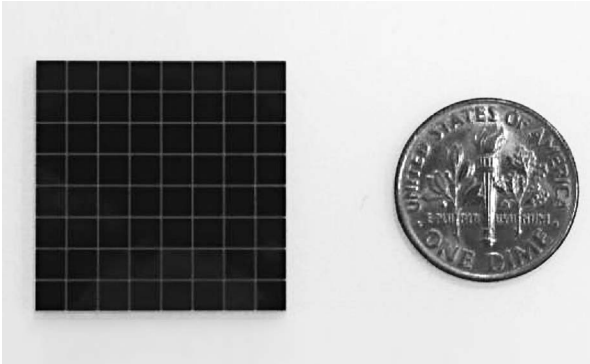

2 - 2 Structure

Many of the Hamamatsu Si photodiode arrays for baggage inspection equipment employ back-illuminated structure. Since back-illuminated Si photodiode arrays do not have patterns or wires on the surface that scintillators are bonded to, damage to patterns and wires when mounting scintillators can be avoided. Figure 1-2 shows cross sections for when a front-illuminated photodiode is combined with a scintillator and for when a back-illuminated photodiode is combined with a scintillator. Examples of scintillators include CsI(Tl) and GOS ceramic. GOS ceramic features small variations in light emission and high reliability. We do not recommend CWO scintillators since they contain cadmium which falls under environmental management substances (CWO scintillator available).

[Figure 2-4] Spectral response of Si photodiode arrays and emission spectrum of scintillators

(a) S11212-121

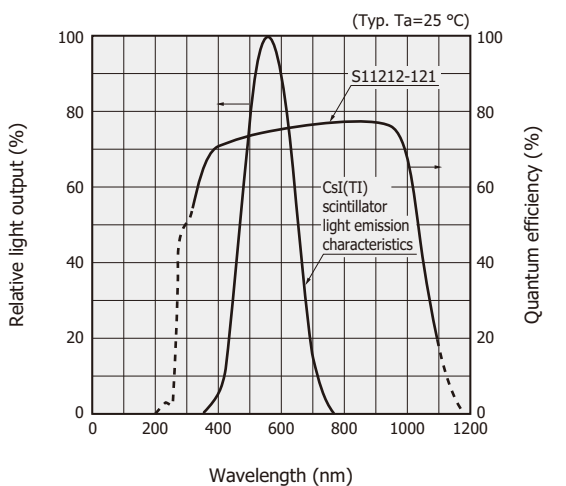

KSPD80330EB

(b) S11212-321

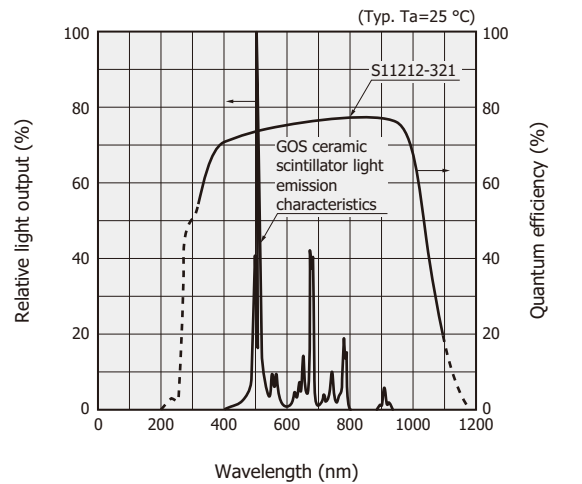

KSPD80331EB

2 - 3 Applications

» Dual energy imaging

In normal X-ray non-destructive inspection, the X-ray transmitted through an object is detected by a single type of sensor, and the shape, density, and other characteristics of the object is made into an image using shading. In comparison, in dual energy imaging, high-energy image and low-energy image are captured simultaneously by two types of sensors, and the images are combined through arithmetic processing. This enables images that show detailed information about hard and soft objects to be obtained. Dual energy imaging is used in a wide range of fields such as security where specific chemicals, explosives, and other dangerous objects are detected and in the field of grain, fruit, meat, and other inspections.

Hamamatsu back-illuminated Si photodiode arrays S11212/S11299 series support dual energy imaging. It is structured so that two types of Si photodiode arrays with scintillators can be combined to create top and bottom layers in order to simultaneously detect high-energy and low-energy X-rays. Moreover, its construction allows multiple arrays to be arranged in close proximity to form a line sensor. This makes measurement of long and narrow objects possible.

[Figure 2-5] Dual energy imaging

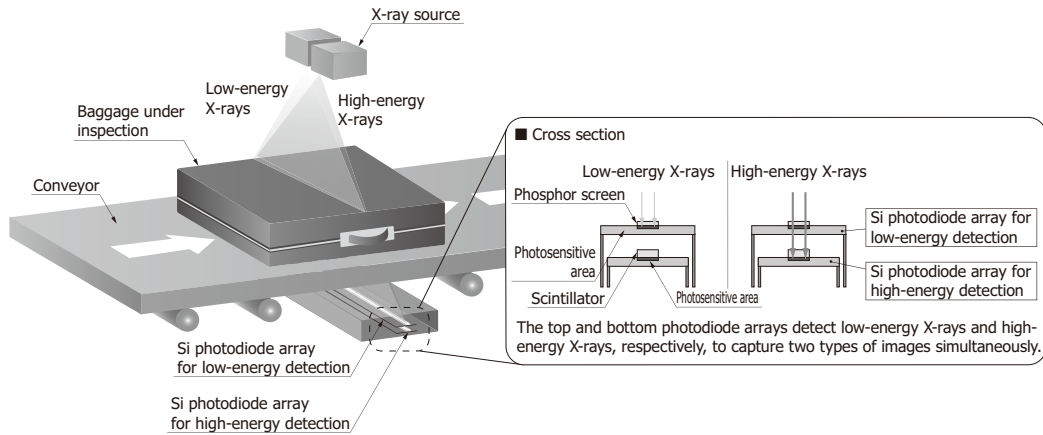

KPDC0038EA

[Figure 2-6] Example of combining back-illuminated Si photodiode arrays [S11212-421 (top) and S11299-121 (bottom)]

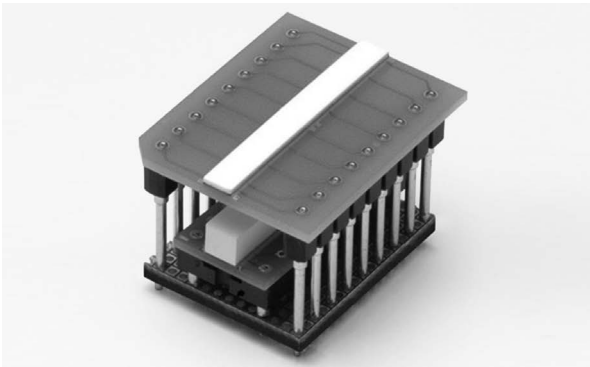

[Figure 2-7] Multiple arrangement example (S11212-121)

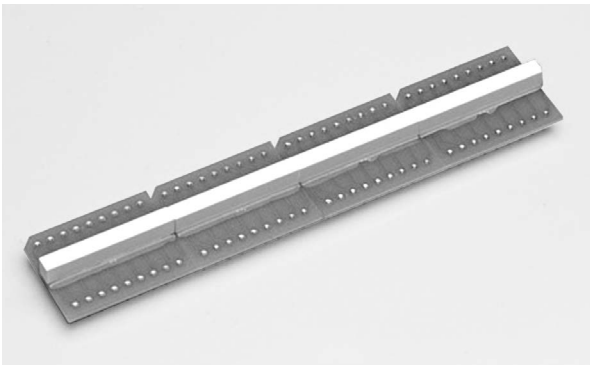

3. Photodiode arrays with amplifiers

Photodiode arrays with amplifiers are sensors suitable for long and narrow area detection systems using an equal-magnification optical system. They consist of a Si photodiode array and CMOS signal processing IC, making the external circuit configuration simple. A long and narrow sensor for X-ray detection can be configured by arranging multiple photodiode arrays with amplifiers, which phosphor sheet has been attached to.

3 - 1 Features

- ▶ Long and narrow sensor can be configured by placement of multiple devices.
- ▶ 5 V operation
- ▶ Simultaneous integration by charge amplifier
- ▶ Time-series signal readout by shift register (data rate: 1 MHz max.)
- ▶ Low dark current due to zero-bias photodiode operation
- ▶ Internal clamp circuit achieves low noise and wide dynamic range.
- ▶ Internal timing generator allows operation with two types of input pulses (reset and clock).
- ▶ Customization of photodiodes, substrates, connectors, and phosphor sheet is available.

3 - 2 Structure

Photodiode arrays with amplifier consist of a Si photodiode array chip of a photosensitive area, a CMOS signal processing IC chip, and a board [Figure 3-1].

[Table 3-1] Hamamatsu photodiode arrays with amplifiers

Type no.	Element height (mm)	Element pitch (mm)	Number of elements	Line rate (lines/s)
S11865-64G	0.8	0.8	64	14678
S11865-128G	0.6	0.4	128	7568
S11866-64G-02	1.6	1.6	64	14678
S11866-128G-02	0.8	0.8	128	7568

[Figure 3-1] Structure diagram (S11865 series)

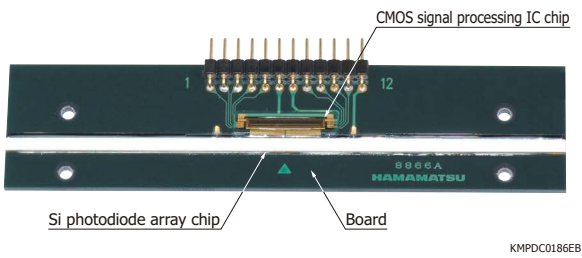

Signals from 64 elements or 128 elements at a time are processed by the CMOS signal processing IC. This makes the system configuration very simple compared to methods that connect each element on the photodiode array to an external signal processing circuit. When X-rays irradiate a sensor with a phosphor sheet, the phosphor sheet converts the X-rays into visible light which is then detected by the sensor.

3-3 Operating principle

The CMOS signal processing IC chip consists of a timing generator, shift register, hold circuit, and charge amplifier array [Figure 3-2]. Each element of the photodiode array is connected by wire bonding to the charge amplifier in the CMOS signal processing IC chip. The light-generated charge (Q_{out}) in a photodiode, which is expressed by the product of the photocurrent (I_L) and the integration time (T_s), is converted into an output voltage ($V_{out} = Q_{out}/C_f$) by the charge amplifier feedback capacitance (C_f). The output signal, which is sent to the hold circuit before the charge amplifier is reset, is read out by the shift register as time-series voltage signals. In the S11865/

S11866 series, signals from all elements are read out by the simultaneous integration method. The S11865/S11866 series also have a shutter function capable of adjusting the integration time. The video data rate is 1 MHz maximum.

[Figure 3-2] Block diagram (S11865/S11866 series)

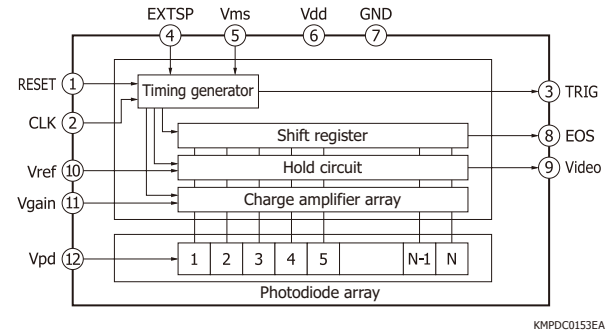

3-4 Characteristics

Figure 3-3 shows the spectral response of the S11865/S11866 series. When the phosphor sheet is attached with resin, the spectral response becomes smooth.

[Figure 3-3] Spectral response (S11865/S11866 series, typical example)

(a) Without phosphor screen

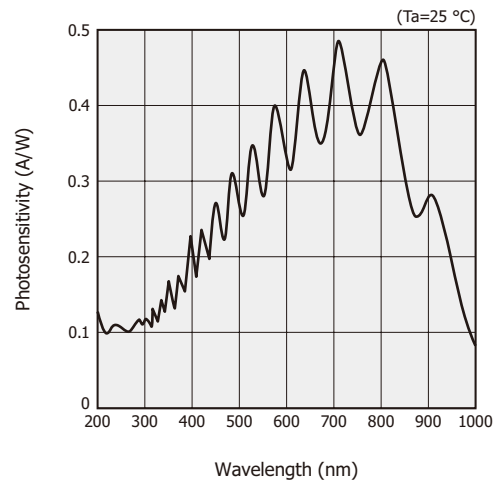

[Figure 3-4] Timing chart (S11865/S11866 series)

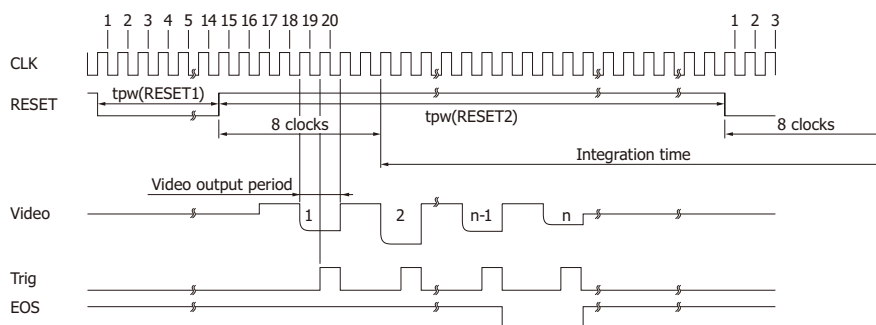

(b) With phosphor screen

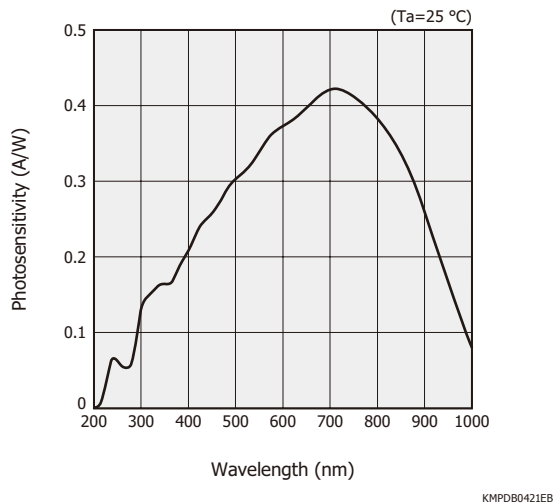

3 - 5 How to use

The S11865/S11866 series are designed so that the effective area length equals the board length. This allows easily configuring a long and narrow, one-dimensional detector system by arranging multiple sensors in a row. This type of system is difficult to create with normal image sensors. When multiple sensors are arrayed, the output signal from each sensor can be read out in parallel using multiple external circuits or read out serially using a single circuit. To read out signals serially, set the external voltage so that the preceding-stage end-of-scan signal is used as the next-stage start signal.

[Figure 3-5] Long and narrow image sensor consisting of multiple photodiode arrays with amplifiers



4. CCD area image sensors

4 - 1 Direct CCD area image sensors

The direct CCD area image sensor can efficiently detect X-rays of 30 keV or lower.

Windowless CCDs (front-illuminated type) are used for directly detecting X-rays from 0.5 keV to 10 keV. These CCDs cannot be used to detect X-rays whose energy is lower than 0.5 keV since an absorption layer exists on the CCD surface. A direct CCD (back-thinned type) must be used to detect X-rays whose energy is lower than 0.5 keV.

To achieve high quantum efficiency in the energy region higher than 10 keV, a direct CCD with a thick depletion layer must be used.

Direct CCDs are capable of both X-ray imaging and spectrophotometry. X-rays can also be detected in photon-counting mode (method for counting individual photons one by one). Direct CCDs are used in fields such as X-ray astronomy, plasma analysis, and crystal analysis.

» Principle of X-ray direct detection

Photons at an energy higher than a specified level generate electron-hole pairs when they enter a CCD. If the photon energy is small as in the case of visible light, only one electron-hole pair is generated by one photon. In the vacuum-UV-ray and soft-X-ray regions where photon energy is greater than 5 eV, multiple electron-hole pairs are generated by one photon. The average energy required for silicon to produce one electron-hole pair is approx. 3.6 eV. So an incident photon at 5.9 keV ($K\alpha$ of manganese), for example, generates 1620 electron-hole pairs in the CCD.

The number of electrons generated by direct X-ray detection is proportional to the energy of the incident photons.

» Characteristics

Figure 4-1 shows the result when X-rays ($Mn-K\alpha/K\beta$) emitted from a Fe-55 radiation source are detected by a CCD. Spectrum resolution is usually evaluated by using the FWHM (full width at half maximum). The Fano limit (theoretical limit of energy resolution) of Si detectors for Fe-55 is 109 eV.

Major factors that degrade energy resolution are CCD charge transfer efficiency and CCD noise including dark current. When a CCD is sufficiently cooled down and is operated at a charge transfer inefficiency of 1×10^{-5} or less, the energy resolution is determined by the readout noise. To improve energy resolution, the CCD

readout noise has to be less than 5 e⁻ rms. The energy resolution of optimally adjusted Hamamatsu CCDs is below 140 eV for Fe-55.

There are two modes for evaluating the CCD quantum efficiency in the X-ray region. One is the photon-counting mode, and the other is the flux mode that integrates all photons. The quantum efficiency in the visible region is usually evaluated in the flux mode [Figure 4-2].

[Figure 4-1] CCD energy resolution in X-ray (Mn-K α /K β) detection (typical example)

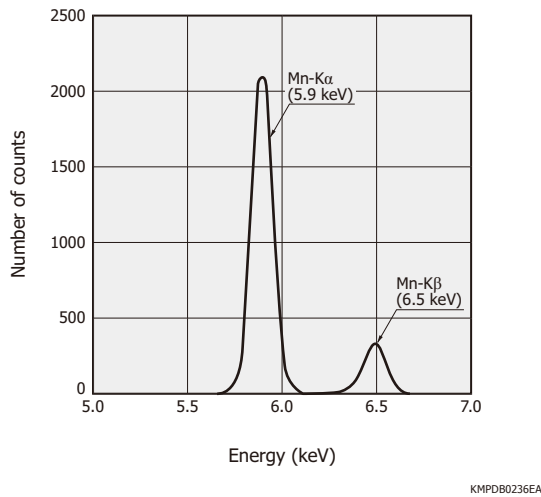

[Figure 4-2] Quantum efficiency vs. photon energy

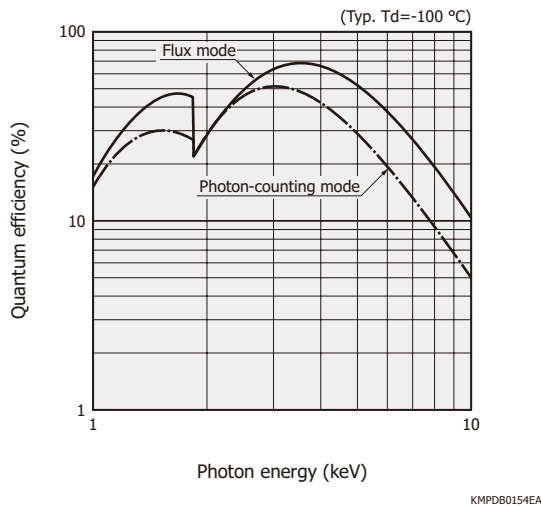

4 - 2 CCD area image sensors with scintillator

Besides visible, infrared, and ultraviolet light, a CCD can directly detect and image X-rays below 30 keV. However, in the X-ray region from several dozen to more than 100 keV used for medical diagnosis and industrial non-destructive inspection, scintillators are needed to convert the X-rays into visible light. In this case, CsI(Tl) and GOS scintillators are generally used, which convert X-rays into light at a peak of around 550 nm. The CCD then detects this light for X-ray detection.

In X-ray imaging applications requiring large-area detectors, Hamamatsu provides front-illuminated CCD coupled to an FOS (fiber optic plate with scintillator). We also respond to requests for CCD coupled to an FOP (fiber optic plate) (scintillator to be implemented by the user).

» Features

► Highly detailed images

High sensitivity and low noise are achieved by use of FFT (full frame transfer) type CCD, which is widely used for analysis and measurement.

» Structure and characteristics

⚙️ CCD area image sensors with FOS

This CCD is coupled to an FOS which is an FOP with scintillator. This CCD with FOS utilizes CsI(Tl) as the scintillator to achieve high resolution.

[Figure 4-3] Structure of CCD with FOS

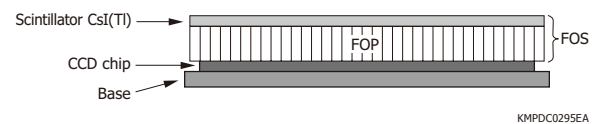

Typically, CCD chips are damaged to some extent when exposed to X-rays. However, this CCD with FOS has an FOP on the CCD chip's photosensitive area, and the FOP also serves as an X-ray shield to suppress damage by X-rays. Electric charges generated by X-rays incident near the surface of the CCD may cause noise, where white spots are seen at random positions. It degrades the image quality. This CCD with FOS, however, maintains high-quality images since the amount of X-rays incident on the CCD is small due to the X-ray shielding effect of the FOP [Figure 4-4].

[Figure 4-4] X-ray transmittance in FOP

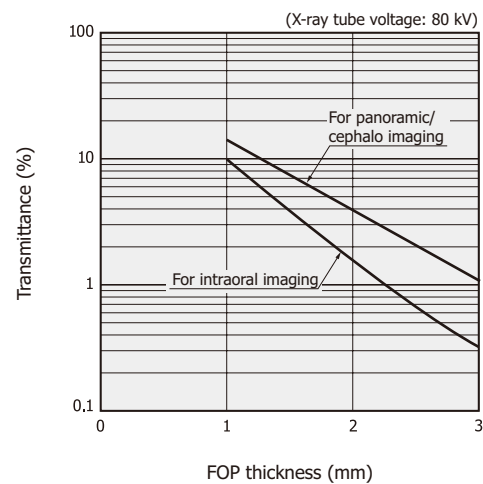

[Figure 4-5] CsI(Tl) absorption coefficient

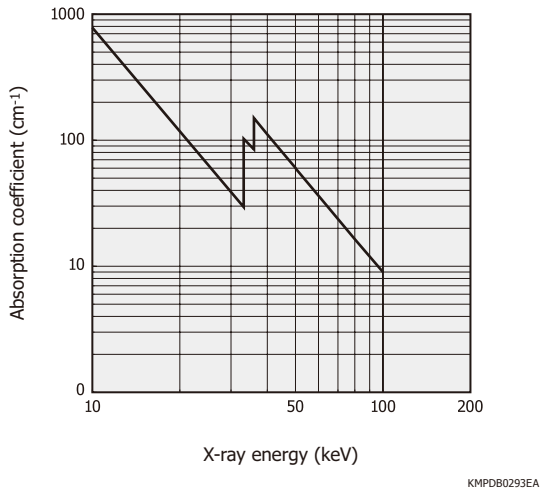

The resolution of a CCD with FOS is mainly determined by the following factors:

- Pixel size
- Scintillator specifications (material, thickness)
- Gap between CCD chip and FOP (e.g., chip flatness)

Due to the CCD structure, the resolution determined by the pixel size cannot be exceeded.

The thicker scintillator results in higher emission intensity, yet the resolution deteriorates as the thickness increases (there is a trade-off here between emission intensity and resolution) [Figure 4-6, 4-7]. Since the resolution deteriorates as the gap between the chip and FOP becomes wider, technology for keeping this gap at a narrow width is essential. Note that the FOP flatness is superior to the chip flatness and so poses no problems.

[Figure 4-6] CsI(Tl) resolution

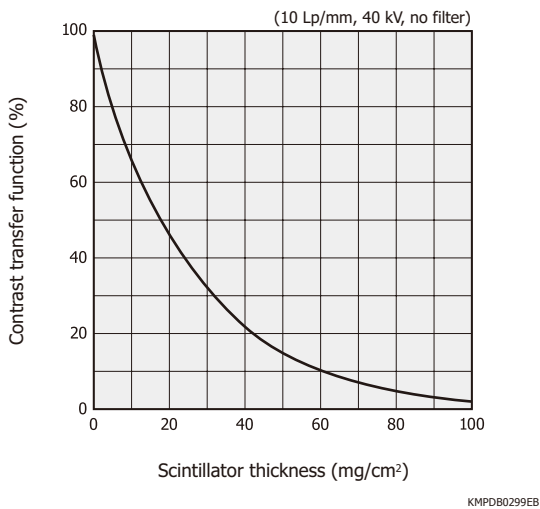

[Figure 4-7] CsI(Tl) emission intensity

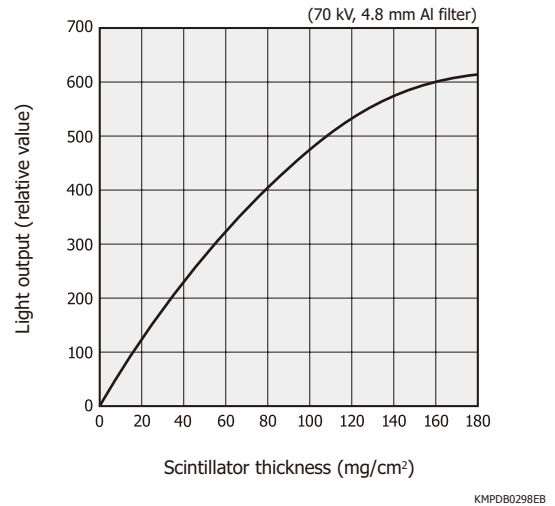

⚙️ Buttable configuration

To obtain a long photosensitive area, panoramic imaging CCDs use two chips and cephalo imaging CCDs use three chips, with each chip being arranged in close proximity in a buttable configuration. There is a dead space between each chip. See Figure 4-8 for an example of an insensitive area caused by this dead space.

4 - 3 How to use

There are two methods for capturing X-ray images: one-shot and TDI operation imaging.

For one-shot imaging, in the CCD pixels, charges are constantly generated due to dark current, so those charges must be constantly drained when no X-rays are being input (standby state). When using TDI operation, the pixel transfer speed has to be made to match the motion speed of the object (see “CCD image sensors technical note | 1. Structure, operating principle | 1-11 TDI-CCD”).

» Image correction

CCDs may sometimes have pixel defects known as white spots where the dark current is large, and black spots where the output is low (low sensitivity). Scintillator and FOP performance also affect the image quality of CCDs with FOS. To achieve high image quality, we recommend using software to compensate for the dark current and sensitivity. See “CCD image sensors technical note | 3. How to use | 3-7 Correction” for information on compensating for pixel defects, dark current, and sensitivity.

Multiple CCD chips are combined in CCDs for panoramic/cephalo imaging and non-destructive inspection, and there is a dead space between each chip. Software compensation may help suppress effects from this dead space.

[Figure 4-8] Example of CCD for cephalo imaging and non-destructive inspection (S8658-01)

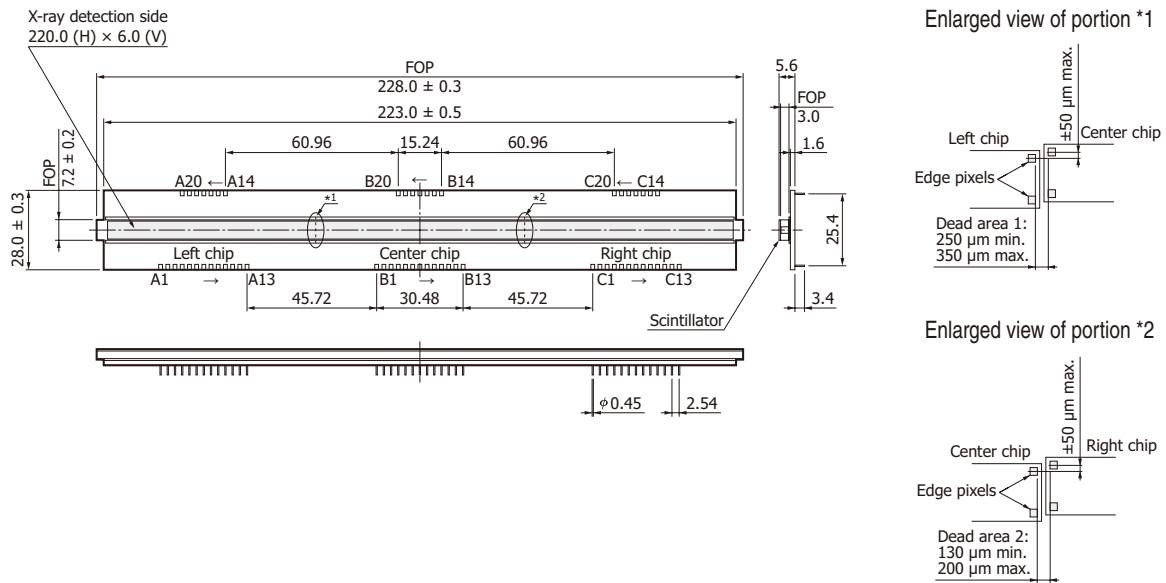

KMPDA0251EA

» Precautions

Take the following precautions when using an X-ray CCD.

(1) Anti-static and surge measures

For measures to avoid electrostatic charge and surge voltage on an X-ray CCD, refer to “CCD image sensors technical note | 3. How to use | 3-11 Electrostatic and surge measures.”

(2) Operating and storage environment

X-ray CCDs are not hermetically sealed, so avoid operating or storing them in high humidity locations. Also do not apply excessive vibrations or shock during transportation.

(3) Deterioration by X-ray irradiation

Like other X-ray detectors, X-ray CCD characteristics deteriorate due to excessive X-ray irradiation. In some applications, CCDs need to be replaced as a consumable product.

(4) Handling CCD with FOS

- FOP is made from glass, so do not apply a strong force and shock to it.
- Do not touch the scintillator section and photosensitive area. A scratched scintillator will cause changes in sensitivity.
- Bonding wires are coated with protective resin, but do not touch the resin as it can damage or break the wire.
- When holding the sensor, hold the board by the edges with your fingers and make sure not to touch the exposed areas of the leads and wires as shown in the photos [Figure 4-9 (a)]. Touching the exposed areas of the leads and wires may damage the sensor due to static electricity.
- Never apply force to the FOS. It may damage the scintillator [Figure 4-9 (b)].

[Figure 4-9] Precautions when holding the sensor

(a) Hold the board by the edges with fingers.

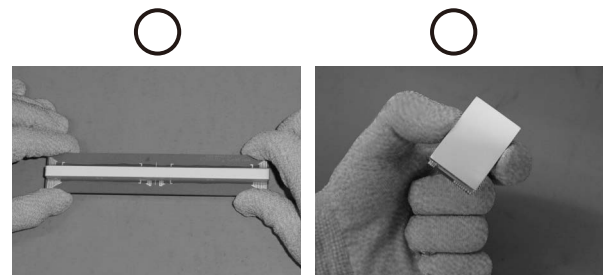

(b) Do not apply force to the FOS.

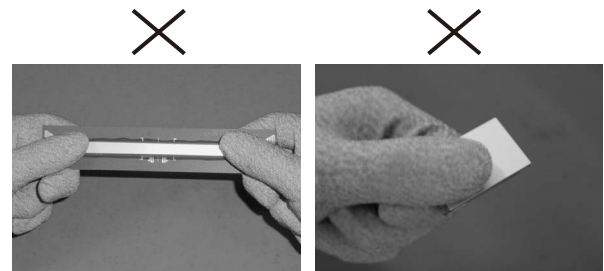

(c) Do not bend the cable excessively.



(5) Handling the module with an assembled cable

- Do not apply excessive force to the sensor section. Biting it, applying force to it, or dropping it may cause damage or failure.

·Applying excessive force by bending or pulling on the cable may cause breakdowns such as the cable breaking internally, so please handle the cable with care [Figure 4-9 (c)].

4 - 4 Applications

» Non-destructive inspection (for industry)

X-ray CCDs can be used to perform one-shot imaging or perform imaging in TDI operation to inspect objects moving on a conveyor and for other purposes.

[Figure 4-10] Example of printed circuit board imaging

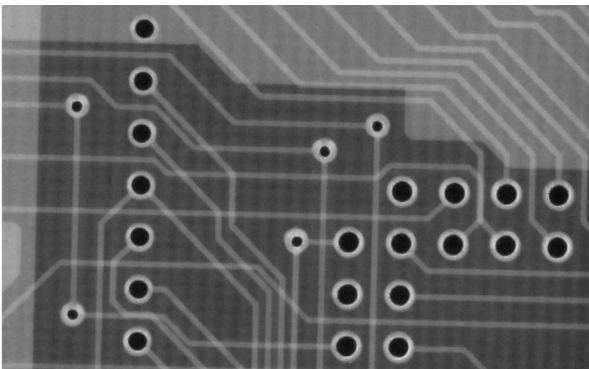

» Radiography

(1) Panoramic imaging

Panoramic X-ray imaging devices capture images by using the X-ray source and detector unit designed to rotate around the patient's head. By TDI operation, a panoramic diagnostic image larger than the size of the photosensitive area is acquired.

[Figure 4-11] Example of panoramic imaging

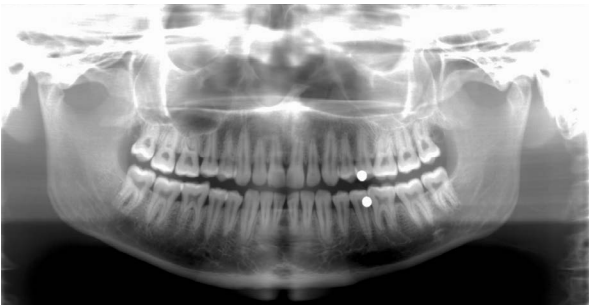

(2) Cephalo imaging

Cephalo X-ray imaging devices capture images of the head. These devices use TDI operation for acquiring diagnostic images like panoramic imaging.

[Figure 4-12] Example of cephalo imaging

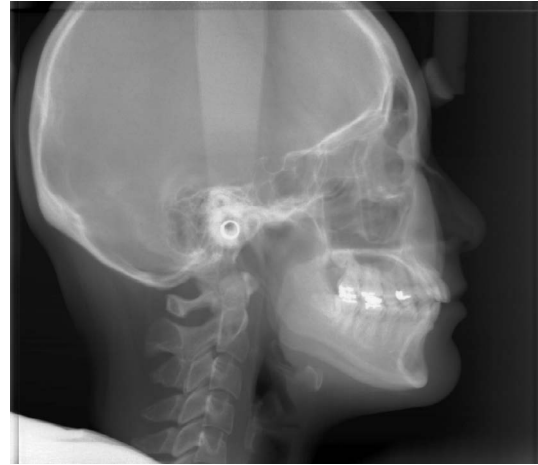

5. CMOS area image sensors

X-ray CMOS area image sensors are image sensors designed for intraoral imaging and non-destructive inspection. These image sensors make use of advantages offered by active pixel type CMOS devices, including high integration, sophisticated functions, and high S/N. They contain a timing generator, vertical and horizontal shift registers, readout amplifier, A/D converters, and LVDS [Figure 5-1]. The digital input and output make these image sensors very easy to use. These image sensors contain a global shutter function (integrates charges simultaneously in all pixels) that allows acquiring one shot of an X-ray image in synchronization with the X-ray irradiation timing. Since these image sensors have an internal A/D converter, analog video wiring can be kept short to reduce noise. The internal A/D converter also simplifies the external circuit and helps hold down the overall cost.

[Figure 5-1] Block diagram (typical example)

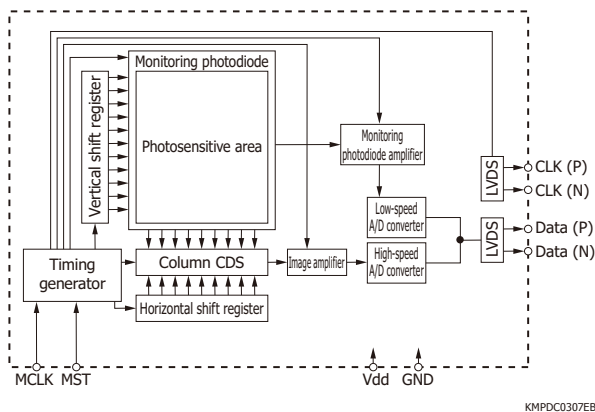

5 - 1 Features and structure

» Comparing CMOS and CCD

In regions where signal levels are low, CCD area image sensors provide better image quality. CMOS area image sensors use CMOS technology, which makes them superior in terms of multifunctionality and easy to use. CMOS area image sensors also offer the advantage of a lower total cost because peripheral circuit functions can be built into the CMOS chip.

» Internal monitoring photodiode

In the X-ray CMOS area image sensors, a monitoring photodiode for detecting the X-ray irradiation start timing (trigger) is mounted as a narrow strip along the entire circumference on the outer side of the photosensitive area [Figure 5-2]. Monitoring photodiode signals are transmitted repetitively at specific intervals.

The output is sent to an external control circuit. When this output exceeds the specified threshold value, the external control circuit determines that the X-ray emission has started and instructs the CMOS area image sensor to start charge integration and readout.

[Figure 5-2] Monitoring photodiode

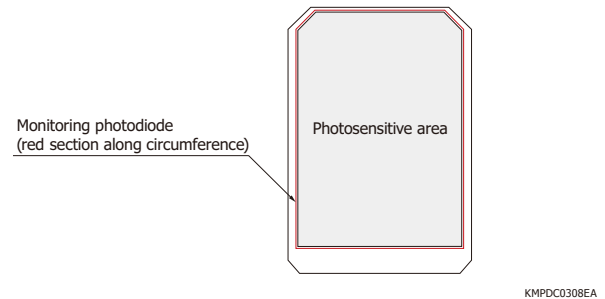

» Low power consumption

X-ray CMOS area image sensors have an internal high-speed A/D converter (14 bits) for image data, and a low-speed A/D converter (10 bits) for monitoring photodiode data. The high-speed A/D converter which uses up much current starts only when image data is transferred. Only the low-speed A/D converter which consumes low power is on during the long periods of standby for X-ray irradiation. This keeps the average power consumption lower [Figure 5-3].

[Figure 5-3] Block diagram

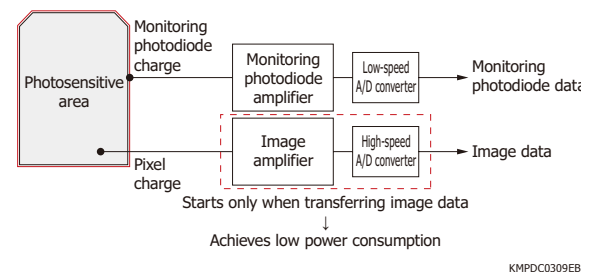

» Global shutter function

Hamamatsu X-ray CMOS area image sensors employ a global shutter function. The global shutter enables integration of all pixels simultaneously and therefore produces high-resolution images even when X-rays are emitted during image data readout or in machine-vision and other applications where images of moving objects are captured, almost without any of their adverse effects.

» APS (active pixel sensor) type

Unlike the charge transfer type image sensors exemplified by CCDs, X-Y address type CMOS area image sensors read out integrated pixel charges and thus have long data line wiring. This wiring

capacitance becomes a large noise source when the transistors in each pixel switch. As such, Hamamatsu X-ray CMOS area image sensors employ an APS type that houses an amplifier in the pixel. Since the integrated charge is converted into voltage for each pixel, low-noise images can be achieved.

» High detective quantum efficiency

Detective quantum efficiency (DQE) is one of the parameters that define the performance of an X-ray detector. It shows the level of the output image signal S/N (SNR_{OUT}) with respect to the S/N (SNR_{IN}) of the X-ray irradiated on the X-ray detector. Since X-ray noise is closely related to the radiation dose, the DQE can be used as a measure of the photon detection efficiency of the X-ray detector.

The DQE can be used as a measure for evaluating the incident X-ray photon detection efficiency and image quality. Higher DQE indicates higher efficiency in obtaining high-quality image from the incident X-rays. The DQE is given by equation (5-1) or (5-2).

$$DQE = \frac{(SNR_{OUT})^2}{(SNR_{IN})^2} \dots\dots (5-1)$$

$$DQE = \frac{MTF^2}{\phi WS} \dots\dots (5-2)$$

MTF : modulation transfer function
 ϕ : number of incident X-ray photons
 WS : Wiener spectrum

In an ideal imaging system without noise, the DQE is equal to 1. In a real imaging system, noise introduced in various processes such as noise generated by the pixels and electronic circuit increases the Wiener spectrum, and especially in the high-frequency region where the effect is great, the DQE decreases. Hamamatsu X-ray CMOS area image sensors use high-emission-efficiency and high-resolution CsI(Tl) for the scintillator to achieve higher DQE, which produces high-quality image and lower X-ray radiation dose [Figure 5-4, 5-5, 5-6].

For information on MTFs, see “CCD image sensors technical note | 2. Characteristics | 2-11 Resolution.”

[Figure 5-4] MTF vs. spatial frequency (S11684, typical example)

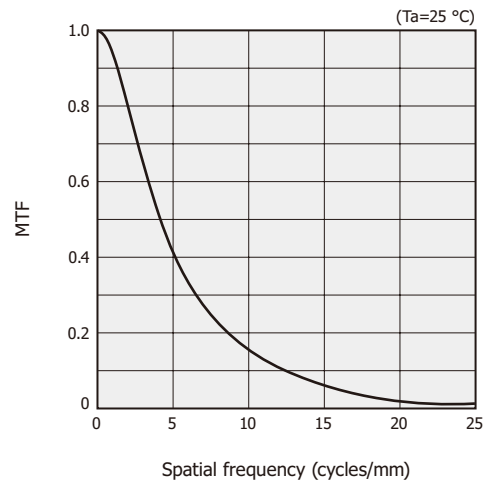

KMPDB0386EA

[Figure 5-5] Wiener spectrum vs. spatial frequency (typical example)

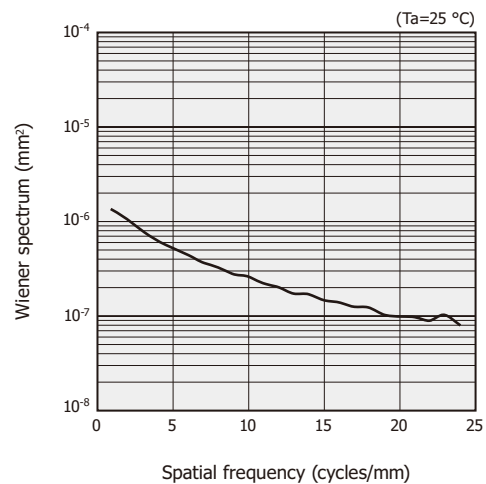

KMPDB0387EA

[Figure 5-6] DQE vs. spatial frequency (typical example)

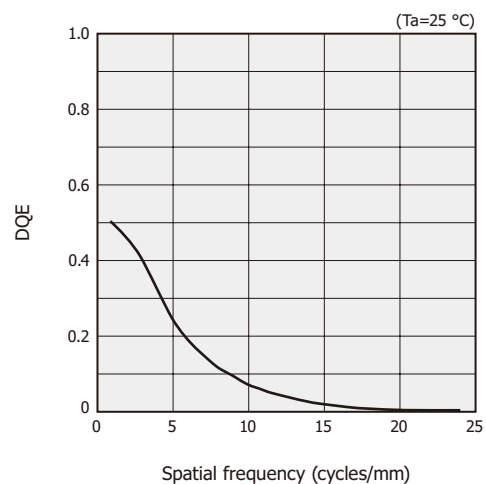

KMPDB0388EA

5 - 2 How to use

Since X-ray CMOS area image sensors have an internal timing generator, it is possible to monitor X-ray emission timing and also integrate and read out image data just by applying a master start pulse (MST) and

master clock pulse (MCLK). Data from the monitoring photodiode and image data are switched by an internal switch so that they are transmitted from the same output wiring [Data(P), Data(N)] [Figure 5-7].

For information on image correction, see “CCD area image sensors | 4-3 How to use | Image correction.”

[Figure 5-7] Input/output wiring diagram

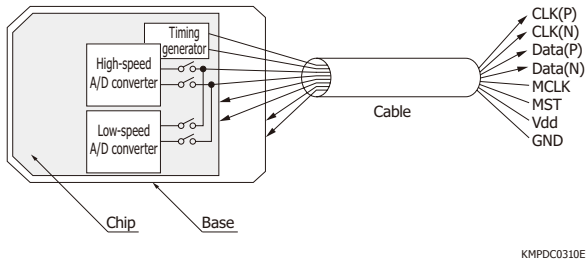

» Precautions

The precautions on using X-ray CMOS area image sensors are the same as those for X-ray CCDs (see “4. CCD area image sensors | 4-3 How to use | Precautions”).

5 - 3 Applications

» Intraoral imaging

Detailed diagnostic images of two to three teeth can be obtained by inserting a CMOS area image sensor for intraoral imaging and non-destructive inspection into the patient’s mouth.

For intraoral imaging, Hamamatsu provides CMOS modules that use a relatively large area CMOS area image sensor of 1000 (H) × 1500 (V) pixels or 1300 (H) × 1700 (V) pixels, both with a pixel size of 20 × 20 μm, assembled with a cable [Figure 5-8]. The scintillator uses CsI(Tl) that achieves a high resolution of 15 to 20 line pairs/mm.

Coupling the FOS to the CMOS gives high durability against X-ray exposure. For example, these modules can operate up to 100000 times or more under X-ray irradiation of approximately 250 μGy at tube voltage 60 kV. Besides this feature, the sensor unit of these CMOS modules is thin and compact, allowing X-ray imaging even in a narrow section.

[Figure 5-8] CMOS module



6. Flat panel sensors

Flat panel sensors are modules for X-ray imaging consisting of a control unit and a detector that combines a large area image sensor and a scintillator. We offer two types of detectors. The first type integrates a photosensitive area (a two-dimensional photodiode array), a high-performance charge amplifier, and a scanning circuit on a large-area single crystal Si chip. The second type uses advanced a-Si that realizes a large photosensitive area and high-speed response. The control unit includes A/D converters, memories, an interface circuit, and a PLD that controls these components. There is no need to use an external circuit to operate the device. The flat panel sensor can capture megapixel-class, high definition digital images which are distortion-free in both still and moving images. The thin profile and light weight make the flat panel sensor easy to install into other equipment. Flat panel sensors are now widely used in various types of X-ray imaging systems including CT.

We also offer flat panel sensors that use advanced a-silicon, which features large photosensitive area and high-speed response, for the detector.

[Figure 6-1] Flat panel sensors

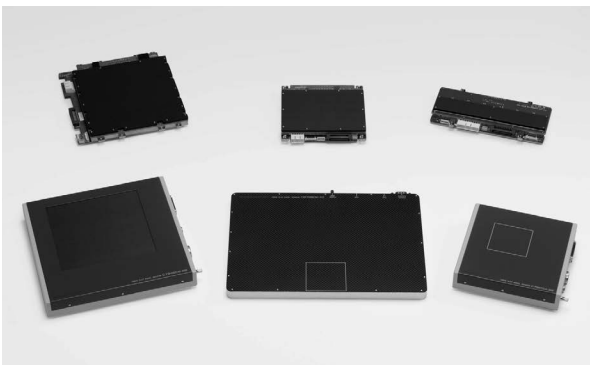

[Figure 6-2] Imaging examples

(a) Hornet

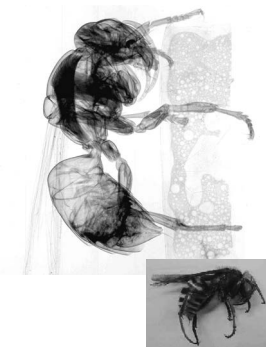

(b) Fish

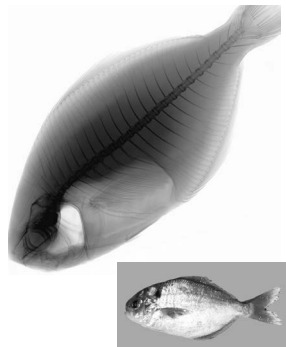

6-1 Features

- ▶ High sensitivity
- ▶ High resolution
- ▶ High frame rate
- ▶ Wide dynamic range
- ▶ Distortion-free images
- ▶ Directly deposited CsI(Tl) scintillator type is available.

6-2 Structure

Figure 6-3 shows the internal circuit of a CMOS chip for flat panel sensors. Two-dimensional X-ray image signals converted into fluorescence by a scintillator are accumulated as an electric charge in the junction capacitance of each photodiode with excellent linearity. The accumulated charges are then output one row at a time through the data line by the vertical shift register when the address switch turns on.

Since the flat panel sensor operates in charge integration mode, the output video signal voltage $V(t)$ is expressed by equation (6-1).

$$V(t) = G \times Q(t) = G \times I(t) \times t_1 = G \times I(t) \times 1/Sf \dots\dots(6-1)$$

G : amplifier gain
 $Q(t)$: integrated charge
 $I(t)$: photodiode photocurrent
 t_1 : integration time
 Sf : frame rate

When a constant X-ray radiation dose is striking an object, the photocurrent generated in a photodiode is constant. The output voltage can be increased by slowing the frame rate (making the integration time longer). The frame rate can be controlled by the external trigger mode described later on. The saturation charge is determined by the photodiode junction capacitance. The maximum video output value after A/D conversion is set to the saturation charge value.

» Amplifier circuit

There are two types of amplifier circuits for flat panel sensors: a passive pixel type and an active pixel type.

The passive pixel type has an amplifier for each column of the photodiode array, where the amplifier is connected to each photodiode via address switch. The amplifiers are formed on one side of the two-dimensional photosensitive area as an amplifier array. The passive pixel type allows a high fill factor and high radiation durability. However, the input capacitance caused by the data line limits the reduction in amplifier thermal noise.

The active pixel type structure eliminates the foregoing problem in the passive pixel type. The active pixel type has an amplifier for each pixel, and the accumulated charges are converted into voltage there. This structure lowers the noise level, which is about one figure less than the passive pixel type. Because of its low noise and high S/N features, the active pixel type flat panel sensor acquires high definition images from low energy X-rays.

[Figure 6-3] Internal circuits of CMOS chip

(a) Passive pixel type

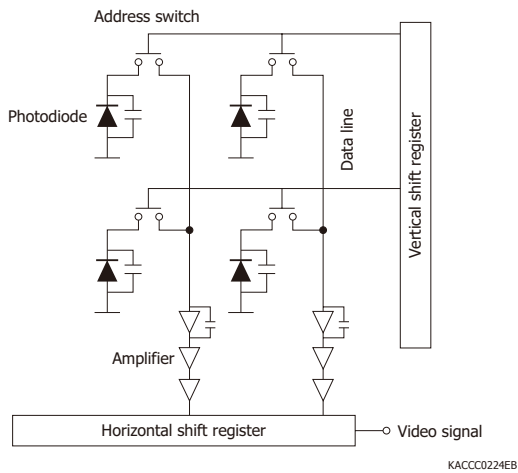

(b) Active pixel type

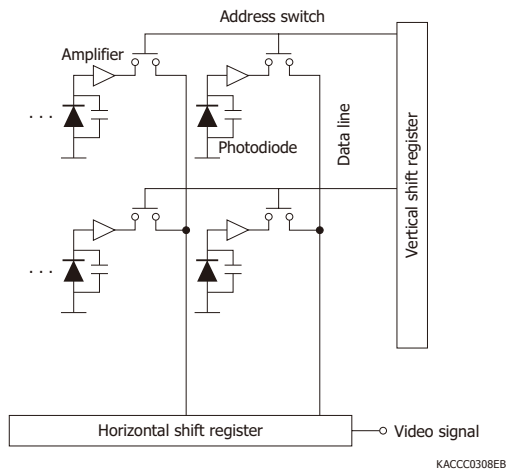

» Scintillator

Flat panel sensors employ an indirect X-ray detection method that converts X-rays into light using a scintillator and then detects that light. By optimizing the wafer process technology, Hamamatsu has succeeded in developing a high-sensitivity photodiode that matches the spectral characteristics of the scintillator.

The CsI(Tl) scintillator [Figure 6-4] used for most flat panel sensors has needle-like crystals through which scintillation light propagates, and flat panel sensors with CsI(Tl) scintillator therefore have superior resolution and emission intensity compared to flat panel sensors using other scintillators composed of

grain (particle) crystals (such as GOS).

[Figure 6-4] Cross-sectional photo of CsI(Tl) scintillator showing needle-like crystals

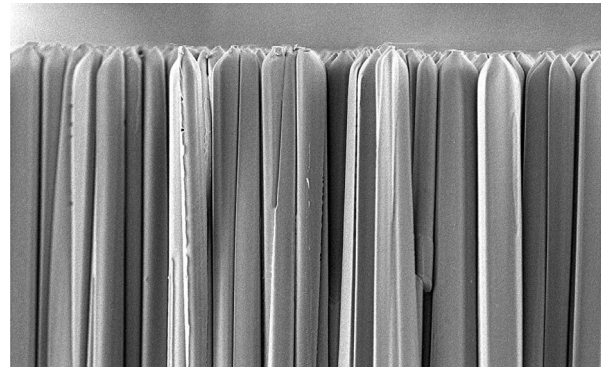

[Figure 6-5] Cross-sectional photo of GOS scintillator showing grain crystals

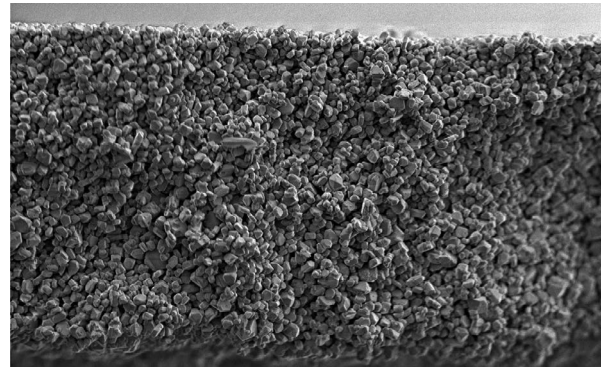

There are two scintillator-to-photodiode coupling methods. One method uses an FSP (flipped scintillator plate), which is a glass plate on which the scintillator is deposited, and the scintillator side of the FSP is attached in close contact with the photodiode. The other method is direct deposition of scintillator onto the photodiode. The method using a CsI(Tl) FSP has better fluorescent intensity and resolution than medical screens utilizing GOS. The direct deposition method further improves the resolution because it suppresses fluorescence scattering compared to the FSP method.

Hamamatsu provides both FSP type and direct deposition type flat panel sensors that can be selected according to the application.

[Figure 6-6] Cross-sectional structures of chip

(a) FSP type

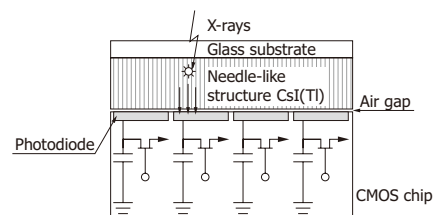

(b) Direct deposition type

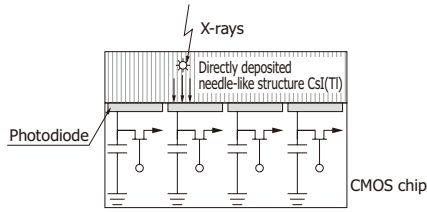

KACCC0271EB

» Tiling

Some flat panel sensors have a large-format photosensitive area achieved by using the “tiling” technique. The high accuracy tiling technique reduces the gap in the tiled part. The tiled part can be compensated by software based on adjacent pixels, so it is possible to obtain seamless images.

[Figure 6-7] Gap in tiled part of photosensitive area (C10502D-70)

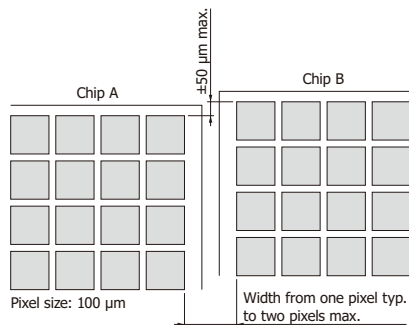

KACCC1065EA

6 - 3 Operating principle

» Signal readout method

The following methods are generally used to read out digital signals.

(1) Serial drive method

This method reads out video data by serially driving all pixels, so the frame rate slows down when there are a large number of pixels.

(2) Parallel drive method

■ Single port readout method

This method divides the monolithic photosensitive area into multiple blocks, and reads out video data through a single port by driving each block in parallel. Figure 6-8 shows a schematic of an photosensitive area divided into “n” blocks. Since flat panel sensors have many pixels numbering more than one million, the serial drive method causes the frame rate to drop. The single port readout method, however, offers high speed and easy processing of video data and so is used for most flat panel sensors.

■ Multiport readout method

This method reads out video data through multiple ports to achieve even higher speed drive than the single port readout method. Providing multiple ports for video data readout can increase the image data transfer amount per unit time, which is larger than that of the single port readout method. Some flat panel sensors use this method.

[Figure 6-8] Schematic of parallel drive method

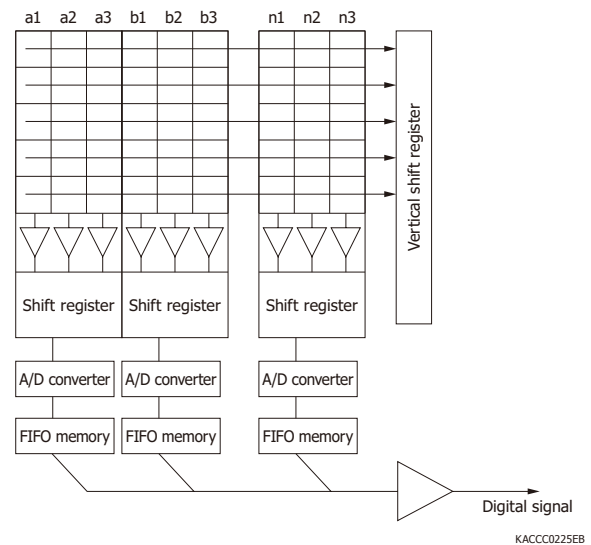

KACCC0225EB

» Video output interface

Flat panel sensors support the following video output interfaces: RS-422, LVDS, USB 2.0, and Gig-E. USB 2.0 and Gig-E support our digital camera interface DCAM.

» Binning mode

Some flat panel sensor models have a binning mode function that simultaneously reads out multiple pixel data. Up to 4 × 4 pixels can be selected for binning though this depends on the sensor models. Increasing the number of binning pixels also increases the sensor frame rate. Note that the highest resolution is obtained by single operation (1 × 1 mode) without using binning mode.

6 - 4 Characteristics

» Spectral response

The photosensitive area of flat panel sensors consists of a two-dimensional photodiode array. Figure 6-9 shows the spectral response of a typical flat panel sensor and the emission spectrum of a CsI(Tl) scintillator. To achieve high sensitivity, the photodiode array is designed to have high sensitivity in the vicinity of the peak emission wavelength of CsI(Tl).

The X-ray energy range at which flat panel sensors are sensitive differs depending on the sensor model. Refer to their datasheets for details.

[Figure 6-9] Example of spectral response and CsI(Tl) scintillator emission spectrum

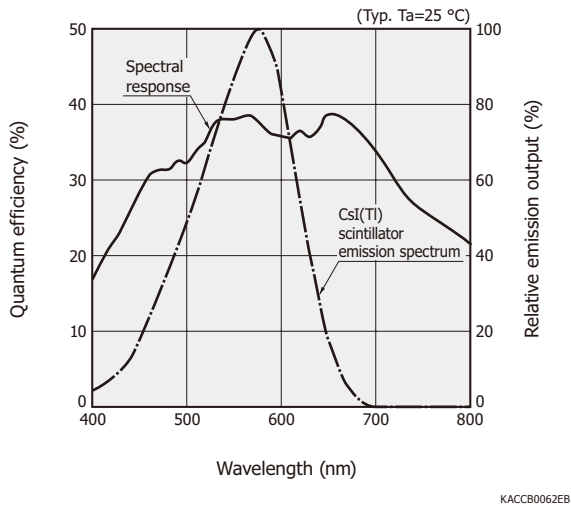

» Linearity

Flat panel sensors exhibit excellent linearity versus the incident X-ray levels. Figure 6-10 shows the output linearity of a flat panel sensor (14-bit output). The upper limit of the 14-bit output is 16383 gray levels.

[Figure 6-10] Output linearity (14-bit output, typical example)

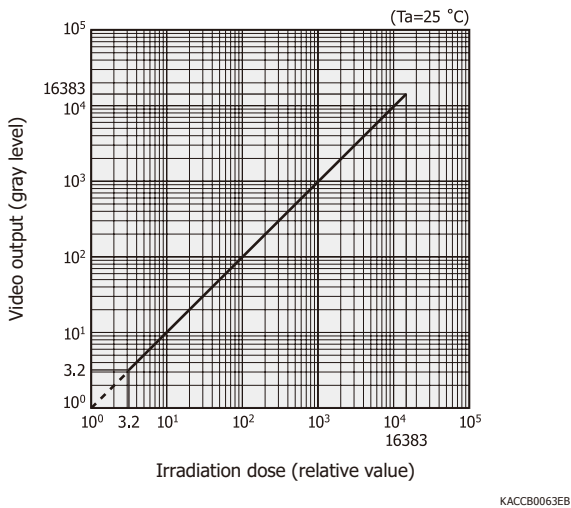

» Dark video output

When the integration time is set longer, dark video output slightly increases due to the photodiode dark current. Figure 6-11 shows the relationship between dark video output and integration time for a flat panel sensor (14-bit output). The photodiode dark current (I_D) is expressed by equation (6-2).

$$I_D = K/G \text{ [C/s]} \dots\dots\dots(6-2)$$

K : increasing rate [gray levels/s] of dark video output versus integration time
G : conversion gain

[Figure 6-11] Dark video output vs. integration time (14-bit output, typical example)

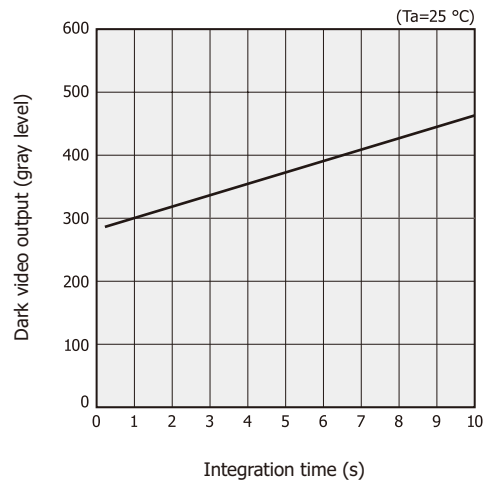

A slight drift occurs in the dark video output after the power is turned on. Figure 6-12 shows examples from measuring this dark video output drift. In internal trigger mode (2 frames/s), the dark video output shows little change after the power is turned on. At a slow frame rate, however, the dark video output shifts. In applications where fluctuations in the dark video output cause problems, determine how often dark images should be acquired for correction to meet the allowable drift level range.

[Figure 6-12] Drift characteristics of dark video output (14-bit output, typical example)

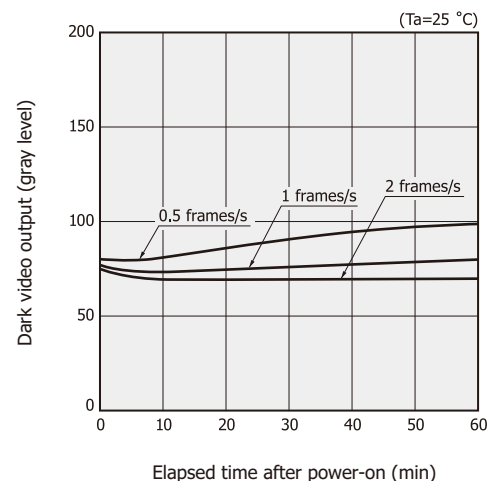

» Noise and dynamic range

Flat panel sensors were developed based on CMOS image sensors. CMOS image sensors transfer charges accumulated in the photodiodes to the readout circuit through the video line.

In the passive pixel type CMOS image sensors, noise is

expressed by equation (6-4). The video line parasitic capacitance (Cd) is very large compared to the photodiode junction capacitance (Cp) and charge amplifier feedback capacitance (Cf), so the video line parasitic capacitance becomes a dominant source of noise.

$$V_{\text{tot}}(\text{rms}) = \frac{8}{3} k T \frac{1}{g_m} \left(\frac{C_t}{C_f} \right)^2 \beta_1 + \frac{K_f}{C_{ox}^2 W L} \left(\frac{C_t}{C_f} \right)^2 \beta_2 \dots (6-3)$$

$$V_{\text{tot}}(\text{rms}) = \frac{C_t}{C_f} \sqrt{\frac{8}{3} k T \frac{1}{g_m} \beta_1 + \frac{K_f}{C_{ox}^2 W L} \beta_2} \dots (6-4)$$

$$C_t = C_p + C_f + C_d \dots (6-5)$$

- Vtot : total noise voltage
- T : absolute temperature [K]
- gm : transconductance of charge amplifier first-stage transistor
- β1, β2 : constants determined by charge amplifier
- Kf : 1/f noise constant of charge amplifier first-stage transistor
- Cox : gate oxide film capacitance of charge amplifier first-stage transistor
- W : W length of charge amplifier first-stage transistor
- L : L length of charge amplifier first-stage transistor

The noise level of passive pixel type CMOS image sensors depends on the pixel size and the number of pixels. The lower limit of flat panel sensor dynamic range is determined by noise and the upper limit by the saturation charge. This means that the dynamic range is derived from the ratio of saturation charge to noise. In the active pixel type, the video line parasitic capacitance is extremely low, so the noise is small.

» Resolution

Resolution is a degree of detail to which image sensors can reproduce an input pattern in the output. The photosensitive area of a flat panel sensor consists of a number of regularly arrayed photodiodes, so the input pattern is output while being separated into pixels. Therefore as shown in Figure 6-13, when a square wave pattern of alternating black and white lines with different intervals is input, the difference between black and white level outputs becomes smaller as the pulse width of the input pattern becomes narrower. In such a case, the contrast transfer function (CTF) is given by equation (6-6).

$$CTF = \frac{V_{WO} - V_{BO}}{V_W - V_B} \times 100 [\%] \dots (6-6)$$

- Vwo: output white level
- Vbo: output black level
- Vw : output white level (when input pattern pulse width is wide)
- Vb : output black level (when input pattern pulse width is wide)

[Figure 6-13] Contrast transfer function characteristics

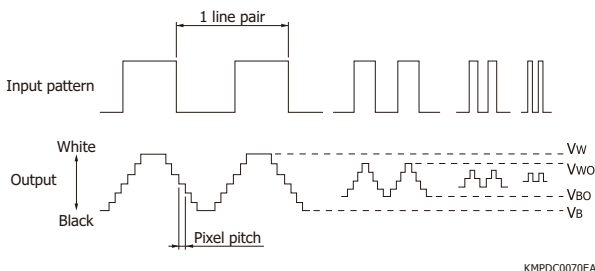

KMPDC0070EA

The fineness of the black and white lines on the input pattern is given by the spatial frequency of the input pattern. The spatial frequency is the number of black and white line pairs per unit length. In Figure 6-13, the spatial frequency corresponds to the reciprocal of the distance from one white edge to the next white edge in the pattern. It is usually represented in units of line pairs/mm. The finer the input pattern or the higher the spatial frequency, the lower the CTF will be.

[Figure 6-14] Contrast transfer function vs. spatial frequency [pixel size: 50 × 50 μm, CsI(Tl) direct deposition, typical example]

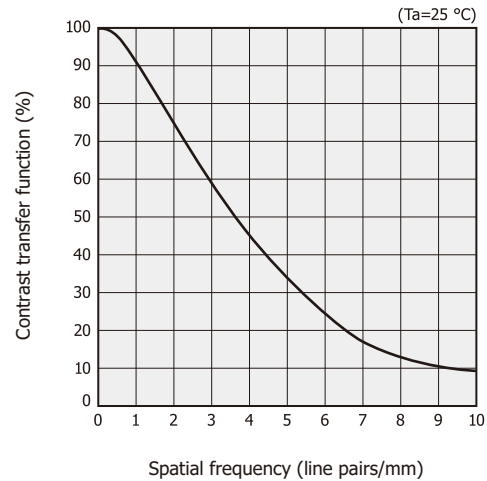

KACC00193EA

The resolution and sensitivity of flat panel sensors to X-rays depend on the scintillator thickness. Both are in a tradeoff relation. Our flat panel sensors are designed for optimal scintillator thickness by taking the application and pixel size into account to deliver high resolution and high sensitivity.

» Reliability

In ordinary X-ray detectors, deterioration in performance such as a drop in sensitivity and an increase in dark video output occurs due to X-ray irradiation. Likewise, flat panel sensor characteristics deteriorate due to X-ray irradiation. For example, an FSP type flat panel sensor with an aluminum top cover intended for non-destructive inspection is designed for use at a tube voltage from 20 kV to 100 kV, and can be used up to an accumulated dose of 8.7 kGy (one million roentgens) if used under tube voltage 100 kV. When the photosensitive area is uniformly irradiated with X-rays, the dark current also increases almost uniformly over the photosensitive area. The dark current might partially increase in the photosensitive area, but this can be eliminated by dark image correction. When the partial increase in dark video output caused by increased dark current has exceeded the dark image correction limit, the flat panel sensor should be replaced as a consumable part. The life of flat panel sensors can be extended by setting the X-ray dose to a lower level within the detectable range and by

preventing X-rays from irradiating the flat panel sensor except during imaging. Another effective way to extend the detector life is to use pulsed X-rays.

» X-ray irradiation damage

For example, on the C7942CA-22, if an X-ray with tube voltage 80 kV is irradiated over 4 hours a day (1 × 1 mode, frame rate: 2 frames/s), the detector life is 152 days.

6 - 5 How to use

» Connection method

Setup is simple. All that is needed is to connect the flat panel sensor to a PC and power supply using the data cable and power cable (some models require an external trigger input cable). Then supplying the voltage to the flat panel sensor will start real-time X-ray image acquisition from the PC control. Figure 6-15 shows a connection example of an X-ray imaging system using a flat panel sensor. Use a monotonically increasing series power supply with a transformer for the voltage source.

[Figure 6-15] Connection example (C10500D-03)

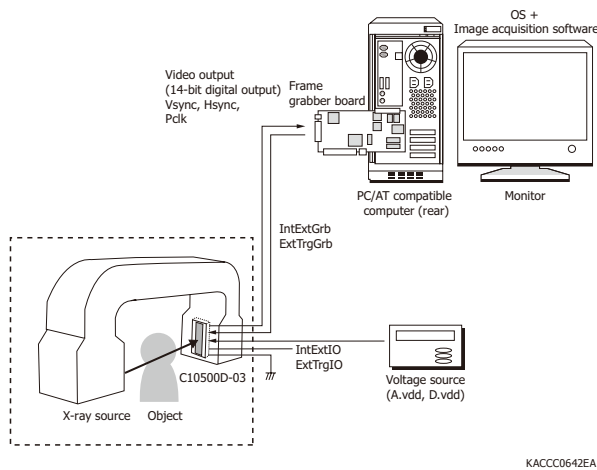

» Trigger mode

Flat panel sensors have two trigger modes (internal trigger mode and external trigger mode).

In internal trigger mode, the sensor always operates at the maximum frame rate and constantly outputs the sync signals and video signal.

To capture images in external trigger mode, apply external trigger pulses to the ExtTrgIO or ExtTrgGrb terminal as shown in Figure 6-16. Vsync+, Hsync+, and video signal are output after time Tvd elapses from the rising edge of the external trigger pulse.

To synchronize with the pulse X-ray source, apply X-rays during Txray.

[Figure 6-16] External trigger mode

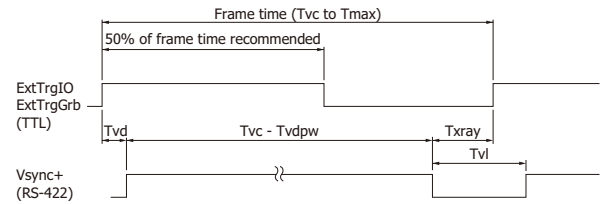

Hsync+, Pclk, and effective video output are the same as those for internal trigger mode.
 · Tmax is defined using the reciprocal of the minimum value of Sf(ext).
 · Txray = Frame time - Tvd - (Tvc - Tvdpw)
 · Tvl = Frame time - (Tvc - Tvdpw)

KACCC0341EE

» Defect lines

Charges accumulated in the photodiodes are transferred to the readout circuit through the data line by turning on the CMOS switch for each pixel using the gate line from the shift register. An open-circuit fault occurring in the gate line or data line will make it impossible to read out some pixels. These continuous pixels are called the defect line. Although defect lines are inevitable in image sensors with a large photosensitive area, correcting them by software based on values of the surrounding pixels makes it possible to eventually acquire images with no defects.

Charges leaking out of a defect line might increase the output of the pixels adjacent to the defect line. This phenomenon can also be corrected by software.

» Image correction

Flat panel sensors utilizing the latest CMOS process technology and CDS circuits can acquire images with very high uniformity, yet they also offer an even higher level of image quality by software correction.

» Precautions

Flat panel sensors deteriorate due to X-ray irradiation. After long term use or after use under large radiation doses, the sensor sensitivity decreases and the dark video output increases. Coping with this deterioration requires correcting the image by software to meet the desired detection accuracy, as well as periodically replacing the flat panel sensor as a consumable part.

6 - 6 Applications

» X-ray imaging using pulsed X-ray source

In most X-ray imaging using a continuous X-ray source, there is no need to synchronize the detector with the X-ray source during use. However, in general, when using a pulsed X-ray source that emits a high radiation dose in a short time compared to

continuous X-ray sources, the detector must be synchronized with the emission timing of the X-ray source to acquire an image.

If using a flat panel sensor with a pulsed X-ray source, then setting the flat panel sensor to external trigger mode will be convenient. In external trigger mode, inputting an external trigger signal to the flat panel sensor allows reading out the charges that have been kept accumulated in the photodiodes up until then. The charges are in this case continually accumulated until an external trigger signal is input. To acquire an image in synchronization with the pulsed X-ray source, the X-ray source must emit X-rays at the appropriate trigger intervals.

Figure 6-17 shows a timing chart for acquiring images with pulsed X-rays using an external trigger signal.

Here, an external trigger signal is input prior to pulsed X-ray emission, and starts readout of charges integrated in the photodiodes up until that time (①). Readout of the integrated charges ends after Tprdy from the rising edge of the external trigger signal (②), and the photodiodes are reset. Refer to the datasheet for information on other parameters.

$$T_{prdy} = T_{vd} + T_{vc} - T_{vdpw} \dots\dots\dots (6-7)$$

Tvdpw: period during Vsync+ is at low level in internal trigger mode

Pulsed X-rays are emitted in the period between ② and ③ (rising edge of the next external trigger signal) on the timing chart. The next external trigger signal is input after the X-ray emission. The operation of ① to ③ then repeats.

[Figure 6-17] Timing chart

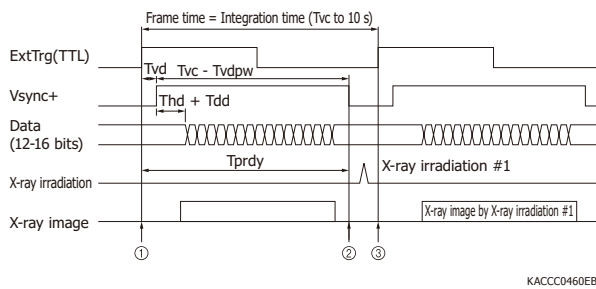

» Acquiring enlarged images of small objects

Flat panel sensors can acquire an enlarged image since they capture images with no distortion and have high resolution.

The image magnification is expressed by equation (6-8).

$$\text{Magnification} = \frac{D_1}{D_2} \dots\dots\dots (6-8)$$

D1: distance between X-ray source focal point and flat panel sensor
D2: distance between X-ray source focal point and object

If the distance between the flat panel sensor and X-ray source is fixed, then the magnification will increase as the object is brought closer to the X-ray source.

During enlargement, the image becomes fuzzier as the focal spot size of the X-ray source becomes larger. This means that using an X-ray source with a small focal spot size will yield sharp, clear images even when enlarged.

[Figure 6-18] Image distortion by X-ray source with different focal spot size

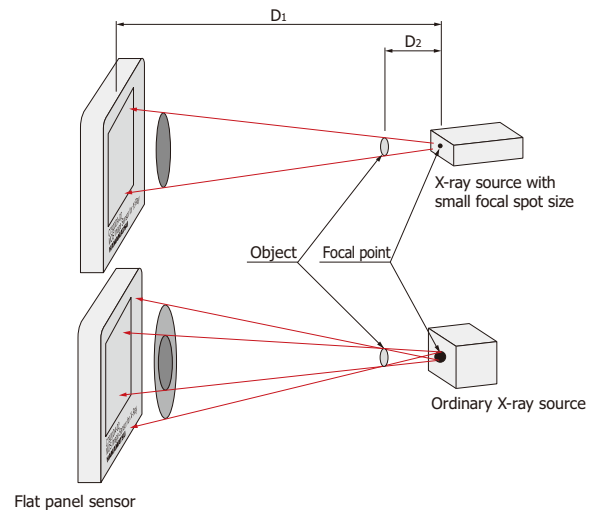

KACCC0245EB

» Cone beam CT

As a method for making full use of the features of flat panel sensors with a large photosensitive area, there is a cone beam CT that uses a cone beam X-ray source capable of emitting X-rays over a wide area.

The cone beam X-ray source and the flat panel sensor are installed opposite each other with the object positioned in the center. Images of the object are then acquired while the X-ray source and flat panel sensor are rotated at the same speed around the object.

The two-dimensional image data acquired in this way is then reconstructed by a computer to create three-dimensional X-ray transmission images. The cone beam CT can also acquire three-dimensional X-ray images of large objects in a short time by using high-frame-rate flat panel sensor with a large photosensitive area.

[Figure 6-19] Concept image of cone beam CT

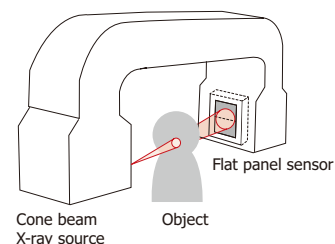

KACCC0461EA

» X-ray diffraction

Flat panel sensors are useful for analysis of X-ray Laue diffraction method because of a large photosensitive area and high resolution. As shown in Figure 6-20, parallel X-rays irradiate the object, and interference fringes formed by the X-rays diffracted by the object are detected with the flat panel sensor. In this way high definition images equivalent to those obtained with an imaging plate can be obtained. The flat panel sensor is used for applications including structural analysis of crystals and proteins.

[Figure 6-20] Concept image of X-ray diffraction

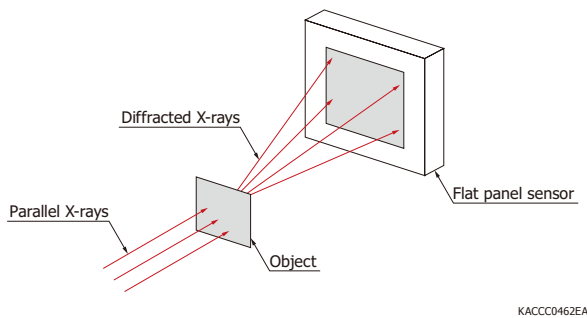

KACCC0462EA

[Figure 6-21] X-ray diffraction pattern example

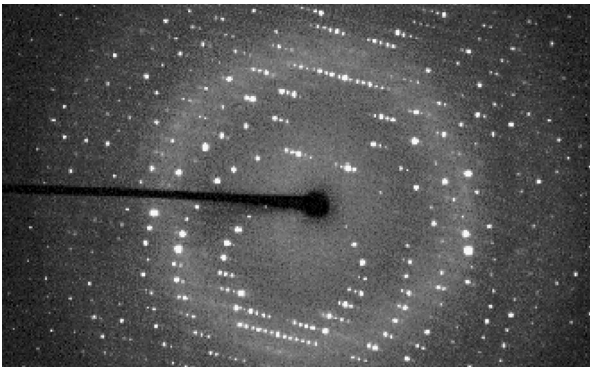

Information described in this material is current as of March 2021.

Product specifications are subject to change without prior notice due to improvements or other reasons. This document has been carefully prepared and the information contained is believed to be accurate. In rare cases, however, there may be inaccuracies such as text errors. Before using these products, always contact us for the delivery specification sheet to check the latest specifications.

The product warranty is valid for one year after delivery and is limited to product repair or replacement for defects discovered and reported to us within that one year period. However, even if within the warranty period we accept absolutely no liability for any loss caused by natural disasters or improper product use. Copying or reprinting the contents described in this material in whole or in part is prohibited without our prior permission.

HAMAMATSU

www.hamamatsu.com

HAMAMATSU PHOTONICS K.K., Solid State Division

1126-1 Ichino-cho, Higashi-ku, Hamamatsu City, 435-8558 Japan, Telephone: (81)53-434-3311, Fax: (81)53-434-5184

U.S.A.: Hamamatsu Corporation: 360 Foothill Road, Bridgewater, N.J. 08807, U.S.A., Telephone: (1)908-231-0960, Fax: (1)908-231-1218, E-mail: usa@hamamatsu.com

Germany: Hamamatsu Photonics Deutschland GmbH: Arzbergerstr. 10, D-82211 Herrsching am Ammersee, Germany, Telephone: (49)8152-375-0, Fax: (49)8152-265-8, E-mail: info@hamamatsu.de

France: Hamamatsu Photonics France S.A.R.L.: 19, Rue du Saule Trapu, Parc du Moulin de Massy, 91882 Massy Cedex, France, Telephone: (33)1 69 53 71 00, Fax: (33)1 69 53 71 10, E-mail: infos@hamamatsu.fr

United Kingdom: Hamamatsu Photonics UK Limited: 2 Howard Court, 10 Tewin Road, Welwyn Garden City, Hertfordshire AL7 1BW, UK, Telephone: (44)1707-294888, Fax: (44)1707-325777, E-mail: info@hamamatsu.co.uk

North Europe: Hamamatsu Photonics Norden AB: Torshamnsgatan 35 16440 Kista, Sweden, Telephone: (46)8-509 031 00, Fax: (46)8-509 031 01, E-mail: info@hamamatsu.se

Italy: Hamamatsu Photonics Italia S.r.l.: Strada della Moia, 1 int. 6, 20044 Aresse (Milano), Italy, Telephone: (39)02-93 58 17 33, Fax: (39)02-93 58 17 41, E-mail: info@hamamatsu.it

China: Hamamatsu Photonics (China) Co., Ltd.: 1201 Tower B, Jiaming Center, 27 Dongsanhuan Bellu, Chaoyang District, 100020 Beijing, P.R.China, Telephone: (86)10-6586-6006, Fax: (86)10-6586-2866, E-mail: hpc@hamamatsu.com.cn

Taiwan: Hamamatsu Photonics Taiwan Co., Ltd.: 8F-3, No. 158, Section2, Gongdao 5th Road, East District, Hsinchu, 300, Taiwan R.O.C. Telephone: (886)3-659-0080, Fax: (886)3-659-0081, E-mail: info@hamamatsu.com.tw

Cat. No. KMPD9016E01 Mar. 2021 DN