

NEW

IMAGE SENSOR

Flat panel sensor C9312SK-06

High-speed, High reliability, 110 kV (X-ray tube voltage) proof



Flat panel sensor C9312SK-06 is a digital X-ray image sensor newly developed as a key device for non-destructive inspection, radiography and other real-time X-ray imaging applications requiring high-speed and high image quality.

Features

- Energy range: 110 kVp Max.
- High quality image: 5.7 Mpixels
- Pixel size: 50 x 50 μm
- Digital output (12-bit dual port LVDS)
- High-speed imaging: 8 frames/s (single binning)
- Long life: 110 kVp, 6 MR

Applications

- Non-destructive inspection
- Radiography

■ Block diagram

C9312SK-06 is a compact flat panel sensor consisting of a sensor board and a control board. The sensor board also has 16 charge-sensitive amplifier arrays each having 312 ch amplifiers with a horizontal shift register. Analog video signals are amplified as the charge on each video line by 4992 ch charge amplifiers with CDS (Correlated Double Sampling) circuits added, and are output each of 16 amplifier arrays. The control board converts the analog video signal into a 12-bit digital signal and outputs it to an external frame grabber through a couple of 12-bit parallel ports.

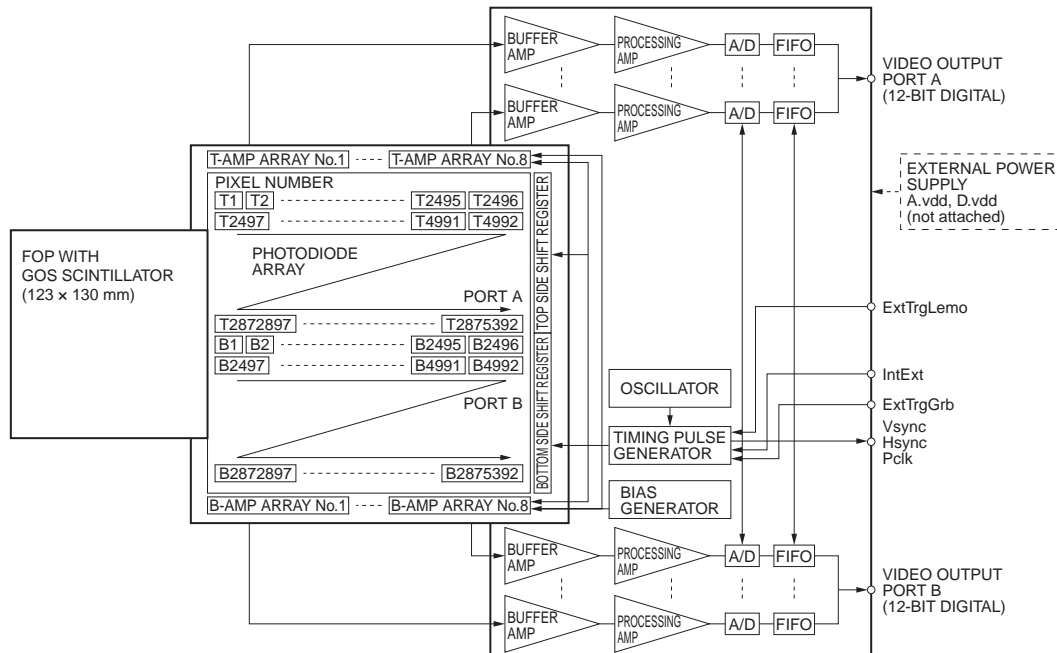

Note: Signals are read out in order of pixel number.

KACCA0168EB

SOLID STATE DIVISION

■ General ratings

Parameter	Specification	Unit
Pixel size	50 × 50	μm
Photodiode area	124.8 × 115.2	mm
Number of pixels	2496 × 2304	pixels
Number of active pixels	2472 × 2184	pixels
Readout	Charge amplifier array	-
Video output	LVDS (differential) 12-bit dual port	-
Output data rate	33.333	MHz
Synchronous signal (Vsync, Hsync, Pclk)	LVDS (differential)	-
ExtTrgGrb, ExtTrgLemo, IntExt	TTL	-
Scintillator	GOS	-

■ Absolute maximum ratings (Ta=25 °C)

Parameter	Symbol	Value	Unit
Supply voltage for digital circuitry (+5 V)	D.vdd	+6.0	V
Supply voltage for analog circuitry (+5 V)	A.vdd	+6.0	V
Input voltage (ExtTrgGrb, ExtTrgLemo, IntExt)	A.vdd	+6.0	V
Operating temperature *1	Topr	0 to +35	°C
Storage temperature *1	Tstg	0 to +50	°C

*1: No condensation

■ Specification (Ta=25 °C, A.vdd= 5.0 V, D.vdd= 5.0 V)

Parameter	Symbol	Min.	Typ.	Max.	Unit
Frame rate (single operation)	Sf (int)	7.6	8	-	frames/s
Frame rate external (single operation)	Sf (ext)	-	Sf (int) to 1	-	frames/s
Noise (rms) *2	N (rms)	-	700	-	electrons
Sensitivity *3	S	16	20	-	LSB/mR
Saturation charge	Csat	-	2.25	-	M electrons
Resolution *4	Reso	7.1	9	-	line pairs/mm
Dynamic range	-	-	3200	-	-
Defect line *5	-	-	-	20	lines
Output offset *6	-	-	65	200	LSB

*2: Internal trigger mode, single operation

*3: at 110 kVp without filter

*4: Spatial frequency at CTF=5 %

*5: A defective line is a vertical or horizontal line containing 4 or more consecutive pixels that produce less than 1/8 of the average output from the surrounding pixels. In this case, one of the following conditions must be met.

Horizontal defective line: Defective pixels are continuously located from the opposite side of the shift register on the upper side or lower side.

Vertical defective line : Defective pixels are continuously located, starting from Row 1091 toward Row 0 in the upper half area.

Defective pixels are continuously located, starting from Row 1092 toward Row 2183 in the lower half area.

Adjacent defective lines are not allowed in the vertical and horizontal directions.

*6: Average of all effective pixels in single operation at Sf (int)

Note: X-ray energy range is 20 k to 110 kVp.

■ Resolution

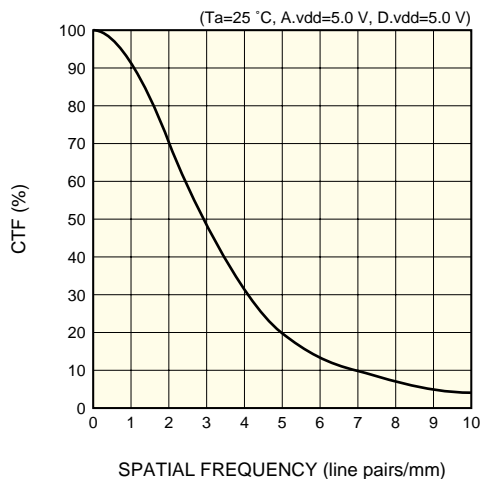

KACCB0148EA

■ Timing chart

To acquire images through an image grabber board, parameters that match the following timing chart should be described in the software program or parameter file.

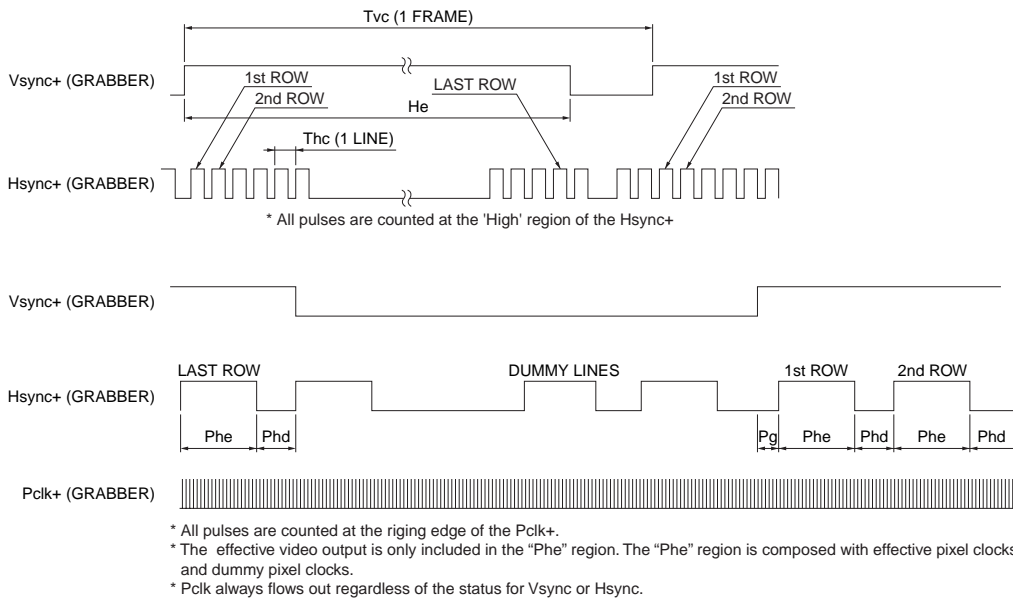

KACCC0281EB

Parameter		1 × 1 (Port A)	1 × 1 (Port B)
He	Dummy	60	0
	Effective	1092	1092
	Dummy	0	60
Phe	Dummy	0	
	Effective	2472	
	Dummy	24	
Phd		1062	
Pg		1069	

■ External trigger mode

To acquire images in external trigger mode, input an external trigger pulse as shown below. When the time Tvd has passed after the rising edge of the external trigger pulse, synchronous signals and video signals are output.

When used in synchronization with a pulsed X-ray source, X-rays should be irradiated during the Txray period.

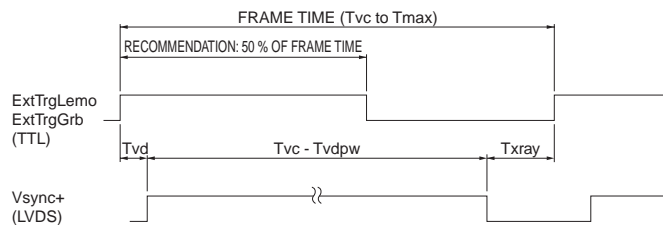

Hsync+, Pclk+ and Data 1-12 are the same as internal trigger mode.
 · Tmax is defined as the reciprocal of the minimum value of Sf (ext).
 · Txray = FRAME TIME - Tvd - (Tvc - Tvdpw)

KACCC0341EB

(Typ.)

Parameter	Symbol	Value	Unit
Vsync	Delay time (only external trigger mode)	Tvd	190 μs
	Cycle time (internal trigger mode)	Tvc	124 ms
	Dummy pulse width	Tvdpw	400 μs

Note: The numbers of significant figures is two. (except Tvc)

■ System requirements

To operate C9312SK-06 at full performance, the following system and peripherals are required.

- PC: IBM compatible PC running on Windows XP
- Digital frame grabber card: Monochrome 32 bits or more, pixel clock 33.3 MHz or more, LVDS interface synchronous signal (See the frame grabber manual.)
- Power source: A. vdd = +5.0 ± 0.1 V (1.8 A), D. vdd = +5.0 ± 0.1 V (0.5 A).

Please use a series power supply. (Avoid using a switching power supply.) A power cable (terminated with an DB-25SF-N plug with right angle type shell at one end and open at the other end; 2 m; see Table 2.), an external trigger cable (terminated with an FFA.OS.302.CLAC37 plug at one end and open at the other end; 5 m; see table 3.) and an earth cable (AWG 18; 4 m) comes supplied with C9312SK-06. An optional frame grabber cable for interface with the 80-pin receptacle (see Table 1) on C9312SK-06 is also available for synchronous signal, video output and external control.

The voltages described above are specified at the flat panel sensor side. The impedance of the power cable attached with the flat panel sensor is low enough but it causes 0.1 V approx. drop. Therefore the voltage at the power source side should be set 0.1 V higher than the voltage specified above. Install a noise filter on the AC power input line to prevent surges on the AC line. To supply the synchronous signal through ExtTrgGrb, apply high level of TTL to ExtTrgLemo and IntExt, or leave them without connection. On the contrary, to use ExtTrgLemo, set high level to ExtTrgGrb and IntExt, or leave them without connection. The earth terminal must be connected to a stable earth point to eliminate noise from surroundings.

Table 1: Pin assignment of 80-pin receptacle

Pin No.	Signal	Pin No.	Signal
1	A_Data1+ (LSB)	41	B_Data1+ (LSB)
2	A_Data1- (LSB)	42	B_Data1- (LSB)
3	A_Data2+	43	B_Data2+
4	A_Data2-	44	B_Data2-
5	A_Data3+	45	B_Data3+
6	A_Data3-	46	B_Data3-
7	A_Data4+	47	B_Data4+
8	A_Data4-	48	B_Data4-
9	A_Data5+	49	B_Data5+
10	A_Data5-	50	B_Data5-
11	A_Data6+	51	B_Data6+
12	A_Data6-	52	B_Data6-
13	A_Data7+	53	B_Data7+
14	A_Data7-	54	B_Data7-
15	A_Data8+	55	B_Data8+
16	A_Data8-	56	B_Data8-
17	A_Data9+	57	B_Data9+
18	A_Data9-	58	B_Data9-
19	A_Data10+	59	B_Data10+
20	A_Data10-	60	B_Data10-
21	A_Data11+	61	B_Data11+
22	A_Data11-	62	B_Data11-
23	A_Data12+ (MSB)	63	B_Data12+ (MSB)
24	A_Data12- (MSB)	64	B_Data12- (MSB)
25	Reserved	65	Reserved
26	Reserved	66	Reserved
27	Reserved	67	Reserved
28	Reserved	68	Reserved
29	Reserved	69	Reserved
30	Reserved	70	Reserved
31	Reserved	71	Reserved
32	Reserved	72	Reserved
33	IntExt (TTL)	73	ExtTrgGrb (TTL)
34	Reserved	74	Reserved
35	Vsync+	75	Reserved
36	Vsync-	76	Reserved
37	Hsync+	77	Reserved
38	Hsync-	78	Reserved
39	Pclk+	79	GND
40	Pclk-	80	GND

Unless otherwise noted signal, signal level is LVDS.

80-pin receptacle: PCS-E80LMD made by Honda Tsushin Kogyo Co., Ltd.

Mating plug: PCS-E80FA made by Honda Tsushin Kogyo Co., Ltd.

Pins described "Reserved" are prepared for an extension of the future.

Do not connect any signal or power or GND, etc. to this plug.

Table 2: Power pin assignment

Pin No.	Signal	Cable color	Marking color	Pin No.	Signal	Cable color	Marking color
1	NC	Brown		14	NC	Red	
2	NC	Orange		15	Analog GND	Yellow	
3	Analog GND	Green		16	Analog GND	Blue	
4	Analog +5 V	Purple		17	Analog +5 V	Gray	
5	Analog +5 V	White		18	Digital GND	Black	
6	Digital GND	Brown	White	19	Digital GND	Red	White
7	Digital +5 V	Orange	White	20	Digital +5 V	Yellow	White
8	Digital +5 V	Green	White	21	Reserved	-	-
9	Reserved	-	-	22	Reserved	-	-
10	Reserved	-	-	23	Reserved	-	-
11	Reserved	-	-	24	Reserved	-	-
12	Reserved	-	-	25	Reserved	-	-
13	Reserved	-	-				

NC: no connection

25-pin receptacle: DBLC-J25PAF-10L6 made by JAE (Japan Aviation Electronics Industry limited)

Mating plug: DB-25SF-N made by JAE

Table 3: External trigger pin assignment and cable color

Pin No.	Signal	Color
1	ExtTrgLemo (TTL)	Red
2	Signal GND	Black

2-pin receptacle: ECP.0S.302.CLL made by LEMO S. A.

Mating plug: FFA.0S.302.CLAC37 made by LEMO S. A.

■ Connection

Install the frame grabber board into the PC by the manufacturer's instructions. When a general-purpose frame grabber board is used, trigger operation for IntExt and ExtTrgGrb can be controlled with its digital I/O control.

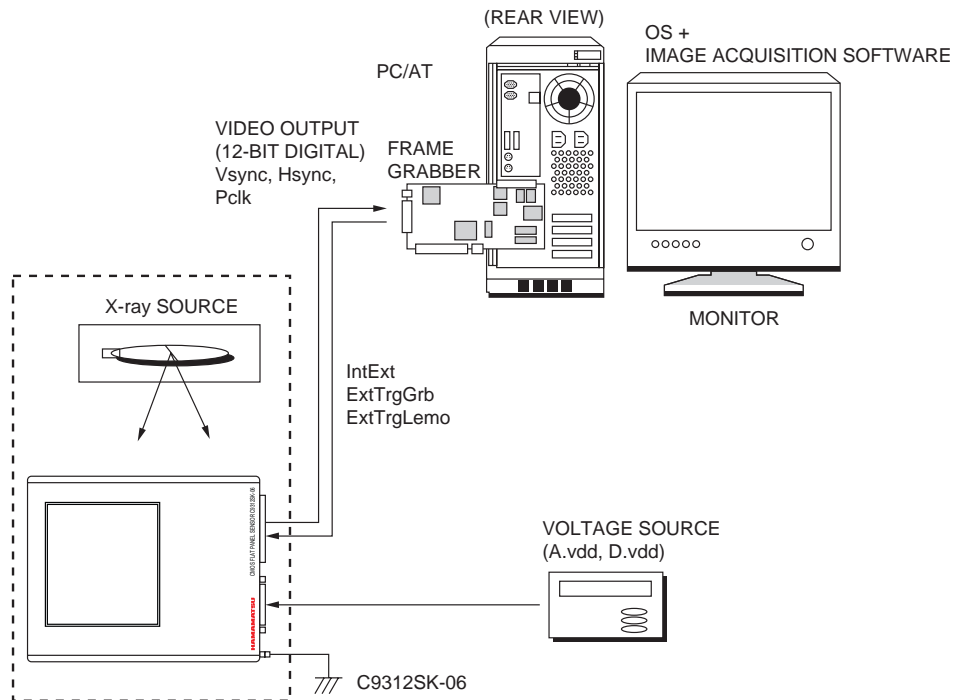

KACCC0353EA

■ Dimensional outline (unit: mm, tolerance: ±1 mm unless otherwise noted)

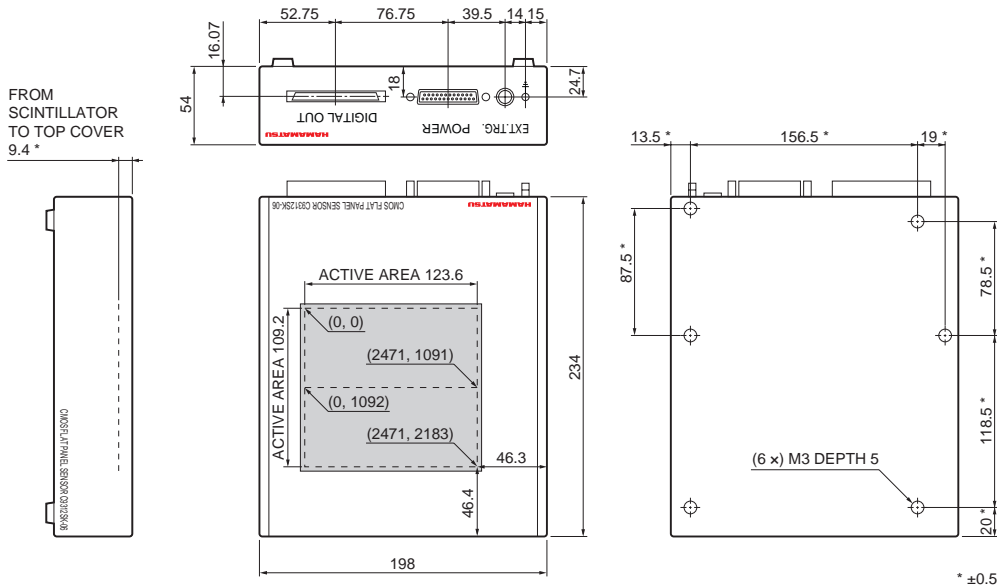

Top cover is made of carbon fiber (1.0 mm thickness)
Weight: 5.6 kg

111CCA0200EA

■ Notice

- Do not subject the Flat Panel Sensors to strong vibration or shock. (Strong shock such as drop impacts may cause permanent damage to these sensors.)
 - Users must take responsibility for implementing X-ray shielding safety measures to avoid the risk of X-ray exposure.
 - Data listed in this datasheet is defined at the time of shipment. Characteristics may vary somewhat due to exposure to X-rays so take proper countermeasures such as making periodic image correction.
 - This product is warranted for a period of 12 months after the date of the shipment. The warranty is limited to replacement or repair of any defective product due to defects in workmanship or materials used in manufacture. The warranty does not cover loss or damage caused by natural disaster, misuse (including modifications and any use not complying with the environment, application, usage and storage conditions described in this datasheet), or total radiation dose over 6 million Roentgen (less than 110 kVp) even within the warranty period.
 - As described above, flat panel sensors have limited resistance to radiation. This must be taken into account when using a flat panel sensor under continuous irradiation (in-line non-destructive inspection, etc.)
- When using flat panel sensors in non-destructive inspection equipment, please contact us and provide information such as irradiation conditions.



C9312SK-06 conforms to European EMC directives:
EN61326 Class A.

■ Frame grabber cables

Frame grabber	Cable type No.	Cable length	Cable end	Cable end
General-purpose	A8406-41	5 m	PCS-E80FA *8	open
	A8406-46	7 m		
	A8406-47	10 m		
	A8406-48	12 m		
IMAQ PCI-1424 *7	A8406-42	5 m		PCS-XE100MA+ *8
	A8406-43	7 m		
	A8406-44	10 m		
	A8406-45	12 m		

*7: Made by NI (National Instruments Corporation)

*8: Made by Honda Tsushin Kogyo Co., Ltd.

Note: The detailed information for these optional cables is shown in the datasheet of A8406 series.

HAMAMATSU
HAMAMATSU PHOTONICS K.K., Solid State Division

1126-1 Ichino-cho, Higashi-ku, Hamamatsu City, 435-8558 Japan, Telephone: (81) 53-434-3311, Fax: (81) 53-434-5184, www.hamamatsu.com

U.S.A.: Hamamatsu Corporation, 360 Foothill Road, P.O.Box 6910, Bridgewater, N.J. 08807-0910, U.S.A., Telephone: (1) 908-231-0960, Fax: (1) 908-231-1218

Germany: Hamamatsu Photonics Deutschland GmbH, Arzbergerstr. 10, D-82211 Herrsching am Ammersee, Germany, Telephone: (49) 08152-3750, Fax: (49) 08152-2658

France: Hamamatsu Photonics France S.A.R.L.: 19, Rue du Saule Trapu, Parc du Moulin de Massy, 91882 Massy Cedex, France, Telephone: 33-(1) 69 53 71 00, Fax: 33-(1) 69 53 71 10

United Kingdom: Hamamatsu Photonics UK Limited: 2 Howard Court, 10 Tewin Road, Welwyn Garden City, Hertfordshire AL7 1BW, United Kingdom, Telephone: (44) 1707-294888, Fax: (44) 1707-325777

North Europe: Hamamatsu Photonics Norden AB: Smidsvägen 12, SE-171 41 Solna, Sweden, Telephone: (46) 8-509-031-00, Fax: (46) 8-509-031-01

Italy: Hamamatsu Photonics Italia S.R.L.: Strada della Moia, 1/E, 20020 Arese, (Milano), Italy, Telephone: (39) 02-935-81-733, Fax: (39) 02-935-81-741