

Digital Camera C11440-22C Instruction manual

Thank you for your purchase

 CAUTION	<ul style="list-style-type: none">• Follow the safety precautions in Chapter 1 in order to avoid personal injury and damage to property when using this camera. Be sure to read this Instruction manual beforehand in order to use the digital camera correctly. The manual describes the correct method of handling the camera and provides cautions in order to avoid accidents.• After reading, keep the manual where it can be referred to at any time.
--	--



Ver.1.4
July 2012

HAMAMATSU PHOTONICS K.K.

1. SAFETY PRECAUTIONS







1-1 INDICATION OF THE SYMBOLS

The following symbols can be found on this camera:

	Direct current
	Alternating current

1-2 CLASSIFICATION OF WARNING

We have classified the warnings symbols that appear in this instruction manual and on the camera as follows for your convenience. Make sure that you fully understand them and obey the instructions they contain.

 WARNING	Improper handling of the camera without observing these warnings could lead to serious injury to the user and even death.
 CAUTION	Improper handling of the camera without observing these cautions could lead to personal injury to the user or damage to property.
 Note	This symbol indicates a note to help you get the best performance from the camera. Read the contents of the note carefully to ensure correct and safe use. Failure to observe one of these notes might impair the performance of the camera.
	This symbol indicates a cautionary item that should be obeyed when handling the camera. Read the contents carefully to ensure correct and safe use.
	This symbol indicates an action that is forbidden. Read the contents carefully and be sure to obey them.
	This symbol indicates a compulsory action or instruction. Read the contents carefully and be sure to obey them.

 **WARNING**



Power supply

Use the camera with the voltage indicated on the rating sticker. Using a different voltage can damage the camera and lead to fire or electric shock.



Cables

Be careful not to place heavy objects on cables or bend it excessively. Doing so can damage the cable and lead to fire or electric shock.



Power supply cord

Use the accessory of the AC adaptor when this camera is used.



Do not touch the plug with wet hand. Doing so can lead to electric shock.



Do not attempt to dismantle or modify the camera

Doing so can also lead to damage and even injury, as some internal components become very hot. Only touch parts as indicated in this manual.



Do not insert a foreign substance into the camera

Do not allow foreign objects such as combustible substances, metal objects or water to get inside the camera. They can damage the camera and lead to fire or electric shock.



If an abnormality occurs

Such as the image suddenly disappearing or a strange noise, smell or see smoke coming from the camera, stop the power supply immediately and contact Hamamatsu subsidiary or local distributor. Never attempt to repair the camera yourself.

 **CAUTION****AC adaptor**

When unplugging the AC adaptor, always pull by the plug, not the cord. Doing so can lead to fire or electric shock.



Remove the AC adaptor from the outlet when not using the camera for long periods of time. Doing so can damage the cable and lead to fire or electric shock.

**Connecting and disconnecting cables**

Always turn off the power supply of the peripheral device before connecting and disconnecting cables.

**Fixed the camera**

When fitting the camera to a tripod or other fixture, use the optional base plate. Be careful that the fitting screw does not enter more than 8 mm from the surface of the base plate. Screwing it in excessively can impair normal operation.

**Lenses**

Be careful not to screw the lens more than 7 mm onto the C-mount of the camera. Doing so can scratch the protective glass. (Some wide-angle lenses in particular can have a thread of 7 mm or more.)

**Shipping precautions**

When transporting the camera by truck, ship, airplane, etc., wrap it securely in packaging material or something similar.

**Strong impact**

Do not subject the camera to strong shocks by dropping it, for example. Doing so can damage the camera.

**At the water cooling**

Be careful water does not splash on the camera. Cut off the power supply of the circulating water cooler and the camera when you remove and install the cooling water hoses.

**Operating environment**

This system is designed and tested for use in an industrial environment. If this system is used in residential areas, EMI (electro-magnetic interference) may occur. This system must not be used in residential areas.

⚠ CAUTION**Disposal**

When disposing of the camera, take appropriate measures in compliance with applicable regulations regarding waste disposal and correctly dispose of it yourself, or entrust disposal to a licensed industrial waste disposal company. In any case, be sure to comply with the regulations in your country, state, region or province to ensure the camera is disposed of legally and correctly.

**Cooling water**

It is recommended to use soft water (except deionized water) for cooling water. Follow instruction manual which is attached to your circulating water cooler for an appropriate temperature range of cooling water. If you plan on using water other than soft water as recommended for example antifreeze etc, please refer to description of cooling water which is written in 12. [Maintenance] or contact Hamamatsu subsidiary or local distributor.

**Condensation**

At the Water-cooling, if ambient temperature and ambient humidity become high, condensation will take place easily. Use the camera under the environment where condensation will not take place referring to the following graph.

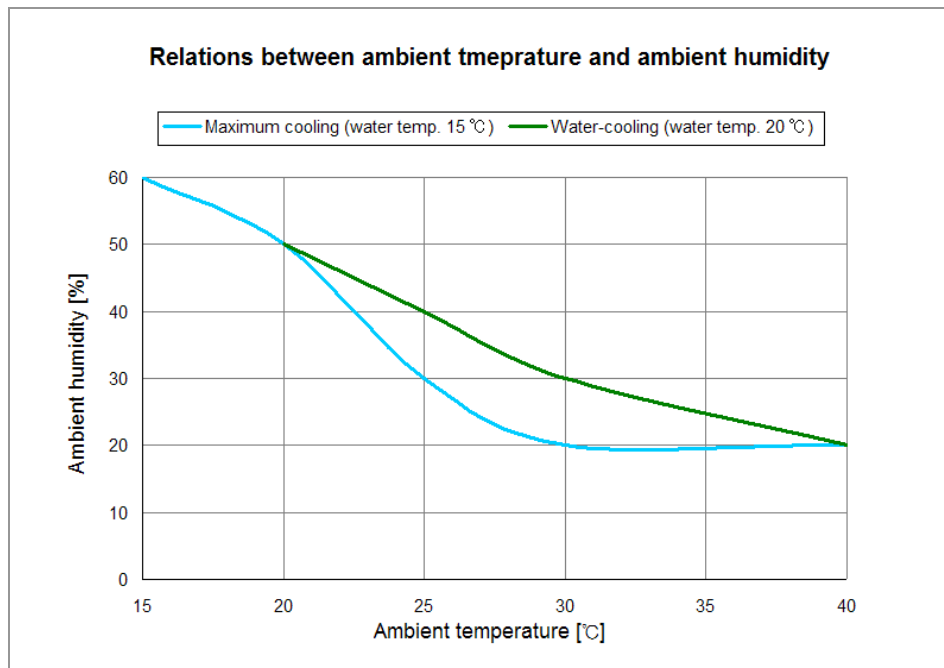

2. CHECK THE CONTENTS OF PACKAGE

When you open the package, check that the following items are included before use. If the contents are incorrect, insufficient or damaged in any way, contact your local dealer without attempting to operate the camera.

C11440-22C camera	1
AC adaptor	1
Power supply cord for AC adaptor	1
Lens mount cap (attached to the camera)	1
C11440-22C Before Use (This Booklet)	1
C11440-22C Instruction manual (CD-ROM)	1

[Option]

Circulating water cooler	C3142-07
Cooling water hose (2 hoses)	A10788-04
External trigger cable for SMA-BNC	A12106-05
External trigger cable for SMA-SMA	A12107-05
CameraLink interface cable	A11255-05
Adjuster pole	A11185-01
Base plate	A11186-01
CameraLink interface board	M9982-20

Note

- The cable listed in option is highly recommended for use with the camera. The camera system may not conform to CE marking regulation if other type of cable is used with.

Note

- The cooling is set as air cooling at factory setting. It is possible to change the cooling setting from Air cooling to Water cooling by the special software included.



- Handle the circulating water cooler and the cooling water according to an instruction manual of the circulating water cooler.

Note

- If you use the adjuster pole and the base plate, see each installation manual.

3. INSTALLATION

Avoid using or storing this camera in the following places



- Where the ambient temperature might fall below 0 °C or rise above 40 °C
- Where the temperature varies extremely
- In direct sunlight or near a heater
- Where there is dripping water
- Close to a strong source of magnetism or radio waves
- Where there is vibration
- Where it might come into contact with corrosive gases (such as chlorine or fluorine)
- Where there is a lot of dust

How to place the camera (when the camera is placed on a table)



Place the camera the water connectors to be lateral side.



Do not place the camera the rear panel of the camera, which connectors are located, to be at the bottom. (Do not block ventilation openings.)

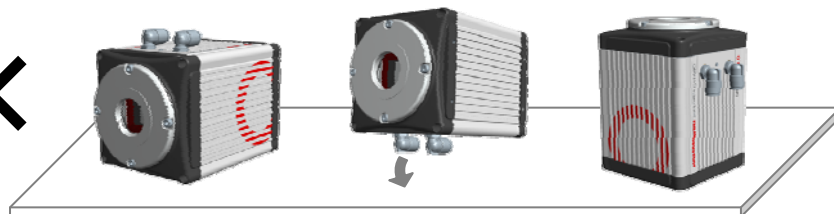
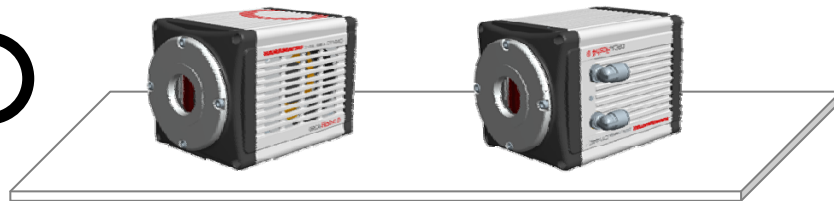

Do not block ventilation openings



To prevent overheating in the camera's interior, do not wrap the camera in cloth or other material, or in any way allow the camera's ventilation ports to become blocked. If the camera is being operated in an enclosed environment, ensure clearance of at least 2 cm from both the intake and exhaust vents when setting up.

Weight of the camera



Be careful not to drop off the camera or not drop underfoot when making it move because it is approx. 2 kg.

Contents

1. SAFETY PRECAUTIONS	1
1-1 INDICATION OF THE SYMBOLS	1
1-2 CLASSIFICATION OF WARNING	1
2. CHECK THE CONTENTS OF PACKAGE	5
3. INSTALLATION	6
4. OVERVIEW	9
5. FEATURES	10
6. NAME AND FUNCTION OF THE PARTS	12
7. CONNECTION	14
7-1 CONNECTING OF CABLES	14
8. WATER COOLING	16
8-1 CAUTIONS	16
8-2 CONNECTION OF WATER COOLING HOSES.....	18
8-3 DISCONNECTION OF WATER COOLING HOSES.....	19
9. OPERATION	20
9-1 PRECAUTIONS.....	20
9-2 PREPARATION FOR IMAGING.....	21
9-2-1 WHEN USING AIR-COOLING.....	21
9-2-2 WHEN USING WATER-COOLING.....	21
9-3 END OF IMAGING.....	21
10. DESCRIPTION OF VARIOUS FUNCTIONS	22
10-1 THEORY OF CMOS IMAGE SENSOR	22
10-2 READOUT METHOD (SCAN MODE)	24
10-3 CONFIGURING EXPOSURE TIME	25
10-4 FREE RUNNING MODE.....	26
10-4-1 NORMAL READOUT MODE	26
10-4-2 ELECTRICAL SHUTTER MODE.....	26
10-5 EXTERNAL CONTROL MODE	27
10-5-1 EDGE TRIGGER MODE	27
10-5-2 LEVEL TRIGGER MODE	28
10-5-3 SYNCHRONOUS READOUT TRIGGER MODE.....	29
10-5-4 START TRIGGER MODE	30
10-5-5 EXTERNAL TRIGGER DELAY FUNCTION.....	30
10-6 TRIGGER OUTPUT.....	31
10-6-1 GLOBAL EXPOSURE TIMING OUTPUT	31
10-6-2 PROGRAMMABLE TIMING OUTPUT.....	31
10-6-3 TRIGGER READY OUTPUT	31
10-7 REAL-TIME CORRECTION FUNCTIONS	32
11. PRECAUTION WHEN USING FL-400	33
12. MAINTENANCE	34
12-1 CARE.....	34

12-2 INFORMATION ON COOLING WATER FOR THE CIRCULATING WATER COOLER	35
12-2-1 WHEN USING COOLING WATER OTHER THAN RECOMMENDED	35
13. TROUBLESHOOTING CHECKLIST	36
13-1 IMAGE IS NOT TRANSFERRED	36
13-2 ALTHOUGH IMAGES ARE TRANSFERRED	36
14. SPECIFICATIONS	37
14-1 CAMERA SPECIFICATIONS	37
14-2 CONDENSATION	39
14-3 SPECTRAL RESPONSE CHARACTERISTICS	39
14-4 INTERFACE SPECIFICATIONS	40
14-4-1 CAMERALINK INTERFACE	40
14-4-2 OUTPUT TIMING SPECIFICATIONS	43
15. DIMENSIONAL OUTLINES	47
16. WARRANTY	48
17. CONTACT INFORMATION	49

4. OVERVIEW

At its core, C11440-22C is equipped with the new scientific image sensor FL-400, an advanced CMOS device that finally realizes the multiple benefits of high resolution, high readout speed, and low noise all at once.

C11440-22C provides 4.0 megapixel resolution at 100 frames/s (and up to 25 655 frames/s by sub-array readout) while achieving 1.3 electrons readout noise performance. Moreover, the camera delivers high sensitivity through its on-chip micro lens, 23 000:1 high dynamic range that make the camera suitable for almost any scientific application from bright field imaging to low-light fluorescence imaging across a wide spectral range. Various external trigger functions and timing output functions ensure proper timing control with peripheral equipment to cover a wide range of applications.

C11440-22C is the new scientific digital camera for life science microscopy, semiconductor inspection, x-ray scintillator readout or industrial imaging.

5. FEATURES

(1) Readout noise

In the camera, the pixel amplifier is optimized: it has high gain from optimizing the semiconductor process, and the difference among pixel amplifiers is greatly minimized. In addition, there is the on-chip CDS (correlated double sampling) circuit, which plays an important role in achieving low noise. Moreover, the sensor features a split readout scheme in which the top and bottom halves of the sensor are readout independently, and the data of each horizontal line is read by 2 lines of column amplifier and A/D in the top and the bottom in parallel and simultaneously. As a result, it achieves very fast readout speed while keeping very good low-noise performance.

The camera has lower readout noise (1.3 electrons) than the conventional cooled CCD camera. Moreover, high-speed readout (100 frame/s with 2048 pixels × 2048 pixels) with very low readout noise, which was impossible, can now be achieved.

(2) Cooling structure

In the camera, the FL-400 is cooled down by the peltier element to suppress the dark current. If FL-400 is exposed to the atmosphere, condensation of the moisture from the air might occur. The camera has a special hermetic chamber structure to isolate the sensor from the atmosphere, and the chamber is filled with nitrogen gas.

(3) Pixel number and pixel size

The FL-400 equipped in the camera has 6.5 μm x 6.5 μm pixel sizes that is the same as the conventional CCD image sensor (2/3 inch, 1.3 megapixels). Also, the camera can observe a wider field of view because the pixel number is about 3 times that of the conventional CCD image sensor (2/3 inch, 1.3 megapixels)

(4) Readout method

The camera has a variety of readout modes. In addition to full resolution readout mode, sub-array readout and binning readout are supported.

(5) Frame rate (readout speed)

The FL-400 realizes both low noise (1.3 electrons) and high speed readout (100 frame/s with 2048 pixels x 2048 pixels) simultaneously, owing to a split readout scheme in which the top and bottom halves of the sensor are readout independently, and the data of each horizontal line is read by 2 lines of column amplifier and A/D in the top and the bottom in parallel and simultaneously.

(6) Real-time correction functions

When using the camera, there is a chance that shading caused by uneven illumination and optics is not negligible in the image. Also, there are a few pixels in FL-400 that have slightly higher readout noise performance compared with surrounding pixels. Therefore, the camera has real-time offset level, shading and defective pixel correction features to further improve image quality. The correction is performed in real-time without sacrificing the readout speed at all.

(7) CameraLink interface

The camera realizes 100 frames/s high-speed data transfer for 4.0 megapixels by using the CameraLink interface. Data is output with 85 MHz x 10 tap (8 bit) that follows the CameraLink full configuration Deca mode, and images can be transferred into a personal computer by using a CameraLink interface board available in the market.

(8) Camera operation modes

The camera has two operation modes: 1) the free running mode, in which the exposure and readout timing are controlled by the internal microprocessor, and 2) the external control mode, in which the exposure and readout timing are decided by an external trigger.

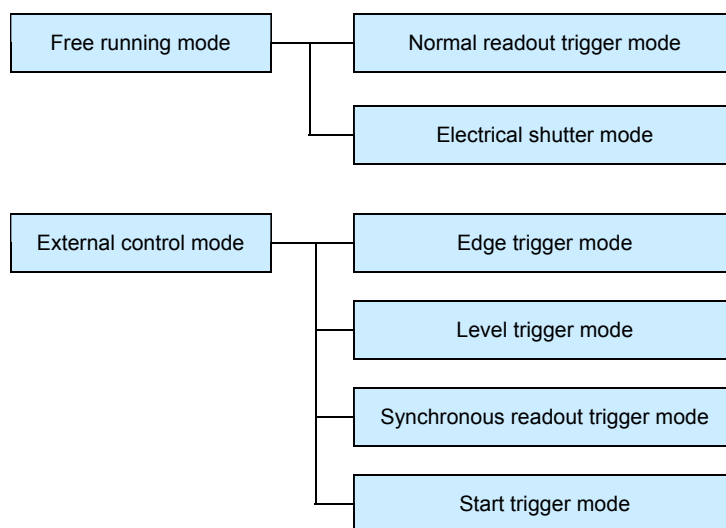

6. NAME AND FUNCTION OF THE PARTS

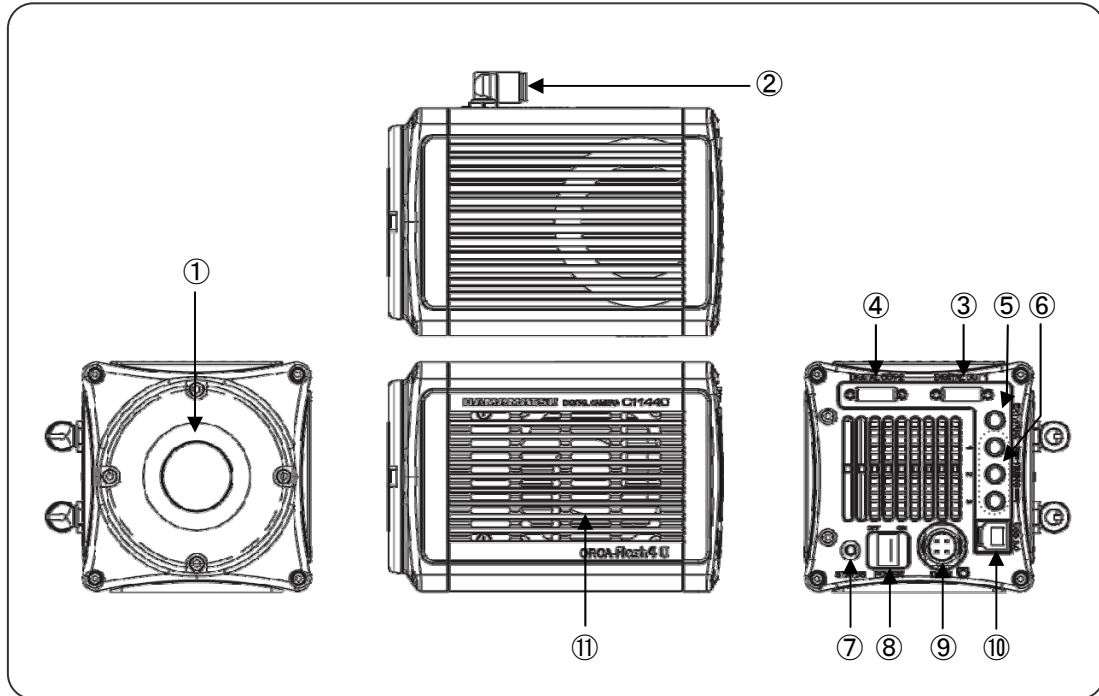

Figure 6-1

CAUTION

- Place the camera the water connectors to be lateral side. Do not place the camera the rear panel of the camera, which connectors are located, to be at the bottom (Do not block ventilation openings.).

① Lens mount

C-mount lens or an optics system with C-mount can be attached.

Note

- The depth of the C-mount is 7 mm. Screwing in the mount too far can scratch the glass surface.

② WATER connector [WATER] (at Water-cooling)

This is for coolant. It connects the camera and the cooler for circulating water with the cooling water hoses. The insert position of WATER IN/OUT is not specified.

CAUTION

- Please see 8. [Water cooling] for details.

③ CameraLink interface connector [DIGITAL OUT 1]

This is connected to the connector 1 of CameraLink interface board in the host computer.

④ CameraLink interface connector [DIGITAL OUT 2]

This is connected to the connector 2 of CameraLink interface board in the host computer.

⑤ Trigger input connector [EXT.TRIG]

This is used when the camera is being operated using external synchronization.
 Input is 3.3 V LVCMOS level, and input impedance is 10 kΩ.
 When an external trigger is input, the trigger is activated at the falling or rising edge of the signal. (You can choose external trigger polarity between Negative and Positive.)

⑥ Timing out connector 1,2,3 [TIMING 1,2,3]

This is used when peripheral device(s) require synchronization with the camera.
 Output is 3.3 V LVCMOS level, and it is output through BUS TRANSCEIVER IC SN74AVC8T245. Output impedance is 33 Ω.

Note

- Determine termination according to cable length and so on.

⑦ STATUS lamp [STATUS]

The LED indicates status of camera.

Lighting color	Status of power distribution
Turn off (no color)	Power off
Green (lighting)	Power on
Orange (lighting)	Data transfer
Red (lighting)	Heat up
Orange or Green (blinking)	Cooler progressing (in Standard air-cooling mode)

⚠ CAUTION

- When the camera heats up, stop operation and unplug the AC adaptor immediately.

⑧ Power switch [POWER]

The power is turned on/off.
 When the power switch is set to "ON", the camera turns on and the lamp color is green.
 When the camera transfers data and the lamp color is orange.
 When the power switch is set to "OFF", the camera returns to the power off state and the lamp turns off.

⑨ DC power input connector [DC IN]

This is the power supply terminal. Use the accessory AC adaptor.

⑩ USB connector [USB3.0]

- This is not used with the camera. Do not connect it.

⑪ Air outlet

This is the outlet for the heat ventilation.



- To prevent overheating in the camera's interior, do not wrap the camera in cloth or other material, or in any way allow the camera's ventilation ports to become blocked.



- If the camera is being operated in an enclosed environment, ensure clearance of at least 2 cm from both the intake and exhaust vents when setting up.

7. CONNECTION

7-1 CONNECTING OF CABLES

Refer to the figure when connecting the various cables.

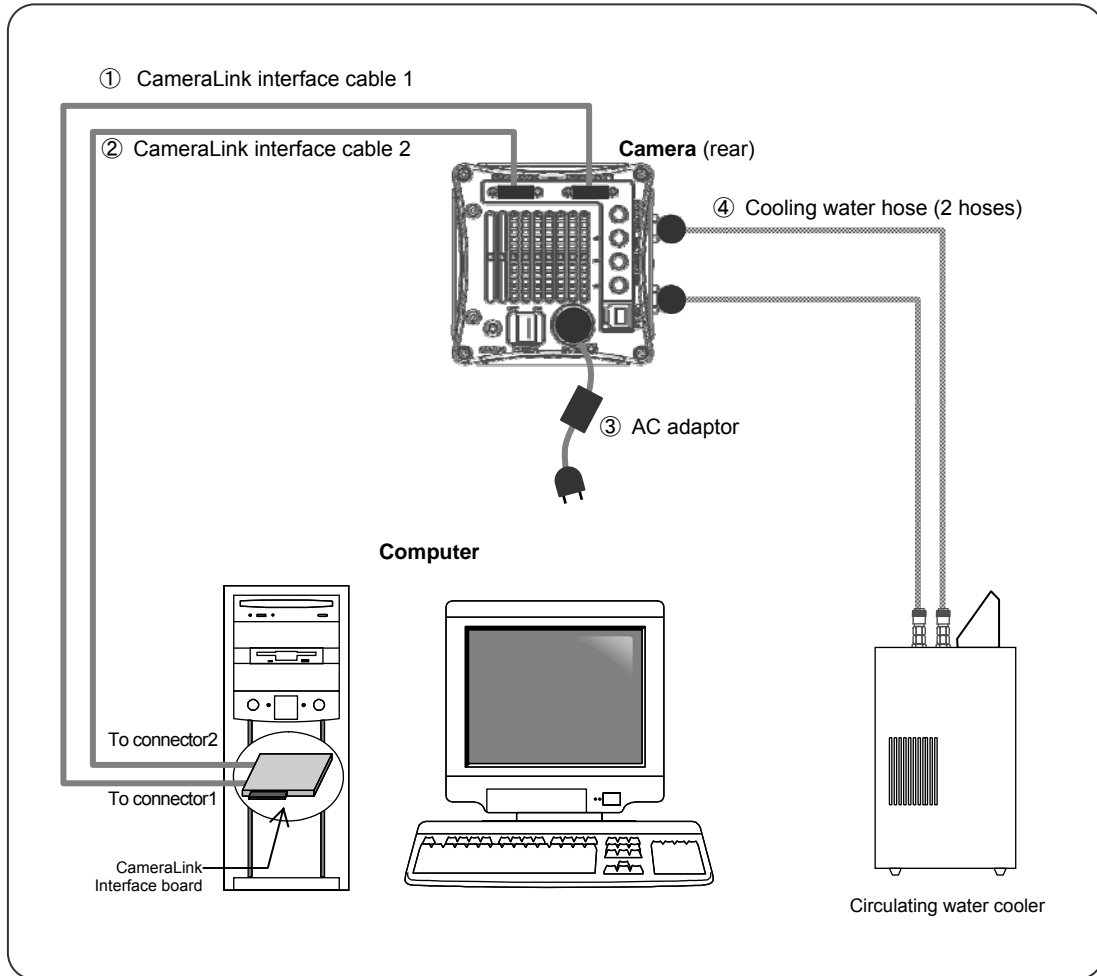

Figure 7-1



- When you connect cables, turn off the power supply of the camera and the peripheral devices.

Note

- If you use the adjuster pole and the base plate, see each installation manual.

CAUTION

- Place the camera the water connectors to be lateral side. Do not place the camera the rear panel of the camera, which connectors are located, to be at the bottom (Do not block ventilation openings.)

① CameraLink interface cable 1 (Option)

This is the cable to connect the camera and the connector 1 of CameraLink interface board on the computer.

② CameraLink interface cable 2 (Option)

This is the cable to connect the camera and the connector 2 of CameraLink interface board on the computer.

Note

- Hamamatsu recommends A11255-05 optional CameraLink interface cable for this camera. The camera complies with EMC direction with using A10514-05 CameraLink interface cable. Be careful that the camera with other interface cable may not fulfill the EMC directive requirements.

③ AC adaptor

This is the cord to supply a power supply. Use the accessory AC adaptor.

④ Cooling water hose (at Water-cooling: Option)

This is for coolant. It connects the camera and the cooler for circulating water. The insert position of WATER IN/OUT on the camera WATER connector is not specified.

**CAUTION**

- Please see 8. [Water cooling] for details.

8. WATER COOLING



CAUTION

- Improper handling of the camera without observing these cautions could lead to personal injury to the user or damage to property.

8-1 CAUTIONS

(1) Cooling water

It is recommended to use soft water (except deionized water) for cooling water. If you plan on using water other than soft water as recommended for example antifreeze etc, please refer to description of cooling water which is written in 12. [Maintenance] or contact Hamamatsu subsidiary or local distributor.

(2) Recommendation ambient temperature

Hamamatsu recommends 20 °C for Circulating water temperature. For the appropriate temperature range of the cooling water, confirm with the instruction manual of your circulating water cooler.

(3) Condensation

Use the camera under the environment where condensation will not take place referring to the following graph.

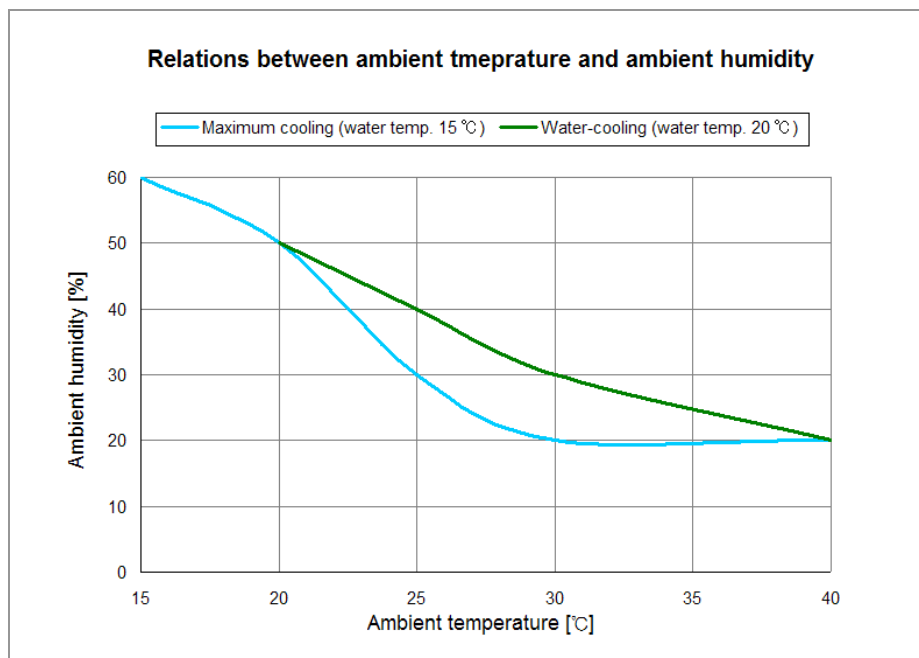

(4) Handling of the circulating water cooler

Handle the circulating water cooler and the cooling water according to an instruction manual of the circulating water cooler. Proper performance may not be achievable if a non-recommended circulating water cooler is used.

(5) Start water cooling and water cooling in operation

- Confirm the water is flowing before starting the camera cooling and that the camera does cool.
- Keep 1.0 L/min flow rate or 0.25 MPa water pressure for water circulation.
- Do not stop coolant while the camera is working.

(6) Cooling water hose

The hose has a blue hose (Internal diameter: 4 mm / External diameter: 6 mm) and a gray hose (Internal diameter: 8 mm / External diameter: 13.5 mm). (Figure 8-1)
If the hose size on circulating water cooler is same as blue hose, remove gray hose from the joint part. The gray hose can be removed when blue hose is pulled with pushing the button of the joint on gray hose. (Figure 8-2)

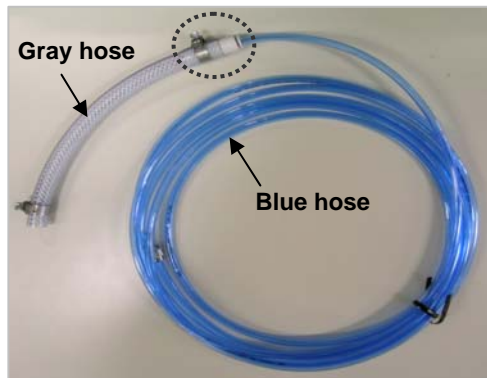

Figure 8-1

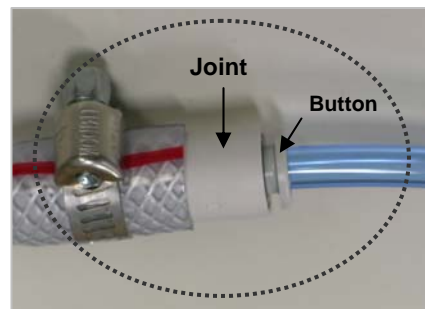

Figure 8-2

(7) Connection of Cooling water hose**⚠ CAUTION**

- Follow the instruction in Section 8-2 [CONNECTION OF WATER COOLING HOSES] and Section 8-3 [DISCONNECTION OF WATER-COOLING HOSES] to connect / disconnect the hose.

- Stop water circulation when connecting / disconnecting the hose, and turn off the power of the camera and the circulating water cooler.
- Confirm that cooling water stops.
- Prepare water absorption sheet (such as Waste, Towel or so) and catch pan in order to avoid water drop or water splash.

(8) Deterioration of Cooling water hose

Replace the water hose with a new one whenever it cannot keep the Keep 1.0 L/min flow rate or 0.25 MPa water pressure for water circulation due to the hose deterioration.

8-2 CONNECTION OF WATER COOLING HOSES

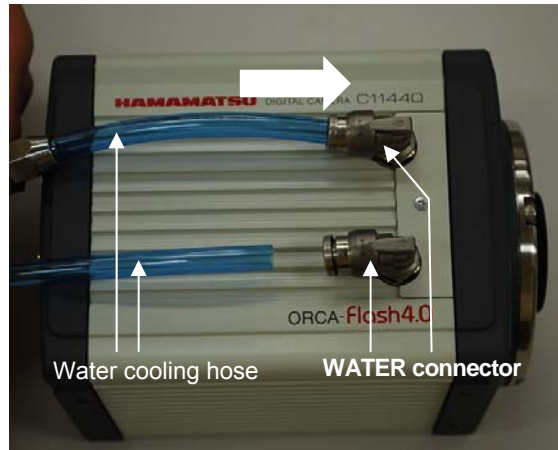

Figure 8-3

- (1) Place the camera on the stable table.
- (2) Connect water cooling hose into the WATER connector on the camera.
 - Insert the hose fully into the WATER connector on the camera (as shown in Figure 8-3)
 - Confirm the hose stops at it.
- (3) Set the camera onto a microscope (If the camera is used on the microscope).

If it is easy to connect the hose onto the camera after the camera is set onto the microscope then it is OK to connect the hose after the camera is set on the microscope.
- (4) Connect the hose onto the circulating water cooler.
 - Follow the instruction on the circulating water cooler when you connect the hose onto the circulating water cooler.
- (5) Turn on the circulating water cooler and confirm the cooling water is flowing normally.

⚠ CAUTION

- Stop the circulating water cooler when the water flow is abnormal or water drop or splash is found.

8-3 DISCONNECTION OF WATER COOLING HOSES



- Remove the water cooling hoses only when it is necessary to remove.

- (1) Turn off the camera power and all peripheral devices (including circulating water cooler).
- (2) Remove the hose on circulating water cooler side.
 - Follow the instruction on the circulating water cooler when you disconnect the hose from the circulating water cooler.
- (3) Remove water or water drop inside the hose and the camera by air.
 - Blow Air from one side of hose. Prepare water absorption sheet (such as Waste, Towel or so) and catch pan on another side of hose in order to avoid water drop or water splash.
 - Blow Air until no water drop come out.
- (4) Remove the camera from the microscope (if the camera is used on the microscope).
It is not necessary to remove the camera from the microscope if it is possible to remove the hoses from the camera as it is.
- (5) Place the camera on the stable table.
 - Put the lens cap on to protect the sensor.
- (6) Change the WATER connector direction to be downward.
 - Prepare water absorption sheet (such as Waste, Towel or so) and catch pan.
- (7) Remove hoses one by one, and wipe water.
 - Disconnect hoses with pushing button while being careful not to splash water.



Figure 8-4

CAUTION

- Cooling water may be left inside the camera even after hoses are removed. In such case, remove water inside by blowing air from connectors. Be careful not to splash water onto the camera.

9. OPERATION

9-1 PRECAUTIONS

Be careful of the following when you operate the camera.

(1) Cooling method

Cooling of this equipment is done using a Peltier element. With a Peltier element, when current is supplied, one surface is cooled, and the other surface is heated. The FL-400 is positioned on the cooling side, and cooling is done by discharging the heat from the heated surface.

The camera has three cooling modes, Standard air-cooling mode, Rapid air-cooling mode and Water-cooling mode. Cooling mode can be changed by a software which is called, "phxver.exe". After cooling mode was changed, the camera memorizes the last setting as the default setting for cooling. The present cooling mode set-up of this camera can be checked using "phxver.exe".

Note

- A software "phxver.exe" is in a CD-ROM of DCAM software July 2012 version and after.

Cooling method	Cooling mode	Detail
Air-cooling	Standard air-cooling mode (Default)	When the camera is turned on, the camera starts cooling. It takes approximately 10 minutes. For that 10 minutes fan does not work and STATUS lamp's light is blinking. (While cooling is progressing (when STATUS lamp's is blinking), it is possible to acquire images however those are not appropriate images to use for measurement.) After 10 minutes when cooling became stable, fan starts working and the STATUS lamp stays on, the camera is ready for acquisition.
	Rapid air-cooling mode	When the camera is turned on, the camera is rapidly cooled. As soon as the camera is turned on, fan starts working and STATUS lamp lights up. The camera will be ready for acquisition quicker than Standard air-cooling mode.
Water-cooling	Circulating water cooler (Optional) is required for water-cooling. (Please refer to 8 [WATER COOLING] for instruction of water-cooling) When camera is turned on, STATUS lamp lights up however fan does not work.	

Note

- Default setting is Standard air-cooling mode.

Note

- If condensation happens on outside of window when using Rapid air-cooling mode, normal cooling mode is recommended.



- Do not switch to water-cooling method when water-cooling is unnecessary.

(2) Ambient temperature

The recommended ambient temperature for camera operation is 20 °C.

Both water-cooling or air-cooling are available as cooling method, FL-400 cooling temperature is more stable under water cooling operation.

(3) Protection circuit

A double protection circuit protects this camera's thermoelectric cooling device. If the heat dissipater becomes abnormally hot, the protection circuit sets off a buzzer alarm from the camera while simultaneously cutting the current supply to Peltier element. When the protection circuit operates like this, immediately turn off the power switch. Then locate and remove the cause of the overheating and restart.

9-2 PREPARATION FOR IMAGING

Use the following procedure when starting operating of the camera.



- When you connect cables, turn off the power supply of the camera and the peripheral devices.



- Please change cooling method (cooling mode) if needed. The present cooling mode set-up of this camera can be checked using phxver.exe.

9-2-1 WHEN USING AIR-COOLING

- (1) Connect the equipment as shown in Figure 7-1 before operating of the camera.
- (2) Turn on the power to the camera.
- (3) Check that the cooling fan is turning properly and that air is circulating.
- (4) Switch to the cooling mode from phxver.exe.

Note

- The cooling temperature becomes stable about 10 minutes after cooling begins.

9-2-2 WHEN USING WATER-COOLING

- (1) Connect the equipment as shown in Figure 7-1 before operating of the camera.
- (2) Turn on the power to the camera.
- (3) Turn on the power to the circulating water cooler.
- (4) Check that cooling water always circulates suitably.

Note

- The cooling temperature becomes stable about 10 minutes after cooling begins.

- (5) Turn on the cooling switch of the camera from application software.

Note

- Please refer to the manual of application software for ON/OFF of the cooling switch of a camera.

9-3 END OF IMAGING

Carry out the procedure below when imaging is finished.

- (1) End the imaging or transmission of image data with the application software.
- (2) Turn off the power to the circulating water cooler. (When set to water-cooled)
- (3) Turn off the power to the camera and peripheral device.

10. DESCRIPTION OF VARIOUS FUNCTIONS

10-1 THEORY OF CMOS IMAGE SENSOR

The pixel of a CMOS image sensor is composed of the photodiode and the amplifier that converts the charge into voltage. The entering light is converted into charge and converted into voltage in the pixel. The voltage of each pixel is output by switching the switch one by one. (Figure 10-1)

The FL-400 scientific CMOS image sensor used in this camera has an on-chip CDS (correlated double sampling) circuit, which plays an important role in achieving low noise. In addition, the FL-400 realizes both low noise and high speed readout simultaneously, owing to a split readout scheme in which the top and bottom halves of the sensor are readout independently, and the data of each horizontal line is read by 2 lines of column amplifier and A/D in the top and the bottom in parallel and simultaneously. The readout starts from 2 lines in the center position and then top half is read from center to top and bottom half is read from center to bottom in parallel and simultaneously.

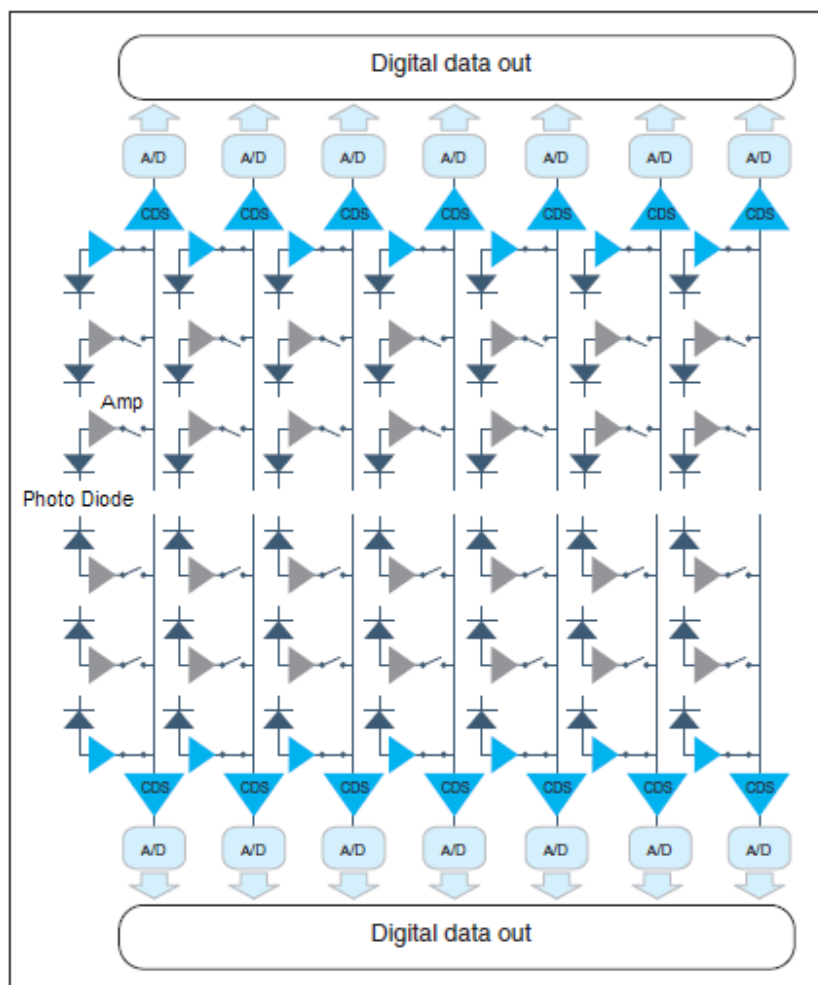

Figure 10-1 Structure of the FL-400

The exposure and the readout method of FL-400 adopt the rolling shutter. In the rolling shutter, the exposure and readout are done line by line. Therefore, the exposure timing is different on one screen. (Figure 10-2) But even if the object moves during the exposure, the affect of rolling shutter shows very little afterglow or smear in many cases.

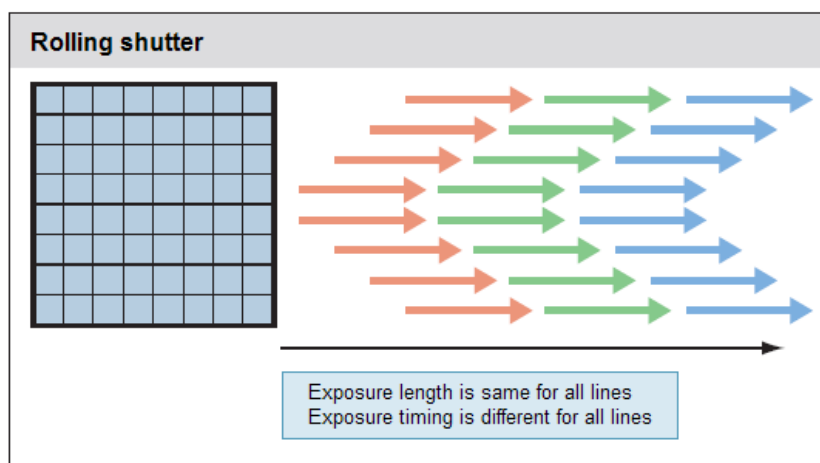

Figure 10-2 Readout timing of Rolling shutter

10-2 READOUT METHOD (SCAN MODE)

(1) Normal readout

Perform charge readout from camera individually for all pixels.
The frame rate of all pixel readout is 100 Hz.

(2) Binning readout

With this camera, 2×2 binning readout and 4×4 binning are available by adding the signal of adjacent pixels in the digital domain, and is a method of achieving high sensitivity as a tradeoff for resolution. The frame rate of all pixel readout is 100 Hz same as normal readout.

(3) Sub-array readout

Sub-array readout is a procedure in which only a region of interest is scanned. It is possible to increase the frame rate by reducing the number of vertical lines scanned. The fastest scan speed is achieved when a sub-array area is set in the center position of the sensor. Sub-array vertical area width and its position can be set with every 4 vertical lines step.

Typical examples of vertical area width and frame rate are shown in the following.

number of pixels	Frame rate at Center position (frame/s)	
	Free running mode	External control mode
2048 × 2048	100	90
2048 × 1024	200	164
2048 × 512	401	278
2048 × 256	802	425
2048 × 128	1603	579
2048 × 64	3207	848
2048 × 8	25 655	877

[Example (in Free running mode)]

When 2048 x 256 pixels area is set completely in the top half area of the sensor or completely in the bottom half area of the sensor the frame rate becomes 401 frames/s regardless of the actual position in the half of the sensor.

It is possible to achieve 802 frames/s if 2048 x 256 pixels area is in the center position of the sensor.

[Calculating formula of the frame rate]

Free running mode	$\frac{1}{Vn/2 \times 9.74 \mu s}$
External control mode	$\frac{1}{(9.74 \times Vn/2) + Exp + 87.66 \mu s}$

Vn = the number of vertical lines (set in the center position of the sensor)

Exp = exposure time (1 ms to 10 s)

Note

- Calculate by inputting Exp into the formula in the unit of μs .

10-3 CONFIGURING EXPOSURE TIME

The exposure time setting can be done by absolute value. The actual exposure time setting is defined by the following formula, and the camera automatically calculate a larger and closest value from the specified exposure time setting.

$$Vn/2 \times 9.74 \mu s$$

Available setting range of the exposure time is the following.

Free running mode	1 ms to 10 s
Free running mode (at Sub-array)	38.96 μs * to 10 s
External control mode (at all)	1 ms to 10 s

Note

* 38.96 μs is the minimum exposure time when sub-array is set to 8 lines vertically symmetric (4 lines in top half and 4 lines in bottom half) with respect to the horizontally center axis. The minimum exposure time vary depend on vertical line number of sub-array setting.

10-4 FREE RUNNING MODE

The camera has the free running mode in which the exposure and readout timing can be set by software command and controlled by the internal microprocessor. The free running mode has normal readout mode (in which the exposure time is longer than the 1 frame readout time) and electrical shutter mode (in which the exposure time is shorter than the 1 frame readout time). These readout modes are automatically switched depending on the exposure time setting.

Note

- The readout frame rate are 100 Hz and 90 Hz in the free running mode and the external control mode respectively. Refer to "Flash4.0 technical note" for the detail of the timing information.

10-4-1 NORMAL READOUT MODE

The normal readout mode is suitable for observation, monitoring, field of view and focus adjustment, and animation because it can operate at 100 fps with full resolution, which is faster than the video rate. In addition, the exposure time can be extended to collect more signals and increase the signal-to-noise ratio if the object is dark. In the normal readout mode, the exposure time is the same or longer than the 1 frame readout time. In this mode, the frame rate depends on the exposure time, and it becomes $\text{frame rate} = 1/\text{exposure time}$. The maximum exposure time is 10 s.

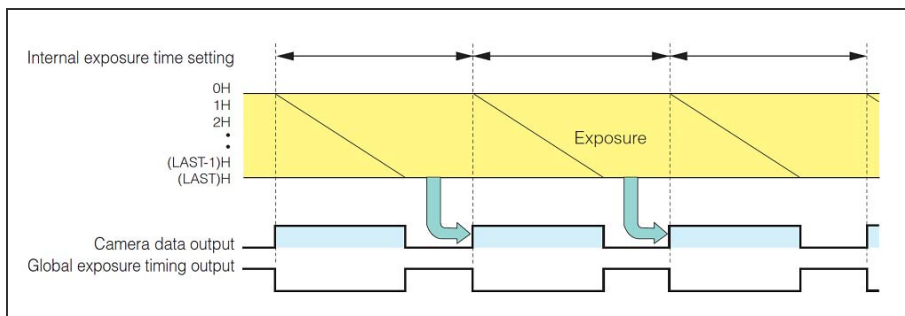

Figure 10-3

10-4-2 ELECTRICAL SHUTTER MODE

The electrical shutter mode is used to get a proper signal level when signal overflow happens due to too much input photons in normal readout mode. In this mode, the frame rate is 100 Hz at full resolution even when the exposure time is short.

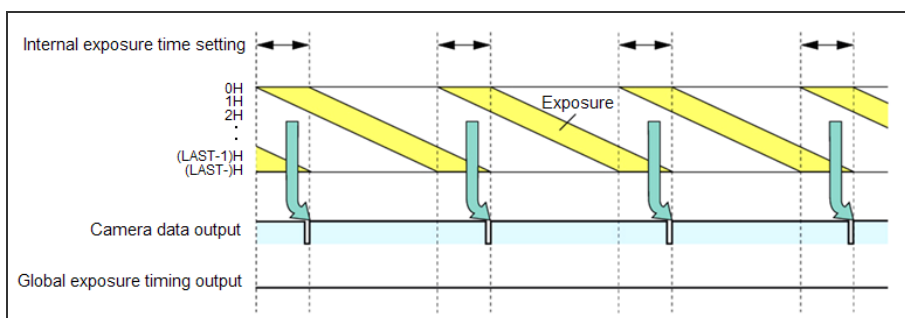

Figure 10-4

10-5 EXTERNAL CONTROL MODE

The camera has various external control functions to synchronize the camera with the external equipment. In the external control mode, the external equipment becomes a master and the camera becomes a slave.

Note

- The readout frame rate are 100 Hz and 90 Hz in the free running mode and the external control mode respectively. Refer to "Flash4.0 technical note" for the detail of the timing information.

10-5-1 EDGE TRIGGER MODE

The edge trigger mode is used so that the exposure starts according to an external signal. Exposure time is set by software command. In this mode, the exposure of the first line begins on the edge (rising/falling) timing of the input trigger signal into the camera. (0H in the following figure) The exposure of the second line is begun after the readout time of one line passes (1H in the following figure), and the exposure is begun one by one for each line.

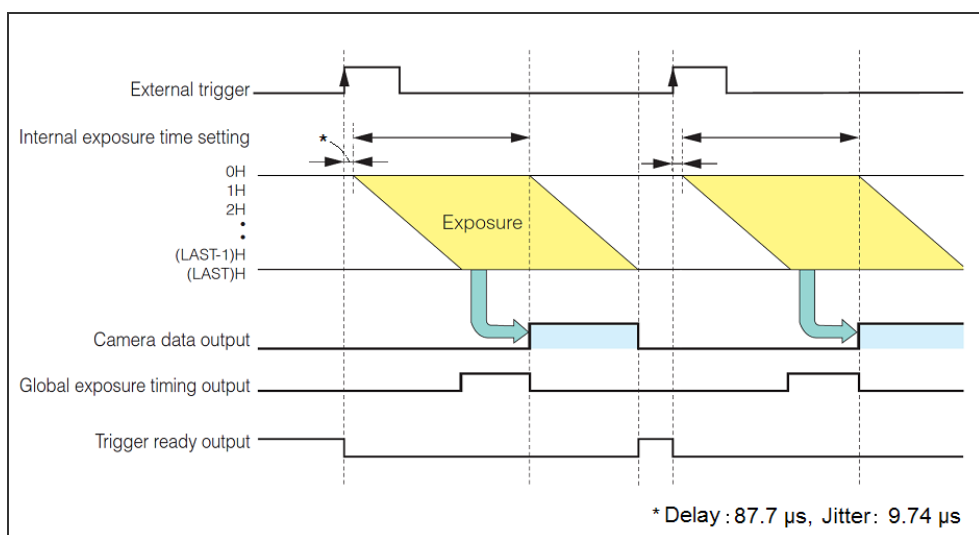

Figure 10-5 (Ex. rising edge)

10-5-2 LEVEL TRIGGER MODE

The level trigger mode is used to control both exposure start timing and exposure time length by inputting external trigger pulses. In the mode, the camera starts the exposure at the start of high or low period of the input trigger pulse and stops the exposure at the end of high or low period of the input trigger pulse. The example below is for the trigger level High. The exposure of the first line begins when the trigger signal becomes High, and the exposure of the second line begins after the readout time of line one passes. Each exposure begins one by one for each line. The exposure of the first line is finished when the trigger signal becomes low, and signal readout is begun. The exposure time of each line is defined by the time that the input trigger is high. The minimum trigger pulse width is $1 \text{ ms} + 50 \text{ }\mu\text{s}$.

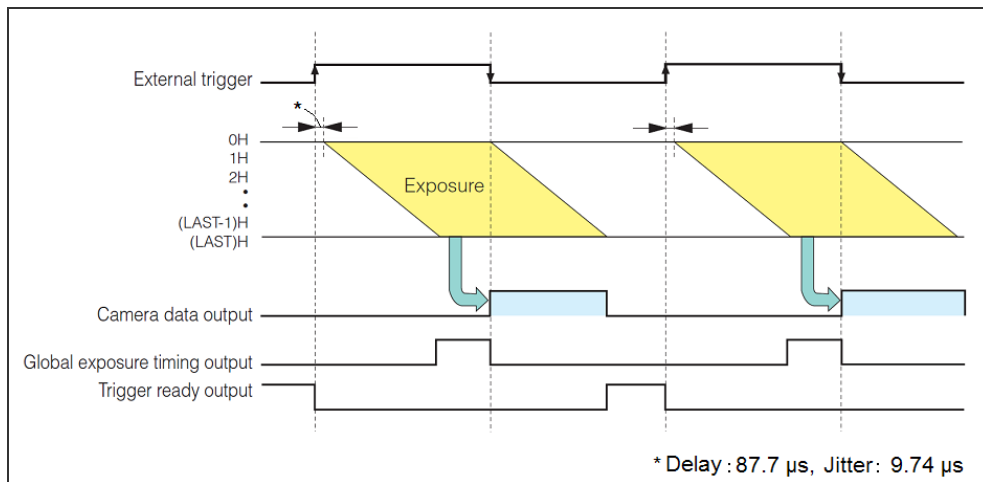

Figure 10-6 (Ex. rising edge)

10-5-3 SYNCHRONOUS READOUT TRIGGER MODE

The synchronous readout trigger mode is used for continuous imaging when it is necessary to control the exposure start timing of each frame from an external source. It is useful for confocal microscopy. For example, when the camera is used with a spinning disk confocal microscope and the camera exposure time is synchronized to the spinning disk's rotation speed, it is possible to eliminate uneven illumination (called banding noise) caused by variation of the spinning disk rotation speed. Also, it is useful for securing as long an exposure time as possible while controlling the exposure start timings by external trigger signals.

(1) At Normal operation (when the pulse count is set as 1.)

The synchronous readout trigger mode is used for continuous imaging when it is necessary to control the exposure start timing of each frame from an outside source and also when it is necessary to secure as long an exposure time as possible. In the synchronous readout trigger mode, the camera ends each exposure, starts the readout and also, at the same time, starts the next exposure at the edge of the input trigger signal (rising / falling edge). That is, the interval between the same edges of the input trigger becomes the exposure time.

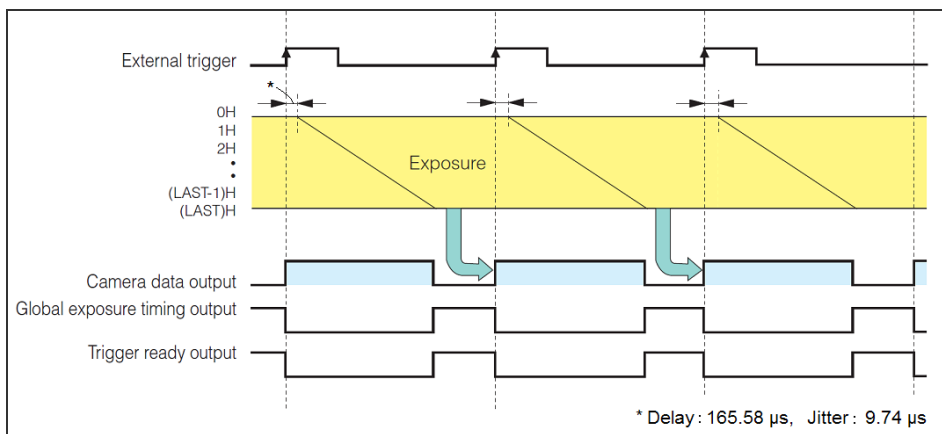

Figure 10-7 (Ex. rising edge)

(2) At Pulse count

Also in the synchronous readout trigger mode, synchronous readout can be controlled by specifying, set by command, the number of timing pulses to use to determine the exposure time. The following figure shows the exposure timing when the pulse count is set as 3.

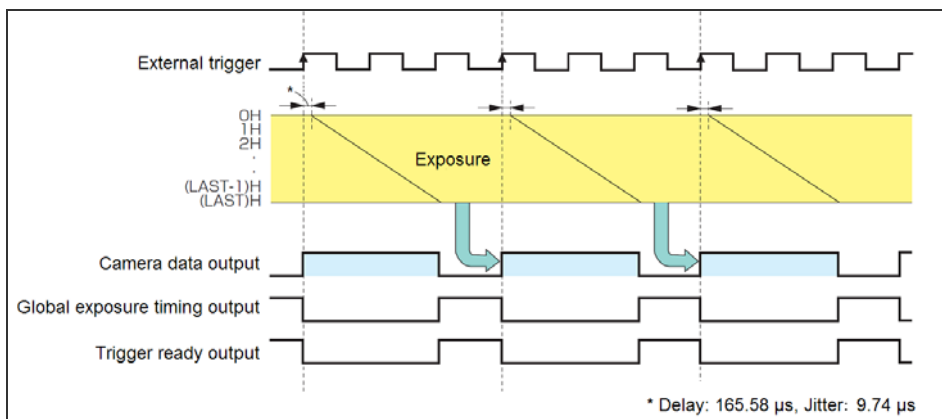

Figure 10-8 (Pulse count)

10-5-4 START TRIGGER MODE

The start trigger mode is used to start operating the camera by a trigger input for a continuous imaging. It is useful to secure the frame rate as fast as possible when continuous image acquisition and not to sacrifice the exposure time. Example, when it is necessary to measure the phenomenon after stimulation, it is possible to start continuous image acquisition at the stimulation timing.

The start trigger mode is used to start operating the camera by a trigger input for continuous imaging, and it works at the highest frame rate because it is operated in internal trigger mode. In the start trigger mode, the camera starts exposure and switches to internal trigger mode by the edge of an external trigger signal (rising / falling edge).

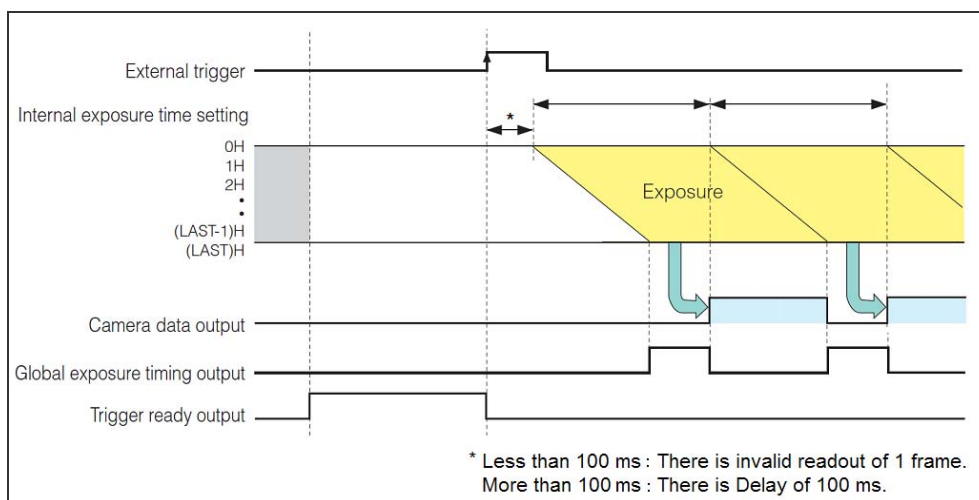

Figure 10-9 (Ex. rising edge)

10-5-5 EXTERNAL TRIGGER DELAY FUNCTION

In most case when a delay between the laser pulse emission and the exposure start is needed, a delay unit is set between the laser and camera to control trigger timing. In each external trigger mode of the camera, the delay time can be set to the trigger signal input to the camera by commands. Therefore, a range of trigger can be arranged without a delay unit. The setting range for delay time is 0 μ s to 10 s (10 μ s steps).

10-6 TRIGGER OUTPUT

The camera provides a range of trigger output signals to synchronize with an external instrument and the camera becomes the master and the external instrument the slave. There are three different trigger output functions as follows. Also, it can output continuous High output (High output fixed) or continuous Low output (Low output fixed). These three different trigger output functions can be selected by software command, and they are output from Timing out connector.

Note

- Please refer to Figure 10-3 to Figure 10-9 about details of each trigger output functions.

10-6-1 GLOBAL EXPOSURE TIMING OUTPUT

It shows the global exposure timing where all lines expose at the same time. There is a case that one event is divided into two frames because the timing of the exposure in each line is different for the rolling shutter. However, by using the Global exposure timing output the global exposure becomes possible for the phenomenon that happens for this period. Global exposure timing output shows the period where all lines expose at the same time.

Note

- There is no output signal when the exposure time is less than the frame rate.

10-6-2 PROGRAMMABLE TIMING OUTPUT

By using the programmable timing output, synchronizing external devices is simple. A system that needs simple timing signal does not require a delay unit nor pulse generator. It is possible to program and output a pulse that has an optional pulse width and an optional delay time to the end of readout timing. The setting range for delay time is 0 μ s to 10 s, and the setting range for pulse width is 9.7 μ s to 10 s.

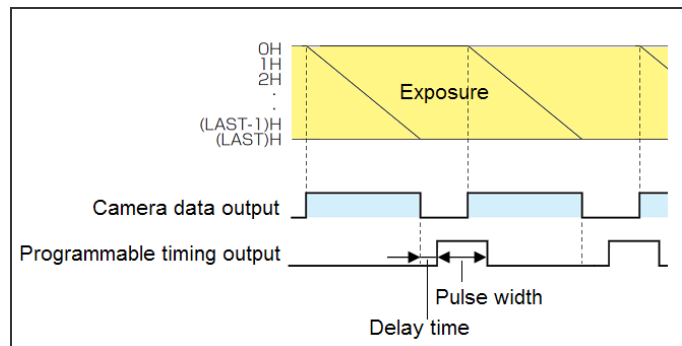

Figure 10-10

10-6-3 TRIGGER READY OUTPUT

The trigger ready output is useful to make the frame intervals as short as possible in external trigger mode. For example, when the camera is working in the edge trigger mode, the next frame can start after the previous frame exposure is done. Thus, the camera can't accept a trigger for the next frame during the exposure period. To reduce useless time to be as short as possible, it is necessary to know the period when the camera can accept a trigger for the next frame. The trigger ready output shows the trigger ready period when the camera can accept an external trigger in the external trigger mode.

10-7 REAL-TIME CORRECTION FUNCTIONS

There are a few pixels in FL-400 that have slightly higher readout noise performance compared with surrounding pixels. Therefore, the camera has real-time variant pixel correction features to further improve image quality. The correction is performed in real-time without sacrificing the readout speed at all. This function can be turned ON and OFF. (Default is ON)

11. PRECAUTION WHEN USING FL-400

This camera uses FL-400 (scientific CMOS image sensor). Careful attention must be paid to the following points when using FL-400:

(1) White spot

Subjecting FL-400 to extended exposures may cause failure in part of the silicon wafer, resulting in white spots. This phenomenon is not currently preventable. If FL-400 is at a fixed temperature, recurrence of the white spot increases proportionally with the exposure time, so this can be rectified with dark subtraction*. Atomic ray may generate white spot.

* After an image made using a certain exposure time is loaded, the FL-400 is exposed to darkness for the same amount of time, and another image is obtained. After this, the difference between the images is determined, and the data for the dark portion of the original image is nullified.

(2) Folding distortion

A rough-edged flicker may be visible when imaging striped patterns, lines, and similar subject matter.

(3) Over light



CAUTION

- Be careful not to input too strong light such as high-energy laser into FL-400 because FL-400 may be damaged by over light.

12. MAINTENANCE

12-1 CARE

Perform cleaning of this equipment with the dry soft cloth.



- Do not wipe with a damp cloth or unclean cloth.

Then, the glass window on the image sensor should be cleaned according to the following.

- (1) Blow the dust from the glass window with an air duster.
- (2) Moisten a lens cleaning paper with a little ethanol, and wipe over center area of the window, gently.



- Use Lens Cleaning Paper for cleaning of glass window in front of the image sensor.



- Please use a plastic tweezers and take extra care not to scratch the glass window with the tweezers. Even with plastic tweezers, there is possibility to make scratch on the glass window in case tweezers touch it.



- Please avoid touching the surrounding parts of image area when wiping the glass window.

- (3) Confirm whether dust is not left.

Attach the camera to an optics, and check if there is dust or not under the uniform light condition. If there is dust on the image, please clean the glass window again.

12-2 INFORMATION ON COOLING WATER FOR THE CIRCULATING WATER COOLER



- Regarding handling cooling water and circulating water cooler, please refer to instruction manual attached to the circulating water cooler.



- It is recommended to use soft water (except deionized water) for cooling water.



- Do not use hard water for cooling. It cause inside of cooling water circulating path to be calcified or corroded and it result lower flow rate or water flow stop. When using hard water, please conduct a process to soften water before use it.

12-2-1 WHEN USING COOLING WATER OTHER THAN RECOMMENDED

Note

Pure water

- Deionized water is not appropriate for cooling water. There is possibility that deionized water absorb component of cooling water path and it may cause corrosion. In addition deionized water is easy to be polluted and cause impurity, sliminess or forming foreign substances. It cause lower flow rate or water flow stop.

Note

Distilled water / Deionized water

- When using the camera inside clean room, it is possible to use distilled water or deionized water by conducting periodical check. However please notice it increases possibility of corrosion inside cooling water path, lowering flow rate or water flow stop.
 - Monthly check : Check water impurity, non-existence of sliminess, foreign particle is not mixed with water or not adhered inside water path and no unusual odor. If you find any of the issues, please exchange cooling water and clean cooling water path.

Note

Soft water from tap

- It is possible to use soft water from tap with conducting periodical change of cooling water and check up. However please notice it increases possibility of corrosion inside cooling water path, lowering flow rate or water flow stop.
 - Monthly check : Check water impurity, non-existence of sliminess, foreign particle is not mixed with water or not adhered inside water path and no unusual odor. If you find any of the issues, please exchange cooling water and clean cooling water path.
 - Exchange cooling water every 3 months.
 - Clean cooling water path every 6 months.

Note

Bottled water

- One example of soft water which is commonly available is mineral water (Hardness less than 70 mg/l). Please check hardness of water by referring product information of bottled water manufacturer.

13. TROUBLESHOOTING CHECKLIST

If an abnormality occurs, look up the possible causes in the following tables and, if necessary, report the details to Hamamatsu subsidiary or local distributor.

13-1 IMAGE IS NOT TRANSFERRED

Cause	Measures	Chapter
AC adaptor or other cable is loose	Reconnect the cable	7
AC adaptor or other cable is broken	Replace the cable	7
The correct command has not been sent to the camera	Recheck command	

13-2 ALTHOUGH IMAGES ARE TRANSFERRED

(1) Scratches or discoloration visible on the screen

Cause	Measures	Chapter
Lens is dirty	Wipe the lens	12

(2) Image is blurred

Cause	Measures	Chapter
Lens is not focused	Contact Hamamatsu subsidiary or local distributor	17
Condensation appear	Confirm the operating environmental conditions	8

(3) Only shadowed images are output

Cause	Measures	Chapter
Lens mount cap has been left on	Remove the cap	
Amount of light is too much or too low	Reduce amount of light	

(4) All screens overflow

Cause	Measures	Chapter
Too much amount of light	Reduce amount of light	
Contrast enhancement is too high	Reduce gain	

(5) Noise appears on the screen

Cause	Measures	Chapter
Exogenous noise	Find and remove cause	
Poor connection of internal connector	Contact Hamamatsu subsidiary or local distributor	17
Defective circuit system		

14. SPECIFICATIONS

14-1 CAMERA SPECIFICATIONS

(1) Electric specifications

Imaging device	Scientific CMOS image sensor FL-400		
Effective number of pixels	2048 (H) × 2048 (V)		
Cell size	6.5 μm (H) × 6.5 μm (V)		
Effective area	13.312 mm (H) × 13.312 mm (V)		
Full well capacity (typ.)	30 000 electrons		
Readout noise (typ.)	1.3 electrons		
Dynamic range * ¹	23 000 : 1		
Cooling method	Peltier device + Forced air-cooled / Water-cooled		
Cooling temperature	at Forced air-cooled: - 10 °C (Ambient temperature: + 20 °C) at Water-cooled: - 20 °C (water temperature: + 20 °C) at Water-cooled (max.): - 30 °C (water temperature: + 15 °C)		
Dark current (typ.)	at -10 °C: 0.5 electrons/pixel/s at -20 °C: 0.15 electrons/pixel/s at -30 °C: 0.05 electrons/pixel/s		
Frame rate	at Full resolution	Free running mode	100 frame/s
		External control mode	90 frame/s
	at 1024 lines at center position	Free running mode	200 frame/s
		External control mode	164 frame/s
at 8 lines at center position	Free running mode	25 655 frame/s	
	External control mode	877 frame/s	
A/D conversion	16 bit		
Readout mode	Binning readout * ² (Digital binning): 2×2, 4×4 Sub-array readout		
Exposure time	Free running mode: 1 ms to 10 s Free running mode (Sub-array): 38.96 μs to 10 s External control mode: 1 ms to 10 s		
Digital interface	CameraLink full configuration Deca mode		
Lens mount	C-mount		
External trigger input level	3.3 V LVCMOS level		
External trigger delay function	0 μs to 10 s (10 μs steps)		
External signal output	Global exposure timing output Trigger ready output Programmable timing output 1 Programmable timing output 2 Programmable timing output 3 (Continuous High or Low output)		

* 1 Calculated from the ratio of the full well capacity and the readout noise.

* 2 Digital binning processing in the camera.

(2) Power supply specifications

Input power supply	AC 100 V to AC 240 V
Frequency	50 Hz / 60 Hz
Power consumption	Approx. 120 VA

Note

- Fluctuations of input power supply voltages are not to exceed $\pm 10\%$ of the nominal voltage.

(3) Operating environment

Ambient operating temperature	0 °C to + 40 °C	
Ambient storage temperature	-10 °C to + 50 °C	
Ambient operating humidity	at Forced air-cooling	Less than 70 %, no condensation
	at Water-cooling	Less than 50 % (at ambient temp. 20 °C)
	at maximum cooling	Less than 40 % (at ambient temp. 20 °C)
Ambient storage humidity	90 %, no condensation	

(4) Dimensional outline and weight

Dimensional outline	85 mm (W) × 85.5 mm (H) × 125 mm (D)
Weight	Approx. 2.0 kg (Camera only)

Note

- Please see Chapter 15 [DIMENSIONAL OUTLINES] for detail of dimensions.



- Be careful not to drop off the camera or not drop underfoot when making it move because it is approx. 2.0 kg.

(5) Applicable standards

EMC	EN61326-1: 2006 Class A
-----	-------------------------

14-2 CONDENSATION

At the Water-cooling, if ambient temperature and ambient humidity become high, condensation will take place easily. Use the camera under the environment where condensation will not take place referring to the following graph.

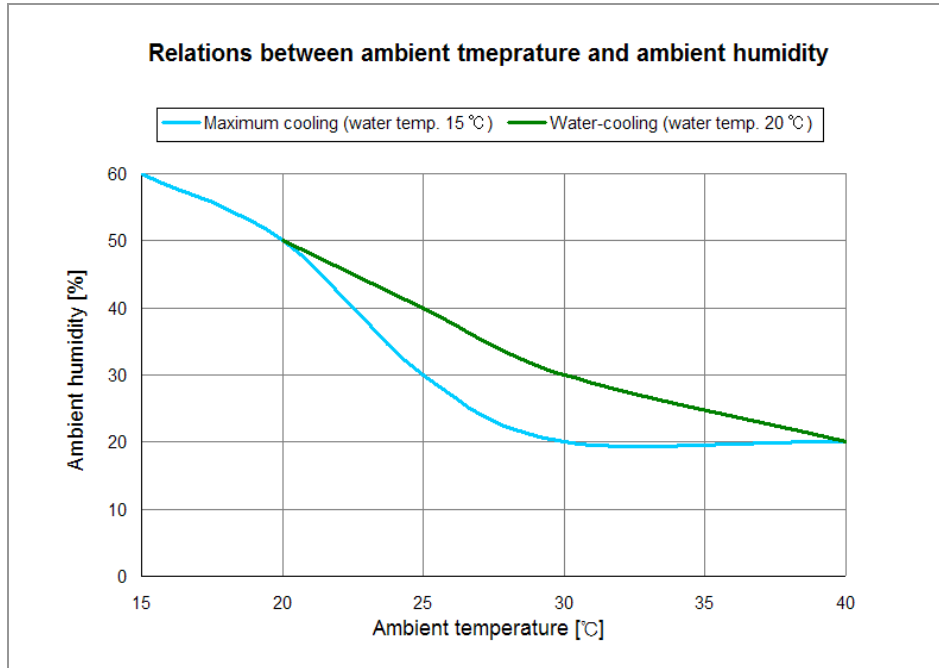

Figure 14-1

14-3 SPECTRAL RESPONSE CHARACTERISTICS

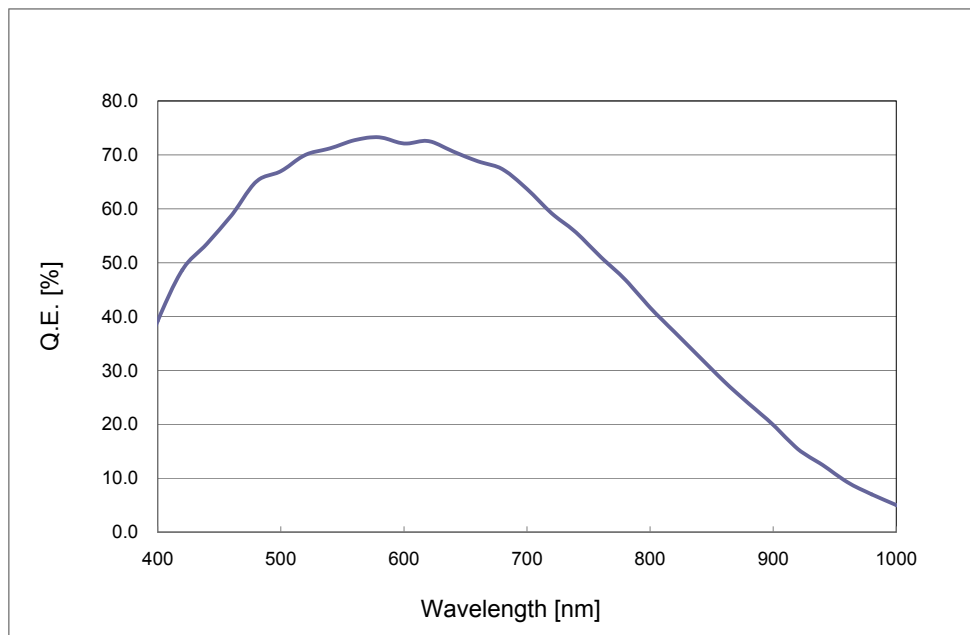

Figure 14-2

14-4 INTERFACE SPECIFICATIONS

14-4-1 CAMERALINK INTERFACE

The camera is based on CameraLink interface [CameraLink full configuration Deca mode], that transfers 80 bit data in parallel (8 bit x 10 port). It is an extended interface of CameraLink full configuration Standard.

(1) Pin assignments of CameraLink connector 1 (SDR-26)

Camera connector	Frame grabber connector	Channel Link signal
1	1	Inner Shield
2	25	X0-
3	24	X1-
4	23	X2-
5	22	Xclk-
6	21	X3-
7	20	SerTC+
8	19	SerTFG-
9	18	CC1-
10	17	CC2+
11	16	CC3-
12	15	CC4+
13	13	Inner Shield
14	14	Inner Shield
15	12	X0+
16	11	X1+
17	10	X2+
18	9	Xclk+
19	8	X3+
20	7	SerTC-
21	6	SerTFG+
22	5	CC1+
23	4	CC2-
24	3	CC3+
25	2	CC4-
26	26	Inner Shield

(2) Pin assignments of CameraLink connector 2 (SDR-26)

Camera connector	Frame grabber connector	Channel Link signal
1	1	Inner Shield
2	25	Y0-
3	24	Y1-
4	23	Y2-
5	22	Yclk-
6	21	Y3-
7	20	Terminated
8	19	Z0-
9	18	Z1-
10	17	Z2-
11	16	Zclk-
12	15	Z3-
13	13	Inner Shield
14	14	Inner Shield
15	12	Y0+
16	11	Y1+
17	10	Y2+
18	9	Yclk+
19	8	Y3+
20	7	Terminated
21	6	Z0+
22	5	Z1+
23	4	Z2+
24	3	Zclk+
25	2	Z3+
26	26	Inner Shield

(3) CameraLink bit assignments

28 bit solution pin name	Port	Plug No.1, Channel Link X	Port	Plug No.2, Channel Link Y	Port	Plug No.3, Channel Link Z
TxIN0	Port A0	D0_0	Port D2	D1_10	Port G5	D3_5
TxIN1	Port A1	D0_1	Port D3	D1_11	Port G6	D3_6
TxIN2	Port A2	D0_2	Port D4	D1_12	Port G7	D3_7
TxIN3	Port A3	D0_3	Port D5	D1_13	Port H0	D3_8
TxIN4	Port A4	D0_4	Port D6	D1_14	Port H1	D3_9
TxIN5	Port A5	D0_5	Port D7	D1_15 (MSB)	Port H2	D3_10
TxIN6	Port A6	D0_6	Port E0	D2_0	Port H3	D3_11
TxIN7	Port A7	D0_7	Port E1	D2_1	Port H4	D3_12
TxIN8	Port B0	D0_8	Port E2	D2_2	Port H5	D3_13
TxIN9	Port B1	D0_9	Port E3	D2_3	Port H6	D3_14
TxIN10	Port B2	D0_10	Port E4	D2_4	Port H7	D3_15 (MSB)
TxIN11	Port B3	D0_11	Port E5	D2_5	Port I0	D4_0
TxIN12	Port B4	D0_12	Port E6	D2_6	Port I1	D4_1
TxIN13	Port B5	D0_13	Port E7	D2_7	Port I2	D4_2
TxIN14	Port B6	D0_14	Port F0	D2_8	Port I3	D4_3
TxIN15	Port B7	D0_15 (MSB)	Port F1	D2_9	Port I4	D4_4
TxIN16	Port C0	D1_0	Port F2	D2_10	Port I5	D4_5
TxIN17	Port C1	D1_1	Port F3	D2_11	Port I6	D4_6
TxIN18	Port C2	D1_2	Port F4	D2_12	Port I7	D4_7
TxIN19	Port C3	D1_3	Port F5	D2_13	Port J0	D4_8
TxIN20	Port C4	D1_4	Port F6	D2_14	Port J1	D4_9
TxIN21	Port C5	D1_5	Port F7	D2_15 (MSB)	Port J2	D4_10
TxIN22	Port C6	D1_6	Port G0	D3_0	Port J3	D4_11
TxIN23	Port C7	D1_7	Port G1	D3_1	Port J4	D4_12
TxIN24	LVAL	LVAL	Port G2	D3_2	Port J5	D4_13
TxIN25	FVAL	FVAL	Port G3	D3_3	Port J6	D4_14
TxIN26	Port D0	D1_8	Port G4	D3_4	Port J7	D4_15 (MSB)
TxIN27	Port D1	D1_9	LVAL	LVAL	LVAL	LVAL
TxCLKIn	PClk	Pixel Clock A,B,C	PClk	Pixel Clock D,E,F	PClk	Pixel Clock G,H,I,J

LVAL (Line Valid signal)	This signal show the period during which the line part of the image data from FL-400 is in effect. This is "ON" when during the period the line is active.
FVAL (Frame Valid signal)	This signal shows the period during which the vertical part of the image data from FL-400 is in effect. This is "ON" during the period the frame is active.
D0_0 to D4_15 (Digital image data)	This is the image signal data from FL-400 converted A/D. "D0 to D4" has 16 bit data in each. MSD shows the most significant bit. Please see 14-4-2 [OUTPUT TIMING SPECIFICATIONS] for details.

14-4-2 OUTPUT TIMING SPECIFICATIONS

(1) in Normal readout

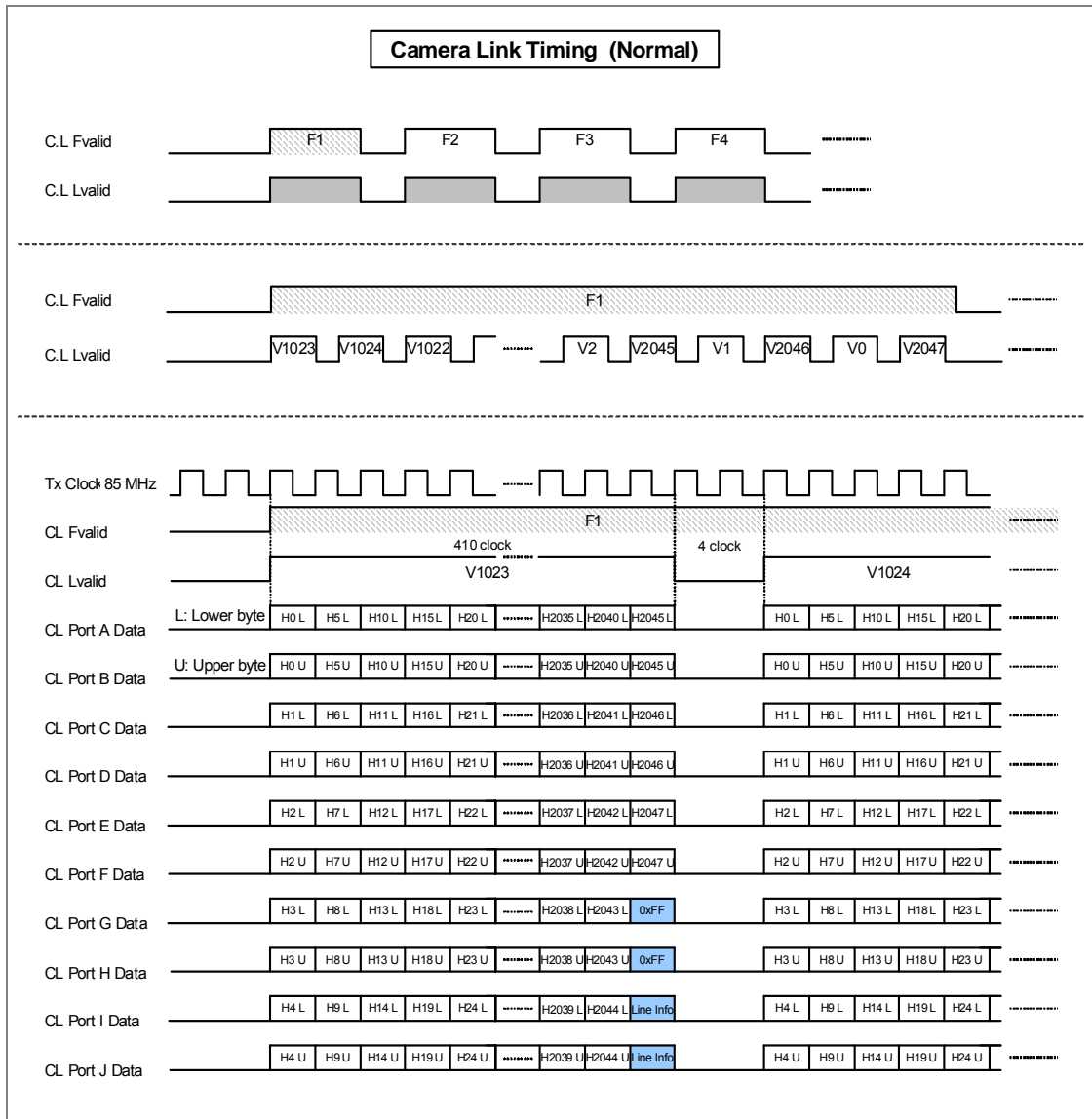

(2) at 2x2 binning readout

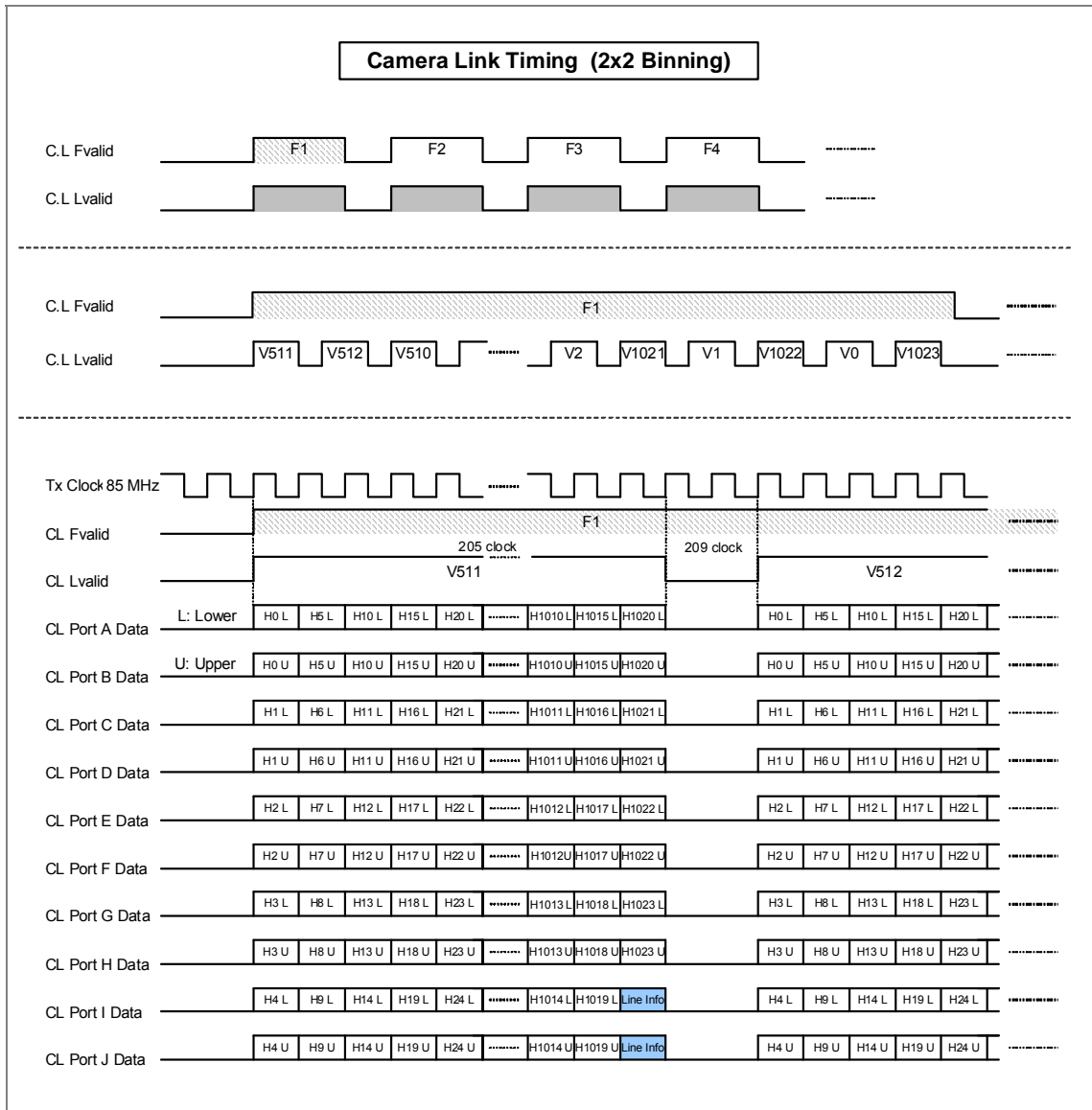

(3) in 4x4 binning readout

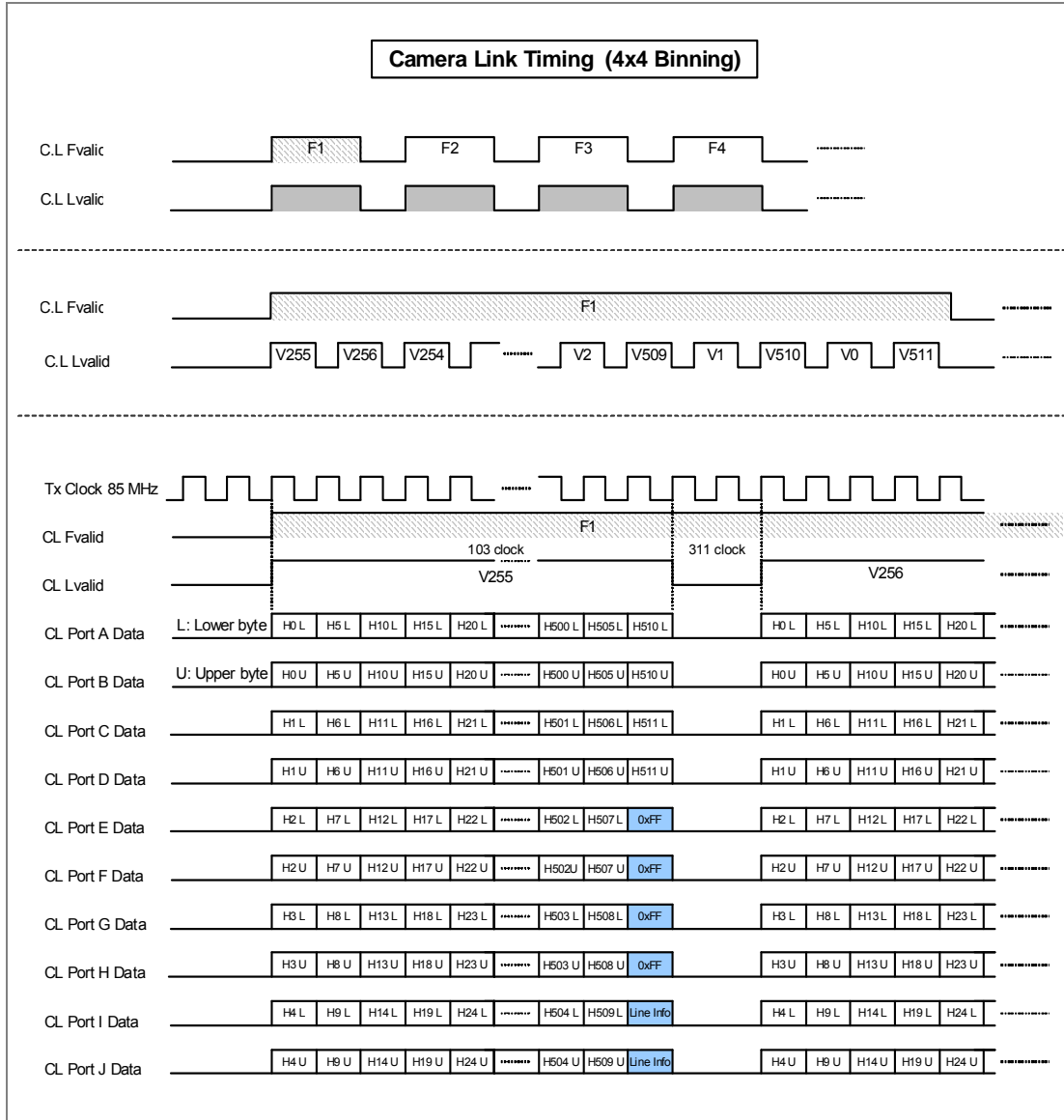

(4) in Sub-array readout

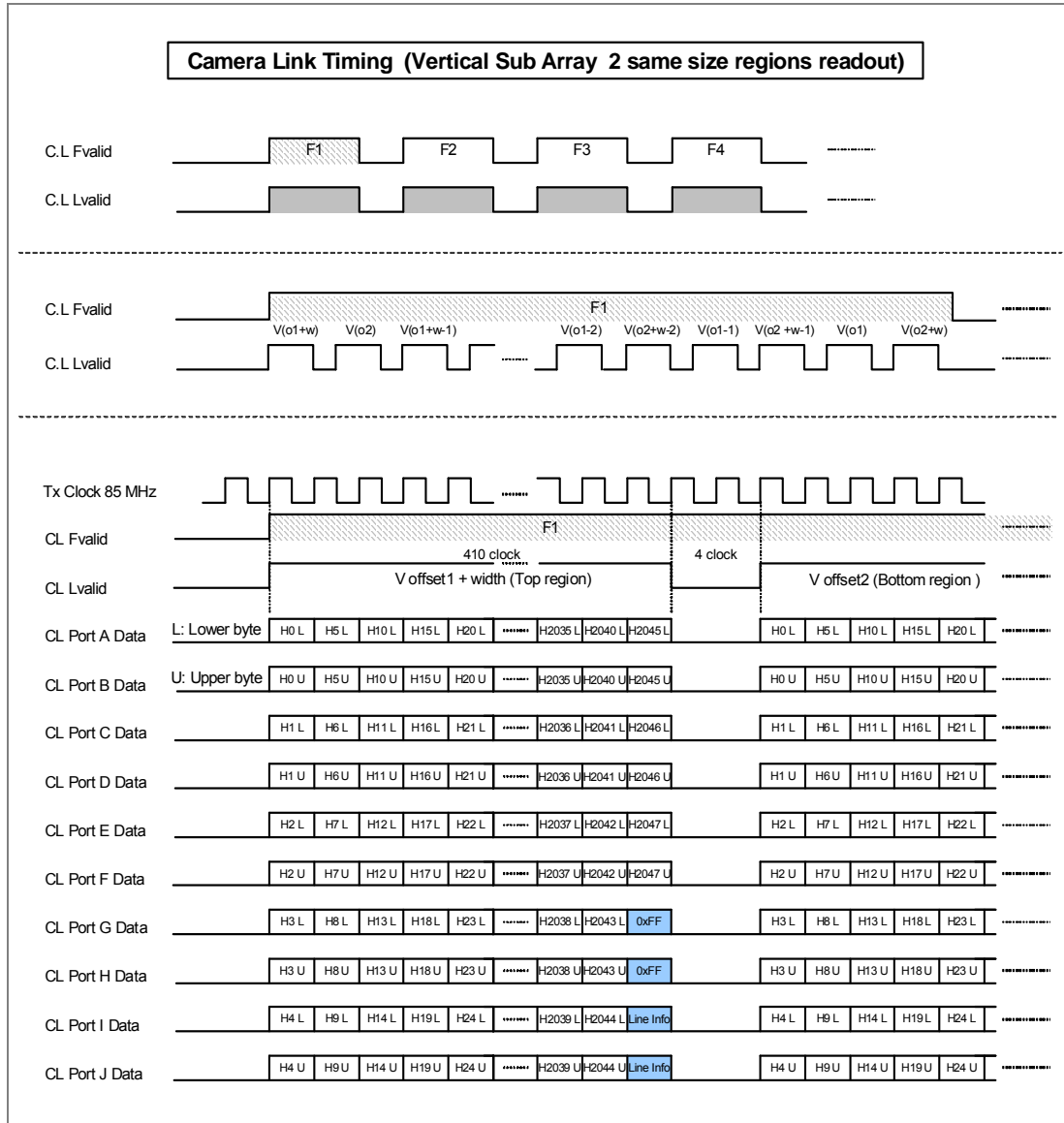

15. DIMENSIONAL OUTLINES

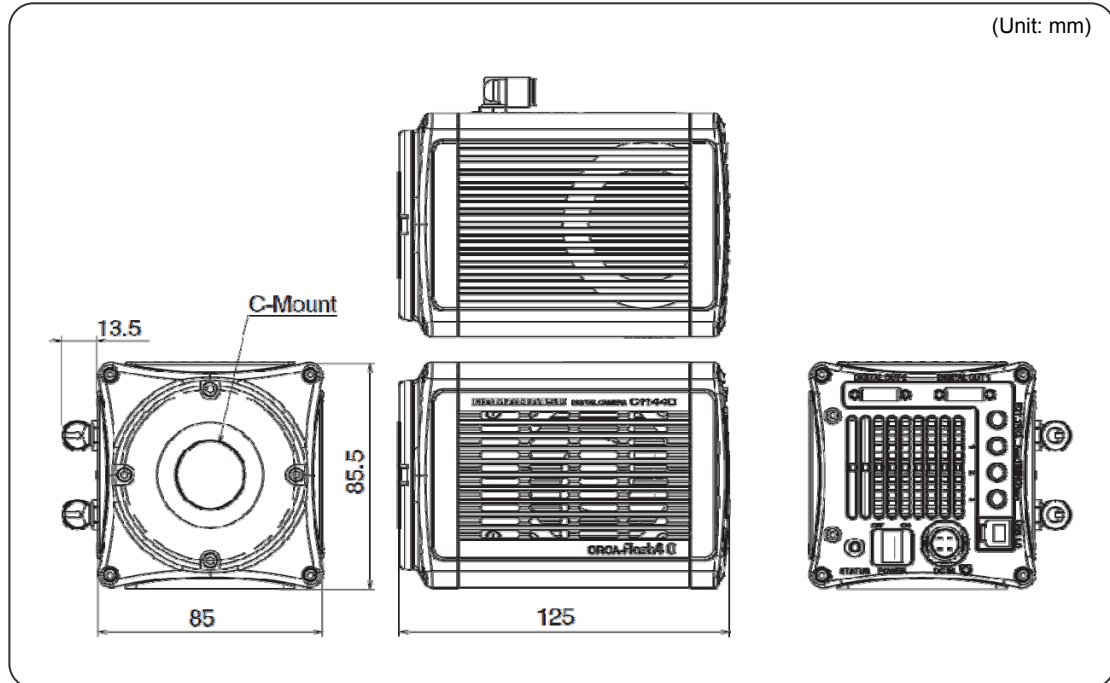

16. WARRANTY

Hamamatsu Photonics have fully inspected this system and checked that its performance conforms to specifications. In the unlikely event of breakdown or other malfunction, contact Hamamatsu subsidiary or local distributor.

- (1) Unless otherwise stated by Hamamatsu subsidiary or local distributor, this system is under warranty for 24 months from the delivery date.
 - Degradation with atomic rays, the radiation (X-rays, gamma rays, UV light, etc.) of FL-400 is excepted.
- (2) The warranty only covers defects in the materials and manufacturing of the system. You may be liable for repairs during the warranty period in the event of a natural disaster or if you handle the system contrary to the instructions in this manual, use it without due caution, or try to modify it.
- (3) We will repair the system or replace it, subject to availability, free of charge within the terms of the warranty.

REPAIRS

- (1) If you notice anything wrong with the camera, confirm whether or not it is malfunctioning by referring to the troubleshooting checklist in this instruction manual. You must first clarify the symptoms in order to avoid any misunderstanding or error.
- (2) If you have any trouble or are unclear about anything, contact Hamamatsu subsidiary or local distributor giving the product name, serial number and details of the problem. If Hamamatsu Photonics consider the problem to be a malfunction, we will decide whether dispatch an engineer or have the camera returned to us for repairs.

17. CONTACT INFORMATION

HAMAMATSU PHOTONICS K. K., Systems Division

812 Joko-cho, Higashi-ku, Hamamatsu City, 431-3196, Japan
 Telephone (81) 53-431-0124, Fax: (81) 53-435-1574
 E-mail: export@sys.hpk.co.jp

U.S.A. and Canada

Hamamatsu Corporation

360 Foothill Road, Bridgewater, N.J. 08807-0910, U.S.A.
 Telephone: (1) 908-231-0960, Fax: (1) 908-231-0852
 E-mail: usa@hamamatsu.com

Germany

Hamamatsu Photonics Deutschland GmbH

Arzbergerstr. 10, D-82211 Herrsching am Ammersee, Germany
 Telephone: (49) 8152-375-0, Fax: (49) 8152-265-8
 E-mail: info@hamamatsu.de

France

Hamamatsu Photonics France S.A.R.L.

19, Rue du Saule Trapu, Parc du Moulin de Massy, 91882 Massy Cedex, France
 Telephone: (33) 1 69 53 71 00, Fax: (33) 1 69 53 71 10
 E-mail: infos@hamamatsu.fr

United Kingdom

Hamamatsu Photonics UK Limited

2 Howard Court, 10 Tewin Road, Welwyn Garden City Hertfordshire AL7 1BW, United Kingdom
 Telephone: (44) 1707-294888, Fax: (44) 1707-325777
 E-mail: info@hamamatsu.co.uk

North Europe

Hamamatsu Photonics Norden AB

Smidesvagän 12, SE-171 41 Solna, Sweden
 Telephone: (46) 8-509-031-00, Fax: (46)8-509-031-01
 E-mail: info@hamamatsu.se

Italy

Hamamatsu Photonics Italia S.R.L.

Strada della Moia, 1/E 20020 Arese (Milano), Italy
 Telephone: (39) 02-935 81 733, Fax: (39) 02-935 81 741
 E-mail: info@hamamatsu.it

China

Hamamatsu Photonics (China) Co., Ltd.

1201 Tower B, Jiaming Center, 27 Dongsanhuan Beilu, Chaoyang District, Beijing 100020, China
 Telephone: (86)10-6586-6006, Fax: (86)10-6586-2866
 E-mail: hpc@hamamatsu.com.cn

- *The contents of this manual are subject to change without notice.*
- *The unauthorized reproduction or distribution of parts or all of this manual is prohibited.*
- *If one of the following problems occurs, please contact Hamamatsu Photonics.
 (See the CONTACT INFORMATION.) We will deal with the problem immediately.*
 - *Some contents of the manual are dubious, incorrect or missing.*
 - *Some pages of the manual are missing or in the wrong order.*
 - *The manual is missing or dirty.*