



Agilent Technologies

Innovating the HP Way

June 8, 2000

08903-90062 Volume 1

Dear Customer,

As of November 1, 1999, four of Hewlett-Packard's businesses, test and measurement, semiconductor products, health care solutions, and chemical analysis became a new company, Agilent Technologies. Now, many of your Hewlett-Packard products and services are in the care of Agilent Technologies.

At Agilent Technologies, we are working diligently to make this transition as smooth as possible for you. However, as a result of this transition, the products and related documentation contained in this shipment may be labeled with either the Hewlett-Packard name and logo, the Agilent Technologies name and logo, or a combination of both. Information in this package may refer to Hewlett-Packard (HP), but applies to your Agilent Technologies product. Hewlett-Packard and Agilent branded products with the same model number are interchangeable.

Whatever logo you see, the information, products, and services come from the same reliable source.

If you have questions about Agilent Technologies products and services, please visit our website at <http://www.agilent.com>.

Sincerely,

Rebranding Team

HP 8903B AUDIO ANALYZER (Including Option 001) Service Manual

SERIAL NUMBERS

This manual applies directly to instruments with serial numbers prefixed:

2450A to 2948A and all *MAJOR* changes that apply to your instrument.

rev. 20JUN91

For additional important information about serial numbers, refer to "INSTRUMENTS COVERED BY THIS MANUAL" in Section 1.

Fifth Edition

This material may be reproduced by or for the U.S. Government pursuant to the Copyright License under the clause at DFARS 52.227-7013 (APR 1988).

Copyright © HEWLETT-PACKARD COMPANY 1985
EAST 24001 MISSION AVENUE, TAF C-34, SPOKANE, WASHINGTON, U.S.A. 99220

Service Manual (Volume 1, 2) HP Part 08903-90062

Other Documents Available:

Operation and Calibration Manual (Volume 1) HP Part 08903-90079

Microfiche Operation and Calibration and Service Manual HP Part 08903-90080

Printed in U.S.A. : July 1993



**HEWLETT
PACKARD**

1 Regulatory Information

(Updated March 1999)

Safety Considerations

GENERAL

This product and related documentation must be reviewed for familiarization with safety markings and instructions before operation.

This product has been designed and tested in accordance with *IEC Publication 1010*, "Safety Requirements for Electronic Measuring Apparatus," and has been supplied in a safe condition. This instruction documentation contains information and warnings which must be followed by the user to ensure safe operation and to maintain the product in a safe condition.

SAFETY EARTH GROUND

A uninterruptible safety earth ground must be provided from the main power source to the product input wiring terminals, power cord, or supplied power cord set.

SAFETY SYMBOLS



Indicates instrument damage can occur if indicated operating limits are exceeded.



Indicates hazardous voltages.



Indicates earth (ground) terminal

WARNING **A WARNING note denotes a hazard. It calls attention to a procedure, practice, or the like, which, if not correctly performed or adhered to, could result in personal injury. Do not proceed beyond a WARNING sign until the indicated conditions are fully understood and met.**

CAUTION A CAUTION note denotes a hazard. It calls attention to an operation procedure, practice, or the like, which, if not correctly performed or adhered to, could result in damage to or destruction of part or all of the product. Do not proceed beyond an CAUTION note until the indicated conditions are fully understood and met.

Safety Considerations for this Instrument

WARNING

This product is a Safety Class I instrument (provided with a protective earthing ground incorporated in the power cord). The mains plug shall only be inserted in a socket outlet provided with a protective earth contact. Any interruption of the protective conductor inside or outside of the product is likely to make the product dangerous. Intentional interruption is prohibited.

Whenever it is likely that the protection has been impaired, the instrument must be made inoperative and be secured against any unintended operation.

If this instrument is to be energized via an auto transformer (for voltage reduction), make sure the common terminal is connected to the earth terminal of the power source.

If this product is not used as specified, the protection provided by the equipment could be impaired. This product must be used in a normal condition (in which all means for protection are intact) only.

No operator serviceable parts in this product. Refer servicing to qualified personnel. To prevent electrical shock, do not remove covers.

Servicing instructions are for use by qualified personnel only. To avoid electrical shock, do not perform any servicing unless you are qualified to do so.

The opening of covers or removal of parts is likely to expose dangerous voltages. Disconnect the product from all voltage sources while it is being opened.

The power cord is connected to internal capacitors that may remain live for 5 seconds after disconnecting the plug from its power supply.

For Continued protection against fire hazard, replace the line fuse(s) only with 250 V fuse(s) or the same current rating and type (for example, normal blow or time delay). Do not use repaired fuses or short circuited fuseholders.

Always use the three-prong ac power cord supplied with this product. Failure to ensure adequate earth grounding by not using this cord may cause product damage.

This product is designed for use in Installation Category II and Pollution Degree 2 per IEC 1010 and IEC 664 respectively. FOR INDOOR USE ONLY.

This product has autoranging line voltage input, be sure the supply voltage is within the specified range.

To prevent electrical shock, disconnect instrument from mains (line) before cleaning. Use a dry cloth or one slightly dampened with water to clean the external case parts. Do not attempt to clean internally.

Ventilation Requirements: When installing the product in a cabinet, the convection into and out of the product must not be restricted. The ambient temperature (outside the cabinet) must be less than the maximum operating temperature of the product by 4° C for every 100 watts dissipated in the cabinet. If the total power dissipated in the cabinet is greater than 800 watts, then forced convection must be used.

Product Markings

CE - the CE mark is a registered trademark of the European Community. A CE mark accompanied by a year indicated the year the design was proven.

CSA - the CSA mark is a registered trademark of the Canadian Standards Association.

REGIONAL SALES AND SERVICE OFFICES

ASIA

Hewlett-Packard Asia Ltd.
47/F 26 Harbour Rd.
Wanchai, HONG KONG
G.P.O. Box 863 Hong Kong
Tel: 5-8330833
Telex: 76793 HPA HX
Cable: HPASIAL TD

CANADA

Hewlett-Packard (Canada) Ltd.
6877 Goreway Drive
MISSISSAUGA, Ontario L4V 1M8
Tel: (416) 678-9430
Telex: 069-8644

EASTERN EUROPE

Hewlett Packard Ges. m.b.h.
Liebigasse 1
P.O. Box 72
A-1222 VIENNA, Austria
Tel: (222) 2500-0
Telex: 1 3 4425 HEPA A

NORTHERN EUROPE

Hewlett-Packard S.A.
V.D. Hooplaan 241
P.O. Box 999
NL-118 LN 15 AMSTELVEEN
The Netherlands
Tel: 20 5479999
Telex: 18919 hpser

SOUTH EAST EUROPE

Hewlett-Packard S.A.
World Trade Center
110 Avenue Louis-Casai
1215 Cointrin, GENEVA,
Switzerland
Tel: (022) 98 96 51
Telex: 27225 hpner
Mail Address:
P.O. Box
CH-1217 Meyrin 1
GENEVA
Switzerland

MIDDLE EAST AND CENTRAL AFRICA

Hewlett-Packard S.A.
Middle East/Central
Africa Sales H.Q.
7, rue du Bois-du-Lan
P.O. Box 364
CH-1217 Meyrin 1
GENEVA
Switzerland
Tel: (022) 83 12 12
Telex: 27835 hmea ch
Telefax: (022)-83 15 35

UNITED KINGDOM

Hewlett Packard Ltd.
Nine Mile Ride
WOKINGHAM
Berkshire, RG113LL
Tel: 0344 773100
Telex: 848805/848814/848912

UNITED STATES OF AMERICA

Customer Information
Center
Tel: (800) 752-0900
6:00 AM to 5:00 PM
Pacific Time

EASTERN USA

Hewlett-Packard Co.
4 Choke Cherry Road
ROCKVILLE, MD 20850
Tel: (301) 948-6370

MIDWESTERN USA

Hewlett-Packard Co.
5201 Tollview Drive
ROLLING MEADOWS,
IL 60008
Tel: (312) 255-9800

SOUTHERN USA

Hewlett-Packard Co.
2000 South Park Place
ATLANTA, GA 30339
Tel: (404) 955-1500

WESTERN USA

Hewlett-Packard Co.
5161 Lankershim Blvd.
NORTH HOLLYWOOD,
CA 91601
Tel: (818) 505-5600

OTHER INTERNATIONAL AREAS

Hewlett-Packard Co.
Intercontinental
Headquarters
3495 Deer Creek Road
PALO ALTO, CA 94304
Tel: (415) 857-1501
Telex: 034-8300
Cable: HEWPACK

SAFETY CONSIDERATIONS

GENERAL

This product and related documentation must be reviewed for familiarization with safety markings and instructions before operation.

This product is a Safety Class I instrument (provided with a protective earth terminal).

BEFORE APPLYING POWER

Verify that the product is set to match the available line voltage and the correct fuse is installed.

SAFETY EARTH GROUND

An uninterruptible safety earth ground must be provided from the main power source to the product input wiring terminals, power cord, or supplied power cord set.

SAFETY SYMBOLS



Instruction manual symbol: the product will be marked with this symbol when it is necessary for the user to refer to the instruction manual (refer to Table of Contents.)



Indicates hazardous voltages.



Indicates earth (ground) terminal.

WARNING

The WARNING sign denotes a hazard. It calls attention to a procedure, practice, or the like, which, if not correctly performed or adhered to, could result in personal injury. Do not proceed beyond a WARNING sign until the indicated conditions are fully understood and met.

CAUTION

The CAUTION sign denotes a hazard. It calls attention to an operating procedure, practice, or the like, which, if not correctly performed or adhered to, could result in damage to or destruction of part or all of the product. Do not proceed beyond a CAUTION sign until the indicated conditions are fully understood and met.

WARNING

Any interruption of the protective (grounding) conductor (inside or outside the instrument) or disconnecting the protective earth terminal will cause a potential shock hazard that could result in personal injury. (Grounding one conductor of a two conductor outlet is not sufficient protection).

Whenever it is likely that the protection has been impaired, the instrument must be made inoperative and be secured against any unintended operation.

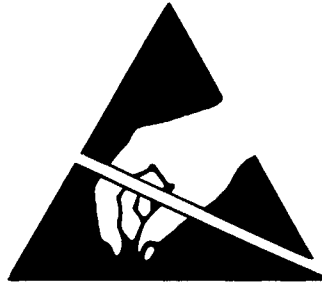
If this instrument is to be energized via an autotransformer (for voltage reduction) make sure the common terminal is connected to the earth terminal of the power source.

Servicing instructions are for use by service trained personnel only. To avoid dangerous electric shock, do not perform any servicing unless qualified to do so.

Adjustments described in the manual are performed with power supplied to the instrument while protective covers are removed. Energy available at many points may, if contacted, result in personal injury.

Capacitors inside the instrument may still be charged even if the instrument has been disconnected from its source or supply.

For continued protection against fire hazard, replace the line fuse(s) only with 250V fuse(s) of the same current rating and type (for example, normal blow, time delay, etc.) Do not use repaired fuses or short circuited fuseholders.



**ATTENTION
Static Sensitive
Devices**

This instrument was constructed in an ESD (electro-static discharge) protected environment. This is because most of the semi-conductor devices used in this instrument are susceptible to damage by static discharge.

Depending on the magnitude of the charge, device substrates can be punctured or destroyed by contact or mere proximity of a static charge. The results can cause degradation of device performance, early failure, or immediate destruction.

These charges are generated in numerous ways such as simple contact, separation of materials, and normal motions of persons working with static sensitive devices.

When handling or servicing equipment containing static sensitive devices, adequate precautions must be taken to prevent device damage or destruction.

Only those who are thoroughly familiar with industry accepted techniques for handling static sensitive devices should attempt to service circuitry with these devices.

In all instances, measures must be taken to prevent static charge build-up on work surfaces and persons handling the devices.

Section 6 REPLACEABLE PARTS

6-1. INTRODUCTION

This section contains information for ordering parts. Table 6-1 lists reference designations, and Table 6-2 lists abbreviations used in the parts list and throughout the manual. Table 6-3 lists all replaceable parts in reference designator order. Table 6-4 contains the names and addresses that correspond to the manufacturer's code numbers.

6-2. ABBREVIATIONS

Table 6-2 lists abbreviations used in the parts list, schematics, and throughout the manual. In some cases, two forms of the abbreviation are used, one all in capital letters, and one partial or no capitals. This occurs because the abbreviations in the parts list are always all capitals. However, in the schematics and other parts of the manual, other abbreviation forms are used with both lower case and upper case letters.

6-3. REPLACEABLE PARTS LIST

Table 6-3 is the list of replaceable parts and is organized as follows:

- a. Electrical assemblies and their components in alphanumeric order by reference designation.
- b. Chassis-mounted parts in alphanumeric order by reference designation.
- c. Mechanical parts.

The information given for each part consists of the following:

- a. The Hewlett-Packard part number.
- b. Part number check digit (CD).
- c. The total quantity (Qty) for the entire instrument except for option assemblies. (See following note.)
- d. The description of the part.
- e. A typical manufacturer of the part in a five-digit code.
- f. The manufacturer's number for the part.

NOTE

The total quantity for each part is given only once, that is, at the first occurrence of the part number in the list. The total quantities for optional assemblies are tallied by assembly and not integrated into the standard list.

6-4. FACTORY SELECTED PARTS (*)

Parts marked with an asterisk (*) are factory selected parts. The value listed in the parts list is the nominal value. Refer to Sections 5 and 8 of this manual for information on determining what value to use for replacement.

6-5. PARTS LIST UPDATING (MANUAL UPDATES)

Production changes to the Audio Analyzer made after the publication date of this manual are accompanied by a change in the serial number prefix. Changes to the parts list are recorded by serial number prefix on an addition or replacement page(s). The MANUAL UPDATE pages can be ordered by filling out and returning the DOCUMENTATION UPDATE SERVICE REQUEST reply card found in the beginning of this service manual.

6-6. ILLUSTRATED PARTS BREAKDOWNS

Most mechanical parts are identified in Figure 6-1 through 6-5. These figures are located at the end of the replaceable parts table.

6-7. ORDERING INFORMATION

To order a part listed in the replaceable parts table, include the Hewlett-Packard part number (with the check digit) and the quantity required. Address the order to the nearest Hewlett-Packard office. The check digit will ensure accurate and timely processing of your order.

To order a part that is not listed in the replaceable parts table, include the instrument model number, instrument serial number, description and function of the part, and the quantity of parts required. Address the order to the nearest Hewlett-Packard office.

NOTE

Within the USA, it is better to order directly from the HP Parts Center in Mountain View, California. Ask your nearest HP office for information and forms for the "Direct Mail Order System".

6-8. RECOMMENDED SPARES LIST

Stocking spare parts for an instrument is often done to ensure quick return to service after a malfunction occurs. Hewlett-Packard has prepared a "Recommended Spares" list for this instrument. The contents of the list are based on failure reports and repair

data. Quantities given are for one year of parts support. A complimentary copy of the "Recommended Spares" list may be requested from your nearest Hewlett-Packard office.

When stocking parts to support more than one Audio Analyzer or to support a variety of Hewlett-Packard instruments, it may be more economical to work from one consolidated list rather than simply adding together stocking quantities from the individual instrument lists. Hewlett-Packard will prepare consolidated "Recommended Spares" lists for any number or combination of instruments. Contact your nearest Hewlett-Packard office for details.

Table 6-1. Reference Designations

REFERENCE DESIGNATIONS			
A	assembly	E	miscellaneous electrical part
AT	attenuator; isolator; termination	F	fuse
B	fan; motor	FL	filter
BT	battery	H	hardware
C	capacitor	HY	circulator
CP	coupler	J	electrical connector (stationary portion); jack
CR	diode; diode thyristor; varactor	K	relay
DC	directional coupler	L	coil; inductor
DL	delay line	M	meter
DS	annunciator; signaling device (audible or visual); lamp; LED	MP	miscellaneous mechanical part
P	electrical connector (movable portion); plug	Q	transistor; SCR; triode thyristor; FET
U	integrated circuit; microcircuit	R	resistor
V	electron tube	RT	thermistor
VR	voltage regulator; breakdown diode	S	switch
W	cable; transmission path; wire	T	transformer
X	socket	TB	terminal board
Y	crystal unit (piezo-electric or quartz)	TC	thermocouple
Z	tuned cavity; tuned circuit	TP	test point

Table 6-2. Abbreviations (1 of 2)

ABBREVIATIONS			
A	ampere	COEF	coefficient
ac	alternating current	COM	common
ACCESS	accessory	COMP	composition
ADJ	adjustment	COMPL	complete
A/D	analog-to-digital	CONN	connector
AF	audio frequency	CP	cadmium plate
AFC	automatic frequency control	CRT	cathode-ray tube
AGC	automatic gain control	CTL	complementary transistor logic
AL	aluminum	CW	continuous wave
ALC	automatic level control	deg	degree (temperature interval or difference)
AM	amplitude modulation	dB	decibel
AMPL	amplifier	dBm	decibel referred to 1 mW
APC	automatic phase control	dc	direct current
ASSY	assembly	deg	degree (temperature interval or difference)
AUX	auxiliary	...°	degree (plane angle)
avg	average	°C	degree Celsius (centigrade)
AWG	American wire gauge	°F	degree Fahrenheit
BAL	balance	°K	degree Kelvin
BCD	binary coded decimal	DEPC	deposited carbon
BD	board	DET	detector
BECU	beryllium copper	diam	diameter
BFO	beat frequency oscillator	DIA	diameter (used in parts list)
BH	binder head	DIFF AMPL	differential amplifier
BKDN	breakdown	div	division
BP	bandpass	DPDT	double-pole, double-throw
BPF	bandpass filter	DR	drive
BRS	brass	DSB	double sideband
BWO	backward-wave oscillator	DTL	diode transistor logic
CAL	calibrate	DVM	digital voltmeter
ccw	counter-clockwise	ECL	emitter coupled logic
CER	ceramic	EMF	electromotive force
CHAN	channel	EDP	electronic data processing
cm	centimeter	ELECT	electrolytic
CMO	cabinet mount only	ENCAP	encapsulated
COAX	coaxial	EXT	external
		F	farad
		FET	field-effect transistor
		F/F	flip-flop
		FH	flat head
		FIL H	fillister head
		FM	frequency modulation
		FP	front panel
		FREQ	frequency
		FXD	fixed
		g	gram
		GE	germanium
		GHz	gigahertz
		GL	glass
		GRD	ground(ed)
		H	henry
		h	hour
		HET	heterodyne
		HEX	hexagonal
		HD	head
		HDW	hardware
		HF	high frequency
		HG	high mercury
		HI	high
		HP	Hewlett-Packard
		HPPF	high pass filter
		HR	hour (used in parts list)
		HV	high voltage
		Hz	Hertz
		IC	integrated circuit
		ID	inside diameter
		IF	intermediate frequency
		IMPG	impregnated
		in	incandescent
		INCL	include(s)
		INP	input
		INS	insulation
		INT	internal
		kg	kilogram
		kHz	kilohertz
		k	kilohm
		kV	kilovolt
		lb	pound
		LC	inductance-capacitance
		LED	light-emitting diode
		LF	low frequency
		LG	long
		LH	left hand
		LIM	limit
		LIN	linear taper (used in parts list)
		LK WASH	lock washer
		LO	low; local oscillator
		LOG	logarithmic taper (used in parts list)
		log	logarithm(ic)
		LPF	low pass filter
		LV	low voltage
		m	meter (distance)
		mA	milliamper
		MAX	maximum
		M	megohm
		MEG	meg (10 ⁶) (used in parts list)
		MET FLM	metal film
		MET OX	metallic oxide
		MF	medium frequency; microfarad (used in parts list)
		MFR	manufacturer
		mg	milligram
		MHz	megahertz
		mH	millihenry
		mho	mho
		min	minute (time)
		...°	minute (plane angle)
		MINAT	miniature
		mm	millimeter

NOTE

All abbreviations in the parts list will be in upper-case.

Table 6-2. Abbreviations (2 of 2)

MOD modulator	OD outside diameter	PWV peak working voltage	TD time delay
MOM momentary	OH oval head	RC resistance-capacitance	TERM terminal
MOS metal-oxide semiconductor	OP AMPL operational amplifier	RECT rectifier	TFT thin-film transistor
ms millisecond	OPT option	REF reference	TGL toggle
MTG mounting	OSC oscillator	REG regulated	THD thread
MTR meter (indicating device)	OX oxide	REPL replaceable	THRU through
mV millivolt	oz ounce	RF radio frequency	TI titanium
mVac millivolt, ac	Ω ohm	RFI radio frequency interference	TOL tolerance
mVdc millivolt, dc	P peak (used in parts list)	RH round head; right hand	TRIM trimmer
mVpk millivolt, peak	PAM pulse-amplitude modulation	RLC resistance-inductance-capacitance	TSTR transistor
mVp-p millivolt, peak-to-peak	PC printed circuit	RMO rack mount only	TTL transistor-transistor logic
mVrms millivolt, rms	PCM pulse-code modulation; pulse-count modulation	rms root-mean-square	TV television
mW milliwatt	PDM pulse-duration modulation	RND round	TVI television interference
MUX multiplex	pF picofarad	ROM read-only memory	TWT traveling wave tube
MY mylar	PH BRZ phosphor bronze	R&P rack and panel	U micro (10 ⁻⁶) (used in parts list)
μA microampere	PHL Phillips	RWV reverse working voltage	UF microfarad (used in parts list)
μF microfarad	PIN positive-intrinsic-negative	S scattering parameter	UHF ultrahigh frequency
μH microhenry	PIV peak inverse voltage	s second (time)	UNDEF undefined
μmho micromho	pk peak	" second (plane angle)	UNREG unregulated
μs microsecond	PL phase lock	S-B slow-blow (fuse) (used in parts list)	V volt
μV microvolt	PLO phase lock oscillator	SCR silicon controlled rectifier; screw	VA voltampere
μVac microvolt, ac	PM phase modulation	SE selenium	Vac volts, ac
μVdc microvolt, dc	PNP positive-negative-positive	SECT sections	VAR variable
μVpk microvolt, peak	P/O part of	SEMICON semiconductor	VCO voltage-controlled oscillator
μVp-p microvolt, peak-to-peak	POLY polystyrene	SHF superhigh frequency	Vdc volts, dc
μVrms microvolt, rms	PORC porcelain	SI silicon	VDCW volts, dc, working (used in parts list)
μW microwatt	POS positive; position(s) (used in parts list)	SIL silver	V(F) volts, filtered
nA nanoampere	POSN position	SL slide	VFO variable-frequency oscillator
NC no connection	POT potentiometer	SNR signal-to-noise ratio	VHF very-high frequency
N/C normally closed	p-p peak-to-peak	SPDT single-pole, double-throw	Vpk volts, peak
NE neon	PP peak-to-peak (used in parts list)	SPG spring	Vp-p volts, peak-to-peak
NEG negative	PPM pulse-position modulation	SR split ring	Vrms volts, rms
nF nanofarad	PREAMPL preamplifier	SPST single-pole, single-throw	VSWR voltage standing wave ratio
NI PL nickel plate	PRF pulse-repetition frequency	SS Service Sheet	VTO voltage-tune oscillator
N/O normally open	PRR pulse repetition rate	SSB single sideband	VTVM vacuum-tube voltmeter
NOM nominal	ps picosecond	SST stainless steel	V(X) volts, switched
NORM normal	PT point	STL steel	W watt
NPN negative-positive-negative	PTM pulse-time modulation	SQ square	W/ with
NPO negative-positive zero (zero temperature coefficient)	PWM pulse-width modulation	SWR standing-wave ratio	WIV working inverse voltage
NRFR not recommended for field replacement		SYNC synchronize	WW wirewound
NSR not separately replaceable		T timed (slow-blow fuse)	W/O without
ns nanosecond		TA tantalum	YIG yttrium-iron-garnet
nW nanowatt		TC temperature compensating	Z ₀ characteristic impedance
OBD order by description			

NOTE

All abbreviations in the parts list will be in upper-case.

MULTIPLIERS

Abbreviation	Prefix	Multiple
T	tera	10 ¹²
G	giga	10 ⁹
M	mega	10 ⁶
k	kilo	10 ³
da	deka	10
d	deci	10 ⁻¹
c	centi	10 ⁻²
m	milli	10 ⁻³
μ	micro	10 ⁻⁶
n	nano	10 ⁻⁹
p	pico	10 ⁻¹²
f	femto	10 ⁻¹⁵
a	atto	10 ⁻¹⁸

Table 6-3. Replaceable Parts

Reference Designation	HP Part Number	C	D	Qty.	Description	Mfr. Code	Mfr. Part Number
A1							
<i>2450A TO 2730A</i>							
A1	08903-60166	9		1	KEYBOARD AND DISPLAY ASSEMBLY	28480	08903-60166
<i>2721A AND ABOVE</i>							
A1	08903-60193	2		1	KEYBOARD AND DISPLAY ASSEMBLY	28480	08903-60193
A1C1	0160-0229	7		1	CAPACITOR-FXD 33UF +-10% 10VDC TA	56289	150D336X9010B2
A1C2	0160-2055	9		4	CAPACITOR-FXD .01UF +80-20% 100VDC CER	28480	0160-2055
A1C3	0160-2291	5		1	CAPACITOR-FXD .18UF +-10% 80VDC POLYE	28480	0160-2291
A1C4	0160-2055	9			CAPACITOR-FXD .01UF +80-20% 100VDC CER	28480	0160-2055
C1C5	0160-2055	9			CAPACITOR-FXD .01UF +80-20% 100VDC CER	28480	0160-2055
A1C6	0160-2055	9			CAPACITOR-FXD .01UF +80-20% 100VDC CER	28480	0160-2055
A1DS1	1990-0719	8		14	LED-LAMP LUM-INT=1MCD IF=20MA-MAX BVR=5V	28480	1990-0719
A1DS2	1990-0719	8		14	LED-LAMP LUM-INT=1MCD IF=20MA-MAX BVR=5V	28480	1990-0719
A1DS3	1990-0719	8		14	LED-LAMP LUM-INT=1MCD IF=20MA-MAX BVR=5V	28480	1990-0719
A1DS4	1990-0719	8		14	LED-LAMP LUM-INT=1MCD IF=20MA-MAX BVR=5V	28480	1990-0719
A1DS5	1990-0719	8		14	LED-LAMP LUM-INT=1MCD IF=20MA-MAX BVR=5V	28480	1990-0719
A1DS6	1990-0719	8		14	LED-LAMP LUM-INT=1MCD IF=20MA-MAX BVR=5V	28480	1990-0719
A1DS7	1990-0719	8		14	LED-LAMP LUM-INT=1MCD IF=20MA-MAX BVR=5V	28480	1990-0719
A1DS8	1990-0719	8		14	LED-LAMP LUM-INT=1MCD IF=20MA-MAX BVR=5V	28480	1990-0719
A1DS9	1990-0719	8		2	LED-LAMP LUM-INT=1MCD IF=20MA-MAX BVR=5V	28480	1990-0719
	0380-1231	7		2	SPACER-RND .365-IN-LG .12-IN-ID	00000	ORDER BY DESCRIPTION
A1DS10	1990-0719	8			LED-LAMP LUM-INT=1MCD IF=20MA-MAX BVR=5V	28480	HLMP-1301
	0380-1231	7			SPACER RND .365-IN-LG .12-IN-ID	00000	ORDER BY DESCRIPTION
A1DS11	1990-0618	6		6	LED-LAMP LUM-INT=800UCD IF=20MA-MAX	28480	HLMP-0301
	0340-1196	5		6	MOUNT-L.E.D. 0.120 +- .005 IN ID; 0.187	28480	0340-1196
A1DS12	1990-0618	6			LED-LAMP LUM-INT=800UCD IF=20MA-MAX	28480	HLMP-0301
	0340-1196	5			MOUNT-L.E.D. 0.120 +- .005 IN ID; 0.187	28480	0340-1196
A1DS13	1990-0618	6			LED-LAMP LUM-INT=800UCD IF=20MA-MAX	28480	HLMP-0301
	0340-1196	5			MOUNT-L.E.D. 0.120 +- .005 IN ID; 0.187	28480	0340-1196
A1DS14	1990-0618	6			LED-LAMP LUM-INT=800UCD IF=20MA-MAX	28480	HLMP-0301
A1DS15	1990-0618	6			LED-LAMP LUM-INT=800UCD IF=20MA-MAX	28480	HLMP-0301
	0340-1196	5			MOUNT-L.E.D. 0.120 +- .005 IN ID; 0.187	28480	0340-1196
A1DS16	1990-0618	6			LED-LAMP LUM-INT=800UCD IF=20MA-MAX	28480	HLMP-0301
	0340-1196	5			MOUNT-L.E.D. 0.120 +- .005 IN ID; 0.187	28480	0340-1196
A1DS17	1990-0719	8		14	LED-LAMP LUM-INT=1MCD IF=20MA-MAX BVR=5V	28480	1990-0719
A1DS18	1990-0719	8		14	LED-LAMP LUM-INT=1MCD IF=20MA-MAX BVR=5V	28480	1990-0719
A1DS19	1990-0719	8		14	LED-LAMP LUM-INT=1MCD IF=20MA-MAX BVR=5V	28480	1990-0719
<i>2450A TO 2730A</i>							
<i>A1DS20</i>							
NOT ASSIGNED							
<i>2721A AND ABOVE</i>							
A1DS20	1990-0719	8			LED-LAMP LUM-INT=1MCD IF=20MA-MAX BVR=5V	24840	1990-0719
	0380-1231	7		3	SPACER-RND .365-IN-LG .12-IN-ID	00000	ORDER BY DESCRIPTION
A1J1	1251-4736	1		1	CONNECTOR 26-PIN M RECTANGULAR	28480	1251-4736
A1MP1	5041-0319	7		6	KEY HALF GY-LIT	28480	5041-0319
A1MP2	5041-1832	1		1	KEY HALF HZ/MV	28480	5041-1832
A1MP3	5041-0319	7			KEY HALF GY-LIT	28480	5041-0319
A1MP4	5041-0385	7		3	KEY/HALF SMK GY	28480	5041-0385
A1MP5	5041-1839	8		1	KEY HALF AMPTD	28480	5041-1839
A1MP6	5041-0817	0		1	KEY/HALF SK/GY 7	28480	5041-0817
A1MP7	5041-0813	6		1	KEY/HALF SK/GY 3	28480	5041-0813
A1MP8	5041-1665	8		1	KEY/QUARTER LCL	28480	5041-1665
A1MP9	5041-1842	3		1	K/H PLOT LIMIT	28480	5041-1842
A1MP10	5041-1831	0		1	KEY HALF KHZ/V	28480	5041-1831

†Refer to Section 7 for update information.

*Factory Selected Component (Refer to Section 5).

Δ Errata part change.

Table 6-3. Replaceable Parts

Reference Designation	HP Part Number	C D	Qty.	Description	Mfr Code	Mfr. Part Number
A1MP11	5041-0319	7		KEY HALF GY-LIT	28480	5041-0319
A1MP12	5041-0319	7		KEY HALF GY-LIT	28480	5041-0319
A1MP13	5041-1838	7	1	KEY HALF FREQ	28480	5041-1838
A1MP14	5041-0816	9	2	KEY/HALF SK/GY 6	28480	5041-0816
A1MP15	5041-0812	5	1	KEY/HALF SK/GY 2	28480	5041-0812
A1MP16	5041-0408	5	1	KEY/QTR EB/BLK	28480	5041-0408
A1MP17	5041-1840	1	1	K/H FREQ/INCR	28480	5041-1840
A1MP18	5041-1837	6	1	K/H STOP/FREQ	28480	5041-1837
A1MP19	5041-0319	7		KEY HALF GY-LIT	28480	5041-0319
A1MP20	5041-0385	7		KEY/HALF SMK GY	28480	5041-0385
A1MP21	5041-0816	9		KEY/HALF SK/GY 6	28480	5041-0816
A1MP22	5041-0815	8	1	KEY/HALF SK/GY 5	28480	5041-0815
A1MP23	5041-0811	4	1	KEY/HALF SK/GY 1	28480	5041-0811
A1MP24	5041-0417	6	1	KEY/QTR BLK S/LT	28480	5041-0417
A1MP25	5041-1641	0	1	KEY HALF DIV GY	28480	5041-1641
A1MP26	5041-1836	5	1	K/H START/FREQ	28480	5041-1836
A1MP27	5041-0319	7		KEY HALF GY-LIT	28480	5041-0319
A1MP28	5041-0385	7		KEY/HALF SMK GY	28480	5041-0385
A1MP29	5041-0818	1	1	KEY/HALF SK/GY 8	28480	5041-0818
A1MP30	5041-0814	7	1	KEY/HALF SK/GY 4	28480	5041-0814
A1MP31	5041-0819	2	1	KEY/HALF SK/GY 0	28480	5041-0819
A1MP32	5041-1640	9	1	KEY HALF X10 GY	28480	5041-1640
A1MP33	5041-0808	9	1	KEY/HALF GY DOT	28480	5041-0808
A1MP34	5041-1841	2	1	K/H AMPTD/INCR	28480	5041-1841
A1MP35	5041-1834	3	1	KEY HALF CLEAR	28480	5041-1834
A1MP36	5041-1843	4	2	K/H ARROW	28480	5041-1843
A1MP37	5041-1835	4	1	KEY HALF	28480	5041-1835
A1MP38	5041-0286	7	1	KEY HALF GY LIT	28480	5041-0286
A1MP39	5041-1843	4		K/H ARROW	28480	5041-1843
A1MP40	5041-0508	6	1	KEY/HALF GR	28480	5041-0508
A1MP41	5041-0319	7	1	KEY CAP-HALF GRAY-LIT	28480	5041-0319
A1R1	1810-0402	6	11	NETWORK-RES 16-DIP330.0 OHM X 8	01121	316B331
A1R2	1810-0205	7	1	NETWORK-RES 8-SIP4.7K OHM X 7	01121	208A472
A1R3	0698-3155	1	1	RESISTOR 4.64K 1% .125W F TC=0+-100	24546	C4-1/8-T0-4641-F
A1R4	0757-0199	3	1	RESISTOR 21.5K 1% .125W F TC=0+-100	24546	C4-1/8-T0-2152-F
A1R5	1810-0207	9	1	NETWORK-RES 8-SIP22.0K OHM X 7	01121	208A223
A1R6	1810-0208	0	1	NETWORK-RES 8-SIP68.0K OHM X 7	01121	208A683
A1R7	0757-0461	2	2	RESISTOR 68.1K 1% .125W F TC=0+-100	24546	C4-1/8-T0-6812-F
A1R8	0698-0082	7	1	RESISTOR 464 1% .125W F TC=0+-100	24546	C4-1/8-T0-464R-F
A1R9	0698-3453	2	1	RESISTOR 196K 1% .125W F TC=0+-100	24546	C4-1/8-T0-1963-F
A1R10	0757-0461	2		RESISTOR 68.1K 1% .125W F TC=0+-100	24546	C4-1/8-T0-6812-F
A1R11	0757-0447	4	1	RESISTOR 16.2K 1% .125W F TC=0+-100	24546	C4-1/8-T0-1622-F
A1R12	0757-0438	3	1	RESISTOR 5.11K 1% .125W F TC=0+-100	24546	C4-1/8-T0-5111-F
A1R13	0698-3445	2	4	RESISTOR 348 1% .125W F TC=0+-100	24546	C4-1/8-T0-348R-F
A1R14	0698-3445	2		RESISTOR 348 1% .125W F TC=0+-100	24546	C4-1/8-T0-348R-F
A1R15	0698-3445	2		RESISTOR 348 1% .125W F TC=0+-100	24546	C4-1/8-T0-348R-F
A1R16	0698-3445	2		RESISTOR 348 1% .125W F TC=0+-100	24546	C4-1/8-T0-348R-F
A1R17	1810-0229	5	1	NETWORK-RES 8-SIP330.0 OHM X 7	01121	208A331
A1R19	1810-0402	6		NETWORK-RES 16-DIP330.0 OHM X 8	01121	316B331
A1R20	1810-0402	6		NETWORK-RES 16-DIP330.0 OHM X 8	01121	316B331
A1R21	1810-0402	6		NETWORK-RES 16-DIP330.0 OHM X 8	01121	316B331

† Refer to Section 7 for update information.

* Factory Selected Component (Refer to Section 5).

Δ Errata part change.

Table 6-3. Replaceable Parts

Reference Designation	HP Part Number	C D	Qty.	Description	Mfr. Code	Mfr. Part Number
A1R22	1810-0402	6		NETWORK-RES 16-DIP330.0 OHM X 8	01121	316B331
A1R23	1810-0402	6		NETWORK-RES 16-DIP330.0 OHM X 8	01121	316B331
A1R24	1810-0402	6		NETWORK-RES 16-DIP330.0 OHM X 8	01121	316B331
A1R25	1810-0402	6		NETWORK-RES 16-DIP330.0 OHM X 8	01121	316B331
A1R26	1810-0402	6		NETWORK-RES 16-DIP330.0 OHM X 8	01121	316B331
A1R27	1810-0402	6		NETWORK-RES 16-DIP330.0 OHM X 8	01121	316B331
A1R28	0757-0280	3	1	RESISTOR 1K 1% .125W F TC=0+-100	24546	C4-1/8-T0-1001-F
2450A TO 2730A						
A1R29				NOT ASSIGNED		
2724A AND ABOVE						
A1R29	0698-3444	1		RESISTOR 316 1% .125W F TC=0+-100	24546	0698-3444
A1S1-A1S41	5060-9436	7	41	PUSHBUTTON SWITCH P.C. MOUNT	28480	5060-9436
A1U1	1820-1729	3	13	IC LCH TTL LS COM CLEAR 8-BIT	01295	SN74LS259N
A1U2	1990-0753	0	10	DISPLAY-NUM-SEG 10-CHAR .43-H RED	28480	1990-0753
	1200-1027	0	10	SOCKET-DSPL 14-CONT DIP DIP-SLDR	28480	1200-1027
A1U3	1990-0753	0		DISPLAY-NUM-SEG 10-CHAR .43-H RED	28480	1990-0753
	1200-1027	0		SOCKET-DSPL 14-CONT DIP DIP-SLDR	28480	1200-1027
A1U4	1990-0753	0		DISPLAY-NUM-SEG 10-CHAR .43-H RED	28480	1990-0753
	1200-1027	0		SOCKET-DSPL 14-CONT DIP DIP-SLDR	28480	1200-1027
A1U5	1990-0753	0		DISPLAY-NUM-SEG 10-CHAR .43-H RED	28480	1990-0753
	1200-1027	0		SOCKET-DSPL 14-CONT DIP DIP-SLDR	28480	1200-1027
A1U6	1990-0753	0		DISPLAY-NUM-SEG 10-CHAR .43-H RED	28480	1990-0753
	1200-1027	0		SOCKET-DSPL 14-CONT DIP DIP-SLDR	28480	1200-1027
A1U7	1820-1729	3		IC LCH TTL LS COM CLEAR 8-BIT	01295	SN74LS259N
A1U8	1990-0753	0		DISPLAY-NUM-SEG 10-CHAR .43-H RED (Refer to Note 1 on page 8D-114.1 for the correct orientation of A1U8)	28480	1990-0753
	1200-1027	0		SOCKET-DSPL 14-CONT DIP DIP-SLDR	28480	1200-1027
A1U9	1990-0753	0		DISPLAY-NUM-SEG 10-CHAR .43-H RED	28480	1990-0753
	1200-1027	0		SOCKET-DSPL 14-CONT DIP DIP-SLDR	28480	1200-1027
A1U10	1990-0753	0		DISPLAY-NUM-SEG 10-CHAR .43-H RED	28480	1990-0753
	1200-1027	0		SOCKET-DSPL 14-CONT DIP DIP-SLDR	28480	1200-1027
A1U11	1990-0753	0		DISPLAY-NUM-SEG 10-CHAR .43-H RED	28480	1990-0753
	1200-1027	0		SOCKET-DSPL 14-CONT DIP DIP-SLDR	28480	1200-1027
A1U12	1990-0753	0		DISPLAY-NUM-SEG 10-CHAR .43-H RED	28480	1990-0753
	1200-1027	0		SOCKET-DSPL 14-CONT DIP DIP-SLDR	28480	1200-1027
A1U13	1820-1729	3		IC LCH TTL LS COM CLEAR 8-BIT	01295	SN74LS259N
A1U14	1820-1729	3		IC LCH TTL LS COM CLEAR 8-BIT	01295	SN74LS259N
A1U15	1820-1729	3		IC LCH TTL LS COM CLEAR 8-BIT	01295	SN74LS259N
A1U16	1820-1729	3		IC LCH TTL LS COM CLEAR 8-BIT	01295	SN74LS259N
A1U17	1820-1729	3		IC LCH TTL LS COM CLEAR 8-BIT	01295	SN74LS259N
A1U18	1820-1729	3		IC LCH TTL LS COM CLEAR 8-BIT	01295	SN74LS259N
A1U19	1820-1729	3		IC LCH TTL LS COM CLEAR 8-BIT	01295	SN74LS259N
A1U20	1820-1729	3		IC LCH TTL LS COM CLEAR 8-BIT	01295	SN74LS259N
A1U21	1820-1729	3		IC LCH TTL LS COM CLEAR 8-BIT	01295	SN74LS259N
A1U22	1826-0412	1	1	IC COMPARATOR PRCN DUAL 8-DIP-P PKG	27014	LM393N
A1U23	1820-1144	6	1	IC GATE TTL LS NOR QUAD 2-INP	01295	SN74LS02N
A1U24	1820-1417	6	2	IC GATE TTL LS NAND QUAD 2-INP	01295	SN74LS26N
A1U25	1820-1417	6		IC GATE TTL LS NAND QUAD 2-INP	01295	SN74LS26N
A1U26	1820-1729	3		IC LCH TTL LS COM CLEAR 8-BIT	01295	SN74LS259N
A1U27	1820-1729	3		IC LCH TTL LS COM CLEAR 8-BIT	01295	SN74LS259N
A1U28	1820-1216	3	2	IC DCDR TTL LS 3-TO-8-LINE 3-INP	01295	SN74LS138N
A1U29	1820-1216	3		IC DCDR TTL LS 3-TO-8-LINE 3-INP	01295	SN74LS138N
A1U30	1820-1427	8	1	IC DCDR TTL LS 2-TO-4-LINE DUAL 2-INP	01295	SN74LS156N

†Refer to Section 7 for update information.

*Factory Selected Component (Refer to Section 5).

Δ Errata part change.

Table 6-3. Replaceable Parts

Reference Designation	HP Part Number	C D	Qty.	Description	Mfr. Code	Mfr. Part Number
A2						
A2	08903-60170	5	1	INPUT AMPLIFIER ASSEMBLY (INCLUDES A2W3 AND A2W4, DOES NOT INCLUDE A2A1 OR A2A2)	28480	08903-60170
A2	08903-69170	3	1	INPUT AMPLIFIER ASSEMBLY (RESTORED)	28480	08903-69170
A2C1	0180-2195	0	2	CAPACITOR-FXD 15UF +-10% 35VDC TA	56289	150D156X9035R2
A2C2	0160-6370	9	2	C MPE 1.5U 600V	28480	0160-6370
A2C3	0121-0422	8	4	CAPACITOR-V TRMR-PSTN .8-4.5PF 1250V	18736	TP5G
	0340-0669	9	4	INSULATOR-XSTR SLBL-ORG-POLYM	28480	0340-0669
A2C4	0160-2265	3		CAPACITOR-FXD 22PF +-5% 500VDC CER 0+-30	28480	0160-2265
A2C5	0160-4832	4	58	CAPACITOR-FXD .01UF +-10% 100VDC CER	28480	0160-4832
A2C6	0160-4786	7	5	CAPACITOR-FXD 27PF +-5% 100VDC CER 0+-30	28480	0160-4786
A2C7	0160-2237	9	2	CAPACITOR-FXD 1.2PF +--.25PF 500VDC CER	28480	0160-2237
A2C8	0160-4801	7	7	CAPACITOR-FXD 100PF +-5% 100VDC CER	28480	0160-4801
A2C10	0121-0422	8		CAPACITOR-V TRMR-PSTN .8-4.5PF 1250V	18736	TP5G
	0340-0669	9		INSULATOR-XSTR SLBL-ORG-POLYM	28480	0340-0669
A2C11	0160-4786	7		CAPACITOR-FXD 27PF +-5% 100VDC CER 0+-30	28480	0160-4786
A2C12	0160-2236	8	4	CAPACITOR-FXD 1PF +--.25PF 500VDC CER	28480	0160-2236
A2C13	0160-0228	6	4	CAPACITOR-FXD 22UF +-10% 15VDC TA	56289	150D226X9015B2
A2C14	0160-4835	7	36	CAPACITOR-FXD .1UF +-10% 50VDC CER	28480	0160-4835
A2C15	0160-4832	4		CAPACITOR-FXD .01UF +-10% 100VDC CER	28480	0160-4832
A2C16	0160-4832	4		CAPACITOR-FXD .01UF +-10% 100VDC CER	28480	0160-4832
A2C17	0180-2195	0	2	CAPACITOR-FXD 15UF +-10% 35VDC TA	56289	150D156X9035R2
A2C18	0160-5549	2	2	CAPACITOR-FXD .068UF +-5% 100VDC	28480	0160-5549
A2C19	0160-4832	4		CAPACITOR-FXD .01UF +-10% 100VDC CER	28480	0160-4832
A2C20	0160-4832	4		CAPACITOR-FXD .01UF +-10% 100VDC CER	28480	0160-4832
A2C21	0160-4832	4		CAPACITOR-FXD .01UF +-10% 100VDC CER	28480	0160-4832
A2C22	0160-4835	7		CAPACITOR-FXD .1UF +-10% 50VDC CER	28480	0160-4835
A2C23	0160-4835	7		CAPACITOR-FXD .1UF +-10% 50VDC CER	28480	0160-4835
A2C24				NOT ASSIGNED		
A2C25	0160-4801	7		CAPACITOR-FXD 100PF +-5% 100VDC CER	28480	0160-4801
A2C26	0160-4803	9	3	CAPACITOR-FXD 68PF +-5% 100VDC CER 0+-30	28480	0160-4803
A2C27	0160-4803	9		CAPACITOR-FXD 68PF +-5% 100VDC CER 0+-30	28480	0160-4803
A2C28	0160-4835	7		CAPACITOR-FXD .1UF +-10% 50VDC CER	28480	0160-4835
A2C29	0160-4835	7		CAPACITOR-FXD .1UF +-10% 50VDC CER	28480	0160-4835
A2C30	0160-4835	7		CAPACITOR-FXD .1UF +-10% 50VDC CER	28480	0160-4835
A2C31	0160-4835	7		CAPACITOR-FXD .1UF +-10% 50VDC CER	28480	0160-4835
A2C32	0160-4803	9		CAPACITOR-FXD 68PF +-5% 100VDC CER 0+-30	28480	0160-4803
A2C33				NOT ASSIGNED		
A2C34	0160-4835	7		CAPACITOR-FXD .1UF +-10% 50VDC CER	28480	0160-4835
A2C35	0160-4835	7		CAPACITOR-FXD .1UF +-10% 50VDC CER	28480	0160-4835
A2C36	0160-4835	7		CAPACITOR-FXD .1UF +-10% 50VDC CER	28480	0160-4835
A2C37	0180-2207	5	5	CAPACITOR-FXD 100UF +-10% 10VDC TA	56289	150D107X9010R2
A2C38	0180-2207	5		CAPACITOR-FXD 100UF +-10% 10VDC TA	56289	150D107X9010R2
A2C39	0160-4835	7		CAPACITOR-FXD .1UF +-10% 50VDC CER	28480	0160-4835
A2C40	0160-4786	7		CAPACITOR-FXD 27PF +-5% 100VDC CER 0+-30	28480	0160-4786
A2C41	0160-4835	7		CAPACITOR-FXD .1UF +-10% 50VDC CER	28480	0160-4835
A2C42	0160-4835	7		CAPACITOR-FXD .1UF +-10% 50VDC CER	28480	0160-4835

†Refer to Section 7 for update information.

*Factory Selected Component (Refer to Section 5).

Δ Errata part change.

Table 6-3. Replaceable Parts

Reference Designation	HP Part Number	C D	Qty.	Description	Mfr. Code	Mfr. Part Number
A2C43-C52				NOT ASSIGNED		
A2C53	0180-0100	3	3	CAPACITOR-FXD 4.7UF +-10% 35VDC TA	56289	150D475X9035B2
A2C54				NOT ASSIGNED		
A2C55				NOT ASSIGNED		
A2C56	0160-4835	7		CAPACITOR-FXD .1UF +-10% 50VDC CER	28480	0160-4835
A2C57	0160-4835	7		CAPACITOR-FXD .1UF +-10% 50VDC CER	28480	0160-4835
A2C58-C60				NOT ASSIGNED		
A2C61	0160-4834	6	3	CAPACITOR-FXD .047UF +-10% 100VDC CER	28480	0160-4834
A2C62-C69				NOT ASSIGNED		
A2C70	0160-4819	7	1	CAPACITOR-FXD 2200PF +-5% 100VDC CER	28480	0160-4819
A2C71-C76				NOT ASSIGNED		
A2C77	0160-4791	4	9	CAPACITOR-FXD 10PF +-5% 100VDC CER 0+-30	28480	0160-4791
A2C78	0160-4835	7		CAPACITOR-FXD .1UF +-10% 50VDC CER	28480	0160-4835
A2C79	0160-4835	7		CAPACITOR-FXD .1UF +-10% 50VDC CER	28480	0160-4835
A2C80	0160-4791	4		CAPACITOR-FXD 10PF +-5% 100VDC CER 0+-30	28480	0160-4791
A2C81	0160-4832	4		CAPACITOR-FXD .01UF +-10% 100VDC CER	28480	0160-4832
A2C82				NOT ASSIGNED		
A2C83				NOT ASSIGNED		
A2C84	0160-4791	4		CAPACITOR-FXD 10PF +-5% 100VDC CER 0+-30	28480	0160-4791
A2C85	0160-4791	4		CAPACITOR-FXD 10PF +-5% 100VDC CER 0+-30	28480	0160-4791
A2C86	0160-4801	7		CAPACITOR-FXD 100PF +-5% 100VDC CER	28480	0160-4801
A2C87	0160-4801	7		CAPACITOR-FXD 100PF +-5% 100VDC CER	28480	0160-4801
A2C88	0160-6370	9		C MPE 1.5U 600V	28480	0160-6370
A2C89	0160-2264	2		CAPACITOR-FXD 20PF +-5% 500VDC CER 0+-30	28480	0160-2264
A2C90	0121-0422	8		CAPACITOR-V TRMR-PSTN .8-4.5PF 1250V	18736	TP5G
A2C91	0160-4786	7		CAPACITOR-FXD 27PF +-5% 100VDC CER 0+-30	28480	0160-4786
A2C92	0121-0422	8		CAPACITOR-V TRMR-PSTN .8-4.5PF 1250V	18736	TP5G
A2C93	0160-5549	2		CAPACITOR-FXD .068UF +-5% 100VDC	28480	0160-5549
A2C94	0160-4832	4		CAPACITOR-FXD .01UF +-10% 100VDC CER	28480	0160-4832
A2C95	0160-4832	4		CAPACITOR-FXD .01UF +-10% 100VDC CER	28480	0160-4832
A2C96	0160-4832	4		CAPACITOR-FXD .01UF +-10% 100VDC CER	28480	0160-4832
A2C97	0160-4835	7		CAPACITOR-FXD .1UF +-10% 50VDC CER	28480	0160-4835
A2C98	0160-4835	7		CAPACITOR-FXD .1UF +-10% 50VDC CER	28480	0160-4835
A2C99	0160-2237	9		CAPACITOR-FXD 1.2PF +-25PF 500VDC CER	28480	0160-2237
A2C100	0160-4786	7		CAPACITOR-FXD 27PF +-5% 100VDC CER 0+-30	28480	0160-4786
A2C101	0160-2236	8		CAPACITOR-FXD 1PF +-25PF 500VDC CER	28480	0160-2236
A2C103	0160-4801	7		CAPACITOR-FXD 100PF +-5% 100VDC CER	28480	0160-4801
A2C104	0160-4832	4		CAPACITOR-FXD .01UF +-10% 100VDC CER	28480	0160-4832
A2C105	0160-4791	4		CAPACITOR-FXD 10PF +-5% 100VDC CER 0+-30	28480	0160-4791
A2C106	0160-4801	7		CAPACITOR-FXD 100PF +-5% 100VDC CER	28480	0160-4801
A2C107	0160-4791	4		CAPACITOR-FXD 10PF +-5% 100VDC CER 0+-30	28480	0160-4791
A2C108	0160-4801	7		CAPACITOR-FXD 100PF +-5% 100VDC CER	28480	0160-4801
A2C109	0121-0527	4	2	CAPACITOR-V TRIMMER-POLYCARBONATE FILM	28480	0121-0527
A2C110	0121-0527	4		CAPACITOR-V TRIMMER-POLYCARBONATE FILM	28480	0121-0527

†Refer to Section 7 for update information.

*Factory Selected Component (Refer to Section 5).

Δ Errata part change.

Table 6-3. Replaceable Parts

Reference Designation	HP Part Number	C D	Qty.	Description	Mfr. Code	Mfr. Part Number
A2CR1	1901-0050	3	57	DIODE-SWITCHING 80V 200MA 2NS DO-35	28480	1901-0050
A2CR2	1901-0050	3		DIODE-SWITCHING 80V 200MA 2NS DO-35	28480	1901-0050
A2CR3	1901-0050	3		DIODE-SWITCHING 80V 200MA 2NS DO-35	28480	1901-0050
A2CR4	1901-0050	3		DIODE-SWITCHING 80V 200MA 2NS DO-35	28480	1901-0050
A2CR5	1901-0050	3		DIODE-SWITCHING 80V 200MA 2NS DO-35	28480	1901-0050
A2CR6	1901-0050	3		DIODE-SWITCHING 80V 200MA 2NS DO-35	28480	1901-0050
A2CR7	1901-0050	3		DIODE-SWITCHING 80V 200MA 2NS DO-35	28480	1901-0050
A2CR8				NOT ASSIGNED		
<i>2450A TO 2520A</i>						
A2CR9	1901-0376	6		DIODE-GEN PRP 35V 50MA DO-35	28480	1901-0376
A2CR10	1901-0050	3		DIODE-SWITCHING 80V 200MA 2NS DO-354	28480	1901-0050
A2CR11	1901-0376	6		DIODE-GEN PRP 35V 50MA DO-35	28480	1901-0376
A2CR12	1901-0050	3		DIODE-SWITCHING 80V 200MA 2NS DO-35	28480	1901-0050
<i>2601A AND ABOVE</i>						
A2CR9	1901-0050	3	44	DIODE-SWITCHING 80V 200MA 2NS DO-35	28480	1901-0050
A2CR10	1901-0880	7		DIODE-GEN PRP 125MA DO-35	28480	1901-0880
A2CR11	1901-0050	3	44	DIODE-SWITCHING 80V 200MA 2NS DO-35	28480	1901-0050
A2CR12	1901-0880	7		DIODE-GEN PRP 125MA DO-35	28480	1901-0880
A2CR13-CR17				NOT ASSIGNED		
A2CR18	1901-0050	3		DIODE-SWITCHING 80V 200MA 2NS DO-35	28480	1901-0050
A2CR19				NOT ASSIGNED		
A2CR20				NOT ASSIGNED		
A2CR21	1901-0050	3		DIODE-SWITCHING 80V 200MA 2NS DO-35	28480	1901-0050
A2CR22	1901-0050	3		DIODE-SWITCHING 80V 200MA 2NS DO-35	28480	1901-0050
A2CR23				NOT ASSIGNED		
A2CR24	1901-0050	3		DIODE-SWITCHING 80V 200MA 2NS DO-35	28480	1901-0050
<i>2450A TO 2520A</i>						
A2CR25	1901-0050	3		DIODE-SWITCHING 80V 200MA 2NS DO-35	28480	1901-0050
A2CR26	1901-0376	6		DIODE-GEN PRP 35V 50MA DO-35	28480	1901-0376
A2CR27	1901-0050	3		DIODE-SWITCHING 80V 200MA 2NS DO-35	28480	1901-0050
A2CR28	1901-0376	6		DIODE-GEN PRP 35V 50MA DO-35	28480	1901-0376
<i>2601A AND ABOVE</i>						
A2CR25	1901-0880	7		DIODE-GEN PRP 125MA DO-35	28480	1901-0880
A2CR26	1901-0050	3	44	DIODE-SWITCHING 80V 200MA 2NS DO-35	28480	1901-0050
A2CR27	1901-0880	7		DIODE-GEN PRP 125MA DO-35	28480	1901-0880
A2CR28	1901-0050	3		DIODE-SWITCHING 80V 200MA 2NS DO-35	28480	1901-0050
A2CR29-CR34				NOT ASSIGNED		
A2CR35	1901-0050	3		DIODE-SWITCHING 80V 200MA 2NS DO-35	28480	1901-0050
A2K1	0490-0916	6	2	RELAY-REED 1A 500MA 100VDC 5VDC-COIL	28480	0490-0916
A2K2	0490-0916	6		RELAY-REED 1A 500MA 100VDC 5VDC-COIL	28480	0490-0916
A2K3				NOT ASSIGNED		
A2K4	0490-1484	5	4	RRLY 50W2A 5VDC	28480	0490-1484
A2K5	0490-1484	5		RRLY 50W2A 5VDC	28480	0490-1484
A2K6	0490-1484	5		RRLY 50W2A 5VDC	28480	0490-1484
A2K7	0490-1484	5		RRLY 50W2A 5VDC	28480	0490-1484
A2L1	9140-0114	4	3	INDUCTOR RF-CH-MLD 10UH 10% .166DX.385LG	28480	9140-0114
A2L2	9100-2430	7	2	INDUCTOR RF-CH-MLD 220UH 10%	28480	9100-2430
A2L3	9140-0114	4		INDUCTOR RF-CH-MLD 10UH 10% .166DX.385LG	28480	9140-0114

†Refer to Section 7 for update information.

*Factory Selected Component (Refer to Section 5).

Δ Errata part change.

Table 6-3. Replaceable Parts

Reference Designation	HP Part Number	C D	Qty.	Description	Mfr. Code	Mfr. Part Number
A2MP1	4040-0748	3	8	EXTR-PC BD BLK POLYC .062-BD-THKNS	28480	4040-0748
	1480-0116	8	1	6 PIN-GRV .062-IN-DIA .25-IN-LG STL	28480	1480-0116
A2MP2	4040-0750	7	1	EXTR-PC BD RED POLYC .062-BD-THKNS	28480	4040-0750
	1480-0116	8		PIN-GRV .062-IN-DIA .25-IN-LG STL	28480	1480-0116
A2MP3	0380-1773	2	8	STDF .375L PCB	28480	0380-1773
A2Q1				NOT ASSIGNED		
A2Q2	1855-0277	7	3	TRANSISTOR J-FET 2N5268 P-CHAN D-MODE	04713	2N5268
A2Q3	1853-0459	3	2	TRANSISTOR PNP SI PD=625MW FT=200MHZ	28480	1853-0459
A2Q4	1855-0277	7		TRANSISTOR J-FET 2N5268 P-CHAN D-MODE	04713	2N5268
A2Q5	1855-0277	7		TRANSISTOR J-FET 2N5268 P-CHAN D-MODE	04713	2N5268
A2Q8	1853-0459	3		TRANSISTOR PNP SI PD=625MW FT=200MHZ	28480	1853-0459
A2Q7, A2Q9	08903-80035	3	1	TRANSISTOR-JFET DUAL N-CHAN D-MODE SI	28480	1855-0418
A2Q8	1855-0642	0		TRANSISTOR-JFET DUAL N-CHAN D-MODE TO-71	28480	1855-0642
A2Q9				SEE A2Q7 (MATCHED PAIR)		
A2Q10	1855-0642	0		TRANSISTOR-JFET DUAL N-CHAN D-MODE TO-71	28480	1855-0642
A2R1				NOT ASSIGNED		
A2R2	0757-0159	5	2	RESISTOR 1K 1% .5W F TC=0+-100	28480	0757-0159
A2R3	0699-0413	0	2	RESISTOR 112 32K .1% 1W F TC=0+-25	28480	0699-0413
A2R4	0699-0526	6	3	RESISTOR 37 68K .1% .25W F TC=0+-25	28480	0699-0526
A2R5	0698-8825	2	3	RESISTOR 681K 1% .125W F TC=0+-100	28480	0698-8825
A2R6	0699-0402	7	2	RESISTOR 281.07K .1% .5W F TC=0+-25	28480	0699-0402
A2R7	0699-0405	0	2	RESISTOR 15.93K .1% .25W F TC=0+-25	28480	0699-0405
A2R8	0698-6348	0	6	RESISTOR 3K 1% .125W F TC=0+-25	28480	0698-6348
A2R9	0698-3455	4	2	RESISTOR 261K 1% .125W F TC=0+-100	24546	C4-1/8-TO-2613-F
A2R10				NOT ASSIGNED		
A2R11				NOT ASSIGNED		
A2R12	0698-3152	8	3	RESISTOR 3.48K 1% .125W F TC=0+-100	24546	C4-1/8-TO-3481-F
A2R13	0757-0465	6	14	RESISTOR 100K 1% .125W F TC=0+-100	24546	C4-1/8-TO-1003-F
A2R14	0757-0290	5	9	RESISTOR 6.19K 1% .125W F TC=0+-100	19701	MF4C1/8-TO-6191-F
A2R15	0757-0465	6		RESISTOR 100K 1% .125W F TC=0+-100	24546	C4-1/8-TO-1003-F
A2R16				NOT ASSIGNED		
A2R17	0757-0833	2	2	RESISTOR 5.11K 1% .5W F TC=0+-100	28480	0757-0833
A2R18				NOT ASSIGNED		
A2R19				NOT ASSIGNED		
A2R20	0698-3150	6	5	RESISTOR 2.37K 1% .125W F TC=0+-100	24546	C4-1/8-TO-2371-F
A2R21				NOT ASSIGNED		
A2R22	0698-3150	6		RESISTOR 2.37K 1% .125W F TC=0+-100	24546	C4-1/8-TO-2371-F
A2R23-R25				NOT ASSIGNED		
A2R26	0698-7196	8	28	RESISTOR 21.5 1% .05W F TC=0+-100	24546	C3-1/8-TO-21R5-F
A2R27	0698-7196	8		RESISTOR 21.5 1% .05W F TC=0+-100	24546	C3-1/8-TO-21R5-F
A2R28	0698-0447	0	2	RESISTOR 683.8 .1% .125W F TC=0+-25	28480	0698-0447
A2R29	0699-0412	9	2	RESISTOR 493 1% .25W F TC=0+-25	28480	0699-0412
A2R30	0699-0412	9		RESISTOR 493 .1% .25W F TC=0+-25	28480	0699-0412
A2R31	0698-7196	8		RESISTOR 21.5 1% .05W F TC=0+-100	24546	C3-1/8-TO-21R5-F
A2R32	0698-7196	8		RESISTOR 21.5 1% .05W F TC=0+-100	24546	C3-1/8-TO-21R5-F
A2R33	0699-0407	2	1	RESISTOR 1.749K .1% .25W F TC=0+-25	28480	0699-0407
A2R34	0698-7196	8		RESISTOR 21.5 1% .05W F TC=0+-100	24546	C3-1/8-TO-21R5-F
A2R35	0698-7196	8		RESISTOR 21.5 1% .05W F TC=0+-100	24546	C3-1/8-TO-21R5-F

†Refer to Section 7 for update information.

*Factory Selected Component (Refer to Section 5).

△ Errata part change.

Table 6-3. Replaceable Parts

Reference Designation	HP Part Number	C D	Qty.	Description	Mfr. Code	Mfr. Part Number
A2R36	0699-0409	4	2	RESISTOR 1.3224K .1% .25W F TC=0+-25	28480	0699-0409
A2R37	0699-0409	4		RESISTOR 1.3224K .1% .25W F TC=0+-25	28480	0699-0409
A2R38	0757-0280	3	43	RESISTOR 1K 1% .125W F TC=0+-100	24546	C4-1/8-T0-1001-F
A2R39	0757-0280	3		RESISTOR 1K 1% .125W F TC=0+-100	24546	C4-1/8-T0-1001-F
A2R40	0698-8835	4	3	RESISTOR 5K .1% .125W F TC=0+-10	28480	0698-8835
A2R41	0698-8835	4		RESISTOR 5K .1% .125W F TC=0+-10	28480	0698-8835
A2R42	0699-0513	1	1	RESISTOR 4.98K .1% .1W F TC=0+-10	28480	0699-0513
A2R43	2100-0552	3	1	RESISTOR-TRMR 50 10% C SIDE-ADJ 1-TPN	28480	2100-0552
A2R44	2100-3355	0	3	RESISTOR-TRMR 100K 10% C SIDE-ADJ 1-TPN	28480	2100-3355
A2R45	0698-7196	8		RESISTOR 21.5 1% .05W F TC=0+-100	24546	C3-1/8-T0-21R5-F
A2R46	0698-8835	4		RESISTOR 5K .1% .125W F TC=0+-10	28480	0698-8835
A2R47	0698-7265	2	1	RESISTOR 16.2K 1% .05W F TC=0+-100	24546	C3-1/8-T0-1622-F
A2R48	0698-7196	8		RESISTOR 21.5 1% .05W F TC=0+-100	24546	C3-1/8-T0-21R5-F
A2R49	0757-0280	3		RESISTOR 1K 1% .125W F TC=0+-100	24546	C4-1/8-T0-1001-F
A2R50	1810-0207	9	1	NETWORK-RES 8-SIP22.0K OHM X 7	01121	208A223
A2R51	0698-7256	1	3	RESISTOR 6.81K 1% .05W F TC=0+-100	24546	C3-1/8-T0-6811-F
A2R52				NOT ASSIGNED		
A2R53				NOT ASSIGNED		
A2R54	0698-7253	8	8	RESISTOR 5.11K 1% .05W F TC=0+-100	24546	C3-1/8-T0-5111-F
A2R55				NOT ASSIGNED		
A2R56	0698 7404	1	1	RESISTOR 1.005K .1% .125W F TC=0+-50	19701	MF4C1,8-T2-1005R-B
A2R57	0699-0411	8	1	RESISTOR 634 .1% .25W F TC=0+-25	28480	0699-0411
A2R58	0698-6355	9	1	RESISTOR 400 .1% .125W F TC=0+-25	28480	0698-6355
A2R59	0698-6447	0		RESISTOR 683 8 .1% .125W F TC=0+-25	28480	0698-6447
A2R60	0757-0280	3		RESISTOR 1K 1% .125W F TC=0+-100	24546	C4-1/8-T0-1001-F
A2R61	0698-7196	8		RESISTOR 21.5 1% .05W F TC=0+-100	24546	C3-1/8-T0-21R5-F
A2R62	0698-7196	8		RESISTOR 21.5 1% .05W F TC=0+-100	24546	C3-1/8-T0-21R5-F
A2R63-R66				NOT ASSIGNED		
A2R67	0757-0438	3	24	RESISTOR 5.11K 1% .125W F TC=0+-100	24546	C4-1/8-T0-5111-F
A2R68	0757-0438	3		RESISTOR 5.11K 1% .125W F TC=0+-100	24546	C4-1/8-T0-5111-F
A2R69	0757-0438	3		RESISTOR 5.11K 1% .125W F TC=0+-100	24546	C4-1/8-T0-5111-F
A2R70-R74				NOT ASSIGNED		
A2R75	0698-3157	3	13	RESISTOR 19.6K 1% .125W F TC=0+-100	24546	C4-1/8-T0-1962-F
A2R76	0757-0447	4	7	RESISTOR 18.2K 1% .125W F TC=0+-100	24546	C4-1/8-T0-1622-F
A2R77-R79				NOT ASSIGNED		
A2R80	0757-0439	4	4	RESISTOR 6.81K 1% .125W F TC=0+-100	24546	C4-1/8-T0-6811-F
A2R81	0757-0441	8	3	RESISTOR 8.25K 1% .125W F TC=0+-100	24546	C4-1/8-T0-8251-F
A2R82				NOT ASSIGNED		
A2R83	0757-0280	3		RESISTOR 1K 1% .125W F TC=0+-100	24546	C4-1,8-T0-1001-F
A2R84-86				NOT ASSIGNED		
A2R87	0757-0442	9	39	RESISTOR 10K 1% .125W F TC=0+-100	24546	C4-1/8-T0-1002-F
A2R88-R92				NOT ASSIGNED		

†Refer to Section 7 for update information.

*Factory Selected Component (Refer to Section 5).

Δ Errata part change.

Table 6-3. Replaceable Parts

Reference Designation	HP Part Number	C D	Qty.	Description	Mfr. Code	Mfr. Part Number
A2R92				NOT ASSIGNED		
A2R93	0757-0280	3		RESISTOR 1K 1% .125W F TC=0+-100	24546	C4-1/8-T0-1001-F
A2R94				NOT ASSIGNED		
A2R95				NOT ASSIGNED		
A2R96	0698-7253	8		RESISTOR 5.11K 1% .05W F TC=0+-100	24546	C3-1/8-T0-5111-F
A2R97				NOT ASSIGNED		
A2R98	0698-7255	0	5	RESISTOR 8.19K 1% .05W F TC=0+-100	24546	C3-1/8-T0-6191-F
A2R99	0698-7255	0		RESISTOR 8.19K 1% .05W F TC=0+-100	24546	C3-1/8-T0-6191-F
A2R100	0699-0413	0		RESISTOR 112.32K .1% 1W F TC=0+-25	28480	0699-0413
A2R101	0699-0526	6		RESISTOR 37.68K .1% .25W F TC=0+-25	28480	0699-0526
A2R102	0698-8825	2		RESISTOR 681K 1% .125W F TC=0+-100	28480	0698-8825
A2R103	0699-0402	7		RESISTOR 281.07K .1% .5W F TC=0+-25	28480	0699-0402
A2R104	0757-0159	5		RESISTOR 1K 1% .5W F TC=0+-100	28480	0757-0159
A2R105	0757-0833	2		RESISTOR 5.11K 1% .5W F TC=0+-100	28480	0757-0833
A2R106	0757-0465	6		RESISTOR 100K 1% .125W F TC=0+-100	24546	C4-1/8-T0-1003-F
A2R107	0757-0465	6		RESISTOR 100K 1% .125W F TC=0+-100	24546	C4-1/8-T0-1003-F
A2R108	0698-7254	9	4	RESISTOR 5.62K 1% .05W F TC=0+-100	24546	C3-1/8-T0-5621-F
A2R109	0698-7254	9		RESISTOR 5.62K 1% .05W F TC=0+-100	24546	C3-1/8-T0-5621-F
A2R110	0698-7252	7	4	RESISTOR 4.64K 1% .05W F TC=0+-100	24546	C3-1/8-T0-4641-F
A2R111	0698-7253	8		RESISTOR 5.11K 1% .05W F TC=0+-100	24546	C3-1/8-T0-5111-F
A2R112	0698-7253	8		RESISTOR 5.11K 1% .05W F TC=0+-100	24546	C3-1/8-T0-5111-F
A2R113	0698-7196	8		RESISTOR 21.5 1% .05W F TC=0+-100	24546	C3-1/8-T0-21R5-F
A2R114	0698-7196	8		RESISTOR 21.5 1% .05W F TC=0+-100	24546	C3-1/8-T0-21R5-F
A2R115	0698-7253	8		RESISTOR 5.11K 1% .05W F TC=0+-100	24546	C3-1/8-T0-5111-F
A2R116	0698-7196	8		RESISTOR 21.5 1% .05W F TC=0+-100	24546	C3-1/8-T0-21R5-F
A2R117	0598-7196	8		RESISTOR 21.5 1% .05W F TC=0+-100	24546	C3-1/8-T0-21R5-F
A2R118	0698-7253	8		RESISTOR 5.11K 1% .05W F TC=0+-100	24546	C3-1/8-T0-5111-F
A2R119				NOT ASSIGNED		
A2R120				NOT ASSIGNED		
A2R121	0699-0405	0		RESISTOR 15.93K .1% .25W F TC=0+-25	28480	0699-0405
A2R122	0698-6348	0		RESISTOR 3K .1% .125W F TC=0+-25	28480	0698-6348
A2R123	0698-3455	4		RESISTOR 261K 1% .125W F TC=0+-100	24546	C4-1/8-T0-2613-F
A2R124	0698-7256	1		RESISTOR 6.81K 1% .05W F TC=0+-100	24546	C3-1/8-T0-6811-F
A2R125	0698-7255	0		RESISTOR 6.19K 1% .05W F TC=0+-100	24546	C3-1/8-T0-6191-F
A2R126	0698-7255	0		RESISTOR 6.19K 1% .05W F TC=0+-100	24546	C3-1/8-T0-6191-F
A2R127	0698-7267	4	3	RESISTOR 19.6K 1% .05W F TC=0+-100	24546	C3-1/8-T0-1962-F
A2R128	0698-7284	5	4	RESISTOR 100K 1% .05W F TC=0+-100	24546	C3-1/8-T0-1003-F
A2R129	0698-7284	5		RESISTOR 100K 1% .05W F TC=0+-100	24546	C3-1/8-T0-1003-F
A2R130	0698-7284	5		RESISTOR 100K 1% .05W F TC=0+-100	24546	C3-1/8-T0-1003-F
A2R131	0698-7284	5		RESISTOR 100K 1% .05W F TC=0+-100	24546	C3-1/8-T0-1003-F
A2R132	0698-7260	7	3	RESISTOR 10K 1% .05W F TC=0+-100	24546	C3-1/8-T0-1002-F
A2R133	0698-7260	7		RESISTOR 10K 1% .05W F TC=0+-100	24546	C3-1/8-T0-1002-F
A2R134	0698-7188	8	1	RESISTOR 10 1% .05W F TC=0+-100	24546	0698-7188
A2TP1	1251-0600	0	90	CONNECTOR-SGL CONT PIN 1.14-MM-BSC-SZ SQ	28480	1251-0600
A2TP2	1251-0600	0		CONNECTOR-SGL CONT PIN 1.14-MM-BSC-SZ SQ	28480	1251-0600
A2TP3	1251-0600	0		CONNECTOR-SGL CONT PIN 1.14-MM-BSC-SZ SQ	28480	1251-0600
A2TP4	1251-0600	0		CONNECTOR-SGL CONT PIN 1.14-MM-BSC-SZ SQ	28480	1251-0600
A2TP5	1251-0600	0		CONNECTOR-SGL CONT PIN 1.14-MM-BSC-SZ SQ	28480	1251-0600

† Refer to Section 7 for update information.

* Factory Selected Component (Refer to Section 5).

Δ Errata part change.

Table 6-3. Replaceable Parts

Reference Designation	HP Part Number	C D	Qty.	Description	Mfr. Code	Mfr. Part Number
A2TP6	1251-0600	0		CONNECTOR-SGL CONT PIN 1.14-MM-BSC-SZ SQ	28480	1251-0600
A2TP7	1251-0600	0		CONNECTOR-SGL CONT PIN 1.14-MM-BSC-SZ SQ	28480	1251-0600
A2U1	1826-0421	2	2	IC CONV RMS/DC 14-DIP-C PKG	24355	AD536AJ
A2U2				NOT ASSIGNED		
A2U3	1826-0783	9	16	IC OP AMP LOW-NOISE 8-DIP-C PKG	52063	XR5534ACN
A2U4	1826-0759	9	4	IC COMPARATOR GP QUAD 14-DIP-C PKG	04713	LM339J
A2U5	1826-0783	9		IC OP AMP LOW-NOISE 8-DIP-C PKG	52063	XR5534ACN
A2U6	1826-0783	9		IC OP AMP LOW-NOISE 8-DIP-C PKG	52063	XR5534ACN
A2U7	1826-0413	2	2	IC OP AMP LOW-BIAS-H-IMPDT TO-99 PKG	34371	HA2-2605-5
A2U8				NOT ASSIGNED		
A2U9	1826-0783	9		IC OP AMP LOW-NOISE 8-DIP-C PKG	52063	XR5534ACN
A2U10	1826-1012	9	2	ANALOG SWITCH 4 SPST 16-PIN	28480	1826-1012
A2U11	1826-1012	9		ANALOG SWITCH 4 SPST 16-PIN	28480	1826-1012
A2U12	1826-0783	9		IC OP AMP LOW-NOISE 8-DIP-C PKG	52063	XR5534ACN
A2U13				NOT ASSIGNED		
A2U14	1820-1202	7	2	IC GATE TTL LS NAND TPL 3-INP	01295	SN74LS10N
A2U15	1820-2795	5	1	IC DRVR TTL F LINE DRVR OCTL	28480	1820-2795
A2U16	1826-0759	9		IC COMPARATOR GP QUAD 14-DIP-C PKG	04713	LM339J
A2U17	1826-0932	0	1	IC OP AMP PRCN 8-DIP-C PKG	06665	OP-27FZ
A2U18	1826-0759	9		IC COMPARATOR GP QUAD 14-DIP-C PKG	04713	LM339J
A2U19				NOT ASSIGNED		
A2U20	1826-0413	2		IC OP AMP LOW-BIAS-H-IMPDT TO-99 PKG	34371	HA2-2605-5
A2VR1	1902-0029	8	2	DIODE-ZNR 12V 5% PD=1W IR=5UA	28480	1902-0029
A2VR2	1902-0029	8		DIODE-ZNR 12V 5% PD=1W IR=5UA	28480	1902-0029
A2W1	8159-0005	0	6	RESISTOR-ZERO OHMS 22 AWG LEAD DIA	28480	8159-0005
A2W2				NOT ASSIGNED		
A2W3	08903-60298	8	1	JUMPER WIRE	28480	08903-60298
A2W4	08903-60298	8	1	JUMPER WIRE	28480	08903-60298
A2XA2A1	1251-6065	3	2	CONNECTOR 10-PIN M POST TYPE	28480	1251-6065
A2XA2A2	1251-6065	3		CONNECTOR 10-PIN M POST TYPE	28480	1251-6065

†Refer to Section 7 for update information.

*Factory Selected Component (Refer to Section 5).

△ Errata part change.

Table 6-3. Replaceable Parts

Reference Designation	HP Part Number	C D	Qty.	Description	Mfr. Code	Mfr. Part Number
A2A1 (OPTION 010)						
A2A1	08903-60124	9	1	400HZ HIGH-PASS FILTER (OPTION 010 ONLY)	28480	08903-60124
OR						
A2A2 (OPTION 050)						
A2A2	08903-60124	9	1	400HZ HIGH-PASS FILTER (OPTION 050 ONLY)	28480	08903-60124
A2A_C1	0160-7018	4		CAPACITOR-FXD .022UF +-2% 100VDC POLYC	05176	0160-7018
A2A_C2	0160-7018	4		CAPACITOR-FXD .022UF +-2% 100VDC POLYC	05176	0160-7018
A2A_C3	0160-4787	8	3	CAPACITOR-FXD 22PF +-5% 100VDC CER 0+-30	28480	0160-4787
A2A_C4	0160-4835	7		CAPACITOR-FXD 1UF +-10% 50VDC CER	28480	0160-4835
A2A_C5	0160-4835	7		CAPACITOR-FXD .1UF +-10% 50VDC CER	28480	0160-4835
A2A_C6	0160-7018	4		CAPACITOR-FXD .022UF +-2% 100VDC POLYC	05176	0160-7018
A2A_C7	0160-7018	4		CAPACITOR-FXD .022UF +-2% 100VDC POLYC	05176	0160-7018
A2A_C8	0160-7018	4		CAPACITOR-FXD .022UF +-2% 100VDC POLYC	05176	0160-7018
A2A_C9	0160-4787	8		CAPACITOR-FXD 22PF +-5% 100VDC CER 0+-30	28480	0160-4787
A2A_C10	0160-5046	4	2	CAPACITOR-FXD .039UF +-2% 100VDC	28480	0160-5046
A2A_C11	0160-5046	4		CAPACITOR-FXD .039UF +-2% 100VDC	28480	0160-5046
A2A_C12	0180-2661	5		CAPACITOR-FXD 1UF +-10% 50VDC TA	25088	D1R03S1A50K
A2A_C13	0180-2661	5		CAPACITOR-FXD 1UF +-10% 50VDC TA	25088	D1R03S1A50K
A2A_J1	1251-6063	1		CONNECTOR 10-PIN F POST TYPE	28480	1251-6063
A2A_R1	0698-7196	8		RESISTOR 21.5 1% .05W F TC=0+-100	24546	C3-1.8 TO-21R5-F
A2A_R2	0698-7196	8		RESISTOR 21.5 1% .05W F TC=0+-100	24546	C3-1.8 TO-21R5-F
A2A_R3	0699-0403	8	1	RESISTOR 45.2K 1% .25W F TC=0+-25	20430	0699-0403
A2A_R4	0698-8586	2	1	RESISTOR 4.71K 1% .125W F TC=0+-100	28480	0698-8586
A2A_R5	0698-7255	0		RESISTOR 6.19K 1% .05W F TC=0+-100	24546	C3-1.8 TO-6191-F
A2A_R6	2100-3351	6		RESISTOR-TRMR 500 10% C SIDE-ADJ 1-TRN	28480	2100-3351
A2A_R7	0699-0404	9	1	RESISTOR 29.3K .1% .25W F TC=0+-25	28480	0699-0404
A2A_R8	0698-7853	4	1	RESISTOR 101.5K .1% .125W F TC=0+-50	19701	MF4C1.8-T2-10152 E
A2A_R9	0699-0410	7	1	RESISTOR 938 1% .25W F TC=0+-25	28480	0699-0410
A2A_R10	0699-0408	3	1	RESISTOR 4.28K .1% .25W F TC=0+-25	28480	0699-0408
A2A_U1	1825-0783	9		IC OP AMP LOW-NOISE 8-DIP-C PKG	52063	XR5534ACN
A2A_U2	1825-0783	9		IC OP AMP LOW-NOISE 8-DIP-C PKG	52063	XR5534ACN

†Refer to Section 7 for update information.

*Factory Selected Component (Refer to Section 5).

Δ Errata part change.

Table 6-3. Replaceable Parts

Reference Designation	HP Part Number	C D	Qty.	Description	Mfr. Code	Mfr. Part Number
A2A1 (OPTION 011)						
A2A1	08903-60125	0	1	CCITT WEIGHTING FILTER (OPTION 011 ONLY)	28480	08903-60125
OR						
A2A2 (OPTION 051)						
A2A2	08903-60125	0	1	CCITT WEIGHTING FILTER (OPTION 051 ONLY)	28480	08903-60125
A2A_C1	0160-6326	5	2	C MPC 1060P 50V	28480	0160-6326
A2A_C2	0160-5201	3	1	CAPACITOR-FXD .01UF +-1% 200VDC	28480	0160-5201
A2A_C3	0160-6327	6	1	C MPC 4000P 50V	28480	0160-6327
A2A_C4	0160-4759	4		CAPACITOR-FXD 6800PF +-1% 200VDC	28480	0160-4759
A2A_C5	0160-4622	0	2	CAPACITOR-FXD .1UF +-1% 160VDC MET-POLYC	28480	0160-4622
A2A_C6	0160-6324	3		C MPC 560P 50V	28480	0160-6324
A2A_C7	0160-6606	4	4	CAPACITOR-FXD .02UF 200VDC	28480	0160-6606
A2A_C8	0160-0578	7		CAPACITOR-FXD .047UF +-1% 50VDC	28480	0160-0578
A2A_C9	0160-0578	7		CAPACITOR-FXD .047UF +-1% 50VDC	28480	0160-0578
A2A_C10	0160-6606	4	4	CAPACITOR-FXD .02UF 200VDC	28480	0160-6606
A2A_C11	0160-6606	4	4	CAPACITOR-FXD .02UF 200VDC	28480	0160-6606
A2A_C12	0160-6606	4	4	CAPACITOR-FXD .02UF 200VDC	28480	0160-6606
A2A_C13	0180-2951	5		CAPACITOR-FXD 1UF +-10% 50VDC TA	25088	D1H0GS1A50K
A2A_C14	0180-2661	5		CAPACITOR-FXD 1UF +-10% 50VDC TA	25088	D1R0GS1A50K
A2A_J1	1251-6063	1		CONNECTOR 10-PIN F POST TYPE	28480	1251-6063
A2A_R1	0757-0448	5	2	RESISTOR 18.2K 1% .125W F TC=0+-100	24546	C4-1/8-T0-1822-F
A2A_R2	0757-0448	5		RESISTOR 18.2K 1% .125W F TC=0+-100	24546	C4-1/8-T0-1822-F
A2A_R3	0698-7236	7	2	RESISTOR 1K 1% .05W F TC=0+-100	24546	C3-1/8-T0-1001-F
A2A_R4	2100-3351	6		RESISTOR-TRMR 500 10% C SIDE-ADJ 1-TRN	28480	2100-3351
A2A_R5	0698-7243	6		RESISTOR 1.96K 1% .05W F TC=0+-100	24546	C3-1/8-T0-1961-F
A2A_R6	0698-7353	9	1	RESISTOR 19K 1% .125W F TC=0+-100	19701	MF4C1-8-T0-1902-F
A2A_R7	0698-7267	4		RESISTOR 19.6K 1% .05W F TC=0+-100	24546	C3-1/8-T0-1962-F
A2A_R8	0698-3515	7	2	RESISTOR 5.9K 1% .125W F TC=0+-100	24546	C4-1/8-T0-5901-F
A2A_R9	0757-0200	7	3	RESISTOR 5.82K 1% .125W F TC=0+-100	24546	C4-1/8-T0-5621-F
A2A_R10	0698-3515	7		RESISTOR 5.9K 1% .125W F TC=0+-100	24546	C4-1/8-T0-5901-F
A2A_R11	0698-7240	3		RESISTOR 1.47K 1% .05W F TC=0+-100	24546	C3-1/8-T0-1471-F
A2A_R12	0698-8607	8	1	RESISTOR 4.5K 1% .125W F TC=0+-25	28480	0698-8607
A2A_R13	0698-7270	9	2	RESISTOR 26 1K 1% .05W F TC=0+-100	24546	C3-1/8-T0-2612-F
A2A_R14	0698-4508	0	1	RESISTOR 78.7K 1% .125W F TC=0+-100	24546	C4-1/8-T0-7872-F
A2A_R15	0698-4489	6	1	RESISTOR 28K 1% .125W F TC=0+-100	24546	C4-1/8-T0-2802-F
A2A_R16	0698-7254	9		RESISTOR 5.62K 1% .05W F TC=0+-100	24546	C3-1/8-T0-5621-F
A2A_R17	0698-7195	8		RESISTOR 21.5 1% .05W F TC=0+-100	24546	C3-1/8-T0-21R5-F
A2A_R18	0698-7195	8		RESISTOR 21.5 1% .05W F TC=0+-100	24546	C3-1/8-T0-21R5-F
A2A_U1	1826-1290	5		IC OP AMP LOW-BIAS-H-IMP'D QUAD 14-DIP-P	01295	TL7L04C40

†Refer to Section 7 for update information.

*Factory Selected Component (Refer to Section 5).

Δ Errata part change.

Table 6-3. Replaceable Parts

Reference Designation	HP Part Number	C D	Qty.	Description	Mfr. Code	Mfr. Part Number
A2A1 (OPTION 012)						
A2A1	08903-60126	1	1	CCIR WEIGHTING FILTER (OPTION 012 ONLY)	28480	08903-60126
OR						
A2A2 (OPTION 052)						
A2A2	08903-60126	1	1	CCIR WEIGHTING FILTER (OPTION 052 ONLY)	28480	08903-60126
A2A_C1	0180-2661	5		CAPACITOR-FXD 1UF +-10% 50VDC TA	25088	D1R0GS1A50K
A2A_C2	0180-2661	5		CAPACITOR-FXD 1UF +-10% 50VDC TA	25088	D1R0GS1A50K
A2A_C3	0160-6323	2		C MPC 2000P 50V	28480	0160-6323
A2A_C4	0160-4759	4	5	CAPACITOR-FXD 6800PF +-1% 200VDC	28480	0160-4759
A2A_C5	0160-6324	3		C MPC 560P 50V	28480	0160-6324
A2A_C6	0160-4759	4		CAPACITOR-FXD 6800PF +-1% 200VDC	28480	0160-4759
A2A_C7	0160-6325	4		C MPC 2400P 50V	28480	0160-6325
A2A_C8	0160-6606	4	1	CAPACITOR-FXD .02UF 200VDC	28480	0160-6606
A2A_J1	1251-6063	1		CONNECTOR 10-PIN F POST TYPE	28480	1251-6063
A2A_R1	0698-7196	8		RESISTOR 21.5 1% .05W F TC=0+-100	24546	C3-1/8-TO-21R5-F
A2A_R2	0698-7196	8		RESISTOR 21.5 1% .05W F TC=0+-100	24546	C3-1/8-TO-21R5-F
A2A_R3	0698-5466	1	2	RESISTOR 5.7K 1% .125W F TC=0+-100	24546	C4-1/8-TO-5701-F
A2A_R4	0698-7257	2	7	RESISTOR 7.5K 1% .05W F TC=0+-100	24546	C3-1/8-TO-7501-F
A2A_R5	0698-7282	3	2	RESISTOR 82.5K 1% .05W F TC=0+-100	24546	C3-1/8-TO-8252-F
A2A_R6	0598-7226	5	2	RESISTOR 383 1% .05W F TC=0+-100	24546	C3-1/8-TO-383R-F
A2A_R7	2100-3350	5	3	RESISTOR-TRMR 200 10% C SIDE-ADJ 1-TRN	28480	2100-3350
A2A_R8	0698-7239	0		RESISTOR 1.33K 1% .05W F TC=0+-100	24546	C3-1/8-TO-1331-F
A2A_R9	0698-7257	2		RESISTOR 7.5K 1% .05W F TC=0+-100	24546	C3-1/8-TO-7501-F
A2A_R10	0698-3259	6	2	RESISTOR 7.87K 1% .125W F TC=0+-100	24546	C4-1/8-TO-7871-F
A2A_R11	0698-7245	8	1	RESISTOR 2.37K 1% .05W F TC=0+-100	24546	C3-1/8-TO-2371-F
A2A_R12	0698-7257	2		RESISTOR 7.5K 1% .05W F TC=0+-100	24546	C3-1/8-TO-7501-F
A2A_R13	0698-7250	5	1	RESISTOR 3.83K 1% .05W F TC=0+-100	24546	C3-1/8-TO-3831-F
A2A_R14	0698-3484	9	3	RESISTOR 6.65K 1% .125W F TC=0+-100	24546	C4-1/8-TO-6651-F
A2A_R15	0698-4430	7		RESISTOR 1.91K 1% .125W F TC=0+-100	24546	C4-1/8-TO-1911-F
A2A_R16	0698-7241	4	2	RESISTOR 1.62K 1% .05W F TC=0+-100	24546	C3-1/8-TO-1621-F
A2A_U1	1826-1290	5		IC OP AMP LOW-BIAS-H-IMPD QUAD 14-DIP-P	01295	TL7L04C40

†Refer to Section 7 for update information.

*Factory Selected Component (Refer to Section 5).

△ Errata part change.

Table 6-3. Replaceable Parts

Reference Designation	HP Part Number	C D	Qty.	Description	Mfr. Code	Mfr. Part Number
A2A1 (OPTION 013)						
A2A1	08903-60127	2	1	C-MESSAGE WEIGHTING FILTER (OPTION 013 ONLY)	28480	08903-60127
OR						
A2A2 (OPTION 053)						
A2A2	08903-60127	2	1	C-MESSAGE WEIGHTING FILTER (OPTION 053 ONLY)	28480	08903-60127
A2A_C1	0180-2661	5	12	CAPACITOR-FXD 1UF+-10% 50VDC TA	25088	D1R0GS1A50K
A2A_C2	0180-2661	5		CAPACITOR-FXD 1UF+-10% 50VDC TA	25088	D1R0GS1A50K
A2A_C3	0160-5032	8	7	CAPACITOR-FXD .0223UF +-1% 200VDC	28480	0160-5032
A2A_C4	0160-6322	1	1	C MPC 3000P 50V	28480	0160-6322
A2A_C5	0160-4622	0		CAPACITOR-FXD .1UF +-1% 160VDC MET-POLYC	28480	0160-4622
A2A_C6	0160-6321	0	1	C MPC 958P 50V	28480	0160-6321
A2A_C7	0160-5032	8		CAPACITOR-FXD .0223UF +-1% 200VDC	28480	0160-5032
A2A_C8	0160-5032	8		CAPACITOR-FXD .0223UF +-1% 200VDC	28480	0160-5032
A2A_C9	0160-6606	4	2	CAPACITOR-FXD .02UF 200VDC	28480	0160-6606
A2A_C10	0160-6606	4	2	CAPACITOR-FXD .02UF 200VDC	28480	0160-6606
A2A_J1	1251-6063	1	6	CONNECTOR 10-PIN F POST TYPE	28480	1251-6063
A2A_R1	0698-7196	8		RESISTOR 21.5 1% .05W F TC=0+-100	24546	C3-1/8-T0-21R5-F
A2A_R2	0698-7196	8		RESISTOR 21.5 1% .05W F TC=0+-100	24546	C3-1/8-T0-21R5-F
A2A_R3	0698-8191	5	1	RESISTOR 12.5K 1% .125W F TC=0+-25	19701	MF4C1,8-T9-1252-B
A2A_R4	0698-7273	2	1	RESISTOR 34.8K 1% .05W F TC=0+-100	24546	C3-1/8-T0-3482-F
A2A_R5	0698-7240	3	2	RESISTOR 1.47K 1% .05W F TC=0+-100	24546	C3-1/8-T0-1471-F
A2A_R6	2100-3351	6		RESISTOR-TRMR 500 10% C SIDE-ADJ 1-TRN	28480	2100-3351
A2A_R7	0598-7243	6		RESISTOR 1.96K 1% .05W F TC=0+-100	24546	C3-1/8-T0-1961-F
A2A_R8	0757-0273	4	2	RESISTOR 3.01K 1% .125W F TC=0+-100	24546	C4-1/8-T0-3011-F
A2A_R9	0698-4471	6	1	RESISTOR 7.15K 1% .125W F TC=0+-100	24546	C4-1/8-T0-7151-F
A2A_R10	0757-0273	4		RESISTOR 3.01K 1% .125W F TC=0+-100	24546	C4-1/8-T0-3011-F
A2A_R11	0698-7234	5	1	RESISTOR 825 1% .05W F TC=0+-100	24546	C3-1/8-T0-825R-F
A2A_R12	0698-4020	1	2	RESISTOR 9.53K 1% .125W F TC=0+-100	24546	C4-1/8-T0-9531-F
A2A_R13	0698-7267	4		RESISTOR 19.6K 1% .05W F TC=0+-100	24546	C3-1/8-T0-1962-F
A2A_R14	0757-0454	3	1	RESISTOR 33.2K 1% .125W F TC=0+-100	24546	C4-1/8-T0-3322-F
A2A_U1	1826-1290	5		IC OP AMP LOW-BIAS-H-IMPD QUAD 14-DIP-P	01295	TL7L04C40

†Refer to Section 7 for update information.

*Factory Selected Component (Refer to Section 5).

Δ Errata part change.

Table 6-3. Replaceable Parts

Reference Designation	HP Part Number	C D	Qty.	Description	Mfr. Code	Mfr. Part Number
A2A1 (OPTION 014)						
A2A1	08903-60162	5	1	CCIR/ARM WEIGHTING FILTER (OPTION 014 ONLY)	28480	08903-60162
OR						
A2A2 (OPTION 054)						
A2A2	08903-60162	5	1	CCIR/ARM WEIGHTING FILTER (OPTION 054 ONLY)	28480	08903-60162
A2A_C1	0180-2661	5		CAPACITOR-FXD 1UF+-10% 50VDC TA	25088	D1R0GS1A50K
A2A_C2	0180-2661	5		CAPACITOR-FXD 1UF+-10% 50VDC TA	25088	D1R0GS1A50K
A2A_C3	0160-6323	2	2	C MPC 2000P 50V	28480	0160-6323
A2A_C4	0160-4759	4		CAPACITOR-FXD 6800PF +-1% 200VDC	28480	0160-4759
A2A_C5	0160-6324	3		C MPC 560P 50V	28480	0160-6324
A2A_C6	0160-4759	4		CAPACITOR-FXD 6800PF +-1% 200VDC	28480	0160-4759
A2A_C7	0160-6325	4	2	C MPC 2400P 50V	28480	0160-6325
A2A_C8	0160-6606	4	1	CAPACITOR-FXD .02UF 200VDC	28480	0160-6606
A2A_J1	1251-6063	1		CONNECTOR 10-PIN F POST TYPE	28480	1251-6063
A2A_R1	0698-7196	8		RESISTOR 21.5 1% .05W F TC=0+-100	24546	C3-1/8-T0-21R5-F
A2A_R2	0698-7196	8		RESISTOR 21.5 1% .05W F TC=0+-100	24546	C3-1/8-T0-21R5-F
A2A_R3	0698-5486	1		RESISTOR 5.7K 1% .125W F TC=0+-100	24546	C4-1/8-T0-5701-F
A2A_R4	0698-7257	2		RESISTOR 7.5K 1% .05W F TC=0+-100	24546	C3-1/8-T0-7501-F
A2A_R5	0698-7282	3		RESISTOR 82.5K 1% .05W F TC=0+-100	24546	C3-1/8-T0-8252-F
A2A_R6	0698-7228	7		RESISTOR 464 1% .05W F TC=0+-100	24546	C3-1/8-T0-464R-F
A2A_R7	2100-3350	5		RESISTOR-TRMR 200 10% C SIDE-ADJ 1-TRN	28480	2100-3350
A2A_R8	0698-7239	0	2	RESISTOR 1.33K 1% .05W F TC=0+-100	24546	C3-1/8-T0-1331-F
A2A_R9	0698-7257	2		RESISTOR 7.5K 1% .05W F TC=0+-100	24546	C3-1/8-T0-7501-F
A2A_R10	0698-3259	6		RESISTOR 7.87K 1% .125W F TC=0+-100	24546	C4-1/8-T0-7871-F
A2A_R11	0698-7249	2	1	RESISTOR 3.48K 1% .05W F TC=0+-100	24546	C3-1/8-T0-3481-F
A2A_R12	0698-7257	2		RESISTOR 7.5K 1% .05W F TC=0+-100	24546	C3-1/8-T0-7501-F
A2A_R13	0698-7252	7		RESISTOR 4.64K 1% .05W F TC=0+-100	24546	C3-1/8-T0-4641-F
A2A_R14	0698-3484	9		RESISTOR 6.65K 1% .125W F TC=0+-100	24546	C4-1/8-T0-6651-F
A2A_R15	0698-4430	7	2	RESISTOR 1.91K 1% .125W F TC=0+-100	24546	C4-1/8-T0-1911-F
A2A_R16	0698-7252	7		RESISTOR 4.64K 1% .05W F TC=0+-100	24546	C3-1/8-T0-4641-F
A2A_U1	1826-1290	5		IC OP AMP LOW-BIAS-H-IMPD QUAD 14-DIP-P	01295	TL7L04C40

†Refer to Section 7 for update information.

*Factory Selected Component (Refer to Section 5).

Δ Errata part change.

Table 6-3. Replaceable Parts

Reference Designation	HP Part Number	C D	Qty.	Description	Mfr. Code	Mfr. Part Number
A2A1 (OPTION 015)						
A2A1	08903-60161	4	1	"A" WEIGHTING FILTER (OPTION 015 ONLY)	28480	08903-60161
OR						
A2A2 (OPTION 055)						
A2A2	08903-60161	4	1	"A" WEIGHTING FILTER (OPTION 055 ONLY)	28480	08903-60161
A2A_C1	0160-6326	5		C MPC 1060P 50V	28480	0160-6326
A2A_C2	0160-6324	3	4	C MPC 560P 50V	28480	0160-6324
A2A_C3	0160-0578	7	6	CAPACITOR-FXD .047UF +-1% 50VDC	28480	0160-0578
A2A_C4	0160-0578	7		CAPACITOR-FXD .047UF +-1% 50VDC	28480	0160-0578
A2A_C5	0160-0578	7		CAPACITOR-FXD .047UF +-1% 50VDC	28480	0160-0578
A2A_C6	0160-0578	7		CAPACITOR-FXD .047UF +-1% 50VDC	28480	0160-0578
A2A_C7	0180-2661	5		CAPACITOR-FXD 1UF +-10% 50VDC TA	25088	D1R0GS1A50K
A2A_C8	0180-2661	5		CAPACITOR-FXD 1UF +-10% 50VDC TA	25088	D1R0GS1A50K
A2A_J1	1251-6063	1		CONNECTOR 10-PIN F POST TYPE	28480	1251-6063
A2A_R1	0698-7262	9	2	RESISTOR 12.1K 1% .05W F TC=0+-100	24546	C3-1/8-T0-1212-F
A2A_R2	0698-7215	2	1	RESISTOR 133 1% .05W F TC=0+-100	24546	C3-1/8-T0-133R-F
A2A_R3	2100-3351	6	4	RESISTOR-TRMR 500 10% C SIDE-ADJ 1-TRN	28480	2100-3351
A2A_R4	0698-7243	6	3	RESISTOR 1.96K 1% .05W F TC=0+-100	24546	C3-1/8-T0-1961-F
A2A_R5	0698-7257	2		RESISTOR 7.5K 1% .05W F TC=0+-100	24546	C3-1/8-T0-7501-F
A2A_R6	0698-7254	9		RESISTOR 5.62K 1% .05W F TC=0+-100	24546	C3-1/8-T0-5621-F
A2A_R7	0698-7260	7		RESISTOR 10K 1% .05W F TC=0+-100	24546	C3-1/8-T0-1002-F
A2A_R8	0698-7252	7		RESISTOR 4.64K 1% .05W F TC=0+-100	24546	C3-1/8-T0-4641-F
A2A_R9	0698-7253	8		RESISTOR 5.11K 1% .05W F TC=0+-100	24546	C3-1/8-T0-5111-F
A2A_R10	0698-7275	4	1	RESISTOR 42.2K 1% .05W F TC=0+-100	24546	C3-1/8-T0-4222-F
A2A_R11	0699-7287	8	1	RESISTOR 133K 1% .05W F TC=0+-100	24546	C3-1/8-T0-1333-F
A2A_R12	0698-7288	9	1	RESISTOR 147K 1% .05W F TC=0+-100	24546	C3-1/8-T0-1473-F
A2A_R13	0698-7196	8		RESISTOR 21.5 1% .05W F TC=0+-100	24546	C3-1/8-T0-21R5-F
A2A_R14	0698-7196	8		RESISTOR 21.5 1% .05W F TC=0+-100	24546	C3-1/8-T0-21R5-F
A2A_R15	0698-7268	5	1	RESISTOR 21.5K 1% .05W F TC=0+-100	24546	C3-1/8-T0-2152-F
A2A_U1	1826-1290	5	4	IC OP AMP LOW-BIAS-H-IMPD QUAD 14-DIP-P	01295	TL7L04C40

†Refer to Section 7 for update information.

*Factory Selected Component (Refer to Section 5).

△ Errata part change.

Table 6-3. Replaceable Parts

Reference Designation	HP Part Number	C D	Qty.	Description	Mfr. Code	Mfr. Part Number
A3						
A3	08903-60163	6	1	NOTCH FILTER ASSEMBLY	28480	08903-60163
A3C1	0160-4834	8		CAPACITOR-FXD .047UF + -10% 100VDC CER	28480	0160-4834
A3C2	0180-0049	9	2	CAPACITOR-FXD 20UF + 75-10% 50VDC AL	56289	30D206G050CC2
A3C3	0180-0049	9		CAPACITOR-FXD 20UF + 75-10% 50VDC AL	56289	30D206G050CC2
A3C4	0160-4834	8		CAPACITOR-FXD .047UF + -10% 100VDC CER	28480	0160-4834
A3C5	0160-4795	8	4	CAPACITOR-FXD 4.7PF +-.5PF 100VDC CER	28480	0160-4795
A3C6	0160-4832	4		CAPACITOR-FXD .01UF + -10% 100VDC CER	28480	0160-4832
A3C7	0160-4832	4		CAPACITOR-FXD .01UF + -10% 100VDC CER	28480	0160-4832
A3C8				NOT ASSIGNED		
A3C9	0160-4832	4		CAPACITOR-FXD .01UF + -10% 100VDC CER	28480	0160-4832
A3C10	0160-4832	4		CAPACITOR-FXD .01UF + -10% 100VDC CER	28480	0160-4832
A3C11	0160-4590	1	4	CAPACITOR-FXD .18UF + -1% 200VDC	28480	0160-4590
A3C12	0160-5032	8		CAPACITOR-FXD .0223UF + -1% 200VDC	28480	0160-5032
A3C13	0160-3293	9	4	CAPACITOR-FXD 2470PF + -1% 100VDC MICA	28480	0160-3293
A3C14	0160-3918	5	2	CAPACITOR-FXD 355PF + -1% 100VDC MICA	28480	0160-3918
A3C15	0160-4795	8		CAPACITOR-FXD 4.7PF +-.5PF 100VDC CER	28480	0160-4795
A3C16	0160-4832	4		CAPACITOR-FXD .01UF + -10% 100VDC CER	28480	0160-4832
A3C17	0160-4832	4		CAPACITOR-FXD .01UF + -10% 100VDC CER	28480	0160-4832
A3C18	0160-4795	8		CAPACITOR-FXD 4.7PF +-.5PF 100VDC CER	28480	0160-4795
A3C19	0160-4832	4		CAPACITOR-FXD .01UF + -10% 100VDC CER	28480	0160-4832
A3C20	0160-4832	4		CAPACITOR-FXD .01UF + -10% 100VDC CER	28480	0160-4832
A3C21	0160-4791	4		CAPACITOR-FXD 10PF + .5% 100VDC CER 0 + -30	28480	0160-4791
A3C22				NOT ASSIGNED		
A3C23	0160-4832	4		CAPACITOR-FXD .01UF + -10% 100VDC CER	28480	0160-4832
A3C24	0160-4832	4		CAPACITOR-FXD .01UF + -10% 100VDC CER	28480	0160-4832
A3C25	0160-4590	1		CAPACITOR-FXD .18UF + -1% 200VDC	28480	0160-4590
A3C26	0160-5032	8		CAPACITOR-FXD .0223UF + -1% 200VDC	28480	0160-5032
A3C27	0160-3293	9		CAPACITOR-FXD 2470PF + -1% 100VDC MICA	28480	0160-3293
A3C28	0160-3918	5		CAPACITOR-FXD 355PF + -1% 100VDC MICA	28480	0160-3918
A3C29	0180-0374	3	5	CAPACITOR-FXD 10UF + -10% 20VDC TA	56289	150D106X9020B2
A3C30	0180-0094	4	1	CAPACITOR-FXD 100UF + 75-10% 25VDC AL	56289	30D107G025DD2
A3C31	0160-4832	4		CAPACITOR-FXD .01UF + -10% 100VDC CER	28480	0160-4832
A3C32	0160-4832	4		CAPACITOR-FXD .01UF + -10% 100VDC CER	28480	0160-4832
A3C33	0160-4832	4		CAPACITOR-FXD .01UF + -10% 100VDC CER	28480	0160-4832
A3C34	0160-4832	4		CAPACITOR-FXD .01UF + -10% 100VDC CER	28480	0160-4832
A3C35	0160-4814	2	4	CAPACITOR-FXD 150PF + -5% 100VDC CER	28480	0160-4814
A3C36	0160-4795	8		CAPACITOR-FXD 4.7PF +-.5PF 100VDC CER	28480	0160-4795
A3C37	0160-4832	4		CAPACITOR-FXD .01UF + -10% 100VDC CER	28480	0160-4832
A3C38	0160-4832	4		CAPACITOR-FXD .01UF + -10% 100VDC CER	28480	0160-4832
A3C39	0160-4807	3	3	CAPACITOR-FXD 33PF + .5% 100VDC CER 0 + -30	28480	0160-4807
A3C40	0160-4807	3		CAPACITOR-FXD 33PF + .5% 100VDC CER 0 + -30	28480	0160-4807
A3C41 ^Δ	0160-5550	0	1	CAPACITOR-FXD .10UF + -5% 100VDC MET-POLYC	28480	0160-5550
A3C42	0160-5527	6	1	CAPACITOR-FXD .033UF + .5% 100VDC	28480	0160-5527
A3C43	0160-4832	4		CAPACITOR-FXD .01UF + -10% 100VDC CER	28480	0160-4832
A3C44	0160-4832	4		CAPACITOR-FXD .01UF + -10% 100VDC CER	28480	0160-4832
A3C45	0160-3510	3	1	CAPACITOR-FXD 3UF + -10% 50VDC MET-POLYC	28480	0160-3510

†Refer to Section 7 for update information.

*Factory Selected Component (Refer to Section 5).

Δ Errata part change.

Table 6-3. Replaceable Parts

Reference Designation	HP Part Number	C D	Qty.	Description	Mfr. Code	Mfr. Part Number
A3C46	0160-4233	9	1	CAPACITOR-FXD .47UF +-5% 50VDC MET-POLYC	28480	0160-4233
A3C47	0160-3531	8	1	CAPACITOR-FXD 2UF +-5% 50VDC MET-POLYC	28480	0160-3531
A3C48	0160-5528	7	1	CAPACITOR-FXD .22UF +-5% 100VDC	28480	0160-5528
A3C49	0160-4832	4		CAPACITOR-FXD .01UF +-10% 100VDC CER	28480	0160-4832
A3C50	0160-4832	4		CAPACITOR-FXD .01UF +-10% 100VDC CER	28480	0160-4832
A3C51				NOT ASSIGNED		
A3C52	0160-4832	4		CAPACITOR-FXD .01UF +-10% 100VDC CER	28480	0160-4832
A3C53	0160-4832	4		CAPACITOR-FXD .01UF +-10% 100VDC CER	28480	0160-4832
A3C54	0160-4835	7		CAPACITOR-FXD .1UF +-10% 50VDC CER	28480	0160-4835
A3C55	0160-4835	7		CAPACITOR-FXD .1UF +-10% 50VDC CER	28480	0160-4835
A3C56	0160-0577	6	1	CAPACITOR-FXD 1.8UF +-20% 50VDC	28480	0160-0577
A3C57	0160-4832	4		CAPACITOR-FXD .01UF +-10% 100VDC CER	28480	0160-4832
A3C58	0160-4832	4		CAPACITOR-FXD .01UF +-10% 100VDC CER	28480	0160-4832
A3C59	0160-5559	4	1	CAPACITOR-FXD .82UF +-5% 100VDC	28480	0160-5559
A3CR1	1901-0033	2	6	DIODE-GEN PRP 180V 200MA DO-7	28480	1901-0033
A3CR2	1901-0033	2		DIODE-GEN PRP 180V 200MA DO-7	28480	1901-0033
A3CR3	1901-0050	3		DIODE-SWITCHING 80V 200MA 2NS DO-35	28480	1901-0050
A3CR4	1901-0050	3		DIODE-SWITCHING 80V 200MA 2NS DO-35	28480	1901-0050
A3CR5	1901-0050	3		DIODE-SWITCHING 80V 200MA 2NS DO-35	28480	1901-0050
A3CR6	1901-0050	3		DIODE-SWITCHING 80V 200MA 2NS DO-35	28480	1901-0050
A3CR7	1901-0050	3		DIODE-SWITCHING 80V 200MA 2NS DO-35	28480	1901-0050
A3CR8	1901-0050	3		DIODE-SWITCHING 80V 200MA 2NS DO-35	28480	1901-0050
A3CR9				NOT ASSIGNED		
A3CR10				NOT ASSIGNED		
A3CR11	1901-0050	3		DIODE-SWITCHING 80V 200MA 2NS DO-35	28480	1901-0050
A3CR12	1901-0050	3		DIODE-SWITCHING 80V 200MA 2NS DO-35	28480	1901-0050
A3CR13	1901-0050	3		DIODE-SWITCHING 80V 200MA 2NS DO-35	28480	1901-0050
A3CR14	1901-0050	3		DIODE-SWITCHING 80V 200MA 2NS DO-35	28480	1901-0050
A3CR15	1901-0518	8	5	DIODE-SM SIG SCHOTTKY	28480	1901-0518
A3CR16	1901-0518	8		DIODE-SM SIG SCHOTTKY	28480	1901-0518
A3L1	9140-0114	4		INDUCTOR RF-CH-MLD 10UH 10% .166DX.385LG	28480	9140-0114
A3L2	9100-2430	7		INDUCTOR RF-CH-MLD 220UH 10%	28480	9100-2430
A3MP1	4040-0748	3		EXTR-PC BD BLK POLYC .062-BD-THKNS	28480	4040-0748
	1480-0116	8		PIN-GRV .062-IN-DIA .25-IN-LG STL	28480	1480-0116
A3MP2	4040-0751	8	1	EXTR-PC BD ORN POLYC .062-BD-THKNS	28480	4040-0751
	1480-0116	8		PIN-GRV .062-IN-DIA .25-IN-LG STL	28480	1480-0116
A3MP3	0403-0026	6	3	PLUG-HOLE BDR-HD FOR .187-D-HOLE NYL	02768	207-120241 03-0101
A3Q1	1855-0414	4	8	TRANSISTOR J-FET 2N4393 N-CHAN D-MODE	04713	2N4393
A3Q2	1855-0414	4		TRANSISTOR J-FET 2N4393 N-CHAN D-MODE	04713	2N4393
A3Q3	1855-0414	4		TRANSISTOR J-FET 2N4393 N-CHAN D-MODE	04713	2N4393
A3Q4	1855-0420	2	27	TRANSISTOR J-FET 2N4391 N-CHAN D-MODE	28480	1855-0420
A3Q5	1855-0420	2		TRANSISTOR J-FET 2N4391 N-CHAN D-MODE	28480	1855-0420
A3Q6	1855-0414	4		TRANSISTOR J-FET 2N4393 N-CHAN D-MODE	04713	2N4393
A3Q7	1855-0414	4		TRANSISTOR J-FET 2N4393 N-CHAN D-MODE	04713	2N4393
A3Q8	1855-0414	4		TRANSISTOR J-FET 2N4393 N-CHAN D-MODE	04713	2N4393
A3Q9	1855-0414	4		TRANSISTOR J-FET 2N4393 N-CHAN D-MODE	04713	2N4393
A3Q10	1855-0414	4		TRANSISTOR J-FET 2N4393 N-CHAN D-MODE	04713	2N4393
A3Q11	1855-0420	2		TRANSISTOR J-FET 2N4391 N-CHAN D-MODE	28480	1855-0420

†Refer to Section 7 for update information.

*Factory Selected Component (Refer to Section 5).

Δ Errata part change.

Table 6-3. Replaceable Parts

Reference Designation	HP Part Number	C D	Qty.	Description	Mfr. Code	Mfr. Part Number
A3Q12	1855-0420	2		TRANSISTOR J-FET 2N4391 N-CHAN D-MODE	28480	1855-0420
A3Q13	1855-0420	2		TRANSISTOR J-FET 2N4391 N-CHAN D-MODE	28480	1855-0420
A3Q14	1855-0420	2		TRANSISTOR J-FET 2N4391 N-CHAN D-MODE	28480	1855-0420
A3Q15	1855-0420	2		TRANSISTOR J-FET 2N4391 N-CHAN D-MODE	28480	1855-0420
A3Q16	1855-0420	2		TRANSISTOR J-FET 2N4391 N-CHAN D-MODE	28480	1855-0420
A3Q17	1855-0420	2		TRANSISTOR J-FET 2N4391 N-CHAN D-MODE	28480	1855-0420
A3Q18	1855-0420	2		TRANSISTOR J-FET 2N4391 N-CHAN D-MODE	28480	1855-0420
A3Q19	1855-0420	2		TRANSISTOR J-FET 2N4391 N-CHAN D-MODE	28480	1855-0420
A3Q20	1855-0420	2		TRANSISTOR J-FET 2N4391 N-CHAN D-MODE	28480	1855-0420
A3Q21	1855-0420	2		TRANSISTOR J-FET 2N4391 N-CHAN D-MODE	28480	1855-0420
A3Q22	1855-0420	2		TRANSISTOR J-FET 2N4391 N-CHAN D-MODE	28480	1855-0420
A3Q23	1855-0420	2		TRANSISTOR J-FET 2N4391 N-CHAN D-MODE	28480	1855-0420
A3Q24	1855-0420	2		TRANSISTOR J-FET 2N4391 N-CHAN D-MODE	28480	1855-0420
A3Q25	1855-0420	2		TRANSISTOR J-FET 2N4391 N-CHAN D-MODE	28480	1855-0420
A3Q27	1855-0420	2		TRANSISTOR J-FET 2N4391 N-CHAN D-MODE	28480	1855-0420
A3Q28	1855-0420	2		TRANSISTOR J-FET 2N4391 N-CHAN D-MODE	28480	1855-0420
A3Q29	1855-0420	2		TRANSISTOR J-FET 2N4391 N-CHAN D-MODE	28480	1855-0420
A3Q30	1855-0420	2		TRANSISTOR J-FET 2N4391 N-CHAN D-MODE	28480	1855-0420
A3Q31	1855-0420	2		TRANSISTOR J-FET 2N4391 N-CHAN D-MODE	28480	1855-0420
A3Q32	1855-0420	2		TRANSISTOR J-FET 2N4391 N-CHAN D-MODE	28480	1855-0420
A3Q33	1855-0420	2		TRANSISTOR J-FET 2N4391 N-CHAN D-MODE	28480	1855-0420
A3Q34	1855-0420	2		TRANSISTOR J-FET 2N4391 N-CHAN D-MODE	28480	1855-0420
A3Q35	1855-0420	2		TRANSISTOR J-FET 2N4391 N-CHAN D-MODE	28480	1855-0420
A3R1	0698-3152	8		RESISTOR 3.48K 1% .125W F TC=0+ .100	24546	C4-1/8-T0-3481-F
A3R2	1810-0208	0	2	NETWORK-RES 8-SIP68.0K OHM X 7	01121	208A683
A3R3	1810-0208	0		NETWORK-RES 8-SIP68.0K OHM X 7	01121	208A683
A3R4	0698-3160	8	6	RESISTOR 31.6K 1% .125W F TC=0+ .100	24546	C4-1/8-T0-3162-F
A3R5	0698-3160	8		RESISTOR 31.6K 1% .125W F TC=0+ .100	24546	C4-1/8-T0-3162-F
A3R6	0698-6360	6	18	RESISTOR 10K .1% .125W F TC=0+ .25	28480	0698-6360
A3R7	0698-6360	6		RESISTOR 10K .1% .125W F TC=0+ .25	28480	0698-6360
A3R8	0698-0004	9	7	RESISTOR 2.15K 1% .125W F TC=0+ .100	24546	C4-1/8-T0-2151-F
A3R9	0698-6360	6		RESISTOR 10K .1% .125W F TC=0+ .25	28480	0698-6360
A3R10	0757-0280	3		RESISTOR 1K 1% .125W F TC=0+ .100	24546	C4-1/8-T0-1001-F
A3R11	0698-8204	1	6	RESISTOR 7.98K .1% .125W F TC=0+ .25	19701	MF4C1/8-T9-7981-R
A3R12	0698-8205	2	5	RESISTOR 15.98K .1% .125W F TC=0+ .25	19701	MF4C1/8-T9-15981-R
A3R13	0698-8047	0	5	RESISTOR 32K .1% .125W F TC=0+ .25	19701	MF4C1/8-T9-3202-R
A3R14	0698-8049	2	5	RESISTOR 64K .1% .125W F TC=0+ .25	19701	MF4C1/8-T9-6402-R
A3R15	0698-8053	8	5	RESISTOR 128K .1% .125W F TC=0+ .25	19701	MF4C1/8-T9-1283-R
A3R16	0698-8050	5	5	RESISTOR 256K .1% .125W F TC=0+ .25	19701	MF4C1/8-T9-2563-R
A3R17	0698-8958	2	2	RESISTOR 511K 1% .125W F TC=0+ .100	28480	0698-8958
A3R18	0698-8827	4	5	RESISTOR 1M 1% .125W F TC=0+ .100	28480	0698-8827
A3R19	0757-0280	3		RESISTOR 1K 1% .125W F TC=0+ .100	24546	C4-1/8-T0-1001-F
A3R20	0698-6360	6		RESISTOR 10K .1% .125W F TC=0+ .25	28480	0698-6360
A3R21	0698-6360	6		RESISTOR 10K .1% .125W F TC=0+ .25	28480	0698-6360
A3R22	0698-6360	6		RESISTOR 10K .1% .125W F TC=0+ .25	28480	0698-6360
A3R23	0698-6360	6		RESISTOR 10K .1% .125W F TC=0+ .25	28480	0698-6360
A3R24	0698-6360	6		RESISTOR 10K .1% .125W F TC=0+ .25	28480	0698-6360
A3R25	0698-8204	1		RESISTOR 7.98K .1% .125W F TC=0+ .25	19701	MF4C1/8-T9-7981-R

†Refer to Section 7 for update information.

*Factory Selected Component (Refer to Section 5).

△ Errata part change.

Table 6-3. Replaceable Parts

Reference Designation	HP Part Number	C D	Qty.	Description	Mfr. Code	Mfr. Part Number
A3R26	0698-8205	2		RESISTOR 15.98K 1% .125W F TC=0+-25	19701	MF4C1/8-T9-15981-B
A3R27	0698-8047	0		RESISTOR 32K 1% .125W F TC=0+-25	19701	MF4C1/8-T9-3202-B
A3R28	0698-8049	2		RESISTOR 84K 1% .125W F TC=0+-25	19701	MF4C1/8-T9-8402-B
A3R29	0698-8053	8		RESISTOR 128K 1% .125W F TC=0+-25	19701	MF4C1/8-T9-1283-B
A3R30	0698-8050	5		RESISTOR 256K 1% .125W F TC=0+-25	19701	MF4C1/8-T9-2563-B
A3R31	0698-8958	2		RESISTOR 511K 1% .125W F TC=0+-100	28480	0698-8958
A3R32	0698-8827	4		RESISTOR 1M 1% .125W F TC=0+-100	28480	0698-8827
A3R33	0757-0280	3		RESISTOR 1K 1% .125W F TC=0+-100	24546	C4-1/8-T0-1001-F
A3R34	0757-0280	3		RESISTOR 1K 1% .125W F TC=0+-100	24546	C4-1/8-T0-1001-F
A3R35	0757-0442	9		RESISTOR 10K 1% .125W F TC=0+-100	24546	C4-1/8-T0-1002-F
A3R36	0757-0280	3		RESISTOR 1K 1% .125W F TC=0+-100	24546	C4-1/8-T0-1001-F
A3R37	0698-3157	3		RESISTOR 19.6K 1% .125W F TC=0+-100	24546	C4-1/8-T0-1962-F
A3R38	0698-3157	3		RESISTOR 19.6K 1% .125W F TC=0+-100	24546	C4-1/8-T0-1962-F
A3R39	0698-3157	3		RESISTOR 19.6K 1% .125W F TC=0+-100	24546	C4-1/8-T0-1962-F
A3R40	0698-3157	3		RESISTOR 19.6K 1% .125W F TC=0+-100	24546	C4-1/8-T0-1962-F
A3R41	0757-0438	3		RESISTOR 5.11K 1% .125W F TC=0+-100	24546	C4-1/8-T0-5111-F
A3R42	0757-0442	9		RESISTOR 10K 1% .125W F TC=0+-100	24546	C4-1/8-T0-1002-F
A3R43	0757-0442	9		RESISTOR 10K 1% .125W F TC=0+-100	24546	C4-1/8-T0-1002-F
A3R44	0757-0438	3		RESISTOR 5.11K 1% .125W F TC=0+-100	24546	C4-1/8-T0-5111-F
A3R45	0757-0442	9		RESISTOR 10K 1% .125W F TC=0+-100	24546	C4-1/8-T0-1002-F
A3R46	0757-0465	6		RESISTOR 100K 1% .125W F TC=0+-100	24546	C4-1/8-T0-1003-F
A3R47	0757-0280	3		RESISTOR 1K 1% .125W F TC=0+-100	24546	C4-1/8-T0-1001-F
A3R48	0757-0465	6		RESISTOR 100K 1% .125W F TC=0+-100	24546	C4-1/8-T0-1003-F
A3R49	0698-0084	9		RESISTOR 2.15K 1% .125W F TC=0+-100	24546	C4-1/8-T0-2151-F
A3R50	0698-0084	9		RESISTOR 2.15K 1% .125W F TC=0+-100	24546	C4-1/8-T0-2151-F
A3R51	0698-6360	6		RESISTOR 10K 1% .125W F TC=0+-25	28480	0698-6360
A3R52	0698-6360	6		RESISTOR 10K 1% .125W F TC=0+-25	28480	0698-6360
A3R53	0698-3160	8		RESISTOR 31.6K 1% .125W F TC=0+-100	24546	C4-1/8-T0-3162-F
A3R54	0757-0465	6		RESISTOR 100K 1% .125W F TC=0+-100	24546	C4-1/8-T0-1003-F
A3R55	0698-3200	7	1	RESISTOR 8K 1% .125W F TC=0+-100	24546	C4-1/8-T0-8001-F
A3R56	0757-0279	0	14	RESISTOR 3.16K 1% .125W F TC=0+-100	24546	C4-1/8-T0-3161-F
A3R57	0757-0458	7	2	RESISTOR 51.1K 1% .125W F TC=0+-100	24546	C4-1/8-T0-5112-F
A3R58	0698-3245	0	1	RESISTOR 20.5K 1% .125W F TC=0+-100	24546	C4-1/8-T0-2052-F
A3R59	0757-0442	9		RESISTOR 10K 1% .125W F TC=0+-100	24546	C4-1/8-T0-1002-F
A3R60	0698-3454	3	1	RESISTOR 215K 1% .125W F TC=0+-100	24546	C4-1/8-T0-2153-F
A3R61	0757-0465	6		RESISTOR 100K 1% .125W F TC=0+-100	24546	C4-1/8-T0-1003-F
A3R62	2100-3355	0		RESISTOR-TRMR 100K 10% C SIDE-ADJ 1-TRN	28480	2100-3355
A3R63	2100-3355	0		RESISTOR-TRMR 100K 10% C SIDE-ADJ 1-TRN	28480	2100-3355
A3R64	0698-3453	2	3	RESISTOR 196K 1% .125W F TC=0+-100	24546	C4-1/8-T0-1963-F
A3R65	0698-3453	2		RESISTOR 196K 1% .125W F TC=0+-100	24546	C4-1/8-T0-1963-F
A3R66	0757-0416	7	7	RESISTOR 511 1% .125W F TC=0+-100	24546	C4-1/8-T0-5111-F
A3R67	0757-0416	7		RESISTOR 511 1% .125W F TC=0+-100	24546	C4-1/8-T0-5111-F
A3R68	0757-0416	7		RESISTOR 511 1% .125W F TC=0+-100	24546	C4-1/8-T0-5111-F
A3R69	0757-0416	7		RESISTOR 511 1% .125W F TC=0+-100	24546	C4-1/8-T0-5111-F
A3R70	0757-0290	5		RESISTOR 6.19K 1% .125W F TC=0+-100	19701	MF4C1/8-T0-6191-F
A3R71	0757-0290	5		RESISTOR 6.19K 1% .125W F TC=0+-100	19701	MF4C1/8-T0-6191-F
A3R72	0757-0279	0		RESISTOR 3.16K 1% .125W F TC=0+-100	24546	C4-1/8-T0-3161-F
A3R73	0757-0279	0		RESISTOR 3.16K 1% .125W F TC=0+-100	24546	C4-1/8-T0-3161-F
A3R74				NOT ASSIGNED		
A3R75	0757-0439	4		RESISTOR 6.81K 1% .125W F TC=0+-100	24546	C4-1/8-T0-6811-F

†Refer to Section 7 for update information.

*Factory Selected Component (Refer to Section 5).

Δ Errata part change.

Table 6-3. Replaceable Parts

Reference Designation	HP Part Number	C D	Qty.	Description	Mfr. Code	Mfr. Part Number
A3R76	0757-0439	4		RESISTOR 6.81K 1% .125W F TC=0+-100	24546	C4-1/8-T0-6811-F
A3R77	0698-3157	3		RESISTOR 19.6K 1% .125W F TC=0+-100	24546	C4-1/8-T0-1962-F
A3R78	0698-3157	3		RESISTOR 19.6K 1% .125W F TC=0+-100	24546	C4-1/8-T0-1962-F
A3R79	0757-0956	0	2	RESISTOR 22K 2% .125W F TC=0+-100	24546	C4-1/8-T0-2202-G
A3R80	0757-0956	0		RESISTOR 22K 2% .125W F TC=0+-100	24546	C4-1/8-T0-2202-G
A3R81	0757-1094	9	7	RESISTOR 1.47K 1% .125W F TC=0+-100	24546	C4-1/8-T0-1471-F
A3R82	0757-1094	9		RESISTOR 1.47K 1% .125W F TC=0+-100	24546	C4-1/8-T0-1471-F
A3R83	0757-0278	9	4	RESISTOR 1.78K 1% .125W F TC=0+-100	24546	C4-1/8-T0-1781-F
A3R84	0757-0278	9		RESISTOR 1.78K 1% .125W F TC=0+-100	24546	C4-1/8-T0-1781-F
A3R85	0698-8869	4	2	RESISTOR 2.15K .25% .125W F TC=0+-100	28480	0698-8869
A3R86	0698-8869	4		RESISTOR 2.15K .25% .125W F TC=0+-100	28480	0698-8869
A3R87	0757-0416	7		RESISTOR 511 1% .125W F TC=0+-100	24546	C4-1/8-T0-511R-F
A3R88	0757-0416	7		RESISTOR 511 1% .125W F TC=0+-100	24546	C4-1/8-T0-511R-F
A3R89	0698-4339	5	2	RESISTOR 11.111K .1% .125W F TC=0+-50	28480	0698-4339
A3R90	0698-4339	5		RESISTOR 11.111K .1% .125W F TC=0+-50	28480	0698-4339
A3R91	0698-8655	6	2	RESISTOR 13.3K .1% .125W F TC=0+-50	28480	0698-8655
A3R92	0698-8655	6		RESISTOR 13.3K .1% .125W F TC=0+-50	28480	0698-8655
A3R93	0698-6360	6		RESISTOR 10K .1% .125W F TC=0+-25	28480	0698-6360
A3R94	0757-0290	5		RESISTOR 6.19K 1% .125W F TC=0+-100	19701	MF4C1/8-T0-6191-F
A3R95	0757-0279	0		RESISTOR 3.16K 1% .125W F TC=0+-100	24546	C4-1/8-T0-3161-F
A3R96	0757-0280	3		RESISTOR 1K 1% .125W F TC=0+-100	24546	C4-1/8-T0-1001-F
A3R97	0698-6360	6		RESISTOR 10K .1% .125W F TC=0+-25	28480	0698-6360
A3R98	0698-6630	3	7	RESISTOR 20K .1% .125W F TC=0+-25	28480	0698-6630
A3R99	0698-6360	6		RESISTOR 10K .1% .125W F TC=0+-25	28480	0698-6360
A3R100	0698-6360	6		RESISTOR 10K .1% .125W F TC=0+-25	28480	0698-6360
A3R101	0698-0594	8	1	RESISTOR 2.21K .1% .125W F TC=0+-25	28480	0698-0594
A3R102	0698-6630	3		RESISTOR 20K .1% .125W F TC=0+-25	28480	0698-6630
A3TP1	1251-0600	0		CONNECTOR-SGL CONT PIN 1.14-MM-BSC-SZ SQ	28480	1251-0600
A3TP2	1251-0600	0		CONNECTOR-SGL CONT PIN 1.14-MM-BSC-SZ SQ	28480	1251-0600
A3TP3	1251-0600	0		CONNECTOR-SGL CONT PIN 1.14-MM-BSC-SZ SQ	28480	1251-0600
A3TP4	1251-0600	0		CONNECTOR-SGL CONT PIN 1.14-MM-BSC-SZ SQ	28480	1251-0600
A3TP5	1251-0600	0		CONNECTOR-SGL CONT PIN 1.14-MM-BSC-SZ SQ	28480	1251-0600
A3TP6	1251-0600	0		CONNECTOR-SGL CONT PIN 1.14-MM-BSC-SZ SQ	28480	1251-0600
A3TP7	1251-0600	0		CONNECTOR-SGL CONT PIN 1.14-MM-BSC-SZ SQ	28480	1251-0600
A3TP8	1251-0600	0		CONNECTOR-SGL CONT PIN 1.14-MM-BSC-SZ SQ	28480	1251-0600
A3TP9	1251-0600	0		CONNECTOR-SGL CONT PIN 1.14-MM-BSC-SZ SQ	28480	1251-0600
A3TP10	1251-0600	0		CONNECTOR-SGL CONT PIN 1.14-MM-BSC-SZ SQ	28480	1251-0600
A3TP11	1251-0600	0		CONNECTOR-SGL CONT PIN 1.14-MM-BSC-SZ SQ	28480	1251-0600
A3TP12	1251-0600	0		CONNECTOR-SGL CONT PIN 1.14-MM-BSC-SZ SQ	28480	1251-0600
A3TP13	1251-0600	0		CONNECTOR-SGL CONT PIN 1.14-MM-BSC-SZ SQ	28480	1251-0600
A3TP14	1251-0600	0		CONNECTOR-SGL CONT PIN 1.14-MM-BSC-SZ SQ	28480	1251-0600
A3TP15	1251-0600	0		CONNECTOR-SGL CONT PIN 1.14-MM-BSC-SZ SQ	28480	1251-0600
A3U1	1826-1491	9	4	IC OP AMP GP DIP-PKG	01295	LM201AL
A3U2	1826-0025	2	2	IC OP AMP LOW-DRIFT TO-99 PKG	27014	LM208AH
A3U3	1826-0025	2		IC OP AMP LOW-DRIFT TO-99 PKG	27014	LM208AH
A3U4	1826-0014	9	3	IC MULTIPLIER 14-DIP-C PKG	04713	MC1595L
A3U5	1826-0783	9		IC OP AMP LOW-NOISE 8-DIP-C PKG	52063	XR5534ACN

†Refer to Section 7 for update information.

*Factory Selected Component (Refer to Section 5).

Δ Errata part change.

Table 6-3. Replaceable Parts

Reference Designation	HP Part Number	C D	Qty.	Description	Mfr. Code	Mfr. Part Number
A3U6	1826-0662	3	4	IC OP AMP LOW-BIAS-H-IMPD TO-99 PKG	28480	1826-0662
A3U7	1826-0109	3	4	IC OP AMP WB TO-99 PKG	34371	HA2-2625-B0593
A3U8	1826-0412	1	1	IC COMPARATOR PRCN DUAL 8-DIP-P PKG	27014	LM339N
A3U9	08903-80041	1		IC LIN SPECIAL	28480	08903-80041
A3U10	1826-0138	8	10	IC COMPARATOR GP QUAD 14-DIP-P PKG	01295	LM339N
A3U11	1826-0783	9		IC OP AMP LOW-NOISE 8-DIP-C PKG	52063	XR5534ACN
A3U12	1826-0783	9		IC OP AMP LOW-NOISE 8-DIP-C PKG	52063	XR5534ACN
A3U13	1826-0662	3		IC OP AMP LOW-BIAS-H-IMPD TO-99 PKG	28480	1826-0662
A3U14	1826-0138	8		IC COMPARATOR GP QUAD 14-DIP-P PKG	01295	LM339N
A3U15	1826-0138	8		IC COMPARATOR GP QUAD 14-DIP-P PKG	01295	LM339N
A3U16	1826-0138	8		IC COMPARATOR GP QUAD 14-DIP-P PKG	01295	LM339N
A3U17	1826-0421	2		IC CONV RMS/DC 14-DIP-C PKG	24355	AD536AJ
A3U18	1826-1796	6		IC OP AMP H-SLEW-RATE DUAL 8-DIP-P PKG	02037	MC34082P
A3U19	1826-0740	8	1	IC SWITCH ANLG DUAL 16-DIP-C PKG	32293	IH5043CDE

†Refer to Section 7 for update information.

*Factory Selected Component (Refer to Section 5).

△ Errata part change.

Table 6-3. Replaceable Parts

Reference Designation	HP Part Number	C D	Qty.	Description	Mfr. Code	Mfr. Part Number
A4	08903-60128 – SERIAL PREFIX 2450A TO 2720A (HP8903B)					
A4	08903-60128	3	1	OUTPUT AMPLIFIER/VOLTMETER ASSEMBLY	28480	08903-60128
A4C1	0180-2207	5		CAPACITOR-FXD 100UF +-10% 10VDC TA	56289	150D107X9010R2
A4C2	0180-0100	3		CAPACITOR-FXD 4.7UF +-10% 35VDC TA	56289	150D475X9035B2
A4C3	0180-0374	3		CAPACITOR-FXD 10UF +-10% 20VDC TA	56289	150D106X9020B2
A4C4	0180-0100	3		CAPACITOR-FXD 4.7UF +-10% 35VDC TA	56289	150D475X9035B2
A4C5	0180-0291	3	15	CAPACITOR-FXD 1UF +-10% 35VDC TA	56289	150D105X9035A2
A4C6	0180-0291	3		CAPACITOR-FXD 1UF +-10% 35VDC TA	56289	150D105X9035A2
A4C7	0180-0291	3		CAPACITOR-FXD 1UF +-10% 35VDC TA	56289	150D105X9035A2
A4C8	0180-0291	3		CAPACITOR-FXD 1UF +-10% 35VDC TA	56289	150D105X9035A2
A4C9	0160-4805	1	6	CAPACITOR-FXD 47PF +-5% 100VDC CER 0+-30	28480	0160-4805
A4C10	0160-2236	8		CAPACITOR-FXD 1PF +-0.25PF 500VDC CER	28480	0160-2236
A4C11	0180-0374	3		CAPACITOR-FXD 10UF +-10% 20VDC TA	56289	150D106X9020B2
A4C12	0160-4843	7	2	CAPACITOR-FXD 47UF +80-20% 50VDC CER	28480	0160-4843
A4C13	0160-5875	8	1	CAPACITOR-FXD 1300PF +-1% 50VDC CER	28480	0160-5875
A4C14	0160-5409	3	1	CAPACITOR-FXD 3000PF +-5% 50VDC CER	28480	0160-5409
A4C15	0160-0336	5	2	CAPACITOR-FXD 100PF +-1% 300VDC MICA	28480	0160-0336
A4C16	0160-4679	7	1	CAPACITOR-FXD 270PF +-1% 300VDC MICA	28480	0160-4679
A4C17	0160-4456	8	2	CAPACITOR-FXD 750PF +-1% 300VDC MICA	28480	0160-4456
A4C18	0160-0335	4	1	CAPACITOR-FXD 91PF +-1% 300VDC MICA 0+-70	28480	0160-0335
A4C19	0160-3046	0	1	CAPACITOR-FXD 250PF +-1% 100VDC MICA	28480	0160-3046
A4C20	0160-4456	8		CAPACITOR-FXD 750PF +-1% 300VDC MICA	28480	0160-4456
A4C21	0160-3324	7	4	CAPACITOR-FXD 1UF +-5% 100VDC MET-POLYC	28480	0160-3324
A4C22	0160-4793	6	2	CAPACITOR-FXD 6.8PF +-0.5PF 100VDC CER	28480	0160-4793
A4C23	0160-3324	7		CAPACITOR-FXD 1UF +-5% 100VDC MET-POLYC	28480	0160-3324
A4C24	0160-4799	2	3	CAPACITOR-FXD 2.2PF +-0.25PF 100VDC CER	28480	0160-4799
A4C25	0180-2206	4	3	CAPACITOR-FXD 60UF +-10% 6VDC TA	56289	150D606X9006B2
A4C26	0180-0229	7	4	CAPACITOR-FXD 33UF +-10% 10VDC TA	56289	150D336X9010B2
A4C27	0160-3324	7		CAPACITOR-FXD 1UF +-5% 100VDC MET-POLYC	28480	0160-3324
A4C28	0160-4805	1		CAPACITOR-FXD 47PF +-5% 100VDC CER 0+-30	28480	0160-4805
A4C29	0160-4805	1		CAPACITOR-FXD 47PF +-5% 100VDC CER 0+-30	28480	0160-4805
A4C30	0160-4835	7		CAPACITOR-FXD 1UF +-10% 50VDC CER	28480	0160-4835
A4C31	0160-4835	7		CAPACITOR-FXD 1UF +-10% 50VDC CER	28480	0160-4835
A4C32*	0160-4382	9		CAPACITOR-FXD 3.3PF +-0.25PF 200VDC CER NOT NORMALLY LOADED.		
				SEE SECTION 5, TABLE 5 1		
A4C33	0160-4799	2		CAPACITOR-FXD 2.2PF +-0.25PF 100VDC CER	28480	0160-4799
A4C34	0180-2206	4		CAPACITOR-FXD 60UF +-10% 6VDC TA	56289	150D606X9006B2
A4C35	0160-4835	7		CAPACITOR-FXD 1UF +-10% 50VDC CER	28480	0160-4835
A4C36	0160-4835	7		CAPACITOR-FXD 1UF +-10% 50VDC CER	28480	0160-4835
A4C37	0160-2236	8		CAPACITOR-FXD 1PF +-0.25PF 500VDC CER	28480	0160-2236
A4C38	0180-2207	5		CAPACITOR-FXD 100UF +-10% 10VDC TA	56289	150D107X9010R2
A4C39	0160-4805	1		CAPACITOR-FXD 47PF +-5% 100VDC CER 0+-30	28480	0160-4805
A4C40	0160-4793	6		CAPACITOR-FXD 6.8PF +-0.5PF 100VDC CER	28480	0160-4793
A4C41	0160-4814	2		CAPACITOR-FXD 150PF +-5% 100VDC CER	28480	0160-4814
A4C42	0160-4810	8	1	CAPACITOR-FXD 330PF +-5% 100VDC CER	28480	0160-4810
A4C43	0160-4835	7		CAPACITOR-FXD 1UF +-10% 50VDC CER	28480	0160-4835
A4C44	0160-4835	7		CAPACITOR-FXD 1UF +-10% 50VDC CER	28480	0160-4835
A4C45	0180-0291	3		CAPACITOR-FXD 1UF +-10% 35VDC TA	56289	150D105X9035A2

†Refer to Section 7 for update information.

*Factory Selected Component (Refer to Section 5).

△ Errata part change.

Table 6-3. Replaceable Parts

Reference Designation	HP Part Number	C D	Qty.	Description	Mfr. Code	Mfr. Part Number
A4 08903-60128 – SERIAL PREFIX 2450A TO 2720A (HP8903B)						
A4C46	0160-4835	7		CAPACITOR-FXD .1UF +-10% 50VDC CER	28480	0160-4835
A4C47	0160-4805	1		CAPACITOR-FXD 47PF +-5% 100VDC CER 0+-30	28480	0160-4805
A4C48	0160-4835	7		CAPACITOR-FXD .1UF +-10% 50VDC CER	28480	0160-4835
A4C49	0160-4835	7		CAPACITOR-FXD .1UF +-10% 50VDC CER	28480	0160-4835
A4C50	0160-4799	2		CAPACITOR-FXD 2.2PF +-25PF 100VDC CER	28480	0160-4799
A4C51	0180-1746	5		CAPACITOR-FXD 15UF +-10% 20VDC TA	56289	150D156X9020B2
A4C52	0160-4814	2		CAPACITOR-FXD 150PF +-5% 100VDC CER	28480	0160-4814
A4C53	0180-3324	7		CAPACITOR-FXD 1UF +-5% 100VDC MET-POLYC	28480	0160-3324
A4C54	0160-4835	7		CAPACITOR-FXD .1UF +-10% 50VDC CER	28480	0160-4835
A4C55	0160-4835	7		CAPACITOR-FXD .1UF +-10% 50VDC CER	28480	0160-4835
A4C56	0160-4653	7	6	CAPACITOR-FXD .1UF +-5% 100VDC MET-POLYP	28480	0160-4653
A4C57	0160-4835	7		CAPACITOR-FXD .1UF +-10% 50VDC CER	28480	0160-4835
A4C58	0160-4814	2		CAPACITOR-FXD 150PF +-5% 100VDC CER	28480	0160-4814
A4C59	0160-4653	7		CAPACITOR-FXD .1UF +-5% 100VDC MET-POLYP	28480	0160-4653
A4C60	0160-4653	7		CAPACITOR-FXD .1UF +-5% 100VDC MET-POLYP	28480	0160-4653
A4C61	0160-4653	7		CAPACITOR-FXD .1UF +-5% 100VDC MET-POLYP	28480	0160-4653
A4C62	0160-4653	7		CAPACITOR-FXD .1UF +-5% 100VDC MET-POLYP	28480	0160-4653
A4C63	0160-4653	7		CAPACITOR-FXD .1UF +-5% 100VDC MET-POLYP	28480	0160-4653
A4C64	0160-4843	7		CAPACITOR-FXD 47UF +-80-20% 50VDC CER	28480	0160-4843
A4C65	0180-0220	6		CAPACITOR-FXD 22UF +-10% 15VDC TA	56289	150D226X9015B2
A4C66	0180-0228	6		CAPACITOR-FXD 22UF +-10% 15VDC TA	56289	150D226X9015B2
A4C67	0180-0228	6		CAPACITOR-FXD 22UF +-10% 15VDC TA	56289	150D226X9015B2
A4C68	0180-2206	4		CAPACITOR-FXD 60UF +-10% 6VDC TA	56289	150D606X9006B2
A4C69	0160-4807	3		CAPACITOR-FXD 33PF +-5% 100VDC CER 0+-30	28480	0160-4807
A4C70	0160-4397	6	1	CAPACITOR-FXD .1UF +-1% 100VDC POLYSTY	28480	0160-4397
A4C71	0180-0291	3		CAPACITOR-FXD 1UF +-10% 35VDC TA	56289	150D105X9035A2
A4C72	0160-5254	6	1	CAPACITOR-FXD 1.5PF +-25PF 100VDC CER	28480	0160-5254
A4C73	0160-4832	4		CAPACITOR-FXD .01UF +-10% 100VDC CER	28480	0160-4832
A4C74	0160-4832	4		CAPACITOR-FXD .01UF +-10% 100VDC CER	28480	0160-4832
A4C75	0160-4797	0	1	CAPACITOR-FXD 3.3PF +-25PF 100VDC CER	28480	019J-4797
A4C76	0160-4835	7		CAPACITOR-FXD .1UF +-10% 50VDC CER	28480	0160-4835
A4C77	0160-4790	3	1	CAPACITOR-FXD 12PF +-5% 100VDC CER 0+-30	28480	0160-4790
2450A TO 2520A						
A4CR1	1901-0376	6		DIODE-GEN PRP 35V 50MA DO-35	28480	1901-0376
A4CR2	1901-0376	6		DIODE-GEN PRP 35V 50MA DO-35	28480	1901-0376
2601A AND ABOVE						
A4CR1	1901-0050	3		DIODE-SWITCHING 80V 200MA 2NS DO-35	28480	1901-0050
A4CR2	1901-0050	3		DIODE-SWITCHING 80V 200MA 2NS DO-35	28480	1901-0050
A4CR3	1901-0040	1	7	DIODE-SWITCHING 30V 50MA 2NS DO-35	28480	1901-0040
2450A TO 2520A						
A4CR4	1901-0376	6		DIODE-GEN PRP 35V 50MA DO-35	28480	1901-0376
A4CR5	1901-0376	6		DIODE-GEN PRP 35V 50MA DO-35	28480	1901-0376
A4CR6	1901-0376	6		DIODE-GEN PRP 35V 50MA DO-35	28480	1901-0376
A4CR7	1901-0376	6		DIODE-GEN PRP 35V 50MA DO-35	28480	1901-0376
2601A AND ABOVE						
A4CR4	1901-0050	3		DIODE-SWITCHING 80V 200MA 2NS DO-35	28480	1901-0050
A4CR5	1901-0050	3		DIODE-SWITCHING 80V 200MA 2NS DO-35	28480	1901-0050
A4CR6	1901-0880	7		DIODE-GEN PRP 125MA DO-35	28480	1901-0880
A4CR7	1901-0050	3		DIODE-SWITCHING 80V 200MA 2NS DO-35	28480	1901-0050
A4CR8	1901-0050	3		DIODE-SWITCHING 80V 200MA 2NS DO-35	28480	1901-0050
A4CR9	1901-0050	3		DIODE-SWITCHING 80V 200MA 2NS DO-35	28480	1901-0050

† Refer to Section 7 for update information.

* Factory Selected Component (Refer to Section 5).

Δ Errata part change.

Table 6-3. Replaceable Parts

Reference Designation	HP Part Number	C D	Qty.	Description	Mfr. Code	Mfr. Part Number
A4 08903-60128 – SERIAL PREFIX 2450A TO 2720A (HP8903B)						
A4CR10	1901-0518	8		DIODE-SM SIG SCHOTTKY	28480	1901-0518
A4CR11	1901-0518	8		DIODE-SM SIG SCHOTTKY	28480	1901-0518
A4CR12	1901-0040	1		DIODE-SWITCHING 30V 50MA 2NS DO-35	28480	1901-0040
<i>2450A TO 2520A</i>						
A4CR13	1901-0376	6		DIODE-GEN PRP 35V 50MA DO-35	28480	1901-0376
<i>2601A AND ABOVE</i>						
A4CR13	1901-0050	3		DIODE-SWITCHING 80V 200MA 2NS DO-35	28480	1901-0050
A4CR14	1901-0040	1		DIODE-SWITCHING 30V 50MA 2NS DO-35	28480	1901-0040
A4CR15	1901-0040	1		DIODE-SWITCHING 30V 50MA 2NS DO-35	28480	1901-0040
<i>2450A TO 2520A</i>						
A4CR16	1901-0376	6		DIODE-GEN PRP 35V 50MA DO-35	28480	1901-0376
A2CR17	1901-0376	6		DIODE-GEN PRP 35V 50MA DO-35	28480	1901-0376
A4CR18	1901-0376	6		DIODE-GEN PRP 35V 50MA DO-35	28480	1901-0376
A4CR19	1901-0376	6		DIODE-GEN PRP 35V 50MA DO-35	28480	1901-0376
A4CR20	1901-0376	6		DIODE-GEN PRP 35V 50MA DO-35	28480	1901-0376
A4CR21	1901-0376	6		DIODE-GEN PRP 35V 50MA DO-35	28480	1901-0376
A4CR22	1901-0376	6		DIODE-GEN PRP 35V 50MA DO-35	28480	1901-0376
A4CR23	1901-0376	6		DIODE-GEN PRP 35V 50MA DO-35	28480	1901-0376
A4CR24	1901-0376	6		DIODE-GEN PRP 35V 50MA DO-35	28480	1901-0376
<i>2601A AND ABOVE</i>						
A4CR16	1901-0050	3		DIODE-SWITCHING 80V 200MA 2NS DO-35	28480	1901-0050
A4CR17	1901-0880	7		DIODE-GEN PRP 125MA DO-35	28480	1901-0880
A4CR18	1901-0880	7		DIODE-GEN PRP 125MA DO-35	28480	1901-0880
A4CR19	1901-0880	7		DIODE-GEN PRP 125MA DO-35	28480	1901-0880
A4CR20	1901-0880	7		DIODE-GEN PRP 125MA DO-35	28480	1901-0880
A4CR21	1901-0880	7		DIODE-GEN PRP 125MA DO-35	28480	1901-0880
A4CR22	1901-0880	7		DIODE-GEN PRP 125MA DO-35	28480	1901-0880
A4CR23	1901-0880	7		DIODE-GEN PRP 125MA DO-35	28480	1901-0880
A4CR24	1901-0880	7		DIODE-GEN PRP 125MA DO-35	28480	1901-0880
A4CR25	1901-0040	1		DIODE-SWITCHING 30V 50MA 2NS DO-35	28480	1901-0040
<i>2450A TO 2520A</i>						
A4CR26	1901-0376	6		DIODE-GEN PRP 35V 50MA DO-35	28480	1901-0376
<i>2601A AND ABOVE</i>						
A4CR26	1901-0880	7		DIODE-GEN PRP 125MA DO-35	28480	1901-0880
A4CR27	1901-0050	3		DIODE-SWITCHING 80V 200MA 2NS DO-35	28480	1901-0050
A4CR28	1901-0050	3		DIODE-SWITCHING 80V 200MA 2NS DO-35	28480	1901-0050
A4K1	0490-1423	2	1	RELAY-REED 1C 250MA 28VDC 5VDC-COIL 3VA	28480	0490-1423
A4L1	9140-0210	1	10	INDUCTOR RF-CH-MLD 100UH 5% .166DX.385LG	28480	9140-0210
A4L2	9140-0210	1		INDUCTOR RF-CH-MLD 100UH 5% .166DX.385LG	28480	9140-0210
A4L3	9100-0539	3	3	INDUCTOR (MISC ITEM)	28480	9100-0539
A4L4	9100-0539	3		INDUCTOR (MISC ITEM)	28480	9100-0539
A4L5	9100-0539	3		INDUCTOR (MISC ITEM)	28480	9100-0539
A4MP1	4040-0748	3		EXTR-PC BD BLK POLYC .062-BD-THKNS	28480	4040-0748
	1480-0116	8		PIN-GRV .062-IN-DIA .25-IN-LG STL	28480	1480-0116
A4MP2	4040-0752	9	1	EXTR-PC BD YEL POLYC .062-BD-THKNS	28480	4040-0752
	1480-0116	8		PIN-GRV .062-IN-DIA .25-IN-LG STL	28480	1480-0116
A4MP3	0403-0026	6		PLUG-HOLE BDR-HD FOR .187-D-HOLE NYL	02768	207-120241-03-0101
A4Q1 ^Δ	08903-80069	3	2	TRANSISTOR-DUAL NPN TO-71 PD = 500MW	28480	08903-80069
	1205-0202	1	2	THERMAL LINK DUAL TO-18-CS	28480	1205-0202
A4Q2	1854-0753	2		TRANSISTOR-DUAL NPN TO-71 PD = 500MW	28480	1854-0753
	1205-0202	1		THERMAL LINK DUAL TO-18-CS	28480	1205-0202
A4Q3	1855-0420	2	36	TRANSISTOR J-FET 2N4391 N-CHAN D-MODE	01295	2N4391
A4Q4	1854-0830	6	1	TRANSISTOR-DUAL NPN PD = 500MW	27014	LM394

†Refer to Section 7 for update information.

*Factory Selected Component (Refer to Section 5).

Δ Errata part change.

Table 6-3. Replaceable Parts

Reference Designation	HP Part Number	C D	Qty.	Description	Mfr. Code	Mfr. Part Number
A4 08903-60128 – SERIAL PREFIX 2450A TO 2720A (HP8903B)						
A4Q5	1855-0420	2		TRANSISTOR J-FET 2N4391 N-CHAN D-MODE	01295	2N4391
A4Q6	1855-0420	2		TRANSISTOR J-FET 2N4391 N-CHAN D-MODE	01295	2N4391
A4Q7	1855-0420	2		TRANSISTOR J-FET 2N4391 N-CHAN D-MODE	01295	2N4391
A4Q8	1855-0420	2		TRANSISTOR J-FET 2N4391 N-CHAN D-MODE	01295	2N4391
A4Q9	1855-0420	2		TRANSISTOR J-FET 2N4391 N-CHAN D-MODE	01295	2N4391
A4Q10	1854-0071	7	1	TRANSISTOR NPN SI PD=300MW FT=200MHZ	28480	1854-0071
A4Q11	1853-0281	9	4	TRANSISTOR PNP 2N2907A SI TO-18 PD=400MW	04713	2N2907A
A4Q12	1853-0281	9		TRANSISTOR PNP 2N2907A SI TO-18 PD=400MW	04713	2N2907A
A4R1	0757-0279	0		RESISTOR 3.16K 1% .125W F TC=0+-100	24546	C4-1/8-T0-3161-F
A4R2	0757-0441	8		RESISTOR 8.25K 1% .125W F TC=0+-100	24546	C4-1/8-T0-8251-F
A4R3	0698-6343	5	7	RESISTOR 9K .1% .125W F TC=0+-25	28480	0698-6343
A4R4	0698-6362	8	7	RESISTOR 1K .1% .125W F TC=0+-25	28480	0698-6362
A4R5	0757-0441	8		RESISTOR 8.25K 1% .125W F TC=0+-100	24546	C4-1/8-T0-8251-F
A4R6	0757-0422	5	4	RESISTOR 909 1% .125W F TC=0+-100	24546	C4-1/8-T0-909R-F
A4R7	0698-8822	9	10	RESISTOR 6.81 1% .125W F TC=0+-100	28480	0698-8822
A4R8	0698-8822	9		RESISTOR 6.81 1% .125W F TC=0+-100	28480	0698-8822
A4R9	0698-8822	9		RESISTOR 6.81 1% .125W F TC=0+-100	28480	0698-8822
A4R10	0698-8822	9		RESISTOR 6.81 1% .125W F TC=0+-100	28480	0698-8822
A4R11	0698-0084	9		RESISTOR 2.15K 1% .125W F TC=0+-100	24546	C4-1/8-T0-2151-F
A4R12	0698-6360	6		RESISTOR 10K 1% .125W F TC=0+-25	28480	0698-6360
A4R13	0698-6631	4	7	RESISTOR 2.5K .1% .125W F TC=0+-25	28480	0698-6631
A4R14	0757-0280	3		RESISTOR 1K 1% .125W F TC=0+-100	24546	C4-1/8-T0-1001-F
A4R15	0757-0274	5	3	RESISTOR 1.21K 1% .125W F TC=0+-100	24546	C4-1/8-T0-1211-F
A4R16	0757-0274	5		RESISTOR 1.21K 1% .125W F TC=0+-100	24546	C4-1/8-T0-1211-F
A4R17	0757-0443	0	1	RESISTOR 11K 1% .125W F TC=0+-100	24546	C4-1/8-T0-1102-F
A4R18	0757-0280	3		RESISTOR 1K 1% .125W F TC=0+-100	24546	C4-1/8-T0-1001-F
A4R19	0757-0438	3		RESISTOR 5.11K 1% .125W F TC=0+-100	24546	C4-1/8-T0-5111-F
A4R20	0757-0437	2	1	RESISTOR 4.75K 1% .125W F TC=0+-100	24546	C4-1/8-T0-4751-F
A4R21				NOT ASSIGNED		
A4R22	0757-1094	9		RESISTOR 1.47K 1% .125W F TC=0+-100	24546	C4-1/8-T0-1471-F
A4R23	0698-3484	9		RESISTOR 6.65K 1% .125W F TC=0+-100	24546	C4-1/8-T0-6651-F
A4R24	0698-4470	5	1	RESISTOR 6.98K 1% .125W F TC=0+-100	24546	C4-1/8-T0-6981-F
A4R25	0698-3151	7	6	RESISTOR 2.87K 1% .125W F TC=0+-100	24546	C4-1/8-T0-2871-F
A4R26	0757-0447	4		RESISTOR 16.2K 1% .125W F TC=0+-100	24546	C4-1/8-T0-1622-F
A4R27	0698-3151	7		RESISTOR 2.87K 1% .125W F TC=0+-100	24546	C4-1/8-T0-2871-F
A4R28	0757-0439	4		RESISTOR 6.81K 1% .125W F TC=0+-100	24546	C4-1/8-T0-6811-F
A4R29	0698-6631	4		RESISTOR 2.5K .1% .125W F TC=0+-25	28480	0698-6631
A4R30	0698-6631	4		RESISTOR 2.5K .1% .125W F TC=0+-25	28480	0698-6631
A4R31	0757-0199	3	1	RESISTOR 21.5K 1% .125W F TC=0+-100	24546	C4-1/8-T0-2152-F
A4R32	0757-0280	3		RESISTOR 1K 1% .125W F TC=0+-100	24546	C4-1/8-T0-1001-F
A4R33	0757-0422	5		RESISTOR 909 1% .125W F TC=0+-100	24546	C4-1/8-T0-909R-F
A4R34	0698-6343	5		RESISTOR 9K .1% .125W F TC=0+-25	28480	0698-6343
A4R35	0698-6362	8		RESISTOR 1K 1% .125W F TC=0+-25	28480	0698-6362
A4R36	0757-0447	4		RESISTOR 16.2K 1% .125W F TC=0+-100	24546	C4-1/8-T0-1622-F
A4R37	0757-0447	4		RESISTOR 16.2K 1% .125W F TC=0+-100	24546	C4-1/8-T0-1622-F
A4R38	0698-3151	7		RESISTOR 2.87K 1% .125W F TC=0+-100	24546	C4-1/8-T0-2871-F
A4R39	0757-0447	4		RESISTOR 16.2K 1% .125W F TC=0+-100	24546	C4-1/8-T0-1622-F
A4R40	0698-3151	7		RESISTOR 2.87K 1% .125W F TC=0+-100	24546	C4-1/8-T0-2871-F
A4R41	0757-0470	3	4	RESISTOR 162K 1% .125W F TC=0+-100	24546	C4-1/8-T0-1623-F

† Refer to Section 7 for update information.

* Factory Selected Component (Refer to Section 5).

Δ Errata part change.

Table 6-3. Replaceable Parts

Reference Designation	HP Part Number	C D	Qty.	Description	Mfr. Code	Mfr. Part Number
A4 08903-60128 – SERIAL PREFIX 2450A TO 2720A (HP8903B)						
A4R42	0698 3151	7		RESISTOR 2.87K 1% .125W F TC=0+-100	24546	C4-1/8-T0-2871-F
A4R43	0757-0447	4		RESISTOR 16.2K 1% .125W F TC=0+-100	24546	C4-1/8-T0-1622-F
A4R44	0698 3151	7		RESISTOR 2.87K 1% .125W F TC=0+-100	24546	C4-1/8-T0-2871-F
A4R45	0698 6343	5		RESISTOR 9K 1% .125W F TC=0+-25	28480	0698-6343
A4R46	0698-6362	8		RESISTOR 1K .1% .125W F TC=0+-25	28480	0698-6362
A4R47	0757-0422	5		RESISTOR 909 1% .125W F TC=0+-100	24546	C4-1/8-T0-909R-F
A4R48	0698-6343	5		RESISTOR 9K .1% .125W F TC=0+-25	28480	0698-6343
A4R49	0698 6343	5		RESISTOR 9K .1% .125W F TC=0+-25	28480	0698-6343
A4R50	0698-6362	8		RESISTOR 1K .1% .125W F TC=0+-25	28480	0698-6362
A4R51	0698 6362	8		RESISTOR 1K .1% .125W F TC=0+-25	28480	0698-6362
A4R52	0757-0280	3		RESISTOR 1K 1% .125W F TC=0+-100	24546	C4-1/8-T0-1001-F
A4R53	0698 0550	6	1	RESISTOR 620 5% .25W CC TC=0+-800	28480	0698-0550
A4R54	0698 0085	0	2	RESISTOR 2.61K 1% .125W F TC=0+-100	24546	C4-1/8-T0-2611-F
A4R55	0698-6360	6		RESISTOR 10K .1% .125W F TC=0+-25	28480	0698-6360
A4R56	0698 3160	8		RESISTOR 31.6K 1% .125W F TC=0+-100	24546	C4-1/8-T0-3162-F
A4R57	0698-3160	8		RESISTOR 31.6K 1% .125W F TC=0+-100	24546	C4-1/8-T0-3162-F
A4R58	0757 0280	3		RESISTOR 1K 1% .125W F TC=0+-100	24546	C4-1/8-T0-1001-F
A4R59	0757 0439	3		RESISTOR 5.11K 1% .125W F TC=0+-100	24546	C4-1/8-T0-5111-F
A4R60	0757-0442	9		RESISTOR 10K 1% .125W F TC=0+-100	24546	C4-1/8-T0-1002-F
A4R61	0698-3152	8		RESISTOR 3.48K 1% .125W F TC=0+-100	24546	C4-1/8-T0-3481-F
A4R62	0698-6360	6		RESISTOR 10K .1% .125W F TC=0+-25	28480	0698-6360
A4R63	0698-8822	9		RESISTOR 6.81 1% .125W F TC=0+-100	28480	0698-8822
A4R64	0757-0465	6		RESISTOR 100K 1% .125W F TC=0+-100	24546	C4-1/8-T0-1003-F
A4R65	0757-0438	3		RESISTOR 5.11K 1% .125W F TC=0+-100	24546	C4-1/8-T0-5111-F
A4R66	0698 3150	6		RESISTOR 2.37K 1% .125W F TC=0+-100	24546	C4-1/8-T0-2371-F
A4R67	0698 3153	9	5	RESISTOR 3.83K 1% .125W F TC=0+-100	24546	C4-1/8-T0-3831-F
A4R68	0757-1108	6	1	RESISTOR 300 1% .125W F TC=0+-100	24546	C4-1/8-T0-301-F
A4R69	0757-0279	0		RESISTOR 3.16K 1% .125W F TC=0+-100	24546	C4-1/8-T0-3161-F
A4R70	0698-6530	3		RESISTOR 20K .1% .125W F TC=0+-25	28480	0698-6530
A4R71	0698-6360	6		RESISTOR 10K .1% .125W F TC=0+-25	28480	0698-6360
A4R72	0757-1094	9		RESISTOR 1.47K 1% .125W F TC=0+-100	24546	C4-1/8-T0-1471-F
A4R73	0698 3136	8	2	RESISTOR 17.8K 1% .125W F TC=0+-100	24546	C4-1/8-T0-1782-F
A4R74	0757-1094	9		RESISTOR 1.47K 1% .125W F TC=0+-100	24546	C4-1/8-T0-1471-F
A4R75	0757-0401	0	21	RESISTOR 100 1% .125W F TC=0+-100	24546	C4-1/8-T0-101-F
A4R76	0698-8822	9		RESISTOR 6.81 1% .125W F TC=0+-100	28480	0698-8822
A4R77	0698-8822	9		RESISTOR 6.81 1% .125W F TC=0+-100	28480	0698-8822
A4R78	0698-0084	9		RESISTOR 2.15K 1% .125W F TC=0+-100	24546	C4-1/8-T0-2151-F
A4R79	0757-0440	7		RESISTOR 7.5K 1% .125W F TC=0+-100	24546	C4-1/8-T0-7501-F
A4R80	0757-0442	9		RESISTOR 10K 1% .125W F TC=0+-100	24546	C4-1/8-T0-1002-F
A4R81	0757-0442	9		RESISTOR 10K 1% .125W F TC=0+-100	24546	C4-1/8-T0-1002-F
A4R82	0757 0438	3		RESISTOR 5.11K 1% .125W F TC=0+-100	24546	C4-1/8-T0-5111-F
A4R83	0698 3157	3		RESISTOR 19.6K 1% .125W F TC=0+-100	24546	C4-1/8-T0-1962-F
A4R84	0757 0280	3		RESISTOR 1K 1% .125W F TC=0+-100	24546	C4-1/8-T0-1001-F
A4R85	2100-3054	6	2	RESISTOR-TRMR 50K 10% C SIDE-ADJ 17-TRN	02111	43P503
A4R86	0698 3223	4	1	RESISTOR 1.24K 1% .125W F TC=0+-100	24546	C4-1/8-T0-1241-F
A4R87	0698-3459	8	2	RESISTOR 383K 1% .125W F TC=0+-100	28480	0698-3459
A4R88	0757-0280	3		RESISTOR 1K 1% .125W F TC=0+-100	24546	C4-1/8-T0-1001-F
A4R89	0757-0438	3		RESISTOR 5.11K 1% .125W F TC=0+-100	24546	C4-1/8-T0-5111-F
A4R90	0698-0526	6		RESISTOR 37.68K 1% .25W F TC=0+-25	28480	0698-0526
A4R91	2100 3056	8	1	RESISTOR-TRMR 5K 10% C SIDE-ADJ 17-TRN	02111	43P502

†Refer to Section 7 for update information.

*Factory Selected Component (Refer to Section 5).

Δ Errata part change.

Table 6-3. Replaceable Parts

Reference Designation	HP Part Number	C D	Qty.	Description	Mfr. Code	Mfr. Part Number
A4 08903-60128 – SERIAL PREFIX 2450A TO 2720A (HP8903B)						
A4R92	0698-8799	9	1	RESISTOR 21.5K .1% .125W F TC=0+-25	28480	0698-8799
A4R93	2100-3109	2	1	RESISTOR-TRMR 2K 10% C SIDE-ADJ 17-TRN	02111	43P202
A4R94	0698-3266	5	2	RESISTOR 237K 1% .125W F TC=0+-100	24546	C4-1/8-T0-2373-F
A4R95	0698-6630	3		RESISTOR 20K .1% .125W F TC=0+-25	28480	0698-6630
A4R96	0698-3266	5		RESISTOR 237K 1% .125W F TC=0+-100	24546	C4-1/8-T0-2373-F
A4R97	0757-0438	3		RESISTOR 5.11K 1% .125W F TC=0+-100	24546	C4-1/8-T0-5111-F
A4R98	0698-6630	3		RESISTOR 20K .1% .125W F TC=0+-25	28480	0698-6630
A4R99	0757-0280	3		RESISTOR 1K 1% .125W F TC=0+-100	24546	C4-1/8-T0-1001-F
A4R100	0757-0442	9		RESISTOR 10K 1% .125W F TC=0+-100	24546	C4-1/8-T0-1002-F
A4R101	0698-3243	8	1	RESISTOR 178K 1% .125W F TC=0+-100	24546	C4-1/8-T0-1783-F
A4R102				NOT ASSIGNED		
A4R103				NOT ASSIGNED		
A4R104	0757-0470	3		RESISTOR 162K 1% .125W F TC=0+-100	24546	C4-1/8-T0-1623-F
A4R105	0757-0200	7		RESISTOR 5.62K 1% .125W F TC=0+-100	24546	C4-1/8-T0-5621-F
A4R106				NOT ASSIGNED		
A4R107	0757-0464	5	2	RESISTOR 90.9K 1% .125W F TC=0+-100	24546	C4-1/8-T0-9092-F
A4R108	0698-3456	5	1	RESISTOR 287K 1% .125W F TC=0+-100	24546	C4-1/8-T0-2873-F
A4R109	0698-3453	2		RESISTOR 196K 1% .125W F TC=0+-100	24546	C4-1/8-T0-1963-F
A4R110	0698-6631	4		RESISTOR 2.5K .1% .125W F TC=0+-25	28480	0698-6631
A4R111	0698-6631	4		RESISTOR 2.5K .1% .125W F TC=0+-25	28480	0698-6631
A4R112	0757-0279	0		RESISTOR 3.16K 1% .125W F TC=0+-100	24546	C4-1/8-T0-3161-F
A4R113	0757-0470	3		RESISTOR 162K 1% .125W F TC=0+-100	24546	C4-1/8-T0-1623-F
A4R114	0757-0279	0		RESISTOR 3.16K 1% .125W F TC=0+-100	24546	C4-1/8-T0-3161-F
A4R115	0757-0279	0		RESISTOR 3.16K 1% .125W F TC=0+-100	24546	C4-1/8-T0-3161-F
A4R116	0757-0442	9		RESISTOR 10K 1% .125W F TC=0+-100	24546	C4-1/8-T0-1002-F
A4R117	0757-0279	0		RESISTOR 3.16K 1% .125W F TC=0+-100	24546	C4-1/8-T0-3161-F
A4R118	0757-0290	5		RESISTOR 6.19K 1% .125W F TC=0+-100	19701	MF4C1/8-T0-6191-F
A4R119	0757-0421	4	1	RESISTOR 825 1% .125W F TC=0+-100	24546	C4-1/8-T0-825R-F
A4R120	0698-3443	0	1	RESISTOR 287 1% .125W F TC=0+-100	24546	C4-1/8-T0-287R-F
A4R121	0757-0290	5		RESISTOR 6.19K 1% .125W F TC=0+-100	19701	MF4C1/8-T0-6191-F
A4R122	0757-0422	5		RESISTOR 909 1% .125W F TC=0+-100	24546	C4-1/8-T0-909R-F
A4R123	0698-3441	8	1	RESISTOR 215 1% .125W F TC=0+-100	24546	C4-1/8-T0-215R-F
A4R124	0698-0082	7	1	RESISTOR 464 1% .125W F TC=0+-100	24546	C4-1/8-T0-4640-F
A4R125	2100-3103	6	2	RESISTOR-TRMR 10K 10% C SIDE-ADJ 17-TRN	02111	43P103
A4R126	0757-0442	9		RESISTOR 10K 1% .125W F TC=0+-100	24546	C4-1/8-T0-1002-F
A4R127	0699-0239	8	1	RESISTOR 59K .1% .1W F TC=0+-15	28480	0699-0239
A4R128	0698-3150	6		RESISTOR 2.37K 1% .125W F TC=0+-100	24546	C4-1/8-T0-2371-F
A4R129	0698-0085	0		RESISTOR 2.61K 1% .125W F TC=0+-100	24546	C4-1/8-T0-2611-F
A4R130	0698-3153	9		RESISTOR 3.83K 1% .125W F TC=0+-100	24546	C4-1/8-T0-3831-F
A4R131	0757-0280	3		RESISTOR 1K 1% .125W F TC=0+-100	24546	C4-1/8-T0-1001-F
A4R132	0757-0405	4	2	RESISTOR 162 1% .125W F TC=0+-100	24546	C4-1/8-T0-162R-F
A4R133	0757-0200	7		RESISTOR 5.62K 1% .125W F TC=0+-100	24546	C4-1/8-T0-5621-F
A4R134	0698-8822	9		RESISTOR 6.81 1% .125W F TC=0+-100	28480	0698-8822
A4R135	0757-0405	4		RESISTOR 162 1% .125W F TC=0+-100	24546	C4-1/8-T0-162R-F
A4R136	0757-0465	6		RESISTOR 100K 1% .125W F TC=0+-100	24546	C4-1/8-T0-1003-F
A4R137	0757-0279	0		RESISTOR 3.16K 1% .125W F TC=0+-100	24546	C4-1/8-T0-3161-F
A4R138	0757-0279	0		RESISTOR 3.16K 1% .125W F TC=0+-100	24546	C4-1/8-T0-3161-F
A4R139	0757-1094	9		RESISTOR 1.47K 1% .125W F TC=0+-100	24546	C4-1/8-T0-1471-F
A4R140	0698-3153	9		RESISTOR 3.83K 1% .125W F TC=0+-100	24546	C4-1/8-T0-3831-F
A4R141	0757-0280	3		RESISTOR 1K 1% .125W F TC=0+-100	24546	C4-1/8-T0-1001-F

†Refer to Section 7 for update information.

*Factory Selected Component (Refer to Section 5).

△ Errata part change.

Table 6-3. Replaceable Parts

Reference Designation	HP Part Number	C D	Qty.	Description	Mfr. Code	Mfr. Part Number
A4 08903-60128 – SERIAL PREFIX 2450A TO 2720A (HP8903B)						
A4R142	2100-3350	5		RESISTOR-TRMR 200 10% C SIDE-ADJ 1-TRN	28480	2100-3350
A4R145	0698-7270	9		RESISTOR 26 1K 1% .05W F TC=0+-100	24546	C3-1/8-TO-2612-F
A4R146	0698-6630	3		RESISTOR 20K .1% .125W F TC=0+-25	28480	0698-6630
A4R147	0698-7256	1		RESISTOR 6.81K 1% .05W F TC=0+-100	24546	C3-1/8-TO-6811-F
A4R148	0698-6630	3		RESISTOR 20K .1% .125W F TC=0+-25	28480	0698-6630
A4R149	2100-3054	6		RESISTOR-TRMR 50K 10% C SIDE-ADJ 17-TRN	02111	43P503
A4R150	0698-3459	8		RESISTOR 383K 1% .125W F TC=0+-100	28480	0698-3459
A4R151	0757-0438	3		RESISTOR 5.11K 1% .125W F TC=0+-100	24546	C4-1/8-TO-5111-F
A4R152	0757-0280	3		RESISTOR 1K 1% .125W F TC=0+-100	24546	C4-1/8-TO-1001-F
A4R153	0698-7253	8		RESISTOR 5.11K 1% .05W F TC=0+-100	24546	C3-1/8-TO-5111-F
A4R154	0698-7196	8		RESISTOR 21.5 1% .05W F TC=0+-100	24546	C3-1/8-TO-21R5-F
A4R155	0698-7196	8		RESISTOR 21.5 1% .05W F TC=0+-100	24546	C3-1/8-TO-21R5-F
A4R156	0698-7236	7		RESISTOR 1K 1% .05W F TC=0+-100	24546	C3-1/8-TO-1001-F
A4R157				NOT ASSIGNED		
A4R157	0698-6360	6		RESISTOR 10K .1% .125W F TC=0+-25	28480	0698-6360
A4R158	0698-6630	3		RESISTOR 20K .1% .125W F TC=0+-25	28480	0698-6630
A4R159-R199				NOT ASSIGNED		
A4R200	0698-6631	4		RESISTOR 2.5K .1% .125W F TC=0+-25	28480	0698-6631
A4R201	0698-6631	4		RESISTOR 2.5K .1% .125W F TC=0+-25	28480	0698-6631
A4RT1	0837-0239	2	1	THERMISTOR TUB WITH AXL LEADS 1K-OHM	28480	0837-0239
A4TP1	1251-0600	0		CONNECTOR-SGL CONT PIN 1.14-MM-BSC-SZ SQ	28480	1251-0600
A4TP2	1251-0600	0		CONNECTOR-SGL CONT PIN 1.14-MM-BSC-SZ SQ	28480	1251-0600
A4TP3	1251-0600	0		CONNECTOR-SGL CONT PIN 1.14-MM-BSC-SZ SQ	28480	1251-0600
A4TP4	1251-0600	0		CONNECTOR-SGL CONT PIN 1.14-MM-BSC-SZ SQ	28480	1251-0600
A4TP5	1251-0600	0		CONNECTOR-SGL CONT PIN 1.14-MM-BSC-SZ SQ	28480	1251-0600
A4TP6	1251-0600	0		CONNECTOR-SGL CONT PIN 1.14-MM-BSC-SZ SQ	28480	1251-0600
A4TP7	1251-0600	0		CONNECTOR-SGL CONT PIN 1.14-MM-BSC-SZ SQ	28480	1251-0600
A4TP8	1251-0600	0		CONNECTOR-SGL CONT PIN 1.14-MM-BSC-SZ SQ	28480	1251-0600
A4TP9	1251-0600	0		CONNECTOR-SGL CONT PIN 1.14-MM-BSC-SZ SQ	28480	1251-0600
A4TP10	1251-0600	0		CONNECTOR-SGL CONT PIN 1.14-MM-BSC-SZ SQ	28480	1251-0600
A4TP11	1251-0600	0		CONNECTOR-SGL CONT PIN 1.14-MM-BSC-SZ SQ	28480	1251-0600
A4U1	1826-0574	6	3	IC OP AMP LOW-DRIFT TO-99 PKG	07263	UA714LHC
A4U2	1826-0574	6		IC OP AMP LOW-DRIFT TO-99 PKG	07263	UA714LHC
A4U3	1826-1491	8	3	IC OP AMP GP DIP PKG	01295	LM201AL
A4U4	1826-1097	0	4	IC OP AMP WB 8-DIP-C PKG	06665	OP-17FZ
A4U5	1826-1491	8	3	IC OP AMP GP DIP PKG	01295	LM201AL
A4U6	1826-0109	3		IC OP AMP WB TO-99 PKG	34371	HA2-2625-B0593
A4U7	1826-0606	5	1	IC SWITCH ANLG QUAD 16-DIP-C PKG	17856	DG201BK
A4U8	1826-0109	3		IC OP AMP WB TO-99 PKG	34371	HA2-2625-B0593
A4U9	1826-0606	5	1	IC SWITCH ANLG QUAD 16-DIP-C PKG	17856	DG201BK
A4U10	1826-0753	3		IC OP AMP LOW-BIAS-H-IMPD QUAD 14-DIP-P	04713	MC34004BL
A4U11	1820-1197	9	4	IC GATE TTL LS NAND QUAD 2-INP	01295	SN74LS00N
A4U12	1826-0574	6		IC OP AMP LOW-DRIFT TO-99 PKG	07263	UA714LHC
A4U13	1826-0109	3		IC OP AMP WB TO-99 PKG	34371	HA2-2625-B0593
A4U14	1826-0785	1		IC OP AMP LOW-BIAS-H-IMPD DUAL 8-DIP-C	02195	TL072ACJG
A4U15	1826-1491	8	3	IC OP AMP GP DIP PKG	01295	LM201AL

†Refer to Section 7 for update information.

*Factory Selected Component (Refer to Section 5).

△ Errata part change.

Table 6-3. Replaceable Parts

Reference Designation	HP Part Number	C D	Qty.	Description	Mfr. Code	Mfr. Part Number
A4 08903-60128 – SERIAL PREFIX 2450A TO 2720A (HP8903B)						
A4U16	1826-1097	0	4	IC OP AMP WB 8-DIP-C PKG	06665	OP-17FZ
A4U17	1826-0753	3		IC OP AMP LOW-BIAS-H-IMPQ QUAD 14-DIP-P	04713	MC34004BL
A4U18	1826-0609	8		IC MULTIPLXR ANLG 16-DIP-C PKG	06665	MUX08FC
A4U19	1826-0138	8	10	IC COMPARTOR GP QUAD 14-DIP-P PKG	01295	LM339N
A4U20	1826-1097	0	4	IC OP AMP WB 8-DIP-C PKG	06665	OP-17FZ
A4U21	1826-0582	6	2	IC SWITCH ANLG QUAD 16-DIP-C PKG	27014	LF13201D
A4U22	1826-1097	0	4	IC OP AMP WB 8-DIP-C PKG	06665	OP-17FZ
A4U23	1826-0740	8	1	IC SWITCH ANLG DUAL 16-DIP-C PKG	32293	IH5043CDE
A4U24	1826-0740	8	1	IC SWITCH ANLG DUAL 16-DIP-C PKG	32293	IH5043CDE
A4VR1	1902-0943	5	3	DIODE-ZNR 2.4V 5% DO-35 PD=.4W TC=-.037%	28480	1902-0943
A4VR2	1902-0064	1	1	DIODE-ZNR 7.5V 5% DO-35 PD=.4W TC=+.05%	28480	1902-0064
A4VR3	1902-3024	9	1	DIODE-ZNR 2.87V 5% DO-7 PD=.4W TC=-.07%	28480	1902-3024
A4VR4	1902-0680	7	2	DIODE-ZNR 1N827 6.2V 5% DO-7 PD=.4W	24046	1N827
A4VR5	1902-0953	7	1	DIODE-ZNR 6.2V 5% DO-35 PD=.4W TC=+.053%	28480	1902-0953

†Refer to Section 7 for update information.

*Factory Selected Component (Refer to Section 5).

△ Errata part change.

Table 6-3. Replaceable Parts

Reference Designation	HP Part Number	C D	Qty.	Description	Mfr. Code	Mfr. Part Number
A4	08903-60183 – SERIAL PREFIX 2730A TO 2813A (HP8903B)					
A4	08903-60183	0	1	OUTPUT AMPLIFIER/VOLTMETER ASSEMBLY	28480	08903-60183
A4	08903-60283 – SERIAL PREFIX 2816A AND ABOVE (HP8903B)					
A4	08903-60283	1	1	OUTPUT AMPLIFIER/VOLTMETER ASSEMBLY	28480	08903-60283
A4	08903-60282	0	1	OUTPUT AMPLIFIER/VOLTMETER ASSEMBLY (THIS IS AN EQUIVALENT TO THE 08903-60283 EXCEPT FOR THE POSITION OF W1. REFER TO THE PARTIAL SCHEMATIC. THE 08903-60282 IS A DIRECT REPLACEMENT FOR THE 08903-60128)	28480	08903-60282
A4C1	0180-2207	5		CAPACITOR-FXD 100UF +-10% 10VDC TA	56289	150D107X9010R2
A4C2	0180-0100	3		CAPACITOR-FXD 4.7UF +-10% 35VDC TA	56289	150D475X9035B2
A4C3	0180-0374	3		CAPACITOR-FXD 10UF +-10% 20VDC TA	56289	150D106X9020B2
A4C4	0180-0100	3		CAPACITOR-FXD 4.7UF +-10% 35VDC TA	56289	150D475X9035B2
A4C5	0180-0291	3	15	CAPACITOR-FXD 1UF +-10% 35VDC TA	56289	150D105X9035A2
A4C6	0180-0291	3		CAPACITOR-FXD 1UF +-10% 35VDC TA	56289	150D105X9035A2
A4C7	0180-0291	3		CAPACITOR-FXD 1UF +-10% 35VDC TA	56289	150D105X9035A2
A4C8	0180-0291	3		CAPACITOR-FXD 1UF +-10% 35VDC TA	56289	150D105X9035A2
A4C9	0160-4805	1	6	CAPACITOR-FXD 47PF +-5% 100VDC CER 0+-30	28480	0160-4805
A4C10	0160-2236	8		CAPACITOR-FXD 1PF +-.25PF 500VDC CER	28480	0160-2236
A4C11	0180-0374	3		CAPACITOR-FXD 10UF +-10% 20VDC TA	56289	150D106X9020B2
A4C12	0160-4843	7	2	CAPACITOR-FXD 47UF +80-20% 50VDC CER	28480	0160-4843
A4C13	0160-5876	8	1	CAPACITOR-FXD 1300PF +-1% 50VDC CER	28480	0160-5876
A4C14	0160-5409	3	1	CAPACITOR-FXD 3000PF +-5% 50VDC CER	28480	0160-5409
A4C15	0160-0336	5	2	CAPACITOR-FXD 100PF +-1% 300VDC MICA	28480	0160-0336
A4C16	0160-4679	7	1	CAPACITOR-FXD 270PF +-1% 300VDC MICA	28480	0160-4679
A4C17	0160-4456	8	2	CAPACITOR-FXD 750PF +-1% 300VDC MICA	28480	0160-4456
A4C18	0160-0336	5		CAPACITOR-FXD 100PF +-1% 300VDC MICA	28480	0160-0336
A4C19	0160-3046	0	1	CAPACITOR-FXD 250PF +-1% 100VDC MICA	28480	0160-3046
A4C20	0160-4456	8		CAPACITOR-FXD 750PF +-1% 300VDC MICA	28480	0160-4456
A4C21	0160-3324	7	4	CAPACITOR-FXD 1UF +-5% 100VDC MET-POLY	28480	0160-3324
A4C22	0160-4793	6	2	CAPACITOR-FXD 6.8PF +-.5PF 100VDC CER	28480	0160-4793
A4C23	0160-3324	7		CAPACITOR-FXD 1UF +-5% 100VDC MET-POLY	28480	0160-3324
A4C24	0160-4799	2	3	CAPACITOR-FXD 2.2PF +-.25PF 100VDC CER	28480	0160-4799
A4C25	0180-2206	4	3	CAPACITOR-FXD 60UF +-10% 6VDC TA	56289	150D606X9006R2
A4C26	0180-0229	7	4	CAPACITOR-FXD 33UF +-10% 10VDC TA	56289	150D336X9010B2
A4C27	0160-3324	7		CAPACITOR-FXD 1UF +-5% 100VDC MET-POLY	28480	0160-3324
A4C28	0160-4805	1		CAPACITOR-FXD 47PF +-5% 100VDC CER 0+-30	28480	0160-4805
A4C29	0160-4805	1		CAPACITOR-FXD 47PF +-5% 100VDC CER 0+-30	28480	0160-4805
A4C30	0160-4835	7		CAPACITOR-FXD 1UF +-10% 50VDC CER	28480	0160-4835
A4C31	0160-4835	7		CAPACITOR-FXD 1UF +-10% 50VDC CER	28480	0160-4835
A4C32	0160-4382	9		CAPACITOR-FXD 3.3PF +-.25PF 200VDC CER	28480	0160-4382
A4C33	0160-4799	2		CAPACITOR-FXD 2.2PF +-.25PF 100VDC CER	28480	0160-4799
A4C34	0180-2206	4		CAPACITOR-FXD 60UF +-10% 6VDC TA	56289	150D606X9006B2
A4C35	0160-4835	7		CAPACITOR-FXD 1UF +-10% 50VDC CER	28480	0160-4835
A4C36	0160-4835	7		CAPACITOR-FXD 1UF +-10% 50VDC CER	28480	0160-4835
A4C37	0160-2236	8		CAPACITOR-FXD 1PF +-.25PF 500VDC CER	28480	0160-2236
A4C38	0180-2207	5		CAPACITOR-FXD 100UF +-10% 10VDC TA	56289	150D107X9010R2
A4C39	0180-4805	1		CAPACITOR-FXD 47PF +-5% 100VDC CER 0+-30	28480	0180-4805
A4C40	0160-4793	6		CAPACITOR-FXD 6.8PF +-.5PF 100VDC CER	28480	0160-4793

†Refer to Section 7 for update information.

*Factory Selected Component (Refer to Section 5).

Δ Errata part change.

Table 6-3. Replaceable Parts

Reference Designation	HP Part Number	C D	Qty.	Description	Mfr. Code	Mfr. Part Number
A4 08903-60283 – SERIAL PREFIX 2816A AND ABOVE (HP8903B)						
A4C41	0160-4814	2		CAPACITOR-FXD 150PF +-5% 100VDC CER	28480	0160-4814
A4C42	0160-4810	8	1	CAPACITOR-FXD 330PF +-5% 100VDC CER	28480	0160-4810
A4C43	0160-4835	7		CAPACITOR-FXD .1UF +-10% 50VDC CER	28480	0160-4835
A4C44	0160-4835	7		CAPACITOR-FXD .1UF +-10% 50VDC CER	28480	0160-4835
A4C45	0180-0291	3		CAPACITOR-FXD 1UF+-10% 35VDC TA	56289	150D105X9035A2
A4C46	0160-4835	7		CAPACITOR-FXD .1UF +-10% 50VDC CER	28480	0160-4835
A4C47	0160-4805	1		CAPACITOR-FXD 47PF +-5% 100VDC CER 0+-30	28480	0160-4805
A4C48	0160-4835	7		CAPACITOR-FXD .1UF +-10% 50VDC CER	28480	0160-4835
A4C49	0160-4835	7		CAPACITOR-FXD .1UF +-10% 50VDC CER	28480	0160-4835
A4C50	0160-4799	2		CAPACITOR-FXD 2.2PF +-25PF 100VDC CER	28480	0160-4799
A4C51	0180-1746	5		CAPACITOR-FXD 15UF+-10% 20VDC TA	56289	150D156X9020B2
A4C52	0160-4814	2		CAPACITOR-FXD 150PF +-5% 100VDC CER	28480	0160-4814
A4C53	0160-3324	7		CAPACITOR-FXD 1UF +-5% 100VDC MET-POLYC	28480	0160-3324
A4C54	0160-4835	7		CAPACITOR-FXD .1UF +-10% 50VDC CER	28480	0160-4835
A4C55	0160-4835	7		CAPACITOR-FXD .1UF +-10% 50VDC CER	28480	0160-4835
A4C56	0160-4653	7	6	CAPACITOR-FXD .1UF +-5% 100VDC MET-POLYP	28480	0160-4653
A4C57	0160-4635	7		CAPACITOR-FXD .1UF +-10% 50VDC CER	28480	0160-4635
A4C58	0160-4814	2		CAPACITOR-FXD 150PF +-5% 100VDC CER	28480	0160-4814
A4C59	0160-4653	7		CAPACITOR-FXD 1UF +-5% 100VDC MET-POLYP	28480	0160-4653
A4C60	0160-4653	7		CAPACITOR-FXD .1UF +-5% 100VDC MET-POLYP	28480	0160-4653
A4C61	0160-4653	7		CAPACITOR-FXD .1UF +-5% 100VDC MET-POLYP	28480	0160-4653
A4C62	0160-4653	7		CAPACITOR-FXD .1UF +-5% 100VDC MET-POLYP	28480	0160-4653
A4C63	0160-4653	7		CAPACITOR-FXD .1UF +-5% 100VDC MET-POLYP	28480	0160-4653
A4C64	0160-4843	7		CAPACITOR-FXD .47UF +-80-20% 50VDC CER	28480	0160-4843
A4C65	0180-0228	6		CAPACITOR-FXD 22UF+ 10% 15VDC TA	56289	150D226X9015B2
A4C66	0180-0228	6		CAPACITOR-FXD 22UF+-10% 15VDC TA	56289	150D226X9015B2
A4C67	0180-0228	6		CAPACITOR-FXD 22UF+-10% 15VDC TA	56289	150D226X9015B2
A4C68	0180-2206	4		CAPACITOR-FXD 60UF+-10% 6VDC TA	56289	150D606X9006B2
A4C69	0160-4807	3		CAPACITOR-FXD 33PF +-5% 100VDC CER 0+-30	28480	0160-4807
A4C70	0160-4397	6	1	CAPACITOR-FXD .1UF +-1% 100VDC POLYSTY	28480	0160-4397
A4C71	0180-0291	3		CAPACITOR-FXD 1UF+-10% 35VDC TA	56289	150D105X9035A2
A4C72	0160-5254	6	1	CAPACITOR-FXD 1.5PF +-25PF 100VDC CER	28480	0160-5254
A4C73	0160-4832	4		CAPACITOR-FXD .01UF +-10% 100VDC CER	28480	0160-4832
A4C74	0160-4832	4		CAPACITOR-FXD .01UF +-10% 100VDC CER	28480	0160-4832
A4C75	0160-4797	0	1	CAPACITOR-FXD 3.3PF +-25PF 100VDC CER	28480	0160-4797
A4C76	0160-4835	7		CAPACITOR-FXD .1UF +-10% 50VDC CER	28480	0160-4835
A4C77	0160-4790	3	1	CAPACITOR-FXD 12PF +-5% 100VDC CER 0+-30	28480	0160-4790
A4C78	0160-4590	1		CAPACITOR-FXD 18UF +-1% 200VDC	28480	0160-4590
A4C79	0160-5622	2		CAPACITOR-FXD 1.25UF +-2% 50VDC	28480	0160-5622
A4CR1	1901-0050	3		DIODE-SWITCHING 80V 200MA 2NS DO-35	28480	1901-0050
A2CR2	1901-0050	3		DIODE-SWITCHING 80V 200MA 2NS DO-35	28480	1901-0050
A4CR3	1901-0040	1	7	DIODE-SWITCHING 30V 50MA 2NS DO-35	28480	1901-0040
A4CR4	1901-0050	3		DIODE-SWITCHING 80V 200MA 2NS DO-35	28480	1901-0050
A4CR5	1901-0050	3		DIODE-SWITCHING 80V 200MA 2NS DO-35	28480	1901-0050
A4CR6	1901-0880	7		DIODE-GEN PRP 125MA DO-35	28480	1901-0880
A4CR7	1901-0050	3		DIODE-SWITCHING 80V 200MA 2NS DO-35	28480	1901-0050
A4CR8	1901-0050	3		DIODE-SWITCHING 80V 200MA 2NS DO-35	28480	1901-0050
A4CR9	1901-0050	3		DIODE-SWITCHING 80V 200MA 2NS DO-35	28480	1901-0050
A4CR10	1901-0518	8		DIODE-SM SIG SCHOTTKY	28480	1901-0518
A4CR11	1901-0518	8		DIODE-SM SIG SCHOTTKY	28480	1901-0518
A4CR12	1901-0040	1		DIODE-SWITCHING 30V 50MA 2NS DO-35	28480	1901-0040
A4CR13	1901-0050	3		DIODE-SWITCHING 80V 200MA 2NS DO-35	28480	1901-0050
A4CR14	1901-0040	1		DIODE SWITCHING 30V 50MA 2NS DO-35	28480	1901-0040
A4CR15	1901-0040	1		DIODE-SWITCHING 30V 50MA 2NS DO-35	28480	1901-0040

†Refer to Section 7 for update information.

*Factory Selected Component (Refer to Section 5).

Δ Errata part change.

Table 6-3. Replaceable Parts

Reference Designation	HP Part Number	C D	Qty.	Description	Mfr. Code	Mfr. Part Number
A4	08903-60283 – SERIAL PREFIX 2816A AND ABOVE (HP8903B)					
A4CR16	1901-0050	3		DIODE-SWITCHING 80V 200MA 2NS DO-35	28480	1901-0050
A4CR17	1901-0880	7		DIODE-GEN PRP 125MA DO-35	28480	1901-0880
A4CR18	1901-0880	7		DIODE-GEN PRP 125MA DO-35	28480	1901-0880
A4CR19	1901-0880	7		DIODE-GEN PRP 125MA DO-35	28480	1901-0880
A4CR20	1901-0880	7		DIODE-GEN PRP 125MA DO-35	28480	1901-0880
A4CR21	1901-0880	7		DIODE-GEN PRP 125MA DO-35	28480	1901-0880
A4CR22	1901-0880	7		DIODE-GEN PRP 125MA DO-35	28480	1901-0880
A4CR23	1901-0880	7		DIODE-GEN PRP 125MA DO-35	28480	1901-0880
A4CR24	1901-0880	7		DIODE-GEN PRP 125MA DO-35	28480	1901-0880
A4CR25	1901-0040	1		DIODE-SWITCHING 30V 50MA 2NS DO-35	28480	1901-0040
A4CR26	1901-0880	7		DIODE-GEN PRP 125MA DO-35	28480	1901-0880
A4CR27	1901-0050	3		DIODE-SWITCHING 80V 200MA 2NS DO-35	28480	1901-0050
A4CR28	1901-0050	3		DIODE-SWITCHING 80V 200MA 2NS DO-35	28480	1901-0050
A4CR29	1901-0880	7		DIODE-GEN PRP 125MA DO-35	28480	1901-0880
A4CR30	1901-0880	7		DIODE-GEN PRP 125MA DO-35	28480	1901-0880
A4CR31	1901-0880	7		DIODE-GEN PRP 125MA DO-35	28480	1901-0880
A4CR32	1901-0880	7		DIODE-GEN PRP 125MA DO-35	28480	1901-0880
A4CR33	1901-0050	3		DIODE-SWITCHING 80V 200MA2NS DO-35	28480	1901-0050
A4CR34	1901-0880	7		DIODE-GEN PRP 125MA DO-35	28480	1901-0880
A4K1	0490-1423	2	1	RELAY-REED 1C 250MA 28VDC 5VDC-COIL 3VA	28480	0490-1423
A4L1	9140-0210	1	10	INDUCTOR RF-CH-MLD 100UH 5% .166DX.385LG	28480	9140-0210
A4L2	9140-0210	1		INDUCTOR RF-CH-MLD 100UH 5% .166DX.385LG	28480	9140-0210
A4L3	9100-0539	3	3	INDUCTOR (MISC ITEM)	28480	9100-0539
A4L4	9100-0539	3		INDUCTOR (MISC ITEM)	28480	9100-0539
A4L5	9100-0539	3		INDUCTOR (MISC ITEM)	28480	9100-0539
A4MP1	4040-0748	3		EXTR-PC BD BLK POLYC .062-BD-THKNS	28480	4040-0748
	1480-0116	8		PIN-GRV .062-IN-DIA .25-IN-LG STL	28480	1480-0116
A4MP2	4040-0752	9	1	EXTR-PC BD YEL POLYC .062-BD-THKNS	28480	4040-0752
	1480-0116	8		PIN-GRV .062-IN-DIA .25-IN-LG STL	28480	1480-0116
A4MP3	0403-0026	6		PLUG-HOLE BDR-HD FOR .187-D-HOLE NYL	02768	207-120241-03-0101
A4Q1 ^Δ	08903-80069	3	2	TRANSISTOR-DUAL NPN TO-71 PD = 500MW	28480	08903-80069
	1205-0202	1	2	THERMAL LINK DUAL TO-18-CS	28480	1205-0202
A4Q2	1854-0753	2		TRANSISTOR-DUAL NPN TO-71 PD = 500MW	28480	1854-0753
	1205-0202	1		THERMAL LINK DUAL TO-18-CS	28480	1205-0202
A4Q3	1855-0420	2	36	TRANSISTOR J-FET 2N4391 N-CHAN D-MODE	01295	2N4391
A4Q4	1854-0830	6	1	TRANSISTOR-DUAL NPN PD = 500MW	27014	LM394
A4Q5	1855-0420	2		TRANSISTOR J-FET 2N4391 N-CHAN D-MODE	01295	2N4391
A4Q6	1855-0420	2		TRANSISTOR J-FET 2N4391 N-CHAN D-MODE	01295	2N4391
A4Q7	1855-0420	2		TRANSISTOR J-FET 2N4391 N-CHAN D-MODE	01295	2N4391
A4Q8	1855-0420	2		TRANSISTOR J-FET 2N4391 N-CHAN D-MODE	01295	2N4391
A4Q9	1855-0420	2		TRANSISTOR J-FET 2N4391 N-CHAN D-MODE	01295	2N4391
A4Q10	1854-0071	7	1	TRANSISTOR NPN SI PD = 300MW FT = 200MHZ	28480	1854-0071
A4Q11	1853-0281	9	4	TRANSISTOR PNP 2N2907A SI TO-18 PD = 400MW	04713	2N2907A
A4Q12	1853-0281	9		TRANSISTOR PNP 2N2907A SI TO-18 PD = 400MW	04713	2N2907A
A4R1	0757-0279	0		RESISTOR 3.16K 1% .125W F TC = 0+ -100	24546	C4-1/8-T0-3161-F
A4R2	0757-0441	8		RESISTOR 8.25K 1% .125W F TC = 0+ -100	24546	C4-1/8-T0-8251-F
A4R3	0698-6343	5	7	RESISTOR 9K .1% .125W F TC = 0+ -25	28480	0698-6343
A4R4	0698-6362	8	7	RESISTOR 1K .1% .125W F TC = 0+ -25	28480	0698-6362
A4R5	0757-0441	8		RESISTOR 8.25K 1% .125W F TC = 0+ -100	24546	C4-1/8-T0-8251-F
A4R6	0757-0422	5	4	RESISTOR 909 1% .125W F TC = 0+ -100	24546	C4-1/8-T0-909R-F

†Refer to Section 7 for update information.

*Factory Selected Component (Refer to Section 5).

Δ Errata part change.

Table 6-3. Replaceable Parts

Reference Designation	HP Part Number	C D	Qty.	Description	Mfr. Code	Mfr. Part Number
A4 08903-60283 – SERIAL PREFIX 2816A AND ABOVE (HP8903B)						
A4R7	0698-8822	9	10	RESISTOR 6.81 1% .125W F TC=0+-100	28480	0698-8822
A4R8	0698-8822	9		RESISTOR 6.81 1% .125W F TC=0+-100	28480	0698-8822
A4R9	0698-8822	9		RESISTOR 6.81 1% .125W F TC=0+-100	28480	0698-8822
A4R10	0698-8822	9		RESISTOR 6.81 1% .125W F TC=0+-100	28480	0698-8822
A4R11	0698-0084	9		RESISTOR 2.15K 1% .125W F TC=0+-100	24546	C4-1/8-T0-2151-F
A4R12	0698-6360	8		RESISTOR 10K .1% .125W F TC=0+-25	28480	0698-6360
A4R13	0698-6631	4	7	RESISTOR 2.5K .1% .125W F TC=0+-25	28480	0698-6631
A4R14	0757-0280	3		RESISTOR 1K 1% .125W F TC=0+-100	24546	C4-1/8-T0-1001-F
A4R15	0757-0274	5	3	RESISTOR 1.21K 1% .125W F TC=0+-100	24546	C4-1/8-T0-1211-F
A4R16	0757-0274	5		RESISTOR 1.21K 1% .125W F TC=0+-100	24546	C4-1/8-T0-1211-F
A4R17	0757-0443	0	1	RESISTOR 11K 1% .125W F TC=0+-100	24546	C4-1/8-T0-1102-F
A4R18	0757-0280	3		RESISTOR 1K 1% .125W F TC=0+-100	24546	C4-1/8-T0-1001-F
A4R19	0757-0438	3		RESISTOR 5.11K 1% .125W F TC=0+-100	24546	C4-1/8-T0-5111-F
A4R20	0757-0437	2	1	RESISTOR 4.75K 1% .125W F TC=0+-100	24546	C4-1/8-T0-4751-F
A4R21				NOT ASSIGNED		
A4R22	0757-1094	9		RESISTOR 1.47K 1% .125W F TC=0+-100	24546	C4-1/8-T0-1471-F
A4R23	0698-3484	9		RESISTOR 6.65K 1% .125W F TC=0+-100	24546	C4-1/8-T0-6651-F
A4R24	0698-4470	5	1	RESISTOR 6.98K 1% .125W F TC=0+-100	24546	C4-1/8-T0-6981-F
A4R25	0698-3151	7	6	RESISTOR 2.87K 1% .125W F TC=0+-100	24546	C4-1/8-T0-2871-F
A4R26	0757-0447	4		RESISTOR 16.2K 1% .125W F TC=0+-100	24546	C4-1/8-T0-1622-F
A4R27	0698-3151	7		RESISTOR 2.87K 1% .125W F TC=0+-100	24546	C4-1/8-T0-2871-F
A4R28	0757-0439	4		RESISTOR 6.81K 1% .125W F TC=0+-100	24546	C4-1/8-T0-6811-F
A4R29	0698-6631	4		RESISTOR 2.5K .1% .125W F TC=0+-25	28480	0698-6631
A4R30	0698-6631	4		RESISTOR 2.5K .1% .125W F TC=0+-25	28480	0698-6631
A4R31	0757-0199	3	1	RESISTOR 21.5K 1% .125W F TC=0+-100	24546	C4-1/8-T0-2152-F
A4R32	0757-0280	3		RESISTOR 1K 1% .125W F TC=0+-100	24546	C4-1/8-T0-1001-F
A4R33	0757-0422	5		RESISTOR 909 1% .125W F TC=0+-100	24546	C4-1/8-T0-909R-F
A4R34	0698-6343	5		RESISTOR 9K .1% .125W F TC=0+-25	28480	0698-6343
A4R35	0698-6362	8		RESISTOR 1K 1% .125W F TC=0+-25	28480	0698-6362
A4R36	0757-0447	4		RESISTOR 16.2K 1% .125W F TC=0+-100	24546	C4-1/8-T0-1622-F
A4R37	0757-0447	4		RESISTOR 16.2K 1% .125W F TC=0+-100	24546	C4-1/8-T0-1622-F
A4R38	0698-3151	7		RESISTOR 2.87K 1% .125W F TC=0+-100	24546	C4-1/8-T0-2871-F
A4R39	0757-0447	4		RESISTOR 16.2K 1% .125W F TC=0+-100	24546	C4-1/8-T0-1622-F
A4R40	0698-3151	7		RESISTOR 2.87K 1% .125W F TC=0+-100	24546	C4-1/8-T0-2871-F
A4R41	0757-0470	3	4	RESISTOR 162K 1% .125W F TC=0+-100	24546	C4-1/8-T0-1623-F
A4R42	0698-3151	7		RESISTOR 2.87K 1% .125W F TC=0+-100	24546	C4-1/8-T0-2871-F
A4R43	0757-0447	4		RESISTOR 16.2K 1% .125W F TC=0+-100	24546	C4-1/8-T0-1622-F
A4R44	0698-3151	7		RESISTOR 2.87K 1% .125W F TC=0+-100	24546	C4-1/8-T0-2871-F
A4R45	0698-6343	5		RESISTOR 9K .1% .125W F TC=0+-25	28480	0698-6343
A4R46	0698-6362	8		RESISTOR 1K .1% .125W F TC=0+-25	28480	0698-6362
A4R47	0757-0422	5		RESISTOR 909 1% .125W F TC=0+-100	24546	C4-1/8-T0-909R-F
A4R48	0698-6343	5		RESISTOR 9K .1% .125W F TC=0+-25	28480	0698-6343
A4R49	0698-6343	5		RESISTOR 9K .1% .125W F TC=0+-25	28480	0698-6343
A4R50	0698-6362	8		RESISTOR 1K .1% .125W F TC=0+-25	28480	0698-6362
A4R51	0698-6362	8		RESISTOR 1K 1% .125W F TC=0+-25	28480	0698-6362
A4R52	0757-0280	3		RESISTOR 1K 1% .125W F TC=0+-100	24546	C4-1/8-T0-1001-F
A4R53	0698-0550	6	1	RESISTOR 620 5% .25W CC TC=0+-800	28480	0698-0550
A4R54	0698-0085	0	2	RESISTOR 2.61K 1% .125W F TC=0+-100	24546	C4-1/8-T0-2611-F
A4R55	0698-6360	6		RESISTOR 10K .1% .125W F TC=0+-25	28480	0698-6360
A4R56	0698-3160	8		RESISTOR 31.6K 1% .125W F TC=0+-100	24546	C4-1/8-T0-3162-F

†Refer to Section 7 for update information.

*Factory Selected Component (Refer to Section 5).

△ Errata part change.

Table 6-3. Replaceable Parts

Reference Designation	HP Part Number	C D	Qty.	Description	Mfr. Code	Mfr. Part Number
A4 08903-60283 – SERIAL PREFIX 2816A AND ABOVE (HP8903B)						
A4R57	0698-3160		8	RESISTOR 31.6K 1% .125W F TC=0+-100	24546	C4-1/8-T0-3162-F
A4R58	0757-0280		3	RESISTOR 1K 1% .125W F TC=0+-100	24546	C4-1/8-T0-1001-F
A4R59	0757-0438		3	RESISTOR 5.11K 1% .125W F TC=0+-100	24546	C4-1/8-T0-5111-F
A4R60	0757-0442		9	RESISTOR 10K 1% .125W F TC=0+-100	24546	C4-1/8-T0-1002-F
A4R61	0698-3152		8	RESISTOR 3.48K 1% .125W F TC=0+-100	24546	C4-1/8-T0-3481-F
A4R62	0698-6360		6	RESISTOR 10K .1% .125W F TC=0+-25	28480	0698-6360
A4R63	0698-8822		9	RESISTOR 6.81 1% .125W F TC=0+-100	28480	0698-8822
A4R64	0757-0465		6	RESISTOR 100K 1% .125W F TC=0+-100	24546	C4-1/8-T0-1003-F
A4R65	0757-0438		3	RESISTOR 5.11K 1% .125W F TC=0+-100	24546	C4-1/8-T0-5111-F
A4R66	0698-3150		6	RESISTOR 2.37K 1% .125W F TC=0+-100	24546	C4-1/8-T0-2371-F
A4R67	0698-3153		9	RESISTOR 3.83K 1% .125W F TC=0+-100	24546	C4-1/8-T0-3831-F
A4R68	0757-1108		6	RESISTOR 300 1% .125W F TC=0+-100	24546	C4-1/8-T0-301-F
A4R69	0757-0279		0	RESISTOR 3.16K 1% .125W F TC=0+-100	24546	C4-1/8-T0-3161-F
A4R70	0698-6630		3	RESISTOR 20K .1% .125W F TC=0+-25	28480	0698-6630
A4R71	0698-6360		6	RESISTOR 10K .1% .125W F TC=0+-25	28480	0698-6360
A4R72	0757-1094		9	RESISTOR 1.47K 1% .125W F TC=0+-100	24546	C4-1/8-T0-1471-F
A4R73	0698-3136		8	RESISTOR 17.8K 1% .125W F TC=0+-100	24546	C4-1/8-T0-1782-F
A4R74	0757-1094		9	RESISTOR 1.47K 1% .125W F TC=0+-100	24546	C4-1/8-T0-1471-F
A4R76	0698-8822		9	RESISTOR 6.81 1% .125W F TC=0+-100	28480	0698-8822
A4R77	0698-8822		9	RESISTOR 6.81 1% .125W F TC=0+-100	28480	0698-8822
A4R78	0698-0084		9	RESISTOR 2.15K 1% .125W F TC=0+-100	24546	C4-1/8-T0-2151-F
A4R79	0757-0440		7	RESISTOR 7.5K 1% .125W F TC=0+-100	24546	C4-1/8-T0-7501-F
A4R80	0757-0442		9	RESISTOR 10K 1% .125W F TC=0+-100	24546	C4-1/8-T0-1002-F
A4R81	0757-0442		9	RESISTOR 10K 1% .125W F TC=0+-100	24546	C4-1/8-T0-1002-F
A4R82	0757-0438		3	RESISTOR 5.11K 1% .125W F TC=0+-100	24546	C4-1/8-T0-5111-F
A4R83	0698-3157		3	RESISTOR 19.6K 1% .125W F TC=0+-100	24546	C4-1/8-T0-1962-F
A4R84	0757-0280		3	RESISTOR 1K 1% .125W F TC=0+-100	24546	C4-1/8-T0-1001-F
A4R85	2100-3054		6	RESISTOR-TRMR 50K 10% C SIDE-ADJ 17-TRN	02111	43P503
A4R86	0698-3223		4	RESISTOR 1.24K 1% .125W F TC=0+-100	24546	C4-1/8-T0-1241-F
A4R87	0698-3459		8	RESISTOR 383K 1% .125W F TC=0+-100	28480	0698-3459
A4R88	0757-0280		3	RESISTOR 1K 1% .125W F TC=0+-100	24546	C4-1/8-T0-1001-F
A4R89	0757-0438		3	RESISTOR 5.11K 1% .125W F TC=0+-100	24546	C4-1/8-T0-5111-F
A4R90	0698-0526		6	RESISTOR 37.68K 1% .25W F TC=0+-25	28480	0698-0526
A4R91	2100-3056		8	RESISTOR-TRMR 5K 10% C SIDE-ADJ 17-TRN	02111	43P502
A4R92	0698-8799		9	RESISTOR 21.5K 1% .125W F TC=0+-25	28480	0698-8799
A4R93	2100-3109		2	RESISTOR-TRMR 2K 10% C SIDE-ADJ 17-TRN	02111	43P202
A4R94	0698-3266		5	RESISTOR 237K 1% .125W F TC=0+-100	24546	C4-1/8-T0-2373-F
A4R95	0698-6630		3	RESISTOR 20K .1% .125W F TC=0+-25	28480	0698-6630
A4R96	0698-3266		5	RESISTOR 237K 1% .125W F TC=0+-100	24546	C4-1/8-T0-2373-F
A4R97	0757-0438		3	RESISTOR 5.11K 1% .125W F TC=0+-100	24546	C4-1/8-T0-5111-F
A4R98	0698-6630		3	RESISTOR 20K 1% .125W F TC=0+-25	28480	0698-6630
A4R99	0757-0280		3	RESISTOR 1K 1% .125W F TC=0+-100	24546	C4-1/8-T0-1001-F
A4R100	0757-0442		9	RESISTOR 10K 1% .125W F TC=0+-100	24546	C4-1/8-T0-1002-F
A4R101	0698-3243		8	RESISTOR 178K 1% .125W F TC=0+-100	24546	C4-1/8-T0-1783-F
A4R102				NOT ASSIGNED		
A4R103				NOT ASSIGNED		
A4R104	0757-0470		3	RESISTOR 162K 1% .125W F TC=0+-100	24546	C4-1/8-T0-1623-F
A4R105	0757-0200		7	RESISTOR 5.62K 1% .125W F TC=0+-100	24546	C4-1/8-T0-5621-F
A4R106				NOT ASSIGNED		
A4R107	0757-0464		5	RESISTOR 90.9K 1% .125W F TC=0+-100	24546	C4-1/8-T0-9092-F

†Refer to Section 7 for update information.

*Factory Selected Component (Refer to Section 5).

Δ Errata part change.

Table 6-3. Replaceable Parts

Reference Designation	HP Part Number	C D	Qty.	Description	Mfr. Code	Mfr. Part Number
A4 08903-60283 – SERIAL PREFIX 2816A AND ABOVE (HP8903B)						
A4R108	0698-3456	5	1	RESISTOR 287K 1% .125W F TC=0+-100	24546	C4-1/8-T0-2873-F
A4R109	0698-3453	2		RESISTOR 196K 1% .125W F TC=0+-100	24546	C4-1/8-T0-1963-F
A4R110	0698-6631	4		RESISTOR 2.5K .1% .125W F TC=0+-25	28480	0698-6631
A4R111	0698-6631	4		RESISTOR 2.5K .1% .125W F TC=0+-25	28480	0698-6631
A4R112	0757-0279	0		RESISTOR 3.16K 1% .125W F TC=0+-100	24546	C4-1/8-T0-3161-F
A4R113	0757-0470	3		RESISTOR 162K 1% .125W F TC=0+-100	24546	C4-1/8-T0-1623-F
A4R114	0757-0279	0		RESISTOR 3.16K 1% .125W F TC=0+-100	24546	C4-1/8-T0-3161-F
A4R115	0757-0279	0		RESISTOR 3.16K 1% .125W F TC=0+-100	24546	C4-1/8-T0-3161-F
A4R116	0757-0442	9		RESISTOR 10K 1% .125W F TC=0+-100	24546	C4-1/8-T0-1002-F
A4R117	0757-0279	0		RESISTOR 3.16K 1% .125W F TC=0+-100	24546	C4-1/8-T0-3161-F
A4R118	0757-0290	5		RESISTOR 6.19K 1% .125W F TC=0+-100	19701	MF4C1/8-T0-6191-F
A4R119	0757-0421	4	1	RESISTOR 825 1% .125W F TC=0+-100	24546	C4-1/8-T0-825R-F
A4R120	0698-3443	0	1	RESISTOR 287 1% .125W F TC=0+-100	24546	C4-1/8-T0-287R-F
A4R121	0757-0290	5		RESISTOR 6.19K 1% .125W F TC=0+-100	19701	MF4C1/8-T0-6191-F
A4R122	0757-0422	5		RESISTOR 909 1% .125W F TC=0+-100	24546	C4-1/8-T0-909R-F
A4R123	0698-3441	8	1	RESISTOR 215 1% .125W F TC=0+-100	24546	C4-1/8-T0-215R-F
A4R124	0698-0082	7	1	RESISTOR 464 1% .125W F TC=0+-100	24546	C4-1/8-T0-4640-F
A4R125	2100-3103	6	2	RESISTOR-TRMR 10K 10% C SIDE-ADJ 17-TRN	02111	43P103
A4R126	0757-0442	9		RESISTOR 10K 1% .125W F TC=0+-100	24546	C4-1/8-T0-1002-F
A4R127	0699-0239	8	1	RESISTOR 59K .1% .1W F TC=0+-15	28480	0699-0239
A4R128	0698-3150	6		RESISTOR 2.37K 1% .125W F TC=0+-100	24546	C4-1/8-T0-2371-F
A4R129	0698-0085	0		RESISTOR 2.61K 1% .125W F TC=0+-100	24546	C4-1/8-T0-2611-F
A4R130	0698-3153	9		RESISTOR 3.83K 1% .125W F TC=0+-100	24546	C4-1/8-T0-3831-F
A4R131	0757-0280	3		RESISTOR 1K 1% .125W F TC=0+-100	24546	C4-1/8-T0-1001-F
A4R132	0757-0405	4	2	RESISTOR 162 1% .125W F TC=0+-100	24546	C4-1/8-T0-162R-F
A4R133	0757-0200	7		RESISTOR 5.62K 1% .125W F TC=0+-100	24546	C4-1/8-T0-5621-F
A4R134	0698-8822	9		RESISTOR 6.81 1% .125W F TC=0+-100	28480	0698-8822
A4R135	0757-0405	4		RESISTOR 162 1% .125W F TC=0+-100	24546	C4-1/8-T0-162R-F
A4R136	0757-0465	6		RESISTOR 100K 1% .125W F TC=0+-100	24546	C4-1/8-T0-1003-F
A4R137	0757-0279	0		RESISTOR 3.16K 1% .125W F TC=0+-100	24546	C4-1/8-T0-3161-F
A4R138	0757-0279	0		RESISTOR 3.16K 1% .125W F TC=0+-100	24546	C4-1/8-T0-3161-F
A4R139	0757-1094	9		RESISTOR 1.47K 1% .125W F TC=0+-100	24546	C4-1/8-T0-1471-F
A4R140	0698-3153	9		RESISTOR 3.83K 1% .125W F TC=0+-100	24546	C4-1/8-T0-3831-F
A4R141	0757-0280	3		RESISTOR 1K 1% .125W F TC=0+-100	24546	C4-1/8-T0-1001-F
A4R142	2100-3350	5		RESISTOR-TRMR 200 10% C SIDE-ADJ 1-TRN	28480	2100-3350
A4R145	0698-7270	9		RESISTOR 26.1K 1% .05W F TC=0+-100	24546	C3-1/8-T0-2612-F
A4R146	0698-6630	3		RESISTOR 20K .1% .125W F TC=0+-25	28480	0698-6630
A4R147	0698-7256	1		RESISTOR 6.81K 1% .05W F TC=0+-100	24546	C3-1/8-T0-6811-F
A4R148	0698-6630	3		RESISTOR 20K .1% .125W F TC=0+-25	28480	0698-6630
A4R149	2100-3054	6		RESISTOR-TRMR 50K 10% C SIDE-ADJ 17-TRN	02111	43P503
A4R150	0698-3459	8		RESISTOR 383K 1% .125W F TC=0+-100	28480	0698-3459
A4R151	0757-0438	3		RESISTOR 5.11K 1% .125W F TC=0+-100	24546	C4-1/8-T0-5111-F
A4R152	0757-0280	3		RESISTOR 1K 1% .125W F TC=0+-100	24546	C4-1/8-T0-1001-F
A4R153	0698-7253	8		RESISTOR 5.11K 1% .05W F TC=0+-100	24546	C3-1/8-T0-5111-F
A4R154	0698-7196	8		RESISTOR 21.5 1% .05W F TC=0+-100	24546	C3-1/8-T0-21R5-F
A4R155	0698-7196	8		RESISTOR 21.5 1% .05W F TC=0+-100	24546	C3-1/8-T0-21R5-F
A4R156	0698-7236	7		RESISTOR 1K 1% .05W F TC=0+-100	24546	C3-1/8-T0-1001-F
A4R157				NOT ASSIGNED		
A4R157	0698-6360	6		RESISTOR 10K .1% .125W F TC=0+-25	28480	0698-6360
A4R158	0698-6630	3		RESISTOR 20K .1% .125W F TC=0+-25	28480	0698-6630

† Refer to Section 7 for update information.

* Factory Selected Component (Refer to Section 5).

Δ Errata part change.

Table 6-3. Replaceable Parts

Reference Designation	HP Part Number	C D	Qty.	Description	Mfr. Code	Mfr. Part Number
A4 08903-60283 – SERIAL PREFIX 2816A AND ABOVE (HP8903B)						
A4R159-R199				NOT ASSIGNED		
A4R200	0698-6631	4		RESISTOR 2.5K .1% .125W F TC=0+-25	28480	0698-6631
A4R201	0698-6631	4		RESISTOR 2.5K .1% .125W F TC=0+-25	28480	0698-6631
A4R202	0698-6343	5		RESISTOR 9K .1% .125W F TC=0+-25	28480	0698-6343
A4R203	0698-8607	8		RESISTOR 4.5K .1% .125W F TC=0+-25	28480	0698-8607
A4R204	0698-7248	1		RESISTOR 3.16K 1% .05W F TC=0+-100	28480	0698-7248
A4R205	0699-0069	2		RESISTOR 2.15M 1% .125W F TC=0+-100	28480	0699-0069
A4R206	0698-6360	6		RESISTOR 10K .1% .125W F TC=0+-25	28480	0698-6360
A4R207	2100-3274	2		RESISTOR-TRMR 10K C SIDE-ADJ 1-TRN	28480	2100-3274
A4R208	0757-0470	3		RESISTOR 162K 1% .125W F TC=0+-100	25456	C4-1/8-TO-1623-F
A4R209	0698-8615	8		RESISTOR 75K 1% .05W F TC=0+-100	28480	0698-8615
A4R210	0698-4543	3		RESISTOR 487K 1% .125W F TC=0+-100	28480	0698-4543
A4R211	0698-3243	8		RESISTOR 178K 1% .125W F TC=0+-100	24546	C4-1/8-TO-1783-F
A4RT1	0837-0239	2	1	THERMISTOR TUB WITH AXL LEADS 1K-OHM	28480	0837-0239
A4TP1	1251-0600	0		CONNECTOR-SGL CONT PIN 1.14-MM-BSC-SZ SQ	28480	1251-0600
A4TP2	1251-0600	0		CONNECTOR-SGL CONT PIN 1.14-MM-BSC-SZ SQ	28480	1251-0600
A4TP3	1251-0600	0		CONNECTOR-SGL CONT PIN 1.14-MM-BSC-SZ SQ	28480	1251-0600
A4TP4	1251-0600	0		CONNECTOR-SGL CONT PIN 1.14-MM-BSC-SZ SQ	28480	1251-0600
A4TP5	1251-0600	0		CONNECTOR-SGL CONT PIN 1.14-MM-BSC-SZ SQ	28480	1251-0600
A4TP6	1251-0500	0		CONNECTOR-SGL CONT PIN 1.14-MM-BSC-SZ SQ	28480	1251-0600
A4TP7	1251-0600	0		CONNECTOR-SGL CONT PIN 1.14-MM-BSC-SZ SQ	28480	1251-0600
A4TP8	1251-0600	0		CONNECTOR-SGL CONT PIN 1.14-MM-BSC-SZ SQ	28480	1251-0600
A4TP9	1251-0600	0		CONNECTOR-SGL CONT PIN 1.14-MM-BSC-SZ SQ	28480	1251-0600
A4TP10	1251-0600	0		CONNECTOR-SGL CONT PIN 1.14-MM-BSC-SZ SQ	28480	1251-0600
A4TP11	1251-0600	0		CONNECTOR-SGL CONT PIN 1.14-MM-BSC-SZ SQ	28480	1251-0600
A4U1	1826-0574	6	3	IC OP AMP LOW-DRIFT TO-99 PKG	07263	UA714LHC
A4U2	1826-0574	6		IC OP AMP LOW-DRIFT TO-99 PKG	07263	UA714LHC
A4U3	1826-1491	8	3	IC OP AMP GP DIP PKG	01295	LM201AL
A4U4	1826-1097	0	4	IC OP AMP WB 8-DIP-C PKG	06665	OP-17FZ
A4U5	1826-1491	8	3	IC OP AMP GP DIP PKG	01295	LM201AL
A4U6	1826-0109	3		IC OP AMP WB TO-99 PKG	34371	HA2-2625-B0593
A4U7	1826-0606	5	1	IC SWITCH ANLG QUAD 16-DIP-C PKG	17856	DG201BK
A4U8	1826-0109	3		IC OP AMP WB TO-99 PKG	34371	HA2-2625-B0593
A4U9	1826-0606	5	1	IC SWITCH ANLG QUAD 16-DIP-C PKG	17856	DG201BK
A4U10	1826-0753	3		IC OP AMP LOW-BIAS-H-IMPD QUAD 14-DIP-P	04713	MC34004BL
A4U11	1820-1197	9	4	IC GATE TTL LS NAND QUAD 2-INP	01295	SN74LS00N
A4U12	1826-0574	6		IC OP AMP LOW-DRIFT TO-99 PKG	07263	UA714LHC
A4U13	1826-0109	3		IC OP AMP WB TO-99 PKG	34371	HA2-2625-B0593
A4U14	1826-0785	1		IC OP AMP LOW-BIAS-H-IMPD DUAL 8-DIP-C	02195	TL072ACJG
A4U15	1826-1491	8	3	IC OP AMP GP DIP PKG	01295	LM201AL
A4U16	1826-1097	0	4	IC OP AMP WB 8-DIP-C PKG	06665	OP-17FZ
A4U17	1826-0753	3		IC OP AMP LOW-BIAS-H-IMPD QUAD 14-DIP-P	04713	MC34004BL
A4U18	1826-0609	8		IC MULTIPLXR ANLG 16-DIP-C PKG	06665	MUX08FO
A4U19	1826-0138	8	10	IC COMPARATOR GP QUAD 14-DIP-P PKG	01295	LM339N
A4U20	1826-1097	0	4	IC OP AMP WB 8-DIP-C PKG	06665	OP-17FZ

†Refer to Section 7 for update information.

*Factory Selected Component (Refer to Section 5).

Δ Errata part change.

Table 6-3. Replaceable Parts

Reference Designation	HP Part Number	C D	Qty.	Description	Mfr. Code	Mfr. Part Number
A4 08903-60283 – SERIAL PREFIX 2816A AND ABOVE (HP8903B)						
A4U21	1826-0582	6	2	IC SWITCH ANLG QUAD 16-DIP-C PKG	27014	LF13201D
A4U22	1826-1097	0	4	IC OP AMP WB 8-DIP-C PKG	06665	OP-17FZ
A4U23	1826-0740	8	1	IC SWITCH ANLG DUAL 16-DIP-C PKG	32293	IH5043CDE
A4U24	1826-0740	8	1	IC SWITCH ANLG DUAL 16-DIP-C PKG	32293	IH5043CDE
A4U25	1826-0606	5		IC SWITCH ANLG QUAD 16-DIP-C PRP 126MA	17856	DGZO1BK
A4U26	1826-0488	1		IC OP AMP WB TO-99 PKG	27014	LM218H
A4U27	1826-0785	1		IC OP AMP LOW-BIAS-H-IMPED DUAL 8-DIP-C	01295	TLO72ACJG
A4U28	1826-1097	0		IC OP AMP WB 8-DIP-C PKG	28480	1826-1097
A4U29	1820-1197	9		IC GATE TTL LS NAND QUAD 2-INP	01295	SN74LS00N
A4VR1	1902-0943	5	3	DIODE-ZNR 2.4V 5% DO-35 PD=.4W TC=-.037%	28480	1902-0943
A4VR2	1902-0064	1	1	DIODE-ZNR 7.5V 5% DO-35 PD=.4W TC=+.05%	28480	1902-0064
A4VR3	1902-3024	9	1	DIODE-ZNR 2.87V 5% DO-7 PD=.4W TC=-.07%	28480	1902-3024
A4VR4	1902-0680	7	2	DIODE-ZNR 1N827 6.2V 5% DO-7 PD=.4W	24046	1N827
A4VRS	1902-0953	7	1	DIODE-ZNR 6.2V 5% DO-35 PD=.4W TC=+.053%	28480	1902-0953
<i>2450A TO 2712A</i>						
A4W1				NOT ASSIGNED		
<i>2817A AND ABOVE</i>						
A4W1	1251-4670	2	1	CONNECTOR 3-PIN M POST TYPE	28480	1251-4670

†Refer to Section 7 for update information.

*Factory Selected Component (Refer to Section 5).

Δ Errata part change.

Table 6-3. Replaceable Parts

Reference Designation	HP Part Number	C D	Qty.	Description	Mfr. Code	Mfr. Part Number
A5						
A5	08903-60006	6	1	OSCILLATOR ASSEMBLY	28480	08903-60006
A5C1	0160-2055	9	61	CAPACITOR-FXD .01UF +80-20% 100VDC CER	28480	0160-2055
A5C2	0160-2055	9		CAPACITOR-FXD .01UF +80-20% 100VDC CER	28480	0160-2055
A5C3	0160-2055	9		CAPACITOR-FXD .01UF +80-20% 100VDC CER	28480	0160-2055
A5C4	0160-2055	9		CAPACITOR-FXD .01UF +80-20% 100VDC CER	28480	0160-2055
A5C5	0160-2055	9		CAPACITOR-FXD .01UF +80-20% 100VDC CER	28480	0160-2055
A5C6	0160-2055	9		CAPACITOR-FXD .01UF +80-20% 100VDC CER	28480	0160-2055
A5C7	0160-2055	9		CAPACITOR-FXD .01UF +80-20% 100VDC CER	28480	0160-2055
A5C8	0160-2055	9		CAPACITOR-FXD .01UF +80-20% 100VDC CER	28480	0160-2055
A5C9	0160-4590	1		CAPACITOR-FXD .18UF +-1% 200VDC	28480	0160-4590
A5C10	0160-5032	8		CAPACITOR-FXD .0223UF +-1% 200VDC	28480	0160-5032
A5C11	0160-3293	9		CAPACITOR-FXD 2470PF +-1% 100VDC MICA	28480	0160-3293
A5C12	0180-2620	6		CAPACITOR-FXD 2.2UF +-10% 50VDC TA	25088	D2R2GS1850K
A5C13	0180-2620	6		CAPACITOR-FXD 2.2UF +-10% 50VDC TA	25088	D2R2GS1850K
A5C14	0160-3934	5	2	CAPACITOR-FXD 350PF +-1% 100VDC MICA	28480	0160-3934
A5C15	0160-2055	9		CAPACITOR-FXD .01UF +80-20% 100VDC CER	28480	0160-2055
A5C16	0160-2055	9		CAPACITOR-FXD .01UF +80-20% 100VDC CER	28480	0160-2055
A5C17	0160-2055	9		CAPACITOR-FXD .01UF +80-20% 100VDC CER	28480	0160-2055
A5C18	0160-2055	9		CAPACITOR-FXD .01UF +80-20% 100VDC CER	28480	0160-2055
A5C19	0160-3934	5		CAPACITOR-FXD 350PF +-1% 100VDC MICA	28480	0160-3934
A5C20	0160-4590	1		CAPACITOR-FXD .18UF +-1% 200VDC	28480	0160-4590
A5C21	0160-5032	8		CAPACITOR-FXD .0223UF +-1% 200VDC	28480	0160-5032
A5C22	0160-3293	9		CAPACITOR-FXD 2470PF +-1% 100VDC MICA	28480	0160-3293
A5C23	0160-3874	2	1	CAPACITOR-FXD 10PF +-.5PF 200VDC CER	28480	0160-3874
A5C24	0160-0194	3	1	CAPACITOR-FXD .015UF +-10% 200VDC POLYE	28480	0160-0194
A5C25	0160-2055	9		CAPACITOR-FXD .01UF +80-20% 100VDC CER	28480	0160-2055
A5C26	0160-2055	9		CAPACITOR-FXD .01UF +80-20% 100VDC CER	28480	0160-2055
A5C27	0160-4494	4	1	CAPACITOR-FXD 39PF +-5% 200VDC CER 0+-30	28480	0160-4494
A5C28	0180-0197	8	13	CAPACITOR-FXD 2.2UF +-10% 20VDC TA	56289	150D225X9020A2
A5C29	0180-2141	6	1	CAPACITOR-FXD 3.3UF +-10% 50VDC TA	56289	150D335X9050B2
A5C30	0180-0197	8		CAPACITOR-FXD 2.2UF +-10% 20VDC TA	56289	150D225X9020A2
A5C31	0180-0291	3		CAPACITOR-FXD 1UF +-10% 35VDC TA	56289	150D105X9035A2
A5C32	0180-0291	3		CAPACITOR-FXD 1UF +-10% 35VDC TA	56289	150D105X9035A2
A5C33	0180-0197	8		CAPACITOR-FXD 2.2UF +-10% 20VDC TA	56289	150D225X9020A2
A5C34	0180-0197	8		CAPACITOR-FXD 2.2UF +-10% 20VDC TA	56289	150D225X9020A2
A5C35	0160-2055	9		CAPACITOR-FXD .01UF +80-20% 100VDC CER	28480	0160-2055
A5C36	0160-2225	5	1	CAPACITOR-FXD 2000PF +-5% 300VDC MICA	28480	0160-2225
A5C37	0180-0197	8		CAPACITOR-FXD 2.2UF +-10% 20VDC TA	56289	150D225X9020A2
A5C38	0160-3454	4	1	CAPACITOR-FXD 220PF +-10% 1KVDC CER	28480	0160-3454
A5C39	0160-4251	1	1	CAPACITOR-FXD 3300PF + 000000033-3%	84411	863UW
A5C40	0160-3466	8	3	CAPACITOR-FXD 100PF +-10% 1KVDC CER	28480	0160-3466
A5C41	0160-2055	9		CAPACITOR-FXD .01UF +80-20% 100VDC CER	28480	0160-2055
A5C42	0180-0291	3		CAPACITOR-FXD 1UF +-10% 35VDC TA	56289	150D105X9035A2
A5C43	0180-0291	3		CAPACITOR-FXD 1UF +-10% 35VDC TA	56289	150D105X9035A2
A5C44	0160-4521	8	2	CAPACITOR-FXD 12PF +-5% 200VDC CER 0+-30	28480	0160-4521
A5C45	0160-4402	4	1	CAPACITOR-FXD .1UF +-10% 100VDC POLYP	28480	0160-4402

†Refer to Section 7 for update information.

*Factory Selected Component (Refer to Section 5).

Δ Errata part change.

Table 6-3. Replaceable Parts

Reference Designation	HP Part Number	C D	Qty.	Description	Mfr. Code	Mfr. Part Number
A5C46	0160-2255	1	1	CAPACITOR-FXD 8.2PF +-25PF 500VDC CER	28480	0160-2255
A5C47	0160-4084	8	1	CAPACITOR-FXD .1UF +-20% 50VDC CER	28480	0160-4084
A5C48	0160-3456	6	3	CAPACITOR-FXD 1000PF +-10% 1KVDC CER	28480	0160-3456
A5C49	0180-0291	3		CAPACITOR-FXD 1UF+-10% 35VDC TA	56289	150D105X9035A2
A5C50	0160-5031	7	1	CAPACITOR-FXD .047UF +-2% 100VDC	28480	0160-5031
A5C51	0160-2055	9		CAPACITOR-FXD .01UF +-80-20% 100VDC CER	28480	0160-2055
A5C52	0160-2055	9		CAPACITOR-FXD .01UF +-80-20% 100VDC CER	28480	0160-2055
A5C53	0160-4521	8		CAPACITOR-FXD 12PF +-5% 200VDC CER 0+-30	28480	0160-4521
A5C54	0180-0291	3		CAPACITOR-FXD 1UF+-10% 35VDC TA	56289	150D105X9035A2
A5C55	0160-2055	9		CAPACITOR-FXD .01UF +-80-20% 100VDC CER	28480	0160-2055
A5C56	0180-0291	3		CAPACITOR-FXD 1UF+-10% 35VDC TA	56289	150D105X9035A2
A5C57	0160-2055	9		CAPACITOR-FXD .01UF +-80-20% 100VDC CER	28480	0160-2055
A5C58	0160-2055	9		CAPACITOR-FXD .01UF +-80-20% 100VDC CER	28480	0160-2055
<i>2450A TO 2720A</i>						
A5C59				NOT ASSIGNED		
A5C60				NOT ASSIGNED		
<i>2723A AND ABOVE</i>						
A5C59	0160-5254	6		CAPACITOR-FXD 1.5PF +-25PF 100VDC CER	28480	0160-5254
A5C60	0160-5254	6		CAPACITOR-FXD 1.5PF +-25PF 100VDC CER	28480	0160-5254
<i>2450A TO 2520A</i>						
A5CR1	1901-0376	6		DIODE-GEN PRP 35V 50MA DO-35	28480	1901-0376
A5CR2	1901-0376	6		DIODE-GEN PRP 35V 50MA DO-35	28480	1901-0376
A5CR3	1901-0376	6		DIODE-GEN PRP 35V 50MA DO-35	28480	1901-0376
A5CR4	1901-0376	6		DIODE-GEN PRP 35V 50MA DO-35	28480	1901-0376
A5CR5	1901-0376	6		DIODE-GEN PRP 35V 50MA DO-35	28480	1901-0376
A5CR6	1901-0880	7		DIODE-GEN PRP 125MA DO-35	28480	1901-0880
A5CR7	1901-0376	6		DIODE-GEN PRP 35V 50MA DO-35	28480	1901-0376
A5CR8	1901-0376	6		DIODE-GEN PRP 35V 50MA DO-35	28480	1901-0376
A5CR9	1901-0376	6		DIODE-GEN PRP 35V 50MA DO-35	28480	1901-0376
A5CR10	1901-0376	6		DIODE-GEN PRP 35V 50MA DO-35	28480	1901-0376
A5CR11	1901-0376	6		DIODE-GEN PRP 35V 50MA DO-35	28480	1901-0376
A5CR12	1901-0376	6		DIODE-GEN PRP 35V 50MA DO-35	28480	1901-0376
A5CR13	1901-0376	6		DIODE-GEN PRP 35V 50MA DO-35	28480	1901-0376
A5CR14	1901-0376	6		DIODE-GEN PRP 35V 50MA DO-35	28480	1901-0376
A5CR15	1901-0376	6		DIODE-GEN PRP 35V 50MA DO-35	28480	1901-0376
<i>2601A AND ABOVE</i>						
A5CR1	1901-0050	3		DIODE-SWITCHING 80V 200MA 2NS DO-35	28480	1901-0050
A5CR2	1901-0050	3		DIODE-SWITCHING 80V 200MA 2NS DO-35	28480	1901-0050
A5CR3	1901-0050	3		DIODE-SWITCHING 80V 200MA 2NS DO-35	28480	1901-0050
A5CR4	1901-0050	3		DIODE-SWITCHING 80V 200MA 2NS DO-35	28480	1901-0050
A5CR5	1901-0050	3		DIODE-SWITCHING 80V 200MA 2NS DO-35	28480	1901-0050
A5CR6	1901-0880	7		DIODE-GEN PRP 125MA DO-35	28480	1901-0880
A5CR7	1901-0880	7		DIODE-GEN PRP 125MA DO-35	28480	1901-0880
A5CR8	1901-0880	7		DIODE-GEN PRP 125MA DO-35	28480	1901-0880
A5CR9	1901-0880	7		DIODE-GEN PRP 125MA DO-35	28480	1901-0880
A5CR10	1901-0880	7		DIODE-GEN PRP 125MA DO-35	28480	1901-0880
A5CR11	1901-0880	7		DIODE-GEN PRP 125MA DO-35	28480	1901-0880
A5CR12	1901-0880	7		DIODE-GEN PRP 125MA DO-35	28480	1901-0880
A5CR13	1901-0880	7		DIODE-GEN PRP 125MA DO-35	28480	1901-0880
A5CR14	1901-0880	7		DIODE-GEN PRP 125MA DO-35	28480	1901-0880
A5CR15	1901-0880	7		DIODE-GEN PRP 125MA DO-35	28480	1901-0880

†Refer to Section 7 for update information.

*Factory Selected Component (Refer to Section 5).

Δ Errata part change.

Table 6-3. Replaceable Parts

Reference Designation	HP Part Number	C D	Qty.	Description	Mfr. Code	Mfr. Part Number
A5CR16	1901-0050	3		DIODE-SWITCHING 80V 200MA 2NS DO-35	28480	1901-0050
A5MP1	4040-0748 1480-0116	3 8		EXTR-PC BD BLK POLYC .062-BD-THKNS PIN-GRV .062-IN-DIA .25-IN-LG STL	28480 28480	4040-0748 1480-0116
A5MP2	4040-0753 1480-0116	0 8	1	EXTR-PC BD GRN POLYC .062-BD-THKNS PIN-GRV .062-IN-DIA .25-IN-LG STL	28480 28480	4040-0753 1480-0116
A5MP3	0403-0026	6		PLUG-HOLE BDR-HD FOR .187-D-HOLE NYL	02768	207-120241-03-0101
A5Q1	1853-0281	9		TRANSISTOR PNP 2N2907A SI TO-18 PD=400MW	04713	2N2907A
A5Q2	1854-0477	7	3	TRANSISTOR NPN 2N2222A SI TO-18 PD=500MW	04713	2N2222A
A5Q3	1855-0420	2		TRANSISTOR J-FET 2N4391 N-CHAN D-MODE	01295	2N4391
A5Q4	1855-0420	2		TRANSISTOR J-FET 2N4391 N-CHAN D-MODE	01295	2N4391
A5Q5	1855-0420	2		TRANSISTOR J-FET 2N4391 N-CHAN D-MODE	01295	2N4391
A5Q6	1855-0420	2		TRANSISTOR J-FET 2N4391 N-CHAN D-MODE	01295	2N4391
A5Q7	1855-0420	2		TRANSISTOR J-FET 2N4391 N-CHAN D-MODE	01295	2N4391
A5Q8	1855-0420	2		TRANSISTOR J-FET 2N4391 N-CHAN D-MODE	01295	2N4391
A5Q9	1855-0420	2		TRANSISTOR J-FET 2N4391 N-CHAN D-MODE	01295	2N4391
A5Q10	1855-0420	2		TRANSISTOR J-FET 2N4391 N-CHAN D-MODE	01295	2N4391
A5Q11	1855-0420	2		TRANSISTOR J-FET 2N4391 N-CHAN D-MODE	01295	2N4391
A5Q12	1855-0420	2		TRANSISTOR J-FET 2N4391 N-CHAN D-MODE	01295	2N4391
A5Q13	1855-0420	2		TRANSISTOR J-FET 2N4391 N-CHAN D-MODE	01295	2N4391
A5Q14	1855-0420	2		TRANSISTOR J-FET 2N4391 N-CHAN D-MODE	01295	2N4391
A5Q15	1855-0420	2		TRANSISTOR J-FET 2N4391 N-CHAN D-MODE	01295	2N4391
A5Q16	1855-0420	2		TRANSISTOR J-FET 2N4391 N-CHAN D-MODE	01295	2N4391
A5Q17	1855-0420	2		TRANSISTOR J-FET 2N4391 N-CHAN D-MODE	01295	2N4391
A5Q18	1855-0420	2		TRANSISTOR J-FET 2N4391 N-CHAN D-MODE	01295	2N4391
A5Q19	1855-0420	2		TRANSISTOR J-FET 2N4391 N-CHAN D-MODE	01295	2N4391
A5Q20	1855-0420	2		TRANSISTOR J-FET 2N4391 N-CHAN D-MODE	01295	2N4391
A5Q21	1855-0420	2		TRANSISTOR J-FET 2N4391 N-CHAN D-MODE	01295	2N4391
A5Q22	1855-0420	2		TRANSISTOR J-FET 2N4391 N-CHAN D-MODE	01295	2N4391
A5Q23	1855-0420	2		TRANSISTOR J-FET 2N4391 N-CHAN D-MODE	01295	2N4391
A5Q24	1855-0420	2		TRANSISTOR J-FET 2N4391 N-CHAN D-MODE	01295	2N4391
A5Q25	1855-0420	2		TRANSISTOR J-FET 2N4391 N-CHAN D-MODE	01295	2N4391
A5Q26	1855-0420	2		TRANSISTOR J-FET 2N4391 N-CHAN D-MODE	01295	2N4391
A5Q27	1855-0420	2		TRANSISTOR J-FET 2N4391 N-CHAN D-MODE	01295	2N4391
A5Q28	1855-0420	2		TRANSISTOR J-FET 2N4391 N-CHAN D-MODE	01295	2N4391
A5Q29	1855-0420	2		TRANSISTOR J-FET 2N4391 N-CHAN D-MODE	01295	2N4391
A5Q30	1855-0420	2		TRANSISTOR J-FET 2N4391 N-CHAN D-MODE	01295	2N4391
A5Q31	1855-0420	2		TRANSISTOR J-FET 2N4391 N-CHAN D-MODE	01295	2N4391
A5Q32	1854-0477	7		TRANSISTOR NPN 2N2222A SI TO-18 PD=500MW	04713	2N2222A
A5Q33	1853-0281	9		TRANSISTOR PNP 2N2907A SI TO-18 PD=400MW	04713	2N2907A
A5Q34	1855-0420	2		TRANSISTOR J-FET 2N4391 N-CHAN D-MODE	01295	2N4391
A5R1	0698-3430	5	27	RESISTOR 21.5 1% .125W F TC=0+-100	03888	PME55-1/8-T0-21R5-F
A5R2	0698-3430	5		RESISTOR 21.5 1% .125W F TC=0+-100	03888	PME55-1/8-T0-21R5-F
A5R3	1810-0206	8	5	NETWORK-RES 8-SIP10.0K OHM X 7	01121	208A103
A5R4	1810-0206	8		NETWORK-RES 8-SIP10.0K OHM X 7	01121	208A103
A5R5	0698-3430	5		RESISTOR 21.5 1% .125W F TC=0+-100	03888	PME55-1/8-T0-21R5-F
A5R6	0698-3430	5		RESISTOR 21.5 1% .125W F TC=0+-100	03888	PME55-1/8-T0-21R5-F
A5R7	0698-3430	5		RESISTOR 21.5 1% .125W F TC=0+-100	03888	PME55-1/8-T0-21R5-F
A5R8	0698-3430	5		RESISTOR 21.5 1% .125W F TC=0+-100	03888	PME55-1/8-T0-21R5-F
A5R9	0757-0280	3		RESISTOR 1K 1% .125W F TC=0+-100	24546	C4-1/8-T0-1001-F
A5R10	0698-8204	1		RESISTOR 7.98K .1% .125W F TC=0+-25	19701	MF4C1/8-T9-7981-B

†Refer to Section 7 for update information.

*Factory Selected Component (Refer to Section 5).

Δ Errata part change.

Table 6-3. Replaceable Parts

Reference Designation	HP Part Number	C D	Qty.	Description	Mfr. Code	Mfr. Part Number
A5R11	0698-8205	2		RESISTOR 15.98K .1% .125W F TC=0+-25	19701	MF4C1/8-T9-15981-B
A5R12	0698-8047	0		RESISTOR 32K .1% .125W F TC=0+-25	19701	MF4C1/8-T9-3202-B
A5R13	0698-8049	2		RESISTOR 64K .1% .125W F TC=0+-25	19701	MF4C1/8-T9-6402-B
A5R14	0698-8053	8		RESISTOR 128K .1% .125W F TC=0+-25	19701	MF4C1/8-T9-1283-B
A5R15	0698-8050	5		RESISTOR 256K .1% .125W F TC=0+-25	19701	MF4C1/8-T9-2563-B
A5R16	0699-0676	7	2	RESISTOR 511K .1% .125W F TC=0+-50	28480	0699-0676
A5R17	0699-0730	4	3	RESISTOR 1M .1% .125W F TC=0+-25	28480	0699-0730
A5R18	0757-0417	8	2	RESISTOR 562 1% .125W F TC=0+-100	24546	C4-1/8-T0-562R-F
A5R19	0757-0447	4		RESISTOR 16.2K 1% .125W F TC=0+-100	24546	C4-1/8-T0-1622-F
A5R20	1810-0206	8		NETWORK-RES 8-SIP10.0K OHM X 7	01121	208A103
A5R21	0757-0290	5		RESISTOR 6.19K 1% .125W F TC=0+-100	19701	MF4C1/8-T0-6191-F
A5R22	0757-0394	0	6	RESISTOR 51.1 1% .125W F TC=0+-100	24546	C4-1/8-T0-51R1-F
A5R23	0757-0442	9		RESISTOR 10K 1% .125W F TC=0+-100	24546	C4-1/8-T0-1002-F
A5R24	0757-0442	9		RESISTOR 10K 1% .125W F TC=0+-100	24546	C4-1/8-T0-1002-F
A5R25	0698-3430	5		RESISTOR 21.5 1% .125W F TC=0+-100	03888	PME55-1/8-T0-21R5-F
A5R26	0698-3430	5		RESISTOR 21.5 1% .125W F TC=0+-100	03888	PME55-1/8-T0-21R5-F
A5R27	0757-0280	3		RESISTOR 1K 1% .125W F TC=0+-100	24546	C4-1/8-T0-1001-F
A5R28	0698-8204	1		RESISTOR 7.98K .1% .125W F TC=0+-25	19701	MF4C1/8-T9-7981-B
A5R29	0698-8205	2		RESISTOR 15.98K .1% .125W F TC=0+-25	19701	MF4C1/8-T9-15981-B
A5R30	0698-8047	0		RESISTOR 32K .1% .125W F TC=0+-25	19701	MF4C1/8-T9-3202-B
A5R31	0698-8049	2		RESISTOR 64K .1% .125W F TC=0+-25	19701	MF4C1/8-T9-6402-B
A5R32	0698-8053	8		RESISTOR 128K .1% .125W F TC=0+-25	19701	MF4C1/8-T9-1283-B
A5R33	0698-8050	5		RESISTOR 256K .1% .125W F TC=0+-25	19701	MF4C1/8-T9-2563-B
A5R34	0699-0576	7		RESISTOR 511K .1% .125W F TC=0+-50	28480	0699-0576
A5R35	0699-0730	4		RESISTOR 1M .1% .125W F TC=0+-25	28480	0699-0730
A5R36	0698-3430	5		RESISTOR 21.5 1% .125W F TC=0+-100	03888	PME55-1/8-T0-21R5-F
A5R37	0698-3430	5		RESISTOR 21.5 1% .125W F TC=0+-100	03888	PME55-1/8-T0-21R5-F
A5R38	0757-0394	0		RESISTOR 51.1 1% .125W F TC=0+-100	24546	C4-1/8-T0-51R1-F
A5R39	0698-3430	5		RESISTOR 21.5 1% .125W F TC=0+-100	03888	PME55-1/8-T0-21R5-F
A5R40	0698-3430	5		RESISTOR 21.5 1% .125W F TC=0+-100	03888	PME55-1/8-T0-21R5-F
A5R41	0757-0280	3		RESISTOR 1K 1% .125W F TC=0+-100	24546	C4-1/8-T0-1001-F
A5R42	0698-8049	2		RESISTOR 64K .1% .125W F TC=0+-25	19701	MF4C1/8-T9-6402-B
A5R43	0698-8047	0		RESISTOR 32K .1% .125W F TC=0+-25	19701	MF4C1/8-T9-3202-B
A5R44	0698-8205	2		RESISTOR 15.98K .1% .125W F TC=0+-25	19701	MF4C1/8-T9-15981-B
A5R45	0698-8204	1		RESISTOR 7.98K .1% .125W F TC=0+-25	19701	MF4C1/8-T9-7981-B
A5R46	0698-3430	5		RESISTOR 21.5 1% .125W F TC=0+-100	03888	PME55-1/8-T0-21R5-F
A5R47	0698-3450	9	2	RESISTOR 42.2K 1% .125W F TC=0+-100	24546	C4-1/8-T0-4222-F
A5R48	0698-3157	3		RESISTOR 19.6K 1% .125W F TC=0+-100	24546	C4-1/8-T0-1962-F
A5R49	0698-3157	3		RESISTOR 19.6K 1% .125W F TC=0+-100	24546	C4-1/8-T0-1962-F
A5R50	0699-0730	4		RESISTOR 1M .1% .125W F TC=0+-25	28480	0699-0730
A5R51	0698-3430	5		RESISTOR 21.5 1% .125W F TC=0+-100	03888	PME55-1/8-T0-21R5-F
A5R52	0698-8050	5		RESISTOR 256K .1% .125W F TC=0+-25	19701	MF4C1/8-T9-2563-B
A5R53	0698-8053	8		RESISTOR 128K .1% .125W F TC=0+-25	19701	MF4C1/8-T9-1283-B
A5R54	0757-0279	0		RESISTOR 3.16K 1% .125W F TC=0+-100	24546	C4-1/8-T0-3161-F
A5R55	0757-1094	9		RESISTOR 1.47K 1% .125W F TC=0+-100	24546	C4-1/8-T0-1471-F
A5R56	0698-0083	8	4	RESISTOR 1.96K 1% .125W F TC=0+-100	24546	C4-1/8-T0-1961-F
A5R57	0757-0288	1	2	RESISTOR 9.09K 1% .125W F TC=0+-100	19701	MF4C1/8-T0-9091-F
A5R58	0698-3160	8		RESISTOR 31.6K 1% .125W F TC=0+-100	24546	C4-1/8-T0-3162-F
A5R59	0757-0280	3		RESISTOR 1K 1% .125W F TC=0+-100	24546	C4-1/8-T0-1001-F
A5R60	0698-3136	8		RESISTOR 17.8K 1% .125W F TC=0+-100	24546	C4-1/8-T0-1782-F

†Refer to Section 7 for update information.

*Factory Selected Component (Refer to Section 5).

Δ Errata part change.

Table 6-3. Replaceable Parts

Reference Designation	HP Part Number	C D	Qty.	Description	Mfr. Code	Mfr. Part Number
A5R61	0698-3430	5		RESISTOR 21.5 1% .125W F TC=0+-100	03888	PME55-1/8-T0-21R5-F
A5R62	0698-3430	5		RESISTOR 21.5 1% .125W F TC=0+-100	03888	PME55-1/8-T0-21R5-F
A5R63	0757-0442	9		RESISTOR 10K 1% .125W F TC=0+-100	24546	C4-1/8-T0-1002-F
A5R64	0757-0280	3		RESISTOR 1K 1% .125W F TC=0+-100	24546	C4-1/8-T0-1001-F
A5R65	0757-0442	9		RESISTOR 10K 1% .125W F TC=0+-100	24546	C4-1/8-T0-1002-F
A5R66	0757-0442	9		RESISTOR 10K 1% .125W F TC=0+-100	24546	C4-1/8-T0-1002-F
A5R67	0757-0280	3		RESISTOR 1K 1% .125W F TC=0+-100	24546	C4-1/8-T0-1001-F
A5R68				NOT ASSIGNED		
A5R69	0757-0442	9		RESISTOR 10K 1% .125W F TC=0+-100	24546	C4-1/8-T0-1002-F
A5R70	0757-0465	6		RESISTOR 100K 1% .125W F TC=0+-100	24546	C4-1/8-T0-1003-F
A5R71				NOT ASSIGNED		
A5R72	0698-3435	0	7	RESISTOR 38.3 1% .125W F TC=0+-100	24546	C4-1/8-T0-38R3-F
A5R73	0698-3435	0		RESISTOR 38.3 1% .125W F TC=0+-100	24546	C4-1/8-T0-38R3-F
A5R74	0757-0280	3		RESISTOR 1K 1% .125W F TC=0+-100	24546	C4-1/8-T0-1001-F
A5R75				NOT ASSIGNED		
A5R76	0757-0401	0		RESISTOR 100 1% .125W F TC=0+-100	24546	C4-1/8-T0-101-F
A5R77	0757-0280	3		RESISTOR 1K 1% .125W F TC=0+-100	24546	C4-1/8-T0-1001-F
A5R78	0757-0280	3		RESISTOR 1K 1% .125W F TC=0+-100	24546	C4-1/8-T0-1001-F
A5R79	0757-0417	8		RESISTOR 562 1% .125W F TC=0+-100	24546	C4-1/8-T0-562R-F
A5R80	0698-3450	9		RESISTOR 42.2K 1% .125W F TC=0+-100	24546	C4-1/8-T0-4222-F
A5R81	0757-0470	3		RESISTOR 162K 1% .125W F TC=0+-100	24546	C4-1/8-T0-1623-F
A5R82	0757-0288	1		RESISTOR 9.09K 1% .125W F TC=0+-100	19701	MF4C1/8-T0-9091-F
A5R83	0757-0280	3		RESISTOR 1K 1% .125W F TC=0+-100	24546	C4-1/8-T0-1001-F
A5R84	0757-0442	9		RESISTOR 10K 1% .125W F TC=0+-100	24546	C4-1/8-T0-1002-F
A5R85	0757-0290	5		RESISTOR 6.19K 1% .125W F TC=0+-100	19701	MF4C1/8-T0-6191-F
A5R86	0698-3161	9	2	RESISTOR 38.3K 1% .125W F TC=0+-100	24546	C4-1/8-T0-3832-F
A5R87	0698-3430	5		RESISTOR 21.5 1% .125W F TC=0+-100	03888	PME55-1/8-T0-21R5-F
A5R88	0757-0317	7	2	RESISTOR 1.33K 1% .125W F TC=0+-100	24546	C4-1/8-T0-1331-F
A5R89	0698-3435	0		RESISTOR 38.3 1% .125W F TC=0+-100	24546	C4-1/8-T0-38R3-F
A5R90	0698-3435	0		RESISTOR 38.3 1% .125W F TC=0+-100	24546	C4-1/8-T0-38R3-F
A5R91	0757-0442	9		RESISTOR 10K 1% .125W F TC=0+-100	24546	C4-1/8-T0-1002-F
A5R92	0757-0280	3		RESISTOR 1K 1% .125W F TC=0+-100	24546	C4-1/8-T0-1001-F
A5R93	0757-0438	3		RESISTOR 5.11K 1% .125W F TC=0+-100	24546	C4-1/8-T0-5111-F
A5R94	0698-3435	0		RESISTOR 38.3 1% .125W F TC=0+-100	24546	C4-1/8-T0-38R3-F
A5R95	0757-0442	9		RESISTOR 10K 1% .125W F TC=0+-100	24546	C4-1/8-T0-1002-F
A5R96	0757-0401	0		RESISTOR 100 1% .125W F TC=0+-100	24546	C4-1/8-T0-101-F
A5R97	0699-0400	5	1	RESISTOR 3.6K 1% .125W F TC=0+-25	28480	0699-0400
A5R98	0698-8204	1		RESISTOR 7.98K 1% .125W F TC=0+-25	19701	MF4C1/8-T9-7981-B
A5R99	0698-0083	8		RESISTOR 1.96K 1% .125W F TC=0+-100	24546	C4-1/8-T0-1961-F
A5R100	0698-3445	2	1	RESISTOR 348 1% .125W F TC=0+-100	24546	C4-1/8-T0-348R-F
A5R101	0757-0401	0		RESISTOR 100 1% .125W F TC=0+-100	24546	C4-1/8-T0-101-F
A5R102	2100-3103	6		RESISTOR-TRMR 10K 10% C SIDE-ADJ 17-TRN	02111	43P103
A5R103	0757-0280	3		RESISTOR 1K 1% .125W F TC=0+-100	24546	C4-1/8-T0-1001-F
A5R104	0698-6320	8	2	RESISTOR 5K 1% .125W F TC=0+-25	03888	PME55-1/8-T9-5001-B
A5R105	0698-6320	8		RESISTOR 5K 1% .125W F TC=0+-25	03888	FME55-1/8-T9-5001-B
A5R106	0757-0317	7		RESISTOR 1.33K 1% .125W F TC=0+-100	24546	C4-1/8-T0-1331-F
A5R107	0698-3430	5		RESISTOR 21.5 1% .125W F TC=0+-100	03888	PME55-1/8-T0-21R5-F
A5R108	0698-3161	9		RESISTOR 38.3K 1% .125W F TC=0+-100	24546	C4-1/8-T0-3832-F
A5R109	0757-0428	1	3	RESISTOR 1.62K 1% .125W F TC=0+-100	24546	C4-1/8-T0-1621-F
A5R110	0757-0401	0		RESISTOR 100 1% .125W F TC=0+-100	24546	C4-1/8-T0-101-F

† Refer to Section 7 for update information.

* Factory Selected Component (Refer to Section 5).

Δ Errata part change.

Table 6-3. Replaceable Parts

Reference Designation	HP Part Number	C D	Qty.	Description	Mfr. Code	Mfr. Part Number
A5R111	0757-0279	0		RESISTOR 3.16K 1% .125W F TC=0+-100	24546	C4-1/8-T0-3161-F
A5R112	0698-3435	0		RESISTOR 38.3 1% .125W F TC=0+-100	24546	C4-1/8-T0-38R3-F
A5R113	0698-3435	0		RESISTOR 38.3 1% .125W F TC=0+-100	24546	C4-1/8-T0-38R3-F
A5R114	0757-0280	3		RESISTOR 1K 1% .125W F TC=0+-100	24546	C4-1/8-T0-1001-F
A5R115	0698-3150	6		RESISTOR 2.37K 1% .125W F TC=0+-100	24546	C4-1/8-T0-2371-F
A5R116	0757-0450	8	1	RESISTOR 56.2K 1% .125W F TC=0+-100	24546	C4-1/8-T0-5622-F
A5R117	0757-0465	6		RESISTOR 100K 1% .125W F TC=0+-100	24546	C4-1/8-T0-1003-F
A5R118	0698-7262	9		RESISTOR 12.1K 1% .05W F TC=0+-100	24546	C3-1/8-T0-1212-F
A5R119	0757-0280	3		RESISTOR 1K 1% .125W F TC=0+-100	24546	C4-1/8-T0-1001-F
A5R120	0757-0440	7		RESISTOR 7.5K 1% .125W F TC=0+-100	24546	C4-1/8-T0-7501-F
A5R121	0698-7241	4		RESISTOR 1.62K 1% .05W F TC=0+-100	24546	C3-1/8-T0-1621-F
A5R122	0698-3430	5		RESISTOR 21.5 1% .125W F TC=0+-100	03888	PME55-1/8-T0-21R5-F
A5R123	0757-0280	3		RESISTOR 1K 1% .125W F TC=0+-100	24546	C4-1/8-T0-1001-F
A5R124	0698-0084	9		RESISTOR 2.15K 1% .125W F TC=0+-100	24546	C4-1/8-T0-2151-F
A5R125	0698-0084	9		RESISTOR 2.15K 1% .125W F TC=0+-100	24546	C4-1/8-T0-2151-F
A5R126	0698-3430	5		RESISTOR 21.5 1% .125W F TC=0+-100	03888	PME55-1/8-T0-21R5-F
A5R127	0698-3153	9		RESISTOR 3.83K 1% .125W F TC=0+-100	24546	C4-1/8-T0-3831-F
A5R128	0698-3153	9		RESISTOR 3.83K 1% .125W F TC=0+-100	24546	C4-1/8-T0-3831-F
A5R129	0757-0442	9		RESISTOR 10K 1% .125W F TC=0+-100	24546	C4-1/8-T0-1002-F
A5R130	0757-0442	9		RESISTOR 10K 1% .125W F TC=0+-100	24546	C4-1/8-T0-1002-F
A5R131	0698-3430	5		RESISTOR 21.5 1% .125W F TC=0+-100	03888	PME55-1/8-T0-21R5-F
A5R132	0698-3430	5		RESISTOR 21.5 1% .125W F TC=0+-100	03888	PME55-1/8-T0-21R5-F
A5TP1	1251-0600	0		CONNECTOR-SGL CONT PIN 1.14-MM-BSC-SZ SQ	28480	1251-0600
A5TP2	1251-0600	0		CONNECTOR-SGL CONT PIN 1.14-MM-BSC-SZ SQ	28480	1251-0600
A5TP3	1251-0600	0		CONNECTOR-SGL CONT PIN 1.14-MM-BSC-SZ SQ	28480	1251-0600
A5TP4	1251-0600	0		CONNECTOR-SGL CONT PIN 1.14-MM-BSC-SZ SQ	28480	1251-0600
A5TP5	1251-0600	0		CONNECTOR-SGL CONT PIN 1.14-MM-BSC-SZ SQ	28480	1251-0600
A5TP6	1251-0600	0		CONNECTOR-SGL CONT PIN 1.14-MM-BSC-SZ SQ	28480	1251-0600
A5TP7	1251-0600	0		CONNECTOR-SGL CONT PIN 1.14-MM-BSC-SZ SQ	28480	1251-0600
A5TP8	1251-0600	0		CONNECTOR-SGL CONT PIN 1.14-MM-BSC-SZ SQ	28480	1251-0600
A5TP9	1251-0600	0		CONNECTOR-SGL CONT PIN 1.14-MM-BSC-SZ SQ	28480	1251-0600
A5TP10	1251-0600	0		CONNECTOR-SGL CONT PIN 1.14-MM-BSC-SZ SQ	28480	1251-0600
A5TP11	1251-0600	0		CONNECTOR-SGL CONT PIN 1.14-MM-BSC-SZ SQ	28480	1251-0600
A5U1	1820-1144	6	1	IC GATE TTL LS NOR QUAD 2-INP	01295	SN74LS02N
A5U2	1826-0026	3	1	IC COMPARATOR PRCN TO-99 PKG	01295	LM311L
A5U3				NOT ASSIGNED		
A5U4	1826-0662	3		IC OP AMP LOW-BIAS-H-IMPED TO-99 PKG	28480	1826-0662
A5U5	1826-0783	9		IC OP AMP LOW-NOISE 8-DIP-C PKG	52063	XR5534ACN
A5U6	08903-80041	4	1	IC, LINEAR	02480	08903-80041
A5U7	1820-1423	4	1	IC MV TTL LS MONOSTBL RETRIG DUAL	01295	SN74LS123N
A5U8	1826-0138	8		IC COMPARATOR GP QUAD 14-DIP-P PKG	01295	LM339N
A5U9	1826-0371	1	3	IC OP AMP LOW-BIAS-H-IMPED TO-99 PKG	27014	LF256H
A5U10	1826-0785	1		IC OP AMP LOW-BIAS-H-IMPED DUAL 8-DIP-C	01295	TL072ACJG
A5U11	1826-0662	3		IC OP AMP LOW-BIAS-H-IMPED TO-99 PKG	28480	1826-0662
A5U12	1826-0716	8	4	IC OP AMP LOW-NOISE DUAL 8-DIP-C PKG	18324	NE5532AFE
A5U13	1826-0371	1		IC OP AMP LOW-BIAS-H-IMPED TO-99 PKG	27014	LF256H
A5U14	1826-1492	9	2	IC OP AMP	28480	1826-1492
A5U15	1826-1492	9		IC OP AMP	28480	1826-1492

†Refer to Section 7 for update information.

*Factory Selected Component (Refer to Section 5).

Δ Errata part change.

Table 6-3. Replaceable Parts

Reference Designation	HP Part Number	C D	Qty.	Description	Mfr. Code	Mfr. Part Number
A5U16	1826-0138	8		IC COMPARATOR GP QUAD 14-DIP-P PKG	01295	LM339N
A5U17	1826-0138	8		IC COMPARATOR GP QUAD 14-DIP-P PKG	01295	LM339N
A5U18	1826-0138	8		IC COMPARATOR GP QUAD 14-DIP-P PKG	01295	LM339N
A5U19	1826-0582	6		IC SWITCH ANLG QUAD 16-DIP-C PKG	27014	LF13201D
A5U20	1826-0138	8		IC COMPARATOR GP QUAD 14-DIP-P PKG	01295	LM339N
A5VR1	1902-0951	5	2	DIODE-ZNR 5.1V 5% DO-35 PD=.4W TC=+.035%	28480	1902-0951
A5VR2	1902-0951	5		DIODE-ZNR 5.1V 5% DO-35 PD=.4W TC=+.035%	28480	1902-0951
A5VR3	1902-0943	5		DIODE-ZNR 2.4V 5% DO-35 PD=.4W TC=-.037%	28480	1902-0943
A5VR4	1902-0954	8	1	DIODE-ZNR 6.8V 5% DO-35 PD=.4W TC=+.057%	28480	1902-0954
A5VR5	1902-0680	7		DIODE-ZNR 1N827 6.2V 5% DO-7 PD=.4W	24046	1N827
A5VR6	1902-0955	9	1	DIODE-ZNR 7.5V 5% DO-35 PD=.4W TC=+.062%	28480	1902-0955

†Refer to Section 7 for update information.

*Factory Selected Component (Refer to Section 5).

Δ Errata part change.

Table 6-3. Replaceable Parts

Reference Designation	HP Part Number	C D	Qty.	Description	Mfr. Code	Mfr. Part Number
A6						
A6	08903-60132	9	1	OUTPUT ATTENUATOR ASSEMBLY	28480	08903-60132
A6C1	0180-0116	1	21	CAPACITOR-FXD 6.8UF +-10% 35VDC TA	56289	150D685X9035B2
A6C2				NOT ASSIGNED		
A6C3	0180-0116	1		CAPACITOR-FXD 6.8UF +-10% 35VDC TA	56289	150D685X9035B2
A6C4	0180-0116	1		CAPACITOR-FXD 6.8UF +-10% 35VDC TA	56289	150D685X9035B2
A6C5	0180-0116	1		CAPACITOR-FXD 6.8UF +-10% 35VDC TA	56289	150D685X9035B2
A6C6				NOT ASSIGNED		
A6C7	0180-0116	1		CAPACITOR-FXD 6.8UF +-10% 35VDC TA	56289	150D685X9035B2
A6C8	0180-0116	1		CAPACITOR-FXD 6.8UF +-10% 35VDC TA	56289	150D685X9035B2
A6C9	0180-0116	1		CAPACITOR-FXD 6.8UF +-10% 35VDC TA	56289	150D685X9035B2
A6C10				NOT ASSIGNED		
A6C11	0160-4791	4		CAPACITOR-FXD 10PF +-5% 100VDC CER 0+-30	28480	0160-4791
A6C13	0180-2207	5		CAPACITOR-FXD 100UF +-10% 10VDC TA	56289	150D107X9010R2
A6C14	0160-4787	8		CAPACITOR-FXD 22PF +-5% 100VDC CER 0+-30	28480	0160-4787
A6C15	0160-4800	6	2	CAPACITOR-FXD 120PF +-5% 100VDC CER	28480	0160-4800
A6C16-C19				NOT ASSIGNED		
A6C20	0160-4800	6		CAPACITOR-FXD 120PF +-5% 100VDC CER	28480	0160-4800
A6C21	0180-0116	1		CAPACITOR-FXD 6.8UF +-10% 35VDC TA	56289	150D685X9035B2
A6C22	0180-0116	1		CAPACITOR-FXD 6.8UF +-10% 35VDC TA	56289	150D685X9035B2
A6C23	0180-0116	1		CAPACITOR-FXD 6.8UF +-10% 35VDC TA	56289	150D685X9035B2
A6C24	0180-0116	1		CAPACITOR-FXD 6.8UF +-10% 35VDC TA	56289	150D685X9035B2
A6C25	0121-0493	3	1	CAPACITOR-V TRMR-AIR 1.7-11PF 175V	74970	187-0306-125
A6C26	0160-4789	0	2	CAPACITOR-FXD 15PF +-5% 100VDC CER 0+-30	28480	0160-4789
A6C27				NOT ASSIGNED		
A6C28	0180-0374	3		CAPACITOR-FXD 10UF +-10% 20VDC TA	56289	150D106X9020R2
A6C29				NOT ASSIGNED		
A6C30	0160-4832	4		CAPACITOR-FXD .01UF +-10% 100VDC CER	28480	0160-4832
A6C31	0160-4832	4		CAPACITOR-FXD .01UF +-10% 100VDC CER	28480	0160-4832
A6C32	0180-1794	3	4	CAPACITOR-FXD 22UF +-10% 35VDC TA	56289	150D226X9035R2
A6C33	0160-4832	4		CAPACITOR-FXD .01UF +-10% 100VDC CER	28480	0160-4832
A6C34	0180-1794	3		CAPACITOR-FXD 22UF +-10% 35VDC TA	56289	150D226X9035R2
A6C35	0160-4832	4		CAPACITOR-FXD .01UF +-10% 100VDC CER	28480	0160-4832
A6C36	0180-1794	3		CAPACITOR-FXD 22UF +-10% 35VDC TA	56289	150D226X9035R2
A6C37	0160-4832	4		CAPACITOR-FXD .01UF +-10% 100VDC CER	28480	0160-4832
A6C38	0180-1794	3		CAPACITOR-FXD 22UF +-10% 35VDC TA	56289	150D226X9035R2
A6C39	0160-4832	4		CAPACITOR-FXD .01UF +-10% 100VDC CER	28480	0160-4832
A6C40	0150-3466	8		CAPACITOR-FXD 100PF +-10% 1KVDC CER	28480	0160-3466
A6C41	0160-3466	8		CAPACITOR-FXD 100PF +-10% 1KVDC CER	28480	0160-3466
A6CR1	1901-0050	3		DIODE-SWITCHING 80V 200MA 2NS DO-35	28480	1901-0050
A6CR2	1901-0050	3		DIODE-SWITCHING 80V 200MA 2NS DO-35	28480	1901-0050
A6CR3				NOT ASSIGNED		
A6CR4	1901-0880	7		DIODE-GEN PRP 125MA DO-35	03406	1901-0880
A6CR5	1901-0880	7		DIODE-GEN PRP 125MA DO-35	03406	1901-0880

†Refer to Section 7 for update information.

*Factory Selected Component (Refer to Section 5).

Δ Errata part change.

Table 6-3. Replaceable Parts

Reference Designation	HP Part Number	C D	Qty.	Description	Mfr. Code	Mfr. Part Number
A6CR6	1901-0880	7		DIODE-GEN PRP 125MA DO-35	03406	1901-0880
A6CR7	1901-0880	7		DIODE-GEN PRP 125MA DO-35	03406	1901-0880
A6CR8	1901-0873	8	4	DIODE-HV RECT 600V 1A	28480	1901-0873
A6CR9	1901-0873	8		DIODE-HV RECT 600V 1A	28480	1901-0873
A6CR10	1901-0873	8		DIODE-HV RECT 600V 1A	28480	1901-0873
A6CR11	1901-0873	8		DIODE-HV RECT 600V 1A	28480	1901-0873
A6CR12	1901-0050	3		DIODE-SWITCHING 80V 200MA 2NS DO-35	28480	1901-0050
A6CR13	1901-0050	3		DIODE-SWITCHING 80V 200MA 2NS DO-35	28480	1901-0050
A6CR14	1901-0050	3		DIODE-SWITCHING 80V 200MA 2NS DO-35	28480	1901-0050
<i>2450A TO 2520A</i>						
A6CR15	1901-0376	6		DIODE-GEN PRP 35V 50MA DO-35	28480	1901-0376
A6CR16	1901-0376	6		DIODE-GEN PRP 35V 50MA DO-35	28480	1901-0376
A6CR17	1901-0376	6		DIODE-GEN PRP 35V 50MA DO-35	28480	1901-0376
A6CR18	1901-0376	6		DIODE-GEN PRP 35V 50MA DO-35	28480	1901-0376
A6CR19	1901-0376	6		DIODE-GEN PRP 35V 50MA DO-35	28480	1901-0376
A6CR20	1901-0376	6		DIODE-GEN PRP 35V 50MA DO-35	28480	1901-0376
A6CR21	1901-0376	6		DIODE-GEN PRP 35V 50MA DO-35	28480	1901-0376
A6CR22	1901-0376	6		DIODE-GEN PRP 35V 50MA DO-35	28480	1901-0376
<i>2601A AND ABOVE</i>						
A6CR15	1901-0880	7		DIODE-GEN PRP 125MA DO-35	28480	1901-0880
A6CR16	1901-0880	7		DIODE-GEN PRP 125MA DO-35	28480	1901-0880
A6CR17	1901-0880	7		DIODE-GEN PRP 125MA DO-35	28480	1901-0880
A6CR18	1901-0880	7		DIODE-GEN PRP 125MA DO-35	28480	1901-0880
A6CR19	1901-0179	7		DIODE-SWITCHING 15V 50MA 750PS DO-7	28480	1901-0179
A6CR20	1901-0179	7		DIODE-SWITCHING 15V 50MA 750PS DO-7	28480	1901-0179
A6CR21	1901-0179	7		DIODE-SWITCHING 15V 50MA 750PS DO-7	28480	1901-0179
A6CR22	1901-0179	7		DIODE-SWITCHING 15V 50MA 750PS DO-7	28480	1901-0179
A6CR23	1902-0627	2	4	DIODE-CUR RGLTR 1N5312 100V DO-7	04713	1N5312
A6CR24	1902-0627	2		DIODE-CUR RGLTR 1N5312 100V DO-7	04713	1N5312
A6CR25	1902-0627	2		DIODE-CUR RGLTR 1N5312 100V DO-7	04713	1N5312
A6CR26	1902-0627	2		DIODE-CUR RGLTR 1N5312 100V DO-7	04713	1N5312
A6CR27	1901-0050	3		DIODE-SWITCHING 80V 200MA 2NS DO-35	28480	1901-0050
A6K1	0490-1190	0	2	RELAY 2C 5VDC-COIL .5A 125VAC	28480	0490-1190
A6K2	0490-1501	7	2	RELAY-R 200W 2A 5 VDC	28480	0490-1501
A6K3	0490-1501	7	2	RELAY-R 200W 2A 5 VDC	28480	0490-1501
A6K4	0490-1190	0		RELAY 2C 5VDC-COIL .5A 125VAC	28480	0490-1190
A6L1	9140-0210	1		INDUCTOR RF-CH-MLD 100UH 5% .166DX.385LG	28480	9140-0210
A6L2	9140-0210	1		INDUCTOR RF-CH-MLD 100UH 5% .166DX.385LG	28480	9140-0210
A6L3				NOT ASSIGNED		
A6L4				NOT ASSIGNED		
A6L5	9140-0210	1		INDUCTOR RF-CH-MLD 100UH 5% .166DX.385LG	28480	9140-0210
A6MP1	4040-0748	3		EXTR-PC BD BLK POLYC .062-BD-THKNS	28480	4040-0748
	1480-0116	8		PIN-GRV .062-IN-DIA .25-IN-LG STL	28480	1480-0116
A6MP2	4040-0754	1	1	EXTR-PC BD BLU POLYC .062-BD-THKNS	28480	4040-0754
	1480-0116	8		PIN-GRV .062-IN-DIA .25-IN-LG STL	28480	1480-0116
A6Q1	1854-0637	1	2	TRANSISTOR NPN 2N2219A SI TO-5 PD=800MW	01295	2N2219A
	0340-0834	0	4	INSULATOR-XSTR POLYI	28480	0340-0834
	1205-0095	0	4	HEAT SINK SGL TO-5/TO-39-CS	30161	3225B
A6Q2	1853-0314	9	2	TRANSISTOR PNP 2N2905A SI TO-39 PD=600MW	04713	2N2905A
	0340-0834	0		INSULATOR-XSTR POLYI	28480	0340-0834
	1205-0095	0		HEAT SINK SGL TO-5/TO-39-CS	30161	3225B

†Refer to Section 7 for update information.

*Factory Selected Component (Refer to Section 5).

Δ Errata part change.

Table 6-3. Replaceable Parts

Reference Designation	HP Part Number	C D	Qty.	Description	Mfr. Code	Mfr. Part Number
A6Q3	1853-0314	9		TRANSISTOR PNP 2N2905A SI TO-39 PD=600MW	04713	2N2905A
	0340-0834	0		INSULATOR-XSTR POLYI	28480	0340-0834
	1205-0095	0		HEAT SINK SGL TO-5/TO-39-CS	30161	3225B
A6Q4	1854-0637	1		TRANSISTOR NPN 2N2219A SI TO-5 PD=800MW	01295	2N2219A
	0340-0834	0		INSULATOR-XSTR POLYI	28480	0340-0834
	1205-0095	0		HEAT SINK SGL TO-5/TO-39-CS	30161	3225B
A6Q5	1855-0418	8		TRANSISTOR-JFET DUAL N-CHAN D-MODE SI	28480	1855-0418
A6R1	0698-3430	5		RESISTOR 21.5 1% .125W F TC=0+-100	03888	PME55-1/8-T0-21R5-F
A6R2	0698-3430	5		RESISTOR 21.5 1% .125W F TC=0+-100	03888	PME55-1/8-T0-21R5-F
A6R3				NOT ASSIGNED		
A6R4	0698-8822	9		RESISTOR 6.81 1% .125W F TC=0+-100	28480	0698-8822
A6R5	0698-8822	9		RESISTOR 6.81 1% .125W F TC=0+-100	28480	0698-8822
A6R6-R13				NOT ASSIGNED		
A6R14	0698-8812	7	3	RESISTOR 1 1% .125W F TC=0+-100	28480	0698-8812
A6R15				NOT ASSIGNED		
A6R16	0757-0401	0		RESISTOR 100 1% .125W F TC=0+-100	24546	C4-1/8-T0-101-F
A6R17-R19				NOT ASSIGNED		
A6R20	0698-8812	7		RESISTOR 1 1% .125W F TC=0+-100	28480	0698-8812
A6R21	0757-0401	0		RESISTOR 100 1% .125W F TC=0+-100	24546	C4-1/8-T0-101-F
A6R22	0698-7847	6	2	RESISTOR 1.111K .1% .125W F TC=0+-25	19701	MF4C1/8-T9-1111R-B
A6R23	0698-8812	7		RESISTOR 1 1% .125W F TC=0+-100	28480	0698-8812
A6R24	0698-6343	5		RESISTOR 9K .1% .125W F TC=0+-25	28480	0698-6343
A6R25	0698-6343	5		RESISTOR 9K .1% .125W F TC=0+-25	28480	0698-6343
A6R26	0698-6362	8		RESISTOR 1K .1% .125W F TC=0+-25	28480	0698-6362
A6R27	0698-3157	3		RESISTOR 19.6K 1% .125W F TC=0+-100	24546	C4-1/8-T0-1962-F
A6R28	0698-3157	3		RESISTOR 19.6K 1% .125W F TC=0+-100	24546	C4-1/8-T0-1962-F
A6R29	0757-0401	0		RESISTOR 100 1% .125W F TC=0+-100	24546	C4-1/8-T0-101-F
A6R30	0698-6362	8		RESISTOR 1K .1% .125W F TC=0+-25	28480	0698-6362
A6R31	0698-7847	6		RESISTOR 1.111K .1% .125W F TC=0+-25	19701	MF4C1/8-T9-1111R-B
A6R32	2100-3353	8	1	RESISTOR-TRMR 20K 10% C SIDE-ADJ 1-TRN	28480	2100-3353
A6R33	0698-8825	2		RESISTOR 681K 1% .125W F TC=0+-100	28480	0698-8825
A6R34-R45				NOT ASSIGNED		
A6R46	0698-6624	5	2	RESISTOR 2K 1% .125W F TC=0+-25	28480	0698-6624
A6R47	0699-1728	2	2	RESISTOR 2.652K .1% .12W	28480	0699-1728
A6R48	0698-6624	5		RESISTOR 2K 1% .125W F TC=0+-25	28480	0698-6624
A6R49	0699-1728	2		RESISTOR 2.652K .1% .12W	28480	0699-1728
A6R50	0757-0428	1		RESISTOR 1.62K 1% .125W F TC=0+-100	24546	C4-1/8-T0-1621-F
A6R51	0757-0428	1		RESISTOR 1.62K 1% .125W F TC=0+-100	24546	C4-1/8-T0-1621-F
A6R52	0698-3430	5		RESISTOR 21.5 1% .125W F TC=0+-100	03888	PME55-1/8-T0-21R5-F
A6R53	0698-3430	5		RESISTOR 21.5 1% .125W F TC=0+-100	03888	PME55-1/8-T0-21R5-F
A6R54	0699-1726	0	2	RESISTOR 1.150K .1% .12W	28480	0699-1726
A6R55	0698-6348	0		RESISTOR 3K .1% .125W F TC=0+-25	28480	0698-6348
A6R56	0698-6348	0		RESISTOR 3K .1% .125W F TC=0+-25	28480	0698-6348
A6R57	0698-6348	0		RESISTOR 3K .1% .125W F TC=0+-25	28480	0698-6348
A6R58	0698-6348	0		RESISTOR 3K .1% .125W F TC=0+-25	28480	0698-6348
A6R59	0698-3430	5		RESISTOR 21.5 1% .125W F TC=0+-100	03888	PME55-1/8-T0-21R5-F
A6R60	0698-3430	5		RESISTOR 21.5 1% .125W F TC=0+-100	03888	PME55-1/8-T0-21R5-F

†Refer to Section 7 for update information.

*Factory Selected Component (Refer to Section 5).

Δ Errata part change.

Table 6-3. Replaceable Parts

Reference Designation	HP Part Number	C D	Qty.	Description	Mfr. Code	Mfr. Part Number
A6R61	0699-1726	0		RESISTOR 1.150K .1% .12W	28480	0699-1726
A6R62-R65				NOT ASSIGNED		
A6R66	0757-0346	2	4	RESISTOR 10 1% .125W F TC=0+-100	24546	C4-1/8-T0-10R0-F
A6R67	0757-0346	2		RESISTOR 10 1% .125W F TC=0+-100	24546	C4-1/8-T0-10R0-F
A6R68	0757-0346	2		RESISTOR 10 1% .125W F TC=0+-100	24546	C4-1/8-T0-10R0-F
A6R69	0757-0346	2		RESISTOR 10 1% .125W F TC=0+-100	24546	C4-1/8-T0-10R0-F
A6R70	0811-3726	4	2	RESISTOR 25.42 .1% .75W	28480	0811-3726
A6R71	0811-3726	4	2	RESISTOR 25.42 .1% .75W	28480	0811-3726
A6R72-R74				NOT ASSIGNED		
A6R75	0811-3720	8	2	RESISTOR 40.91 .1% .4W	28480	0811-3720
A6R76	0811-3725	3		RESISTOR 10.10 .1% .4W	28480	0811-3725
A6R77	0811-3720	8	2	RESISTOR 40.91 .1% .4W	28480	0811-3720
A6R78-R81				NOT ASSIGNED		
A6R82	0757-0401	0		RESISTOR 100 1% .125W F TC=0+-100	24546	C4-1/8-T0-101-F
A6R83				NOT ASSIGNED		
A6R84	0757-0401	0		RESISTOR 100 1% .125W F TC=0+-100	24546	C4-1/8-T0-101-F
A6R85				NOT ASSIGNED		
A6R86				NOT ASSIGNED		
A6R87	0757-0464	5		RESISTOR 90 9K 1% .125W F TC=0+-100	24546	C4-1/8-T0-9092-F
A6R88	0757-0442	9		RESISTOR 10K 1% .125W F TC=0+-100	24546	C4-1/8-T0-1002-F
A6R89	0757-0280	3		RESISTOR 1K 1% .125W F TC=0+-100	24546	C4-1/8-T0-1001-F
A6R90	0698-8827	4		RESISTOR 1M 1% .125W F TC=0+-100	28480	0698-8827
2450A TO 2816A A6R91	0757-0123	3	2	RESISTOR 34.8K 1% .125W F TC=0+-100	28480	0757-0123
2818A AND ABOVE A6R91	0757-0199	3		RESISTOR 21.5K 1% .125W F TC=0+-100	24546	C4-1/8-T0-2152-F
A6R92	0698-8827	4		RESISTOR 1M 1% .125W F TC=0+-100	28480	0698-8827
2450A TO 2816A A6R93	0757-0123	3		RESISTOR 34.8K 1% .125W F TC=0+-100	28480	0757-0123
2818A AND ABOVE A6R93	0757-0199	3		RESISTOR 21.5K 1% .125W F TC=0+-100	24546	C4-1/8-T0-2152-F
2450A TO 2816A A6R94	0757-0278	9		RESISTOR 1.78K 1% .125W F TC=0+-100	24546	C4-1/8-T0-1781-F
A6R95	0757-0278	9		RESISTOR 1.78K 1% .125W F TC=0+-100	24546	C4-1/8-T0-1781-F
2818A AND ABOVE A6R94	0698-0085	0		RESISTOR 2.61K 1% .125 F TC=0+-100	24546	C4-1/8-T0-2611-F
A6R95	0698-0085	0		RESISTOR 2.61K 1% .125 F TC=0+-100	24546	C4-1/8-T0-2611-F
A6R96	0757-0394	0		RESISTOR 51.1 1% .125W F TC=0+-100	24546	C4-1/8-T0-51R1-F
A6R97	0757-0394	0		RESISTOR 51.1 1% .125W F TC=0+-100	24546	C4-1/8-T0-51R1-F
A6R98	0757-0442	9		RESISTOR 10K 1% .125W F TC=0+-100	24546	C4-1/8-T0-1002-F
A6R99	0698-8821	8	4	RESISTOR 5.62 1% .125W F TC=0+-100	28480	0698-8821
A6R100	0698-8821	8		RESISTOR 5.62 1% .125W F TC=0+-100	28480	0698-8821
A6R101	0698-8821	8		RESISTOR 5.62 1% .125W F TC=0+-100	28480	0698-8821
A6R102	0698-8821	8		RESISTOR 5.62 1% .125W F TC=0+-100	28480	0698-8821
A6R103	0699-1727	1	1	RESISTOR 550 .1% .25W	28480	0699-1727
A6TP1	1251-0600	0		CONNECTOR-SGL CONT PIN 1.14-MM-BSC-SZ SQ	28480	1251-0600
A6TP2	1251-0600	0		CONNECTOR-SGL CONT PIN 1.14-MM-BSC-SZ SQ	28480	1251-0600
A6TP3	1251-0600	0		CONNECTOR-SGL CONT PIN 1.14-MM-BSC-SZ SQ	28480	1251-0600
A6TP4	1251-0600	0		CONNECTOR-SGL CONT PIN 1.14-MM-BSC-SZ SQ	28480	1251-0600
A6TP5	1251-0600	0		CONNECTOR-SGL CONT PIN 1.14-MM-BSC-SZ SQ	28480	1251-0600

†Refer to Section 7 for update information.

*Factory Selected Component (Refer to Section 5).

Δ Errata part change.

Table 6-3. Replaceable Parts

Reference Designation	HP Part Number	C D	Qty.	Description	Mfr. Code	Mfr. Part Number
A6TP6	1251-0600	0		CONNECTOR-SGL CONT PIN 1 14-MM-BSC-SZ SQ	28480	1251-0600
A6TP7	1251-0600	0		CONNECTOR-SGL CONT PIN 1 14-MM-BSC-SZ SQ	28480	1251-0600
A6U1	1826-0783	9		IC OP AMP LOW-NOISE 8-DIP-C PKG	52063	XR5534ACN
A6U2	1826-0783	9		IC OP AMP LOW-NOISE 8-DIP-C PKG	52063	XR5534ACN
A6U3	1826-0783	9		IC OP AMP LOW-NOISE 8-DIP-C PKG	52063	XI75534ACN
A6U4	1820-0535	7	1	IC DRVR TTL AND DUAL 2-INP	01295	SN75451BP
A6U5	1826-0606	5	1	IC SWITCH ANLG QUAD 16 DIP-C PKG	17856	DG201BK
A6U6	1826-0783	9		IC OP AMP LOW-NOISE 8-DIP-C PKG	52063	XR5534ACN
A6U7	1826-0180	0	1	IC TIMER TTL MONO/ASTBL	01295	NE555P
A6U8	1826-0759	9		IC COMPARATOR GP QUAD 14-DIP-C PKG	04713	LM339J
A6U9	1826-0783	9		IC OP AMP LOW-NOISE 8-DIP-C PKG	52063	XR5534ACN
A6U10	1826-0921	7	2	D/A 10-BIT 16-CBRZ/SDR CMOS	28480	1826-0921
A6U11	08903-80013	7	1	PROM 1816-0916	28480	08903-80013
A6U12	08903-80014	8	1	PROM 1816-0916	28480	08903-80014
A6U13	1826-0921	7		D/A 10-BIT 16-CBRZ/SDR CMOS	28480	1826-0921
A6U14	1820-1197	9	4	IC GATE TTL LS NAND QUAD 2-INP	01295	SN74LS00N
A6VR1	1902-1397	5	2	DIODE-ZNR 12V 5%	28480	1902-1397
A6VR2	1902-1397	5		DIODE-ZNR 12V 5%	28480	1902-1397
A6VR3	1902-0966	2	1	DIODE-ZNR 22V 5% DO-35 PD= 4W TC= + 093%	28480	1902-0966
A6VR4-VR6				NOT ASSIGNED		
A6VR7	1902-0962	8	1	DIODE-ZNR 15V 5% DO-35 PD= 4W TC= + 087%	28480	1902-0962
A6W1	8159-0005	0		RESISTOR-ZERO OHMS 22 AWG LEAD DIA	28480	8159-0005
A6W2	8159-0005	0		RESISTOR-ZERO OHMS 22 AWG LEAD DIA	28480	8159-0005

†Refer to Section 7 for update information.

*Factory Selected Component (Refer to Section 5).

Δ Errata part change.

Table 6-3. Replaceable Parts

Reference Designation	HP Part Number	C D	Qty.	Description	Mfr. Code	Mfr. Part Number
A7						
A7	08903-60130	7	1	LATCH ASSEMBLY	28480	08903-60130
A7C1	0180-0116	1		CAPACITOR-FXD 6.8UF + -10% 35VDC TA	56289	150D685X9035B2
A7C2	0180-0229	7		CAPACITOR-FXD 33UF + -10% 10VDC TA	56289	150D336X9010B2
A7C3	0160-4832	4		CAPACITOR-FXD .01UF + -10% 100VDC CER	28480	0160-4832
A7C4	0160-4832	4		CAPACITOR-FXD .01UF + -10% 100VDC CER	28480	0160-4832
A7C5	0180-0116	1		CAPACITOR-FXD 6.8UF + -10% 35VDC TA	56289	150D685X9035B2
A7C6	0160-4832	4		CAPACITOR-FXD .01UF + -10% 100VDC CER	28480	0160-4832
A7C7	0160-4832	4		CAPACITOR-FXD .01UF + -10% 100VDC CER	28480	0160-4832
A7C8	0160-4832	4		CAPACITOR-FXD .01UF + -10% 100VDC CER	28480	0160-4832
A7C9	0160-4832	4		CAPACITOR-FXD .01UF + -10% 100VDC CER	28480	0160-4832
A7C10	0160-4832	4		CAPACITOR-FXD .01UF + -10% 100VDC CER	28480	0160-4832
A7C11	0160-4832	4		CAPACITOR-FXD .01UF + -10% 100VDC CER	28480	0160-4832
A7C12	0160-4832	4		CAPACITOR-FXD .01UF + -10% 100VDC CER	28480	0160-4832
A7C13	0160-4832	4		CAPACITOR-FXD .01UF + -10% 100VDC CER	28480	0160-4832
A7C14	0160-4832	4		CAPACITOR-FXD .01UF + -10% 100VDC CER	28480	0160-4832
A7C15	0160-4832	4		CAPACITOR-FXD .01UF + -10% 100VDC CER	28480	0160-4832
A7C16	0160-4832	4		CAPACITOR-FXD .01UF + -10% 100VDC CER	28480	0160-4832
A7C17	0160-4832	4		CAPACITOR-FXD .01UF + -10% 100VDC CER	28480	0160-4832
A7C18	0160-4832	4		CAPACITOR-FXD .01UF + -10% 100VDC CER	28480	0160-4832
A7C19	0180-0376	5	7	CAPACITOR-FXD .47UF + -10% 35VDC TA	56289	150D474X9035A2
A7C20	0180-0376	5		CAPACITOR-FXD .47UF + -10% 35VDC TA	56289	150D474X9035A2
A7C21	0160-4822	2	2	CAPACITOR-FXD 1000PF + -5% 100VDC CER	28480	0160-4822
A7C22	0160-4822	2		CAPACITOR-FXD 1000PF + -5% 100VDC CER	28480	0160-4822
A7C23	0180-2249	5	2	CAPACITOR-FXD 47UF + -10% 20VDC TA	56289	150D476X9020R2
A7C24	0180-2249	5		CAPACITOR-FXD 47UF + -10% 20VDC TA	56289	150D476X9020R2
A7C25	0180-0376	5		CAPACITOR-FXD .47UF + -10% 35VDC TA	56289	150D474X9035A2
A7C26	0180-0376	5		CAPACITOR-FXD .47UF + -10% 35VDC TA	56289	150D474X9035A2
A7C27	0180-0376	5		CAPACITOR-FXD .47UF + -10% 35VDC TA	56289	150D474X9035A2
A7C28	0180-0116	1		CAPACITOR-FXD 6.8UF + -10% 35VDC TA	56289	150D685X9035B2
A7C29	0180-0116	1		CAPACITOR-FXD 6.8UF + -10% 35VDC TA	56289	150D685X9035B2
A7C30	0160-4789	0		CAPACITOR-FXD 15PF + -5% 100VDC CER 0 + -30	28480	0160-4789
A7C31	0180-0376	5		CAPACITOR-FXD .47UF + -10% 35VDC TA	56289	150D474X9035A2
A7C32	0180-0376	5		CAPACITOR-FXD .47UF + -10% 35VDC TA	56289	150D474X9035A2
A7CR1	1901-0040	1		DIODE-SWITCHING 30V 50MA 2NS DO-35	28480	1901-0040
A7CR2	1901-0040	1		DIODE-SWITCHING 30V 50MA 2NS DO-35	28480	1901-0040
A7CR3	1901-0050	3		DIODE-SWITCHING 80V 200MA 2NS DO-35	28480	1901-0050
A7CR4	1901-0050	3		DIODE-SWITCHING 80V 200MA 2NS DO-35	28480	1901-0050
A7CR5	1901-0050	3		DIODE-SWITCHING 80V 200MA 2NS DO-35	28480	1901-0050
A7CR6	1901-0050	3		DIODE-SWITCHING 80V 200MA 2NS DO-35	28480	1901-0050
A7CR7	1906-0042	3	1	DIODE-DUAL 70V VF DIFF = 10MV	28480	1906-0042
A7CR8 ^Δ	1906-0388	0	1	DIODE-DUAL 50V 200MA VF DIFF = 3MV	02037	MSD6101
A7CR9	1901-0050	3		DIODE-SWITCHING 80V 200MA 2NS DO-35	28480	1901-0050
A7CR10	1901-0050	3		DIODE-SWITCHING 80V 200MA 2NS DO-35	28480	1901-0050
A7CR11	1901-0050	3		DIODE-SWITCHING 80V 200MA 2NS DO-35	28480	1901-0050
A7CR12	1901-0050	3		DIODE-SWITCHING 80V 200MA 2NS DO-35	28480	1901-0050

†Refer to Section 7 for update information.

*Factory Selected Component (Refer to Section 5).

Δ Errata part change.

Table 6-3. Replaceable Parts

Reference Designation	HP Part Number	C D	Qty.	Description	Mfr. Code	Mfr. Part Number
A7MP1	4040-0748	3		EXTR-PC BD BLK POLYC .062-BD-THKNS	28480	4040-0748
	1480-0116	8		PIN-GRV .062-IN-DIA .25-IN-LG STL	28480	1480-0116
A7MP2	4040-0755	2	1	EXTR-PC BD VIO POLYC .062-BD-THKNS	28480	4040-0755
	1480-0116	8		PIN-GRV .062-IN-DIA .25-IN-LG STL	28480	1480-0116
A7R1				NOT ASSIGNED		
A7R2	0757-0442	9		RESISTOR 10K 1% .125W F TC=0+-100	24546	C4-1/8-T0-1002-F
A7R3	1810-0205	7	1	NETWORK-RES 8-SIP4.7K OHM X 7	01121	208A472
A7R4				NOT ASSIGNED		
A7R5	0698-3155	1	1	RESISTOR 4.84K 1% .125W F TC=0+-100	24546	C4-1/8-T0-4841-F
A7R6	0757-0465	6		RESISTOR 100K 1% .125W F TC=0+-100	24546	C4-1/8-T0-1003-F
A7R7	0757-0465	6		RESISTOR 100K 1% .125W F TC=0+-100	24546	C4-1/8-T0-1003-F
A7R8*	0757-0440	7	7	RESISTOR 7.5K 1% .125W F TC=0+-100	24546	C4-1/8-T0-7501-F
A7R9	0757-0440	7		RESISTOR 7.5K 1% .125W F TC=0+-100	24546	C4-1/8-T0-7501-F
A7R10*	0757-0440	7		RESISTOR 7.5K 1% .125W F TC=0+-100	24546	C4-1/8-T0-7501-F
A7R11	0757-0440	7		RESISTOR 7.5K 1% .125W F TC=0+-100	24546	C4-1/8-T0-7501-F
A7R12	0698-6320	8		RESISTOR 5K .1% .125W F TC=0+-100	03888	PME55-1/8-T9-5001-B
A7R13	0698-6320	8		RESISTOR 5K .1% .125W F TC=0+-100	03888	PME55-1/8-T0-5001-B
A7R14	0698-3157	3		RESISTOR 19.6K 1% .125W F TC=0+-100	24546	C4-1/8-T0-1962-F
A7R15	0675-1021	8	2	RESISTOR 1K 10% .125W CC TC=-330/+800	01121	BB1021
A7R16	0675-1021	8		RESISTOR 1K 10% .125W CC TC=-330/+800	01121	BB1021
A7R17	0757-0438	3		RESISTOR 5.11K 1% .125W F TC=0+-100	24546	C4-1/8-T0-5111-F
A7R18	0757-0438	3		RESISTOR 5.11K 1% .125W F TC=0+-100	24546	C4-1/8-T0-5111-F
A7R19	0757-0438	3		RESISTOR 5.11K 1% .125W F TC=0+-100	24546	C4-1/8-T0-5111-F
A7R20	0757-0438	3		RESISTOR 5.11K 1% .125W F TC=0+-100	24546	C4-1/8-T0-5111-F
A7R21	0757-0438	3		RESISTOR 5.11K 1% .125W F TC=0+-100	24546	C4-1/8-T0-5111-F
A7R22	0699-0070	5	2	RESISTOR 3.16M 1% .125W F TC=0+-100	28480	0699-0070
A7R23	0699-0070	5		RESISTOR 3.16M 1% .125W F TC=0+-100	28480	0699-0070
A7R24	0757-0438	3		RESISTOR 5.11K 1% .125W F TC=0+-100	24546	C4-1/8-T0-5111-F
A7R25	0757-0438	3		RESISTOR 5.11K 1% .125W F TC=0+-100	24546	C4-1/8-T0-5111-F
A7R26	0757-0438	3		RESISTOR 5.11K 1% .125W F TC=0+-100	24546	C4-1/8-T0-5111-F
A7R27	0757-0438	3		RESISTOR 5.11K 1% .125W F TC=0+-100	24546	C4-1/8-T0-5111-F
A7R28	0683-1015	7	1	RESISTOR 100 5% .25W FC TC=-400/+500	01121	CB1015
A7TP1	1251-0600	0		CONNECTOR-SGL CONT PIN 1.14-MM-BSC-SZ SQ	28480	1251-0600
A7TP2	1251-0600	0		CONNECTOR-SGL CONT PIN 1.14-MM-BSC-SZ SQ	28480	1251-0600
A7TP3	1251-0600	0		CONNECTOR-SGL CONT PIN 1.14-MM-BSC-SZ SQ	28480	1251-0600
A7TP4	1251-0600	0		CONNECTOR-SGL CONT PIN 1.14-MM-BSC-SZ SQ	28480	1251-0600
A7TP5	1251-0600	0		CONNECTOR-SGL CONT PIN 1.14-MM-BSC-SZ SQ	28480	1251-0600
A7TP6	1251-0600	0		CONNECTOR-SGL CONT PIN 1.14-MM-BSC-SZ SQ	28480	1251-0600
A7U1	1820-1197	9		IC GATE TTL LS NAND QUAD 2-INP	01295	SN74LS00N
A7U2	1826-0138	8		IC COMPARATOR GP QUAD 14-DIP-P PKG	01295	LM339N
A7U3	1826-0323	3	1	IC OP AMP GP QUAD 14-DIP-C PKG	28480	1826-0323
A7U4	1826-0188	8	2	IC CONV 8-B-D/A 16-DIP-C PKG	04713	MC1408L-8
A7U5	1820-1729	3	12	IC LCH TTL LS COM CLEAR 8-BIT	01295	SN74LS259N
A7U6	1820-1729	3		IC LCH TTL LS COM CLEAR 8-BIT	01295	SN74LS259N
A7U7	1820-1216	3	4	IC DCDR TTL LS 3-TO-8-LINE 3-INP	01295	SN74LS138N
A7U8	1820-1211	8	1	IC GATE TTL LS EXCL-OR QUAD 2-INP	01295	SN74LS86N
A7U9	1820-1195	7	3	IC FF TTL LS D-TYPE POS-EDGE-TRIG COM	01295	SN74LS175N
A7U10	1820-1195	7		IC FF TTL LS D-TYPE POS-EDGE-TRIG COM	01295	SN74LS175N

†Refer to Section 7 for update information.

*Factory Selected Component (Refer to Section 5).

△ Errata part change.

Table 6-3. Replaceable Parts

Reference Designation	HP Part Number	C D	Qty.	Description	Mfr. Code	Mfr. Part Number
A7U11	1820-1195	7		IC FF TTL LS D-TYPE POS-EDGE-TRIG COM	01295	SN74LS175N
A7U12	1820-1112	8	7	IC FF TTL LS D-TYPE POS-EDGE-TRIG	01295	SN74LS74AN
A7U13	1820-1112	8		IC FF TTL LS D-TYPE POS-EDGE-TRIG	01295	SN74LS74AN
A7U14	1820-1112	8		IC FF TTL LS D-TYPE POS-EDGE-TRIG	01295	SN74LS74AN
A7U15	1820-0269	4	1	IC GATE TTL NAND QUAD 2-INP	01295	SN7403N
A7U16	1820-1197	9		IC GATE TTL LS NAND QUAD 2-INP	01295	SN74LS00N
A7U17	1826-0371	1		IC OP AMP LOW-BIAS-H-IMPD TO-99 PKG	27014	LF256H
A7U18	1826-1018	5	1	ANALOG-SWITCH 4SPST 16-DIP-P	28480	1826-1018
A7U19	1826-0188	8		IC CONV 8-B-D/A 16-DIP-C PKG	04713	MC1408L-8
A7U20	1820-1729	3		IC LCH TTL LS COM CLEAR 8-BIT	01295	SN74LS259N
A7U21	1820-1729	3		IC LCH TTL LS COM CLEAR 8-BIT	01295	SN74LS259N
A7U22	1820-1729	3		IC LCH TTL LS COM CLEAR 8-BIT	01295	SN74LS259N
A7U23	1820-1729	3		IC LCH TTL LS COM CLEAR 8-BIT	01295	SN74LS259N
A7U24	1820-1729	3		IC LCH TTL LS COM CLEAR 8-BIT	01295	SN74LS259N
A7U25	1820-1729	3		IC LCH TTL LS COM CLEAR 8-BIT	01295	SN74LS259N
A7U26	1820-1729	3		IC LCH TTL LS COM CLEAR 8-BIT	01295	SN74LS259N
A7U27	1820-1729	3		IC LCH TTL LS COM CLEAR 8-BIT	01295	SN74LS259N
A7U28	1820-1729	3		IC LCH TTL LS COM CLEAR 8-BIT	01295	SN74LS259N
A7U29	1820-1729	3		IC LCH TTL LS COM CLEAR 8-BIT	01295	SN74LS259N
A7U30	1820-1199	1	4	IC INV TTL LS HEX 1-INP	01295	SN74LS04N

†Refer to Section 7 for update information.

*Factory Selected Component (Refer to Section 5).

△ Errata part change.

Table 6-3. Replaceable Parts

Reference Designation	HP Part Number	C D	Qty.	Description	Mfr. Code	Mfr. Part Number
A8 08903-60134 – SERIAL PREFIX 2450A TO 2614A						
A8	08903-60134	1	1	CONTROLLER/COUNTER ASSEMBLY	28480	08903-60134
A8C1	0160-2055	9		CAPACITOR-FXD .01UF +80-20% 100VDC CER	28480	0160-2055
A8C2	0160-2055	9		CAPACITOR-FXD .01UF +80-20% 100VDC CER	28480	0160-2055
A8C3	0160-2055	9		CAPACITOR-FXD .01UF +80-20% 100VDC CER	28480	0160-2055
A8C4	0160-2055	9		CAPACITOR-FXD .01UF +80-20% 100VDC CER	28480	0160-2055
A8C5	0160-2055	9		CAPACITOR-FXD .01UF +80-20% 100VDC CER	28480	0160-2055
A8C6	0160-2055	9		CAPACITOR-FXD .01UF +80-20% 100VDC CER	28480	0160-2055
A8C7	0160-2055	9		CAPACITOR-FXD .01UF +80-20% 100VDC CER	28480	0160-2055
A8C8	0160-2055	9		CAPACITOR-FXD .01UF +80-20% 100VDC CER	28480	0160-2055
A8C9	0160-2055	9		CAPACITOR-FXD .01UF +80-20% 100VDC CER	28480	0160-2055
A8C10	0160-2055	9		CAPACITOR-FXD .01UF +80-20% 100VDC CER	28480	0160-2055
A8C11	0160-2055	9		CAPACITOR-FXD .01UF +80-20% 100VDC CER	28480	0160-2055
A8C12	0160-2055	9		CAPACITOR-FXD .01UF +80-20% 100VDC CER	28480	0160-2055
A8C13	0160-3456	6		CAPACITOR-FXD 1000PF +-10% 1KVDC CER	28480	0160-3456
A8C14	0160-3456	6		CAPACITOR-FXD 1000PF +-10% 1KVDC CER	28480	0160-3456
A8C15	0180-0197	8		CAPACITOR-FXD 2.2UF +-10% 20VDC TA	56289	150D225X9020A2
A8C16	0180-0229	7		CAPACITOR-FXD 33UF +-10% 10VDC TA	56289	150D336X9010B2
A8C17	0180-0197	8		CAPACITOR-FXD 2.2UF +-10% 20VDC TA	56289	150D225X9020A2
A8C18	0180-0197	8		CAPACITOR-FXD 2.2UF +-10% 20VDC TA	56289	150D225X9020A2
A8C19	0180-0197	8		CAPACITOR-FXD 2.2UF +-10% 20VDC TA	56289	150D225X9020A2
A8C20	0160-2055	9		CAPACITOR-FXD .01UF +80-20% 100VDC CER	28480	0160-2055
A8C21	0160-2055	9		CAPACITOR-FXD .01UF +80-20% 100VDC CER	28480	0160-2055
A8C22	0160-2055	9		CAPACITOR-FXD .01UF +80-20% 100VDC CER	28480	0160-2055
A8C23				NOT ASSIGNED		
A8C24	0160-2055	9		CAPACITOR-FXD .01UF +80-20% 100VDC CER	28480	0160-2055
A8C25	0160-2264	2		CAPACITOR-FXD 20PF +-5% 500VDC CER 0+-30	28480	0160-2264
A8C26	0160-4789	0	1	CAPACITOR-FXD 15PF +-5% 100VDC CER 0+-30	28480	0160-4789
A8C27	0121-0436	4	1	CAPACITOR-V TRMR-AIR 2 6-23.5PF 350V	74970	189-0309-125
A8C28	0160-2055	9		CAPACITOR-FXD .01UF +80-20% 100VDC CER	28480	0160-2055
A8C29	0180-0553	0	1	CAPACITOR-FXD 22UF +-20% 25VDC TA	28480	0180-0553
A8C30	0160-2055	9		CAPACITOR-FXD .01UF +80-20% 100VDC CER	28480	0160-2055
A8C31	0160-2055	9		CAPACITOR-FXD .01UF +80-20% 100VDC CER	28480	0160-2055
A8C32	0160-2055	9		CAPACITOR-FXD .01UF +80-20% 100VDC CER	28480	0160-2055
A8C33	0160-2055	9		CAPACITOR-FXD .01UF +80-20% 100VDC CER	28480	0160-2055
A8C34	0160-2055	9		CAPACITOR-FXD .01UF +80-20% 100VDC CER	28480	0160-2055
A8C35				NOT ASSIGNED		
A8C36	0160-2055	9		CAPACITOR-FXD .01UF +80-20% 100VDC CER	28480	0160-2055
A8C37	0180-1745	4	1	CAPACITOR-FXD 1.5UF +-10% 20VDC TA	56289	150D155X9020A2
A8CR1	1901-0050	3		DIODE-SWITCHING 80V 200MA 2NS DO-35	28480	1901-0050
A8CR2	1901-0050	3		DIODE-SWITCHING 80V 200MA 2NS DO-35	28480	1901-0050
A8CR3	1901-0050	3		DIODE-SWITCHING 80V 200MA 2NS DO-35	28480	1901-0050
A8CR4	1901-0050	3		DIODE-SWITCHING 80V 200MA 2NS DO-35	28480	1901-0050
A8CR5	1901-0050	3		DIODE-SWITCHING 80V 200MA 2NS DO-35	28480	1901-0050
A8CR6	1901-0050	3		DIODE-SWITCHING 80V 200MA 2NS DO-35	28480	1901-0050
A8CR7	1901-0050	3		DIODE-SWITCHING 80V 200MA 2NS DO-35	28480	1901-0050
A8CR8	1901-0050	3		DIODE-SWITCHING 80V 200MA 2NS DO-35	28480	1901-0050
A8CR9	1901-0539	3	1	DIODE-SM SIG SCHOTTKY	28480	1901-0539

†Refer to Section 7 for update information.

*Factory Selected Component (Refer to Section 5).

Δ Errata part change.

Table 6-3. Replaceable Parts

Reference Designation	HP Part Number	C D	Qty.	Description	Mfr. Code	Mfr. Part Number
A8 08903-60134 – SERIAL PREFIX 2450A TO 2614A						
A8DS1	1990-0524	3	4	LED-LAMP LUM-INT=1MCD IF=20MA-MAX BVR=5V	28480	5082-4550
A8DS2	1990-0524	3		LED-LAMP LUM-INT=1MCD IF=20MA-MAX BVR=5V	28480	5082-4550
A8DS3	1990-0524	3		LED-LAMP LUM-INT=1MCD IF=20MA-MAX BVR=5V	28480	5082-4550
A8DS4	1990-0524	3		LED-LAMP LUM-INT=1MCD IF=20MA-MAX BVR=5V	28480	5082-4550
A8J1	1200-0507	9	1	SOCKET-IC 16-CONT DIP-SLDR	28480	1200-0507
A8MP1	4040-0748	3		EXTR-PC BD BLK POLYC .062-BD-THKNS	28480	4040-0748
	1480-0116	8		PIN-GRV .062-IN-DIA .25-IN-LG STL	28480	1480-0116
A8MP2	4040-0747	2	1	EXTR-PC BD GRA POLYC .062-BD-THKNS	28480	4040-0747
	1480-0116	8		PIN-GRV .062-IN-DIA .25-IN-LG STL	28480	1480-0116
A8MP3	08903-00060	6	1	LBL-BD 03E MON	28480	08903-00060
A8Q1	1854-0810	2	1	TRANSISTOR NPN SI PD=623MW FT=200MHZ	28480	1854-0810
A8R1	0757-0401	0		RESISTOR 100 1% .125W F TC=0+-100	24546	C4-1/B-T0-101-F
A8R2	0698-3440	7	1	RESISTOR 196 1% .125W F TC=0+-100	24546	C4-1/B-T0-196R-F
A8R3	1810-0055	5	1	NETWORK-RES 9-SIP10 0K OHM X 8	28480	1810-0055
A8R4	0757-0442	9		RESISTOR 10K 1% .125W F TC=0+-100	24546	C4-1/B-T0-1002-F
A8R5	0757-0442	9		RESISTOR 10K 1% .125W F TC=0+-100	24546	C4-1/B-T0-1002-F
A8R6	0757-0442	9		RESISTOR 10K 1% .125W F TC=0+-100	24546	C4-1/B-T0-1002-F
A8R7	1810-0363	8	1	NETWORK-RES 6-SIP330 0 OHM X 5	01121	206A331
A8R8	0757-0442	9		RESISTOR 10K 1% .125W F TC=0+-100	24546	C4-1/B-T0-1002-F
A8R9	0757-0442	9		RESISTOR 10K 1% .125W F TC=0+-100	24546	C4-1/B-T0-1002-F
A8R10	0757-0442	9		RESISTOR 10K 1% .125W F TC=0+-100	24546	C4-1/B-T0-1002-F
A8R11	0757-0442	9		RESISTOR 10K 1% .125W F TC=0+-100	24546	C4-1/B-T0-1002-F
A8R12	0757-0442	9		RESISTOR 10K 1% .125W F TC=0+-100	24546	C4-1/B-T0-1002-F
A8R13	0757-0459	7		RESISTOR 51.1K 1% .125W F TC=0+-100	24546	C4-1/B-T0-5112-F
A8TP1	1251-0600	0		CONNECTOR-SGL CONT PIN 1.14-MM-BSC-SZ SQ	28480	1251-0600
A8TP2	1251-0600	0		CONNECTOR-SGL CONT PIN 1.14-MM-BSC-SZ SQ	28480	1251-0600
A8TP3	1251-0600	0		CONNECTOR-SGL CONT PIN 1.14-MM-BSC-SZ SQ	28480	1251-0600
A8TP4	1251-0600	0		CONNECTOR-SGL CONT PIN 1.14-MM-BSC-SZ SQ	28480	1251-0600
A8TP5	1251-0600	0		CONNECTOR-SGL CONT PIN 1.14-MM-BSC-SZ SQ	28480	1251-0600
A8TP6	1251-0600	0		CONNECTOR-SGL CONT PIN 1.14-MM-BSC-SZ SQ	28480	1251-0600
A8TP7	1251-0600	0		CONNECTOR-SGL CONT PIN 1.14-MM-BSC-SZ SQ	28480	1251-0600
A8TP8	1251-0600	0		CONNECTOR-SGL CONT PIN 1.14-MM-BSC-SZ SQ	28480	1251-0600
A8TP9	1251-0600	0		CONNECTOR-SGL CONT PIN 1.14-MM-BSC-SZ SQ	28480	1251-0600
A8TP10	1251-0600	0		CONNECTOR-SGL CONT PIN 1.14-MM-BSC-SZ SQ	28480	1251-0600
A8TP11	1251-0600	0		CONNECTOR-SGL CONT PIN 1.14-MM-BSC-SZ SQ	28480	1251-0600
A8TP12	1251-0600	0		CONNECTOR-SGL CONT PIN 1.14-MM-BSC-SZ SQ	28480	1251-0600
A8TP13	1251-0600	0		CONNECTOR-SGL CONT PIN 1.14-MM-BSC-SZ SQ	28480	1251-0600
A8TP14	1251-0600	0		CONNECTOR-SGL CONT PIN 1.14-MM-BSC-SZ SQ	28480	1251-0600
A8TP15	1251-0600	0		CONNECTOR-SGL CONT PIN 1.14-MM-BSC-SZ SQ	28480	1251-0600
A8TP16	1251-0600	0		CONNECTOR-SGL CONT PIN 1.14-MM-BSC-SZ SQ	28480	1251-0600
A8TP17	1251-0600	0		CONNECTOR-SGL CONT PIN 1.14-MM-BSC-SZ SQ	28480	1251-0600
A8TP18	1251-0600	0		CONNECTOR-SGL CONT PIN 1.14-MM-BSC-SZ SQ	28480	1251-0600
A8U1	1820-1193	5	4	IC CNTR TTL LS BIN ASYNCHRO	01295	SN74LS197N
A8U2	1820-1193	5		IC CNTR TTL LS BIN ASYNCHRO	01295	SN74LS197N
A8U3	1820-1201	6	1	IC GATE TTL LS AND QUAD 2-INP	01295	SN74LS08N
A8U4	1820-1197	9		IC GATE TTL LS NAND QUAD 2-INP	01295	SN74LS00N
A8U5	1820-1928	4	1	IC FB-MPU; CLK FREQ=2 MHZ	28480	1820-1928
	1200-0654	7	3	SOCKET-IC 40-CONT DIP DIP-SLDR	28480	1200-0654
A8U6	1820-2027	6	1	IC-STATIC MEMORY INTERFACE	28480	1820-2027
	1200-0654	7		SOCKET-IC 40-CONT DIP DIP-SLDR	28480	1200-0654
A8U7	1820-1417	6	4	IC GATE TTL LS NAND QUAD 2-INP	01295	SN74LS26N
	1200-0638	7	2	SOCKET-IC 14-CONT DIP DIP-SLDR	28480	1200-0638

†Refer to Section 7 for update information.

*Factory Selected Component (Refer to Section 5).

Δ Errata part change.

Table 6-3. Replaceable Parts

Reference Designation	HP Part Number	C D	Qty.	Description	Mfr. Code	Mfr. Part Number
A8 08903-60134 – SERIAL PREFIX 2450A TO 2614A						
<i>2450A TO 2520A</i>						
<i>A8U8</i>	08903-80017	1	1	ROM-PROG #2	28480	08903-80017
	1200-0541	1		SOCKET-IC 24-CONT DIP DIP-SLDR	28480	1200-0541
<i>A8U9</i>	08903-80016	0	1	ROM-PROG #1	28480	08903-80016
	1200-0541	1		SOCKET-IC 24-CONT DIP DIP-SLDR	28480	1200-0541
<i>A8U10</i>	08903-80018	2	1	ROM-PROG #3	28480	08903-80018
	1200-0541	1		SOCKET-IC 24-CONT DIP DIP-SLDR	28480	1200-0541
<i>A8U11</i>	08903-80019	3	1	ROM-PROG #4	28480	08903-80019
	1200-0541	1		SOCKET-IC 24-CONT DIP DIP-SLDR	28480	1200-0541
<i>A8U12</i>	08903-80022	8	1	ROM-PROG #7	28480	08903-80022
	1200-0541	1		SOCKET-IC 24-CONT DIP DIP-SLDR	28480	1200-0541
<i>A8U13</i>	08903-80021	7	1	ROM-PROG #6	28480	08903-80021
	1200-0541	1		SOCKET-IC 24-CONT DIP DIP-SLDR	28480	1200-0541
<i>2537A TO 2611A</i>						
<i>A8U8</i>	1818-3742	9	1	ROM-PROG #2	28480	1818-3742
	1200-0541	1		SOCKET-IC 24-CONT DIP DIP-SLDR	28480	1200-0541
<i>A8U9</i>	1818-3741	8	1	ROM-PROG #1	28480	1818-3741
	1200-0541	1		SOCKET-IC 24-CONT DIP DIP-SLDR	28480	1200-0541
<i>A8U10</i>	1818-3743	0	1	ROM-PROG #3	28480	1818-3743
	1200-0541	1		SOCKET-IC 24-CONT DIP DIP-SLDR	28480	1200-0541
<i>A8U11</i>	1818-3744	1	1	ROM-PROG #4	28480	1818-3744
	1200-0541	1		SOCKET-IC 24-CONT DIP DIP-SLDR	28480	1200-0541
<i>A8U12</i>	1818-3747	4	1	ROM-PROG #7	28480	1818-3747
	1200-0541	1		SOCKET-IC 24-CONT DIP DIP-SLDR	28480	1200-0541
<i>A8U13</i>	1818-3746	3	1	ROM-PROG #6	28480	1818-3746
<i>A8U14</i>	1820-1193	5		IC CNTR TTL LS BIN ASYNCHRO	01295	SN74LS197N
<i>A8U15</i>	1820-1193	5		IC CNTR TTL LS BIN ASYNCHRO	01295	SN74LS197N
<i>A8U16</i>	1820-1287	8	1	IC BFR TTL LS NAND QUAD 2-INP	01295	SN74LS37N
<i>A8U17</i>	1820-1417	6		IC GATE TTL LS NAND QUAD 2-INP	01295	SN74LS26N
	1200-0638	7		SOCKET-IC 14-CONT DIP DIP-SLDR	28480	1200-0638
<i>A8U18</i>	1820-1199	1		IC INV TTL LS HEX 1-INP	01295	SN74LS04N
<i>A8U19</i>	1820-1202	7		IC GATE TTL LS NAND TPL 3-INP	01295	SN74LS10N
<i>A8U20</i>	1820-1199	1		IC INV TTL LS HEX 1-INP	01295	SN74LS04N
<i>A8U21</i>	1820-1216	3		IC DCDR TTL LS 3-TO-8-LINE 3-INP	01295	SN74LS138N
<i>A8U22</i>	1820-1216	3		IC DCDR TTL LS 3-TO-8-LINE 3-INP	01295	SN74LS138N
<i>A8U23</i>	1820-0174	0	1	IC INV TTL HEX	01295	SN7404N
<i>A8U24</i>	1820-1418	7	1	IC DCDR TTL LS BCD-TO-DEC 4 TO-10-LINE	01295	SN74LS42N
<i>A8U25</i>				NOT ASSIGNED		
	1200-0541	1		SOCKET-IC 24-CONT DIP DIP-SLDR	28480	1200-0541
	1200-0541	1		SOCKET-IC 24-CONT DIP DIP-SLDR	28480	1200-0541
<i>2450A TO 2520A</i>						
<i>A8U26</i>	08903-80024	0	1	ROM-PROG #9	28480	08903-80024
	1200-0541	1		SOCKET-IC 24-CONT DIP DIP-SLDR	28480	1200-0541
<i>A8U27</i>	08903-80023	9	1	ROM-PROG #8	28480	08903-80023
	1200-0541	1		SOCKET-IC 24-CONT DIP DIP-SLDR	28480	1200-0541
<i>A8U28</i>	08903-80020	6	1	ROM-PROG #5	28480	08903-80020
	1200-0541	1		SOCKET-IC 24-CONT DIP DIP-SLDR	28480	1200-0541
<i>2537A TO 2611A</i>						
<i>A8U26</i>	1818-3749	6	1	ROM-PROG #9	28480	1818-3749
	1200-0541	1		SOCKET-IC 24-CONT DIP DIP-SLDR	28480	1200-0541
<i>A8U27</i>	1818-3748	5	1	ROM-PROG #8	28480	1818-3748
	1200-0541	1		SOCKET-IC 24-CONT DIP DIP-SLDR	28480	1200-0541
<i>A8U28</i>	1818-3745	2	1	ROM-PROG #5	28480	1818-3745
	1200-0541	1		SOCKET-IC 24-CONT DIP DIP-SLDR	28480	1200-0541

↑ Refer to Section 7 for update information.

* Factory Selected Component (Refer to Section 5).

Δ Errata part change.

Table 6-3. Replaceable Parts

Reference Designation	HP Part Number	C D	Qty.	Description	Mfr. Code	Mfr. Part Number
A8	08903-60134 – SERIAL PREFIX 2450A TO 2614A					
A8U29	1820-1112	8		IC FF TTL LS D-TYPE POS-EDGE-TRIG	01295	SN74LS74AN
A8U30	1818-0197	2	1	IC NMOS 1024 (1K) STAT RAM 400-NS 3-S	34335	AM91L11BDC
	1200-0539	7	1	SOCKET-IC 18-CONT DIP DIP-SLDR	28480	1200-0539
A8Y1	0410-0757	5	1	CRYSTAL-QUARTZ 2.000 MHZ HC-6/U-HLDR	28480	0410-0757
	1200-0770	8	1	SOCKET-XTAL 2-CONT HC-6/U DIP-SLDR	28480	1200-0770

†Refer to Section 7 for update information.

*Factory Selected Component (Refer to Section 5).

Δ Errata part change.

Table 6-3. Replaceable Parts

Reference Designation	HP Part Number	C D	Qty.	Description	Mfr. Code	Mfr. Part Number
A8 08903-60184 – SERIAL PREFIX 2652A TO 2922A						
A8	08903-60184	1	1	CONTROLLER/COUNTER ASSEMBLY	28480	08903-60184
A8C1	0160-4832	4		CAPACITOR-FXD .01UF +80-20% 100VDC CER	28480	0160-4832
A8C2	0160-4832	4		CAPACITOR-FXD .01UF +80-20% 100VDC CER	28480	0160-4832
A8C3	0160-4832	4		CAPACITOR-FXD .01UF +80-20% 100VDC CER	28480	0160-4832
A8C4	0160-4832	4		CAPACITOR-FXD .01UF +80-20% 100VDC CER	28480	0160-4832
A8C5	0160-4832	4		CAPACITOR-FXD .01UF +80-20% 100VDC CER	28480	0160-4832
A8C7	0160-4832	4		CAPACITOR-FXD .01UF +80-20% 100VDC CER	28480	0160-4832
A8C8	0160-4832	4		CAPACITOR-FXD .01UF +80-20% 100VDC CER	28480	0160-4832
A8C9	0160-4832	4		CAPACITOR-FXD .01UF +80-20% 100VDC CER	28480	0160-4832
A8C10	0160-4832	4		CAPACITOR-FXD .01UF +80-20% 100VDC CER	28480	0160-4832
A8C11	0160-4832	4		CAPACITOR-FXD .01UF +80-20% 100VDC CER	28480	0160-4832
A8C12	0160-4832	4		CAPACITOR-FXD .01UF +80-20% 100VDC CER	28480	0160-4832
<i>2652A TO 2836A</i>						
A8C13	0160-4832	4		CAPACITOR-FXD .01UF +80-20% 100VDC CER	28480	0160-4832
A8C14	0160-4832	4		CAPACITOR-FXD .01UF +80-20% 100VDC CER	28480	0160-4832
<i>2908A TO 2922A</i>						
A8C13	0160-4822	2		CAPACITOR-FXD 1000PF +-10% 100VDC	28480	0160-4822
A8C14	0160-4822	2		CAPACITOR-FXD 1000PF +-10% 100VDC	28480	0160-4822
A8C15	0180-0197	8		CAPACITOR-FXD 2.2UF +-10% 20VDC TA	56289	150D225X9020A2
A8C16	0180-0220	7		CAPACITOR-FXD 33UF +-10% 10VDC TA	56289	150D335X9010B2
A8C17	0180-0197	8		CAPACITOR-FXD 2.2UF +-10% 20VDC TA	56289	150D225X9020A2
A8C18	0180-0197	8		CAPACITOR-FXD 2.2UF +-10% 20VDC TA	56289	150D225X9020A2
A8C19	0180-0197	8		CAPACITOR-FXD 2.2UF +-10% 20VDC TA	56289	150D225X9020A2
A8C20	0160-4832	4		CAPACITOR-FXD .01UF +80-20% 100VDC CER	28480	0160-4832
A8C21	0160-4832	4		CAPACITOR-FXD .01UF +80-20% 100VDC CER	28480	0160-4832
A8C22	0160-4832	4		CAPACITOR-FXD .01UF +80-20% 100VDC CER	28480	0160-4832
A8C23	0160-4832	4		CAPACITOR-FXD .01UF +80-20% 100VDC CER	28480	0160-4832
A8C24	0160-4832	4		CAPACITOR-FXD .01UF +80-20% 100VDC CER	28480	0160-4832
A8C25	0160-4787	8		CAPACITOR-FXD 20PF +-5% 500VDC CER 0+-30	28480	0160-4787
A8C26*	0160-4787	8	4	CAPACITOR-FXD 20PF +-5% 500VDC CER 0+-30	28480	0160-4787
A8C27	0121-0436	4	1	CAPACITOR-V TRMR-AIR 2.6-23.5PF 350V	74970	189-0509-125
A8C28				NOT ASSIGNED		
A8C29				NOT ASSIGNED		
A8C30				NOT ASSIGNED		
A8C31				NOT ASSIGNED		
A8C32				NOT ASSIGNED		
A8C34				NOT ASSIGNED		
A8C35				NOT ASSIGNED		
A8C36				NOT ASSIGNED		
A8C37	0180-1745	4	1	CAPACITOR-FXD 1.5UF +-10% 20VDC TA	56289	150D155X9020A2
A8C38	0160-4832	4	1	CAPACITOR-FXD .01UF +-10% 100VDC CER	28480	0160-4832
A8C44	0180-0197	8	1	CAPACITOR-FXD 2.2UF +-10% 20VDC TA	28480	0180-0197
A8CR1	1901-0050	3		DIODE-SWITCHING 80V 200MA 2NS DO-35	28480	1901-0050
A8CR2	1901-0050	3		DIODE-SWITCHING 80V 200MA 2NS DO-35	28480	1901-0050
A8CR3	1901-0050	3		DIODE-SWITCHING 80V 200MA 2NS DO-35	28480	1901-0050
A8CR4	1901-0050	3		DIODE-SWITCHING 80V 200MA 2NS DO-35	28480	1901-0050
A8CR5	1901-0050	3		DIODE-SWITCHING 80V 200MA 2NS DO-35	28480	1901-0050
A8CR6	1901-0050	3		DIODE-SWITCHING 80V 200MA 2NS DO-35	28480	1901-0050
A8CR7	1901-0050	3		DIODE-SWITCHING 80V 200MA 2NS DO-35	28480	1901-0050
A8CR8	1901-0050	3		DIODE-SWITCHING 80V 200MA 2NS DO-35	28480	1901-0050
A8CR9	1901-0539	3	1	DIODE-SM SIG SCHOTTKY	28480	1901-0539

† Refer to Section 7 for update information.

* Factory Selected Component (Refer to Section 5).

Δ Errata part change.

Table 6-3. Replaceable Parts

Reference Designation	HP Part Number	C D	Qty.	Description	Mfr. Code	Mfr. Part Number
A8 08903-60184 – SERIAL PREFIX 2652A TO 2922A						
A8DS1	1990 1110	5	4	LED-LAMP LUM-INT=1.5 MCD IF=15MA-MAX	28480	1900-1110
A8DS2	1990 1110	5	4	LED-LAMP LUM-INT=1.5 MCD IF=15MA-MAX	28480	1990-1110
A8DS3	1990-1110	5	4	LED-LAMP LUM-INT=1.5 MCD IF=15MA-MAX	28480	1990-1110
A8DS4	1990-1110	5	4	LED-LAMP LUM-INT=1.5 MCD IF=15MA-MAX	28480	1990-1110
A8J1	1200-0507	9	1	SOCKET-IC 16-CONT DIP-SLDR	28480	1200-0507
A8MP1	4040-0748	3		EXTR-PC BD BLK POLYC .062-BD-THKNS	28480	4040-0748
	1480-0116	8		PIN-GRV .062-IN-DIA .25-IN-LG STL	28480	1480-0116
A8MP2	4040-0747	2	1	EXTR-PC BD GRA POLYC .062-BD-THKNS	28480	4040-0747
	1480-0116	8		PIN-GRV .062-IN-DIA .25-IN-LG STL	28480	1480-0116
A8MP3				NOT ASSIGNED		
A8Q1	1854-0810	2	1	TRANSISTOR NPN SI PD=625MW FT=200MHZ	28480	1854-0810
A8R1	0757-0401	0		RESISTOR 100 1% .125W F TC=0+-100	24546	C4-1/8-T0-101-F
A8R2	0698-3440	7	1	RESISTOR 196 1% .125W F TC=0+-100	24546	C4-1/8-T0-196R-F
A8R3	1810-0286	2	1	NETWORK-CAPACITOR SIP 390 PF EA 8 PINS	2	8480 1810-0286
A8R4	0757-0442	9		RESISTOR 10K 1% .125W F TC=0+-100	24546	C4-1/8-T0-1002-F
A8R5	0757-0442	9		RESISTOR 10K 1% .125W F TC=0+-100	24546	C4-1/8-T0-1002-F
A8R6	0757-0442	9		RESISTOR 10K 1% .125W F TC=0+-100	24546	C4-1/8-T0-1002-F
A8R7				NOT ASSIGNED		
A8R8	0757-0442	9		RESISTOR 10K 1% .125W F TC=0+-100	24546	C4-1/8-T0-1002-F
A8R9	0757-0442	9		RESISTOR 10K 1% .125W F TC=0+-100	24546	C4-1/8-T0-1002-F
A8R10	0757-0442	9		RESISTOR 10K 1% .125W F TC=0+-100	24546	C4-1/8-T0-1002-F
A8R11	0757-0442	9		RESISTOR 10K 1% .125W F TC=0+-100	24546	C4-1/8-T0-1002-F
A8R12	0757-0442	9		RESISTOR 10K 1% .125W F TC=0+-100	24546	C4-1/8-T0-1002-F
A8R13	0757-0458	7		RESISTOR 51.1K 1% .125W F TC=0+-100	24546	C4-1/8-T0-5112-F
A8TP1	1251-5039	0		CONNECTOR-SGL CONT PIN 1.14-MM-BSC-SZ SO	22526	65500-118
A8TP2				NOT ASSIGNED		
A8TP3				NOT ASSIGNED		
A8TP4				NOT ASSIGNED		
A8TP5				NOT ASSIGNED		
A8TP6				NOT ASSIGNED		
A8TP7				NOT ASSIGNED		
A8TP8				NOT ASSIGNED		
A8TP9				NOT ASSIGNED		
A8TP10				NOT ASSIGNED		
A8TP11				NOT ASSIGNED		
A8TP12				NOT ASSIGNED		
A8TP13				NOT ASSIGNED		
A8TP14				NOT ASSIGNED		
A8TP15				NOT ASSIGNED		
A8TP16				NOT ASSIGNED		
A8TP17				NOT ASSIGNED		
A8TP18				NOT ASSIGNED		

†Refer to Section 7 for update information.

*Factory Selected Component (Refer to Section 5).

Δ Errata part change.

Table 6-3. Replaceable Parts

Reference Designation	HP Part Number	C D	Qty.	Description	Mfr. Code	Mfr. Part Number
A8 08903-60184 – SERIAL PREFIX 2652A TO 2922A						
A8U1	1820-1193	5	4	IC CNTR TTL LS BIN ASYNCHRO	01295	SN74LS197N
A8U2	1820-1193	5		IC CNTR TTL LS BIN ASYNCHRO	01295	SN74LS197N
A8U3	1820-1201	6	1	IC GATE TTL LS AND QUAD 2-INP	01295	SN74LS08N
A8U4	1820-1197	9		IC GATE TTL LS NAND QUAD 2-INP	01295	SN74LS00N
A8U5	1820-1928	4	1	IC-F8-MPU, CLK FREQ=2 MHZ	28480	1820-1928
	1200-0654	7	3	SOCKET-IC 40-CONT DIP DIP-SLDR	28480	1200-0654
A8U6	1820-2027	6	1	IC-STATIC MEMORY INTERFACE	28480	1820-2027
	1200-0654	7		SOCKET-IC 40-CONT DIP DIP-SLDR	28480	1200-0654
A8U7	1820-1417	6	4	IC GATE TTL LS NAND QUAD 2-INP	01295	SN74LS26N
	1200-0638	7	2	SOCKET-IC 14-CONT DIP DIP-SLDR	28480	1200-0638
A8U8				NOT ASSIGNED		
A8U9				NOT ASSIGNED		
A8U10				NOT ASSIGNED		
A8U11				NOT ASSIGNED		
A8U12				NOT ASSIGNED		
A8U13				NOT ASSIGNED		
A8U15	1820-1193	5		IC CNTR TTL LS BIN ASYNCHRO	01295	SN74LS197N
A8U16	1820-1287	8	1	IC BFR TTL LS NAND QUAD 2-INP	01295	SN74LS37N
A8U17	1820-1417	6		IC GATE TTL LS NAND QUAD 2-INP	01295	SN74LS26N
	1200-0638	7		SOCKET-IC 14-CONT DIP DIP-SLDR	28480	1200-0638
A8U18	1820-1199	1		IC INV TTL LS HEX 1-INP	01295	SN74LS04N
A8U19	1820-1202	7		IC GATE TTL LS NAND TPL 3-INP	01295	SN74LS10N
A8U20	1820-1199	1		IC INV TTL LS HEX 1-INP	01295	SN74LS04N
A8U21	1820-1216	3		IC DCDR TTL LS 3-TO-8-LINE 3-INP	01295	SN74LS139N
A8U22	1820-1216	3		IC DCDR TTL LS 3-TO-8-LINE 3-INP	01295	SN74LS139N
A8U23	1820-0174	0	1	IC INV TTL HEX	01295	SN7404N
A8U24				NOT ASSIGNED		
A8U25				NOT ASSIGNED		
A8U26				NOT ASSIGNED		
A8U27				NOT ASSIGNED		
A8U28				NOT ASSIGNED		
A8U29	1820-1114	8		IC FF TTL LS D-TYPE POS-EDGE-TRIG	01295	SN74LS74AN
A8U30	1818-0197	2	1	IC NMOS 1024 (1K) STAT RAM 400-NS 3-S	34335	AM91L11RDC
	1200-0539	7	1	SOCKET-IC 18-CONT DIP DIP-SLDR	28480	1200-0539
<i>2150A TO 2818A</i>						
A8U31	08903-80036	4	1	ROM-PROG 10 (8903B ONLY)	28480	08903-80036
	1200-1121	5	1	SOCKET-IC DIP PC	28480	1200-1121
<i>2836A TO 2922A</i>						
A8U31	08903-80036	2	1	ROM-PROG 10 (8903B ONLY)	28480	08903-80036
	1200-1121	5	1	SOCKET-IC DIP PC	28480	1200-1121
A8U34	1820-1281	2	1	IC DCDR TTL LS 2-TO-4-LINE DUAL 2-INP	01295	SN74LS139N
A8Y1	0410-0757	5	1	CRYSTAL-QUARTZ 2.000 MHZ HC-6/U-HLDR	28480	0410-0757
A8Y1	0410-0757	5	1	CRYSTAL-QUARTZ 2.000 MHZ HC-6/U-HLDR	28480	0410-0757

†Refer to Section 7 for update information.

*Factory Selected Component (Refer to Section 5).

Δ Errata part change.

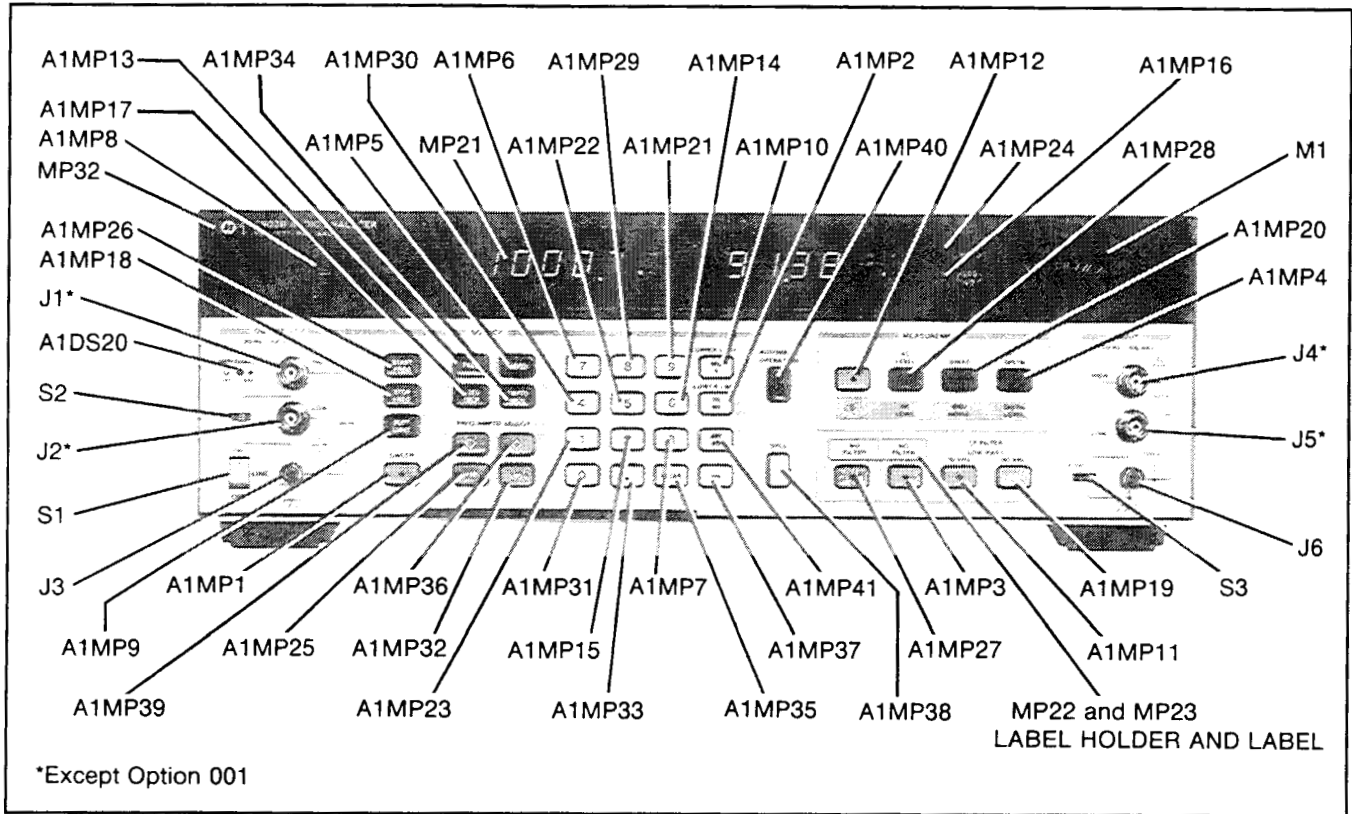


Figure 6-3. Chassis and Mechanical Parts Identification - Front Panel

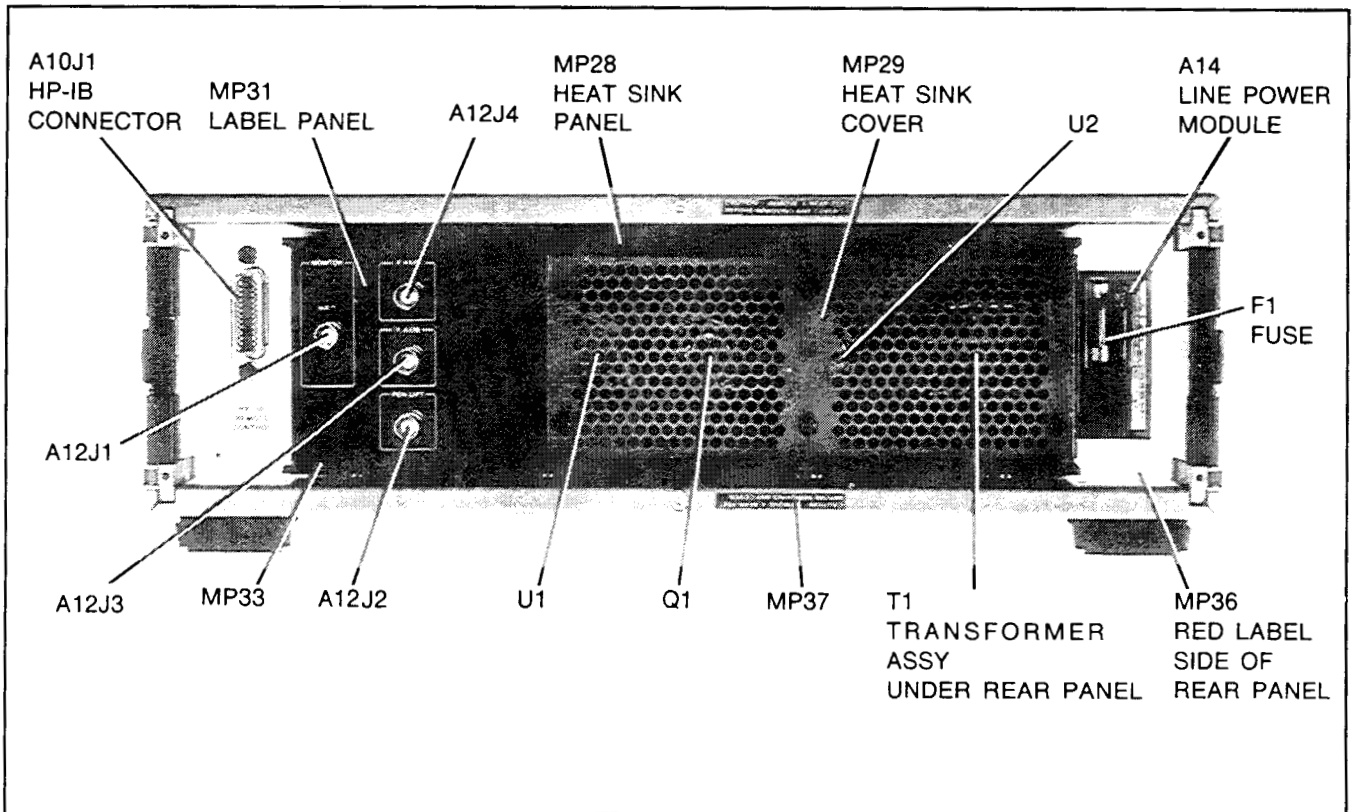


Figure 6-4. Chassis and Mechanical Parts Identification - Rear Panel (2742A and above)

Table 6-3. Replaceable Parts

Reference Designation	HP Part Number	C D	Qty.	Description	Mfr. Code	Mfr. Part Number
A8	08903-60300			– SERIAL PREFIX 2948A AND ABOVE		
A8	08903-60300	3	1	CONTROLLER/COUNTER ASSEMBLY	28480	08903-60300
A8C1	0160-4832	4	22	CAP-FXD 0.01uF 100 V	09969	RPA10X7R103K100V
A8C2	0160-4832	4		CAP-FXD 0.01uF 100 V	09969	RPA10X7R103K100V
A8C3	0160-4832	4		CAP-FXD 0.01uF 100 V	09969	RPA10X7R103K100V
A8C4	0160-4832	4		CAP-FXD 0.01uF 100 V	09969	RPA10X7R103K100V
A8C5	0160-4832	4		CAP-FXD 0.01uF 100 V	09969	RPA10X7R103K100V
A8C6	0160-4832	4		CAP-FXD 0.01uF 100 V	09969	RPA10X7R103K100V
A8C7	0160-4832	4		CAP-FXD 0.01uF 100 V	09969	RPA10X7R103K100V
A8C8	0160-4832	4		CAP-FXD 0.01uF 100 V	09969	RPA10X7R103K100V
A8C9	0160-4832	4		CAP-FXD 0.01uF 100 V	09969	RPA10X7R103K100V
A8C10	0160-4832	4		CAP-FXD 0.01uF 100 V	09969	RPA10X7R103K100V
A8C11	0160-4832	4		CAP-FXD 0.01uF 100 V	09969	RPA10X7R103K100V
A8C12	0160-4832	4		CAP-FXD 0.01uF 100 V	09969	RPA10X7R103K100V
A8C13	0160-4832	4		CAP-FXD 0.01uF 100 V	09969	RPA10X7R103K100V
A8C14	0160-4832	4		CAP-FXD 0.01uF 100 V	09969	RPA10X7R103K100V
A8C15	0160-4832	4		CAP-FXD 0.01uF 100 V	09969	RPA10X7R103K100V
A8C16	0160-4832	4		CAP-FXD 0.01uF 100 V	09969	RPA10X7R103K100V
A8C17	0160-4832	4		CAP-FXD 0.01uF 100 V	09969	RPA10X7R103K100V
A8C18	0160-4832	4		CAP-FXD 0.01uF 100 V	09969	RPA10X7R103K100V
A8C19	0160-4832	4		CAP-FXD 0.01uF 100 V	09969	RPA10X7R103K100V
A8C20	0160-4832	4		CAP-FXD 0.01uF 100 V	09969	RPA10X7R103K100V
A8C21	0160-4832	4		CAP-FXD 0.01uF 100 V	09969	RPA10X7R103K100V
A8C22	0160-4832	4		CAP-FXD 0.01uF 100 V	09969	RPA10X7R103K100V
A8C27	0160-4822	2	2	CAP-FXD 1000pF 100 V	09969	RPA20C0G102J100V
A8C28	0160-4822	2		CAP-FXD 1000pF 100 V	09969	RPA20C0G102J100V
A8C29	0180-1974	1	1	CAP-FXD 10uF 35 V TA	56289	150D106X9035R2
A8C30	0160-4835	7	1	CAP-FXD 0.1uF 50 V	09969	RPA20X7R104K50VPT
A8C31*	0160-4783	4	1	CAP-FXD 15pF + -2% 200V CER COG	06352	FD112COG2D150G
A8C32	0160-4765	2	1	CAP-FXD 36pF 200 V	09969	RPE121-105C0G360J200V
A8C33	0180-2111	0	4	CAP-FXD 33uF 35 V TA	56289	150D336X9035SA
A8C34	0180-0197	8	4	CAP-FXD 2.2uF 20 V TA	56289	150D225X9020A2
A8C35	0180-0197	8		CAP-FXD 2.2uF 20 V TA	56289	150D225X9020A2
A8C36	0180-0197	8		CAP-FXD 2.2uF 20 V TA	56289	150D225X9020A2
A8C37	0180-0197	8		CAP-FXD 2.2uF 20 V TA	56289	150D225X9020A2
A8C38	0180-2111	0		CAP-FXD 33uF 35 V TA	56289	150D336X9035SA
A8C39	0180-2111	0		CAP-FXD 33uF 35 V TA	56289	150D336X9035SA
A8C40	0180-2111	0		CAP-FXD 33uF 35 V TA	56289	150D336X9035SA
A8C41	0121-0436	4	1	CAP-VAR 23.5pF 2.6pF 350 V AIR	74970	189-0509-125
A8CR1	1901-1098	1	8	DIODE-SWITCHING 1N4150 50V 200MA 4NS	9N171	1N4150
A8CR2	1901-1098	1		DIODE-SWITCHING 1N4150 50V 200MA 4NS	9N171	1N4150
A8CR3	1901-1098	1		DIODE-SWITCHING 1N4150 50V 200MA 4NS	9N171	1N4150
A8CR4	1901-1098	1		DIODE-SWITCHING 1N4150 50V 200MA 4NS	9N171	1N4150
A8CR5	1901-1098	1		DIODE-SWITCHING 1N4150 50V 200MA 4NS	9N171	1N4150
A8CR6	1901-1098	1		DIODE-SWITCHING 1N4150 50V 200MA 4NS	9N171	1N4150
A8CR7	1901-1098	1		DIODE-SWITCHING 1N4150 50V 200MA 4NS	9N171	1N4150
A8CR8	1901-1098	1		DIODE-SWITCHING 1N4150 50V 200MA 4NS	9N171	1N4150

†Refer to Section 7 for update information.

*Factory Selected Component (Refer to Section 5).

Δ Errata part change.

Table 6-3. Replaceable Parts

Reference Designation	HP Part Number	C D	Qty.	Description	Mfr. Code	Mfr. Part Number
A8 08903-60300 – SERIAL PREFIX 2948A AND ABOVE						
A8DS1	1990-1110	5	4	LED-LAMP LUM-INT=1.5MCD IF=15MA-MAX	28480	HLMP-3600
A8DS2	1990-1110	5		LED-LAMP LUM-INT=1.5MCD IF=15MA-MAX	28480	HLMP-3600
A8DS3	1990-1110	5		LED-LAMP LUM-INT=1.5MCD IF=15MA-MAX	28480	HLMP-3600
A8DS4	1990-1110	5		LED-LAMP LUM-INT=1.5MCD IF=15MA-MAX	28480	HLMP-3600
A8R1	0757-0401	0	1	RESISTOR 100 +-1% .125W TF TC=0+-100	12498	CT4-1/8-TO-101-F
A8R2	0698-3440	7	1	RESISTOR 196 +-1% .125W TF TC=0+-100	12498	CT4-1/8-TO-196R-F
A8R3	0757-041E	7	1	RESISTOR 511 +-1% .125W TF TC=0+-100	12498	CT4-1/8-TO-511R-F
A8R6	0757-0412	9	2	RESISTOR 10K +-1% .125W TF TC=0+-100	12498	CT4-1/8-TO-1002-F
A8R7	0757-0442	9		RESISTOR 10K +-1% .125W TF TC=0+-100	12498	CT4-1/8-TO-1002-F
A8R8	1810-0206	8	2	NETWORK-RES 8-SIP 10.0K OHM X 7	C1433	750-81
A8R9	1810-0206	8		NETWORK-RES 8-SIP 10.0K OHM X 7	C1433	750-81
A8S1	3101-041H	3	1	SWITCH-DIP RKR 10-1A 0.1A 30VDC	81073	76PSE10S1
A8TP1	1251-0950	0	2	CONNECTOR-SGL CONT PIN 1.14-MM-BSC-SZ SQ	12360	94-155-1010-01-03-00
A8TP2	1251-0600	0		CONNECTOR-SGL CONT PIN 1.14-MM-BSC-SZ SQ	12360	94-155-1010-01-03-00
A8U1	1820-1193	5	4	IC CNTR TTL LS BIN ASYNCHRO	01295	SN74LS197N
A8U2	1820-1193	5		IC CNTR TTL LS BIN ASYNCHRO	01295	SN74LS197N
A8U3	1820-1201	6	1	IC GATE TTL LS AND QUAD 2-INP	01295	SN74LS08N
A8U4	1820-1197	9	2	IC GATE TTL LS NAND QUAD 2-INP	01295	SN74LS00N
A8U5	1820-1193	5		IC CNTR TTL LS BIN ASYNCHRO	01295	SN74LS197N
A8U6	1820-1193	5		IC CNTR TTL LS BIN ASYNCHRO	01295	SN74LS197N
A8U7	1820-1417	6	2	IC GATE TTL LS NAND QUAD 2-INP	01295	SN74LS26N
A8U8	1820-1417	6		IC GATE TTL LS NAND QUAD 2-INP	01295	SN74LS26N
A8U9	1820-1199	1	1	IC INV TTL LS HEX 1-INP	01295	SN74LS04N
A8U10	1820-1202	7	1	IC GATE TTL LS NAND TPL 3 INP	01295	SN74LS10N
A8U11	1820-1216	3	2	IC DCDR TTL LS 3-TO-8-LINE 3-INP	01295	SN74LS139N
A8U12	1820-1112	8	1	IC FF TTL LS D-TYPE POS-EDGE-TRIG	01295	SN74LS74AN
A8U13	1820-1208	3	1	IC GATE TTL LS OR QUAD 2-INP	01295	SN74LS32N
A8U14	1820-2624	9	1	IC-MPU. CLK FREQ=2 MHZ. ENHANCED 6800	04713	MC68B09P
A8U15	08903-87003	9	1	PROGRAMMED ROM	28480	08903-87003
A8U16	1820-1281	2	1	IC DCDR TTL LS 2-TO-4-LINE DUAL	01295	SN74LS139AN
A8U17	1818-318J	2	1	IC CMOS 65536 (64K) STAT RAM 150-NS 3-S	S4013	HM6254LP 15
A8U18	1820-1197	9		IC GATE TTL LS NAND QUAD 2-INP	01295	SN74LS00N
A8U19	1820-298J	3	1	IC-PERIPHERAL INTERFACE ADAPTER,CLK=2MHZ	04713	MC68B21F
A8U20	1820-1917	1	1	IC DRVR TTL LS LINE OCTL	01295	SN74LS240N
A8U21	1820-3608	1	1	IC INV TTL AS HEX	01295	SN74AS04N
A8U22	1820-1216	3		IC DCDR TTL LS 3-TO-8-LINE 3-INP	01295	SN74LS138N
A8VR1	1826-1338	2	1	IC MISC 8-DIP-P PKG	01295	TL7705A
A8Y1	0410-0779	1	1	CRYSTAL QUARTZ 8.0 MHZ HC-18-U-HLDR	11236	Q20-1746-0
	4040-0748	3	1	EXTR-PC BD BLK POLYC .062-IN-BD-THKNS	28480	4040-0748
	4040-0747	2	1	EXTR-PC BD GRA POLYC .062-IN-BD-THKNS	28480	4040-0747
	1480-0116	8	2	PIN-GRV .062-IN-DIA .25-IN-LG STL	73957	GP24 063 X 250-17
	0361-0026	6	1	RIVET-SEMITUB OVH .089DIA .125LG	28480	0361-0026
	1400-0973	7	1	CLIP-CMPNT .139-.154-DIA STL	91506	6180-1A
	1200-0567	1	1	SOCKET-IC-DIP 28-CONT DIP DIP-SLDR	01295	C8728-01
	1200-0654	7	2	SOCKET-IC-DIP 40-CONT DIP DIP-SLDR	01295	C8740 01

† Refer to Section 7 for update information.

* Factory Selected Component (Refer to Section 5).

Δ Errata part change.

Table 6-3. Replaceable Parts

Reference Designation	HP Part Number	C D	Qty.	Description	Mfr. Code	Mfr. Part Number
A9 08903-60118 – SERIAL PREFIX 2450A TO 2922A						
A9	08903-60118	1	1	REMOTE INTERFACE ASSEMBLY	28480	08903-60118
A9C1	0180-0374	3		CAPACITOR-FXD 10UF +-10% 20VDC TA	56289	150D106X9020B2
A9C2	0180-0229	7		CAPACITOR-FXD 33UF +-10% 10VDC TA	56289	150D335X9010B2
A9C3	0160-2055	9		CAPACITOR-FXD .01UF +80-20% 100VDC CER	28480	0160-2055
A9C4	0180-0197	8		CAPACITOR-FXD 2.2UF +-10% 20VDC TA	56289	150D225X9020A2
A9C5	0160-2055	9		CAPACITOR-FXD .01UF +80-20% 100VDC CER	28480	0160-2055
A9C6	0160-2055	9		CAPACITOR-FXD .01UF +80-20% 100VDC CER	28480	0160-2055
A9C7	0160-2055	9		CAPACITOR-FXD .01UF +80-20% 100VDC CER	28480	0160-2055
A9C8	0160-2055	9		CAPACITOR-FXD .01UF +80-20% 100VDC CER	28480	0160-2055
A9C9	0160-2055	9		CAPACITOR-FXD .01UF +80-20% 100VDC CER	28480	0160-2055
A9C10	0160-2055	9		CAPACITOR-FXD .01UF +80-20% 100VDC CER	28480	0160-2055
A9C11	0160-2055	9		CAPACITOR-FXD .01UF +80-20% 100VDC CER	28480	0160-2055
A9C12	0160-2055	9		CAPACITOR-FXD .01UF +80-20% 100VDC CER	28480	0160-2055
A9C13	0160-2055	9		CAPACITOR-FXD .01UF +80-20% 100VDC CER	28480	0160-2055
A9C14	0160-2055	9		CAPACITOR-FXD .01UF +80-20% 100VDC CER	28480	0160-2055
A9C15	0160-2055	9		CAPACITOR-FXD .01UF +80-20% 100VDC CER	28480	0160-2055
A9C16	0160-2055	9		CAPACITOR-FXD .01UF +80-20% 100VDC CER	28480	0160-2055
A9C17	0160-0574	3	2	CAPACITOR-FXD 022UF +-20% 100VDC CER	28480	0160-0574
A9C18	0140-0196	3	1	CAPACITOR-FXD 150PF +-5% 300VDC MICA	72136	DM15F151J0300WV1CR
A9C19	0160-0574	3		CAPACITOR-FXD 022UF +-20% 100VDC CER	28480	0160-0574
A9CR1	1901-0518	8		DIODE-SM SIG SCHOTTKY	28480	1901-0518
A9MP1	4040-0748	3		EXTR-PC BD BLK POLYC .062-BD-THKNS	28480	4040-0748
	1490-0116	8		PIN-GRV .052-IN-DIA .25-IN-LG STL	28480	1490-0116
A9MP2	4040-0756	3	1	EXTR-PC BD WHT POLYC .062-BD-THKNS	28480	4040-0756
	1480-0116	8		PIN-GRV .062-IN-DIA .25-IN-LG STL	28480	1480-0116
A9R1	0698-3444	1	2	RESISTOR 316 1% .125W F TC=0+-100	24546	C4-1/8-T0-316R-F
A9R2	1810-0206	8		NETWORK-RES 8-SIP10.0K OHM X 7	01121	208A103
A9R3	1810-0206	8		NETWORK-RES 8-SIP10.0K OHM X 7	01121	208A103
A9R4	0698-0084	9		RESISTOR 2.15K 1% .125W F TC=0+-100	24546	C4-1/8-T0-1961-F
A9R5	0757-0416	7		RESISTOR 511 1% .125W F TC=0+-100	24546	C4-1/8-T0-511R-F
A9R6	1810-0136	3	1	NETWORK-RES 10-SIP MULTI-VALUE	28480	1810-0136
A9R7	0698-0083	8		RESISTOR 1.96K 1% .125W F TC=0+-100	24546	C4-1/8-T0-1961-F
A9R8	0698-3444	1		RESISTOR 316 1% .125W F TC=0+-100	24546	C4-1/8-T0-316R-F
A9R9	0757-0442	9		RESISTOR 10K 1% .125W F TC=0+-100	24546	C4-1/8-T0-1002-F
A9S1	3101-1973	7	1	SWITCH-SL 7-1A DIP-SLIDE ASSY .1A 50VDC	28480	3101-1973
	1200-0485	2	1	SOCKET-IC 14-CONT DIP DIP-SLDR	28480	1200-0485
A9TP1	1251-0600	0		CONNECTOR-SGL CONT PIN 1.14-MM-BSC-SZ SQ	28480	1251-0600
A9TP2	1251-0600	0		CONNECTOR-SGL CONT PIN 1.14-MM-BSC-SZ SQ	28480	1251-0600
A9TP3	1251-0600	0		CONNECTOR-SGL CONT PIN 1.14-MM-BSC-SZ SQ	28480	1251-0600
A9TP4	1251-0600	0		CONNECTOR-SGL CONT PIN 1.14-MM-BSC-SZ SQ	28480	1251-0600
A9TP5	1251-0600	0		CONNECTOR-SGL CONT PIN 1.14-MM-BSC-SZ SQ	28480	1251-0600
A9TP6	1251-0600	0		CONNECTOR-SGL CONT PIN 1.14-MM-BSC-SZ SQ	28480	1251-0600
A9TP7	1251-0600	0		CONNECTOR-SGL CONT PIN 1.14-MM-BSC-SZ SQ	28480	1251-0600
A9TP8	1251-0600	0		CONNECTOR-SGL CONT PIN 1.14-MM-BSC-SZ SQ	28480	1251-0600
A9TP9	1251-0600	0		CONNECTOR-SGL CONT PIN 1.14-MM-BSC-SZ SQ	28480	1251-0600

†Refer to Section 7 for update information.

*Factory Selected Component (Refer to Section 5).

Δ Errata part change.

Table 6-3. Replaceable Parts

Reference Designation	HP Part Number	C D	Qty.	Description	Mfr. Code	Mfr. Part Number
A9 08903-60118 – SERIAL PREFIX 2450A TO 2922A						
A9U1	1820-1112	8		IC FF TTL LS D-TYPE POS-EDGE-TRIG	01295	SN74LS74AN
A9U2	08901-80004	4	1	PROM 1816-0915	28480	08901-80004
A9U3	1820-1112	8		IC FF TTL LS D-TYPE POS-EDGE-TRIG	01295	SN74LS74AN
A9U4	1820-1417	6		IC GATE TTL LS NAND QUAD 2-INP	01295	SN74LS26N
A9U5	1820-2740	0	1	IC COMPTN TTL LS MAGTD 2-INP 8-BIT	01295	SN74LS688N
A9U6	1820-1905	7	1	IC GATE TTL LS NOR DUAL 5-INP	07263	74LS260PC
A9U7	1820-1198	0	2	IC GATE TTL LS NAND QUAD 2-INP	01295	SN74LS03N
A9U8	1820-1689	4	2	IC UART TTL QUAD	01295	1820-1689
A9U9	1820-1199	0		IC GATE TTL LS NAND QUAD 2-INP	01295	SN74LS03N
A9U10	1820-1689	4	2	IC UART TTL QUAD	01295	1820-1689
A9U11	1820-1200	5	2	IC INV TTL LS HEX	01295	SN74LS05N
A9U12	1820-1112	8		IC FF TTL LS D-TYPE POS-EDGE-TRIG	01295	SN74LS74AN
A9U13	1820-1200	5		IC INV TTL LS HEX	01295	SN74LS05N
A9U14	1820-1199	1		IC INV TTL LS HEX 1-INP	01295	SN74LS04N
A9U15	1820-0054	5	1	IC GATE TTL NAND QUAD 2-INP	01295	SN7400N
A9U16	1820-1216	3		IC DCDR TTL LS 3-TO-8-LINE 3-INP	01295	SN74LS138N
A9U17	1820-1417	6		IC GATE TTL LS NAND QUAD 2-INP	01295	SN74LS26N
A9U18	1820-2100	6	1	IC MICPROC-ACCESS NMOS DUAL 8-BIT	07263	3861EPC
	1200-0654	7		SOCKET-IC 40-CONT DIP DIP-SLDR	28480	1200-0654
A9U19	1820-1416	5	1	IC SCHMITT-TRIG TTL LS INV HEX 1-INP	01295	SN74LS14N
A9U20	1820-0621	2	1	IC BFR TTL NAND QUAD 2-INP	01295	SN7438N

†Refer to Section 7 for update information.

*Factory Selected Component (Refer to Section 5).

Δ Errata part change.

Table 6-3. Replaceable Parts

Reference Designation	HP Part Number	C/D	Qty.	Description	Mfr. Code	Mfr. Part Number
A9 08903-60297 – SERIAL PREFIX 2948A AND ABOVE						
A9	08903-60297	7		REMOTE INTERFACE ASSEMBLY	28480	08903-60297
A9C2	0180-2111	0	1	CAP-FXD 33uF 35 V TA	56289	150D336X9035SA
A9C4	0180-0197	8	1	CAP-FXD 2.2uF 20 V TA	56289	150D225X9020A2
A9C5	0160-4832	4	12	CAP-FXD 0.01uF 100 V	09969	RPA10X7R103K100V
A9C6	0160-4832	4		CAP-FXD 0.01uF 100 V	09969	RPA10X7R103K100V
A9C7	0160-4832	4		CAP-FXD 0.01uF 100 V	09969	RPA10X7R103K100V
A9C8	0160-4832	4		CAP-FXD 0.01uF 100 V	09969	RPA10X7R103K100V
A9C9	0160-4832	4		CAP-FXD 0.01uF 100 V	09969	RPA10X7R103K100V
A9C10	0160-4832	4		CAP-FXD 0.01uF 100 V	09969	RPA10X7R103K100V
A9C11	0160-4832	4		CAP-FXD 0.01uF 100 V	09969	RPA10X7R103K100V
A9C12	0160-4832	4		CAP-FXD 0.01uF 100 V	09969	RPA10X7R103K100V
A9C13	0160-4832	4		CAP-FXD 0.01uF 100 V	09969	RPA10X7R103K100V
A9C14	0160-4832	4		CAP-FXD 0.01uF 100 V	09969	RPA10X7R103K100V
A9C15	0160-4832	4		CAP-FXD 0.01uF 100 V	09969	RPA10X7R103K100V
A9C16	0160-4832	4		CAP-FXD 0.01uF 100 V	09969	RPA10X7R103K100V
A9C17	0160-4833	5	2	CAP-FXD 0.022uF 100 V	09969	RPA20X7R223K100V
A9C18	0160-4814	2	1	CAP-FXD 150pF 100 V	09969	RPA10C0G151J100V
A9C19	0160-4833	5		CAP-FXD 0.022uF 100 V	09969	RPA20X7R223K100V
A9CR1	1901-0518	8	1	DIODE-SCHOTTKY SM SIG	12403	5002-2800
A9R1	0698-3444	1	2	RESISTOR 316 +-1% .125W TF TC=0+-100	12498	CT4-1/8-T0-316R-F
A9R2	1810-0206	8	3	NETWORK-RES 8-SIP 10.0K OHM X 7	C1433	750-81
A9R3	1810-0206	8		NETWORK-RES 8-SIP 10.0K OHM X 7	C1433	750-81
A9R4	0698-0084	9	1	RESISTOR 2.15K +-1% .125W TF TC=0+-100	24546	C4-1/8-T0-2151-F
A9R5	0757-0416	7	1	RESISTOR 511 +-1% .125W TF TC=0+-100	12498	CT4-1/8-T0-511R-F
A9R6	1810-0136	3	1	NETWORK-RES 10-SIP MULTI-VALUE	01121	410S003
A9R7	0698-0083	8	1	RESISTOR 1.96K +-1% .125W TF TC=0+-100	12498	CT4-1/8-T0-1961-F
A9R8	0698-3444	1		RESISTOR 316 +-1% .125W TF TC=0+-100	12498	CT4-1/8-T0-316R-F
A9R9	0757-0442	9	1	RESISTOR 10K +-1% .125W TF TC=0+-100	12498	CT4-1/8-T0-1002-F
A9R10	1810-0206	8		NETWORK-RES 8-SIP 10.0K OHM X 7	C1433	750-81
A9S1	3101-1973	7	1	SWITCH-DIP SL 7-1A 0.1A 50VDC	11236	11P-1028
A9TP1	1251-0600	0	8	CONNECTOR-SGL CONT PIN 1.14-MM-BSC-SZ SQ	12360	94-155-1010-01-03-00
A9TP2	1251-0600	0		CONNECTOR-SGL CONT PIN 1.14-MM-BSC-SZ SQ	12360	94-155-1010-01-03-00
A9TP3	1251-0600	0		CONNECTOR-SGL CONT PIN 1.14-MM-BSC-SZ SQ	12360	94-155-1010-01-03-00
A9TP4	1251-0600	0		CONNECTOR-SGL CONT PIN 1.14-MM-BSC-SZ SQ	12360	94-155-1010-01-03-00
A9TP5	1251-0600	0		CONNECTOR-SGL CONT PIN 1.14-MM-BSC-SZ SQ	12360	94-155-1010-01-03-00
A9TP6	1251-0600	0		CONNECTOR-SGL CONT PIN 1.14-MM-BSC-SZ SQ	12360	94-155-1010-01-03-00
A9TP7	1251-0600	0		CONNECTOR-SGL CONT PIN 1.14-MM-BSC-SZ SQ	12360	94-155-1010-01-03-00
A9TP9	1251-0600	0		CONNECTOR-SGL CONT PIN 1.14-MM-BSC-SZ SQ	12360	94-155-1010-01-03-00
A9U1	1820-1112	8	3	IC FF TTL LS D-TYPE POS-EDGE-TRIG	01295	SN74LS74AN
A9U2	08901-80004	4	1	PROM 1816-0915	28480	08901-80004
A9U3	1820-1112	8		IC FF TTL LS D-TYPE POS-EDGE-TRIG	01295	SN74LS74AN
A9U4	1820-1417	6	2	IC GATE TTL LS NAND QUAD 2-1NP	01295	SN74LS26N
A9U5	1820-2740	0	1	IC COMPTR TTL LS MAGTD 2-1NP 8-BIT	34335	AM25LS2521PC

†Refer to Section 7 for update information.

*Factory Selected Component (Refer to Section 5).

Δ Errata part change.

Table 6-3. Replaceable Parts

Reference Designation	HP Part Number	C D	Qty.	Description	Mfr. Code	Mfr. Part Number
A9 08903-60297 – SERIAL PREFIX 2948A AND ABOVE						
A9U6	1820-1905	7	1	IC GATE TTL LS NOR DUAL 5-INP	18324	74LS260N
A9U7	1820-1198	0	2	IC GATE TTL LS NAND QUAD 2-INP	01295	SN74LS03N
A9U8	1820-1689	4	2	IC-INTERFACE XCVR INSTRUMENT BUS IEEE	01295	MC3446N
A9U9	1820-1198	0		IC GATE TTL LS NAND QUAD 2-INP	01295	SN74LS03N
A9U10	1820-1689	4		IC-INTERFACE XCVR INSTRUMENT BUS IEEE	01295	MC3446N
A9U11	1820-1200	5	2	IC INV TTL LS HEX	01295	SN74LS05N
A9U12	1820-1112	8		IC FF TTL LS D-TYPE POS-EDGE-TRIG	01295	SN74LS74AN
A9U13	1820-1200	5		IC INV TTL LS HEX	01295	SN74LS05N
A9U14	1820-1199	1	1	IC INV TTL LS HEX 1-INP	01295	SN74LS04N
A9U15	1820-0054	5	1	IC GATE TTL NAND QUAD 2-INP	01295	SN7400N
A9U16	1820-1216	3	1	IC DCDR TTL LS 3-TO-8-LINE 3-INP	01295	SN74LS138N
A9U17	1820-1417	6		IC GATE TTL LS NAND QUAD 2-INP	01295	SN74LS26N
A9U18	1820-2983	3	1	IC-PERIPHERAL INTERFACE ADAPTER,CLK=2MHZ	04713	MC68B21P
A9U19	1820-1416	5	1	IC SCHMITT TRIG TTL LS INV HEX 1-INP	01295	SN74LS14N
A9U20	1820-0621	2	1	IC BFR TTL NAND QUAD 2-INP	01295	SN7438N
A9XS1	1200-0485	2	1	SOCKET-IC-14-CONT DIP DIP-SLDR	51167	14-820-90
A9XU18	1200-0654	7	1	SOCKET-IC-DIP 40-CONT DIP DIP-SLDR	01295	C8/40-01
	1480-0116	8	2	PIN-GRV .062-IN-DIA .25-IN-LG STL	73957	GP24 063 X 250-17
	4040-0748	3	1	EXTR-PC BD BLK POLYC .062-IN-BD-THKNS	28480	4040-0748
	4040-0756	3	1	EXTR-PC BD WHT POLYC .062-IN-BD-THKNS	28480	4040-0756
	7121-4611	2	1	LABEL-INFORMATION .15-IN-WD .6-IN-LG	09535	L01003
	7121-4611	2	1	LABEL-INFORMATION .15-IN-W/D .6-IN-LG	09535	L01003

†Refer to Section 7 for update information.

*Factory Selected Component (Refer to Section 5).

Δ Errata part change.

Table 6-3. Replaceable Parts

Reference Designation	HP Part Number	C D	Qty.	Description	Mfr. Code	Mfr. Part Number
A10						
A10	08903-60108	9	1	REMOTE INTERFACE CONNECTOR ASSEMBLY	28480	08903-60108
A10J1	1251-3283	1	1	CONNECTOR 24-PIN F MICRORIBBON	28480	1251-3283
A10MP1	0380-0644	4	2	STANDOFF-HEX .327-IN-LG 6-32THD	00000	ORDER BY DESCRIPTION
	2190-0034	5	2	WASHER-LK HLCL NO. 10 .194-IN-ID	28480	2190-0034
A10MP2	1530-1098	4	2	CLEVIS 0.070-IN W SLT: 0.454-IN PIN CTR	00000	ORDER BY DESCRIPTION
	2190-0019	6	8	WASHER-LK HLCL NO. 4 .115-IN-ID	28480	2190-0019
	2200-0109	8	2	SCREW-MACH 4-40 .438-IN-LG PAN-HD-POZI	00000	ORDER BY DESCRIPTION
	2260-0002	6	2	NUT HEX-DBL-CHAM 4-40-THD .062-IN-THK	28480	2260-0002

†Refer to Section 7 for update information.

*Factory Selected Component (Refer to Section 5).

Δ Errata part change.

Table 6-3. Replaceable Parts

Reference Designation	HP Part Number	C D	Qty.	Description	Mfr. Code	Mfr. Part Number
A11						
A11	08903-60015	7	1	SERIES REGULATOR SOCKET ASSEMBLY	28480	08903-60015
A11C1	0180-0116	1		CAPACITOR-FXD 6.8UF+-10% 35VDC TA	56289	150D685X9035B2
A11C2	0180-0116	1		CAPACITOR-FXD 6.8UF+-10% 35VDC TA	56289	150D685X9035B2
A11C3	0180-0116	1		CAPACITOR-FXD 6.8UF+-10% 35VDC TA	56289	150D685X9035B2
A11C4	0180-0116	1		CAPACITOR-FXD 6.8UF+-10% 35VDC TA	56289	150D685X9035B2
A11F1	2110-0001	8	2	FUSE 1A 250V NTD 1.25X.25 UL	75915	312001
A11F2	2110-0294	1	1	FUSE 4A 32V NTD 1.25X.25	28480	2110-0294
A11F3	2110-0001	8		FUSE 1A 250V NTD 1.25X.25 UL	75915	312001
A11MP1	2110-0269	0	6	FUSEHOLDER-CLIP TYPE.25D-FUSE	28480	2110-0269
A11MP2	2110-0269	0		FUSEHOLDER-CLIP TYPE.25D-FUSE	28480	2110-0269
A11MP3	2110-0269	0		FUSEHOLDER-CLIP TYPE.25D-FUSE	28480	2110-0269
A11MP4	2110-0269	0		FUSEHOLDER-CLIP TYPE.25D-FUSE	28480	2110-0269
A11MP5	2110-0269	0		FUSEHOLDER-CLIP TYPE.25D-FUSE	28480	2110-0269
A11MP6	2110-0269	0		FUSEHOLDER-CLIP TYPE.25D-FUSE	28480	2110-0269
A11XQ1	1200-0041	6	3	SOCKET-XSTR 2-CONT TO-3 SLDR-EYE	28480	1200-0041
A11XU1	1200-0041	6		SOCKET-XSTR 2-CONT TO-3 SLDR-EYE	28480	1200-0041
A11XU2	1200-0041	6		SOCKET-XSTR 2-CONT TO-3 SLDR-EYE	28480	1200-0041

†Refer to Section 7 for update information.

*Factory Selected Component (Refer to Section 5).

Δ Errata part change.

Table 6-3. Replaceable Parts

Reference Designation	HP Part Number	C D	Qty.	Description	Mfr. Code	Mfr. Part Number
A12						
A12	08903-60018	8	1	CONNECTOR FILTER ASSEMBLY	28480	08903-60018
A12C1	0160-2307	4	5	CAPACITOR-FXD 47PF +5% 300VDC MICA	28480	0160-2307
A12C2	0160-2055	9		CAPACITOR-FXD .01UF +80-20% 100VDC CER	28480	0160-2055
A12C3	0160-2055	9		CAPACITOR-FXD .01UF +80-20% 100VDC CER	28480	0160-2055
A12C4	0160-2055	9		CAPACITOR-FXD .01UF +80-20% 100VDC CER	28480	0160-2055
A12J1 ^Δ	1250-1096	8	4	CONNECTOR-RF BNC FEM SGL-HOLE-RR 50-OHM	28480	1250-1096
	2190-0347	3	4	WASHER-FL MTL C 7/18 IN .467-IN-ID	05057	P-1476-1
A12J2				NOT ASSIGNED		
A12J3	1250-1096	8		CONNECTOR-RF BNC FEM SGL-HOLE-RR 50-OHM	28480	1250-1096
A12J4	1250-1096	8		CONNECTOR-RF BNC FEM SGL-HOLE-RR 50-OHM	28480	1250-1096
A12J5	1250-1096	8		CONNECTOR-RF BNC FEM SGL-HOLE-RR 50-OHM	28480	1250-1096
A12L1	9140-0210	1		INDUCTOR RF-CH-MLD 100UH 5% .166DX.385LG	28480	9140-0210
A12L2	9140-0210	1		INDUCTOR RF-CH-MLD 100UH 5% .166DX.385LG	28480	9140-0210
A12L3	9140-0210	1		INDUCTOR RF-CH-MLD 100UH 5% .166DX.385LG	28480	9140-0210
A12L4	9140-0210	1		INDUCTOR RF-CH-MLD 100UH 5% .166DX.385LG	28480	9140-0210

†Refer to Section 7 for update information.

*Factory Selected Component (Refer to Section 5).

Δ Errata part change.

Table 6-3. Replaceable Parts

Reference Designation	HP Part Number	C D	Qty.	Description	Mfr. Code	Mfr. Part Number
A13 08903-60129/192/292 – SERIAL PREFIX 2450A TO 2922A						
2450A TO 2652A A13	08903-60129	4	1	POWER SUPPLY MOTHERBOARD	28480	08903-60129
2717A TO 2712A A13	08903-60192	1	1	POWER SUPPLY MOTHERBOARD	28480	08903-60192
2813A TO 2922A A13	08903-60292	2	1	POWER SUPPLY MOTHERBOARD	28480	08903-60292
2717A TO 2712A A13C1	0180-2317	8	2	CAPACITOR-FXD 3600UF +75-10% 40VDC AL	00853	539-7445-02
	2680-0271	1	6	SCREW-MACH 10-32 .312-IN-LG PAN-HD-POZI	00000	ORDER BY DESCRIPTION
A13C2	0180-2317	8		CAPACITOR-FXD 3600UF +75-10% 40VDC AL	00853	539-7445-02
	2680-0271	1	6	SCREW-MACH 10-32 .312-IN-LG PAN-HD-POZI	00000	ORDER BY DESCRIPTION
A13C3	0180-0452	8	1	CAPACITOR-FXD .013F +75-10% 25VDC AL	28480	0180-0452
	2680-0271	1	6	SCREW-MACH 10-32 .312-IN-LG PAN-HD-POZI	00000	ORDER BY DESCRIPTION
2813A TO 2922A A13C1	0180-2317	8	2	CAPACITOR-FXD 3600UF +75-10% 40VDC AL	00853	539-7445-02
	2680-0099	1	5	SCREW-MACH 10-32 .375-IN-LG PAN-HD-POZI	00000	ORDER BY DESCRIPTION
	2190-0012	9	6	WASHER-LK EXT T NO. 10 .195-IN-ID	00000	ORDER BY DESCRIPTION
A13C2	0180-2317	8		CAPACITOR-FXD 3600UF +75-10% 40VDC AL	00853	539-7445-02
	2680-0099	1	6	SCREW-MACH 10-32 .375-IN-LG PAN-HD-POZI	00000	ORDER BY DESCRIPTION
	2190-0012	9	6	WASHER-LK EXT T NO. 10 .195-IN-ID	00000	ORDER BY DESCRIPTION
A13C3	0180-0452	8	1	CAPACITOR-FXD .013F +75-10% 25VDC AL	28480	0180-0452
	2680-0099	1	6	SCREW-MACH 10-32 .375-IN-LG PAN-HD-POZI	00000	ORDER BY DESCRIPTION
	2190-0012	9	6	WASHER-LK EXT T NO. 10 .193-IN-ID	00000	ORDER BY DESCRIPTION
2450A TO 2922A A13C1	0180-0291	3		CAPACITOR-FXD 1UF +-10% 35VDC TA	56289	150D105X9035A2
A13C5	0180-0116	1		CAPACITOR-FXD 6.8UF +-10% 35VDC TA	56289	150D685X9035B2
A13C6	0180-0291	3		CAPACITOR-FXD 1UF +-10% 35VDC TA	56289	150D105X9035A2
A13C7	0140-0210	2	1	CAPACITOR-FXD 270PF +-5% 300VDC MICA	72136	DM115F21J030WV1CR
A13C8	0180-0197	8		CAPACITOR-FXD 2.2UF +-10% 20VDC TA	56289	150D225X9020A2
A13C9	0180-0197	8		CAPACITOR-FXD 2.2UF +-10% 20VDC TA	56289	150D225X9020A2
A13C10	0180-0116	1		CAPACITOR-FXD 6.8UF +-10% 35VDC TA	56289	150D685X9035B2
A13C11	0180-0197	8		CAPACITOR-FXD 2.2UF +-10% 20VDC TA	56289	150D225X9020A2
A13C12	0160-0576	5	1	CAPACITOR-FXD 1UF +-20% 50VDC CER	28480	0160-0576
A13C13	0160-2307	4		CAPACITOR-FXD 47PF +-5% 300VDC MICA	28480	0160-2307
A13C14	0160-2307	4		CAPACITOR-FXD 47PF +-5% 300VDC MICA	28480	0160-2307
A13C15	0160-2307	4		CAPACITOR-FXD 47PF +-5% 300VDC MICA	28480	0160-2307
A13C16	0160-2307	4		CAPACITOR-FXD 47PF +-5% 300VDC MICA	28480	0160-2307
A13C17	0160-4805	1		CAPACITOR-FXD 47PF +-5% 100VDC CER 0+-30	28480	0160-4805
2450A TO 2652A A13C18	0160-4535	4	3	CAPACITOR-FXD 1UF +-10% 50VDC CER	28480	0160-4535
A13C19	0160-4535	4		CAPACITOR-FXD 1UF +-10% 50VDC CER	28480	0160-4535
A13C20	0160-4535	4		CAPACITOR-FXD 1UF +-10% 50VDC CER	28480	0160-4535
2717A TO 2922A A13C18	0160-5469	5	3	CAPACITOR-FXD 1UF 10% 50VDC	28480	0160-5469
A13C19	0160-5469	5		CAPACITOR-FXD 1UF 10% 50VDC	28480	0160-5469
A13C20	0160-5469	5		CAPACITOR-FXD 1UF 10% 50VDC	28480	0160-5469
A13CR1	1901-0200	5	4	DIODE-PWR RECT 100V 1.5A	28480	1901-0200
A13CR2	1901-0200	5		DIODE-PWR RECT 100V 1.5A	28480	1901-0200
A13CR3	1901-0200	5		DIODE-PWR RECT 100V 1.5A	28480	1901-0200
A13CR4	1901-0200	5		DIODE-PWR RECT 100V 1.5A	28480	1901-0200
A13CR5	1905-0231	2	1	DIODE-CT-RECT 200V 15A	28480	1905-0231
	1200-0043	8	4	INSULATOR-XSTR ALUMINUM	28480	1200-0043
	1205-0021	2	1	HEAT SINK TO-3-CS	28480	1205-0021
	2190-0006	1	4	WASHER-LK HLCL NO. 6 .141-IN-ID	28480	2190-0006
	2360-0229	1	2	SCREW-MACH 6-32 .562-IN-LG PAN-HD-POZI	00000	ORDER BY DESCRIPTION
	2420-0002	6	4	NUT-HEX-DBL-CHAM 6-32-THD .109-IN-THK	28480	2420-0002
	3050-0227	3	4	WASHER-FL MTLN NO. 6 .149-IN-ID	28480	3050-0227

↑ Refer to Section 7 for update information.

* Factory Selected Component (Refer to Section 5).

△ Errata part change.

Table 6-3. Replaceable Parts

Reference Designation	HP Part Number	C D	Qty.	Description	Mfr. Code	Mfr. Part Number
A13 08903-60129/192/292 – SERIAL PREFIX 2450A TO 2922A						
<i>2450A TO 2922A</i>						
A13CR6	1901-0159	3	7	DIODE-PWR RECT 400V 750MA DO-41	28480	1901-0159
A13CR7	1901-0033	2		DIODE-GEN PRP 180V 200MA DO-7	28480	1901-0033
A13CR8	1901-0033	2		DIODE-GEN PRP 180V 200MA DO-7	28480	1901-0033
A13CR9	1901-0033	2		DIODE-GEN PRP 180V 200MA DO-7	28480	1901-0033
A13CR10	1901-0033	2		DIODE-GEN PRP 180V 200MA DO-7	28480	1901-0033
A13CR11	1901-0159	3		DIODE-PWR RECT 400V 750MA DO-41	28480	1901-0159
<i>2450A TO 2922A</i>						
A13CR12	1901-0159	3		DIODE-PWR RECT 400V 750MA DO-41	28480	1901-0159
A13CR13	1901-0159	3		DIODE-PWR RECT 400V 750MA DO-41	28480	1901-0159
A13CR14	1901-0159	3		DIODE-PWR RECT 400V 750MA DO-41	28480	1901-0159
A13CR15	1901-0159	3		DIODE-PWR RECT 400V 750MA DO-41	28480	1901-0159
A13CR16	1901-0159	3		DIODE-PWR RECT 400V 750MA DO-41	28480	1901-0159
A13DS1	1990-0485	5	4	LED-LAMP LUM-INT=800UCD IF=30MA-MAX	28480	5082-4984
<i>2450A TO 2922A</i>						
A13DS2	1990-0485	5		LED-LAMP LUM-INT=800UCD IF=30MA-MAX	28480	5082-4984
A13DS3	1990-0485	5		LED-LAMP LUM-INT=800UCD IF=30MA-MAX	28480	5082-4984
A13DS4	1990-0485	5		LED-LAMP LUM-INT=800UCD IF=30MA-MAX	28480	5082-4984
A13J1	1251-4736	1	1	CONNECTOR 26-PIN M RECTANGULAR	28480	1251-4736
A13J2	1251-3412	8	1	CONNECTOR 6-PIN M POST TYPE	28480	1251-3412
A13J3	1251-5169	6	2	CONNECTOR 6-PIN M POST TYPE	28480	1251-5169
A13JP1-B	8159-0005	0		RESISTOR-ZERO OHMS 22 AWG LEAD DIA	28480	8159-0005
A13JP1-E	8159-0005	0		RESISTOR-ZERO OHMS 22 AWG LEAD DIA	28480	8159-0005
A13J4	1251-5169	6		CONNECTOR 6-PIN M POST TYPE	28480	1251-5169
<i>2450A TO 2922A</i>						
A13L1	9140-0137	1	1	INDUCTOR RF-CH-MLD 1MH 5% .2DX 45LG Q=60	28480	9140-0137
A13L2	9100-3922	4	5	INDUCTOR-FIXED 120-1300 HZ	28480	9100-3922
A13L3	9100-3922	4		INDUCTOR-FIXED 120-1300 HZ	28480	9100-3922
A13L4	9100-3922	4		INDUCTOR-FIXED 120-1300 HZ	28480	9100-3922
A13L5	9100-3922	4		INDUCTOR-FIXED 120-1300 HZ	28480	9100-3922
A13L6	9100-3922	4		INDUCTOR-FIXED 120-1300 HZ	28480	9100-3922
A13L7	9140-0210	1		INDUCTOR RF-CH-MLD 100UH 5% .166DX 385LG	28480	9140-0210
A13MP1	0403-0285	9	8	BUMPER FOOT-ADH MTG 12.7-MM-WD	28480	0403-0285
A13Q1	1854-0477	7		TRANSISTOR NPN 2N2222A SI TO-18 PD=500MW	04713	2N2222A
	1205-0012	1	1	HEAT SINK TO-18-CS	28480	1205-0012
A13Q2	1884-0005	0	1	THYRISTOR-SCR VRRM=50	04713	MCR649P-2
	2190-0006	1		WASHER-LK HLCL NO. 6 .141-IN-ID	28480	2190-0006
	2360-0229	1		SCREW-MACH 6-32 .562-IN-LG PAN-HD-POZI	00000	ORDER BY DESCRIPTION
	2420-0002	6		NUT-HEX-DBL-CHAM 6-32-THD .109-IN-THK	28480	2420-0002
	3050-0227	3		WASHER-FL MTLC NO. 6 .149-IN-ID	28480	3050-0227
A13Q3	1884-0276	7	1	THYRISTOR-TRIAC TO-220AB	28480	1884-0276
	2190-0006	1		WASHER-LK HLCL NO. 6 .141-IN-ID	28480	2190-0006
	2360-0229	1		SCREW-MACH 6-32 .562-IN-LG PAN-HD-POZI	00000	ORDER BY DESCRIPTION
	2420-0002	6		NUT-HEX-DBL-CHAM 6-32-THD .109-IN-THK	28480	2420-0002
	3050-0227	3		WASHER-FL MTLC NO. 6 .149-IN-ID	28480	3050-0227
<i>2450A TO 2910A</i>						
A13Q4	1884-0244	9	3	THYRISTOR-SCR VRRM=400	3L585	S2600D
A13Q5	1884-0244	9		THYRISTOR-SCR VRRM=400	3L585	S2600D
A13Q6	1884-0244	9		THYRISTOR-SCR VRRM=400	3L585	S2600D
<i>2922A ONLY</i>						
A13Q4	1884-0345	1	3	THYRISTOR-SCR VRRM=400	3L585	S2600D
A13Q5	1884-0345	1		THYRISTOR-SCR VRRM=400	3L585	S2600D
A13Q6	1884-0345	1		THYRISTOR-SCR VRRM=400	3L585	S2600D
<i>2450A TO 2652A</i>						
A13Q7				NOT ASSIGNED		
<i>2717A TO 2922A</i>						
A13Q7	1854-0477	7		TRANSISTOR NPN 2N2222A SI TO-18 PD=500MW	04712	2N2222A

†Refer to Section 7 for update information.

*Factory Selected Component (Refer to Section 5).

Δ Errata part change.

Table 6-3. Replaceable Parts

Reference Designation	HP Part Number	C D	Qty.	Description	Mfr. Code	Mfr. Part Number
A13 08903-60129/192/292 – SERIAL PREFIX 2450A TO 2922A						
A13R1	0757-0401	0		RESISTOR 100 1% .125W F TC=0+-100	24546	C4-1/8-T0-101-F
A13R2	0698-3429	2	1	RESISTOR 19.6 1% .125W F TC=0+-100	03888	PME55-1/8-T0-19R3-F
A13R3	0757-0401	0		RESISTOR 100 1% .125W F TC=0+-100	24546	C4-1/8-T0-101-F
A13R4	0757-0440	7		RESISTOR 7.5K 1% .125W F TC=0+-100	24546	C4-1/8-T0-7501-F
A13R5	8110-0180	0	1	RIBBON-RES .157-OHM/FT .0253X.0625	28480	8110-0180
A13R6	0757-0460	1	1	RESISTOR 61.8K 1% .125W F TC=0+-100	24546	C4-1/8-T0-6192-F
A13R7	0757-0280	3		RESISTOR 1K 1% .125W F TC=0+-100	24546	C4-1/8-T0-1001-F
A13R8	0698-0083	8		RESISTOR 1.96K 1% .125W F TC=0+-100	24548	C4-1/8-T0-1961-F
A13R9	0757-0394	0		RESISTOR 51.1 1% .125W F TC=0+-100	24546	C4-1/8-T0-51R1-F
A13R10	0757-0394	0		RESISTOR 51.1 1% .125W F TC=0+-100	24546	C4-1/8-T0-51R1-F
A13R11	0757-0290	5		RESISTOR 6.19K 1% .125W F TC=0+-100	19701	MF4C1/8-T0-6191-F
A13R12	0698-4020	1		RESISTOR 9.53K 1% .125W F TC=0+-100	24546	C4-1/8-T0-9531-F
A13R13	0757-0274	5		RESISTOR 1.21K 1% .125W F TC=0+-100	24546	C4-1/8-T0-1211-F
A13R14	0757-0401	0		RESISTOR 100 1% .125W F TC=0+-100	24546	C4-1/8-T0-101-F
<i>2450A TO 2922A</i>						
A13R15	0757-0401	0		RESISTOR 100 1% .125W F TC=0+-100	24546	C4-1/8-T0-101-F
A13R16	0757-0401	0		RESISTOR 100 1% .125W F TC=0+-100	24546	C4-1/8-T0-101-F
A13R17	0757-0401	0		RESISTOR 100 1% .125W F TC=0+-100	24546	C4-1/8-T0-101-F
A13R18	0757-0280	3		RESISTOR 1K 1% .125W F TC=0+-100	24546	C4-1/8-T0-1001-F
A13R19	0757-0401	0		RESISTOR 100 1% .125W F TC=0+-100	24546	C4-1/8-T0-101-F
<i>2450A TO 2910A</i>						
A13R20	0757-0442	9		RESISTOR 10K 1% .125W F TC=0+-100	24546	C4-1/8-T0-1002-F
<i>2922A ONLY</i>						
A13R20	0698-3437	2		RESISTOR 133 1% .125W F TC=0+-100	24546	C4-1/8-T0-133R-F
<i>2450A TO 2922A</i>						
A13R21	0757-0401	0		RESISTOR 100 1% .125W F TC=0+-100	24546	C4-1/8-T0-101-F
<i>2450A TO 2910A</i>						
A13R22	0757-0442	9		RESISTOR 10K 1% .125W F TC=0+-100	24546	C4-1/8-T0-1002-F
<i>2922A ONLY</i>						
A13R22	0757-0401	0		RESISTOR 100 1% .125W F TC=0+-100	24546	C4-1/8-T0-101-F
A13R23	0757-0401	0		RESISTOR 100 1% .125W F TC=0+-100	24546	C4-1/8-T0-101-F
A13R24	0757-0442	9		RESISTOR 10K 1% .125W F TC=0+-100	24546	C4-1/8-T0-1002-F
A13R25	0757-0401	0		RESISTOR 100 1% .125W F TC=0+-100	24546	C4-1/8-T0-101-F
<i>2450A TO 2910A</i>						
A13R26	0757-0442	9		RESISTOR 10K 1% .125W F TC=0+-100	24546	C4-1/8-T0-1002-F
<i>2922A ONLY</i>						
A13R26	0698-3437	2		RESISTOR 133 1% .125W F TC=0+-100	24546	C4-1/8-T0-133R-F
A13R27	0698-8827	4		RESISTOR 1M 1% .125W F TC=0+-100	28480	0698-8827
<i>2450A TO 2652A</i>						
A13R28				NOT ASSIGNED		
A13R29				NOT ASSIGNED		
<i>2717A TO 2922A</i>						
A13R28	0757-0280	3		RESISTOR 1K 1% .125W F TC=0+-100	25456	C4-1/8-T0-1001-F
A13R29	0698-3132	4		RESISTOR 261 1% .125W F TC=0+-100	25456	C4-1/8-T0-2610-F

†Refer to Section 7 for update information.

*Factory Selected Component (Refer to Section 5).

△ Errata part change.

Table 6-3. Replaceable Parts

Reference Designation	HP Part Number	C D	Qty.	Description	Mfr. Code	Mfr. Part Number
A13 08903-60129/192/292 – SERIAL PREFIX 2450A TO 2922A						
A13TP1	1251-0600	0		CONNECTOR-SGL CONT PIN 1.14-MM-BSC-SZ SQ	28480	1251-0600
A13TP2	1251-0600	0		CONNECTOR-SGL CONT PIN 1.14-MM-BSC-SZ SQ	28480	1251-0600
A13TP3	1251-0600	0		CONNECTOR-SGL CONT PIN 1.14-MM-BSC-SZ SQ	28480	1251-0600
<i>2450A TO 2922A</i>						
A13TP4	1251-0600	0		CONNECTOR-SGL CONT PIN 1.14-MM-BSC-SZ SQ	28480	1251-0600
A13TP5	1251-0600	0		CONNECTOR-SGL CONT PIN 1.14-MM-BSC-SZ SQ	28480	1251-0600
A13TP6	1251-0600	0		CONNECTOR-SGL CONT PIN 1.14-MM-BSC-SZ SQ	28480	1251-0600
<i>2450A TO 2652A</i>						
A13U1	1826-0785	1		IC OP AMP LOW-BIAS-H-IMPD DUAL 8-DIP-C	01295	TL072ACJG
<i>2717A TO 2922A</i>						
A13U1	5180-1817	1		IC OP AMP LOW-BIAS-H-IMPD DUAL I-DIP-C	01295	TL072ACJG
<i>2450A TO 2922A</i>						
A13U2	1826-0117	3	1	IC 7812 V RGLTR TO-3	07263	7812KC
	2190-0006	1		WASHER-LK HLCL NO. 6 .141-IN-ID	28480	2190-0006
	2360-0229	1		SCREW-MACH 6-32 .562-IN-LG PAN-HD-POZI	00000	ORDER BY DESCRIPTION
A13VR1	1902-3381	1	2	DIODE-ZNR 68.1V 5% DO-7 PD=.4W TC=+.079%	28480	1902-3381
A13VR2	1902-3381	1		DIODE-ZNR 68.1V 5% DO-7 PD=.4W TC=+.079%	28480	1902-3381
A13VR3	1902-0950	6	2	DIODE-ZNR 12V 5% DO-35 PD=.4W TC=+.077%	28480	1902-0950
<i>2450A TO 2922A</i>						
A13VR4	1902-0957	1	1	DIODE-ZNR 9.1V 5% DO-35 PD=.4W TC=+.069%	28480	1902-0957
A13VR5	1902-0943	5		DIODE-ZNR 2.4V 5% DO-35 PD=.4W TC=-.037%	28480	1902-0943
A13VR6	1902-0960	6		DIODE-ZNR 12V 5% DO-35 PD=.4W TC=+.077%	28480	1902-0960
A13VR7	1902-3214	9	2	DIODE-ZNR 16.2V 2% DO-35 PD=.4W	28480	1902-3214
<i>2450A TO 2922A</i>						
A13VR8	1902-3194	4	1	DIODE-ZNR 13.3V 2% DO-35 PD=.4W	28480	1902-3194
A13VR9	1902-3107	9	1	DIODE-ZNR 5.76V 2% DO-35 PD=.4W	28480	1902-3107
A13VR10	1902-3214	9		DIODE-ZNR 16.2V 2% DO-35 PD=.4W	28480	1902-3214
A13VR11	1902-3094	3	1	DIODE-ZNR 5.11V 2% DO-35 PD=.4W	28480	1902-3094
A13XA2A	1251-2035	9	7	CONNECTOR-PC EDGE 15-CONT/ROW 2-ROWS	28480	1251-2035
A13XA2B	1251-1365	6	10	CONNECTOR-PC EDGE 22-CONT/ROW 2-ROWS	28480	1251-1365
A13XA3A	1251-2035	9		CONNECTOR-PC EDGE 15-CONT/ROW 2-ROWS	28480	1251-2035
A13XA3B	1251-2035	9		CONNECTOR-PC EDGE 15-CONT/ROW 2-ROWS	28480	1251-2035
A13XA4A	1251-2035	9		CONNECTOR-PC EDGE 15-CONT/ROW 2-ROWS	28480	1251-2035
A13XA4B	1251-2035	9		CONNECTOR-PC EDGE 15-CONT/ROW 2-ROWS	28480	1251-2035
A13XA5A	1251-2035	9		CONNECTOR-PC EDGE 15-CONT/ROW 2-ROWS	28480	1251-2035
A13XA5B	1251-1365	6		CONNECTOR-PC EDGE 22-CONT/ROW 2-ROWS	28480	1251-1365
A13XA6A	1251-2035	9		CONNECTOR-PC EDGE 15-CONT/ROW 2-ROWS	28480	1251-2035
A13XA6B	1251-1365	6		CONNECTOR-PC EDGE 22-CONT/ROW 2-ROWS	28480	1251-1365
A13XA7A	1251-1365	6		CONNECTOR-PC EDGE 22-CONT/ROW 2-ROWS	28480	1251-1365
A13XA7B	1251-1365	6		CONNECTOR-PC EDGE 22-CONT/ROW 2-ROWS	28480	1251-1365
A13XA7C	1251-1365	6		CONNECTOR-PC EDGE 22-CONT/ROW 2-ROWS	28480	1251-1365

† Refer to Section 7 for update information.

* Factory Selected Component (Refer to Section 5).

Δ Errata part change.

Table 6-3. Replaceable Parts

Reference Designation	HP Part Number	C D	Qty.	Description	Mfr. Code	Mfr. Part Number
A13	08903-60129/192/292 – SERIAL PREFIX 2450A TO 2922A					
A13XA8A	1251-1365	6		CONNECTOR-PC EDGE 22-CONT/ROW 2-ROWS	28480	1251-1365
A13XA8B	1251-1365	6		CONNECTOR-PC EDGE 22-CONT/ROW 2-ROWS	28480	1251-1365
A13XA9A	1251-1365	6		CONNECTOR-PC EDGE 22-CONT/ROW 2-ROWS	28480	1251-1365
A13XA9B	1251-1365	6		CONNECTOR-PC EDGE 22-CONT/ROW 2-ROWS	28480	1251-1365
A13XA10	1251-1626	2	1	CONNECTOR-PC EDGE 12-CONT/ROW 2-ROWS	28480	1251-1626
A13XA11	1251-0472	4	1	CONNECTOR-PC EDGE 6-CONT/ROW 2-ROWS	28480	1251-0472
A13XA12	1251-0472	4		CONNECTOR-PC EDGE 6-CONT/ROW 2-ROWS	28480	1251-0472
A13XA12	1251-0472	4		CONNECTOR-PC EDGE 6-CONT/ROW 2-ROWS	28480	1251-0472

†Refer to Section 7 for update information.

*Factory Selected Component (Refer to Section 5).

Δ Errata part change.

Table 6-3. Replaceable Parts

Reference Designation	HP Part Number	C D	Qty.	Description	Mfr. Code	Mfr. Part Number
A13	08903-60392 – SERIAL PREFIX 2948A AND ABOVE					
A13	08903-60392	3	1	POWER SUPPLY MOTHERBOARD	28480	08903-60392
A13C1	0180-2317	8	2	CAPACITOR-FXD 3600UF + 75-10% 40VDC AL	00853	539-7445-02
	2680-0099	1	6	SCREW-MACH 10-32 .375-IN-LG PAN-HD-POZI	00000	ORDER BY DESCRIPTION
	2190-0012	9	6	WASHER-LK EXT T NO. 10 .195-IN-ID	00000	ORDER BY DESCRIPTION
A13C2	0180-2317	8		CAPACITOR-FXD 3600UF + 75-10% 40VDC AL	00853	539-7445-02
	2680-0099	1	6	SCREW-MACH 10-32 .375-IN-LG PAN-HD-POZI	00000	ORDER BY DESCRIPTION
	2190-0012	9	6	WASHER-LK EXT T NO. 10 .195-IN-ID	00000	ORDER BY DESCRIPTION
A13C3	0180-0452	8	1	CAPACITOR-FXD .013F + 75-10% 25VDC AL	28480	0180-0452
	2680-0099	1	6	SCREW-MACH 10-32 .375-IN-LG PAN-HD-POZI	00000	ORDER BY DESCRIPTION
	2190-0012	9	6	WASHER-LK EXT T NO. 10 .195-IN-ID	00000	ORDER BY DESCRIPTION
A13C4				NOT ASSIGNED		
A13C5				NOT ASSIGNED		
A13C6	0180-0291	3		CAPACITOR-FXD 1UF + -10% 35VDC TA	56289	150D105X9035A2
A13C7	0140-0210	2	1	CAPACITOR-FXD 270PF + -5% 300VDC MICA	72136	DM15F271J0300VV1CR
A13C8	0180-0197	8		CAPACITOR-FXD 2.2UF + -10% 20VDC TA	56289	150D225X9020A2
A13C9	0180-0197	8		CAPACITOR-FXD 2.2UF + -10% 20VDC TA	56289	150D225X9020A2
A13C10	0180-0116	1		CAPACITOR-FXD 6.8UF + -10% 35VDC TA	56289	150D685X9035B2
A13C11	0180-0197	8		CAPACITOR-FXD 2.2UF + -10% 20VDC TA	56289	150D225X9020A2
A13C12	0160-0576	5	1	CAPACITOR-FXD .1UF + -20% 50VDC CER	28480	0160-0576
A13C13	0160-2307	4		CAPACITOR-FXD 47PF + -5% 300VDC MICA	28480	0160-2307
A13C14	0160-2307	4		CAPACITOR-FXD 47PF + -5% 300VDC MICA	28480	0160-2307
A13C15	0160-2307	4		CAPACITOR-FXD 47PF + -5% 300VDC MICA	28480	0160-2307
A13C16	0160-2307	4		CAPACITOR-FXD 47PF + -5% 300VDC MICA	28480	0160-2307
A13C17	0160-4805	1		CAPACITOR-FXD 47PF + -5% 100VDC CER 0 + -30	28480	0160-4805
A13C18	0160-5469	5	3	CAPACITOR-FXD 1UF 10% 50VDC	28480	0160-5469
A13C19	0160-5469	5		CAPACITOR-FXD 1UF 10% 50VDC	28480	0160-5469
A13C20	0160-5469	5		CAPACITOR-FXD 1UF 10% 50VDC	28480	0160-5469
A13CR1	1901-0200	5	4	DIODE-PWR RECT 100V 1.5A	28480	1901-0200
A13CR2	1901-0200	5		DIODE-PWR RECT 100V 1.5A	28480	1901-0200
A13CR3	1901-0200	5		DIODE-PWR RECT 100V 1.5A	28480	1901-0200
A13CR4	1901-0200	5		DIODE-PWR RECT 100V 1.5A	28480	1901-0200
A13CR5 ^Δ	1906-0231	2	1	DIODE-CT-RECT 200V 15A	28480	1906-0231
	1200-0043	8	4	INSULATOR-XSTR ALUMINUM	28480	1200-0043
	1205-0021	2	1	HEAT SINK TO-3-CS	28480	1205-0021
	2190-0018	5		WASHER-LK HLCL NO. 6 .141-IN-ID	04604	2190-0018
	2360-0229	1	2	SCREW-MACH 6-32 .562-IN-LG PAN-HD-POZI	00000	ORDER BY DESCRIPTION
	2420-0003	7	4	NUT-HEX-DBL-CHAM 6-32-THD .094-IN-THK	04939	2420-0003
	3050-0010	2		WASHER-FL MTLC NO. 6 .147-IN-ID	04719	65

†Refer to Section 7 for update information.

*Factory Selected Component (Refer to Section 5).

Δ Errata part change.

Table 6-3. Replaceable Parts

Reference Designation	HP Part Number	C D	Qty.	Description	Mfr. Code	Mfr. Part Number
A13	08903-60392 – SERIAL PREFIX 2948A AND ABOVE					
A13CR6				NOT ASSIGNED		
A13CR7	1901-0033	2		DIODE-GEN PRP 180V 200MA DO-7	28480	1901-0033
A13CR8	1901-0033	2		DIODE-GEN PRP 180V 200MA DO-7	28480	1901-0033
A13CR9	1901-0033	2		DIODE-GEN PRP 180V 200MA DO-7	28480	1901-0033
A13CR10	1901-0033	2		DIODE-GEN PRP 180V 200MA DO-7	28480	1901-0033
A13CR11	1901-0159	3		DIODE-PWR RECT 400V 750MA DO-41	28480	1901-0159
A13CR12				NOT ASSIGNED		
A13CR13	1901-0159	3		DIODE-PWR RECT 400V 750MA DO-41	28480	1901-0159
A13CR14	1901-0159	3		DIODE-PWR RECT 400V 750MA DO-41	28480	1901-0159
A13CR15	1901-0159	3		DIODE-PWR RECT 400V 750MA DO-41	28480	1901-0159
A13CR16	1901-0159	3		DIODE-PWR RECT 400V 750MA DO-41	28480	1901-0159
A13DS1	1990-0485	5	4	LED-LAMP LUM-INT=800UCD IF=30MA-MAX	28480	5082-4984
A13DS2				NOT ASSIGNED		
A13DS3	1990-0485	5		LED-LAMP LUM-INT=800UCD IF=30MA-MAX	28480	5082-4984
A13DS4	1990-0485	5		LED-LAMP LUM-INT=800UCD IF=30MA-MAX	28480	5082-4984
A13J1	1251-4736	1	1	CONNECTOR 26-PIN M RECTANGULAR	28480	1251-4736
A13J2	1251-3412	8	1	CONNECTOR 6-PIN M POST TYPE	28480	1251-3412
A13J3	1251-5169	6	2	CONNECTOR 6-PIN M POST TYPE	28480	1251-5169
A13JP1-B	8159-0005	0		RESISTOR-ZERO OHMS 22 AWG LEAD DIA	28480	8159-0005
A13JP1-E	8159-0005	0		RESISTOR-ZERO OHMS 22 AWG LEAD DIA	28480	8159-0005
A13J4	1251-5169	6		CONNECTOR 6-PIN M POST TYPE	28480	1251-5169
A13L1				NOT ASSIGNED		
A13L2	9100-3922	4	5	INDUCTOR-FIXED 120-1300 HZ	28480	9100-3922
A13L3	9100-3922	4		INDUCTOR-FIXED 120-1300 HZ	28480	9100-3922
A13L4	9100-3922	4		INDUCTOR-FIXED 120-1300 HZ	28480	9100-3922
A13L5	9100-3922	4		INDUCTOR-FIXED 120-1300 HZ	28480	9100-3922
A13L6	9100-3922	4		INDUCTOR-FIXED 120-1300 HZ	28480	9100-3922
A13L7	9140-0210	1		INDUCTOR RF-CH-MLD 100UH 5% .166DX.385LG	28480	9140-0210
A13MP1	0403-0285	9	8	JUMPER FOOT-ADH MTG 12.7-MM-WD	28480	0403-0285
A13Q1	1854-0477	7		TRANSISTOR NPN 2N2222A SI TO-18 PD=500MW	04713	2N2222A
	1205-0012	1	1	HEAT SINK TO-18-CS	28480	1205-0012
A13Q2	1884-0005	0	1	THYRISTOR-SCR VRRM=50	04713	MCR649P-2
	2190-0006	1		WASHER-LK HLCL NO. 6 .141-IN-ID	28480	2190-0006
	2360-0229	1		SCREW-MACH 6-32 .562-IN-LG PAN-HD-POZI	00000	ORDER BY DESCRIPTION
	2420-0002	6		NUT-HEX-DBL-CHAM 6-32-THD .109-IN-THK	28480	2420-0002
	3050-0227	3		WASHER-FL MTLC NO. 6 .149-IN-ID	28480	3050-0227
A13Q3	1884-0276	7	1	THYRISTOR-TRIAC TO-220AB	28480	1884-0276
	2190-0006	1		WASHER-LK HLCL NO. 6 .141-IN-ID	28480	2190-0006
	2360-0229	1		SCREW-MACH 6-32 .562-IN-LG PAN-HD-POZI	00000	ORDER BY DESCRIPTION
	2420-0002	6		NUT-HEX-DBL-CHAM 6-32-THD .109-IN-THK	28480	2420-0002
	3050-0227	3		WASHER-FL MTLC NO. 6 .149-IN-ID	28480	3050-0227
A13Q4				NOT ASSIGNED		
A13Q5	1884-0345	1		THYRISTOR-SCR VRRM=400	3L585	S2600D
A13Q6	1884-0345	1		THYRISTOR-SCR VRRM=400	3L585	S2600D
A13Q7	1854-0477	7		TRANSISTOR NPN 2N2222A SI TO-18 PD=500MW	04712	2N2222A

†Refer to Section 7 for update information.

*Factory Selected Component (Refer to Section 5).

Δ Errata part change.

Table 6-3. Replaceable Parts

Reference Designation	HP Part Number	C D	Qty.	Description	Mfr. Code	Mfr. Part Number
A13 08903-60392 – SERIAL PREFIX 2948A AND ABOVE						
A13R1	0757-0401	0		RESISTOR 100 1% .125W F TC=0+-100	24546	C4-1/8-T0-101-F
A13R2	0698-3429	2	1	RESISTOR 19.6 1% .125W F TC=0+-100	03888	PME55-1/8-T0-19R6-F
A13R3	0757-0401	0		RESISTOR 100 1% .125W F TC=0+-100	24546	C4-1/8-T0-101-F
A13R4	0757-0440	7		RESISTOR 7.5K 1% .125W F TC=0+-100	24546	C4-1/8-T0-7501-F
A13R5	8110-0180	0	1	RIBBON-RES .157-OHM/FT .0253X.0625	28480	8110-0180
A13R6	0757-0460	1	1	RESISTOR 61.9K 1% .125W F TC=0+-100	24546	C4-1/8-T0-6192-F
A13R7	0757-0280	3		RESISTOR 1K 1% .125W F TC=0+-100	24546	C4-1/8-T0-1001-F
A13R8	0698-0083	8		RESISTOR 1.96K 1% .125W F TC=0+-100	24546	C4-1/8-T0-1961-F
A13R9	0757-0394	0		RESISTOR 51.1 1% .125W F TC=0+-100	24546	C4-1/8-T0-51R1-F
A13R10	0757-0394	0		RESISTOR 51.1 1% .125W F TC=0+-100	24546	C4-1/8-T0-51R1-F
A13R11	0757-0290	5		RESISTOR 6.19K 1% .125W F TC=0+-100	19701	MF4C1/8-T0-6191-F
A13R12	0698-4020	1		RESISTOR 9.53K 1% .125W F TC=0+-100	24546	C4-1/8-T0-9531-F
A13R13	0757-0274	5		RESISTOR 1.21K 1% .125W F TC=0+-100	24546	C4-1/8-T0-1211-F
A13R14	0757-0401	0		RESISTOR 100 1% .125W F TC=0+-100	24546	C4-1/8-T0-101-F
A13R15				NOT ASSIGNED		
A13R16	0757-0401	0		RESISTOR 100 1% .125W F TC=0+-100	24546	C4-1/8-T0-101-F
A13R17	0757-0401	0		RESISTOR 100 1% .125W F TC=0+-100	24546	C4-1/8-T0-101-F
A13R18	0757-0280	3		RESISTOR 1K 1% .125W F TC=0+-100	24546	C4-1/8-T0-1001-F
A13R19	0757-0401	0		RESISTOR 100 1% .125W F TC=0+-100	24546	C4-1/8-T0-101-F
A13R20	0698-3437	2		RESISTOR 133 1% .125W F TC=0+-100	24546	C4-1/8-T0-133R-F
A13R21				NOT ASSIGNED		
A13R22				NOT ASSIGNED		
A13R23	0757-0401	0		RESISTOR 100 1% .125W F TC=0+-100	24546	C4-1/8-T0-101-F
A13R24	0757-0442	9		RESISTOR 10K 1% .125W F TC=0+-100	24546	C4-1/8-T0-1002-F
A13R25	0757-0401	0		RESISTOR 100 1% .125W F TC=0+-100	24546	C4-1/8-T0-101-F
A13R26	0698-3437	2		RESISTOR 133 1% .125W F TC=0+-100	24546	C4-1/8-T0-133R-F
A13R27	0698-8827	4		RESISTOR 1M 1% .125W F TC=0+-100	28480	0698-8827
A13R28	0757-0280	3		RESISTOR 1K 1% .125W F TC=0+-100	25456	C4-1/8-T0-1001-F
A13R29	0690-3132	4		RESISTOR 261 1% .125W F TC=0+-100	25456	C4-1/8-T0-2610-F

†Refer to Section 7 for update information.

*Factory Selected Component (Refer to Section 5).

Δ Errata part change.

Table 6-3. Replaceable Parts

Reference Designation	HP Part Number	C D	Qty.	Description	Mfr. Code	Mfr. Part Number
A13 08903-60392 – SERIAL PREFIX 2948A AND ABOVE						
A13TP1	1251-0600	0		CONNECTOR-SGL CONT PIN 1.14-MM-BSC-SZ SQ	28480	1251-0600
A13TP2	1251-0600	0		CONNECTOR-SGL CONT PIN 1.14-MM-BSC-SZ SQ	28480	1251-0600
A13TP3	1251-0600	0		CONNECTOR-SGL CONT PIN 1.14-MM-BSC-SZ SQ	28480	1251-0600
A13TP4				NOT ASSIGNED		
A13TP5	1251-0600	0		CONNECTOR-SGL CONT PIN 1.14-MM-BSC-SZ SQ	28480	1251-0600
A13TP6	1251-0600	0		CONNECTOR-SGL CONT PIN 1.14-MM-BSC-SZ SQ	28480	1251-0600
A13U1	5180-1817	1		IC OP AMP LOW-BIAS-HMPD DUAL I-DIP-C	01295	TL072ACJG
A13U2				NOT ASSIGNED		
	2190-0006	1		WASHER-LK HLCL NO. 6 .141-IN-HD	28480	2190-0006
	2360-0229	1		SCREW-MACH 6-32 .562-IN-LG PAN-HD-POZI	00000	ORDER BY DESCRIPTION
A13VR1	1902-3381	1	2	DIODE-ZNR 68.1V 5% DO-7 PD = .4W TC = +.079%	28480	1902-3381
A13VR2	1902-3381	1		DIODE-ZNR 68.1V 5% DO-7 PD = .4W TC = +.079%	28480	1902-3381
A13VR3	1902-0960	6	2	DIODE-ZNR 12V 5% DO-35 PD = .4W TC = +.077%	28480	1902-0960
A13VR4				NOT ASSIGNED		
A13VR5	1902-0943	5		DIODE-ZNR 2.4V 5% DO-35 PD = .4W TC = -.037%	28480	1902-0943
A13VR6	1902-0960	6		DIODE-ZNR 12V 5% DO-35 PD = .4W TC = +.077%	28480	1902-0960
A13VR7	1902-3214	9	2	DIODE-ZNR 16.2V 2% DO-35 PD = .4W	28480	1902-3214
A13VR8				NOT ASSIGNED		
A13VR9	1902-3107	9	1	DIODE-ZNR 5.76V 2% DO-35 PD = .4W	28480	1902-3107
A13VR10	1902-3214	9		DIODE-ZNR 16.2V 2% DO-35 PD = .4W	28480	1902-3214
A13VR11	1902-3094	3	1	DIODE-ZNR 5.11V 2% DO-35 PD = .4W	28480	1902-3094
A13XA2A	1251-2035	9	7	CONNECTOR-PC EDGE 15-CONT/ROW 2-ROWS	28480	1251-2035
A13XA2B ^Δ	1252-4187	8	10	CONNECTOR-PC EDGE 22-CONT/ROW 3-ROWS	28480	1252-4187
A13XA3A	1251-2035	9		CONNECTOR-PC EDGE 15-CONT/ROW 2-ROWS	28480	1251-2035
A13XA3B	1251-2035	9		CONNECTOR-PC EDGE 15-CONT/ROW 2-ROWS	28480	1251-2035
A13XA4A	1251-2035	9		CONNECTOR-PC EDGE 15-CONT/ROW 2-ROWS	28480	1251-2035
A13XA4B	1251-2035	9		CONNECTOR-PC EDGE 15-CONT/ROW 2-ROWS	28480	1251-2035
A13XA5A	1251-2035	9		CONNECTOR-PC EDGE 15-CONT/ROW 2-ROWS	28480	1251-2035
A13XA5B ^Δ	1252-4187	8		CONNECTOR-PC EDGE 22-CONT/ROW 3-ROWS	28480	1252-4187
A13XA6A	1251-2035	9		CONNECTOR-PC EDGE 15-CONT/ROW 2-ROWS	28480	1251-2035
A13XA6B ^Δ	1252-4187	8		CONNECTOR-PC EDGE 22-CONT/ROW 3-ROWS	28480	1252-4187
A13XA7A ^Δ	1252-4187	8		CONNECTOR-PC EDGE 22-CONT/ROW 3-ROWS	28480	1252-4187
A13XA7B ^Δ	1252-4187	8		CONNECTOR-PC EDGE 22-CONT/ROW 3-ROWS	28480	1252-4187
A13XA7C ^Δ	1252-4187	8		CONNECTOR-PC EDGE 22-CONT/ROW 3-ROWS	28480	1252-4187
A13XA8A ^Δ	1252-4187	8		CONNECTOR-PC EDGE 22-CONT/ROW 3-ROWS	28480	1252-4187
A13XA8B ^Δ	1252-4187	8		CONNECTOR-PC EDGE 22-CONT/ROW 3-ROWS	28480	1252-4187
A13XA9A ^Δ	1252-4187	8		CONNECTOR-PC EDGE 22-CONT/ROW 3-ROWS	28480	1252-4187
A13XA9B ^Δ	1252-4187	8		CONNECTOR-PC EDGE 22-CONT/ROW 3-ROWS	28480	1252-4187
A13XA10	1251-1626	2	1	CONNECTOR-PC EDGE 12-CONT/ROW 2-ROWS	28480	1251-1626
A13XA11	1251-0472	4	1	CONNECTOR-PC EDGE 6-CONT/ROW 2-ROWS	28480	1251-0472
A13XA12	1251-0472	4		CONNECTOR-PC EDGE 6-CONT/ROW 2-ROWS	28480	1251-0472
A13XA12	1251-0472	4		CONNECTOR-PC EDGE 6-CONT/ROW 2-ROWS	28480	1251-0472

†Refer to Section 7 for update information.

*Factory Selected Component (Refer to Section 5).

Δ Errata part change.

Table 6-3. Replaceable Parts

Reference Designation	HP Part Number	C D	Qty.	Description	Mfr. Code	Mfr. Part Number
A14						
A14	0960-0443	1	1	LINE POWER MODULE	28480	0960-0443
A14TB1	0960-0736	5	1	LINE VOLTAGE SELECTION CARD	28480	0960-0736

†Refer to Section 7 for update information.

*Factory Selected Component (Refer to Section 5).

Δ Errata part change.

Table 6-3. Replaceable Parts

Reference Designation	HP Part Number	C D	Qty.	Description	Mfr. Code	Mfr. Part Number
2450A TO 2601A F1	2110 0039	6	1	FUSE 1.5A 250V TD 1.25X.25 UL (FOR 115V OPERATION)	71400	MDX 1-1/2
F1	2110 0360	2	1	FUSE .75A 250V TD 1.25X.25 UL (FOR 230V OPERATION)	26480	2110-0360
2611A AND ABOVE F1	2110-0043	8	1	FUSE 1.5A 250V NTD 1.25X.25 UL (FOR 115V OPERATION)	26480	2110-0043
F1	2110 0001	8	1	FUSE 1A 250V NTD 1.25X.25 UL (FOR 230V OPERATION)	75915	312001
J1				CONNECTOR "OUTPUT HIGH" NSR P/O W1 (EXCEPT OPTION 001)		
J2				CONNECTOR "OUTPUT LOW" NSR P/O W1 (EXCEPT OPTION 001)		
J3	1510-0038 2190 0027 2950 0006	8 6 3	2 2 2	BINDING POST ASSY SGL THD-STUD WASHER-LK INTL T 1/4 IN .256-IN-ID NUT-HEX-DBL-CHAM 1/4-32-THD .094-IN-THK	26480 26480 00000	1510-0038 2190-0027 ORDER BY DESCRIPTION
J4				CONNECTOR "INPUT HIGH" NSR P/O W2 (EXCEPT OPTION 001)		
J5				CONNECTOR "INPUT LOW" NSR P/O W2 (EXCEPT OPTION 001)		
J6	1510-0038 2190 0027 2950 0006	8 6 3		BINDING POST ASSY SGL THD-STUD WASHER-LK INTL T 1/4 IN .256-IN-ID NUT-HEX-DBL-CHAM 1/4-32-THD .094-IN-THK	26480 26480 00000	1510-0038 2190-0027 ORDER BY DESCRIPTION
J7				CONNECTOR "OUTPUT HIGH" NSR P/O W3 (EXCEPT OPTION 001)		
J8				CONNECTOR "OUTPUT LOW" NSR P/O W3 (EXCEPT OPTION 001)		
J9				CONNECTOR "INPUT HIGH" NSR P/O W4 (EXCEPT OPTION 001)		
J10				CONNECTOR "INPUT LOW" NSR P/O W4 (EXCEPT OPTION 001)		
M1	1120 0694 0380 1155 2260 0009 0380 0053 2820-0002 0590-1580	5 4 3 7 4 4	1 4 4 2 2 4	METER 1 MA; LESS THAN 500 OHMS; 1.75 X SPACER-RND .2-IN-LG .12-IN-ID .25-IN-OD NUT-HEX-W/LKWR 4-40-THD .094-IN-THK TERMINAL SLDR LUG LK MTG FOR #10-SCRN NUT-HEX-DBL-CHAM 10-32-THD .094-IN-THK THREADED INSERT-STDF M3X0.5 14-MM-LG	26480 00000 00000 26480 00000 26480	1120-0694 ORDER BY DESCRIPTION ORDER BY DESCRIPTION 0380-0053 ORDER BY DESCRIPTION 0590-1580
2450A TO 2908A MP1				NO LONGER AVAILABLE. (SEE SECTION 7)		
2910A AND ABOVE MP1	08903-20298	4	1	FRONT FRAME, MODIFIED	26480	08903-20298
2450A ONLY MP2	5020 8836 2510 0192	5 6	4 16	CORNER STRUT SCREW-MACH 8-32 .25-IN-LG 100 DEG (ATTACHES CORNER STRUT TO FRONT AND REAR FRAME)	26480 00000	5020-8836 ORDER BY DESCRIPTION
MP3	08903-60168 2360 0115	1 4	1 38	REAR PANEL ASSEMBLY SCREW-MACH 6-32 .312-IN-LG PAN-HD-POZI (ATTACH MOTHERBOARD TO REAR PANEL ASSY)	26480 00000	08903-60168 ORDER BY DESCRIPTION
2520A AND ABOVE MP2	5021-5836 0515-1331	1 5	4 16	CORNER STRUT SCREW-METRIC SPECIALTY M4 X 0.7 THD. 6 (ATTACHES CORNER STRUT TO FRONT AND REAR FRAME)	26480 26480	5021-5836 0515-1331
MP3	08903-60169 0515-1950	2 4	1 4	REAR PANEL ASSEMBLY SCREW-MACH M3 X 0.5 8MM-LG PNTX (ATTACH MOTHERBOARD TO REAR PANEL ASSY)	26480 00000	08903-60169 ORDER BY DESCRIPTION

†Refer to Section 7 for update information.

*Factory Selected Component (Refer to Section 5).

Δ Errata part change.

Table 6-3. Replaceable Parts

Reference Designation	HP Part Number	C D	Qty.	Description	Mfr. Code	Mfr. Part Number
2450A TO 2908A						
MP4				NO LONGER AVAILABLE, (SEE SECTION 7)		
MP5				NO LONGER AVAILABLE, (SEE SECTION 7)		
MP6				NO LONGER AVAILABLE, (SEE SECTION 7)		
2910A AND ABOVE						
MP4	08903-00148	1	1	COVER, TOP	28480	08903-00148
MP5	5062-3892	1	1	COVER, BOTTOM	28480	5062-3892
MP6	5041-8802	9	1	TRIM STRIP, TOP	28480	5041-8802
MP7	08903-60158	7	1	COVER, CARD CAGE	28480	08903-60158
2450A TO 2730A						
MP8 (STD)	08903-00034			FRONT PANEL, STANDARD	28480	08903-00034
MP8 (OPT 001)	08903-00055			FRONT PANEL, OPTION 001 ONLY	28480	08903-00055
2742A TO 2908A						
MP8 (STD)				NO LONGER AVAILABLE, (SEE SECTION 7)		
MP8 (OPT 001)			1	NO LONGER AVAILABLE, (SEE SECTION 7)		
2910A AND ABOVE						
MP8	08903-00145	8	1	FRONT PANEL, STANDARD	28480	08903-00145
MP8	08903-00146	9	1	FRONT PANEL, OPTION 001 ONLY	28480	08903-00146
2450A TO 2730A						
MP9	08903-00110	6	1	SUB-PANEL	28480	08903-00110
	0515-1227	8	6	SCREW-MACH M3 X 0.5 6MM-LG 90-DEG-FLH-HD (ATTACH SUB-PANEL TO FRONT FRAME)	28480	0515-1227
	0515-1950	4		SCREW-MACH M3 X 0.5 8MM-LG PNTX (ATTACHES GROUND LUG TO SUB-PANEL)	00000	ORDER BY DESCRIPTION
	1400-0519	7		CLAMP-HOSE 1.313-2.25-DIA .562-WD SST	28480	1400-0519
2742A AND ABOVE						
MP9	08903-00135	6	1	SUB-PANEL	28480	08903-00135
	0515-1227	8	6	SCREW-MACH M3 X 0.5 6MM-LG 90-DEG-FLH-HD (ATTACH SUB-PANEL TO FRONT FRAME)	28480	0515-1227
	0515-1950	4		SCREW-MACH M3 X 0.5 8MM-LG PNTX (ATTACH KEYBOARD TO SUB-PANEL)	00000	ORDER BY DESCRIPTION
	1400-0519	7		CLAMP-HOSE 1.313-2.25-DIA .562-WD SST	28480	1400-0519
2450A TO 2908A						
MP10				NO LONGER AVAILABLE, (SEE SECTION 7)		
MP11				NO LONGER AVAILABLE, (SEE SECTION 7)		
MP12				NO LONGER AVAILABLE, (SEE SECTION 7)		
MP13				NO LONGER AVAILABLE, (SEE SECTION 7)		
MP14				NO LONGER AVAILABLE, (SEE SECTION 7)		
MP15				NO LONGER AVAILABLE, (SEE SECTION 7)		
MP16				NO LONGER AVAILABLE, (SEE SECTION 7)		
MP17				NO LONGER AVAILABLE, (SEE SECTION 7)		
2910A AND ABOVE						
MP10	5001-0539	9	1	TRIM STRIP, SIDE	28480	5001-0539
MP11	5041-8819	8	2	HANDLE CAP, FRONT	28480	5041-8819
	0515-0262	9	2	SCREW-THD-RLG M3 X 0.5 7MM-LG PAN-HD (ATTACHES HANDLE TO SIDE COVER)	00000	ORDER BY DESCRIPTION
MP12	5062-3703	3	2	STRAP HANDLE	28480	5062-3703
MP13	5041-8820	1	1	HANDLE CAP, REAR	28480	5041-8820
	2680-0118	5		SCREW-MACH 10-32 .5-IN-LG 82 DEG (ATTACHES HANDLE TO SIDE COVER)	00000	ORDER BY DESCRIPTION
MP14	5062-3836	3	2	COVER, SIDE	28480	5062-3836
MP15	08903-00150	5	1	PULL-OUT CARD, OPERATING INFO	28480	08903-00150
MP16	08903-00151	6	1	PULL-OUT CARD, ERROR DISPLAY, HP-IB	28480	08903-00151
MP17	08903-00149	2	1	PULL-OUT INFO CARD TRAY	28480	08903-00149
MP18	1460-1345	5	1	TILT STAND SST	28480	1460-1345
2450A TO 2908A						
MP19				NO LONGER AVAILABLE, (SEE SECTION 7)		
MP20				NO LONGER AVAILABLE, (SEE SECTION 7)		
2910A AND ABOVE						
MP19	5041-8801	8	4	FOOT, BOTTOM	28480	5041-8801
MP20	5041-8821	2	4	STANDOFF, REAR PANEL	28480	5041-8821
	0515-0067	2	4	SCREW-MACH M3.5 X 0.6 10MM-LG PAN-HD (ATTACH STANDOFF TO REAR PANEL ASSEMBLY)	28480	0515-0067

†Refer to Section 7 for update information.

*Factory Selected Component (Refer to Section 5).

Δ Errata part change.

Table 6-3. Replaceable Parts

Reference Designation	HP Part Number	C D	Qty.	Description	Mfr. Code	Mfr. Part Number
MP21				NOT ASSIGNED		
MP22	08903-40001	9	1	LABEL HOLDER	28480	08903-40001
MP23	08903-90047	8		LABELS, SHEET OF 51 FILTER INCLUDES: 400Hz HIGH-PASS FILTER C-MESSAGE WEIGHTING FILTER CCIR/ARM WEIGHTING FILTER "A" WEIGHTING FILTER	28480	08903-90047
MP24	08903-60201	3	1	CARD CAGE	28480	08903-60201
	0515-1950	4		SCREW-MACH M3 X 0.5 8MM-LG PNTX (ATTACHES CARD CAGE TO MOTHERBOARD AND TO CORNER STRUTS)	00000	ORDER BY DESCRIPTION
	2190 0584	0	12	WASHER-LK HLCL 3.0 MM 3 1-MM-ID	28480	2190-0584
	1400 1016	1		CLAMP MULTIPLE TYPE	28480	1400-1016
MP25	1400 0997	0	1	CLAMP-FL-CA 1-WD	06915	CFCC-8
	0510-1839	8		SCREW-MACH M3 X 0.5 8-MM-LG PAN-HD (ATTACHES CLAMP TO CARD CAGE)	00000	ORDER BY DESCRIPTION
	2190 0584	0	12	WASHER-LK HLCL 3.0 MM 3.1-MM-ID	28480	2190-0584
MP26				NOT ASSIGNED		
MP27	08903-00102	7	1	SUPPORT, LEFT	28480	08903-00103
	0515-1950	4		SCREW-MACH M3 X 0.5 8MM-LG PNTX (ATTACHES SUPPORT TO CORNER STRUT AND MOTHERBOARD)	00000	ORDER BY DESCRIPTION
MP28	08903-20054	0	1	HEAT SINK PANEL	28480	08903-20054
	0515 0365	3	6	SCREW-MACH ASSY M2 X 0.4 4MM-LG	00000	ORDER BY DESCRIPTION
	0515 0374	4	6	SCREW-MACH ASSY M3 X 0.5 10MM-LG	00000	ORDER BY DESCRIPTION
MP29	08903-00010	6	2	HEAT SINK COVER	28480	08903-00010
	0515 1329	8		SCREW-MACH M3 X 0.5 8MM-LG PAN-HD	00000	ORDER BY DESCRIPTION
	0515-0374	4	6	SCREW-MACH ASSY M3 X 0.5 10MM-LG	00000	0515-0374
	0515 0365	3	6	SCREW-MACH ASSY M2 X 0.4 4MM-LG	00000	0515-0365
2305A TO 2720A MP30	08903-00017	3	1	POWER SHIELD	28480	08903 00017
2720A AND ABOVE MP30				NOT ASSIGNED		
MP31	08903-00043	5	1	LABEL PANEL REAR (OPTION 001 ONLY)	28480	08903-00043
	0515-1950	4		SCREW-MACH M3 X 0.5 8MM-LG PNTX (ATTACHES PANEL TO HEATSINK PANEL)	00000	ORDER BY DESCRIPTION
	0515-0365	3	6	SCREW-MACH ASSY M3 X 0.5 10MM-LG	00000	ORDER BY DESCRIPTION
	0515 0374	4	6	SCREW-MACH ASSY M3 X 0.5 10MM-LG	00000	ORDER BY DESCRIPTION
MP31	08903-00018	4	1	LABEL PANEL REAR (EXCEPT OPTION 001)	28480	08903-00018
	0515-1950	4		SCREW-MACH M3 X 0.5 8MM-LG PNTX (ATTACHES PANEL TO HEATSINK PANEL)	00000	ORDER BY DESCRIPTION
	0515 0365	3	6	SCREW-MACH ASSY M2 X 0.4 4MM-LG	00000	ORDER BY DESCRIPTION
	0515 0374	4	6	SCREW-MACH ASSY M3 X 0.5 10MM-LG	00000	ORDER BY DESCRIPTION
MP32	7121-4953	1	1	NAMEPLATE 9 23-MM-WD 13 7-MM-LG CU	03211	7121-4953
MP33				NOT ASSIGNED		
MP34	7120 4295	6	1	LABEL "WARNING: HAZARDOUS VOLTAGE ALWAYS PRESENT IN THIS AREA..."	28480	7120-4295
2450A ONLY MP35	7120 5911	5	1	LABEL "CAUTION: METRIC THREADED"	28480	7120-5911
2520A AND ABOVE MP35				NOT ASSIGNED		
MP36				NOT ASSIGNED		
MP37	7120-8138	4	1	LABEL "CAUTION REMOVE FOUR FEET..."	28480	7120-8138
MP38				NOT ASSIGNED		
MP39				NOT ASSIGNED		
MP40	0590 1231	6		NUT-SPCLY 15/32-32-THD .1-IN-THK 562-WD	00000	ORDER BY DESCRIPTION
MP41	2190-0068	5		WASHER-LK INTL T 1/2-IN .505 IN-ID	28480	2190-0068
MP42	2190 0102	8		WASHER-LK INTL T 15/32-IN .472-IN-ID	28480	2190-0102
MP43	2950-0035	8		NUT-HEX-DBL-CHAM 15/32-32-THD	00000	ORDER BY DESCRIPTION
MP44	1250-2164	3	4	CONNECTOR 3-PIN F CIRC AUDIO	28480	1250-2164

† Refer to Section 7 for update information.

* Factory Selected Component (Refer to Section 5).

Δ Errata part change.

Table 6-3. Replaceable Parts

Reference Designation	HP Part Number	C D	Qty.	Description	Mfr. Code	Mfr. Part Number
Q1	1854-0669	9	1	TRANSISTOR NPN 2N6057 SI TO-3 PD=150W	04713	2N6057
	08640-20057	5	4	INSULATOR SPACER	28480	08640-20057
	1200-0043	8		INSULATOR-XSTR ALUMINUM	28480	1200-0043
	0624-0459	7	3	SCREW-TPG 6-20 .75-IN-LG PAN-HD-POZI STL	00000	ORDER BY DESCRIPTION
	2190-0018	5		WASHER-LK HLCL NO. 6 .141-IN-ID	28480	2190-0018
S1	3101-2080	9	2	SWITCH "POWER" (P/O W6)	28480	3101-2080
	08903-20055	1	2	NUT	28480	08903-20055
	5041-1418	9	2	CAP, ROCKER SWITCH	28480	5041-1418
S2	3101-1903	3	6	SWITCH "OUTPUT FLOAT"	28480	3101-1903
	08640-40052	2	18	LEVER SLIDE SWITCH	28480	08640-40052
	0515-0365	3	6	SCREW-MACH ASSY M2 X 0.4 4MM-LG	00000	0515-0365
	0515-0374	4	6	SCREW-MACH ASSY M3 X 0.5 10MM-LG	00000	ORDER BY DESCRIPTION
S3	3101-1903	3		SWITCH "INPUT FLOAT"	28480	3101-1903
	08640-40052	2		LEVER SLIDE SWITCH	28480	08640-40052
	0515-0365	3	6	SCREW-MACH ASSY M2 X 0.4 4MM-LG	00000	ORDER BY DESCRIPTION
	0515-0374	4	6	SCREW-MACH ASSY M3 X 0.5 10MM-LG	00000	ORDER BY DESCRIPTION
<i>2450A TO 2730A</i>						
S4	3101-1903	3		SWITCH "OUTPUT IMPEDENCE"	28480	3101-1903
	08640-40052	2		LEVER SLIDE SWITCH	28480	08640-40052
	0515-0365	3	6	SCREW-MACH ASSY M2 X 0.4 4MM-LG	00000	ORDER BY DESCRIPTION
	0515-0374	4	6	SCREW-MACH ASSY M3 X 0.5 10MM-LG	00000	ORDER BY DESCRIPTION
<i>2742A AND ABOVE</i>						
S4				NOT ASSIGNED		
<i>2520A TO 2601A</i>						
T1	9100-4118	2	1	TRANSFORMER-POWER 100/120/220/240V	28480	9100-4118
	0515-1408	7	4	SCREW-MACH 4.0 60MM-LG PAN-HD	28480	0515-1408
	2190-0586	2	4	WASHER-LK HLCL 4.0 MM 4.1-MM-ID	28480	2190-0586
	0535-0006	1	4	NUT-HEX DBL-CHAM M4 X 0.7 3.2MM-THK	00000	ORDER BY DESCRIPTION
	3050-0893	9		WASHER-FL MTLC 4.0 MM 4.4-MM-ID	28480	3050-0893
	3050-2007	1		WASHER-SHLDR NO.6 .169-IN-ID .375-IN-OD	28480	3050-2007
	1400-0249	0	4	CABLE TIE .062-.625-DIA .091-WD NYL	06383	PLT1M-8
<i>2614A AND ABOVE</i>						
T1	9100-4516	4	1	TRANSFORMER-POWER 100/120/220/240V	28480	9100-4516
	0515-1408	7	4	SCREW-MACH 4.0 60MM-LG PAN-HD	28480	0515-1408
	2190-0586	2	4	WASHER-LK HLCL 4.0 MM 4.1-MM-ID	28480	2190-0586
	0535-0006	1	4	NUT-HEX DBL-CHAM M4 X 0.7 3.2MM-THK	00000	ORDER BY DESCRIPTION
	3050-0893	9		WASHER-FL MTLC 4.0 MM 4.4-MM-ID	28480	3050-0893
	3050-2007	1		WASHER-SHLDR NO.6 .169-IN-ID .375-IN-OD	28480	3050-2007
	1400-0249	0	4	CABLE TIE .062-.625-DIA .091-WD NYL	06383	PLT1M-8
U1 ^Δ	1826-1181	3	1	IC V RGLTR-FXD-POS 14.7/15.3V TO-3 PKG	03406	LM340AK-15
	08640-20057	5		INSULATOR SPACER	28480	08640-20057
	1200-0043	8		INSULATOR-XSTR ALUMINUM	28480	1200-0043
	0624-0459	7		SCREW-TPG 6-20 .75-IN-LG PAN-HD-POZI STL	00000	ORDER BY DESCRIPTION
	2190-0918	4		WASHER-LK HLCL NO. 6 .141-IN-ID	28480	2190-0918
U2	1826-0169	5	1	IC V RGLTR TO-3	27014	LM320K-15
	08640-20057	5		INSULATOR SPACER	28480	08640-20057
	1200-0043	8		INSULATOR-XSTR ALUMINUM	28480	1200-0043
	0624-0459	7		SCREW-TPG 6-20 .75-IN-LG PAN-HD-POZI STL	00000	ORDER BY DESCRIPTION
	2190-0918	4		WASHER-LK HLCL NO. 6 .141-IN-ID	28480	2190-0918

†Refer to Section 7 for update information.

*Factory Selected Component (Refer to Section 5).

Δ Errata part change.

Table 6-3. Replaceable Parts

Reference Designation	HP Part Number	C D	Qty.	Description	Mfr. Code	Mfr. Part Number
W1	08903-60197	6	1	CABLE ASSEMBLY, FRONT OUTPUT (EXCEPT	28480	08903-60197
W2	08903-60045	3	1	CABLE ASSEMBLY, FRONT INPUT (EXCEPT	28480	08903-60045
W3	08903-60198	7	1	CABLE ASSEMBLY, REAR OUTPUT (OPTION 001	28480	08903-60198
W4	08903-60047	5	1	CABLE ASSEMBLY, REAR INPUT (OPTION 001	28480	08903-60047
W5	08903-60028	2	1	RIBBON CABLE ASSEMBLY (A13J1 TO A1J1)	28480	08903-60028
▲ W6	08903-60029	3	1	CABLE ASSEMBLY, POWER (S1 TO A14)	28480	08903-60029
	08903-20055	1		NUT-SPECIAL M2.5 (PART OF W6)	28480	08903-20055
	0837-0396	6	1	THERMISTOR SURGE PTCTR 5Ω AT 25deg C (PART OF W6)	04379	SG200
W7	0960-0443	1	1	LINE MODULE-FILTERED	28480	0960-0443
	8120-1378	1	1	LINE POWER CORD	28480	8120-1378
2450A TO 2520A W8	08903-60176	1		GROUND CABLE (54) T1 TO CHASSIS	28480	08903-60176
2520A AND ABOVE W8				NOT ASSIGNED		

† Refer to Section 7 for update information.

* Factory Selected Component (Refer to Section 5).

▲ Errata part change.

Table 6-4. Code List of Manufacturers

Mfr. Code	Manufacturer Name	Address	Zip Code
00000	ANY SATISFACTORY SUPPLIER		
00853	SANGAMO ELEC CO S CAROLINA DIV	PICKENS SC	29671
01121	ALLEN-BRADLEY CO	MILWAUKEE WI	53204
01295	TEXAS INSTR INC SEMICOND CMPNT DIV	DALLAS TX	75222
02111	SPECTROL ELECTRONICS CORP	CITY OF IND CA	91745
02768	ILLINOIS TOOL WORKS INC FASTEX DIV	DES PLAINES IL	60016
03888	K D I PYROFILM CORP	WHIPPANY NJ	07981
04713	MOTOROLA SEMICONDUCTOR PRODUCTS	PHOENIX AZ	85008
06383	PANDUIT CORP	TINLEY PARK IL	60477
06665	PRECISION MONOLITHICS INC	SANTA CLARA CA	95050
06915	RICHCO PLASTIC CO	CHICAGO IL	60646
07263	FAIRCHILD SEMICONDUCTOR DIV	MOUNTAIN VIEW CA	94042
17856	SILICONIX INC	SANTA CLARA CA	95054
18736	VOLTRONICS CORP	HANOVER NJ	07936
19701	MEPCO/ELECTRA CORP	MINERAL WELLS TX	76067
24046	TRANSITRON ELECTRONIC CORP	WAKEFIELD MA	01880
24355	ANALOG DEVICES INC	NORWOOD MA	02062
24546	CORNING GLASS WORKS (BRADFORD)	BRADFORD PA	16701
25088	SIEMENS CORP	ISELIN NJ	08830
27014	NATIONAL SEMICONDUCTOR CORP	SANTA CLARA CA	95051
28480	HEWLETT-PACKARD CO CORPORATE HQ	PALO ALTO CA	94304
3L585	RCA CORP SOLID STATE DIV	SOMERVILLE NJ	
30161	AAVID ENGINEERING INC	LACONIA NH	03246
32293	INTERSIL INC	CUPERTINO CA	95014
34335	ADVANCED MICRO DEVICES INC	SUNNYVALE CA	94086
34371	HARRIS SEMICON DIV HARRIS-INTERTYPE	MELBOURNE FL	32901
52063	EXAR INTEGRATED SYSTEMS INC	SUNNYVALE CA	94086
56289	SPRAGUE ELECTRIC CO	NORTH ADAMS MA	01247
71400	BUSSMAN MFG DIV OF MCGRAW-EDISON CO	ST LOUIS MO	63107
72136	ELECTRO MOTIVE CORP	FLORENCE SC	06226
74970	JOHNSON E F CO	WASECA MN	56093
75915	LITTELFUSE INC	DES PLAINES IL	60016
84411	TRW CAPACITOR DIV	OGALLALA NE	69153

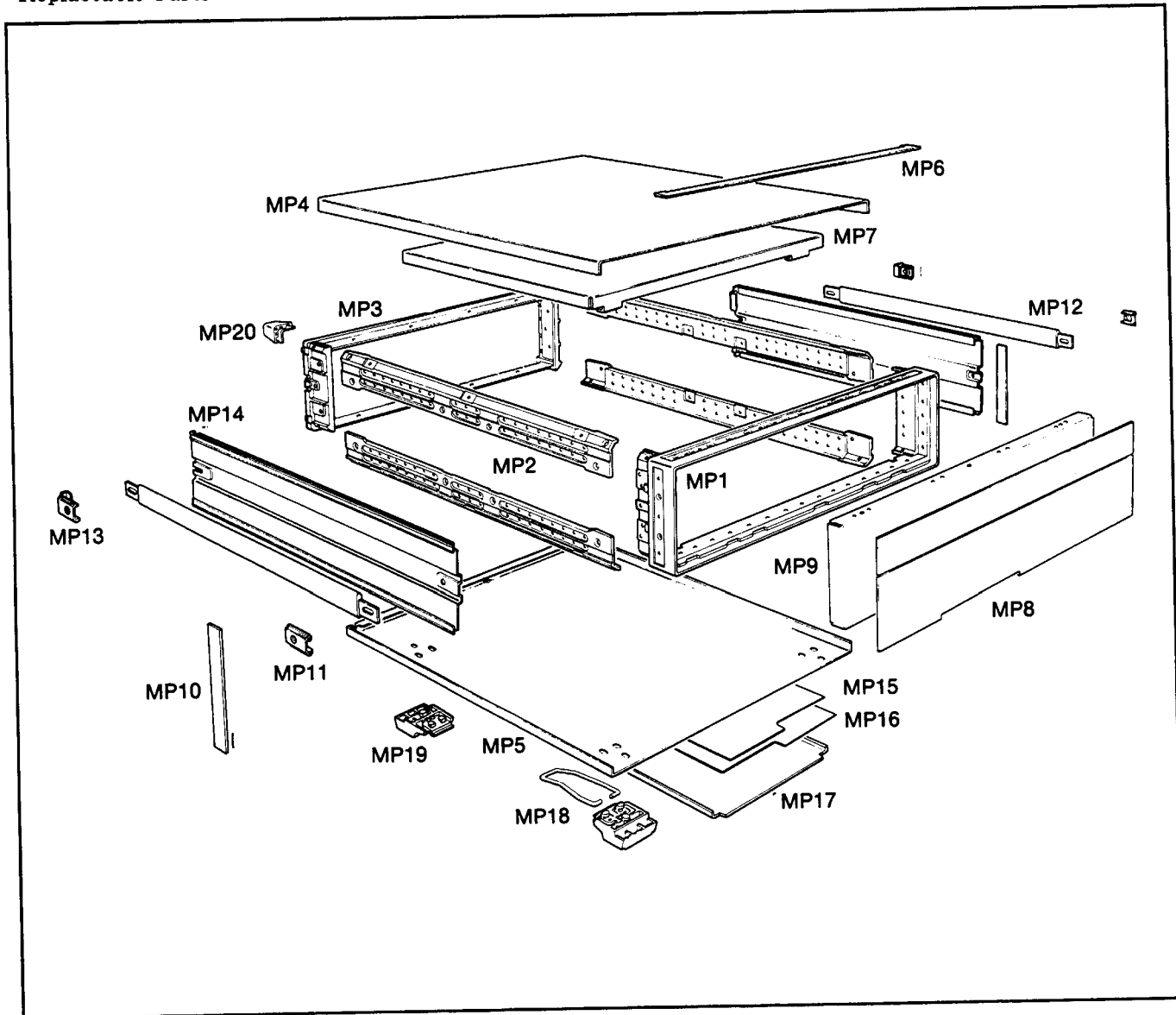
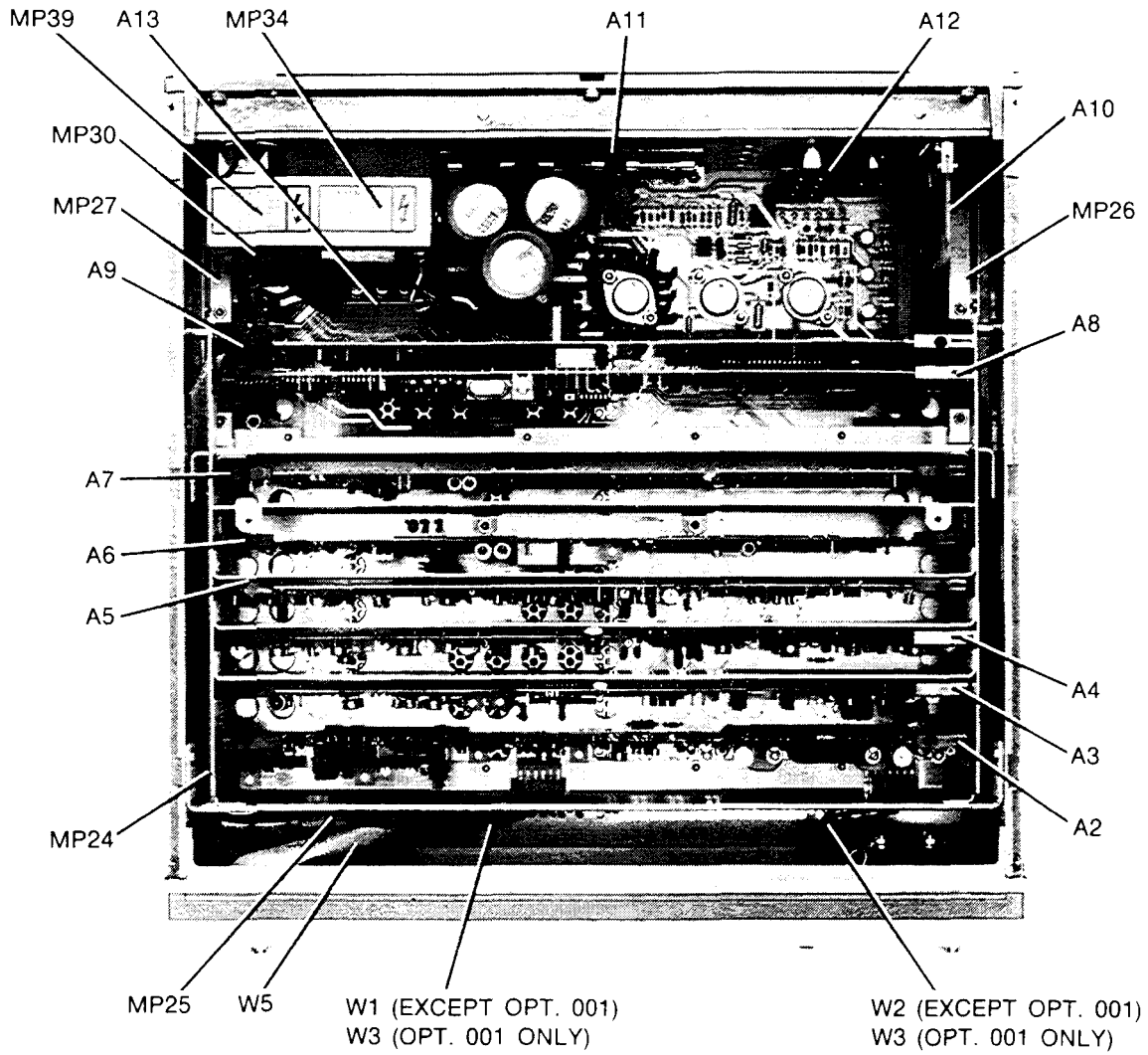


Figure 6-1. Cabinet Parts



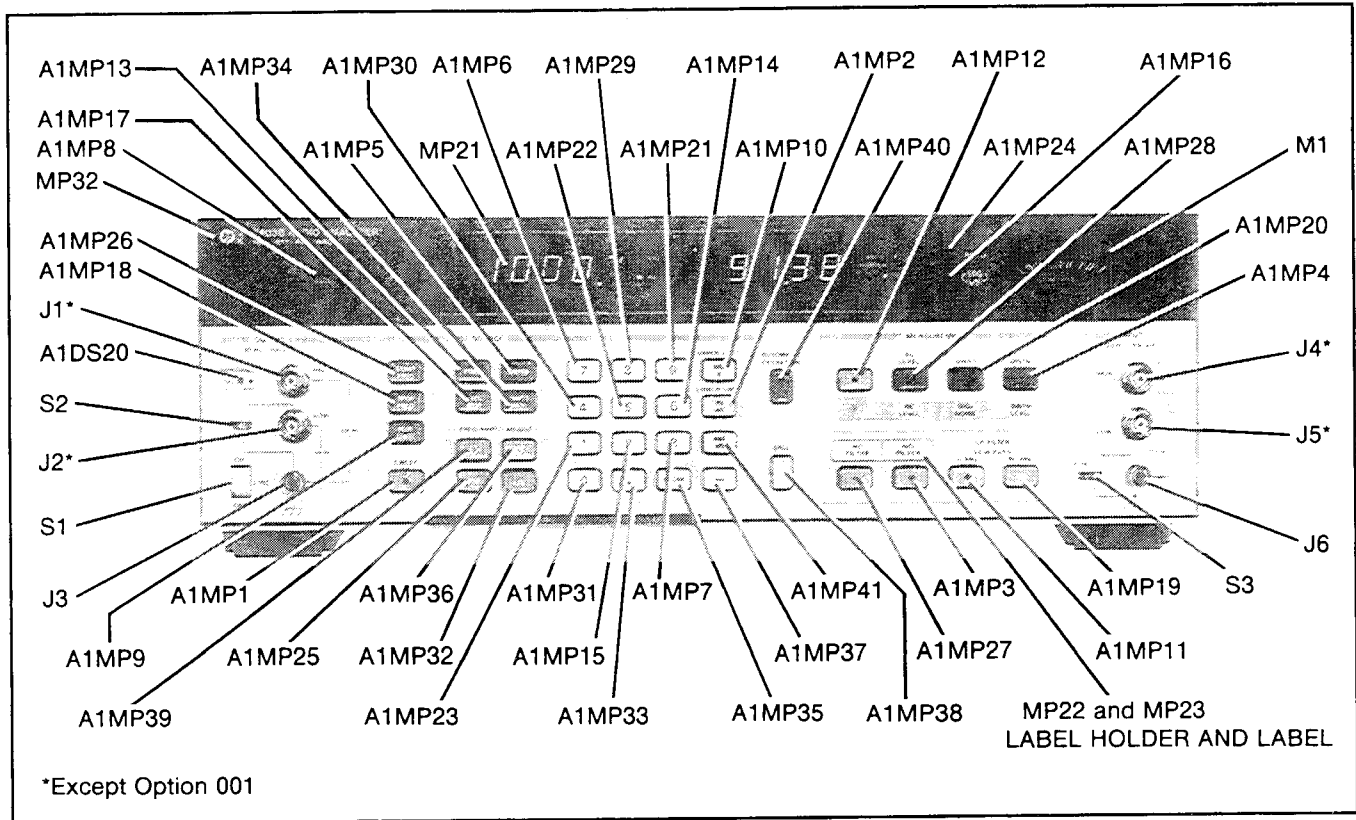


Figure 6-3. Chassis and Mechanical Parts Identification - Front Panel

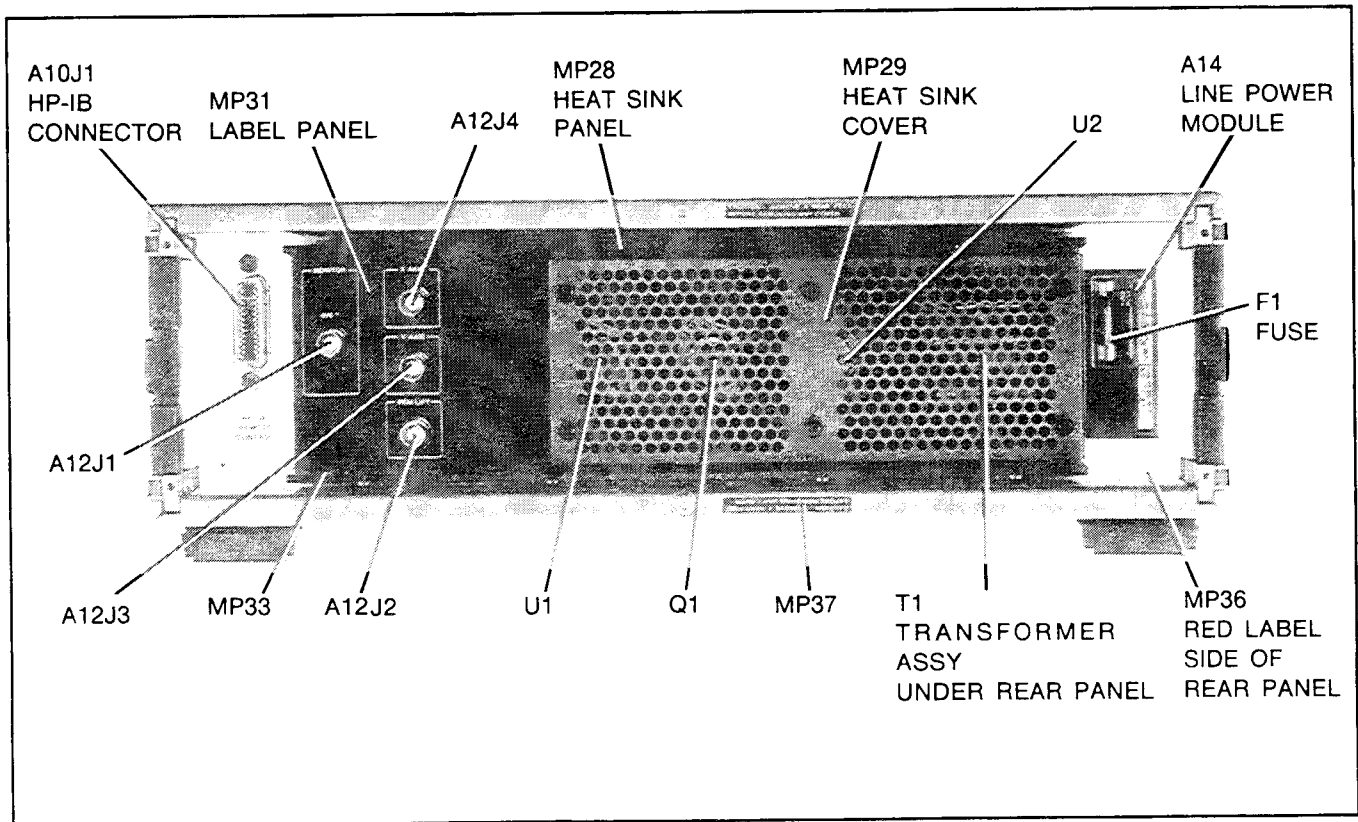


Figure 6-4. Chassis and Mechanical Parts Identification - Rear Panel (2742A and above)

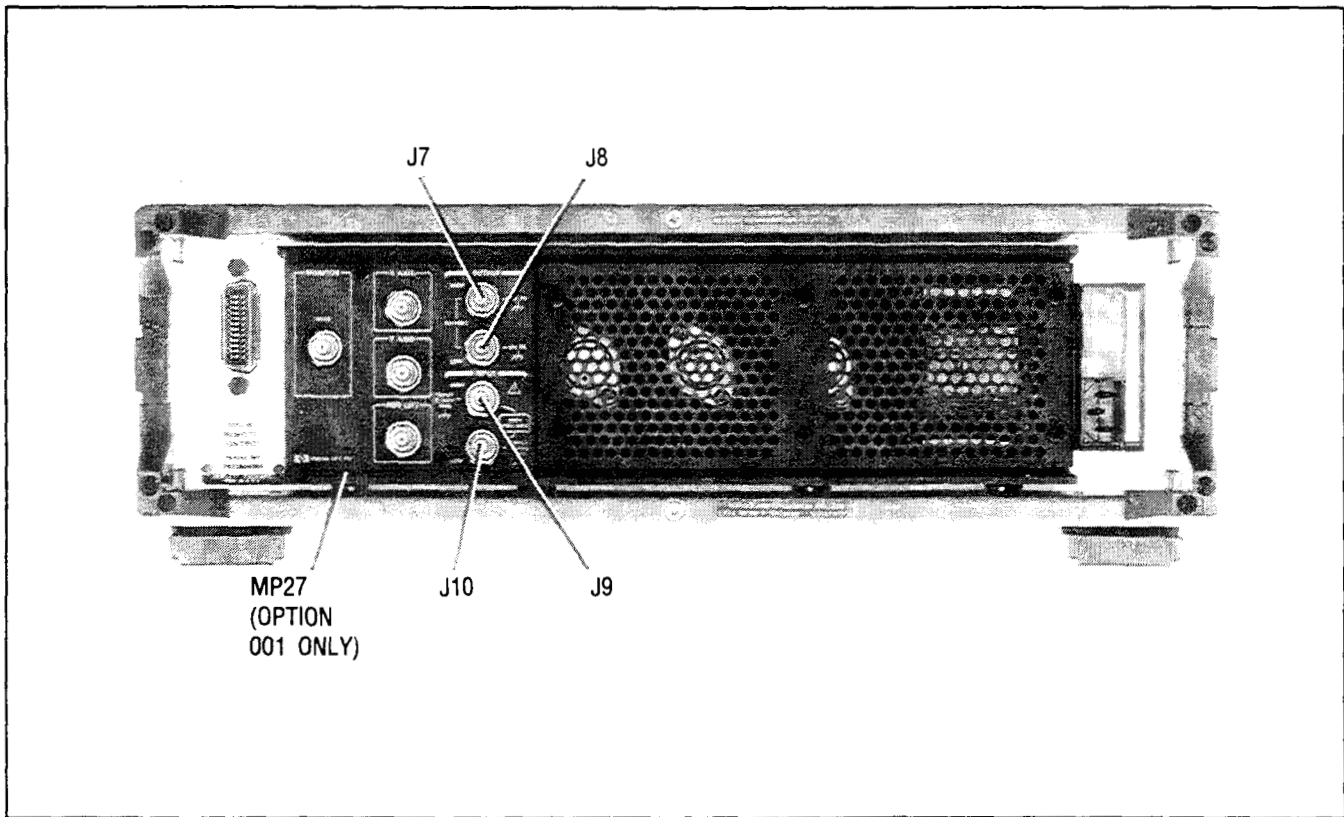


Figure 6-5. Chassis and Mechanical Parts Identification — Rear Panel, Including Option 001

Section 7 INSTRUMENT CHANGES

7-1. INTRODUCTION TO THIS SECTION

This section contains instrument modification recommendations and procedures that could improve the performance and reliability of your instrument. Refer to *Instrument Covered by This Manual*, paragraphs 1 through 4 in Section 1 for important information about serial number coverage.

7-2. MODIFICATIONS/CHANGES

Description

Instruments with Serial Prefix 2450A have System II cabinet parts and hardware that are English thread. Instruments with Serial Prefix 2520A and higher have System II cabinet parts and hardware that are METRIC thread.

In Section 6, *Replaceable Parts*, both English and Metric thread part numbers are listed. The correct part numbers are referenced to the instrument's serial number prefix.

7-3. FIRMWARE CHANGE SUMMARY

The firmware is changed whenever anomalies are found in the instrument's operation which can be corrected by altering the Controller's program. Firmware is also changed to add new features which may be only changed in the program or which may also result from instrument hardware changes.

Since the program resides in the ROMs (the firmware), the ROMs are altered each time the program is changed. At that time the new ROMs are given new part numbers and the software (the program) date is changed. (To display the software date, key in Special Function 42.0.) Always update firmware with the latest edition, which is backward compatible. (See Service Sheet 15 and 16 for ROM identification.)

1. **Software date code: 11.15 1984** (2450A to 2520A)

1. ROM part numbers:

- ROM 1, 08903-80016
- ROM 2, 08903-80017
- ROM 3, 08903-80018
- ROM 4, 08903-80019
- ROM 5, 08903-80020
- ROM 6, 08903-80021
- ROM 7, 08903-80022
- ROM 8, 08903-80023
- ROM 9, 08903-80024

2. Software date code: 2.11 1985 (2520A to 2614A)

ROM part numbers

ROM 1, 1818-3741
ROM 2, 1818-3742
ROM 3, 1818-3743
ROM 4, 1818-3744
ROM 5, 1818-3745
ROM 6, 1818-3746
ROM 7, 1818-3747
ROM 8, 1818-3748
ROM 9, 1818-3749

3. Software date code: 8.22 1986 (2652A to 2818A) The instrument has undergone a change in firmware. ROM memory has been consolidated into 1 single ROM (ROM 10, U31).

ROM part number

ROM 10, 08903-80036

4. Software date code: 2829 (2836A and above) The 08903-80050 is now capable of being programmed to 17.78 dBm (6.0 volts) in the log mode. The previous ROM (08903-80036) could not be programmed above +15.56 dBm (4.64 volts) in the log mode.

ROM part number

ROM 10, 08903-80050

7-4. HARDWARE CHANGE SUMMARY**1. 2730A and above**

A quasi-peak detector is added to the Output RMS/AVG detector on the A4 Voltmeter assembly. The part number for the new A4 assembly is 08903-60183.

2. 2742A and above

The selectable 600 Ω or 50 Ω Source Output Impedance is now enabled from the front panel as a special function, and is programmable over HP-IB.

7-5. CABINET PARTS COLOR CHANGE**1. 2910A and above****NOTE**

Serial prefix 2910A changes the color of the instrument covers and accessories. The old color cover and accessories are no longer available. If your instrument has serial prefixes 2908A and below, and you must replace one of these parts, we recommend that you order the full set of covers and accessories using the part numbers for serial prefix 2910A and above. Affected cabinet parts are MP1, MP4-6, MP8, MP10-17, MP19, and, MP20 (see Table 6-3).

Section 8

SERVICE

8-1. INTRODUCTION

This section contains information for troubleshooting and repairing the Audio Analyzer. Included are troubleshooting tests, block and schematic diagrams, and principles of operation.

8-2. SERVICE SHEETS

The foldout pages in the last part of this section are block diagrams (BD1 through BD5) and service sheets (1 to 21 and A to C).

8-3. Block Diagrams

Block Diagram 1 (BD1) is an overall block diagram that breaks the instrument into functional sections. It serves as an index to the other block diagrams and as a starting point for troubleshooting (refer to *General Troubleshooting*, paragraph 8-16). The other block diagrams (BD2 through BD5) cover the Measurement, Source, Digital, and Power Supply Sections of the instrument, respectively. These block diagrams break the sections into physical assemblies and serve as an index to the schematic service sheets. Included with the block diagrams are troubleshooting checks and discussions of the principles of operation.

8-4. Schematics

Service Sheets 1 through 21 consist of assembly schematic diagrams, principles of operation discussions, component locator drawings, troubleshooting checks and hints, and, when necessary, mnemonic tables.

8-5. Additional Service Sheets

Service Sheets A and B contain disassembly procedures and exploded views of the front- and rear-panel assemblies. Service Sheet C contains a summary of Service Special Functions and Error Messages.

8-6. SAFETY CONSIDERATIONS

8-7. Before Applying Power

Verify that the instrument is set to match the available line voltage and that the correct fuse is installed. An uninterrupted safety earth ground must be provided from the main power source to the instrument input wiring terminals, power cord, or supplied power cord set. In addition, verify that a common ground exists between the Audio Analyzer and all test equipment.

8-8. Safety

Pay attention to WARNINGS and CAUTIONS. They must be followed for your protection and to avoid damage to the equipment.

WARNING

Maintenance described herein is performed with power supplied to the instrument and with the protective covers removed. Such maintenance should be performed only by service-trained personnel who are aware of the hazards involved (for example, fire and electrical shock). Where maintenance can be performed without power supplied, the power should be removed.

Any interruption of the protective (grounding) conductor (inside or outside the instrument) or disconnection of the protective earth terminal will create a potential shock hazard that could result in personal injury. Grounding one conductor of a two conductor outlet is not sufficient. Whenever it is likely that the protection has been impaired, the instrument must be made inoperative (that is, secured against unintended operation).

If this instrument is to be energized via an autotransformer, make sure that the autotransformer's common terminal is connected to the earth terminal of the power source.

Capacitors inside the instrument can still be charged even if the instrument is disconnected from its source of supply.

Make sure that only 250 volt fuses with the required rated current and of the specified type (normal blow, time delay, etc.) are used for replacement. Do not use repaired fuses or short-circuited fuseholders. To do so could create a shock or fire hazard.

CAUTION

Do not unplug any boards in the Audio Analyzer unless the instrument is unplugged or switched to OFF. Some boards contain devices which can be damaged if the board is removed when the power is on. Use conductive foam when removing MOS devices from sockets. Use care when unplugging ICs from high-grip sockets.

8-9. RECOMMENDED TEST EQUIPMENT AND ACCESSORIES

Test equipment and test accessories required to maintain the Audio Analyzer are listed in Tables 1-3 and 1-4. Equipment other than that listed may be used if it meets the listed critical specifications.

8-10. SERVICE TOOLS, AIDS, AND INFORMATION**8-11. Service Accessories**

The accessory items required for servicing the Audio Analyzer are listed in Table 1-4. Three 44-contact extender boards (HP 08901-60084) are required for the observation of waveforms and signatures on the A7 assembly. Two 30-contact extender boards (HP 08901-60085) are required for the A3 and A4 assemblies. One each of the 44 and 30 contact extender boards are required for use with the A2, A5, and A6 assemblies. The Digital Test/Extender Board (HP 08903-60018) is required for troubleshooting the A8 Controller/Counter Assembly. Refer to Figure 8-1. The conductive polyurethane foam pad (HP 4208-0094) is required for the protection of MOS devices as cautioned in paragraph 8-8 and Service Sheets BD4 and 14.

8-12. Heat-Staking Tool

The front-panel pushbutton switches have small plastic pins protruding from the back. These tabs fit through holes in the front-panel printed-circuit board (assembly A1) and are melted down to hold the switch in place. This process is known as heat staking. The heat-staking tool is a standard soldering iron with a special tip attached (see Figure 8-2).

8-13. Assembly Locations

Assemblies in the Audio Analyzer are numbered sequentially from front to back as shown in Figure 8-3. Assemblies A2 through A9 have color-coded board extractors. (For example, assembly A6 has a black left extractor

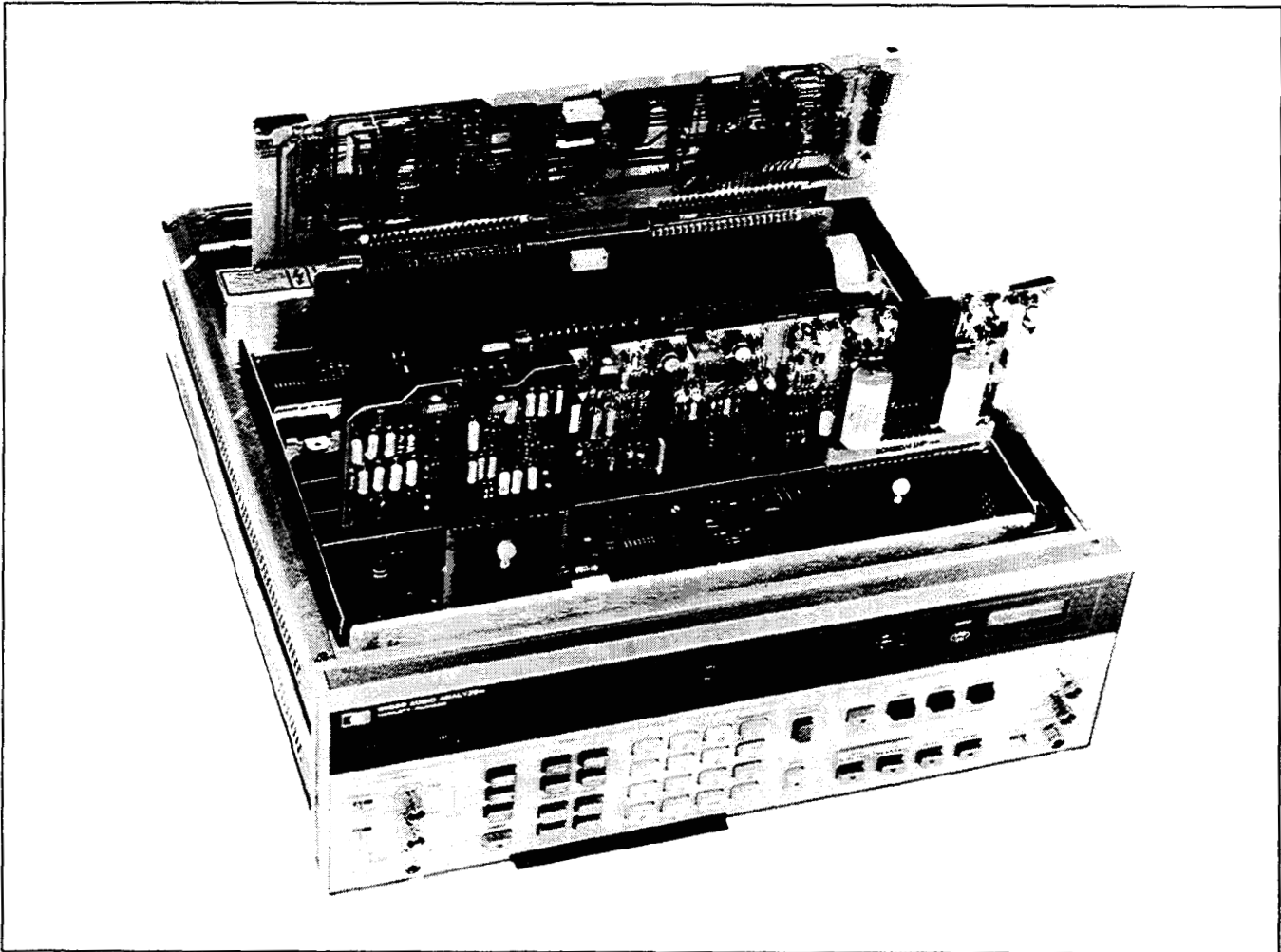


Figure 8-1. Assemblies A2 and A9 Shown on Extender Boards

and blue right extractor. Thus, the color code of A6 is 06.) Assembly A1 is part of the front-panel assembly of the instrument.

8-14. Parts and Cable Locations

The locations of individual components mounted on printed-circuit boards or other assemblies are shown adjacent to the schematic diagram on the appropriate service sheet. The part reference designator is the assembly designator plus the part designator. For example, A6R9 is R9 on the A6 assembly. For specific component descriptions and ordering information, refer to Table 6-3, *Replaceable Parts*, in Section 6. Chassis and frame parts, as well as mechanical parts and cables, are identified on Figures 6-1 through 6-5. In addition, Service Sheets A and B in this section contain illustrated parts breakdowns that locate many mechanical parts and cables.

Major mechanical parts have reference designations that begin with the letters MP. Other mechanical parts, such as screws, are listed in the replaceable-parts list below the part to which they fasten. To find the part number and description of a mechanical part, find the part in one of the figures in Section 6 or Section 8. The part in the figure will be labeled with its reference designator. Look up that reference designator in the *Replaceable Parts* table. If the part is a fastener, such as a screw, nut, or washer, look to the figure for the part to which it fastens. Then, look up the fastened part in the parts list. Just below it are the part numbers and description of the desired hardware.

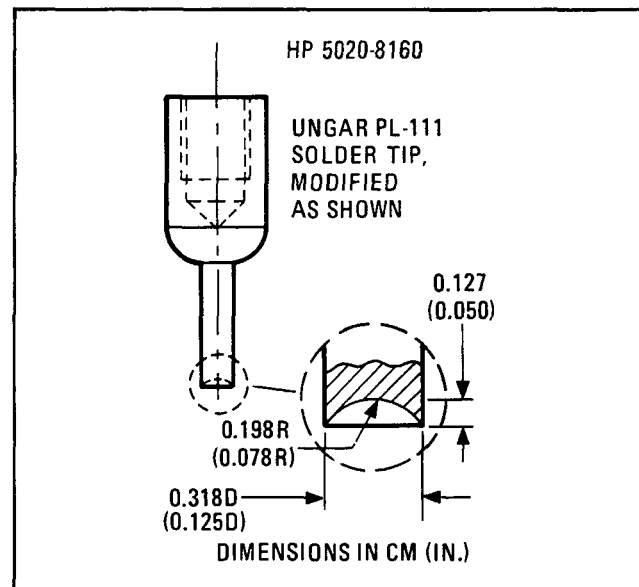


Figure 8-2. Heat-Staking Tip

8-15. Other Service Documents

Service Notes, Manual Updates, and other service literature are available through Hewlett-Packard. For further information, contact your nearest Hewlett-Packard office.

8-15.1 Component Replacement Procedures

The A2A1 Options 010, 011, 012, 013, 015, A2A2 Options 050, 051, 052, 053, 055, A3, A4, A5, A6, A7, A9, A10, A11, A12 and A13 printed circuit board assemblies are manufactured using a Hot Air Levelled (HAL) process. The printed circuit board traces, pads and plated-through holes (PTH) are copper. While the process has several advantages over conventional processes the printed circuit boards are more susceptible to broken traces, lifted pads and damage to the plated-through holes. Therefore, additional care must be taken when replacing components on HAL printed circuit boards.

Listed below are soldering considerations that apply to all printed circuit boards:

- The temperature of the soldering iron tip and the tip is in contact with the printed circuit board.
- The size and shape of the soldering iron tip.
- The pressure of the soldering iron tip on the pad.
- The operator's skill.

When replacing components on HAL printed circuit boards the following steps should also be taken.

1. Use a temperature controlled soldering iron set at a temperature of 600°F (315°C).

Extensive tests were made by Hewlett-Packard using commercial brands of soldering irons. As a result of these tests, the recommended soldering iron was the HEXACON THERM-O-TRAC STATION #1000 with the FINGER GRIP SLEEVE 21 A-5 and solder tip #J 301X. During soldering, the tip temperature of the HEXACON THERM-O-TRAC STATION remained very stable.

2. Cut out the body of the component to be removed. (Leave leads as long as possible for easier removal.)
3. Apply heat to the lead only, add solder as required, slide tip down to the pad and remove solder with solder sucker.

CAUTION

Tip pressure on the pad is most critical and is totally operator dependent. Excessive tip pressure will damage or destroy the board. Do not use tin desoldering braid or solder wicking techniques on Hot Air Leveled boards.

The melting point of solder in the plated through hole (PTH) is reached in 2.5 seconds at tip temperature of 600° to 750°F (315° to 400°C). The recommended time for heat to be applied is 3 seconds.

Keep the solder sucker clean and do not let the tip of the solder sucker hit the pad when removing solder. Breaking the lead loose can damage the PTH. If the lead is attached to the PTH after the solder has been removed, reheat the lead to remove it.

4. When soldering or desoldering multilead components, do not consecutively apply heat to adjacent leads. Distribute heat by skipping leads or crossing to opposite side of device.

8-16. GENERAL TROUBLESHOOTING

Instrument problems usually fall into three general categories: operator errors, operation out of specification, and catastrophic failures. The troubleshooting strategy is different for each category.

8-17. Operator Errors

Apparent failures sometimes can result from using the instrument outside of its range. Usually, the instrument can sense the condition and will display an error message. At other times it cannot, such as when it attempts to measure signals with frequencies higher than 100 kHz. Consult the *Specifications* table (Table 1-1) and the *Detailed Operating Instructions* in Section 3 for more detailed information.

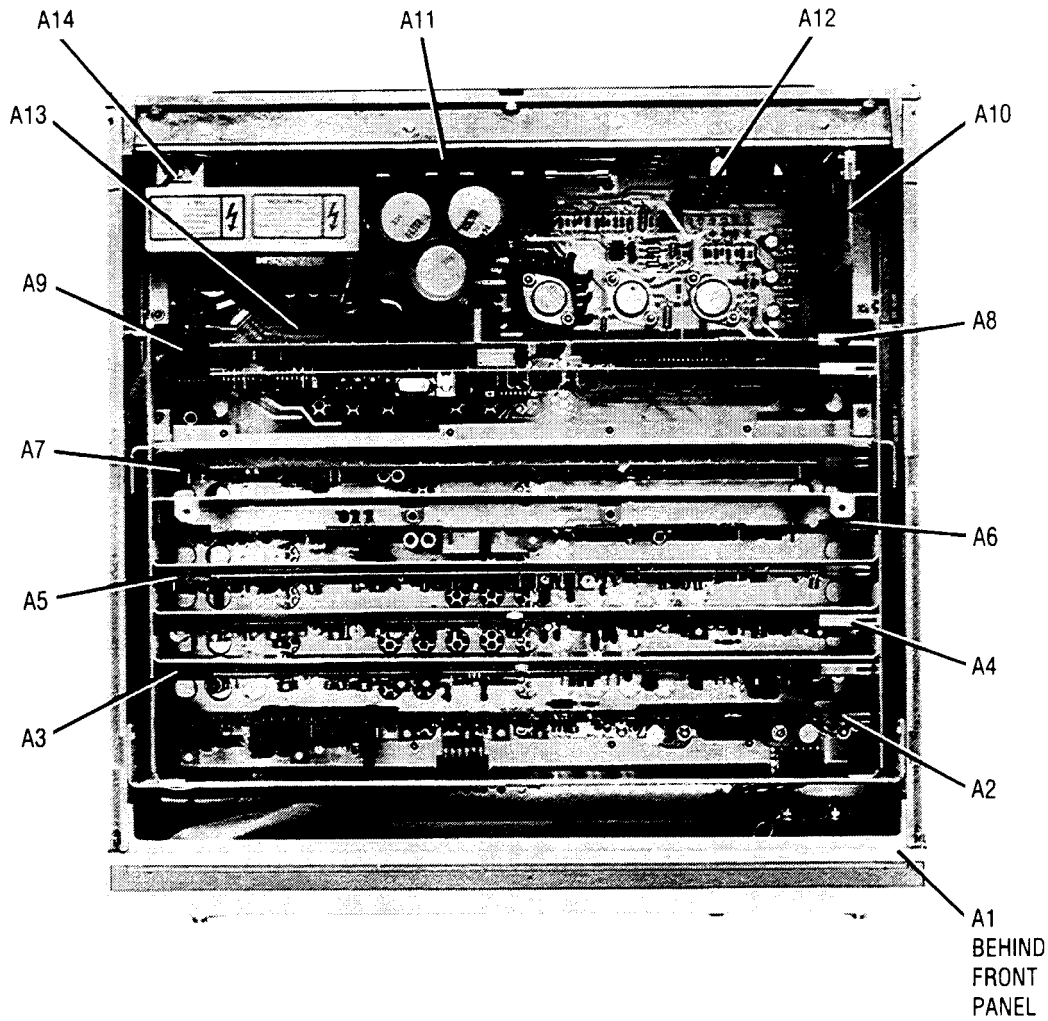
8-18. Operation Out of Specification

The specifications are listed in Table 1-1. Performance tests that can be used to verify the specifications are found in Section 4. If instrument performance is only slightly out of limits, it can sometimes be corrected by an adjustment. The procedures for adjustments are in Section 5. References listed for each adjustment indicate which service sheet to consult when the adjustment procedure fails. In general, however, it is also a good practice to perform the troubleshooting checks on Service Sheet BD1, since they take only a few minutes and reveal much information.

8-19. Catastrophic Failures

Begin troubleshooting catastrophic failures by performing the troubleshooting checks on Service Sheet BD1. The simple procedures there take only a few minutes and will quickly differentiate a control (digital) problem from a hardware (analog) problem. The checks then give cross-references to the detailed block diagrams (Service Sheets BD2 to BD5) or to a schematic.

The troubleshooting information found on all service sheets consists of a series of performance checks. The purpose of the checks is not to identify which circuit or component has failed but rather to verify whether or not the assembly or circuit is operating correctly. Information on the possible cause of failure is given in the form of hints whenever they can be given reliably. The limits given in the troubleshooting checks are rather



Reference Designator	Assembly
A1	Keyboard and Display
A2	Input Amplifier
A3	Notch Filter
A4	Output Amplifier/Voltmeter
A5	Oscillator
A6	Output Attenuator
A7	Latch
A8	Controller/Counter
A9	Remote Interface
A10	Remote Interface Connector
A11	Series Regulator Socket
A12	Connector/Filter
A13	Power Supply and Mother Board
A14	Line Power Module

Figure 8-3. Assembly Locations

loose to facilitate the use of general-purpose equipment (usually an oscilloscope). If a slightly-out-of-tolerance condition is suspected, the test can usually be run more rigorously paying greater attention to measurement accuracy.

Troubleshooting on the block diagram level normally utilizes User and Service Special Functions, while that on the schematic level often utilizes Direct Control Special Functions. Direct Control Special Functions will require some study of their operation before using them for the first time.

8-20. SPECIAL FUNCTIONS

8-21. General

Special Functions extend user control of the instrument beyond that normally available from the front panel. They are intended for the user who has an understanding of the instrument and the service technician who needs arbitrary control of the instrument functions. During normal use, the Audio Analyzer safeguards itself against invalid measurements. Safeguards come in the form of automatic tuning and ranging, overvoltage protection, and error messages. When Special Functions are used, some of these safeguards are removed, depending on the Special Function selected, and thus there is a degree of risk that the measurement may be invalid. (However, there is no risk of damage to the instrument.)

To enter a Special Function, enter the Special Function code (usually a prefix, decimal, and suffix), then press the SPCL key. The Special Function code will appear on the display as it is being entered. If a mistake is made during entry of the Special Function code, press the CLEAR key and start over. When a Special Function is entered, the light in the SPCL key will usually go on (if it is not already on). The readout on the display will depend on the Special Function entered. The readout may be a measured quantity, an instrument setting, or a special code, or, in some cases, the display is unaltered. Special Functions can be entered from the HP-IB by issuing the Special Function code followed by the code SP or sp.

The Special Functions are grouped by prefix range as follows:

- 0: Direct Control Special Functions.** These functions are used for service. They halt the functioning of the Controller and configure the instrument hardware as dictated by the suffix. All software safeguards are relinquished.
- 1-39: User Special Functions.** These functions are used during normal instrument operation when a special configuration, measurement, or information is required. Many of the instrument safeguards remain implemented. More information on User Special Functions can be found under *Special Functions* in the *Detailed Operating Instructions* in Section 3 and on the Operating Information pull-out cards. **SERIAL PREFIX 2742A AND ABOVE:** Special Function 47 selects either 50 or 600 ohm Source Output Impedance.
- 40-99: Service Special Functions.** These functions are used to assist in troubleshooting an instrument fault. The functions available are quite diverse and include special internal measurements, software control, and special service tests and configurations. Safeguards are generally relinquished.

8-22. Direct Control Special Functions (Prefix 0)

Communication between the instrument's Controller and its hardware is via the Instrument Bus. During normal instrument operation, the Instrument Bus carries measurement results, status information, and commands (which control hardware). The Direct Control Special Functions halt the bus activity and send out commands as determined by the code suffix. One command is sent for each Special Function entry.

Direct Control Special Function Code Format. The Direct Control Special Function code is in the form $0.esd$, where 0 is the prefix (which may be omitted) and esd represents a three-digit hexadecimal number. The significance of esd (which stands for enable, select, and data) is discussed in the *Principles of Operation* for Service Sheet BD4. Specific direct control codes are given in the *Troubleshooting* section of the individual service sheets.

As the Direct Control code is entered, the code will appear on the left display. Pressing the SPCL key initiates the Special Function. The displays will then be in the form $rrrr$ (left display) and www (right display), where each digit represents a binary bit (1 or 0). The $rrrr$ is the d (data) read back from the Instrument Bus. The www is the d (data) written to the bus. Thus $rrrr$ and www are normally the binary form of the hexadecimal d . Exceptions to this are Special Functions $0.03d$ through $0.06d$ and $0.0Bd$ through $0.0Fd$, which control the display itself.

Since the display has a limited set of segments for alphabetic characters, the hexadecimal characters A, B, C, D, E, and F are displayed on entry as -, E, H, L, P, and blank respectively, and they are entered from the keyboard as Shift 0, Shift 1, Shift 2, etc., or from the HP-IB as X0, X1, X2, etc. Table 8-1 summarizes the hexadecimal entry and readback for Direct Control Special Functions.

Table 8-1. Hexadecimal Information for Direct Control Special Functions

Hexadecimal Character	Decimal Equivalent	Binary Equivalent	Keystroke Entry	HP-IB Code Entry	Display On Entry
0	0	0000	0	0	0
1	1	0001	1	1	1
2	2	0010	2	2	2
3	3	0011	3	3	3
4	4	0100	4	4	4
5	5	0101	5	5	5
6	6	0110	6	6	6
7	7	0111	7	7	7
8	8	1000	8	8	8
9	9	1001	9	9	9
A	10	1010	S (Shift) 0	X0	—
B	11	1011	S (Shift) 1	X1	E
C	12	1100	S (Shift) 2	X2	H
D	13	1101	S (Shift) 3	X3	L
E	14	1110	S (Shift) 4	X4	P
F	15	1111	S (Shift) 5	X5	(blank)

Direct Control Special Function Applications. Direct Control Special Functions are used in troubleshooting to provide manual control of various switches or digital-to-analog devices in the hardware where other special functions or front-panel keys prove ineffective. Some examples will illustrate how to use Direct Control Special Functions.

Example 1

In the measurement path of the input signal is a Programmable Gain Amplifier located on the A2 Input Amplifier Assembly. A simplified diagram of the circuit is shown in Figure 8-4. Amplifier gain is selected by analog switches U11(1), U11(2), U11(3), and U11(4). Table 8-2 shows the Direct Control Special Functions that can be used to control the switches. (Special Function 1.N is normally used to set the amplifier gain in troubleshooting. This example was chosen to illustrate the concept of Direct Control Special Functions because of its simplicity.)

To set the gain to 8 dB, key in 0.722 SPCL or .722 SPCL. The displays will show 0010 0010, indicating that the Controller received $d=2$ from the keyboard (or HP-IB), issued it to the Instrument Bus, and read it back. If circuitry on the assembly is working properly, only switch U11(3) should be closed, and thus the signal is amplified by 8 dB.

Table 8-2. Programmable Gain Amplifier Switching Direct Control Special Functions

Direct Control Special Function	Switch Closed	Gain (dB)
0.720	U11(2)	0
0.724	U11(4)	4
0.722	U11(3)	8
0.721	U11(1)	12

Notice that the display no longer shows a measurement result. No annunciators are lighted (except REMOTE and ADDRESSED if the Special Function is entered via HP-IB) and only the SPCL key is lighted. If any key other than a number key, the S (Shift) key, or the LCL key is pressed, the instrument

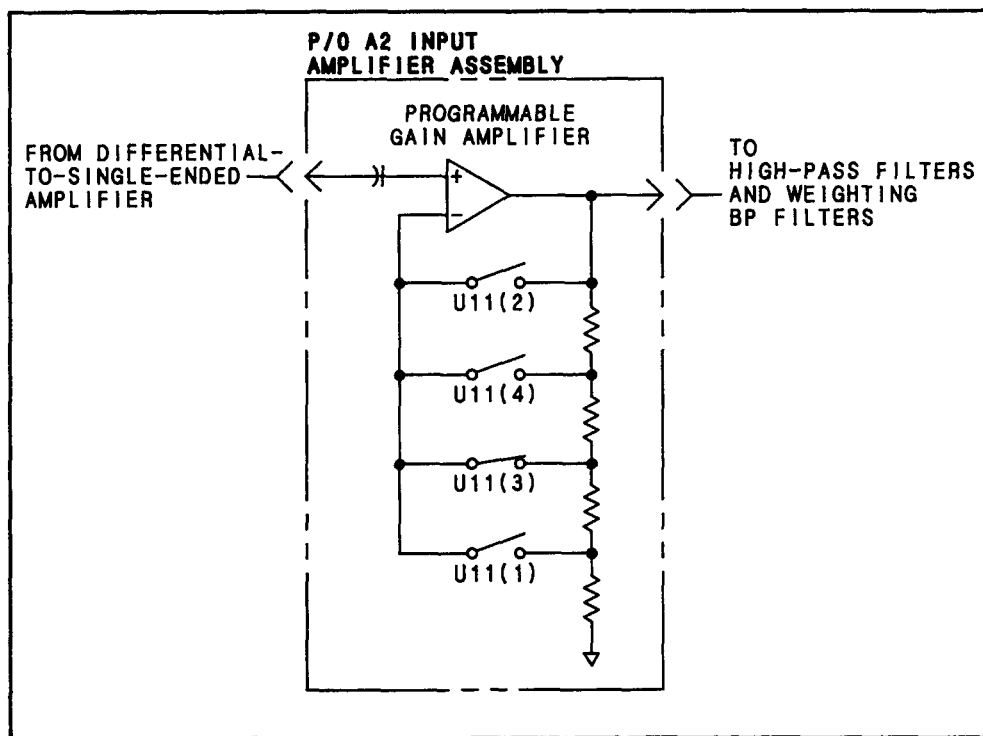


Figure 8-4. Example Showing Programmable Gain Amplifier Switching

hardware will revert back to the measurement mode it was in before the Direct Control Special Function was entered. Thus, in this example, unless 8 dB gain had been previously set, it would be removed from the audio path when any other key is pressed. (However, note that there are some Service Special Functions that will maintain the requested configurations even if another key is pressed.)

As it turns out, other 0.72d codes than those shown in Table 8-2 will affect the gain of the Programmable Gain Amplifier. For example, 0.723 will close U11(3) and U11(1) simultaneously (gain is now 10.6 dB). This fact is ascertained from the service sheet schematics.

Example 2

A second example from the A2 assembly illustrates data readback. One of the means of detecting an overrange of the input circuits is by the Input Overload Detector. The detector connects to both the high and low inputs (directly) and output (through the Input Range Detector) of the Programmable Gain Amplifier of Example 1. See Figure 8-5. At the input of the amplifier, the Input Overload Detector senses the dc level and compares it against both a positive and negative reference. At the output of the Input Range Detector it also compares the dc level (and hence the ac level of the signal) against a reference. If any detected level exceeds a reference, the output of the detector goes low and resets flip-flop A7U14 on the A7 Latch Assembly. A7U14 also sets the gain of all input circuits up to and including the Programmable Gain Amplifier to minimum gain without intervention of the Controller. A7U15B, when enabled, inverts the output of A7U14. The output of A7U14 is across the least-significant bit of the readback data line of the Instrument Bus. In the normal measurement cycle, the Controller reads the status of the Input Overload Detector (by enabling A7U15B and reading its output) and takes corrective action if A7U14 has tripped.

At this point in the discussion, a more detailed description of the Instrument Bus data lines is needed. Data (d) is sent out from the I/O port of the Controller to the Instrument Bus through buffers (TTL inverters). However, data is read back to the I/O port directly, bypassing the buffers. An I/O port outputs a low by actively pulling the line to ground. It outputs a high by allowing the output to be passively

pulled up by an external pull-up resistor. When a Controller I/O port inputs data from other circuits of the Audio Analyzer, these circuits must operate against the pull-up resistor.

Readback devices that are read out to the data lines, such as A7U15B, are similarly configured. A7U15B has an open-collector TTL output. When it outputs data, a low is produced by switching the output device to ground. A high is produced by switching the device off and allowing the output to be passively pulled up. The readback lines are low true (that is, $r=1$ when the line is low).

When A7U15B is disabled (enable is low), the output is high (inactive) and has no effect on the data line. A7U15B is enabled by Direct Control Special Function 0.70 d . The value of d is arbitrary to enable A7U15B, but the least-significant bit must be 0 (that is, d must be even) to switch off the output device of the I/O data port.

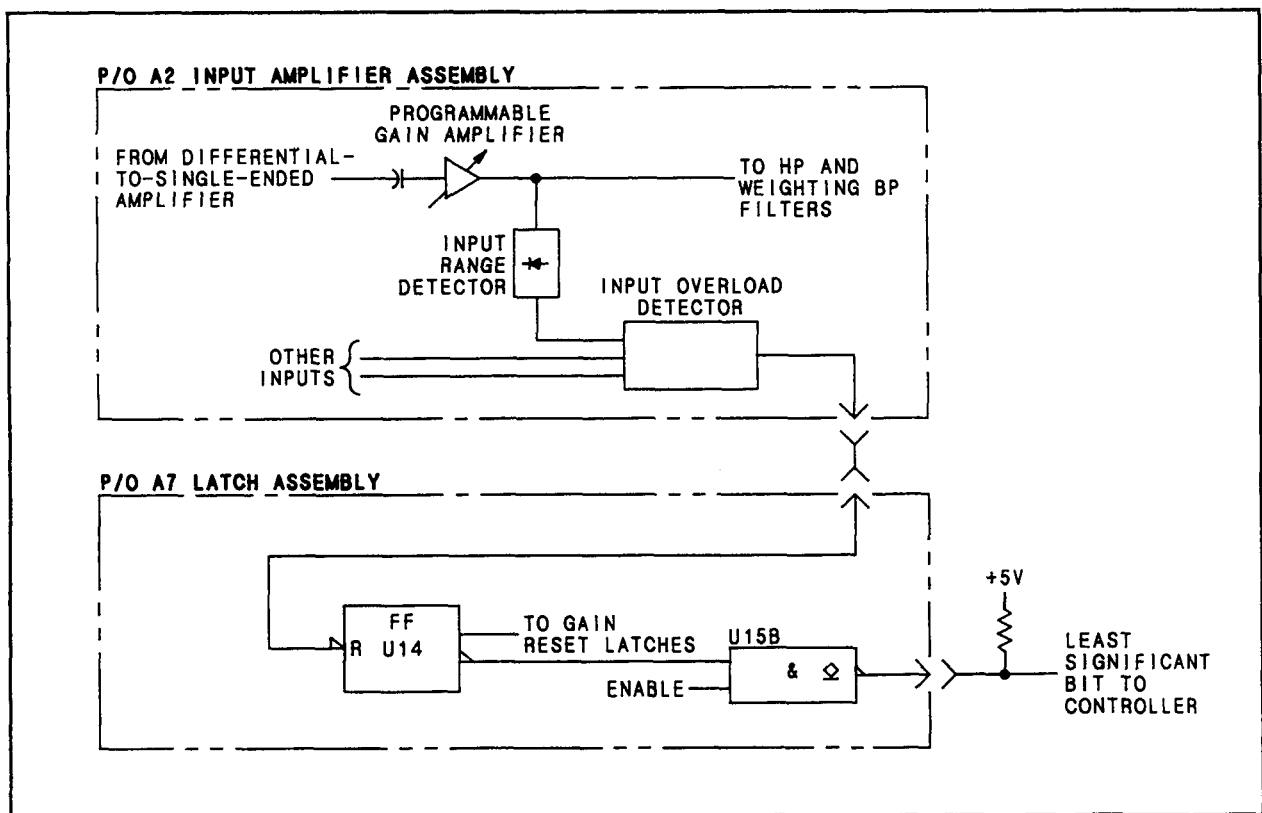


Figure 8-5. Example Showing Input Overload Detector Readback

To clarify this, suppose that A7U14 has not been reset. If Direct Control Special Function 0.700 is entered, the displays will show 0000 0000. The second four digits are 0000 because $d=0$ was received by the Controller from the keyboard and issued to the Instrument Bus. The un-reset flip-flop puts a low on the input of A7U15B and an inactive high on the least-significant data line. This is read by the Controller as $r=0$ and thus is the same as the bit issued. The other three data readback lines are unaffected by the readback command and remain 000. Thus the d read back is 0000.

If A7U14 is reset, A7U15B puts a low on the least-significant data bit ($r=1$), and the data read back is 0001. The displays are therefore 0001 0000. (Note that $rrrr$ is different from www .) If d is keyed in as a hexadecimal F, the displays are 1111 1111 regardless of the state of A7U15B. This is because all output devices on the data I/O port of the Controller are on (logical 1).

One final note, after a Direct Control Special Function is entered, it is periodically re-issued to the Instrument Bus. If a fault causes $rrrr$ to indicate a malfunction, the display will begin to read correctly as soon as the

fault is removed. For example, if you key in 0.700 SPCL then increase the input signal level until an overload condition is reached, you will find that the displays show 0000 0000 continuously except for the instant the overload is detected (when the displays momentarily blink 0001 0000). An automatic resetting of the input circuits removes the overload as soon as it is detected so the overload is observed only for one period of the Direct Control Special Function cycle.

8-23. Service Special Functions (Prefix 40-99)

The Service Special Functions are used to perform a variety of tasks related to service. The functions are cataloged below. A suffix N indicates that a parameter other than 0 may be required to complete the Special Function Code. See Table 8-1 for entry of hexadecimal suffixes.

40.0 Controller Reset. Initializes the Controller to its power-up state. Because this disturbs the HP-IB hardware, it is unavailable from HP-IB (gives Error 24). The power-up sequence is discussed in paragraph 8-27.

41.0 Controller Clear. Initializes the Controller to its power-up state but bypasses the operational checks (see paragraph 8-27). Leaves HP-IB hardware unaffected but clears any service request message (SRQ) being issued by the Audio Analyzer, sets the service request condition to its power-up state, and clears all bits in the status byte.

42.0 Display Software Date. Displays the date of the software in the form: <month of year>.<day of month> in the left display and <year> in the right display.

43.N Service Error Display Control. Service Errors are numbered 65 to 95. Refer to paragraph 8-26.

N=0 Disables display of Service Errors.

N=1 Enables display of Service Errors.

N=65 to N=95 quad Enables display of only the Service Error specified by N. Operating and Entry Errors remain enabled.

44.N Notch Filter Mode Select. Permits manual selection of one of three configurations of the Notch Filter.

N=0 Notch Filter mode selected automatically as required by the measurement mode.

N=1 Notch Filter in notch mode.

N=2 Notch Filter in flat mode.

N=3 Notch Filter in bandpass mode.

45.N SINAD Meter Enable. Permits the SINAD meter to be enabled for measurement modes other than SINAD and, in the SINAD mode, for measurements greater than 24 dB. It is most often useful for reading distortion when the displayed reading is very noisy. When this Special Function is invoked, the meter reads the ratio of the level at the Pre-Notch RMS/Average Detector to the Output RMS/Average/Quasi-peak Detector, expressed in dB. The reading must, therefore, be interpreted relative to the dB reading in the right display. Usually, this entails ignoring the minus sign and subtracting multiples of 20 dB. For example, a distortion reading of -66.80 dB in the right display may be indicated as 6.8 dB on the SINAD meter or -76.80 dB may be indicated as 16.8 dB. AC level readings will normally be 0 dB.

N=0 SINAD meter enabled normally. See *Detailed Operating Instructions* in Section 3.

N=1 SINAD meter enabled in all measurement modes except dc level.

46.N Count Internal Signals. The Counter counts the internal signal selected by N and displays the count. The resolution is the same as would normally be displayed.

N=0 Oscillator Frequency. See Service Sheets 9 and 13.

N=1 Input Frequency. See Service Sheets 2 and 13.

N=3 Output Amplifier Frequency. See Service Sheets 5 and 13.

48.N Defeat Output Amplifier Overdrive Protection. In the ac level and signal-to-noise measurement modes, the gain of the Output Amplifier is normally set to 0 dB whenever the signal detected by the Pre-Notch RMS/Average Detector exceeds 0.6V and a low-pass filter has been selected. This prevents the first amplifier after the Notch Filter from being overdriven by signals in the stopband which would normally be detected by the Output RMS/Average/Quasi-peak Detector. When this Special Function is invoked, the Output RMS/Average/Quasi-peak Detector is used to determine the gain setting of the Output Amplifier. Use of this function permits measurement of filters (such as the internal, optional weighting bandpass filters) with extended dynamic range, but care must be taken not to overload the selected low-pass filter (either 30 or 80 kHz).

N=0 Output Amplifier gain determined normally.

N=1 Output Amplifier gain determined by the Output RMS/Average/Quasi-peak Detector.

49.N Display Internal Voltages. The Voltmeter measures and displays the internal voltage selected by N.

N=0 Ground. See Service Sheet 7.

N=1 Pre-Notch RMS/Average Detector with Ripple Filter. See Service Sheets 2 and 7.

N=2 DC Input Voltage without Filter. See Service Sheet 1.

N=3 Output RMS/Average/Quasi-peak Detector with Ripple Filter. See Service Sheets 6 and 7.

N=4 Output RMS/Average/Quasi-peak Detector. See Service Sheet 6.

N=5 Output RMS/Average/Quasi-peak Detector with SINAD Filter. See Service Sheets 6 and 7.

N=6 Notch Tune Voltage. See Service Sheet 4.

N=7 DC Input Voltage with Filter. See Service Sheet 1.

N=B Input Range Detector. See Service Sheet 2.

NOTE

The suffix can also be two digits, XY. The difference (49.X SPCL – 49.Y SPCL) is then displayed. For example, 49.3 SPCL or 49.30 SPCL gives a display of the Output RMS/Average/Quasi-peak Detector with Ripple Filter with respect to ground. 49.34 SPCL gives a display of the difference between the Output RMS/Average/Quasi-peak Detector with Ripple Filter and the same detector without the Ripple Filter.

50.N Display Oscillator Frequency. The frequency of the Oscillator is displayed in the left display in all measurement modes except dc level and where a valid measurement cannot be made. The right display operates as usual. Resolution is the same as it would be if it had been an input signal.

N=0 Display frequency as normal.

N=1 Display Oscillator frequency.

52.N Read Only Memory Verification. The Controller displays the checksum of the read only memory (ROM) specified by N. When specifying a ROM, use N=1 through 10. The display is in the form: <actual checksum> in the left display and <expected checksum> in the right display. Both displays should show 0 for ROM 10. See Service Sheet 16. **Serial Prefix 2652A and Above:** ROM consolidation does not change this Verification.

53.N Notch Filter Frequency Range. Permits the frequency range of the Notch Filter to be displayed or manually set. If no suffix is keyed in (that is, 53. SPCL), the current Notch Filter range is displayed, where 0 is the lowest range and 3 is the highest. For N=0 through 3, the Notch Filter is set to the range specified by N. See Service Sheet 3 and Special Function 54.N.

54.N Notch Filter Coarse Tune. Permits the coarse-tune code of the Notch Filter to be displayed or manually set. If no suffix is keyed in (that is, 54. SPCL), the current Notch Filter coarse-tune code is displayed, where 0

is the lowest frequency and 255 is the highest. For N=0 through 255, the Notch Filter coarse-tune code is set to the number specified by N. (N is keyed in as a decimal value and not a hexadecimal value.) Fine tuning of the Notch Filter is via the automatic tuning circuitry on the Notch Filter Assembly. See Service Sheet 3 and Special Function 53.N.

55.N Oscillator Frequency Range. Permits the frequency range of the Oscillator to be displayed or manually set. If no suffix is keyed in (that is, 55. SPCL), the current Oscillator range is displayed, where 0 is the lowest range and 3 is the highest. For N=0 through 3, the Oscillator is set to the range specified by N. See Service Sheet 8 and Special Functions 56.N and 57.N.

56.N Oscillator Coarse Tune. Permits the coarse-tune code of the Oscillator to be displayed or manually set. If no suffix is keyed in (that is, 56. SPCL), the current Oscillator coarse-tune code is displayed, where 0 is the lowest frequency and 255 is the highest. For N=0 through 255, the Oscillator coarse-tune code is set to the number specified by N. (N is keyed in as a decimal value and not a hexadecimal value.) See Service Sheet 9 and Special Functions 55.N and 57.N.

57.N Oscillator Fine Tune. Same as Special Function 56.N except that it pertains to fine tuning.

58.N Source Fine Level. Permits the fine-level code of the Source to be displayed or manually set. If no suffix is keyed in (that is, 58. SPCL), the current Source fine-level code is displayed, where 0 is the lowest level and the 255 is the highest. For N=0 through 255, the Source fine-level code is set to the number specified by N. (N is keyed in as a decimal value and not a hexadecimal value.) See Service Sheet 10 and Special Function 59.N.

59.N Source Coarse Level. Permits the coarse-level code of the Source to be displayed or manually set. If no suffix is keyed in (that is, 59. SPCL), the current Source coarse-level code is displayed where 31 is the lowest level, 0 is the highest, and 32 through 63 switch the level off. For N=0 through 63, the Source coarse-level code is set to the number specified by N. For N=0 through 31, the level is controlled in 2.5 dB steps, where the attenuation is N times 2.5 dB. (N is keyed in as a decimal value and not a hexadecimal value.) See Service Sheet 11 and Special Function 58.N.

60.0 Key Scan. The keyboard is scanned and a keycode is displayed and output to the HP-IB. The key codes are shown in Figure 8-6.

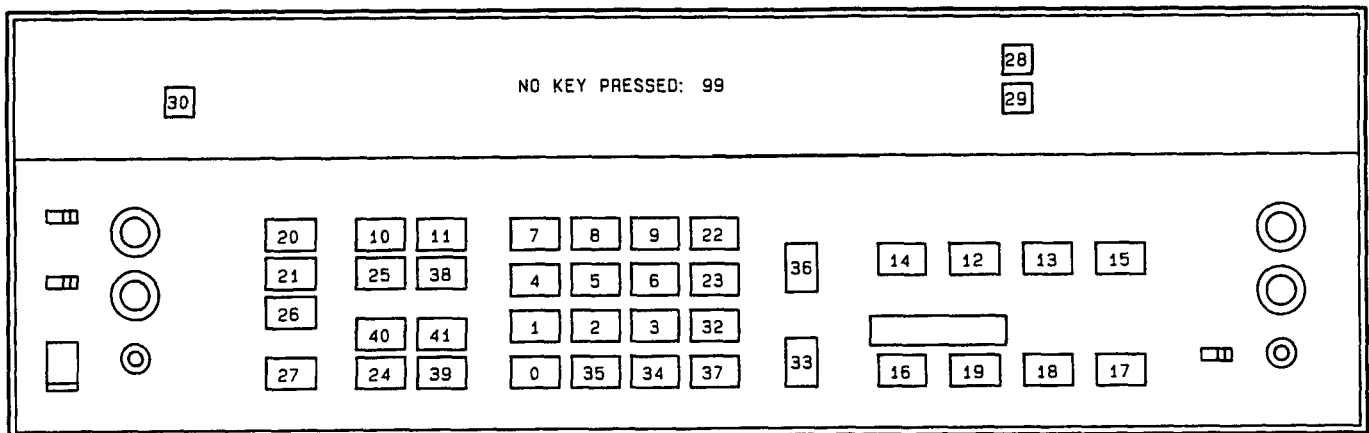


Figure 8-6. Key Codes for Key Scan (Service Special Function 60.0)

To use the Key Scan Special Function, remove the instrument top cover. Key in 60.0 SPCL, then jumper A8U6 pin 7 to A8TP3 (GND) on the A8 Controller/Counter Assembly. Press the front-panel keys and observe the right display. If two or more keys are pressed simultaneously, the display shows the first one found in its normal scan. See Service Sheet 17.

Two simple programs for displaying the key codes on a computing controller are shown in Table 8-3. Removal of the top cover is unnecessary. The Audio Analyzer is assumed to have HP-IB address 28.

Table 8-4. PIO Port A

A9U18 Pin	2	37	36	31	30	25	24	19
Display Digit	1	2	3	4	5	6	7	8
Mnemonic	IO8	IO7	IO6	IO5	IO4	IO3	IO2	IO1
1 = True								

Table 8-5. PIO Port B

A9U18 Pin	1	38	35	32	29	26	23	20
Display Digit	1	2	3	4	5	6	7	8
Mnemonic	ATN	ARD	AAD	SRQ	RNL	ATT	ATL	SDV
1 = True								

8-24. ERROR MESSAGES

8-25. General

The instrument generates error messages to indicate operating problems, incorrect keyboard entries, or service-related problems. The error message is generally cleared when the error condition is removed. The error messages are grouped by error code as follows:

Error 10 through Error 39 and Error 96. These are Operating and Entry Errors which indicate that not all conditions have been met to assure a calibrated measurement or that an invalid key sequence or keyboard entry has been made. Operating Errors can usually be cleared by readjustment of the front-panel controls. The Error Disable Special Function (8.N) can be used to selectively disable certain operating error messages. Entry Errors require that a new keyboard entry or function selection be made. More information on Operating and Entry Errors and error message disabling can be found under *Error Message Summary* and *Error Disable* in the *Detailed Operating Instructions* in Section 3 and on the Operating Information pull-out cards.

Error 65 through Error 95. These are Service Errors which provide additional service-related information and are discussed below.

8-26. Service Errors (Error 65 through Error 95)

Service Errors are not normally displayed. When a service-related problem is suspected, enable the Service Errors by keying in 43.1 SPCL. Also a specific error message can be enabled by keying in 43.N where N is the number of the desired error message (N=65 through 95). Service Errors can be disabled by keying in 43.0 SPCL or by pressing AUTOMATIC OPERATION. Not all Service Errors are an indication of a problem but may be a normal occurrence under the circumstances. When Service Errors are not enabled, a Service Error will often map into an Operating or Entry Error; when Service Errors are enabled, both Service and Operating or Entry Errors are displayed sequentially.

Error 65 Decimal Point Fixed Too Far to the Left. The decimal point has been held by Special Function 4.N and the reading to be displayed is too large to fit the display. This error maps into Error 10.

Error 70 Cannot Count Oscillator Frequency. When the Oscillator is being tuned (that is, when a new frequency is entered or a new measurement mode requiring tuning has been selected), the frequency count is 0. See Service Sheets BD3 and BD4. This error maps into Error 19.

Error 71 Oscillator Tune Abort. The Oscillator failed to tune after three attempts. See Service Sheet BD3. This error is identical to Error 18.

Error 72 AC Input Overload with Input Range Hold. For all measurements except dc level, the Input Overload Detector has tripped while the input level range has been held with Special Function 1.N. See Service Sheet BD2. This error maps into Error 30.

Error 73 Input AC Level Abort. For all measurements except dc level, the Input Amplifier failed to level after three attempts. This would be normal for an unstable signal. See Service Sheet BD2. This error maps into a display of "----" until Error 31 appears.

Error 74 Output Amplifier Overload with Output Amplifier at 0 dB Gain. The Output Overload Detector has tripped with the Output Amplifier gain at 0 dB. See Service Sheet BD2. This error maps into a display of "----" until Error 31 appears.

Error 75 DC Input Overload with Input Range Hold. For a dc level measurement only, the Input Overload Detector has been tripped while the input level range has been held with Special Function 2.N. See Service Sheet BD2. This error maps into Error 30.

Error 76 Too Much AC for DC Level Measurement. For a dc level measurement, the Input Overload Detector has tripped because of too much ac (as sensed by the Input Range Detector). This error maps into Error 14 or generates a normal range down.

Error 77 Output Amplifier Gain Too High after Leveling Once. The Output RMS/Average/Quasi-peak Detector has sensed too high a level after one attempt to set the Output Amplifier gain. This would be normal for an unstable signal. See Service Sheet BD3. This error maps into a display of "----" until Error 31 appears.

Error 78 Output Amplifier Overload after Leveling Once. The Output Overload Detector has tripped after one attempt to set the Output Amplifier gain. This would be normal for an unstable signal. See Service Sheet BD3. This error maps into a display of "----" until Error 31 appears.

Error 79 Output Amplifier Overload with No Post-Notch Gain Hold. The Output Overload Detector remains tripped after three attempts to set the Output Amplifier gain and Special Function 3.N is in automatic selection. See Service Sheet BD3. This error maps into a display of "----" until Error 31 appears.

Error 80 Cannot Count Oscillator Frequency in SINAD. When the Oscillator is attempting to tune to the frequency of the Notch Filter, the frequency count is 0. See Service Sheets BD3 and BD4. This error maps into Error 19.

Error 81 Cannot Count Input Frequency. The input frequency cannot be counted in ac level, distortion, distortion level, or signal-to-noise measurement modes. See Service Sheet BD2. This error maps into Error 13.

Error 82 Notch Filter Does Not Null. The Notch Filter does not null after three attempts. This would be normal for an erratic signal. See Service Sheet BD2. This error maps into Error 13.

Error 83 Cannot Count Input Frequency. After sensing the presence of a signal, the count is 0. This would be normal when the input signal is filtered by the High-Pass and Weighting Bandpass Filters. See Service Sheet BD2. This error gives rise to a display of 0.00 Hz.

Error 84 Output Amplifier Overvoltage with No Overload. The Output RMS/Average/Quasi-peak Detector senses an overvoltage, the Output Amplifier gain is 0 dB, but the Output Overload Detector has not tripped. See Service Sheet BD2. This error maps into a display of "----" until Error 31 appears.

Error 85 Period of the Voltage-to-Time Converter 0. The Counter receives no pulses from the Voltage-to-Time Converter. This can occur if the input to the Voltage-to-Time Converter is too negative. See Service Sheet BD2. This error is identical to Error 17.

Error 86 Frequency Count Greater Than 200 kHz. This error causes a display of 0.000 kHz.

Error 87 Output Amplifier Overload with Post-Notch Gain Hold. The Output Overload Detector remains tripped after three attempts to set the Output Amplifier gain and Special Function 3.N has been selected. See Service Sheet BD2. This error maps into Error 19.

Error 88 Attempt to Take Log of Negative Ratio. This error maps into Error 11.

Error 89 Attempt to Take Log of Negative Number. This error maps into Error 11.

Error 90 Decimal Point Fixed and Exponent Too Large. One of the mV ranges has been requested by Special Function 4.N for a measurement that does not use those ranges. This error maps into Error 10.

Error 91 Decimal Point Fixed Too Far to the Left. The decimal point has been held by Special Function 4.N and the reading to be displayed is too large to fit the display. This error maps into Error 10.

Error 92 Decimal Point Fixed and Unable to Display. This error maps into Error 10.

Error 93 Number to Be Displayed Greater Than 9999. This error maps into Error 10.

Error 94 Attempt to Divide by Zero in Ratio. This error maps into Error 11.

Error 95 Signal-to-Noise Ratio Too Large to Calculate. This error maps into Error 10.

POWER-UP CHECKS

8-27. POWER-UP CHECKS

When the Audio Analyzer is first turned on (or if Special Function 40.0 is entered), the instrument goes through a series of operational checks. When a check fails, an error code is output for two seconds on the four internal TEST LEDs on the A8 Controller/Counter Assembly. The sequence then continues on to the next check.

Except for the check of the front-panel LED annunciators, no indication of the power-up sequence or results is given on the front-panel displays. The principal advantages to using the Power-Up Checks are that the keyboard and display need not be operational.

To use the Power-Up Checks, remove the top cover (refer to *Top and Bottom Cover Removal*, Service Sheet A), remove any signal at the INPUT, and switch the LINE to OFF for five seconds (to discharge the supplies) and back to ON. Observe the four TEST LEDs on the top of the Controller/Counter Assembly as the instrument powers up. The LEDs should light in the following sequence:

1. Indeterminate for about 1/8 second.
2. () () () (1) for about 1 second.
3. (8) (4) (2) (1) for about 2 seconds.
4. (8) (4) (2) (1), with (1) blinking indefinitely until a key is pressed.

The Power-Up Checks actually begin at step 2 (above) and are carried out in the following order:

1. **Front-Panel Annunciator Check.** All front-panel LEDs and display segments and decimal points are lighted and remain so throughout the tests that follow and for about one second afterwards. Failure of one or more LEDs or segments indicates that the respective components or drive circuits have failed. See Service Sheet 18.
2. **Read Only Memory Check.** The checksum of each of the read only memories (ROMs) is read and compared against a stored reference (stored in ROM 1). (This is similar to entering a series of 52.N SPCL commands—see *Service Special Functions*, paragraph 8-23.) When a wrong checksum is found, the four TEST LEDs blink for one second with the binary code of the ROM number. For example, if ROM 5 is faulty, the TEST LEDs will blink () (4) () (1)—that is, 0101, a binary 5. The check then continues on to the next ROM. See Service Sheets BD4 and 16. If no faulty ROM is found, a steady () () () (1) appears for about 370 second. **Serial Prefix 2652A and Above:** ROM Consolidation does not change this Check. Note however, that if any “ROM” check produces an error, the entire ROM 10 needs to be replaced.
3. **Random Access Memory Check.** Data is stored into and retrieved from the random access memory (RAM). If the data read back differs from the data entered, error code () () (2) () is output to the TEST LEDs for two seconds. See Service Sheet 15.
4. **Instrument Bus Parity Check.** A parity check of the data lines of the Instrument Bus is made. A failure is indicated by () () (2) (1) on the TEST LEDs for two seconds. See Service Sheets BD4, 12, and 16.
5. **Keyboard Check.** The keyboard is scanned to see if any keys are down. If a key is down, error code () (4) () () is output to the TEST LEDs for two seconds. See Service Sheets BD4 and 17.

CONTROLLER TEST LEDS AND TEST POINTS

8-28. CONTROLLER TEST LEDS AND TEST POINTS

Near the top edge of the A8 Controller/Counter Assembly are located four test points and four associated LED annunciators labeled TEST which are used primarily for troubleshooting the instrument. The LED annunciators are labeled (from left to right) 8, 4, 2, and 1 and are associated with test points A, B, C, and D respectively.

The label on the annunciators is sometimes used to represent a binary weighting. They function in the following way:

1. At instrument power-up the TEST annunciators light in a certain sequence that indicates proper functioning of several vital areas of the instrument. A failure in any of the areas is indicated on the annunciators. For details see *Power-Up Checks*, paragraph 8-27.
2. After power-up, annunciator 1 toggles once for each measurement cycle.
3. After power-up, annunciator 2 toggles once for each keyboard interrupt (that is, each time a key is pressed).
4. After power-up, annunciator 4 toggles once for each HP-IB interrupt.

Grounding of certain of the TEST test points alters instrument operation in the following ways:

1. Grounding test point C on power-up initiates the Counter, Latch, and Controller I/O signature analysis troubleshooting routines. See Service Sheet 14.
2. Grounding test point D on power-up initiates the Keyboard signature analysis troubleshooting routine. The signature analyzer's start and stop leads are then connected to test point A and the probe leads are then connected to test point B. See Service Sheet 17.

Whenever a test point is grounded, the associated annunciator is extinguished.

SIGNATURE ANALYSIS

8-29. SIGNATURE ANALYSIS

Signature analysis is a simple method of verifying the operation of digital circuitry. When properly used, signature analysis can detect extremely subtle hardware faults. Signatures must identically match those given in the signature tables. If everything is working correctly, signatures will all match exactly. If they don't match, by even one digit, something is wrong.

The Keyboard and Display, Latch, and Counter/Controller Assemblies (A1, A7, and A8) are designed for troubleshooting with signature analysis. Signature analysis is a method of digital signal tracing using test routines programmed in the Audio Analyzer's ROM. With the Audio Analyzer's Controller executing the signature analysis routine, the signature analyzer's test probe is used to check nodes in the circuit under test. The signature analyzer converts the signals at the node into a four digit "signature", which it displays. This signature is then compared to the signature in the troubleshooting checks adjacent to the appropriate schematic. These two signatures must be identical.

Signature analysis can be speeded up if the following considerations are kept in mind:

1. Make sure that every step is performed as described in the set-up procedure. That is, make sure that the clock, start, and stop connections and triggering are correct.
2. Double-check to ensure that the signatures are being taken at the correct node.
3. Make sure that the signature analyzer probe is making good contact with the pin being checked. Oxidation on pins can cause invalid signatures due to poor contact.
4. When you think that you have found a bad signature, double check to make sure.
5. When checking a node, be sure that the unstable signature indicator is not blinking.

SCHEMATIC SYMBOLOGY AND SCHEMATIC DIAGRAM NOTES

8-30. SCHEMATIC SYMBOLOGY AND SCHEMATIC DIAGRAM NOTES

Table 8-6 summarizes the symbology used in presenting many devices found in the instrument. The logic symbols used in this manual are based on the Institute of Electrical and Electronic Engineers (IEEE) in IEEE-STD 91-1984, *Graphic Symbols for Logic Functions*. This publication may be purchased from:

Institute of Electrical and Electronic Engineers Inc.
 345 East 47th Street
 New York, NY 10017

Table 8-6. Schematic Diagram Notes (1 of 11)

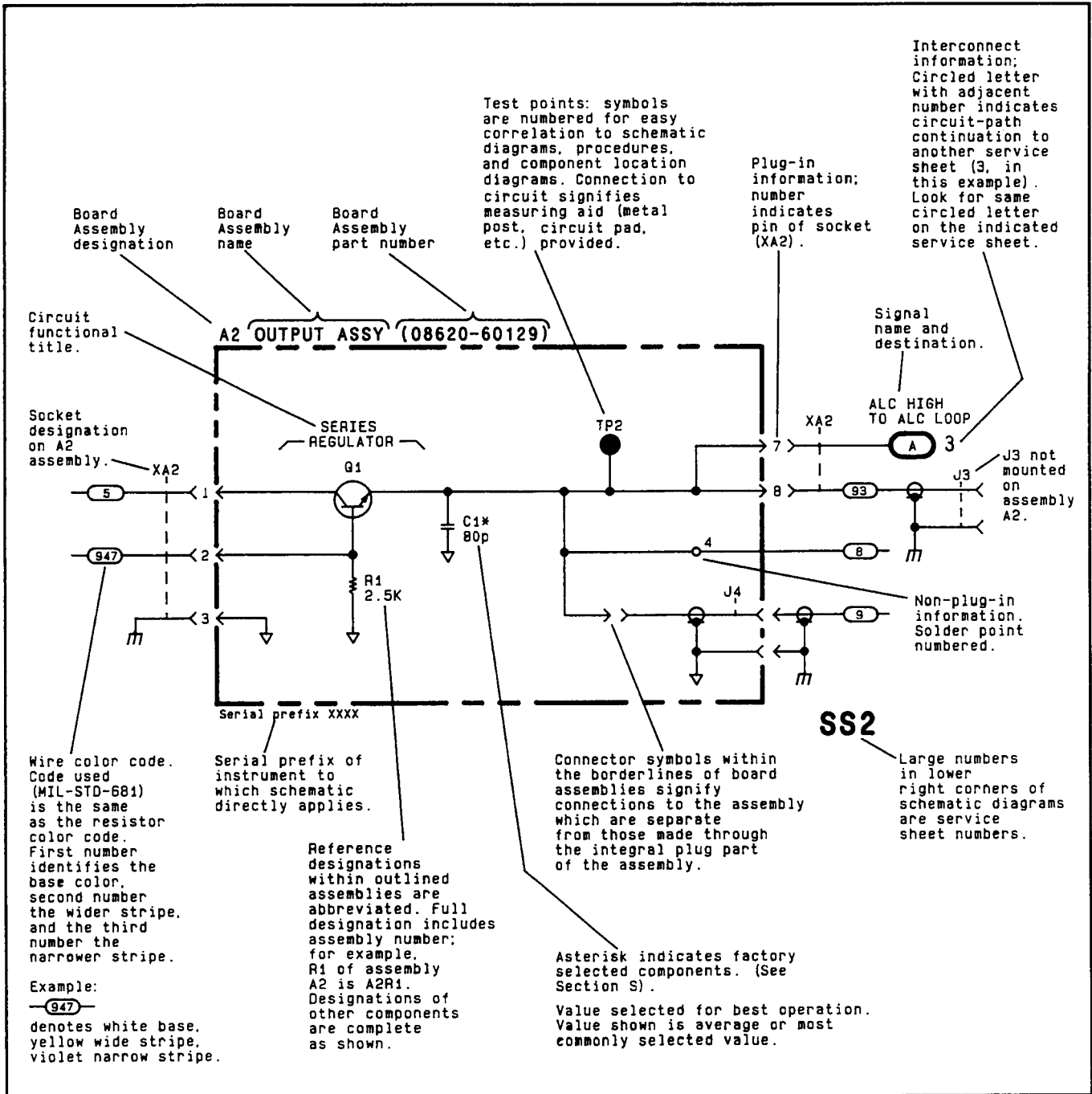


Table 8-6. Schematic Diagram Notes (2 of 11)

Values for all components are marked in units of farads, henries, and ohms unless otherwise specified.



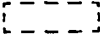

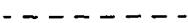











*	Asterisk denotes a factory-selected value. Value shown is typical. See Section V.
	Tool-aided adjustment.
	Encloses front-panel designation.
	Encloses rear-panel designation
	Circuit assembly borderline.
	Other assembly borderline.
	Heavy line with arrows indicates path and direction of main signal.
	Heavy dashed line with arrows indicates path and direction of main feedback.
	Indicates stripline (i.e., RF transmission line above ground).
	Wiper moves toward cw with clockwise rotation of control (as viewed from shaft or knob).
	Numbered Test Point measurement aid provided.
	Encloses wire or cable color code. Code used is the same as the resistor color code. First number identifies the base color, second number identifies the wider stripe, and the third number identifies the narrower stripe, e.g., 947 denotes white base, yellow wide stripe, violet narrow stripe.
	A direct conducting connection to earth, or a conducting connection to a structure that has a similar function (e.g., the frame of an air, sea, or land vehicle).
	A conducting connection to a chassis or frame.
	Common connections. All like-designation points are connected.
	Letter = off-page connection. Number = Service Sheet number for off-page connection. In the example, signal flow is continued on Service Sheet 12, at the point marked
	Number (only) = on-page connection.

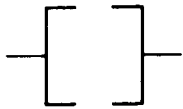
Table 8-6. Schematic Diagram Notes (3 of 11)

	<p>Indicates multiple paths represented by only one line. Letters or names identify individual paths. Numbers indicate number of paths represented by the line.</p>
	<p>Coaxial or shielded cable.</p>
	<p>Ferrite bead. (Increases the self-inductance of the conductor passing through the bead.)</p>
	<p>Relay. Contact moves in direction of arrow when energized.</p>
	<p>Indicates a pushbutton switch with a momentary (ON) position.</p>
	<p>Feedthrough capacitor. (Acts as a feedthrough terminal when mounted on a chassis or a frame.)</p>
	<p>Indicates a PIN diode.</p>
	<p>Indicates a current regulation diode.</p>
	<p>Indicates a voltage regulation diode.</p>
	<p>Indicates a capacitive (varactor) diode.</p>
	<p>Indicates a Schottky (hot-carrier) diode.</p>
	<p>Light-emitting diode.</p>
	<p>Multiple transistors in a single package—physical location of the pins is shown in package outline on schematic.</p>
	<p>Identification of logic families as shown (in this case, ECL).</p>

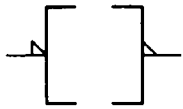
Table 8-6. Schematic Diagram Notes (4 of 11)

DIGITAL SYMBOLOGY REFERENCE INFORMATION

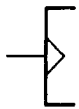
Input and Output Indicators



Implied Indicator—Absence of polarity indicator (see below) implies that the active state is a relative high voltage level. Absence of negation indicator (see below) implies that the active state is a relative high voltage level at the input or output.



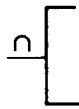
Polarity Indicator—The active state is a relatively low voltage level.



Dynamic Indicator—The active state is a transition from a relative low to a relative high voltage level.



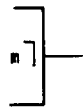
Inhibit Input—Input that, when active, inhibits (blocks) the active state outputs of a digital device.



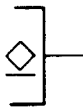
Analog Input—Input that is a continuous signal function (e.g., a sine wave).



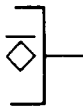
Polarity Indicator used with Inhibit Indicator—Indicates that the relatively low level signal inhibits (blocks) the active state outputs of a digital device.



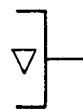
Output Delay—Binary output changes state only after the referenced input (m) returns to its inactive state (m should be replaced by appropriate dependency or function symbols).



Open Collector Output.



Open Emitter Output.



Three-state Output—Indicates outputs can have a high impedance (disconnect) state in addition to the normal binary logic states.

Table 8-6. Schematic Diagram Notes (5 of 11)

DIGITAL SYMBOLOGY REFERENCE INFORMATION

Combinational Logic Symbols and Functions



Σ	Summing Junction—Outputs added together at a common point.
&	AND—All inputs must be active for the output to be active.
≥ 1	OR—One or more inputs being active will cause the output to be active.
$\geq m$	Logic Threshold—m or more inputs being active will cause the output to be active (replace m with a number).
=1	EXCLUSIVE OR—Output will be active when one (and only one) input is active.
=m	m and only m—Output will be active when m (and only m) inputs are active (replace m with a number).
=	Logic Identity—Output will be active only when all or none of the inputs are active (i.e., when all inputs are identical, output will be active).
	Amplifier—The output will be active only when the input is active (can be used with polarity or logic indicator at input or output to signify inversion).
X/Y	Signal Level Converter—Input level(s) are different than output level(s).
	Bilateral Switch—Binary controlled switch which acts as an on/off switch to analog or binary signals flowing in both directions. Dependency notation should be used to indicate affecting/affected inputs and outputs. Note: amplifier symbol (with dependency notation) should be read to indicate unilateral switching.
X→Y	Coder—Input code (X) is converted to output code (Y) per weighted values or a table.
(Functional Labels)	The following labels are to be used as necessary to ensure rapid identification of device function.
MUX	Multiplexer—The output is dependent only on the selected input.
DEMUX	Demultiplexer—Only the selected output is a function of the input.
CPU	Central Processing Unit

Table 8-6. Schematic Diagram Notes (6 of 11)

DIGITAL SYMBOLOGY REFERENCE INFORMATION

Sequential Logic Functions



Monostable—Single shot multivibrator. Output becomes active when the input becomes active. Output remains active (even if the input becomes inactive) for a period of time that is characteristic of the device and/or circuit.



Oscillator—The output is a uniform repetitive signal which alternates between the high and low state values. If an input is shown, then the output will be active if and only if the input is in the active state.

FF

Flip-Flop—Binary element with two stable states, set and reset. When the flip-flop is set, its outputs will be in their active states. When the flip-flop is reset, its outputs will be in their inactive states.

T

Toggle Input—When active, causes the flip-flop to change states.

S

Set Input—When active, causes the flip-flop to set.

R

Reset Input—When active, causes the flip-flop to reset.

J

J Input—Analogous to set input.

K

K Input—Analogous to reset input.

D

Data Input—Always enabled by another input (generally a C input—see Dependency Notation). When the D input is dependency-enabled, a high level at D will set the flip-flop; a low level will reset the flip-flop. Note: strictly speaking, D inputs have no active or inactive states—they are just enabled or disabled.

+m

Count-Up Input—When active, increments the contents (count) of a counter by "m" counts (m is replaced with a number).

-m

Count-Down Input—When active, decrements the contents (count) of a counter by "m" counts (m is replaced with a number).

→m

Shift Right (Down) Input—When active, causes the contents of a shift register to shift to the right or down "m" places (m is replaced with a number).

←m

Shift Left (Up) Input—When active, causes the contents of a shift register to shift to the left or up "m" places (m is replaced with a number).

NOTE

For the four functions shown above, if m is one, it is omitted.

(Functional Labels)

The following functional labels are to be used as necessary in symbol build-ups to ensure rapid identification of device function.

mCNTR

Counter—Array of flip-flops connected to form a counter with modules m (m is replaced with a number that indicates the number of states: 5 CNTR, 10 CNTR, etc.).

Table 8-6. Schematic Diagram Notes (7 of 11)

DIGITAL SYMBOLOGY REFERENCE INFORMATION	
Sequential Logic Functions (Cont'd)	
REG	Register—Array of unconnected flip-flops that form a simple register or latch.
SREG	Shift Register—Array of flip-flops that form a register with internal connections that permit shifting the contents from flip-flop to flip-flop.
ROM	Read Only Memory—Addressable memory with read-out capability only.
RAM	Random Access Memory—Addressable memory with read-in and read-out capability.
Dependency Notation	
Cm	Control Dependency—Binary affecting input used where more than a simple AND relationship exists between the C input and the affected inputs and outputs (used only with D-type flip-flops).
Gm	Gate (AND) Dependency—Binary affecting input with an AND relationship to those inputs or outputs labeled with the same identifier. The m is replaced with a number or letter (the identifier).
Vm	OR Dependency—Binary affecting input with an OR relationship to those inputs or outputs labeled with the same identifier. The m is replaced with a number or the letter (the identifier).
mAm	Address Dependency—Binary affecting inputs of affected outputs. The m prefix is replaced with a number that differentiates between several address inputs, indicates dependency, or indicates demultiplexing of address inputs and outputs. The m suffix indicates the number of cells that can be addressed.
ENm	Enable Dependency—Binary affecting input which, when active enables all outputs. When inactive open-collector and open-emitter outputs are off, and three-state outputs are at an external high impedance state. When the enable input affects only certain inputs and outputs, they will be numbered to indicate the logic connection.
Xm	Transmission Dependency—Binary affecting input which bidirectionally connects dependent inputs and outputs.
Mm	Mode Dependency—Binary affecting input used to indicate that the effects of particular inputs and outputs of an element depend on the mode in which the element is operating. The m is replaced with a number or letter (the identifier).
Zm	Interconnection Dependency—Indicates the existence of internal logic connections between inputs, outputs, internal inputs, and/or internal outputs. The m is replaced with a number (the identifier).
,	Comma—AND Function.
/	Slant—OR Function.
NOTE	
<i>The identifier (m) is omitted if it is one—that is, when there is only one dependency relationship of that kind in a particular device. When this is done, the dependency indicator itself (G, C, EN, or V) is used to prefix or suffix the affected (dependent) input or output.</i>	

*Table 8-6. Schematic Diagram Notes (8 of 11)***DIGITAL SYMBOLOGY REFERENCE INFORMATION****Miscellaneous**

Schmitt Trigger—Input characterized by hysteresis; one threshold for positive going signals and a second threshold for negative going signals.

Active

Active State—A binary physical or logical state that corresponds to the true state of an input, an output, or a function. The opposite of the inactive state.

Table 8-6. Schematic Diagram Notes (9 of 11)

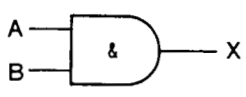
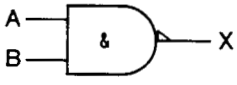
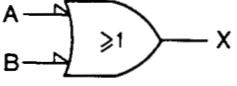
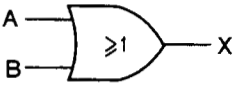
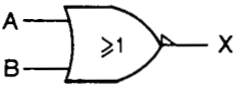
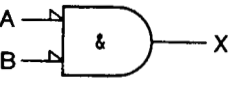
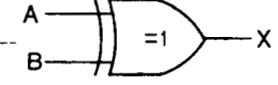
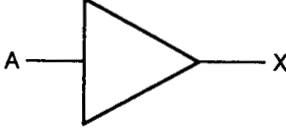
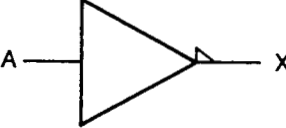
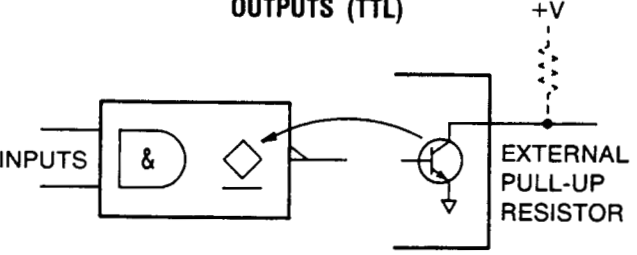
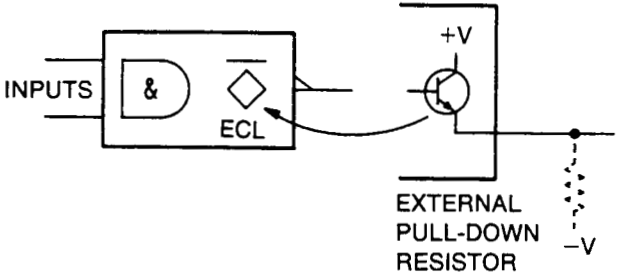
<p>AND GATE</p>  <table border="1" data-bbox="462 383 755 563"> <thead> <tr> <th>A</th> <th>B</th> <th>X</th> </tr> </thead> <tbody> <tr> <td>H</td> <td>H</td> <td>H</td> </tr> <tr> <td>H</td> <td>L</td> <td>L</td> </tr> <tr> <td>L</td> <td>H</td> <td>L</td> </tr> <tr> <td>L</td> <td>L</td> <td>L</td> </tr> </tbody> </table>	A	B	X	H	H	H	H	L	L	L	H	L	L	L	L	<p>NAND GATE</p>  <table border="1" data-bbox="1136 372 1429 553"> <thead> <tr> <th>A</th> <th>B</th> <th>X</th> </tr> </thead> <tbody> <tr> <td>H</td> <td>H</td> <td>L</td> </tr> <tr> <td>H</td> <td>L</td> <td>H</td> </tr> <tr> <td>L</td> <td>H</td> <td>H</td> </tr> <tr> <td>L</td> <td>L</td> <td>H</td> </tr> </tbody> </table> <p>OR GATE WITH INVERTED INPUTS</p> 	A	B	X	H	H	L	H	L	H	L	H	H	L	L	H
A	B	X																													
H	H	H																													
H	L	L																													
L	H	L																													
L	L	L																													
A	B	X																													
H	H	L																													
H	L	H																													
L	H	H																													
L	L	H																													
<p>OR GATE</p>  <table border="1" data-bbox="462 819 755 1000"> <thead> <tr> <th>A</th> <th>B</th> <th>X</th> </tr> </thead> <tbody> <tr> <td>H</td> <td>H</td> <td>H</td> </tr> <tr> <td>H</td> <td>L</td> <td>H</td> </tr> <tr> <td>L</td> <td>H</td> <td>H</td> </tr> <tr> <td>L</td> <td>L</td> <td>L</td> </tr> </tbody> </table>	A	B	X	H	H	H	H	L	H	L	H	H	L	L	L	<p>NOR GATE</p>  <table border="1" data-bbox="1128 755 1421 936"> <thead> <tr> <th>A</th> <th>B</th> <th>X</th> </tr> </thead> <tbody> <tr> <td>H</td> <td>H</td> <td>L</td> </tr> <tr> <td>H</td> <td>L</td> <td>L</td> </tr> <tr> <td>L</td> <td>H</td> <td>L</td> </tr> <tr> <td>L</td> <td>L</td> <td>H</td> </tr> </tbody> </table> <p>AND GATE WITH INVERTED INPUTS</p> 	A	B	X	H	H	L	H	L	L	L	H	L	L	L	H
A	B	X																													
H	H	H																													
H	L	H																													
L	H	H																													
L	L	L																													
A	B	X																													
H	H	L																													
H	L	L																													
L	H	L																													
L	L	H																													
<p>EXCLUSIVE-OR GATE</p>  <table border="1" data-bbox="454 1255 747 1436"> <thead> <tr> <th>A</th> <th>B</th> <th>X</th> </tr> </thead> <tbody> <tr> <td>H</td> <td>H</td> <td>L</td> </tr> <tr> <td>H</td> <td>L</td> <td>H</td> </tr> <tr> <td>L</td> <td>H</td> <td>H</td> </tr> <tr> <td>L</td> <td>L</td> <td>L</td> </tr> </tbody> </table>	A	B	X	H	H	L	H	L	H	L	H	H	L	L	L	<p>BUFFER</p>  <table border="1" data-bbox="1153 1095 1356 1223"> <thead> <tr> <th>A</th> <th>X</th> </tr> </thead> <tbody> <tr> <td>H</td> <td>H</td> </tr> <tr> <td>L</td> <td>L</td> </tr> </tbody> </table> <p>INVERTER</p>  <table border="1" data-bbox="1153 1372 1356 1500"> <thead> <tr> <th>A</th> <th>X</th> </tr> </thead> <tbody> <tr> <td>H</td> <td>L</td> </tr> <tr> <td>L</td> <td>H</td> </tr> </tbody> </table>	A	X	H	H	L	L	A	X	H	L	L	H			
A	B	X																													
H	H	L																													
H	L	H																													
L	H	H																													
L	L	L																													
A	X																														
H	H																														
L	L																														
A	X																														
H	L																														
L	H																														
<p>OPEN COLLECTOR OUTPUTS (TTL)</p> 	<p>OPEN EMITTER OUTPUTS (ECL)</p> 																														

Table 8-6. Schematic Diagram Notes (10 of 11)

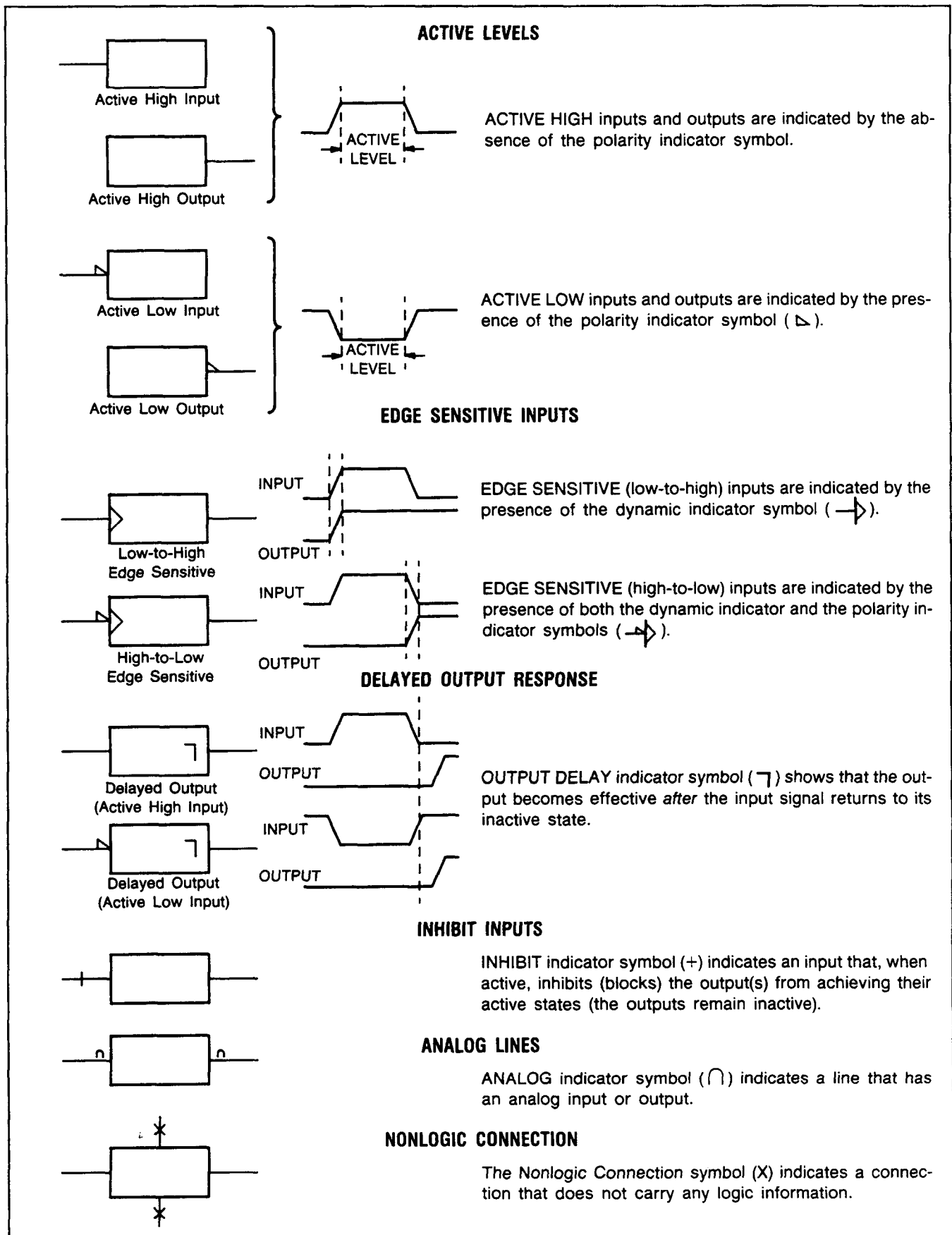
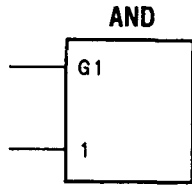
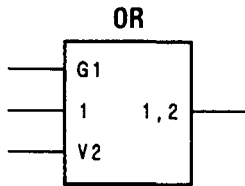


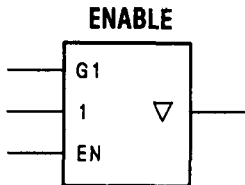
Table 8-6. Schematic Diagram Notes (11 of 11)



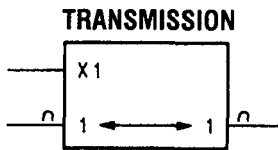
The input that controls or gates other inputs is labeled with a C or a G, followed by an identifying number. The controlled or gated input or output is labeled with the same number. In this example, 1 is controlled by G1.



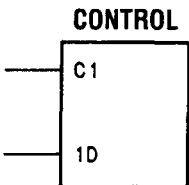
When a V input is active, the output will be in its active state. With the V input inactive, the device functions as if the V input doesn't exist.



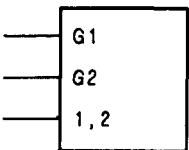
When the EN input is active, the output is enabled to function normally. When the EN input is inactive, the three-state output (▽), in this case, becomes a high impedance, effectively removing that device from the circuit.



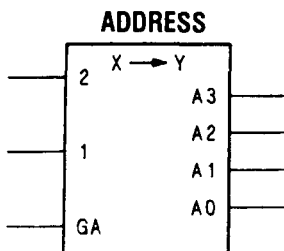
When the X1 input is active, the associated input-output pair are bi-directionally connected together. When X1 is inactive, the connection is broken.



When the controlled or gated input or output already has a functional label (D is used here), that label will be prefixed by the identifying number.



If the input or output is affected by more than one gate or control input, then the identifying numbers of each gate or control input will appear separated by commas.



When GA is active, the active address line (0 through 3) is the decoded value of the 1 and 2 binary inputs. When the controlled address lines have a functional value, that value will be prefixed by the identifying letter.

SERVICE SHEET BD1—Overall Block Diagram

PRINCIPLES OF OPERATION

General

The Audio Analyzer can be conceptually broken down into four subsections. The subsections are shown in Table 8A-1. Service Sheets BD2 through BD5 break the operation of the instrument along similar lines as indicated in the table.

Table 8A-1. Instrument Block Diagram and Subsection Breakdown

Service Sheet	Subsection	Circuits
BD2	Measurement	Input, Notch Filter, Output Amplifier, Detectors, DC Voltmeter
BD3	Source	Oscillator, Output Attenuator
BD4	Digital	Controller, Counter, Keyboard and Display, Remote Interface
BD5	Power Supply	Power Supplies, Motherboard

Input Circuits

Measurements on the input signal are made on the difference between the HIGH and LOW INPUT connectors. The range of signals at the INPUT connectors is 20 Hz to 100 kHz and 0 to 300 Vrms for ac signals and 0 to 300V (either polarity) for dc signals. Either INPUT connector (HIGH or LOW) can be floated upto 300V with respect to ground.

For ac measurements, the AC/DC Switches insert a capacitor into both the high and low paths. The ac input impedance for each path is 100 k Ω with respect to ground. The dc impedance is 101 k Ω .

The Input Attenuator has voltage dividers on both high and low paths which can be set to 0, -12, -24, or -40 dB. In automatic operation the gain is set to 0 dB when the input signal is 3V or less.

The Over-Voltage Protection circuitry limits the input signal level of either the high or low path to ± 13 Vp. In addition, the output of the protection circuit is sensed by the Input Overload Detector. If the level exceeds a preset reference, all input circuits are set to minimum gain.

The Differential-to-Single-Ended Amplifier converts the non-referenced, differential signal to a signal referenced to ground. The gain of the amplifier can be set to 0, 8, 16, or 20 dB. (For the dc level measurement mode, the gain is always 0 dB.) The amplifier is dc coupled. When dc level is selected, the output of the amplifier is measured by the dc voltmeter. The output is also sensed by the Input Overload Detector. If the level is more positive than +8.7V or more negative than -8.7V, the detector sets the Input Attenuator to the 40 dB range until the proper range has been determined by the Controller.

The Programmable Gain Amplifier can be set for 0, 4, 8, or 20 dB gain and is ac coupled.

The Input Range Detector is used to set the gain of the input path (Input Attenuator, Differential-to-Single-Ended Amplifier, and Programmable Gain Amplifier). Since it is positioned before the Weighting Bandpass and High-Pass Filters, it prevents overloading of the filters by input signals located in the filter stopbands. The gain of the detector is programed to match the passband gain of the selected filter. (The gain is programed indirectly by the Controller via the filter circuits.)

The gain of the input path is set so that the signal is between 1.7 and 3V at the Input Range Detector. This is the optimum level for the Input Range Detector, the Pre-Notch RMS/Average Detector, and the Notch Filter.

At this point, one of two filters can be inserted in the audio path. The filters available depend upon the options installed. Two types of filters are available: a 400 Hz high-pass filter or a weighted-response, bandpass filter. Table 8A-2 enumerates the filter combinations available. The two filters can be installed in either order with respect to the two front-panel keys (or HP-IB codes); thus each filter has two option numbers. (If no filter options are installed, the filter positions are jumpered.)

Table 8A-2. Filter Options

Filter	Option Numbers
400 Hz High-Pass	010 or 050
CCITT or Psophometric Bandpass	011 or 051
CCIR Bandpass	012 or 052
C-Message Bandpass	013 or 053
CCIR/ARM Bandpass	014 or 054
"A" Weighting Bandpass	015 or 055

Filter selection is via front-panel keys or HP-IB. Both are active filters. The Weighting Bandpass Filter generally has a standardized frequency response that simulates the response of a telecommunications system as perceived by human hearing. It gives predominance to 1 kHz.

The Pre-Notch RMS/Average Detector is read by the Controller via the dc voltmeter for the distortion and SINAD measurements (and also the analog SINAD meter). Its output becomes the numerator of the SINAD measurement and the denominator of the distortion measurement.

Notch Filter

The Notch Filter is inserted into the signal path in the distortion, distortion level, and SINAD measurement modes. It is coarse tuned by the Controller. When measuring distortion, the Controller sets the Notch Filter to the frequency of the signal counted at the input. When measuring SINAD, the Controller sets it to the programmed frequency of the internal oscillator.

A notch-filter frequency response is obtained by passing the signal through a unity-gain, inverting, active bandpass filter, then summing the filter's output with its input. At the center frequency of the bandpass filter, the two signals into the Sum and Output Amplifier nearly cancel. This results in significant rejection of the signal at that frequency. Since the notch is very narrow, only the fundamental is rejected while noise and harmonic components are passed.

The Balance and Fine Tune control circuit uses negative feedback to fine tune the bandpass filter to the signal and to fine adjust (balance) its gain to maximize the depth of the notch. The tuning range of the fine tune control is 8% of the nominal center frequency. Feedback for the Balance and Fine Tune Control circuit comes from Amplifier 1 which follows the Notch Filter. The tuning error is also measured by the DC Voltmeter which is monitored by the Controller. If a large error exists, the Controller takes steps to either retune the Notch Filter or display an error message.

In the other measurement modes, the bandpass filter is not switched in and a flat response results.

Output Circuits

The output from the Notch Filter is attenuated, amplified, and filtered to condition the signal for the most accurate measurement by the Voltmeter. The signal level at the input to the Output RMS/Average/Quasi-peak Detector is normally between 0.3 and 3V. Attenuator 1 is set to either 0 or 20 dB. Amplifier 1 has a gain of 14 dB. The Low-Pass Filters are selected from the front panel or HP-IB. The 3 dB frequencies of the filters are 30 kHz, 80 kHz, and 750 kHz. The latter filter is selected when the other two filters are off. The filters are active-types and have 6 dB gain.

Attenuator 2 is set to either 0 or 20 dB. Amplifier 3 has a gain of 20 dB. Attenuator 3 is set to either 0 or 20 dB. The Buffer amplifier has 0 dB gain. The High-Pass Filter is set to 0.3 Hz in the ac level measurement mode to ensure accuracy down to 20 Hz; otherwise, it is set to 13 Hz to speed up measurement time. Amplifier 4 has 20 dB gain. The output from Amplifier 4 is the rear-panel MONITOR output signal, an input to the Counter (since this is the point of greatest sensitivity in the ac level measurement mode), and the input to the Output RMS/Average/Quasi-peak Detector.

The Output RMS/Average/Quasi-peak Detector is used to set the gain of the output path (Attenuators 1, 2, and 3) and, after processing by the Controller, its output is also used as the numerator of the distortion measurement or the denominator of the SINAD measurement. The detector can also be configured to respond to the absolute average or quasi-peak value of the signal instead of the true RMS value. The Output Overload Detector senses the output of the Output RMS/Average/Quasi-peak Detector. If the output exceeds 3V, the gain of the output path is set to 0 dB. The state of the output can also be read by the Controller, which then takes appropriate action.

The SINAD panel meter is normally used only in the SINAD measurement mode when the SINAD is between 0 and 18 dB. On that range, since the gain of the output path is 0 dB, SINAD is equal to the log of the ratio of the output of the Pre-Notch RMS Detector to the output of the Output RMS/Average/Quasi-peak Detector. The mathematical manipulation takes place in the SINAD Log Ratio Meter Amplifier. The Meter Transconductance Amplifier converts the voltage at its input to a current to drive the SINAD meter. If SINAD is not in the range 0 to 18 dB or if some other measurement mode has been selected, the Controller either pegs the meter to full scale or switches it off via the Meter Peg/Off Switch.

DC Voltmeter

Various dc voltages are routed to the Voltmeter Input Selector switch. The outputs from the Pre-Notch RMS/Average Detector and the Output RMS/Average/Quasi-peak Detector are measured through Ripple Filters when measurements are made on noisy ranges. The DC Voltmeter consists of the Counter, the Controller, and the Voltage-to-Time Converter. The output of the Voltage-to-Time Converter controls one of the input gates of the Counter. The voltage-measurement cycle begins when the Controller gates the 2 MHz Clock into the Clock Counter. Counting proceeds until the Voltage-to-Time converter produces a Stop Count pulse which opens the Stop Count Gate. The time lapse between the gating of the clock and the opening of the Stop Count Gate is proportional to the dc input voltage. The count thus accumulated during the interval is proportional to the input voltage.

Source

The source consists of a 10 Hz to 100 kHz Oscillator and output level-setting circuits. Oscillator tuning is programmed by the Controller which uses the Counter to check frequency. The Oscillator output is self-leveled to about 3 V_{rms} via an automatic leveling control (ALC) circuit. The circuit senses the level with a peak Level Detector. The output from the detector is compared against a dc reference voltage by the Level Error amplifier. The output of the amplifier drives the level-varying circuitry in the Oscillator to eliminate the error condition.

The amplifiers and attenuators in the output path are:

- Amplifier 1, an active attenuator with a gain of 0 to -6 dB settable in 256 steps;
- Amplifier 2, an active attenuator with a gain of 0 to -17.5 dB settable in 2.5 dB steps;
- Attenuator A, a passive attenuator with 0, 20, and 40 dB attenuation;
- Output Amplifier Driver, a non-programmable buffer with a gain of 1.9 (+5.58 dB);
- Floating Output Amplifier with a gain of about +1 dB; and
- Attenuator B, a passive attenuator with 0 or 20 dB attenuation.

In the signal-to-noise ratio measurement mode, Amplifiers 1 and 2 and Attenuator A are switched between a normal and an "off" state. (The Controller reads the Output RMS/Average/Quasi-peak Detector for both states and computes the ratio.) In the "off" state the gain of Amplifier 1 is lowered by 6 dB, Amplifier 2 is set to -60 dB gain, and Attenuator A is shorted to ground. This "off" state also occurs when a source level of 0V is selected.

The Floating Output Amplifier generates a differential output signal, that is, a signal not referenced to ground. Either OUTPUT terminal (HIGH or LOW) may be grounded or floated up to 10 Vpk. This feature is useful for breaking up ground loops, summing signals, and adding dc offsets to the output. Attenuator B is also floating. For instruments with serial prefix 2730A and below, the output impedance is selected by a non-programmable, front panel IMPEDENCE switch for either 50Ω or 600Ω. For instruments with serial prefix 2742A and above, the output impedance can be selected from the front panel or via HP-IB by using Special Functions (47.X).

The Over-Voltage Protect circuit protects the output circuits from the inadvertent application of a reverse voltage to either the HIGH or LOW OUTPUT connector. The reverse voltage is sensed by an over-voltage detector, which opens two output relays. The relays automatically reset about 1s after the overvoltage is removed. The Voltage Clamp protects the output circuits during the time between the application of the reverse voltage and the opening of the relay contacts.

Counter

When the frequency of the input signal or Oscillator is to be counted, two sub-counters (the Cycle and Clock Counters) operate simultaneously. The signal itself is directed into the Cycle Counter. In the case of counting the input signal, the signal is first routed through the Counter Input Schmitt Trigger which converts the analog signal into square wave pulses which are compatible with the Cycle Counter. The 2 MHz Clock signal is directed into the Clock Counter.

To count frequency, the Controller first sets the Clock Counter Gate switch to route the path from the Frequency Gate switch into the Clock Counter. Then, the Controller arms the Cycle Counter Gate and Frequency Gate switches, and the first signal pulse closes the switches. Both counters (which were previously cleared) then begin to accumulate counts. The Cycle Counter is a divide by 32, the Clock Counter is a divide by 2048. The overflow or carry pulses of each counter are counted by the Controller. After a pre-determined minimum number of carries from the Clock Counter and at least one carry from the Cycle Counter, the Frequency Gate and Cycle Counter Gate switches are disabled by the Controller. The first signal pulse opens the switches and counting ceases. The Controller then reads the contents of the Cycle and Clock Counters and computes the signal frequency which is

$$f = \frac{[\text{Count of Cycle Counter} + (32 \times \text{Cycle Counter Carries})] \times 2 \text{ MHz}}{(2048 \times \text{Clock Counter Carries}) + \text{Count of Clock Counter}}$$

The count sequence is also timed out to prevent hang-up of the instrument should there be no input signal or should the signal be interrupted during a count cycle.

During a voltage measurement cycle, only the Clock Counter is used. The Controller first sets the Clock Counter Gate to receive the signal from the Voltmeter Gate and closes the Voltmeter Gate. (The Controller had also previously closed the Stop Count Gate by deactivating the Voltage-to-Time Converter via the Ramp Gate line.) The 2 MHz Clock is now routed into the Clock Counter. After a time interval which is proportional to the dc voltage being measured, the Voltage-to-Time Converter opens the Stop Count Gate. The accumulated count is proportional to the dc voltage at the input of the DC Voltmeter.

Controller and Remote Interface

The Controller plays a key role in governing the instrument operation. The Microprocessor in the Controller outputs information to configure the instrument, reads back vital status information to prevent invalid measurements, and services interrupts from the Keyboard or Remote Interface. Information from the Input/Output (I/O) port of the Microprocessor is carried to the rest of the instrument by the Instrument Bus. Typically, the data on the Instrument Bus are decoded by the Decoders and Latches and distributed to the appropriate circuit. For the Counter, Keyboard and Display, and Remote Interface, decoding of the Instrument Bus is done on the assemblies.

Information within the Controller itself is handled by three main buses: the ROM Control Bus (which coordinates the various devices which make up the Controller), the Address Bus (which addresses the ROM and RAM), and the Data Bus (which carries information to or from the ROM and RAM). Since the Remote Interface contains some Controller devices, these buses are also distributed to it.

The Remote Interface receives inputs from the external interface bus (HP-IB), processes the information, and interrupts the Controller in a manner similar to the Keyboard. It also processes the measurement information and outputs it on the HP-IB if requested. The Remote Interface is designed to make operation from an external computing controller as similar as possible to operation from the front panel.

Instrument Software Supervisor Flowchart

The instrument's software is structured in a form called the supervisor. See Figure 8A-1. The supervisor is a loop that is continually traversed with displays made near the end after checks for oscillator tuning, input and output leveling, notch tuning, and measurements. Arithmetic manipulation (for example, for the ratio function) follows the measurement, and the programs loop back to the beginning after outputting to the display.

The various level and tune blocks verify that the instrument is adjusted to make an accurate measurement. A measurement is not made until all of the tests are passed in succession. If a test is not passed, corrective action is taken. The decision after that block then forces the program back to the top of the supervisor, bypassing the measurement for that loop if corrective action is unsuccessful. The software interface with the hardware makes use of two concepts called software state and hardware state. The software state is located in the RAM and totally describes the state of the instrument. On power-up, the initialization procedure loads the software state from ROM. Keyboard and HP-IB entry routines modify only the software state and do not effect the hardware immediately. The setup block in the supervisor is where the hardware state is made to conform with the software state. Setup is not the only place where hardware is affected; tune, level, and measurement blocks manipulate the hardware as well.

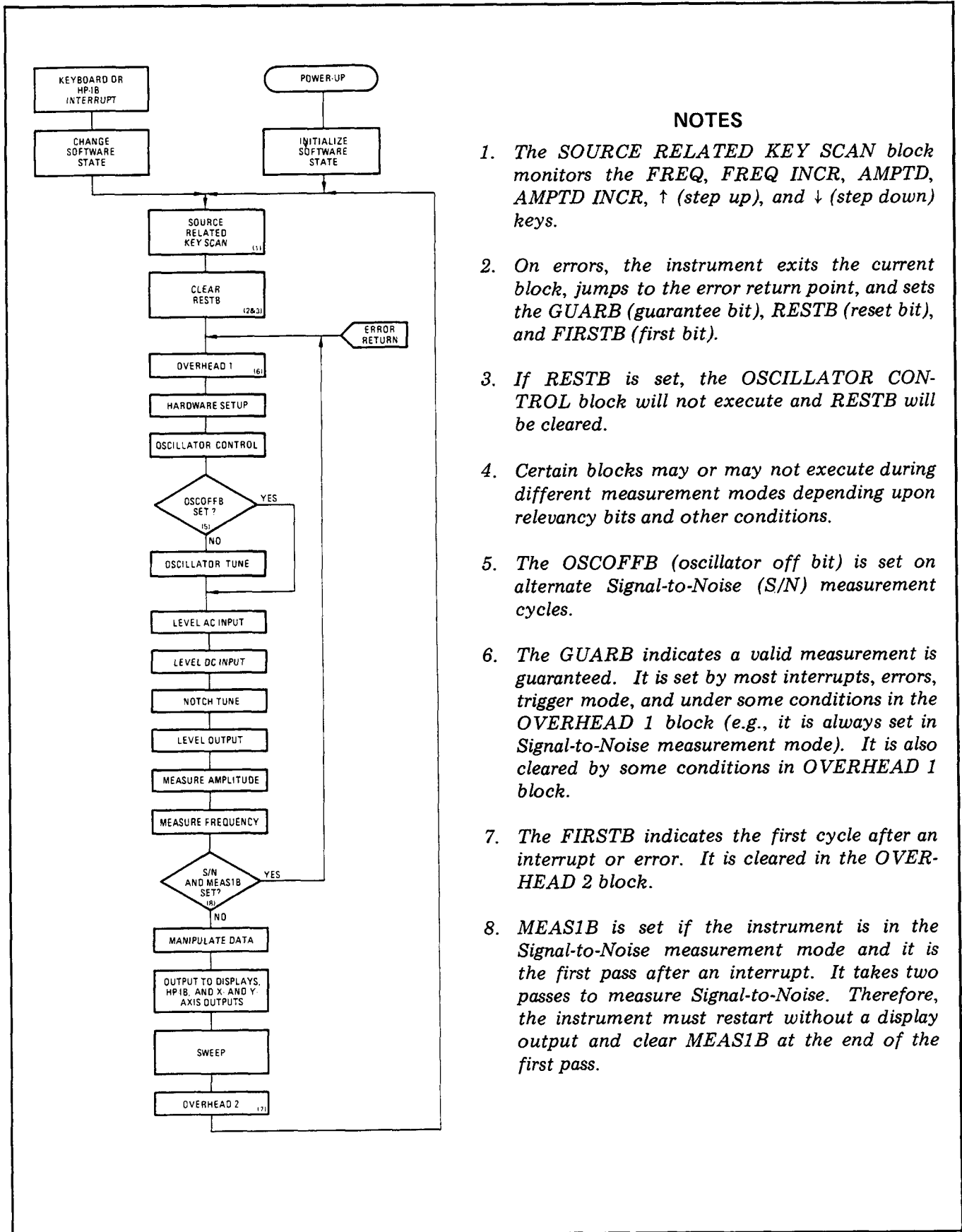
The Keyboard and HP-IB interrupt the flow around the loop, forcing the Microprocessor to execute a short program and then return to the loop as shown in the diagram. Since the supervisor can be interrupted at any point but always returns to a single location, Keyboard and HP-IB interrupts must abort the current measurement and start a new measurement cycle. The Keyboard and HP-IB can be thought of as a medium through which the user requests a certain setup.

The microprocessor-based Controller interacts closely with the hardware of the instrument. Many circuits are used by the Controller for different functions at different times. Thus, a specific failure in one circuit can show up as a collection of symptoms that superficially seem unrelated. The appearance of several symptoms can often be used to advantage as they provide many avenues to pursue when tracking down a problem.

A clear line is drawn between Service Special Functions and normal instrument operation. When most Service Special Functions are used, normal instrument functions are suspended. When the Service Special Function mode is left to resume normal measurements, all effects of the Service Special Function on hardware are lost. As an example, a Service Special Function can be used to display the oscillator frequency. But once normal measurements are resumed, the display will revert back to what it was before the Service Special Function was invoked.

Power Supplies

The instrument is run from four regulated supplies: +15V, -15V, +12V, and +5V. All supplies are independent except the +5V supply which is dependent on the +15V and -15V supplies.



NOTES

1. The SOURCE RELATED KEY SCAN block monitors the *FREQ*, *FREQ INCR*, *AMPTD*, *AMPTD INCR*, ↑ (*step up*), and ↓ (*step down*) keys.
2. On errors, the instrument exits the current block, jumps to the error return point, and sets the *GUARB* (guarantee bit), *RESTB* (reset bit), and *FIRSTB* (first bit).
3. If *RESTB* is set, the *OSCILLATOR CONTROL* block will not execute and *RESTB* will be cleared.
4. Certain blocks may or may not execute during different measurement modes depending upon relevancy bits and other conditions.
5. The *OSCOFFB* (oscillator off bit) is set on alternate *Signal-to-Noise (S/N)* measurement cycles.
6. The *GUARB* indicates a valid measurement is guaranteed. It is set by most interrupts, errors, trigger mode, and under some conditions in the *OVERHEAD 1* block (e.g., it is always set in *Signal-to-Noise* measurement mode). It is also cleared by some conditions in *OVERHEAD 1* block.
7. The *FIRSTB* indicates the first cycle after an interrupt or error. It is cleared in the *OVERHEAD 2* block.
8. *MEAS1B* is set if the instrument is in the *Signal-to-Noise* measurement mode and it is the first pass after an interrupt. It takes two passes to measure *Signal-to-Noise*. Therefore, the instrument must restart without a display output and clear *MEAS1B* at the end of the first pass.

Figure 8A-1. Supervisor Flowchart

TROUBLESHOOTING

General

The troubleshooting checks that follow are a starting place for locating an instrument fault. They are easy to perform and give much key information in a short time. In most instances they can differentiate between an instrument hardware failure and a Controller or software problem. The comments associated with each procedure summarize the information known as a result of passing or failing the check. The checks should be done in order. For additional information on the troubleshooting philosophy used in these checks, refer to *General Troubleshooting*, paragraph 8-16.

√1 Line Check

Procedure: Remove the instrument top cover (three screws) and switch LINE to ON.

Normal Indication: The four green LEDs on the A13 Power Supply and Motherboard Assembly are lighted indicating that the supplies are nominally operating.

If Indication Abnormal: Check rear panel line fuse and line voltage selector. Check Mains wiring. See Service Sheet 20. Check individual regulators. See Service Sheet BD5.

√2 Power-Up Checks

Procedure: If there are any jumpers on the TEST test points on the A8 Controller/Counter Assembly, remove them. Switch LINE to OFF for five seconds then back to ON. Note the sequencing of the four TEST LEDs on the top of the Controller/Counter Assembly as the instrument powers up.

Normal Indication: The four TEST LEDs light in the following sequence:

1. Indeterminate for about 1/8 second.
2. () () () (1) for about second. This indicates the start of the power up routines and the run of the Read Only Memory Check.
3. (8)(4)(2)(1) for about 2 seconds. This indicates that all power-up checks passed and that a visual front-panel check is in progress (see √3).
4. (8)(4)(2)(1), with (1) blinking indefinitely until a key is pressed. The behavior of the LED (1) is also affected by the presence of an input signal.

Any other sequence indicates a failure of the check. Passing this check indicates that the Controller is functioning properly and that there is no catastrophic failure in the following circuits:

Read Only Memory,
Random Access Memory,
Instrument Bus, and
Keyboard (only that no key is down).

If Indication Abnormal: If the TEST LEDs come on and remain in the indeterminate state of step 1, check the Controller Kernel. See Service Sheet BD4. If other indications appear in or after step 2, consult *Power-Up Checks*, paragraph 8-27, which discusses the individual checks, documents the error indications, and cross references to the service sheets.

√3 Front-Panel LED Check

Procedure: Disconnect all connections to the INPUT. Switch LINE to OFF and back to ON.

Normal Indications: After less than 1/8 second, all front-panel LEDs, display segments and decimal points should light for about three seconds, then the displays blank for one second then after a few seconds settle to readings of 0.000 kHz in the left display and <0.100 mV in the right display. The measurement cycle indicator LED in the upper left-hand corner of the right display should blink rapidly. The kHz and mV annunciators and the AC LEVEL and 80 kHz LOW PASS key lights should be on. This indicates that the Controller is able to output to the front-panel LED and display latches which are all operative.

If Indication Abnormal: If one or more LEDs or display segments fail, check the respective components and drive circuits. See Service Sheet 18. Also check the CPU I/O port. See Service Sheet BD4.

√4 Measurement Error Check

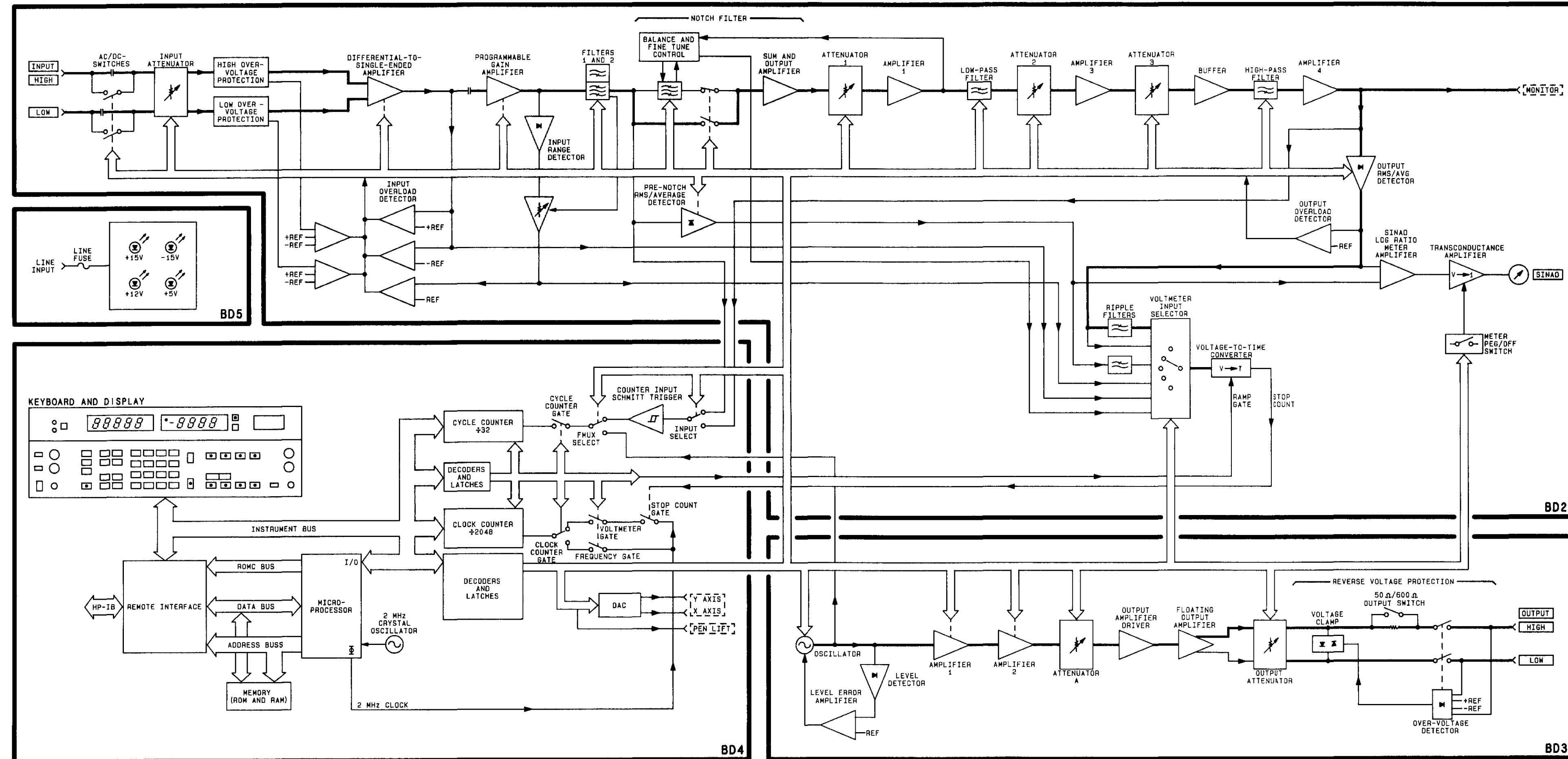
Procedure: Key in 43.1 SPCL. This enables Service Errors. Make the measurement in which the fault appears.

Normal Indications: As the Special Function code is entered, 43.1 should appear in the left display. This indicates that the Controller responds to keyboard interrupts. After pressing the SPCL key, measurements should proceed as normal.

If Indication Abnormal: If the keys have no effect, check the keyboard interrupt. See Service Sheet 17. If the keystrokes produce an erroneous display, check the Keyboard. See Service Sheet BD4. If the measurement is improper or error messages appear in the display, consult the error messages tables (see *Error Messages* in the *Detailed Operating Instructions*, Section 3 and *Error Messages*, paragraph 8-24) or consult the block diagram service sheet that documents the section of the instrument that appears to have the fault (see Service Sheets BD2 through BD5).

NOTE

For problems that are exclusive to the HP-IB, see Service Sheet BD4.



BD1
Figure 8A-101
8A-101

SERVICE SHEET BD2—Measurement Circuits Block Diagram

PRINCIPLES OF OPERATION

General

Service Sheet BD2 covers the input circuits, notch filter, output circuits, and part of the voltmeter; that is, it covers most of the measurement (analyzer) circuits of the instrument.

Input Amplifier (A2)

The Input Amplifier circuits amplify or attenuate the input signal so that its output is within 1.9 to 3V at the input to the Notch Filter. The overall input gain can be controlled by Special Function 1 for ac measurements and Special Function 2 for dc. Other circuits provide ac or dc coupling, over-voltage protection, differential-to-single-ended conversion, filtering, and level sensing.

The HIGH and LOW INPUT connectors are the differential inputs. A front-panel switch permits convenient grounding of the LOW INPUT. For ac measurements, the AC/DC Switch is set to ac couple the input.

Two pairs of voltage dividers form a balanced Input Attenuator. The first divider pair is 12 dB; the second divider pair have taps at 24 and 40 dB. The input level range and the associated attenuation are summarized in Table 8B-1 for dc measurements and Table 8B-2 for ac measurements.

Table 8B-1. Input Attenuation for DC Measurements

DC Input Level Range		Input Attenuation (dB)
Range (Vdc)	Special Function	
4	2.4	0
16	2.3	12
64	2.2	24
300	2.1	40

The Over-Voltage Protection circuit clamps the high and low inputs of the Differential-to-Single-Ended amplifier when the signal level exceeds $\pm 13V$. The diodes of the protection circuit are in parallel with the signal path and are normally biased off. The amplifiers ac couple signal to the clamp diodes to prevent the signal from modulating the diode capacitance and creating distortion. The output of the amplifier is also fed to the Input Overload Protection.

The signals on the high and low paths are each amplified by programmable-gain amplifiers. The outputs from the two amplifiers are subtracted to create a single-ended signal (that is, one that is referenced with respect to ground). The gain of the Differential-to-Single-Ended Amplifier is 0, 8, 16, or 20 dB. The gain is 0 dB when measuring dc. The gain for ac is summarized in Table 8B-2.

DC measurements are made at the output of the Differential-to-Single-Ended Amplifier by the DC Voltmeter.

The Programmable Gain Amplifier has a gain of 0, 4, 8, or 12 dB. The gain is summarized in Table 8B-2. The amplifier input is ac coupled.

The rms level at the output of the Programmable Gain Amplifier is converted to dc by the Input Range Detector. The output is measured by the DC Voltmeter and sets the input gain. The gain of the detector is programmed to match the peak gain of the Weighting Bandpass Filters that follow the Programmable Gain Amplifier.

The output of the Input Range Detector and the dc at the input of the Programmable Gain Amplifier are compared to positive and negative references by the Input Overload Detector. This is to determine if the signal levels are too large for the input gain settings.

The output of the Programmable Gain Amplifier can be filtered with optional audio filters: either a 400 Hz High-Pass Filter or one or two of several Weighting Bandpass Filters. All are active filters. The 400 Hz High-Pass Filter is a 7-pole filter. The Weighting Bandpass Filters are designed to match certain international standards. The filters plug onto the A2 assembly.

Table 8B-2. Gain Summary for AC Measurements

Range (Vrms)	Special Function	Gain (dB)		
		Input Attenuator	Differential-to-Single-Ended Amplifier	Programmable Gain Amplifier
300	1.1	-40	0	0
189	1.2	-40	0	4
119	1.3	-40	0	8
75.4	1.4	-40	0	12
47.6	1.5	-24	0	0
30.0	1.6	-24	0	4
18.9	1.7	-24	0	8
11.9	1.8	-12	0	0
7.45	1.9	-12	0	4
4.76	1.10	-12	0	8
3.00	1.11	0	0	0
1.89	1.12	0	0	4
1.19	1.13	0	0	8
0.745	1.14	0	0	12
0.476	1.15	0	8	8
0.300	1.16	0	8	12
0.189	1.17	0	16	8
0.119	1.18	0	16	12
0.0745	1.19	0	20	12

Notch Filter (A3)

The input to the Notch Filter is measured by the Pre-Notch RMS/Average Detector. The measured level is used as the denominator in the distortion calculation and the numerator in the SINAD calculation. Its output also is fed to the analog SINAD meter circuitry. The Pre-Notch RMS/Average Detector can be switched to respond to the true rms or the absolute average value of the input voltage by Special Function 5.

The Notch Filter is a state-variable filter, that is, a filter which is formed by combining various circuit blocks which perform simple mathematical functions (amplification, inversion, summation, and integration). A simplified diagram of the basic filter is shown in Figure 8B-1. The transfer functions at various points in the diagram are also given. Band-reject, bandpass, high-pass, and low-pass responses are all generated by the circuit. The output of the circuit diagram is V_2 (the notch filter output).

In actual use, the circuit is configured to obtain three types of responses: band-reject or notch (in the SINAD, distortion, and distortion level measurement modes), bandpass (in Special Function 44.3), and flat (in the other ac measurement modes). Referring now to Block Diagram 2, the transfer function has a notch filter response when both switches at the input to the Sum and Output Amplifier are closed. The transfer function has a bandpass response when the path from the input to the Sum and Output Amplifier is open. The transfer function has a flat response when the path from Integrator 1 to the Sum and Output Amplifier is broken.

In the notch-filter configuration, the notch frequency is coarse tuned by adjusting ω_0 in the simplified diagram (R_s and C_s in Integrators 1 and 2). This is done by the Controller. Coarse tuning accuracy is about 8%. Special Functions 53 and 54 can be used to manually set the tuning of the Notch Filter. The damping factor α is fixed and is approximately equal to 0.15. (Thus the low- and high-pass filters are underdamped.) To improve the depth of the notch, the phase and level of the output of the Notch Filter are sensed. The phase and level error voltages then correct the tuning and balance by controlling the amount of signal of the appropriate magnitude and phase injected into Sum Amplifier 2. (The amplifier is not depicted in Figure 8B-1. It is a summing amplifier inserted before Integrator 2.) Operation of the fine-tune and balance circuit is independent of the Controller.

Figure 8B-2 shows the essential parts of the phase and level sensing circuits and the associated waveforms. The input to the circuit (V_{NOTCH}) comes from the output of the Notch Filter after being amplified by the combination

of Attenuator 1 and Amplifier 1 of the Output Amplifier/Voltmeter Assembly (A4) and the Notch Amplifier. The total gain is either 5.5 or 55 depending on the setting of Attenuator 1. The input (V_{NOTCH}) can be considered as having components in phase with the input to the Notch Filter and in quadrature (that is, 90° out-of-phase) with it. The waveform for V_{NOTCH} in Figure 8B-2 is shown as being totally in phase with the input.

The in-phase component represents a balance error in the Notch Filter, that is, the notch does not completely null out the signal. The quadrature component represents a tuning error. When perfectly tuned, any output from an imperfectly balanced Notch Filter will be in phase with the input.

To sense the in-phase component, a current, produced by the input signal (V_{NOTCH}), is chopped in phase with the input to the Notch Filter. Chopper S_i is driven by the bandpass output of the Notch Filter which is in phase with the fundamental component of the input to the Notch Filter. If V_{NOTCH} is in phase with S_i (as in this example), the chopped current (I_{1i}) will be a half-wave-rectified signal. Current I_2 is proportional to the input voltage but half the level of the chopped current. I_{1i} and I_2 are summed together to produce a current (I_{3i}) whose average (dc) level represents the level error of the in-phase component of the signal. For this example, the result is a full-wave-rectified signal (I_{3i}). I_{3i} is integrated (that is, amplified and filtered). The integrated current controls the gain of the Balance Multiplier which balances the Notch Filter.

Sensing the quadrature component is similar. A current, produced by the input signal (V_{NOTCH}), is chopped in quadrature with the input to the Notch Filter. Chopper S_q is driven by the low-pass output of the Notch Filter which is 90° out of phase with the fundamental of the input to the Notch Filter. If V_{NOTCH} is in quadrature with S_q (as in this example), the chopped current (I_{1q}) will consist only of the half cycles going from the positive to the negative peak. (The dc component of this signal is zero.) Current I_2 is as before. I_{1q} and I_2 are summed together to produce a current (I_{3q}) whose average (dc) level represents the level error of the quadrature component of the signal. For this example, the result has a dc value of zero. I_{3q} is integrated and controls the gain of the Tune Multiplier which tunes the Notch Filter.

More commonly, V_{NOTCH} will have both quadrature and in-phase components. The tune and balance detectors isolate the respective components and drive the respective multiplier with the error signal. The resistors through which I_{1i} , I_{1q} , and I_2 flow can be switched to change the magnitude of the current by a factor of ten. This compensates for the gain change in Attenuator 1 of assembly A4.

In summary, the Tune and Balance Multipliers can be visualized as variable-gain amplifiers with ac inputs from the bandpass and high-pass outputs of the Notch Filter respectively. (The bandpass output is in phase with the fundamental of the input to the Notch Filter; the high-pass output is in quadrature.) The dc inputs (from the Tune and Balance Integrators) control the gain of the multipliers, including the sense of the gain (that is, inverting or non-inverting). The output currents of the multipliers are summed together (their outputs are in parallel) and the composite signal is summed with the output from Integrator 1 in Sum Amplifier 2 to create a feedback loop that fine adjusts the tuning and balance of the Notch Filter.

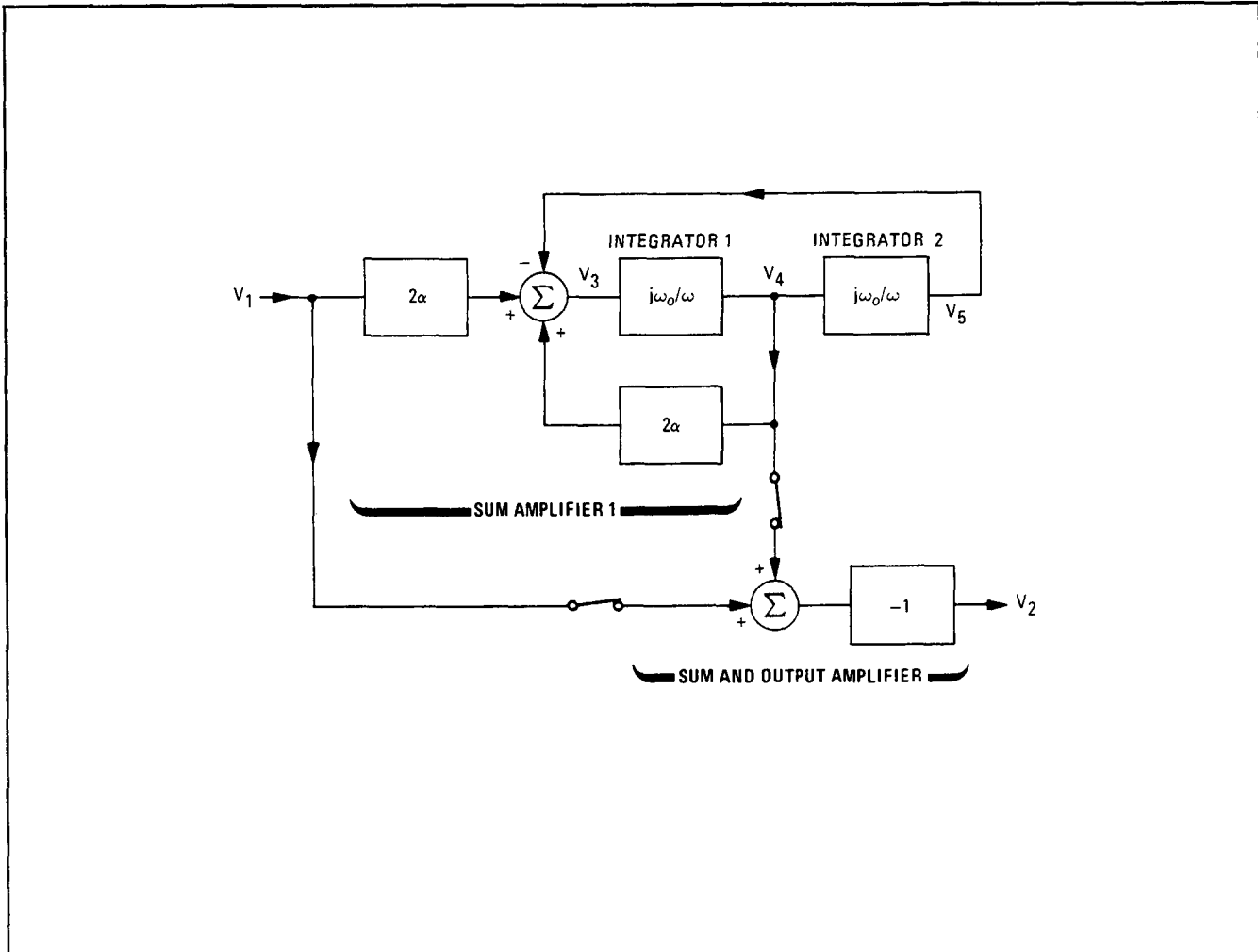
Output Amplifier/Voltmeter (A4)

The signal from the Notch Filter is further processed before being detected by the voltmeter or sent to the rear-panel MONITOR output. The signal is amplified by Amplifier 1 (gain=5), the Low-Pass Filters (gain=2), Amplifier 3 (gain=10), and Amplifier 4 (gain=10). The maximum gain is thus 1000 (or 60 dB). Attenuators 1, 2, and 3 each have a selectable attenuation of 0 or 20 dB. The overall gain is set by the Controller so that the level sensed by the Output RMS/Average/Quasi-peak Detector is 3V or less. Switching of the attenuators can be controlled by Special Function 3 and is summarized in Table 8B-3.

Selection of the active low-pass filters is from the front panel or HP-IB. When no filtering is selected, the 750 kHz filter is active. The other two filters are 80 and 30 kHz.

The Buffer amplifier has 0 dB gain. The High-Pass Filters following the Buffer are either 0.3 Hz in ac level or 13 Hz in the other measurement modes. The 13 Hz filter is an active filter. Amplifier 4 drives the MONITOR output, the Output RMS/Average/Quasi-peak Detector, and the Counter Input Schmitt Trigger (see Service Sheet BD4).

The Output RMS/Average/Quasi-peak Detector converts its input into a dc voltage corresponding to the rms level of the signal. The detector can also be configured to produce the absolute-average or quasi-peak value of the signal using Special Function 5. The output is measured by the DC Voltmeter for computing measurement



Transfer Function	Type of Response	Transfer Function at		
		$\omega = 0$	$\omega = \omega_0$	$\omega = \infty$
$\frac{V_2}{V_1} = - \frac{\omega^2 - \omega_0^2}{\omega^2 - j2\alpha\omega_0\omega - \omega_0^2}$	Notch Filter	-1	0	-1
$\frac{V_3}{V_1} = \frac{2\alpha\omega^2}{\omega^2 - j2\alpha\omega_0\omega - \omega_0^2}$	High-Pass Filter	0	j	2α
$\frac{V_4}{V_1} = \frac{j2\alpha\omega_0\omega}{\omega^2 - j2\alpha\omega_0\omega - \omega_0^2}$	Bandpass Filter	0	-1	0
$\frac{V_5}{V_1} = - \frac{2\alpha\omega_0^2}{\omega^2 - j2\alpha\omega_0\omega - \omega_0^2}$	Low-Pass Filter	2α	-j	0

Figure 8B-1. Simplified Diagram of the Notch Filter with Transfer Functions Given for Various Points

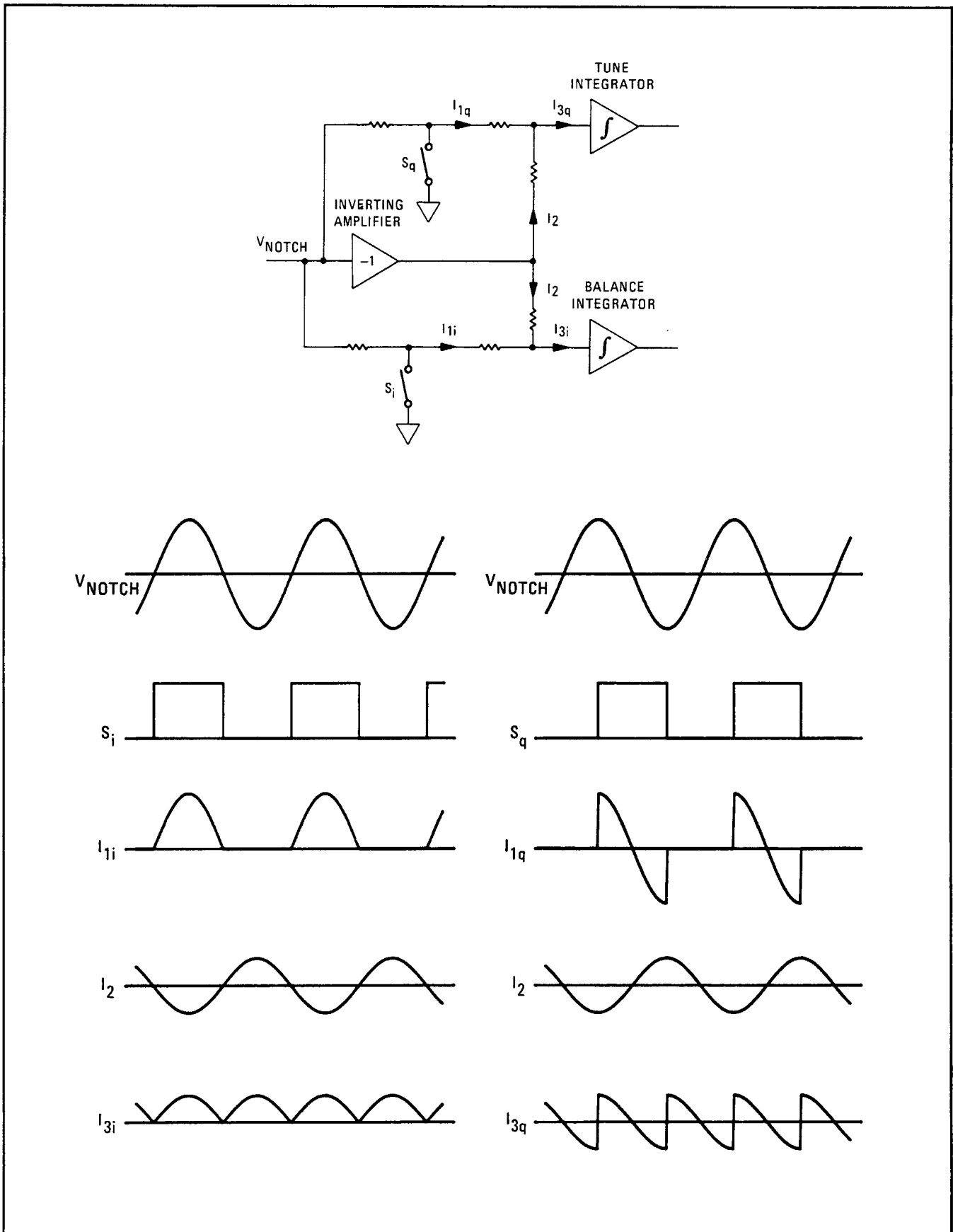


Figure 8B-2. Notch Filter Tune and Balance Detectors

Table 8B-3. Summary of Attenuator Switching

Post-Notch Amplifier		Attenuation (dB)		
Gain (dB)	Special Function	Attenuator 1	Attenuator 2	Attenuator 3
0	3.1	20	20	20
20	3.2	20	20	0
40	3.3	0	0	20
60	3.4	0	0	0

results and setting the gain of the Output Amplifier. In the rms configuration the circuit is an analog computer consisting of a full-wave rectifier, log amplifier, and antilog amplifier and filter.

The Output Overload Detector compares the output of the Output RMS/Average/Quasi-peak Detector with a reference and sets the Output Amplifier gain to 0 dB if an overload is sensed (unless defeated by Special Function 3).

The SINAD Log Ratio Meter Amplifier produces an output voltage which is the log of the ratio of the outputs of the Pre-Notch and Output RMS/Average/Quasi-peak Detectors. The amplifier drives a Meter Transconductance Amplifier which converts the log-ratio voltage to a current which drives the front-panel SINAD meter.

The state of the Meter Peg/Off Switch is set by the Controller. If the SINAD reading exceeds 18 dB (or 24 dB when Special Function 7.1 is invoked), the switch is set to peg (force off scale) the meter. If the SINAD measurement mode has not been selected, the meter is switched off. Special Function 45.1 enables the meter for all ac measurement modes.

The Voltmeter Input Selector selects one of the dc inputs into the Voltage-to-Time Converter. The Ripple Filters on lines from the Input to Output RMS Detectors add low-pass filtering to reduce display fluctuation on noisy measurements. The output from the Output RMS/Average/Quasi-peak Detector is also heavily filtered by the SINAD Filter in the SINAD measurement mode.

The output of the selector is the reference input for a Comparator. The Comparator's other input is a constant slope ramp. The ramp is initiated by the Controller. As the ramp rises, the Counter counts the time-base reference (2 MHz). When the ramp voltage equals the level of the reference input, the Comparator signals the Counter to stop counting. The accumulated count is proportional to the dc voltage. Ground is measured before each reading and subtracted from the DC Voltmeter measurement to eliminate the effect of offsets. The ramp begins at approximately -6V, which permits measurement of negative voltages.

TROUBLESHOOTING

General

Procedures for checking the measurement circuits of the instrument are given below. The blocks or points to check are marked on the block diagram by a hexagon with a check mark and a number inside, for example $\sqrt{3}$. The procedures assume that the source is working properly. A second audio source is needed only if distortion is out of specification and it cannot be determined whether the instrument's source or distortion measurement is at fault. Before performing any check, perform all the checks on Service Sheet BD1.

Equipment

Audio Analyzer..... HP 8903B or HP 339A
 Oscilloscope..... HP 1740A

$\sqrt{1}$ Input Amplifier Check

NOTE

This check does not test the Over-Voltage Protection. If the Over-Voltage Protection is suspected to be faulty, see Service Sheet 1.

1. On the Audio Analyzer, key in 41.0 SPCL to initialize the instrument. Set the INPUT and OUTPUT switches to ground. Set IMPEDANCE to 600 Ω . Key in AMPTD 3 V. Connect the HIGH OUTPUT to the HIGH INPUT through a tee adapter.
2. Connect a high-impedance, ac coupled oscilloscope to the tee at the HIGH INPUT. Use the oscilloscope's vertical gain controls to adjust the display amplitude for 5 divisions peak-to-peak deflection of the sinusoidal signal. (The period of the signal should be 1 ms.)
3. Connect the oscilloscope to A2TP5 (SING END). Key in the Special Functions listed in Table 8B-4. For each setting, increase the oscilloscope's vertical gain by the amount indicated. The peak-to-peak amplitude, displayed on the oscilloscope, should be within the limits indicated. If faulty, see Service Sheet 1 and check the High Input Attenuator.

Table 8B-4. Amplitude Limits at A2TP5, $\sqrt{1}$ Step 3

Special Function	Total Change in Oscilloscope Vertical Gain	Amplitude Limits (divisions pk-pk)	
		Minimum	Maximum
1.11	$\times 1$	4.9	5.1
1.8	$\times 1$	1.2	1.3
1.5	$\times 10$	3.0	3.3
1.1	$\times 100$	4.8	5.2

4. Set the INPUT switch to FLOAT. Connect the HIGH OUTPUT to the LOW INPUT. Short the HIGH INPUT to ground.
5. Key in the Special Functions listed in Table 8B-5. For each setting, decrease the oscilloscope's vertical gain by the amount indicated. The peak-to-peak amplitude, displayed on the oscilloscope, should be within the limits indicated. If faulty, see Service Sheet 1 and check the Low Input Attenuator.
6. On the Audio Analyzer, key in AMPTD .1 V. Readjust the oscilloscope's vertical gain for a display of 5 divisions peak-to-peak.
7. Reduce the oscilloscope's gain by a factor of 10. Key in the Special Functions listed in Table 8B-6. The peak-to-peak amplitude displayed on the oscilloscope should be within the limits indicated. If faulty, see Service Sheet 1 and check the Differential-to-Single-Ended Amplifier.

Table 8B-5. Amplitude Limits at A2TP5, $\sqrt{1}$ Step 5

Special Function	Total Change in Oscilloscope Vertical Gain	Amplitude Limits (divisions pk-pk)	
		Minimum	Maximum
1.1	$\times 1$	4.8	5.2
1.5	$\div 10$	3.0	3.3
1.8	$\div 100$	1.2	1.3
1.11	$\div 100$	4.9	5.1

Table 8B-6. Amplitude Limits at A2TP5, $\sqrt{1}$ Step 7

Special Function	Amplitude Limits (divisions pk-pk)	
	Minimum	Maximum
1.15	1.2	1.3
1.17	3.0	3.3
1.19	4.8	5.2

8. On the Audio Analyzer, key in 1.11 SPCL. On the oscilloscope, set the gain back to $\times 1$. (Check that the waveform is still 5 divisions peak-to-peak.)

9. Connect the oscilloscope to A2TP4 (PGM AMP). On the Audio Analyzer, key in the Special Functions listed in Table 8B-7. For each setting, decrease the oscilloscope's gain by the amount indicated. The peak-to-peak amplitude, displayed on the oscilloscope, should be within the limits indicated. If faulty, see Service Sheet 2 and check the Programmable Gain Amplifier.

Table 8B-7. Amplitude Limits at A2TP4, $\sqrt{1}$ Step 9

Special Function	Total Change in Oscilloscope Vertical Gain	Amplitude Limits (divisions pk-pk)	
		Minimum	Maximum
1.11	$\times 1$	4.8	5.2
1.12	$\times 1$	7.7	8.2
1.13	$\div 10$	1.2	1.3
1.14	$\div 10$	1.9	2.1

10. On the Audio Analyzer, key in 1.11 SPCL. On the oscilloscope, set the gain back to $\times 1$. (Check that the waveform is still 5 divisions peak-to-peak.)

11. Connect the oscilloscope to A2TP3 (OUT). The oscilloscope display should be between 4.9 and 5.1 divisions peak-to-peak. If faulty, see Service Sheet 2 and check the Weighting Bandpass and High-Pass Filters.

12. On the Audio Analyzer, key in AMP TD 300 mV. Decrease the vertical gain of the oscilloscope for a display of 5 divisions peak-to-peak.

13. On the Audio Analyzer, key in the frequencies and the weighting bandpass or high-pass filter indicated in Table 8B-8 for the filters installed in the instrument. (If no filter options are installed, go on to the next step.) For each setting, the peak-to-peak amplitude, displayed on the oscilloscope, should be within the limits indicated. If faulty, see Service Sheets 2, 2A, and 2B, and check the Weighting Bandpass and High-Pass Filters.

Table 8B-8. Amplitude Limits at A2TP3, $\sqrt{1}$ Step 13

Weighting Bandpass or High-Pass Filter	Source Frequency (Hz)	Amplitude Limits (divisions pk-pk)	
		Minimum	Maximum
400 Hz HIGH-PASS	1 000	4.9	5.1
	400	2.5	4.5
CCITT WEIGHTING	800	4.8	5.2
	300	1.2	1.8
	3 000	2.2	3.1
CCIR WEIGHTING	6 300	2.0*	2.1*
	200	0.9	1.1
	10 000	1.2*	1.4*
C-MESSAGE WEIGHTING	1 000	4.9	5.1
	500	1.8	2.5
	3 000	3.1	4.5
CCIR/ARM WEIGHTING	6 300	1.0*	1.1*
	200	0.5	0.6
	10 000	6.2	7.1
"A" WEIGHTING	1 000	4.9	5.1
	200	1.3	1.5
	10 000	3.4	4.1

*Reduce the oscilloscope's vertical gain by 10.

14. On the Audio Analyzer, set the Weighting Bandpass or High-Pass Filter off if one is on. Key in **FREQ** 1 kHz and **AMPTD** 1 V. Connect the oscilloscope to A2TP4 (PGM AMP). Adjust the oscilloscope's vertical gain for 7.1 divisions peak-to-peak amplitude.

15. DC couple the oscilloscope and connect it to A2TP2 (RMS). The waveform should be a dc voltage between 2.4 and 2.6 divisions (with respect to ground). If faulty, see Service Sheet 2 and check the Input Range Detector.

16. If the Audio Analyzer has the CCIR Weighting, CCIR/ARM Weighting, or "A" Weighting Filter, key in the filter. The dc voltage should be within the limits given in Table 8B-9. If faulty, see Service Sheet 2 and check the Input Range Detector and the respective Weighting Bandpass Filter.

Table 8B-9. Amplitude Limits at A2TP2, $\sqrt{1}$ Step 16

Weighting Filter	Amplitude Limits (divisions)	
	Minimum	Maximum
CCIIR WEIGHTING	0.9*	1.1*
CCIR/ARM WEIGHTING	5.1	5.4
"A" WEIGHTING	3.0	3.2

* Reduce the oscilloscope's vertical gain by 10.

17. Set the oscilloscope for 2 V/division. On the Audio Analyzer, set the Weighting Bandpass or High-Pass Filter off. Key in 1.12 SPCL. Key in **AMPTD** 5.1 V. The voltage, displayed on the oscilloscope, should be approximately

8.1 Vdc. (Ignore the display.) If faulty, see Service Sheet 2 and check the Input Range Detector and Input Overload Detector.

18. On the Audio Analyzer, key in AMPTD 5.5 V. The voltage should drop to approximately 0 Vdc. The display should show Error 30. If faulty, see Service Sheet 2 and check the Input Range Detector and Input Overload Detector.

19. On the Audio Analyzer, press AUTOMATIC OPERATION. Press S (Shift) DC LEVEL. Key in 2.3 SPCL to set the dc level range to 16V. Connect the oscilloscope to A2TP5 (SING END).

20. Connect A8TP16 (+5V) to the LOW INPUT. The oscilloscope should show a dc voltage approximately 1.25 Vdc. If faulty, see Service Sheet 1 and check the AC/DC Switch.

21. Press AC LEVEL. The oscilloscope should show a dc voltage of approximately 0 Vdc. If faulty, see Service Sheet 1 and check the AC/DC Switch.

22. Remove the short from the HIGH INPUT. Remove the connection from the LOW INPUT and connect it to the HIGH INPUT. Set the INPUT switch to ground. The oscilloscope should remain as in step 21. If faulty, see Service Sheet 1 and check the AC/DC Switch.

23. Press S DC LEVEL. Key in 2.3 SPCL again. The oscilloscope should show a dc voltage approximately -1.25 Vdc. If faulty, see Service Sheet 1 and check the AC/DC Switch.

√2 Notch Filter Check

1. On the Audio Analyzer, key in 41.0 SPCL to initialize the instrument. Set the INPUT and OUTPUT switches to ground. Set the 80 kHz LOW PASS filter off. Key in AMPTD 3 V and FREQ 98.7 Hz. Key in 1.11 SPCL to set the input to 3V range. Key in 53.0 SPCL to set the Notch Filter to its lowest frequency range. Key in 54.115 SPCL to set the Notch Filter Coarse Tune near the middle of its range (approximately 98.7 Hz). Connect the HIGH OUTPUT to the HIGH INPUT.

2. Connect a high-impedance, ac coupled oscilloscope to A2TP3 (OUT). The waveform on the oscilloscope should be a sine wave with a amplitude between 8 and 9 Vpp and a period of approximately 10 ms. If faulty, see **√1** *Input Amplifier Check*.

3. Use the oscilloscope's vertical gain controls to adjust the display amplitude for 5 divisions peak-to-peak deflection of the signal.

4. On the Audio Analyzer, connect A3TP3 (TUNE) and A3TP4 (BAL) to A3TP1 (GND) to defeat the fine tune and balance control. Connect the oscilloscope to A3TP5 (BP OUT). The peak-to-peak amplitude, displayed on the oscilloscope, should be between 4.7 and 5.3 divisions. If faulty, see Service Sheet 3 and check Sum Amplifiers 1 and 2 and Integrators 1 and 2.

5. Connect the oscilloscope to A3TP7 (OUT). The peak-to-peak amplitude, displayed on the oscilloscope, should be between 4.9 and 5.1 divisions. If faulty, see Service Sheet 3 and check the Sum and Output Amplifier.

6. On the Audio Analyzer, key in 44.3 SPCL to set the Notch Filter to the bandpass mode. The peak-to-peak amplitude, displayed on the oscilloscope, should be between 4.7 and 5.3 divisions. The amplitude display on the Audio Analyzer should read between 2.8 and 3.2V. If the oscilloscope waveform is faulty, see Service Sheet 3 and check the Sum and Output Amplifier. If the amplitude display is faulty, see Output Amplifier Check and Voltmeter Check.

7. On the Audio Analyzer, key in the Special Functions listed in Table 8B-10. For each setting, key in the first frequency, set RATIO off (if on), and, after settling, note the displayed amplitude. Then press RATIO to establish a ratio reference. Key in the other two frequencies, and after settling, note the relative amplitude. The levels should be within the limits indicated. If faulty, see Service Sheet 3 and check Sum Amplifiers 1 and 2 and Integrators 1 and 2.

8. On the Audio Analyzer, key in 53.2 SPCL. Key in the frequencies listed in Table 8B-11. For each setting, key in the pair of Special Functions indicated. After keying in the first member of the pair of Special Functions, press RATIO twice to establish a new ratio reference. After keying in the second Special Function, the amplitude read

Table 8B-10. Amplitude Limits on Display, $\sqrt{2}$ Step 7

Special Function	Source Frequency (Hz)	Amplitude Limits	
		Minimum	Maximum
53.0	98.7	2.8V	3.2V
	49.4	15%	25%
	197	15%	25%
53.1	781	2.8V	3.2V
	390	15%	25%
	1 560	15%	25%
53.2	6 250	2.8V	3.2V
	3 130	15%	25%
	12 500	15%	25%
53.3	50 000	2.8V	3.2V
	25 000	15%	25%
	100 000	15%	25%

Table 8B-11. Amplitude Limits on Display, $\sqrt{2}$ Step 8

Source Frequency (Hz)	Special Functions	Amplitude Limits (%)	
		Minimum	Maximum
9120	54.128, 54.127	97	99
4560	54.64, 54.63	94	97
2280	54.32, 54.31	90	94
1140	54.16, 54.15	82	88
570	54.8, 54.7	68	76
285	54.4, 54.3	46	58
142.5	54.2, 54.1	20	40

on the Audio Analyzer's display should be within the limits shown. If faulty, see Service Sheet 3 and check Sum Amplifiers 1 and 2 and Integrators 1 and 2.

9. On the Audio Analyzer, key in **FREQ** 1 kHz, **53.1 SPCL**, and **54.147 SPCL**. Connect the oscilloscope to **A3TP2** (**NOTCH AMP**) and set it for absolute vertical calibration. The waveform should be a heavily clipped sine wave with an amplitude between 20 and 25 Vpp. If faulty, see Service Sheet 4 and check the Notch Amplifier.

10. Press **RATIO** twice to establish a new ratio reference. Key in **44.1 SPCL** to set the Notch Filter to the notch mode. The amplitude display should be less than 25%. If faulty, see Service Sheet 3 and check the Sum and Output Amplifier.

11. Remove the ground from **A3TP3** and connect the oscilloscope (dc coupled) to it instead. On the Audio Analyzer, key in **FREQ** 800 Hz. The waveform should be a dc voltage between 4.0 and 4.6 Vdc. If faulty, see Service Sheet 4 and check the tune control circuits.

12. On the Audio Analyzer, key in 1.2 kHz. The waveform should be between -4.6 and -4.0 Vdc. If faulty, see Service Sheet 4 and check the tune control circuits.

13. On the Audio Analyzer, key in 1 kHz. The waveform should be between -1 and +1 Vdc. If faulty, see Service Sheet 3 and check the Sum Amplifier 2 and Service Sheet 4 and check the Tune Multiplier.

14. Remove the ground from A3TP4. The amplitude display should read 1% or less. If faulty, see Service Sheet 3 and check the Sum Amplifier and Service Sheet 4 and check the balance control circuits.

15. On the Audio Analyzer, key in 41.0 SPCL. Key in AMPTD 3 V. Press DISTN. The amplitude display should read 0.01% or less. If the level is slightly out of limit, perform the *Notch Filter Tune and Balance Adjustment*, paragraph 5-12. Otherwise, the Notch Filter is functioning, but the automatic tuning sequence is faulty. See Service Sheet BD4 and check the Counter.

√3 Output Amplifier Check

1. On the Audio Analyzer, key in 41.0 SPCL to initialize the instrument. Set the INPUT and OUTPUT switches to ground. Set the 80 kHz LOW PASS filter off. Key in AMPTD 300 mV. Key in 1.11 SPCL to set the input to the 3V range. Key in 3.1 SPCL to set the output to the least sensitive range. Connect the HIGH OUTPUT to the HIGH INPUT.

2. Connect a high-impedance, ac coupled oscilloscope to A3TP7 (OUT). The waveform on the oscilloscope should be a sine wave with an amplitude between 800 and 900 mVpp and a period of approximately 1 ms. If faulty, see √2 *Notch Filter Check*.

3. Use the oscilloscope's vertical gain controls to adjust the display amplitude for 5 divisions peak-to-peak deflection.

4. Connect the oscilloscope to A4TP8 (AMP 1). The peak-to-peak amplitude, displayed on the oscilloscope, should be between 2.4 and 2.6 divisions. If faulty, see Service Sheet 5 and check Attenuator 1 and Amplifier 1.

5. On the Audio Analyzer, key in AMPTD 30 mV. Key in 3.3 SPCL. The peak-to-peak amplitude, displayed on the oscilloscope, should be between 2.4 and 2.6 divisions. If faulty, see Service Sheet 5 and check Attenuator 1.

6. Connect the oscilloscope to A4TP6 (AMP 2). The peak-to-peak amplitude, displayed on the oscilloscope, should be between 4.8 and 5.2 divisions. If faulty, see Service Sheet 5 and check the Low-Pass Filters.

7. Connect the oscilloscope to A4TP5 (AMP 3). Decrease the vertical gain of the oscilloscope by a factor of 10. The peak-to-peak amplitude, displayed by the oscilloscope, should be between 4.8 and 5.2 divisions. If faulty, see Service Sheet 5 and check Attenuator 2 and Amplifier 3.

8. On the Audio Analyzer, key in AMPTD 300 mV. Key in 3.2 SPCL. Increase the vertical gain of the oscilloscope by a factor of 10. The peak-to-peak amplitude, displayed on the oscilloscope, should be between 4.8 and 5.2 divisions. If faulty, see Service Sheet 5 and check Attenuator 2.

9. Connect the oscilloscope to A4TP4 (AMP 4). Decrease the vertical gain of the oscilloscope by a factor of 10. The peak-to-peak amplitude, displayed on the oscilloscope, should be between 4.8 and 5.2 divisions. If faulty, see Service Sheet 5 and check Attenuator 3, the Buffer, the High-Pass Filter, and Amplifier 4.

10. On the Audio Analyzer, key in 3.1 SPCL. Increase the vertical gain of the oscilloscope by a factor of 10. The peak-to-peak amplitude, displayed on the oscilloscope, should be between 4.8 and 5.2 divisions. If faulty, see Service Sheet 5 and check Attenuator 3.

11. On the Audio Analyzer, key in FREQ 80 kHz. Set the 80 kHz LOW PASS filter on. The peak-to-peak amplitude, displayed on the oscilloscope, should be between 3 and 4 divisions. If faulty, see Service Sheet 5 and check the 80 kHz Low-Pass Filter.

12. On the Audio Analyzer, key in FREQ 30 kHz. Set the 30 kHz LOW PASS filter on. The peak-to-peak amplitude, displayed on the oscilloscope, should be between 3 and 4 divisions. If faulty, see Service Sheet 5 and check the 30 kHz Low-Pass Filter.

13. On the Audio Analyzer, key in 55.0 SPCL, 56.15 SPCL, and 57.140 SPCL to set the internal source to 13 Hz. The peak-to-peak amplitude, displayed on the oscilloscope, should be between 4.6 and 5.4 divisions. If faulty, see Service Sheet 5 and check the High-Pass Filter.

14. On the Audio Analyzer, key in 0.435 SPCL to insert the 13 Hz High-Pass Filter. (Ignore the displays.) The peak-to-peak amplitude, displayed on the oscilloscope, should be between 3 and 4 divisions. If faulty, see Service Sheet 5 and check the High-Pass Filter.

√4 Voltmeter Check

1. On the Audio Analyzer, key in 41.0 SPCL to initialize the instrument. Set the INPUT and OUTPUT switches to ground. Key in AMPTD 300 mV. Key in 1.11 SPCL to set the input to the 3V range. Key in 3.2 SPCL to set the output to the 20 dB range. Connect the HIGH OUTPUT to the HIGH INPUT.
2. Connect a high-impedance, ac coupled oscilloscope to A4TP4 (AMP 4). The waveform on the oscilloscope should be a sine wave with an amplitude between 8 and 9 Vpp and a period of approximately 1 ms. If faulty, see **√3 Output Amplifier Check**.
3. DC couple the oscilloscope and connect it to A4TP1 (DC OUT). The waveform should be a dc voltage between 2.8 and 3.2 Vdc. If faulty, see Service Sheet 6 and check the Output RMS/Average/Quasi-peak Detector.
4. On the Audio Analyzer, key in AMPTD 400 mV. Key in 0.76 SPCL to enable readback of the Output Overload Detector. The displays should read 0000 0000. If faulty, see Service Sheet 6 and check the Output Overload Detector.
5. On the Audio Analyzer, key in AMPTD 420 mV. Key in 0.76 SPCL. the displays should read 0001 0000. If faulty, see Service Sheet 6 and check the Output Overload Detector.

Hint: Because of the hysteresis in the Output Overload Detector, it will be necessary to key in AMPTD 300 mV first if it is desired to repeat steps 4 and 5.

6. On the Audio Analyzer, key in AMPTD 300 mV. Connect the oscilloscope to A4TP9. The waveform should be a pulse waveform switching between 0 Vdc and 2.9 to 3.1 Vdc. If faulty, see Service Sheet 7 and check the Voltmeter Input Selector.
7. The right display should read between 0.29 and 0.31V. If faulty, see Service Sheet 7 and begin troubleshooting with the Voltage-to-Time Converter.

Hint: If the other inputs to the Voltmeter Input Selector are suspected to be faulty, see Service Sheet 7 and check the Voltmeter Input Selector.

8. On the Audio Analyzer, press SINAD. Key in AMPTD 3 V. Key in 3.0 SPCL. Key in 45.1 SPCL to enable the SINAD meter. The amplitude display should read greater than 80 dB. The SINAD meter should read beyond full scale. If the amplitude display is faulty, see **√2 Notch Filter Check**. If the SINAD meter is faulty, see Service Sheet 6 and check the SINAD meter circuits.
9. On the Audio Analyzer, key in 6.1 SPCL to hold the Notch Filter at its present setting. Key in FREQ 900 Hz. The amplitude display should read between 15 and 20 dB, but more importantly, the SINAD meter should agree with this reading to within 1 dB. If the SINAD meter is faulty, see Service Sheet 6 and check the SINAD meter circuits.
10. On the Audio Analyzer, key in 0.524 SPCL. The SINAD meter should read beyond full scale. If faulty, see Service Sheet 6 and check the Meter Peg/Off Switch.
11. On the Audio Analyzer, key in 0.528 SPCL. The SINAD meter should read between 0 and +0.5 dB. If faulty, see Service Sheet 6 and check the Meter Peg/Off Switch.

√5 Pre-Notch RMS/Average Detector Check

1. On the Audio Analyzer, key in 41.0 SPCL to initialize the instrument. Set the INPUT and OUTPUT switches to ground. Key in AMPTD 3 V. Key in 1.11 SPCL to set the input to the 3V range. Connect the HIGH OUTPUT to the HIGH INPUT.
2. Connect a high-impedance, ac coupled oscilloscope to A2TP3 (OUT). The waveform on the oscilloscope should be a sine wave with an amplitude between 8 and 9 Vpp and a period of approximately 1 ms. If faulty, see **√3 Input Amplifier Check**.
3. Use the oscilloscope's vertical gain controls to adjust the display amplitude for 5 divisions peak-to-peak deflection of the signal.

4. DC couple the oscilloscope and connect it to A2TP15 (RMS2). The waveform should be a dc voltage between 1.7 and 1.8 divisions. If faulty, see Service Sheet 3 and check the RMS Detector.
5. On the Audio Analyzer, key in 5.2 SPCL to switch to the Average Detector. The waveform should be a dc voltage between 1.7 and 1.8 divisions. If faulty, see Service Sheet 3 and check the Average Detector.

SERVICE SHEET 1---A2 Input Amplifier Assembly (Input Circuits)**PRINCIPLES OF OPERATION****General**

This portion of the Input Amplifier Assembly (A2) contains the AC/DC Switch, Input Attenuator, Over-Voltage Protection, and Differential-to-Single-Ended Amplifier. These and the other circuits on the Input Amplifier Assembly condition the signal to be suitable to drive the Notch Filter and Output Amplifier.

Input Circuits and Input Attenuator

The signals at the HIGH and LOW INPUT connectors are filtered by RFI filters A13L2 and A13C16 and A13L3 and A13C15. The INPUT connectors are both floating. The LOW INPUT can be shorted to ground by chassis part S3. The inputs are ac coupled by C2 and C88 except in the dc level measurement mode where the capacitors are effectively shorted by R2 and R104 which are switched in by K7.

The High and Low Input Attenuators are identical. Only the High Input Attenuator will be discussed. The attenuator is a set of two divider legs with four outputs which are selected by relays K4, K5, and K6 and FET Q2. The two dividers present a combined input impedance of 100 k Ω . (R2 adds another 1 k Ω for dc measurements.) R3 and R4 form a 12 dB divider. C3, C4, C6, C7, and R5 compensate stray capacitance for flattest frequency response. R6, R7, and R8 form a 24 and 40 dB divider. The 24 dB tap is at the junction of R7 and R8. C9, C10, C11, C12, and R9 frequency compensate the 24 dB divider. In addition, C8, C109, and R96 are switched in by Q3 to frequency compensate the 40 dB divider. For input levels below 3V, the attenuation is set to 40 dB.

Over-Voltage Protection

The Over-Voltage Protection clips the input signal on either high or low path when the signal exceeds a magnitude of 15V. The circuit for both paths is identical.

Using the high path as an example, the clipping diodes are CR9, CR10, CR11, and CR12. VR1 and VR2 reference the clipping diodes to +12 and -12V. Follower amplifier U7 feeds the signal through C20 and C21 to the clipping diodes to prevent ac modulation of the capacitance of the clipping diodes to eliminate distortion. The signal from voltage divider R108 and R112 is fed to the Input Overload Detector (see Service Sheet 2).

Differential-to-Single-Ended Amplifier

U6, U12, and U5 convert the differential signal from the High and Low Input Attenuators to a single-ended signal (that is, one that is referenced to ground). The differential gain of U6 and U12 is programmed by K1 and K2 as cataloged in Table 8B-12. In the dc level measurement mode, only 0 dB gain is used.

Table 8B-12. Gain of the Differential-to-Single-Ended Amplifier

State of K1	State of K2	Gain (dB)
Open	Open	0
Open	Closed	8
Closed	Open	16
Closed	Closed	20

U5 subtracts the output of U6 from U12. Its gain with respect to the output of U6 is -1; its gain with respect to U12 is +1 if the divide-by-two voltage divider (R41, R42, and R43) is taken into account. R43 is adjusted to equalize the two gains and thus reject the common-mode signal. C25, C26, C27, and C32 flatten the frequency response of the two amplifiers. Dual FETs Q7 and Q9 provide a high input impedance. Dual FETs Q8 and Q10 minimize high-frequency distortion generated by ac modulation of the drain-to-gate capacitance of Q7 and Q9.

Relay Drivers

U15 is a TTL octal peripheral driver capable driving the relays. The relays energize when the relay-driver outputs go low. The diodes across the relay coils suppress the inductive transient generated by the coil when the current is interrupted. U14 decodes the attenuation control lines for the 40 dB attenuator.

Humidity Sealing

The area surrounding the relays of this assembly have been coated with a humidity seal. The area is marked on the circuit board. If components in the sealed area are replaced, it is recommended that solder flux *not* be removed and that a humidity sealant (such as HP 8500-3266) be applied with a cotton swab over the affected area.

TROUBLESHOOTING

General

Procedures for checking the Input Amplifier Assembly are given below. The circuits or points to check are marked on the schematic diagram by a hexagon with a check mark and a number inside, for example, $\sqrt{3}$. In addition, any points outside the labeled circuit area that must be checked are also identified. Fixed signals are shown on the schematic also inside a hexagon, for example, $+1.9 \text{ TO } +2.1 \text{ VDC}$. Extend the board assembly where necessary to make measurements. These procedures assume that the source is working properly.

Equipment

- Oscilloscope HP 1740A
- Test Oscillator HP 3310A

$\sqrt{1}$ **Input Attenuator and AC/DC Switch Check**

1. On the Audio Analyzer, key in 41.0 SPCL to initialize the instrument. Set the INPUT switch to FLOAT and the OUTPUT switch to ground. Key in AMPTD 3 V. Connect the HIGH OUTPUT to the HIGH INPUT. Connect a high-impedance, ac coupled oscilloscope to the gate of Q7A.
2. Key in the Special Functions listed in Table 8B-13. For each setting the peak-to-peak amplitude should be within the limits indicated. (The period of the signal should be approximately 1 ms.) If the signal level is incorrect, also check the control signals indicated.

Table 8B-13. Amplitude Limits at the Gate of Q7A or Q9A, $\sqrt{1}$ Steps 2 and 4

Check	Special Function	Oscilloscope Display (mVpp)	Level (TTL) at U15 Pins		
			4, 16	17, 3	6, 14
0 dB	1.11	8100 to 8900	L	H	H
12 dB	1.8	2000 to 2200	H	L	H
24 dB	1.5	500 to 560	H	H	L

Hint: Pin 1 of U16A should be between +10 and +12 Vdc. Pin 8 of U14C should be a TTL high. Q2 and Q5 should be off.

3. Key in 1.1 SPCL to set the input attenuation to 40 dB. The waveform should have an amplitude between 81 and 89 mVpp.

Hint: Pin 1 of U16A should be between -15 and -14 Vdc. Pins 16, 14, and 3 of U15 should be TTL high. Pin 8 of U14C should be a TTL low. Q2 and Q5 should be on.

4. Connect the oscilloscope to the gate of Q9A. Connect the HIGH OUTPUT to the LOW INPUT. Repeat steps 2 and 3. The results should be the same.

5. On the Audio Analyzer, key in 1.11 SPCL. Connect A8TP16 (+5V) to the LOW INPUT. The oscilloscope, dc coupled, should read 0 Vdc.

Hint: Pins 8 and 12 of U15A should be a TTL high. K7 should be open.

6. On the Audio Analyzer, press S (Shift) DC LEVEL. Key in 2.4 SPCL to set the input attenuation to 0 dB (in the dc mode). The oscilloscope should read approximately +5 Vdc.

Hint: Pins 8 and 12 of U15A should be a TTL low. K7 should be closed.

7. Connect the oscilloscope to the gate of Q7A. Connect the HIGH OUTPUT to the HIGH INPUT. Press AC LEVEL. Repeat steps 5 and 6. The results should be the same.

√2 Over-Voltage Protection Check

1. On the Audio Analyzer, key in 41.0 SPCL to initialize the instrument. Set the INPUT switch to FLOAT. Key in 1.11 SPCL to set the input amplifier gain to 0 dB.
2. Set the test oscillator to 1 kHz and level to approximately 1 Vrms. Connect the output to the Audio Analyzer's HIGH INPUT.
3. Connect a high-impedance, dc coupled oscilloscope to the gate of Q7A.
4. Short A7TP6 (RSI) to A8TP16 (+5V) to inhibit the Input Overload Flip-Flop. (See Service Sheet 12.)
5. Increase the test oscillator level to approximately 30 Vpp. The waveform on the oscilloscope should appear as shown in Figure 8B-3.

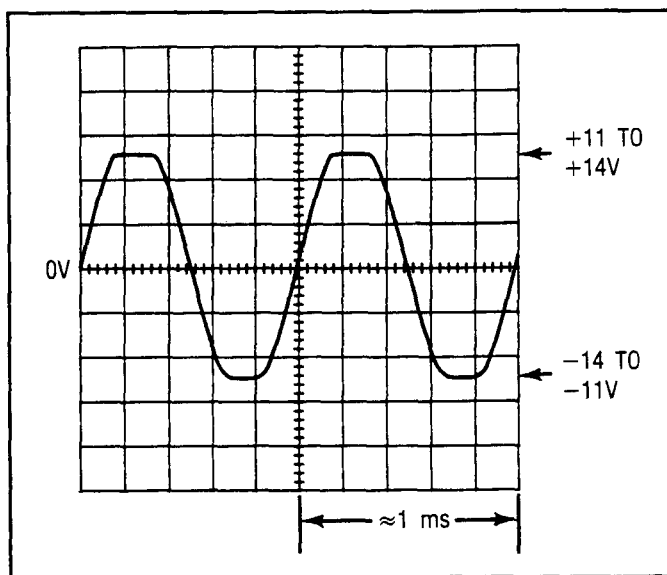


Figure 8B-3. Waveform for √2 Steps 5 and 6

6. Connect the oscilloscope to the gate of Q9A. Connect the test oscillator to the LOW INPUT. The waveform should appear as shown in Figure 8B-3.

√3 Differential-to-Single-Ended Amplifier

1. On the Audio Analyzer, key in 41.0 SPCL to initialize the instrument. Set the INPUT switch to FLOAT and the OUTPUT switch to ground. Key in AMPTD 80 mV. Connect the HIGH OUTPUT to the HIGH INPUT.
2. Connect a high-impedance, ac coupled oscilloscope to the gate of Q7A. The waveform on the oscilloscope should be between 216 and 236 mVpp. (The period of the signal should be 1 ms.)
3. Use the oscilloscope's vertical gain controls to adjust the waveform amplitude for 2 divisions peak-to-peak.
4. Connect the oscilloscope to A2TP5 (SING END). Key in the Special Functions listed in Table 8B-14. For each setting, increase the oscilloscope's vertical gain by the amount indicated. The peak-to-peak amplitude, displayed on the oscilloscope, should be within the limits indicated. If the signal level is incorrect, also check the control signals indicated.
5. Disconnect the HIGH INPUT. Set the oscilloscope to measure dc voltage. The voltage should be between -0.1 and +0.1 Vdc.

Hint: If the dc voltage is only slightly out of limits, perform the *Input DC Offset Adjustment*, paragraph 5-10.

6. Connect the HIGH OUTPUT to the LOW INPUT. Set the oscilloscope back to the $\times 1$ gain that begins step 4. Repeat step 4. The results should be the same.

Table 8B-14. Amplitude at A2TP5, $\boxed{J3}$ Step 4

Special Function	Increase in Oscilloscope Vertical Gain	Amplitude Limits (div pp)	Level (TTL) at U15B Pin	
			9, 11	7, 13
1.11	×1	1.9 to 2.1	H	H
1.15	×1	4.7 to 5.3	H	L
1.17	×10	1.2 to 1.3	L	H
1.19	×10	1.9 to 2.1	L	L

7. Using a tee adapter, connect the HIGH OUTPUT to the HIGH and LOW INPUTs in parallel. Key in AMPTD 1 V. The waveform on the oscilloscope should have an amplitude less than 50 mVpp. (The waveform may be non-sinusoidal.)

Hint: If the signal is only slightly out of limits, perform the *Common-Mode Rejection Adjustment*, paragraph 5-9.

SERVICE SHEET 2---A2 Input Amplifier Assembly (Output Circuits)**PRINCIPLES OF OPERATION****General**

This portion of the Input Amplifier Assembly (A2) contains a stage of programmable amplification, the Weighting Bandpass and High-Pass Filters, and the Input Range and Overload Detectors. The output of the assembly drives the Notch Filter.

Programmable Gain Amplifier

The input of the Programmable Gain Amplifier is ac coupled by C37 and C38. The amplifier itself is non-inverting and has a gain as cataloged in Table 8B-15. (Only one switch is closed at a time.)

Table 8B-15. Gain of the Programmable Gain Amplifier

Switch Closed	Gain (dB)
U11(2)	0
U11(4)	4
U11(3)	8
U11(1)	12

Weighting Bandpass and High-Pass Filters

The Weighting Bandpass and High-Pass Filters are optional plug-on filters used for specialized testing applications. None, one, or two filters can be installed. If no filter is installed, the filters are replaced by jumpers. See Service Sheets 2A and 2B for a discussion of the filter circuits.

Input Range Detector

The Input Range Detector (U1) is a true rms detector which senses the signal level at the input to the Weighting Bandpass and High-Pass Filters. The output drives the dc voltmeter which is read by the Controller to determine the setting of input gain. The detector is placed before the active filters to sense overloading, since the filters can filter the overload signal components.

Since some filters have gain, the sensitivity of the detector is increased to match the filters. The Gain 1 and Gain 2 resistors in the filters set the overall detector sensitivity by setting the gain of U17.

Input Overload Detector

The Input Overload Detector produces a low output that resets the Input Overload Flip-Flop on the Latch Assembly and sets the input Attenuators to 40 dB (see Service Sheets 1 and 12). The low is produced if the output of the Input Range Detector exceeds 8V or if the output of the Differential-to-Single-Ended Amplifier or the signal from the Input Attenuators goes more positive than +7.5V or more negative than -7.5V. (See Service Sheet 1.)

Comparators U4 and U18 are wire-ORed in such a way that if any comparator senses an overload condition, the INPUT OVLD line goes low. R76 and C61 add delay to the circuit that prevents the recognition of short-duration overloads. R87 and C70 form a high-frequency interference filter.

TROUBLESHOOTING

General

Procedures for checking the Input Amplifier Assembly are given below. The circuits or points to check are marked on the schematic diagram by a hexagon with a check mark and a number inside, for example, $\langle \checkmark 3 \rangle$. In addition, any points outside the labeled circuit area that must be checked are also identified. Fixed signals are shown on the schematic also inside a hexagon, for example, $\langle +1.9 \text{ TO } +2.1 \text{ VDC} \rangle$. Extend the board assembly where necessary to make measurements. These procedures assume that the source is working properly.

Equipment

Oscilloscope HP 1740A

$\langle \checkmark 1 \rangle$ Programmable Gain Amplifier Check

1. On the Audio Analyzer, key in 41.0 SPCL to initialize the instrument. Set the INPUT and OUTPUT switches to ground. Key in AMPTD 1 V. Key in 1.11 SPCL to set the input gain to 0 dB. Connect the HIGH OUTPUT to the HIGH INPUT.

2. Connect a high-impedance, ac coupled oscilloscope to A2TP5 (SING END). The waveform should be 2.7 to 2.9 Vpp. (The period of the signal should be approximately 1 ms.)

Hint: If the signal is faulty, see Service Sheet 1 and check the Differential-to-Single-Ended Amplifier.

3. Use the oscilloscope's vertical gain controls to adjust the waveform amplitude for 2 divisions peak-to-peak.

4. Connect the oscilloscope to A2TP4 (PGM AMP). On the Audio Analyzer, key in the Special Functions listed in Table 8B-16. For each setting the peak-to-peak amplitude should be within the limits indicated. If the signal level is incorrect, also check the control signals indicated. (Checking U11 will require unplugging the leftmost plug-on filter A2A1 or probing from the circuit side of A2.)

Table 8B-16. Amplitude Limits at A2TP4, $\langle \checkmark 1 \rangle$ Step 4

Gain (dB)	Special Function	Amplitude Limits (div pp)	Level (TTL) at U11 Pins			
			8	9	16	1
0	1.11	1.9 to 2.1	L	H	H	H
4	1.12	3.0 to 3.3	H	L	H	H
8	1.13	4.7 to 5.3	H	H	L	H
12	1.14	7.6 to 8.4	H	H	H	L

$\langle \checkmark 2 \rangle$ Weighting Bandpass and High-Pass Filters Check

1. On the Audio Analyzer, key in 41.0 SPCL to initialize the instrument. Set the INPUT and OUTPUT switches to ground. Key in AMPTD 1 V. Key in 1.11 SPCL to set the input gain to 0 dB. Connect the HIGH OUTPUT to the HIGH INPUT.

2. Connect a high-impedance, ac coupled oscilloscope to A2TP4 (PGM AMP). The waveform should be 2.7 to 2.9 Vpp. (The period of the signal should be approximately 1 ms.)

Hint: If the signal is faulty, check the Programmable Gain Amplifier.

3. Use the oscilloscope's vertical gain controls to adjust the waveform amplitude for 2 divisions peak-to-peak.

4. Connect the oscilloscope to A2TP3 (OUT).

5. Set the source frequency as listed in Table 8B-17. For each setting, press the appropriate filter key. The peak-to-peak amplitude should be within the limits indicated.

Table 8B-17. Amplitude at A2TP3, $\sqrt{2}$ Step 5

SOURCE Frequency (Hz)	Weighting Bandpass or High-Pass Filter	Amplitude Limits (div pp)
1000	(Both Off or None)	1.9 to 2.1
1000	HIGH PASS 400 Hz	1.9 to 2.1
800	CCITT WEIGHTING	1.9 to 2.1
6800	CCIR WEIGHTING	7.7 to 8.6
1000	C-Message WEIGHTING	1.9 to 2.1
6800	CCIR/ARM WEIGHTING	4.1 to 4.5
1000	"A" WEIGHTING	1.9 to 2.1

Hint: If the signal level is incorrect, check the control signals indicated in Table 8B-18. (Checking U10 will require probing from the circuit side of A2.)

Table 8B-18. Control Signals, $\sqrt{2}$ Step 5 Hint

Position of On-Filter	Level (TTL) at U10 Pin		
	1	8	16
(Both Off)	L	H	H
Left A2A1	H	L	H
Right A2A2	H	H	L

Hint: If the signal is only slightly out of limits, perform the *400 Hz High-Pass and Weighting Bandpass Filters Adjustment*, paragraph 5-11.

Hint: See Service Sheet 2A or 2B for hints in checking the individual filters.

6. Perform the *Audio Filters Performance Test*, paragraph 4-11 or the filter check portion of the simpler *Basic Functional Checks*, paragraph 3-10.

Hint: If the passband gain is correct but the frequency response is out of limits, check the frequency-response-determining resistors and capacitors of the respective filter. See Service Sheet 2A or 2B.

$\sqrt{3}$ Input Range Detector Check

1. On the Audio Analyzer, key in 41.0 SPCL to initialize the instrument. Set the INPUT and OUTPUT switches to ground. Key in AMPTD 1 V. Key in 1.11 SPCL to set the input gain to 0 dB. Connect the HIGH OUTPUT to the HIGH INPUT.

2. Connect a high-impedance, ac coupled oscilloscope to A2TP5 (SING END). The waveform should be 2.7 to 2.9 Vpp. (The period of the signal should be approximately 1 ms.)

Hint: If the signal is faulty, see Service Sheet 1 and check the Differential-to-Single-Ended Amplifier.

3. Use the oscilloscope's vertical gain controls to adjust the waveform amplitude for 7.1 divisions peak-to-peak.

4. Connect the oscilloscope, dc coupled, to A2TP2 (RMS). Press the appropriate filter key indicated in Table 8B-19. For each setting, the dc level (with respect to ground) should be within the limits indicated.

Hint: The sensitivity of the rms converter (U1) is 1 Vdc/Vrms. The gain of U17 is determined by R115 and the Gain 1 or Gain 2 resistor of A2A1 or A2A2 respectively. FET Q4 is on when filter A2A1 is selected. (Pin 8 of U10 is a TTL low.) Switch 4 of U10 is on when filter A2A2 is selected. (Pin 16 of U10 is a TTL low.)

Table 8B-19. Level at A2TP2, $\boxed{J3}$ Step 4

Weighting Bandpass or High-Pass Filter	Amplitude Limits (div dc)
(Both Off or None)	2.4 to 2.6
HIGH PASS 400 Hz	2.4 to 2.6
CCITT WEIGHTING	2.4 to 2.6
CCIR WEIGHTING	0.9 to 1.1*
C-Message WEIGHTING	2.4 to 2.6
CCIR/ARM WEIGHTING	5.1 to 5.4
"A" WEIGHTING	3.0 to 3.2

* Reduce the oscilloscope's vertical gain by 10.

 $\boxed{J4}$ Input Overload Detector Input

1. Unplug the A2A2 assembly, if present, to gain access to the components beneath. (Refer to *Filter Board Removal in Troubleshooting* for Service Sheet 2A.)

2. On the Audio Analyzer, key in 41.0 SPCL to initialize the instrument. Set the INPUT and OUTPUT switches to ground. Key in AMPTD 1 V. Key in 1.11 SPCL to set the input gain to 0 dB. Connect the HIGH OUTPUT to the HIGH INPUT.

3. Connect a high-impedance, dc coupled oscilloscope to A2TP3 (RMS). The dc level should be between +0.9 and +1.1 Vdc.

Hint: If the signal is faulty, check the Input Range Detector.

4. Connect the oscilloscope or a logic probe to A7TP6 (RSI). The signal should be a TTL high.

Hint: All outputs of U4 and U18 should be in the high (open) state.

5. Perform the following procedure. Each procedure should generate a TTL low at A7TP6. (Remove the shorts after each step is completed.)

- a. Short out R81. (This will also generate Error 30.)
- b. Short pin 4 of U4A to +15V.
- c. Short pin 4 of U4A to -15V.
- d. Short pin 6 of U18B to +15V.
- e. Short pin 6 of U18B to -15V.
- f. Short pin 9 of U18C to +15V.
- g. Short pin 9 of U18C to -15V.

SERVICE SHEETS 2A AND 2B---A2A1 and A2A2 Weighting Bandpass and High-Pass Filter Assemblies**PRINCIPLES OF OPERATION**

The Weighting Bandpass and High-Pass Filter Assemblies (A2A1 or A2A2) are optional audio filters which plug onto the A2 Input Amplifier Assembly to filter the signal before being measured by the Pre-Notch RMS/Average or Output RMS/Average Detector. In general the filters are quite similar. The filters are active types composed of multiple high-pass, low-pass, and bandpass sections. The CCITT Weighting Filter will serve as an example.

The CCITT Weighting Filter (sometimes referred to as a psophometric filter) is a complex collection of poles and zeros which produces a bandpass response. U1A, U1B, U1D, and their associated resistors and capacitors have low-pass responses. U1C and its associated resistors and capacitors have a bandpass response. U9 on the A2 Input Amplifier Assembly (see Service Sheet 2) and its associated resistors and capacitors have a high-pass response. R8 and C5 is a single-pole, passive low-pass filter. C10 and R14 is a single-pole, passive high-pass filter. R4 adjusts the overall filter gain.

Some filters, such as the "A" Weighting Filter, have a resistor (R15) which increases the sensitivity of the Input Range Detector. (See Service Sheet 2.)

TROUBLESHOOTING

Begin troubleshooting the Weighting Bandpass and High-Pass Filter Assemblies by performing the *Weighting Bandpass and High-Pass Filters Check* on Service Sheet 2. If the passband gain is faulty, check the input offset on the individual ICs on the filter assembly using the following guidelines. (Note that A2U9 is part of a filter stage. It lies behind A2A1 but can be probed from the circuit side or, if desired, A2A1 can be moved to the position of A2A2 while A2U9 is checked. See Service Sheet 2.)

- Where bias voltages are shown on the schematic diagram, the dc voltage should be within the limits shown.
- Where bias voltages are not shown on the schematic diagram, the differential offset voltage at between the input pins should be within ± 15 mVdc.
- If the offset exceeds these limits, check the polarity of the output of the IC. If the polarity corresponds with the polarity of the input offset, the IC is probably good.

If the filters appear to work properly except that the frequency response is out of limits, check the frequency response of the individual filter stages against the following plots. An easy way to do this is as follows.

- Set the source to the desired frequency at 1V.
- Set the LOW INPUT and OUTPUT switches to ground. Set IMPEDANCE to 50 Ω . Connect the HIGH OUTPUT to the HIGH INPUT.
- Connect an ac voltmeter to A2TP4 (PGM AMP). The voltmeter reading is a reference.
- Connect the voltmeter to the output of the filter stage to be checked. The voltmeter reading relative to the reading in step c should agree with the plots in Figures 8B-4 to 8B-31 for the particular frequency and filter stage. (Note that the plots use a logarithmic magnitude scale. The dB reading is 20 log (reading of step d \div reading of step c).)

Filter Board Removal

To remove a filter board assembly, turn the screw in each of the four plastic standoffs one-quarter turn counter-clockwise, then work the board off the standoffs and interconnect plug. To install a board assembly, align the board with the standoffs and the interconnect plug, then press the board into place. If the board hangs up on a standoff, squeeze the top of the standoff with needle-nose pliers while pressing on the board. (The standoff has memory and remains slightly spread apart.) Relock the standoffs by turning the plastic screws one-quarter turn clockwise.

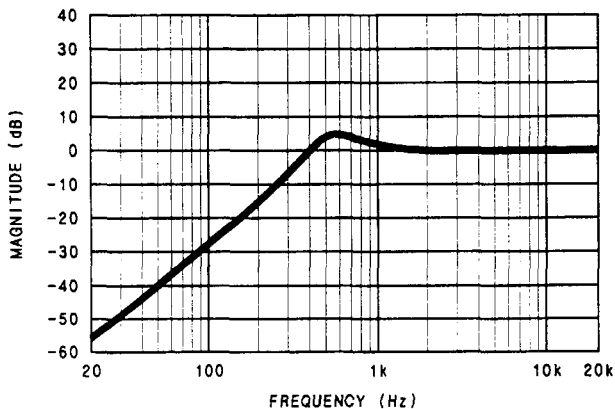


Figure 8B-4. 400 Hz High-Pass Filter,
U1 Pin 6

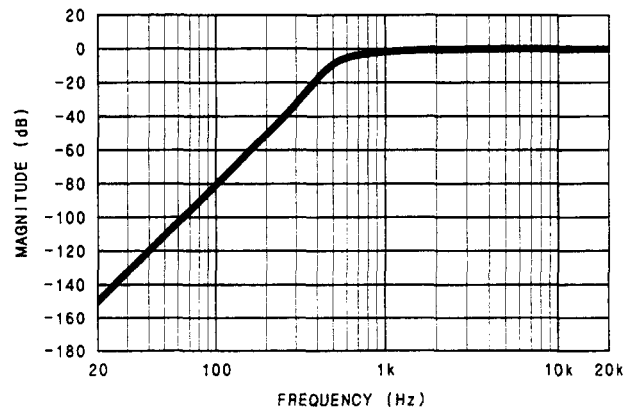


Figure 8B-5. 400 Hz High-Pass Filter,
U2 Pin 6

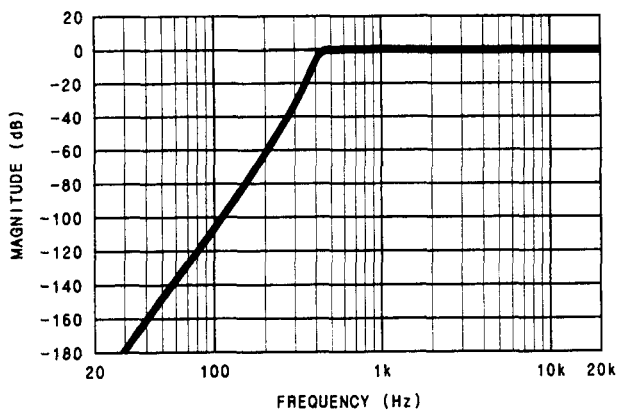


Figure 8B-6. 400 Hz High-Pass Filter, A2TP3

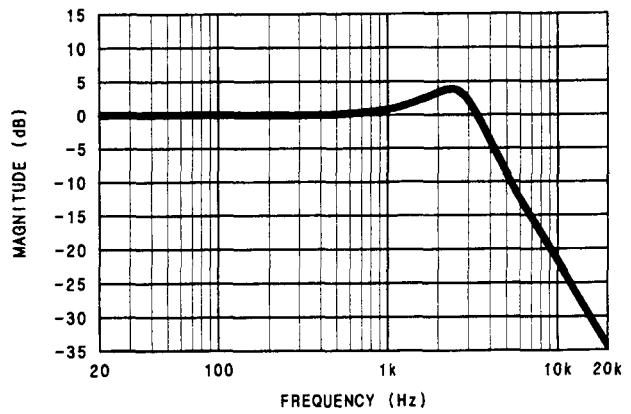


Figure 8B-7. CCITT Weighting Filter, U1 Pin 6

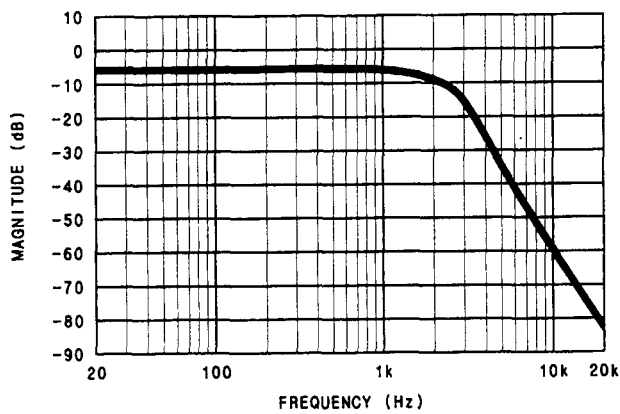


Figure 8B-8. CCITT Weighting Filter, U1 Pin 7

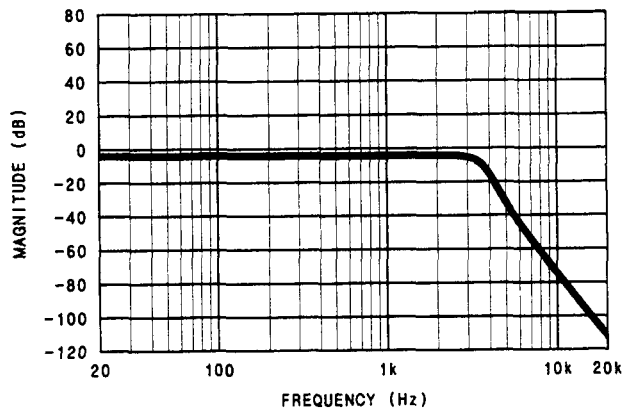


Figure 8B-9. CCITT Weighting Filter, U1 Pin 14

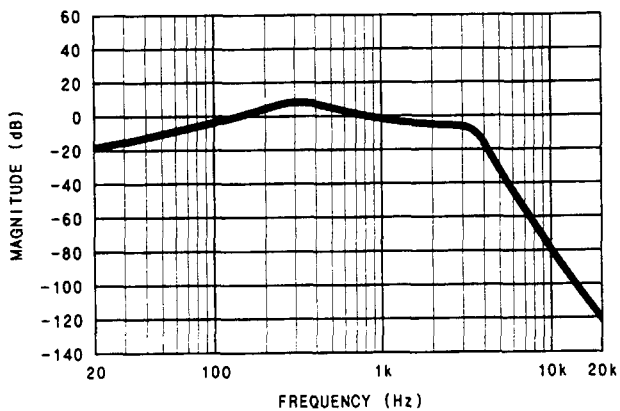


Figure 8B-10. CCITT Weighting Filter, U1 Pin 8

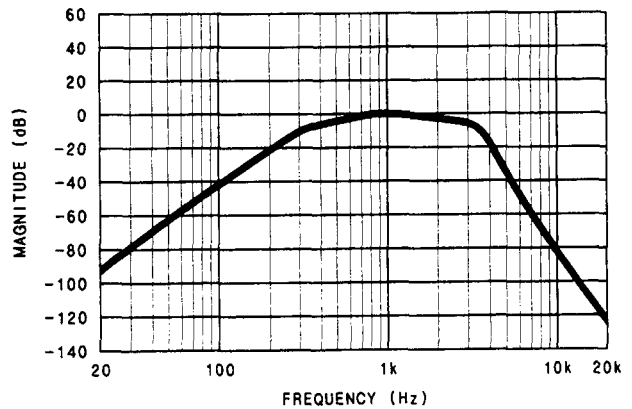


Figure 8B-11. CCITT Weighting Filter, A2TP3

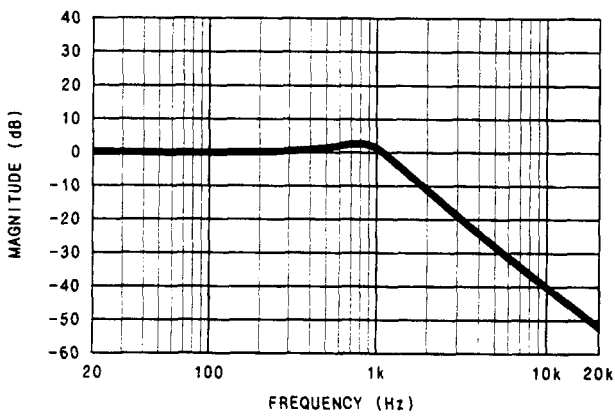


Figure 8B-12. C-Message Weighting Filter, U1 Pin 1

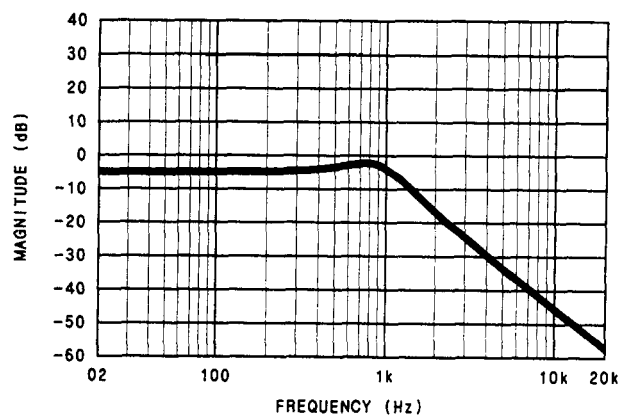


Figure 8B-13. C-Message Weighting Filter, U1 Pin 7

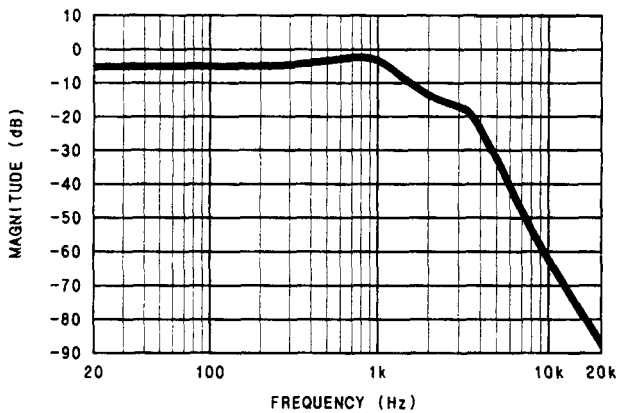


Figure 8B-14. C-Message Weighting Filter, U1 Pin 14

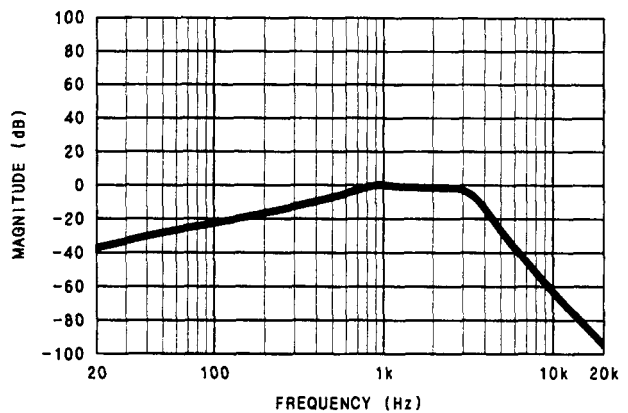


Figure 8B-15. C-Message Weighting Filter, U1 Pin 8

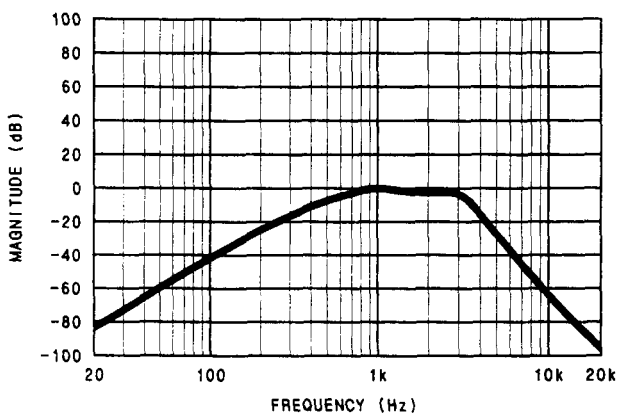


Figure 8B-16. C-Message Weighting Filter, A2TP3

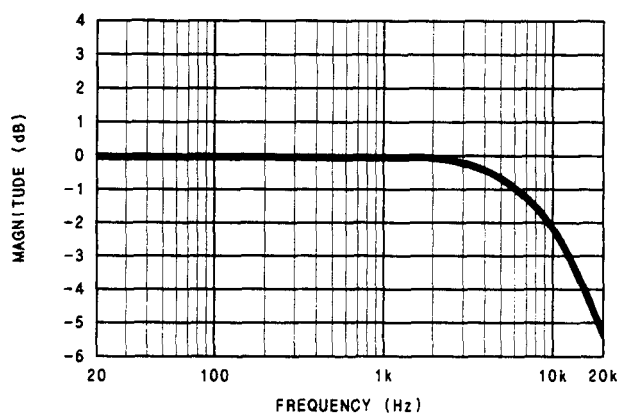


Figure 8B-17. "A" Weighting Filter, U1 Pin 3

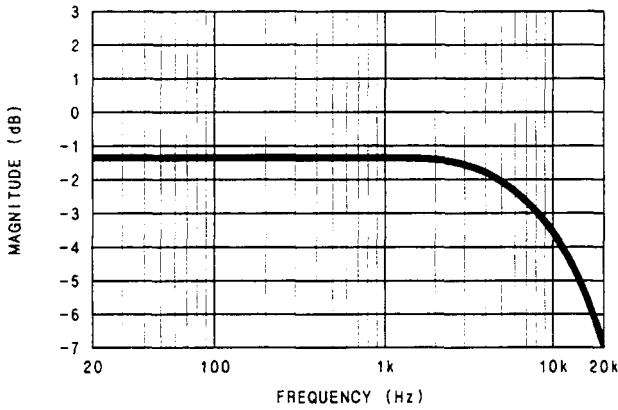


Figure 8B-18. "A" Weighting Filter, U1 Pin 7

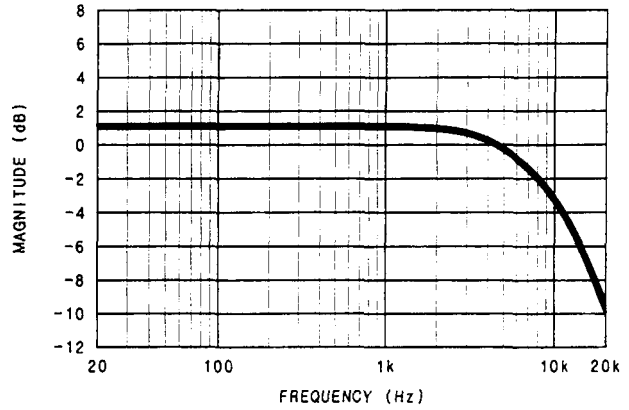


Figure 8B-19. "A" Weighting Filter, U1 Pin 14

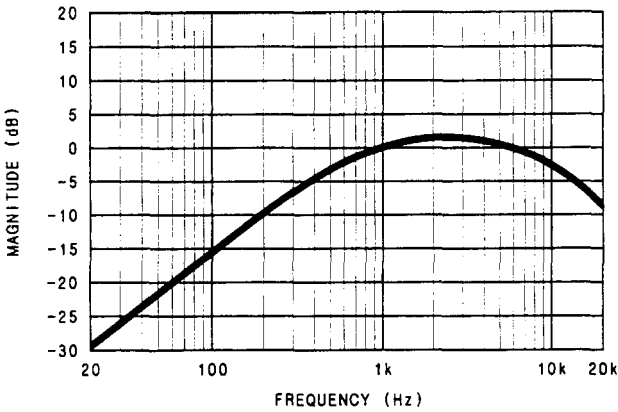


Figure 8B-20. "A" Weighting Filter, U1 Pin 8

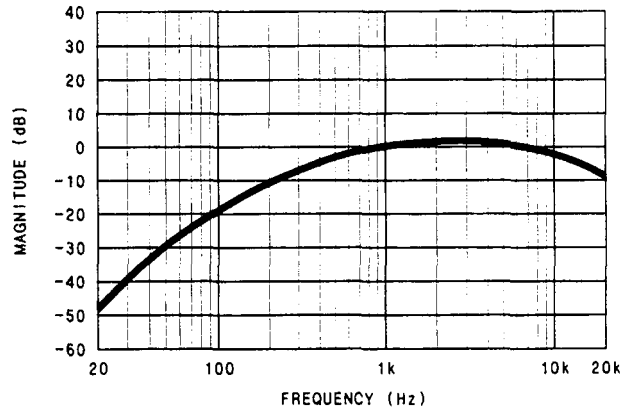


Figure 8B-21. "A" Weighting Filter, A2TP3

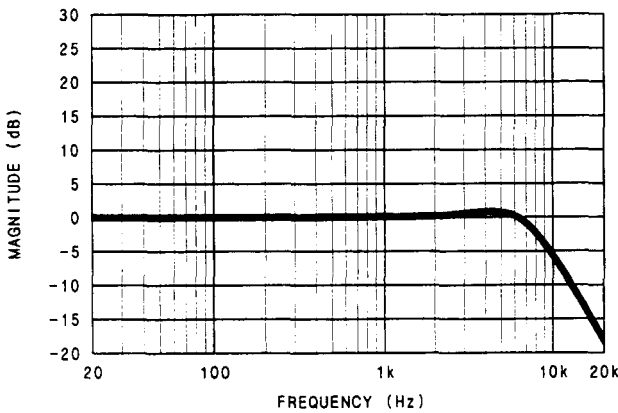


Figure 8B-22. CCIR Weighting Filter, U1 Pin 1

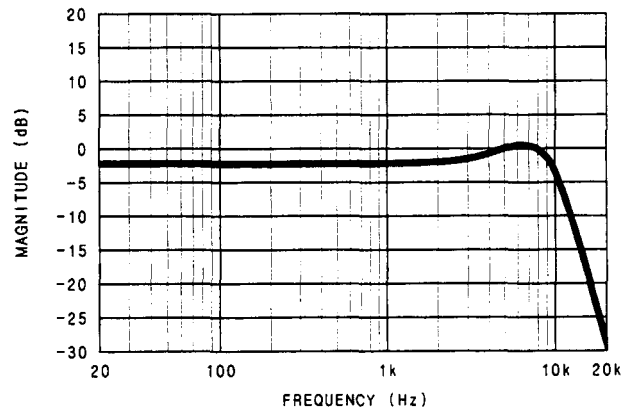


Figure 8B-23. CCIR Weighting Filter, U1 Pin 7

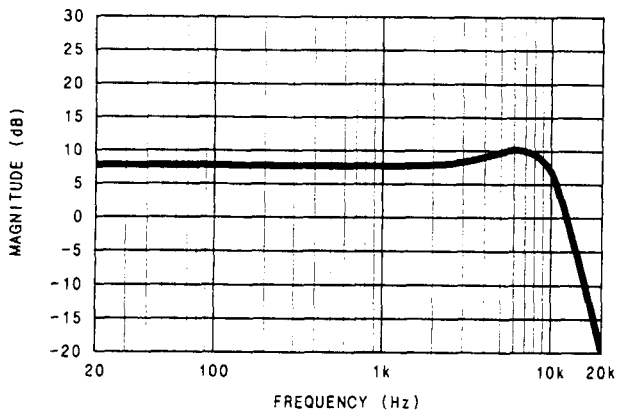


Figure 8B-24. CCIR Weighting Filter,
U1 Pin 14

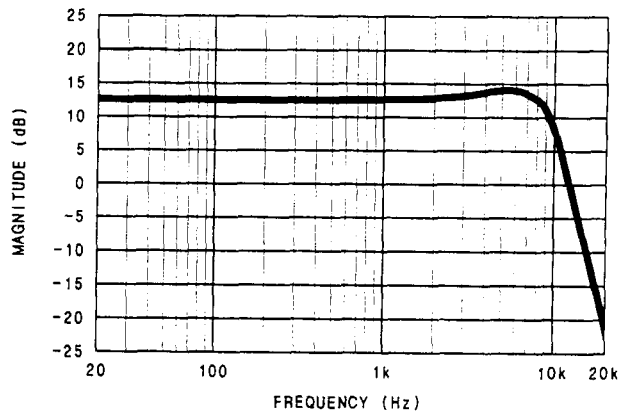


Figure 8B-25. CCIR Weighting Filter,
U1 Pin 8

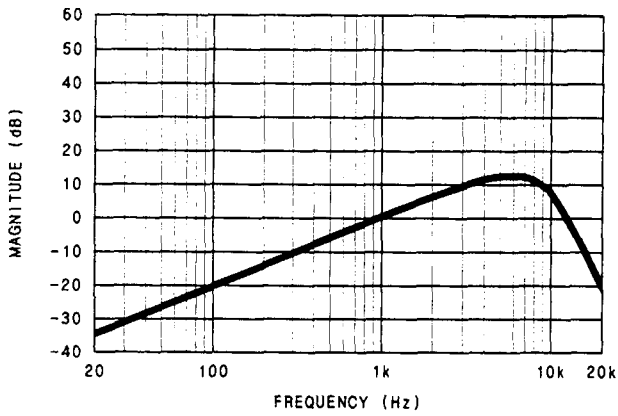


Figure 8B-26. CCIR Weighting Filter,
A2TP3

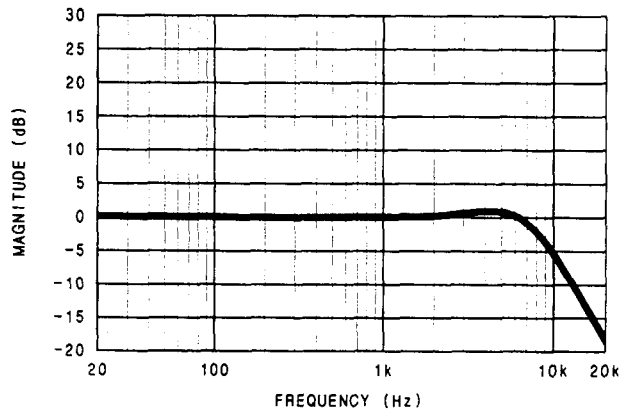


Figure 8B-27. CCIR/ARM Weighting Filter,
U1 Pin 1

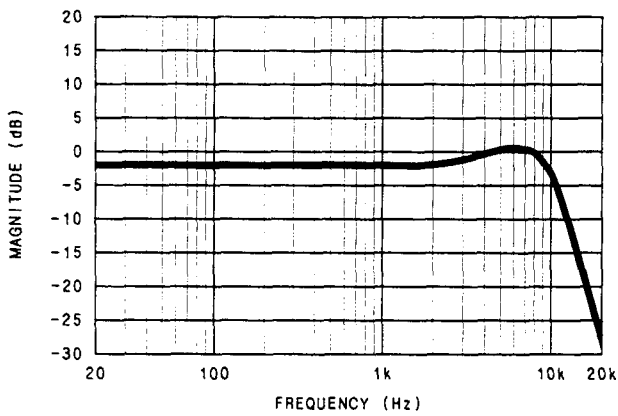


Figure 8B-28. CCIR/ARM Weighting Filter,
U1 Pin 7

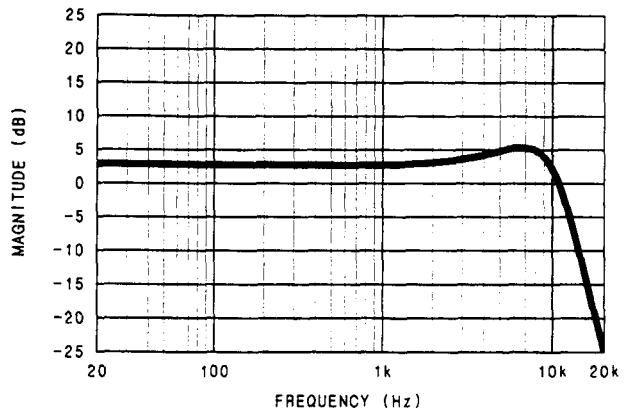


Figure 8B-29. CCIR/ARM Weighting Filter,
U1 Pin 14

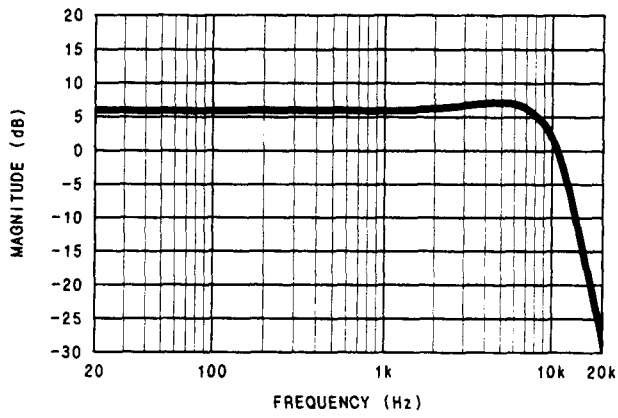


Figure 8B-30. CCIR/ARM Weighting Filter, U1 Pin 8

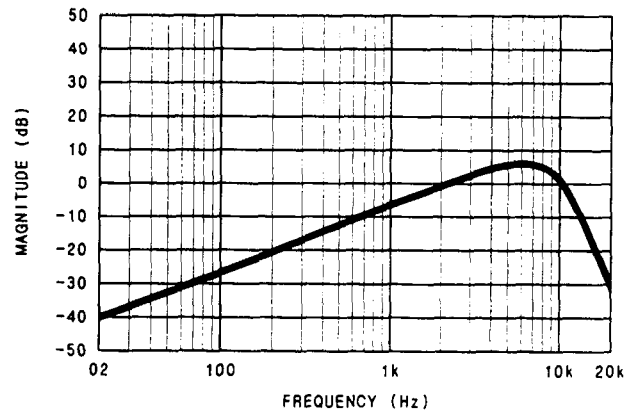


Figure 8B-31. CCIR/ARM Weighting Filter, A2TP3

SERVICE SHEET 3---A3 Notch Filter Assembly (Notch-Generating Circuits)**PRINCIPLES OF OPERATION****General**

This portion of the Notch Filter Assembly (A3) contains the basic notch-generating circuitry which includes two integrators, two sum amplifiers, and their control circuitry.

Integrators

The two integrators are nearly identical. A simplified diagram of an integrator is shown in Figure 8B-32. For Integrator 1, FETs Q30 through Q32 switch the feedback capacitors to change ranges. FETs Q14 through Q21 switch the input resistors to coarse tune the filter. The FETs are driven by the Notch Control Drivers whose control inputs come from the Controller via the Latch Assembly (see Service Sheets 12 and 13).

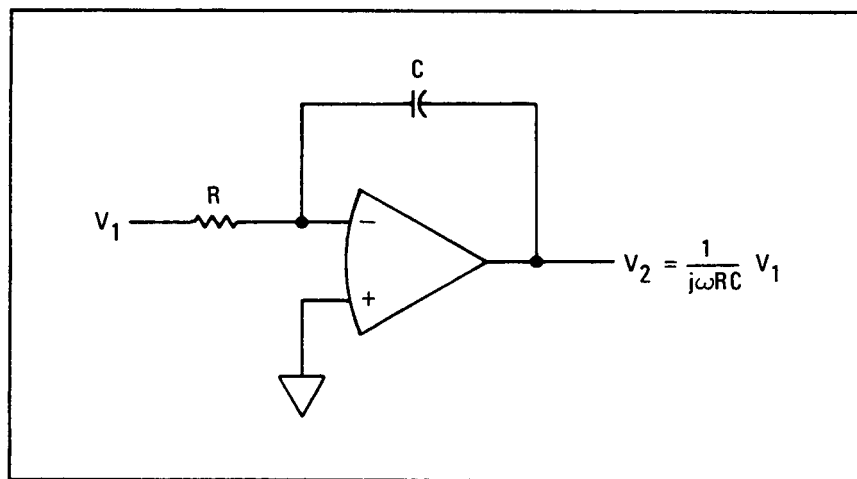


Figure 8B-32. Integrator Circuit

Sum Amplifiers

Sum Amplifiers 1 and 2 and the Sum and Output Amplifier sum various signals in the proportion and phase relationship required by the state-variable design. (See the discussion of the Notch Filter on Service Sheet BD2.) The Sum and Output Amplifier has inputs which are switched by FETs Q11 and Q12 to control the type of filter response, namely, notch, bandpass, or flat. Q13 is a resistive match for the resistance of Q11 or Q12. Sum Amplifier 2 injects the error signal from the notch Balance and Tune Multipliers to automatically fine balance and tune the Notch Filter (see Service Sheet 4). The FETs are driven by the Notch Control Drivers.

Pre-Notch RMS and Average Detectors

The Pre-Notch RMS and Average Detectors convert the ac signal at the input to the Notch Filter, but following the Weighting Bandpass and High-Pass Filters (see Service Sheet 2), to an equivalent dc voltage measured by the Voltmeter. The conversion can be either rms responding or average responding as selected by U19. U17 is the true rms converter. The Pre-Notch Average Detector is calibrated to output a dc voltage corresponding to the rms value of a sine-wave input.

The average-responding converter consists of U18A and associated components, which function as a full-wave rectifier, and U18B and associated components, which function as a low-pass filter. Full-wave rectification is produced by summing the half-wave-rectified current flowing through R100 with the un-rectified current flowing through R98. The rectified current is weighted twice as heavily as the un-rectified current since R100 is half the value of R98. Since U18A inverts as well as rectifies, the summing of currents is equivalent to a subtraction.

TROUBLESHOOTING

General

Procedures for checking the Notch Filter Assembly are given below. The circuits or points to check are marked on the schematic diagram by a hexagon with a check mark and a number inside for example, $\langle \checkmark 3 \rangle$. In addition, any points outside the labeled circuit area that must be checked are also identified. Fixed signals are shown on the schematic also inside a hexagon, for example, $\langle +1.9 \text{ TO } +2.1 \text{ VDC} \rangle$. Extend the board assembly where necessary to make measurements. These procedures assume that the source is working properly.

Equipment

Oscilloscope HP1740A

$\langle \checkmark 1 \rangle$ Notch Filter Check

1. On the Audio Analyzer, key in 41.0 SPCL to initialize the instrument. Press DISTN. Short pin 3 of U5 to A3TP1 (GND).
2. Connect a high-impedance, dc coupled oscilloscope to A3TP5 (BP OUT), A3TP6 (HP OUT), A3TP7 (OUT), and A3TP14 (LP OUT) one at a time. The dc offset level (superimposed on an ac signal) for each should be between -200 to $+200$ mVdc.
3. On the Audio Analyzer, remove the short at pin 3 of U5. Short A3TP3 (TUNE) and A3TP4 (BAL) both to A3TP1 (GND).
4. On the Audio Analyzer, set the INPUT and OUTPUT switches to ground. Key in AMPTD 2 V. Key in 1.11 SPCL to set the input gain to 0 dB. Connect the HIGH OUTPUT to the HIGH INPUT.
5. AC couple the oscilloscope and connect it to A2TP3 (OUT, see Service Sheet 2). Increment the Audio Analyzer's SOURCE amplitude to obtain exactly 6 Vpp on the oscilloscope.

Hint: The amplitude at A2TP3 should be approximately between 5 and 6 Vpp before adjustment. (The period should be approximately 1 ms.)

6. On the Audio Analyzer, key in the SOURCE frequency and Special Functions listed in Table 8B-20. For each setting, measure the waveforms at the test point indicated. The peak-to-peak amplitude should be within the limits indicated.

Hint: If the waveforms at A3TP14 only are faulty, check the Sum and Output Amplifier. See step 8 below.

Hint: If all waveforms are incorrect, check the Sum Amplifier, which should have a gain of 1 (from A3TP5 to pin 6 of U11) and Sum Amplifier 1.

Hint: If most of the waveforms are incorrect, check the control voltages listed in Table 8B-21. If the control signals are correct, measure the ac signal at the drains of FETs Q30 through Q35 at the corresponding SOURCE frequency (choose 1 kHz for 53.1 SPCL). The drain voltage should be 0 Vrms when the FET is on. If these signals are all correct, continue on with step 7.

7. On the Audio Analyzer, key in 53.1 SPCL. Key in the Special Functions and SOURCE frequencies listed in Table 8B-22. For each setting, measure the ac signal on the sources of FETs Q14 through Q29. A signal should appear on the source unless the FET is off; 0 Vrms should appear if the FET is on. If a signal is faulty, also check the control voltage listed in Table 8B-22.

Hint: If an attempt is made to switch on an FET which has failed to an open state, signals will usually appear on the sources of Q14 through Q21 but not Q22 through Q29.

8. On the Audio Analyzer, key in FREQ 1 kHz, 53.1 SPCL, and 54.147 SPCL. Connect the oscilloscope to A3TP7 (OUT).

Table 8B-20. Voltage at A3TP5, 6, 7, and 14, $\sqrt{1}$ Step 6

Special Functions	SOURCE Frequency (Hz)	Voltage Limits (Vpp) at			
		A3TP5	A3TP6	A3TP7	A3TP14
53.1 and 54.147	1 000	4.8 to 7.2	4.8 to 7.2	<1.2	4.8 to 7.2
	5 000	0.3 to 0.5	1.6 to 2.4	4.8 to 7.2	<0.1
	200	0.3 to 0.5	<0.1	4.8 to 7.2	1.6 to 2.4
53.0	125	4.8 to 7.2	4.8 to 7.2	<1.2	4.8 to 7.2
53.2	8 000	4.8 to 7.2	4.8 to 7.2	<1.2	4.8 to 7.2
53.3 and 54.108	47 000	4.8 to 7.2	4.8 to 7.2	<1.2	4.8 to 7.2

Table 8B-21. Voltage at A3U16, $\sqrt{1}$ Step 6 Hint

Special Function	Level (Vdc) U16 Pin			FETs On
	1	2	3	
53.0	0	-15	-15	Q31, Q34
53.1	-15	0	-15	Q30, Q33
53.2	-15	-15	0	Q32, Q35
53.3	-15	-15	-15	None

Table 8B-22. Levels at A3Q14 through A3Q29, $\sqrt{1}$ Step 7

Special Function	SOURCE Frequency (Hz)	FETs On	Level (Vdc) at U14 Pin				Level (Vdc) at U15 Pin			
			13	14	2	1	2	1	13	14
54.1	20	Q21, Q29	-15	-15	-15	-15	-15	-15	-15	0
54.2	20	Q20, Q28	-15	-15	-15	-15	-15	-15	0	-15
54.4	20	Q19, Q27	-15	-15	-15	-15	-15	0	-15	-15
54.8	50	Q18, Q26	-15	-15	-15	-15	0	-15	-15	-15
54.16	100	Q17, Q25	-15	-15	-15	0	-15	-15	-15	-15
54.32	200	Q16, Q24	-15	-15	0	-15	-15	-15	-15	-15
54.64	500	Q15, Q23	-15	0	-15	-15	-15	-15	-15	-15
54.128	1000	Q14, Q22	0	-15	-15	-15	-15	-15	-15	-15
54.255	2000	All	0	0	0	0	0	0	0	0

9. On the Audio Analyzer, key in the Special Functions listed in Table 8B-23. For each setting, the peak-to-peak amplitude, observed on the oscilloscope, should be within the limits indicated. If the signal is faulty, also check the control signals indicated.

10. See Service Sheet 4 and check the Notch Filter tune and balance.

$\sqrt{2}$ Pre-Notch RMS and Average Detectors Check

1. On the Audio Analyzer, key in 41.0 SPCL to initialize the instrument. Set the INPUT and OUTPUT switches to ground. Key in AMPTD 1 V. Key in 1.11 SPCL to set the input gain to 0 dB. Connect the HIGH OUTPUT to the HIGH INPUT.

Table 8B-23. Voltage at A3TP7, $\langle J1 \rangle$ Step 9

Notch Filter Mode	Special Function	Level at A3TP7 (Vpp)	Level (Vdc) at U10 Pin	
			1	2
Notch	44.1	<2.1	0	0
Flat	44.2	5.4 to 6.6	0	-15
Bandpass	44.3	4.8 to 7.2	-15	0

2. Connect a high-impedance, ac coupled oscilloscope to A2TP3 (OUT). The waveform should be 2.7 to 2.9 Vpp. (The period of the signal should be approximately 1 ms.)

Hint: If the signal is faulty, see Service Sheet 2 and check the Programmable Gain Amplifier.

3. Use the oscilloscope's vertical gain controls to adjust the waveform amplitude for 7.1 divisions peak-to-peak.

4. Connect the oscilloscope, dc coupled, to A3TP15 (RMS2). The dc level observed on the oscilloscope should be between 2.4 and 2.6 Vdc. Grounding pin 6 of U18B should have no effect.

Hint: Pin 15 of U19 should be a TTL low.

5. On the Audio Analyzer, key in 5.2 SPCL. The dc level observed on the oscilloscope should be between 2.4 and 2.6 Vdc. Grounding pin 6 of U18B should cause the voltage to be about -15 Vdc.

Hint: Pin 15 of U19 should be a TTL high.

SERVICE SHEET 4---A3 Notch Filter Assembly (Tune and Balance Circuits)**PRINCIPLES OF OPERATION****General**

This portion of the Notch Filter Assembly (A3) contains the notch balance and tune circuitry that improves the depth and tuning accuracy of the notch.

Chopper Circuits

The Tune Comparator and Chopper are driven by the signal from Integrator 2 (see Service Sheet 3). This signal is in quadrature with the fundamental of the input to the Notch Filter. The Balance Comparator and Chopper are driven by the signal from Integrator 1. This signal is in phase with the fundamental of the input to the Notch Filter. The Tune and Balance Comparators drive the chopper FETs (Q4 and Q5) so that they switch at the zero crossings of the comparator inputs. When the outputs of the comparators go high (for example, when their open-collector outputs shut off), the FETs switch on (short circuit) because the gates are grounded through R46 or R48. When the comparators go low, putting a large negative voltage at the FET gates, the FETs switch off.

The current from the Tune (or Balance) Chopper and the Inverting Amplifier are summed together at the inverting (-) input of the Tune (or Balance) Integrator. The chopper current is weighted by a factor of two because the path resistance from the chopper is about half of the path resistance from the Inverting Amplifier. When Gain Switch Q2 is off, the Tune Chopper's path resistance is R49 in series with R54; the Inverting Amplifier's path resistance is R60. When Q2 is switched on, the current in both paths increases by about a factor of ten. R55 is now in parallel with R54, and R58 with R60. This increases the Tune Integrator gain by a factor of ten and compensates for a 20 dB reduction in attenuation when Attenuator 1 is switched out (see Service Sheet 5). The action of the Balance Chopper is similar to the Tune Chopper.

Integrators and Multipliers

The sum current from the Tune Chopper and Inverting Amplifier is integrated by the Tune Integrator. The dc value of the sum current represents the tuning error of the Notch Filter. The integrator amplifies and filters the error current and drives the Tune Multiplier. The integration capacitors are switched for different frequency ranges to compensate for the resultant gain change with frequency. When the Notch Filter range is changed, FET Q1 is momentarily switched on to discharge the integration capacitor and speed up the tuning correction. Operation of the Balance Integrator is similar to the Tune Integrator. The tune and balance offset adjustments (R62 and R63) compensate for dc offsets in the filter to maximize the depth of the notch.

The Tune Multiplier receives a dc control input (the Y input) from the Tune Integrator and an ac input (the X input) from Integrator 1 (see Service Sheet 3). The sensitivity of the X input is set by R77, the Y input by R81, and the overall multiplier by R75 and R79. The output of the Tune Multiplier is a current which is summed directly with the current from the Balance Multiplier and applied to Sum Amplifier 2 (see Service Sheet 3). The dc level into the Tune Multiplier is also measured by the DC Voltmeter to give the Controller an indication of whether or not the Notch Filter is properly tuned.

TROUBLESHOOTING

General

Procedures for checking the Notch Filter Assembly are given below. The circuits or points to check are marked on the schematic diagram by a hexagon with a check mark and a number inside, for example, $\checkmark 3$. In addition, any points outside the labeled circuit area that must be checked are also identified. Fixed signals are shown on the schematic also inside a hexagon, for example, $+1.9 \text{ TO } +2.1 \text{ VDC}$. Extend the board assembly where necessary to make measurements. These procedures assume that the source is working properly.

Equipment

Oscilloscope HP 1740A

$\checkmark 1$ Notch Filter Tune and Balance Check

1. On the Audio Analyzer, key in 41.0 SPCL to initialize the instrument. Set the INPUT and OUTPUT switches to ground. Key in AMPTD 1 V. Key in 1.11 SPCL to set the input gain to 0 dB. Key in 3.1 SPCL to set the output gain to 0 dB. Key in 53.1 SPCL and 54.147 SPCL to tune the Notch Filter to 1 kHz. Connect the HIGH OUTPUT to the HIGH INPUT.

2. Connect a high-impedance, ac coupled oscilloscope to A4TP8 (AMP 1, see Service Sheet 5). The waveform should be between 1.1 and 1.7 Vpp. (The period of the signal should be approximately 1 ms.)

Hint: If the signal is faulty, see Service Sheet 3 and check the Notch Filter and Service Sheet 5 and check Attenuator 1 and Amplifier 1.

3. Connect the oscilloscope to A3TP2 (NOTCH AMP). The waveform should be between 12 and 19 Vpp.

4. DC couple the oscilloscope and connect it to A3TP4 (BAL). The dc level should be between -5 and -4 Vdc.

Hint: Pin 7 of U8B should be a 0 to -15 V square wave with a period of 1 ms. The source of Q4 should be a positive, half-wave-rectified sine wave. Pin 6 of U1 should be a sine wave with an amplitude of 12 to 19 Vpp. Pin 14 of U16D should be -15 V; Q8 should be off.

5. On the Audio Analyzer, key in 44.3 SPCL to set the Notch Filter to the bandpass mode. The dc level should be between +4 and +5 Vdc.

Hint: A3TP2 should be a sine wave with an amplitude of 10 to 21 Vpp. If faulty, see Service Sheet 3 and check the Notch Filter.

Hint: Pin 7 of U8B should be a 0 to -15 V square wave with a period of 1 ms. The source of Q4 should be a negative, half-wave-rectified sine wave.

6. Connect the oscilloscope to A3TP3 (TUNE). On the Audio Analyzer, key in 44.2 SPCL to set the Notch Filter to the flat mode. Key in FREQ 500 Hz. The dc level should be between +4 and +5 Vdc.

Hint: Pin 1 of U8A should be a 0 to -15 V square wave with a period of 2 ms. The source of Q5 should be a negative, half-wave-rectified sine wave. Q1 should be off.

7. On the Audio Analyzer, key in FREQ 2 kHz. The dc level should be between -5 and -4 Vdc.

Hint: Pin 1 of U8A should be a 0 to -15 V square wave with a period of 0.5 ms. The source of Q5 should be a positive, half-wave-rectified sine wave.

8. On the Audio Analyzer, key in 0.56 S (Shift) 3 SPCL to discharge the Tune and Balance Integrators. The dc level should be between -50 and +50 mVdc.

Hint: Pin 14 of U16D should be 0 Vdc; Q1 should be on.

9. Connect the oscilloscope to A3TP4. The dc level should be between -50 and +50 mVdc.

Hint: Q8 should be on.

10. On the Audio Analyzer, key in 0.565 SPCL to disable the discharge of the Tune and Balance Integrators. Connect one channel of the oscilloscope (ac coupled) to A3TP5 and the other channel to pin 2 of U9. Trigger the oscilloscope from the signal on A3TP5 (BP OUT). The two signals should be in phase. (The signal to pin 2 of U9 should have an amplitude of approximately 100 mVpp.)

11. On the Audio Analyzer, key in FREQ 500 Hz. The two signals should be approximately 180° out of phase.

12. On the Audio Analyzer, key in FREQ 1 kHz. Move the oscilloscope from A3TP5 to A3TP6 (HP OUT) and from pin 2 of U9 to pin 2 of U4. The two signals should be in phase.

13. On the Audio Analyzer, key in 44.3 SPCL. The two signals should be approximately 180° out of phase.

14. On the Audio Analyzer, key in 44.2 SPCL. Connect the oscilloscope to the source of Q2. The waveform should have an amplitude of less than 200 mVpp.

Hint: Pin 14 of U10D should be 0V. Q2 should be on.

15. On the Audio Analyzer, key in AMPTD 100 mV. Key in 3.3 SPCL to set the Gain Switch off. The waveform should be a sine wave with a phase reversal at each peak and have an amplitude of approximately 5 Vpp.

Hint: Pin 14 of U10D should be -15V. Q2 should be off.

Hint: The signal at A3TP2 should be a sine wave with an amplitude of 16 Vpp. If faulty, see Service Sheet 5 and check Attenuator 1.

16. Connect the oscilloscope to the source of Q3. The waveform should be a positive, full-wave-rectified sine wave with an amplitude of approximately 2 Vpp.

Hint: Q3 should be off.

17. On the Audio Analyzer, key in 3.1 SPCL. Key in AMPTD 1 V. The signal amplitude should be less than 500 mVpp.

Hint: Q3 should be on.

NOTE

The following steps check the overall performance of the Notch Filter at various frequencies. The notch circuitry of Service Sheet 3 is assumed to be operating properly, and the source is assumed to have less than 0.01% distortion and noise. If distortion is high on all ranges, perform the Notch Filter Tune and Balance Adjustment, paragraph 5-12, and also check the distortion of the Output Amplifier 1, see Service Sheet 5.

18. On the Audio Analyzer, press DISTN. Key in AMPTD 2.5 V. Key in 44.1 SPCL to set the Notch Filter to the notch mode. Key in 3.0 SPCL to set the output amplifier gain to automatic. The amplitude display should read 0.01% or less.

Hint: The gates of Q7 and Q9 should be 0V and the FETs should be on. The gates of Q6 and Q10 should be -15V and the FETs should be off. The signal at A3TP7 (OUT) should be less than 100 mVpp.

19. On the Audio Analyzer, key in 54.139 SPCL. Note the amplitude display. Key in 54.155 SPCL. Note the amplitude display. In both cases the display should be 0.01% or less.

20. On the Audio Analyzer, key in FREQ 20 Hz. Key in 53.0 SPCL and 54.23 SPCL to tune the Notch Filter to 20 Hz. The amplitude display should be 0.01% or less.

Hint: The gates of Q6 and Q10 should be 0V and the FETs should be on. The gates of Q7 and Q9 should be -15V and the FETs should be off. The signal at A3TP7 should be less than 100 mVpp.

21. On the Audio Analyzer, key in **FREQ 10 kHz**. Key in **53.2 SPCL** and **54.184 SPCL** to tune the Notch Filter to 10 kHz. The amplitude display should be 0.01% or less.

Hint: The gates of Q6, Q7, Q9, and Q10 should be $-15V$ and the FETs should be off. The signal at A3TP7 should be less than 100 mVpp.

22. On the Audio Analyzer, key in **FREQ 20 kHz**. Key in **53.3 SPCL** and **54.46 SPCL** to tune the Notch Filter to 20 kHz. The amplitude display should be 0.01% or less.

Hint: See the hint for step 21.

SERVICE SHEET 5---A4 Output Amplifier/Voltmeter Assembly (Output Amplifier)**PRINCIPLES OF OPERATION****General**

This portion of the Output Amplifier/Voltmeter (A4) contains the output amplifier circuitry. The output from the Notch Filter is amplified, attenuated, and filtered as necessary to obtain a proper output reading by the Output RMS/Average Detector (see Service Sheet 6). The ac output of the amplifier is available at the rear-panel MONITOR output connector.

Attenuators and Amplifiers

Attenuators 1 and 2 can each be set for an attenuation of 0 or 20 dB. They are switched together. The attenuator control line, OU AMP1, switches in the 0 dB path of Attenuators 1 and 2 indirectly through U21D, which acts as an isolating switch and a logic inverter. When the control input (F4) to U21D is high, U21D is off; F1 of U21A and F3 of U7C are pulled to ground via R11, and the respective switches are enabled. When F4 of U21D is low, U21D is on; resistors R2, R5, and R11 form a voltage divider which applies a logical high to F1 of U21A and F3 of U7C, and the respective switches are disabled.

Amplifier 1 has a fixed gain of 5. Amplifiers 3 and 4 each have a fixed gain of 10. The Output Clamp in Amplifiers 3 and 4 accesses the driver stage of the respective IC and prevents the output from exceeding +12 or -12V. The output from Amplifier 1 drives the Low-Pass Filters and the Notch Filter tune and balance circuitry (see Service Sheet 4). Amplifier 4 drives the MONITOR output connector and is protected against the application of reverse voltage by R53 (which acts as a fuse), CR8, and CR9. A12L1 and C1 form an RFI filter.

Filters

The three Low-Pass Filters are 30, 80, and 750 kHz, three-pole, active Butterworth filters. The passband gain of each filter is 2. The active element of the filter, U8, has an Output Clamp similar to U6 and U13. The filters are switched via U9.

The two High-Pass Filters are respectively a 0.3 Hz, single-pole, passive filter and a 13 Hz, three-pole, active filter. Switching is via K1. CR3 suppresses the inductive transient created by the coil of K1 when the current is interrupted.

TROUBLESHOOTING

General

Procedures for checking the Output Amplifier/Voltmeter Assembly are given below. The circuits or points to check are marked on the schematic diagram by a hexagon with a check mark and a number inside, for example, $\langle \checkmark 3 \rangle$. In addition, any points outside the labeled circuit area that must be checked are also identified. Fixed signals are shown on the schematic also inside a hexagon, for example, $\langle +1.9 \text{ TO } +2.1 \text{ VDC} \rangle$. Extend the board assembly where necessary to make measurements. These procedures assume that the source is working properly.

Equipment

Oscilloscope HP 1740A

$\langle \checkmark 1 \rangle$ Attenuators, Amplifiers, and Low-Pass Filters Check

1. On the Audio Analyzer, key in 41.0 SPCL to initialize the instrument. Set the INPUT and OUTPUT switches to ground. Key in AMPTD 100 mV. Key in 1.11 SPCL to set the input gain to 0 dB. Connect the HIGH OUTPUT to the HIGH INPUT.

2. Connect a high-impedance, ac coupled oscilloscope to A3TP7 (OUT). Increment the Audio Analyzer's SOURCE amplitude for exactly 300 mVpp on the oscilloscope.

Hint: The amplitude at A3TP7 before adjustment should be between 260 and 300 mVpp. (The period should be approximately 1 ms.) If the signal is faulty, see Service Sheet 3 and check the Notch Filter.

3. Connect the oscilloscope to A4TP8 (AMP 1). On the Audio Analyzer, key in the Special Functions listed in Table 8B-24. For each setting, the amplitude of the signal observed on the oscilloscope should be within the limits indicated. If the signal is faulty, also check the control signals indicated.

Table 8B-24. Level at A4TP8, $\langle \checkmark 1 \rangle$ Step 3

Special Function	Level at A4TP8 (mVpp)	Level (TTL) at U21 Pin		
		1	8	16
3.1	140 to 160	H	L	L
3.3	1400 to 1600	L	H	H

Hint: Amplifier 1 should have a gain of 5.

4. Connect the oscilloscope to A4TP6 (AMP 2). On the Audio Analyzer, set the LOW PASS FILTER to 80 kHz, 30 kHz, and all off. For each setting, the waveform should have an amplitude between 2.7 and 3.3 Vpp.

Hint: The control signals are as shown in Table 8B-25.

Table 8B-25. Levels at A4U9, $\langle \checkmark 1 \rangle$ Step 4 Hint

LOW PASS FILTER On	Level (TTL) at U9 Pin		
	1	8	9
80 kHz	H	L	H
30 kHz	H	H	L
None	L	H	H

5. On the Audio Analyzer, key in the SOURCE frequency and LOW PASS FILTER listed below. For each setting, the waveform should be within the limits indicated in Table 8B-26.

Table 8B-26. Limits at A4TP6, $\langle J1 \rangle$ Step 5

SOURCE Frequency (kHz)	LOW PASS FILTER On	Level at A4TP6 (Vpp)
100	None	2.5 to 3.3
80	80 kHz	1.7 to 2.6
30	30 kHz	1.7 to 2.6

Hint: See the hint for step 4.

6. On the Audio Analyzer, key in **FREQ 1 kHz**. Set **LP FILTER** to **80 kHz**. Reduce the **SOURCE** amplitude for a waveform amplitude of **1.2 Vpp**.

7. Connect the oscilloscope to **A4TP5 (AMP 3)**. The waveform should be between **11.5 and 12.5 Vpp**.

Hint: Pin 9 of **U7** should be a **TTL low**. Pin 1 of **U7** should be a **TTL high**. Amplifier 3 should have a gain of **10**.

8. On the Audio Analyzer, key in **3.1 SPCL**. The waveform should be between **110 and 130 mVpp**.

Hint: Pin 9 of **U7** should be a **TTL high**. Pin 1 of **U7** should be a **TTL low**.

9. Connect the oscilloscope to **A4TP4 (AMP 4)**. The waveform should be between **110 and 130 mVpp**.

Hint: Pin 8 of **U7** should be a **TTL high**. Pin 16 of **U7** should be a **TTL low**. The **Buffer (U14B)** and **High-Pass Filters** should each have a gain of **1**. Amplifier 4 should have a gain of **10**.

10. On the Audio Analyzer, key in **3.2 SPCL**. The waveform should be between **1.1 and 1.3 Vpp**.

Hint: Pin 8 of **U7** should be a **TTL low**. Pin 16 of **U7** should be a **TTL high**.

11. On the Audio Analyzer, key in **55.0 SPCL**, **56.15 SPCL**, and **57.140 SPCL** to set the **SOURCE** frequency to **13 Hz**. The waveform should be between **1.1 and 1.3 Vpp**.

Hint: Pin 1 of **K1** should be a **TTL low**. Pins 3 and 4 of **K1** should be shorted.

12. On the Audio Analyzer, key in **0.435 SPCL** to insert the **13 Hz High-Pass Filter (U14A and associated components)**. The waveform should be between **0.7 and 1.0 Vpp**.

Hint: Pin 1 of **K1** should be a **TTL high**. Pins 3 and 5 of **K1** should be shorted. The waveform at pin 1 of **U14A** should be between **80 and 130 mVpp**.

SERVICE SHEET 6—A4 Output Amplifier/Voltmeter Assembly (Detector and Meter Circuits)

PRINCIPLES OF OPERATION

General

This portion of the Output Amplifier/Voltmeter (A4) contains the Output RMS/Average/Quasi-peak Detector, Output Overload Detector, and SINAD meter circuitry.

Output RMS/Average/Quasi-peak Detector

The circuits on the upper half of the schematic diagram form the Output RMS/Average/Quasi-peak Detector referred to in the block diagrams. When used as a true rms converter, the Output RMS/Average/Quasi-peak Detector converts the ac input signal into a dc voltage equal to the root mean square (rms) of the input level. The circuits form an analog computer which converts the ac signal to its dc rms equivalent by a method called implicit conversion. The analog computer performs logging, antilogging, squaring, averaging, and dividing mathematical functions. When used as an average-responding converter, the Output RMS/Average/Quasi-peak Detector converts the ac input signal into a dc voltage equal to the absolute average (that is, full-wave rectified and filtered) of the input level but calibrated to the rms value of a sine wave. When used as a quasi-peak converter, the Output detector converts the ac signal to its dc quasi-peak equivalent. This type of detector has a fast rise time coupled with a slow decay time constant which "captures" impulses or other signals with a high crest factor (noise or repetitive signal bursts).

Refer to Figure 8B-33, which is a simplified diagram of the circuit showing only the components which produce the rms conversion. Since the log-antilog circuit cannot operate on a bi-directional signal, the input is full-wave rectified. Full-wave rectification is accomplished by half-wave rectifying (and inverting) the input, then summing the rectified current with a current proportional to the input voltage but weighted by one half. U5, R55, R62, and CR11 perform the half-wave rectification. The rectified signal produces a current (I_1) in R71 which is summed with the current (I_2) in R70 at the inverting (-) input to U4. R70 is twice the resistance of R71.

U4, Q2A, and Q1A form the Log Amplifier. The full-wave-rectified current ($I_3 = I_1 + I_2$) flows through transistors Q2A and Q1A and into the output of U4. (Q2A is a common-base stage; Q1A is configured as a diode.) The current (I_3) through Q2A and Q1A produces a voltage across each base-emitter junction proportional to the log of the current. The sum of the two base-emitter voltages (V_1) is the sum of two nearly identical logarithms and is proportional to the log of the square of the current ($\log I_3^2$) and hence the log of the square of the input voltage ($\log V_{IN}^2$). (The identity used here is: $\log I + \log I = \log (I \times I) = \log I^2$.)

Now consider the operation of the Filter Amplifier, which also functions as an antilog circuit. The collector current (I_4) of Q1B is filtered by U3 and the associated resistors and capacitors (R90, R91, R92, R94, C53, and C56). The dc component of this current flows through R90, R91, and R92 and produces a voltage which, when buffered by U2, is the output (V_{OUT}) of the circuit. (The effects of R93 and R95 in the schematic are being momentarily ignored.) U3 also holds the collector of Q1B at ground potential to establish the offset of the output at 0V. The collector current (I_5) of Q2B is generated by the output voltage (V_{OUT}), which appears across R98. U12 holds the collector of Q2B and one end of R98 at ground potential.

The voltage across the base-emitter junctions of Q1B and Q2B is proportional to the log of their respective collector currents. The sum of the two base-emitter voltages (V_1) is proportional to the log of the product of the two collector currents ($I_4 \times I_5$). Since the sum of the base-emitter voltages of Q1B and Q2B equals the sum of Q1A and Q2A, the products of the respective collector currents are equal ($I_3^2 = I_4 \times I_5$). Recalling that the dc component of I_4 produced the output voltage (V_{OUT}) and that the output voltage produced I_5 , it is evident that the output voltage is proportional to the square root of the product of I_4 and I_5 and thus is proportional to the input voltage (V_{IN}), which has been squared, filtered (to obtain the mean level), and the square root obtained.

Refer now to the schematic diagram, Figure 8B-117 (SS6). The switches of U23 and U25 control whether the detector functions as a true rms, average or quasi-peak responding converter. The switch modes are cataloged in Table 8B-27.

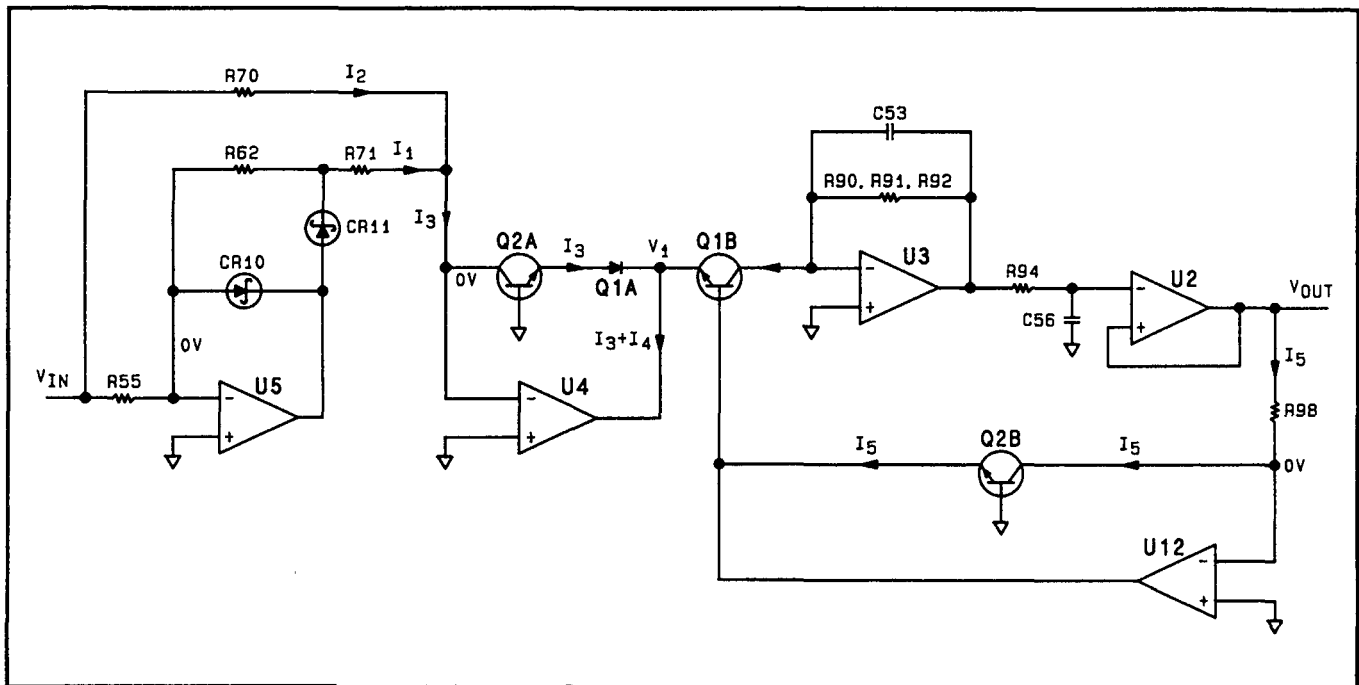


Figure 8B-33. Simplified Diagram of the Output RMS/ Detector

Table 8B-27. Detector Switching Modes

Detector Mode	State of			
	U23A, U23C, U24A, U24C	U23B, U23D, U24B, U24D	U25A, U25B, U25C	U25D
True RMS	Open	Closed	Open	Closed
Average	Closed	Open	Open	Closed
Quasi-peak	Closed	Open	Closed	Open

In the average-responding converter mode, full-wave rectification of the input signal is performed by U5 as with the true rms converter. But current summing is via R158, R157, and U22. Filtering is done via the Filter Amplifier but bypassing the antilogging function.

R143 and R144 are installed whenever the offset adjustment R85 has insufficient range. CR13 and CR16 protect the log and antilog transistors should offset voltages of opposite polarity be applied to them. CR14 provides an offset voltage in the collector of Q1B that matches the offset created by the base-emitter junction of Q2A in the collector of Q1A. R93 and R95 improve the response characteristics of the circuit to low frequency inputs while at the same time allow the circuit to respond rapidly to changes in input level. R91 permits fine adjustment of the gain of the circuit. R94 and C56 also form the first real pole in the Ripple Filter (see Service Sheet 7).

In the quasi-peak converter mode, full-wave rectification of the input signal is performed by U5 with current summing via R202 and R203. The quasi-peak converter consists of two peak detector stages in series. Stage 1, which consists of U26, U27A (Buffer) and associated components is an inverting, positive peak detector which has a charge rate of ≤ 2 ms (determined by R202 and C1) and a discharge rate of approximately 400 ms (R205, C1). Stage 2, which consists of U28, U27B (Buffer) and associated components is an inverting, negative peak detector which has a charge rate of approximately 200 ms (determined by R208 and C2), and a discharge rate of approximately 600 ms (R210, C2).

SINAD Meter Circuits

The SINAD meter displays the log of the Pre-Notch RMS/Average Detector minus the log of the Output RMS/Average/Quasi-peak Detector. The Pre-Notch RMS/Average Detector produces a current which flows through R57 and logging transistor Q4A. The voltage developed across the base-emitter junction of Q4A is proportional to the log of its collector current. Similarly, the Output RMS/Average/Quasi-peak Detector produces a current which flows through R56 and logging transistor Q4B and develops a base-emitter voltage proportional to the log of its collector current. The voltage at the base of Q4A (with respect to ground) is equal to the difference between the base-emitter voltages of Q4A and Q4B. The feedback amplifier, Q17C, amplifies this difference and produces the output. Note that the collectors and bases of both Q4A and Q4B are all biased near ground potential. Thermistor RT1 thermally compensates for the drift of the two logging transistors.

The voltage from the SINAD Log Ratio Meter Amplifier is converted to a current by the Meter Transconductance Amplifier which drives the meter. CR15 protects the meter against reverse current. R83 and C51 add heavy filtering to the often noisy SINAD measurement signal.

The Meter Peg/Off Switch receives commands from the Controller via the Latch Assembly which enable, gently peg, or switch off the meter via the Meter Transconductance amplifier, depending on the measurement being made and the SINAD measurement range. A low at the inverting (–) input of U19A or U19B switches the respective output FET (Q6 or Q5) on pulling the output connection to either ground or +2.4V.

Output Overload Detector

The Output Overload Detector compares the level from the Output RMS/Average/Quasi-peak Detector to a reference set by R60 and R61. If the level exceeds the reference, U19D switches FET Q7 on which resets the Overload Flip-Flop (see Service Sheet 12) and reduces the gain of the Output Amplifier to 0 dB.

TROUBLESHOOTING

General

Procedures for checking the Output Amplifier/Voltmeter Assembly are given below. The circuits or points to check are marked on the schematic diagram by a hexagon with a check mark and a number inside, for example, $\sqrt{3}$. In addition, any points outside the labeled circuit area that must be checked are also identified. Fixed signals are shown on the schematic also inside a hexagon, for example, \diamond . Extend the board assembly where necessary to make measurements. These procedures assume that the source is working properly.

Equipment

Digital Voltmeter HP 3455A
 Oscilloscope HP 1740A

$\sqrt{1}$ Output RMS/Average/Quasi-peak Detector General Check

1. On the Audio Analyzer, key in 41.0 SPCL to initialize the instrument. Set the INPUT and OUTPUT switches to ground. Key in AMPTD 3 V. Key in 1.11 SPCL to set the input gain to 0 dB. Key in 3.1 SPCL to set the output gain to 0 dB. Connect the HIGH OUTPUT to the HIGH INPUT.

2. Connect a voltmeter to A4TP4 (AMP 4). Set the voltmeter to measure ac. Fine adjust the Audio Analyzer's SOURCE amplitude for 2.99 to 3.01 Vrms on the voltmeter.

Hint: The amplitude at A4TP4 before adjustment should be between 2.85 and 3.15 Vrms. If the signal is faulty, see Service Sheet 5 and check the Output Amplifier circuitry.

3. Connect the voltmeter to A4TP1 (DC OUT). Set the voltmeter to measure dc. The level on the voltmeter should be between +2.94 and +3.06 Vdc. Grounding pin 2 of U22 should have no effect.

Hint: Pin 10 of U23 should be a TTL low. U23B, U23D, U24B, and U24D should be on. U23A, U23C, U24A, and U24C should be off.

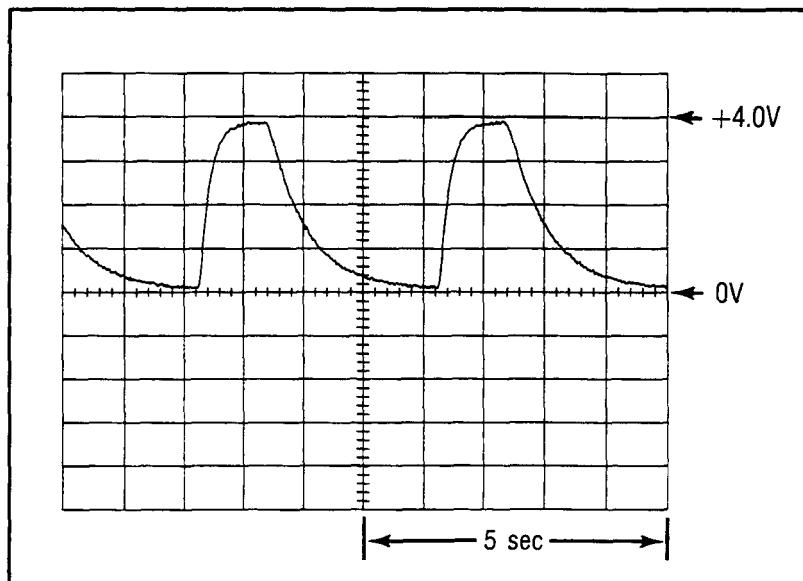


Figure 8B-33.1. Waveform at A4TP1, $\sqrt{1}$ Step 12

Hint: If the signal amplitude is only slightly out of limits, perform the *Voltmeter Adjustment*, paragraph 5-13; if greatly out of limits, perform the $\sqrt{2}$ *Full-Wave Rectifier Check* and the $\sqrt{3}$ *Log Amplifier and Filter Amplifier Check*.

4. Key in 5.2 SPCL to switch the detector to average. The level on the voltmeter should be between +2.94 and +3.06 Vdc. Grounding pin 2 of U22 should cause the level to go to approximately -15 Vdc.

Hint: Pin 10 of U23 should be a TTL high. U23B, U23D, U24B, and U24D should be off. U23A, U23C, U24A, and U24C should be on.

5. Reconnect the voltmeter to A4TP4. Set the voltmeter to measure ac. On the Audio Analyzer, reduce the SOURCE amplitude for a reading between 299 and 301 mVrms on the voltmeter.

6. Reconnect the voltmeter to A4TP1. Set the voltmeter to measure dc. The level on the voltmeter should be between +294 and +306 mVdc.

Hint: If the signal is only slightly out of limits, perform the *Voltmeter Adjustment*, paragraph 5-13; if within limits, the detector is functioning properly under the current test conditions.

7. Key in 5.0 SPCL to switch the detector to rms. The level on the voltmeter should be between +294 and +306 mVdc.

8. Reconnect the voltmeter to A4TP4. Set the voltmeter to measure ac. On the Audio Analyzer, increase the SOURCE amplitude for a reading between 2.99 and 3.01 Vrms on the voltmeter.

9. Key in 5.7 SPCL to switch the detector to quasi-peak. Hint: Pin 3 of U29 should be a TTL low. U25A, U25B and U25C should be on, U25D should be off and U23 and U24 should be in the same state as for the average detector. See hint for step 4.

10. Reconnect the voltmeter to A4TP1. Set the voltmeter to measure dc. The level on the voltmeter should be between 2.94 and 3.06 Vdc. Hint: See the hint for step 6.

11. Disconnect the voltmeter. Connect a high-impedance, dc-coupled oscilloscope to A4TP1. Use the oscilloscope's vertical gain controls to adjust the display amplitude for 4 division peak deflections of the dc signal. Hint: Set the ground to the center of the display. Set sweep time to 1 sec/div. Hint: See the hint for step 6.

12. On the Audio Analyzer, press S (Shift) SIG/NOISE. The waveform should be as shown in Figure 8B-33.1. Note rise and fall times.

$\sqrt{2}$ Full-Wave Rectifier Check

1. On the Audio Analyzer, key in 41.0 SPCL to initialize the instrument. Set the INPUT and OUTPUT switches to ground. Key in AMPTD 3 V. Key in 1.11 SPCL to set the input gain to 0 dB. Key in 3.1 SPCL to set the output gain to 0 dB. Connect the HIGH OUTPUT to the HIGH INPUT.

2. Connect a high-impedance, dc coupled oscilloscope to A4TP4 (AMP 4). On the Audio Analyzer, fine adjust the SOURCE amplitude for 8.5 Vpp on the oscilloscope.

Hint: The amplitude at A4TP4 before adjustment should be approximately 8.5 Vpp. If the signal is faulty, see Service Sheet 5 and check the Output Amplifier circuitry.

3. Connect the oscilloscope to pin 6 of U5. The waveform should be as shown in Figure 8B-34. (Note: Excessive input capacitance of the oscilloscope may cause oscillation. Use a divide-by-ten probe.)

4. Connect the oscilloscope to A4TP11 (RECT). The waveform should be a negative full-wave-rectified sine wave with a peak amplitude between -4.5 and -4.0V.

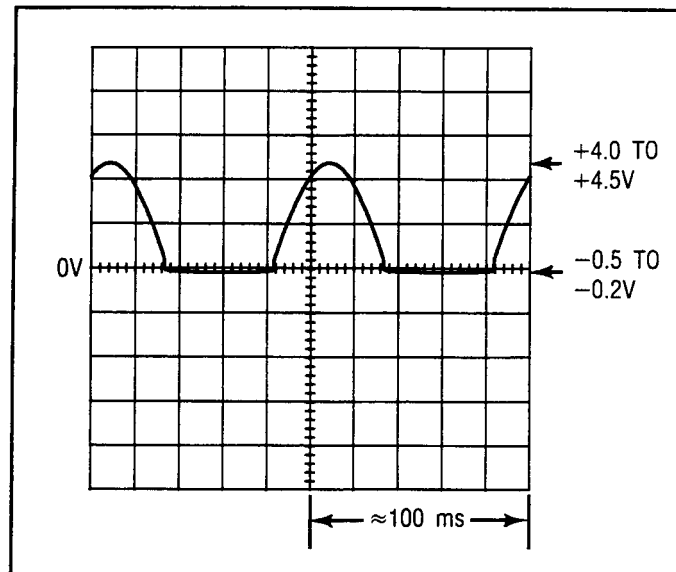


Figure 8B-34. Waveform at Pin 6 of U5, $\sqrt{2}$ Step 3

$\sqrt{3}$ Log Amplifier and Filter Amplifier Check

1. On the Audio Analyzer, key in 41.0 SPCL to initialize the instrument. Set the INPUT and OUTPUT switches to ground. Key in AMPTD 3 V. Key in 1.11 SPCL to set the input gain to 0 dB. Key in 3.1 SPCL to set the output gain to 0 dB. Connect the HIGH OUTPUT to the HIGH INPUT.

2. Connect a high-impedance, dc coupled oscilloscope to the cathode of CR11. The waveform should be a half-wave-rectified sine wave with a peak amplitude between +4.0 and +4.5V. (The period should be approximately 1 ms.)

Hint: If the signal is faulty, perform the *Full-Wave Rectifier Check*.

3. Connect the voltmeter to A4TP2 (LOG AMP). Set the voltmeter to measure dc. The voltmeter should read between -1.26 and -1.21 Vdc. (This voltage is valid only at room temperature.)

4. Connect the voltmeter to pin 6 of U4. The voltage should be approximately -2.3 Vdc.

Hint: If the voltage is closer to -2.0 Vdc, the Log Amplifier is operating properly but no current is flowing in the emitter of Q1B; the fault is in the Filter Amplifier. If the voltage is closer to -3.0 Vdc, the Log Amplifier is operating properly but no current is flowing in the collector of Q1B; the fault is in the Filter Amplifier. (The fault is probably causing the output of U12 to be clamped to +0.5 Vdc, whereas, it is normally negative.)

5. On the Audio Analyzer, key in 5.2 SPCL to set the detector to average. (This isolates the Amplifier Filter from the Log Amplifier.) Connect the oscilloscope to A4TP11 (RECT). The waveform should be a negative, full-wave-rectified sine wave with a peak amplitude between -4.5 and -4.0V.

Hint: If the signal is faulty, perform the *Full-Wave Rectifier Check*.

6. Connect the voltmeter to A4TP1 (DC OUT). The voltmeter should read between +2.9 and +3.3 Vdc.

Hint: Pin 6 of U3 should also be between +2.9 and +3.3 Vdc and read the same as A4TP1.

7. Connect the voltmeter to pin 6 of U12. The voltmeter should read between -2.5 to -2.0 Vdc.

Hint: The emitter of Q2B should be approximately -640 mVdc.

Hint: At this point, operation of the Filter Amplifier has been verified except for Q1B, CR14, U23, U24, and the filtering capability of the circuit. Check U23 and U24 by performing the $\sqrt{1}$ *Output RMS/Average/Quasi-peak Detector General Check*.

$\sqrt{4}$ SINAD Meter Circuits Check

1. On the Audio Analyzer, key in 41.0 SPCL to initialize the instrument. Set the INPUT and OUTPUT switches to ground. Key in AMPTD 1 V. Key in 1.11 SPCL to set the input gain to 0 dB. Key in 3.1 SPCL to set the output gain to 0 dB. Key in 45.1 SPCL to enable the SINAD meter. Connect the HIGH OUTPUT to the HIGH INPUT.

2. Connect a dc voltmeter to A3TP15 (RMS2). On the Audio Analyzer, fine adjust the SOURCE amplitude for a reading of $+1.00$ Vdc on the voltmeter.

Hint: The voltage at A3TP15 should read approximately 1 Vdc before adjustment. If it does not, see Service Sheet 3 and check the Pre-Notch RMS Detector.

3. Connect the voltmeter to A4TP1 (DC OUT). The voltage should read between $+0.99$ and $+1.01$ Vdc.

Hint: If the voltage is out of limits, perform the *Output RMS/Average/Quasi-peak Detector General Check*.

4. Insert a 31.6 k Ω resistor in parallel with R56. This simulates a 6 dB SINAD.

5. Connect the voltmeter to pin 14 of U17C. The voltage should be between $+320$ and $+360$ mVdc.

Hint: The voltage at pins 3 and 5 of Q4 should be between -500 and -480 mVdc.

6. Connect the voltmeter to pin 5 of U17B. The voltage should be the same as in step 5 except that the loading of a 10 M Ω voltmeter input will cause the signal level to be 0.3% low. The SINAD meter should read between 5.5 and 6.5 dB.

Hint: The drains of Q5 and Q6 should read the same as pin 5 of U17B. Q5 and Q6 should be off. Pins 4 and 6 of U19 should be a TTL high.

Hint: If the meter reads only slightly out of limits, perform the *SINAD Meter Adjustment*, paragraph 5-14.

7. On the Audio Analyzer, key in 0.528 SPCL to switch the SINAD meter off. The voltage at pin 5 of U17B should read 0 to $+10$ mVdc. The SINAD meter should read 0.

Hint: Q6 should be on. Pin 4 of U19A should be a TTL low. Pin 6 of U19B should be a TTL high.

8. On the Audio Analyzer, key in 0.524 SPCL to peg the meter. The voltage at pin 5 of U17B should read between $+1.5$ and $+2.5$ Vdc. The SINAD meter should read slightly above full scale.

Hint: Q5 should be on. Pin 6 of U19B should be a TTL low. Pin 4 of U19A should be a TTL high.

$\sqrt{5}$ Overload Detector Check

1. On the Audio Analyzer, key in 41.0 SPCL to initialize the instrument. Set the INPUT and OUTPUT switches to ground. Key in AMPTD 4 V. Key in 1.11 SPCL to set the input gain to 0 dB. Key in 3.1 SPCL to set the output gain to 0 dB. Connect the HIGH OUTPUT to the HIGH INPUT.

2. Connect a high-impedance, dc coupled oscilloscope to the drain of Q7. The level should be a TTL high.

Hint: Pin 13 of U19D should be between -15.2 and -14.7 Vdc.

3. On the Audio Analyzer, key in AMPTD 4.2 V. The level should be a TTL low.

Hint: Pin 13 of U19D should be between 0 and $+200$ mVdc.

SERVICE SHEET 7---A4 Output Amplifier/Voltmeter Assembly (Ripple Filters, Voltmeter Input Selector, and Voltage-to-Time Converter)**PRINCIPLES OF OPERATION****General**

This portion of the Output Amplifier/Voltmeter (A4) contains the Voltmeter Input Selector, the Voltage-to-Time Converter, and several input ripple filters.

Ripple Filters

Several of the dc inputs to the Voltage-to-Time Converter are filtered to remove ripple and noise. This gives a smoother-reading display. The line from the Differential-to-Single-Ended Amplifier (see Service Sheet 1), from which dc level is read in the dc level measurement mode, is filtered by the passive filter consisting of R118, C65, and C66. CR23 and CR24 are needed to prevent reverse voltages from damaging the electrolytic capacitors, C65 and C66, since the input voltage can be of either polarity. Passive filter R116 and C67 heavily filters the line from the Output RMS/Average Detector in the SINAD measurement.

The Ripple Filter, consisting of U10C and associated components, provides a complex impedance across the line from the Output RMS/Average Detector and gives two poles of high-frequency rolloff. The output is buffered by U1. A similar Ripple Filter (U10D and associated components) filters the line from the Input RMS or Average Detector. It is a more complex filter, having an extra real pole. The output is buffered by U10A.

Diodes CR17 through CR22 protect the inputs to the Voltmeter Input Selector against high or reverse voltages.

Voltmeter Input Selector

Multiplexer U18 forms an eight-pole, single-throw switch. The multiplexer is always enabled by the high on the EN input. The Detector Select Switches (U9B and U21C) selects between the Input Range Detector and the Input RMS/Average Detector. To change a switch setting, the Controller issues the appropriate code to the Instrument Bus. The code is decoded and latched on the Latch Assembly (see Service Sheet 12) which puts the appropriate logic level on lines VO SEL 0, 1, and 2. For a discussion of Instrument Bus control, see Service Sheet BD4.

Voltage-to-Time Converter

The dc voltage at the DC Voltmeter input is converted to a pulse, with a duration linearly related to the magnitude of the voltage, by the Voltage-to-Time Converter. The pulse length is then measured by the Counter (see Service Sheet 14). The converter consists of the Comparator, Ramp Generator, and Reference.

The Reference supplies a voltage of controlled temperature co-efficient to the input to the Ramp Generator. The basic reference is the temperature-stable, reference diode VR4. The reference is fed from the current source Q10, which itself is temperature stable because its base-emitter junction and its reference, VR3, have similar thermal behavior. The negative reference supplies current to the inverting (–) input of U15 through R125 and R127. CR25, R123, and R124 add a slight temperature coefficient to the current to cancel the effect of the temperature coefficient of C70. The DC Voltmeter sensitivity is adjusted by means of R125.

U15 (with C70) integrates the negative input current to produce an increasing ramp. The ramp is generated only when Q9 is off (for example, when RAMP GATE (L) is low). This is initiated by the Controller. When Q9 is on, the voltage across VR5 appears across C70. This clamps the output of U15 at approximately –6.2V. The current for Q9 is supplied by current source Q12. When Q9 goes off, the ramp begins, starting at –6.2V.

The ramp begins when the RAMP GATE (L) line goes low. The output of comparator U20 at this time is high because the voltage at its non-inverting (+) input is higher than the inverting (–) input. The output of U20 is inverted by FET Q8. The Counter now begins clocking the duration of the ramp. When the ramp reaches the voltage at the non-inverting input, the output of U20 goes low and (via Q8) inhibits the clocking of the Counter. R131 and R136 add a small amount of hysteresis to the Comparator to assure a complete and rapid transition of the output once it begins to change.

Since the ramp begins at a negative offset, each voltage measurement consists of clocking the duration of a pair of ramps. The first ramp is generated with the Voltmeter Input Selector set to the grounded input (input 0). The duration of this ramp is proportional to the offset. The second ramp is generated with the selector set to the input to be measured. The duration of this ramp is proportional to the input level plus the offset. The difference in duration is computed by the Controller and is proportional to the input voltages.

The large negative offset voltage permits the DC Voltmeter to measure both negative and positive voltages.

TROUBLESHOOTING

General

Procedures for checking the Output Amplifier/Voltmeter Assembly are given below. The circuits or points to check are marked on the schematic diagram by a hexagon with a check mark and a number inside, for example, $\langle \checkmark 3 \rangle$. In addition, any points outside the labeled circuit area that must be checked are also identified. Fixed signals are shown on the schematic also inside a hexagon, for example, $\langle +1.9 \text{ TO } +2.1 \text{ VDC} \rangle$. Extend the board assembly where necessary to make measurements. These procedures assume that the source is working properly.

Equipment

Digital Voltmeter	HP 3455A
Oscilloscope	HP 1740A

$\langle \checkmark 1 \rangle$ Ripple Filters Check

1. On the Audio Analyzer, key in 41.0 SPCL to initialize the instrument. Set the INPUT and OUTPUT switches to ground. Key in AMPTD 3 V. Key in 1.11 SPCL to set the input gain to 0 dB. Key in 3.1 SPCL to set the output gain to 0 dB. Connect the HIGH OUTPUT to the HIGH INPUT.

2. Connect one channel of a high-impedance, dc coupled oscilloscope to A2TP2 (RMS). Connect the other channel to pin 1 of U10A. Both channels should read between +2.9 and +3.1 Vdc and both should read the same.

3. On the Audio Analyzer, connect and disconnect the HIGH INPUT several times and observe the two traces on the oscilloscope. The signal at pin 1 of U10A should lag in time slightly behind the signal at A2TP2 when the input is connected and disconnected.

4. On the Audio Analyzer, reconnect the HIGH INPUT. Connect one channel of the oscilloscope to A4TP1 (DC OUT). Connect the other channel to pin 7 of U18. Both channels should read between +2.9 and +3.1 Vdc and both should read the same.

Hint: If the signal at A4TP1 is faulty, see Service Sheet 6 and check the Output RMS/Average Detector.

5. On the Audio Analyzer, connect and disconnect the HIGH INPUT several times and observe the two traces on the oscilloscope. The signal at pin 7 of U18 should lag slightly behind the signal at A4TP1 when the input is connected and disconnected.

6. On the Audio Analyzer, reconnect the HIGH INPUT. Move the oscilloscope connection from pin 7 of U18 to pin 11. Both channels should read the same.

7. On the Audio Analyzer, connect and disconnect the HIGH INPUT several times and observe the two traces on the oscilloscope. The signal at pin 11 of U18 should lag behind the signal at A4TP1 when the input is connected and disconnected. (The lag will be longer than for the previous steps.)

$\langle \checkmark 2 \rangle$ Voltmeter Input Selector Check

1. On the Audio Analyzer, key in 41.0 SPCL to initialize the instrument. Set the INPUT and OUTPUT switches to ground. Key in AMPTD 3 V. Key in 1.11 SPCL to set the input gain to 0 dB. Key in 3.1 SPCL to set the output gain to 0 dB. Connect the HIGH OUTPUT to the HIGH INPUT.

2. Key in the Direct Control Special Functions listed in Table 8B-28. For each setting, compare the dc voltage at A4TP9 (MUX) to the pin on U18 indicated. The two voltages should be the same to within the repeatability of the voltmeter. If faulty, also check the logic level of the pins indicated.

Hint: If the selector has a failure in which one input is always connected to the output, pulses will usually appear on the faulty input when another line is selected. Use Special Function 49.N to select the lines.

$\langle \checkmark 3 \rangle$ Voltage-to-Time Converter Check

1. Measure the anode of VR4 with a dc voltmeter. The voltage should be between -6.51 and -5.89 Vdc.

Table 8B-28. Voltmeter Input Selector Check, $\sqrt{2}$ Step 2

Direct Control Special Function	Check Voltage at U18 Pin	Level (TTL) at U18 Pin		
		1	16	15
0.530	4	L	L	L
0.531	5	H	L	L
0.532	6*	L	H	L
0.533	7	H	H	L
0.534	12	L	L	H
0.535	11	H	L	H
0.536	10	L	H	H
0.537	9**	H	H	H

* A 3 Vrms ac signal should appear here also.
** A 1.2 to 1.5 Vrms signal should appear here also if the SOURCE frequency is set to 20 Hz.

2. On the Audio Analyzer, key in 41.0 SPCL to initialize the instrument. Set the INPUT and OUTPUT switches to ground. Key in AMPTD 3 V. Key in 1.11 SPCL to set the input gain to 0 dB. Key in 49.1 SPCL to set the voltmeter to measure the Input Range Detector. Connect the HIGH OUTPUT to the HIGH INPUT.

3. Connect a high-impedance, dc coupled oscilloscope to A4TP7 (RAMP). The waveform should be as shown in Figure 8B-35.

Hint: The slope of the triangles in the waveform should be approximately 1 V/ms.

Hint: Pin 14 of U19C should be as shown in Figure 8B-36. If it appears as a simple square wave, check that pin 5 of U18 is between +1.4 and +1.5 Vdc.

4. Connect the oscilloscope to A4TP10 (COMP). The waveform should be as shown in Figure 8B-37.

$\sqrt{4}$ Detector Select Switches Check

1. On the Audio Analyzer, key in 41.0 SPCL to initialize the instrument. Set the INPUT and OUTPUT switches to ground. Key in AMPTD 3 V. Key in 1.11 SPCL to set the input gain to 0 dB. Key in 3.1 SPCL to set the output gain to 0 dB. Connect the HIGH OUTPUT to the HIGH INPUT.

2. Connect a dc voltmeter to pin 7 of U9B.

3. On the Audio Analyzer, key in 0.531 SPCL to select the Pre-Notch Detector. The voltage should be between 1.4 and 1.6 Vdc. Shorting out R201 should reduce the voltage to 0V.

Hint: Pin 1 of U10A should be between 2.8 and 3.2 Vdc. Pin 9 of U21C should be a TTL low. Pin 8 of U9B should be a TTL high.

4. On the Audio Analyzer, key in 0.539 SPCL to select the Input Range Detector. The voltage should be between 1.4 and 1.6 Vdc. Shorting out R201 should have no effect.

Hint: Pin 19 of connector A13XA4B should be between 2.8 and 3.2 Vdc. Pin 9 of U21C should be a TTL high. Pin 8 of U9B should be a TTL low.

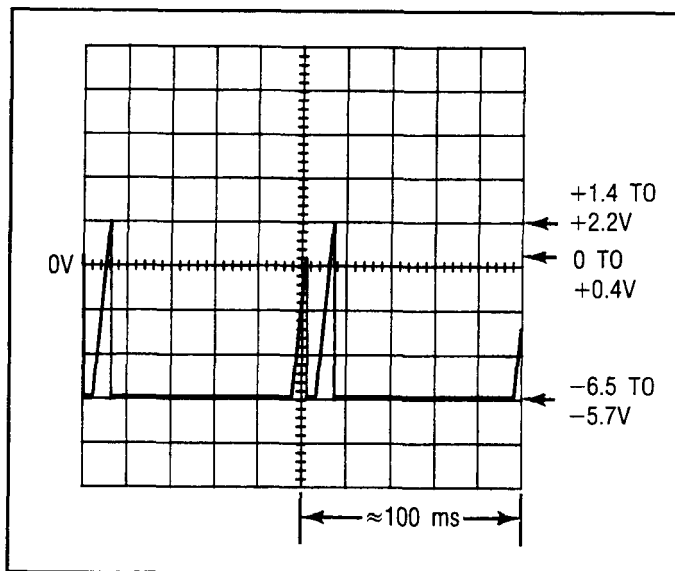


Figure 8B-35. Voltage-to-Time Converter Check, **J3** Step 3

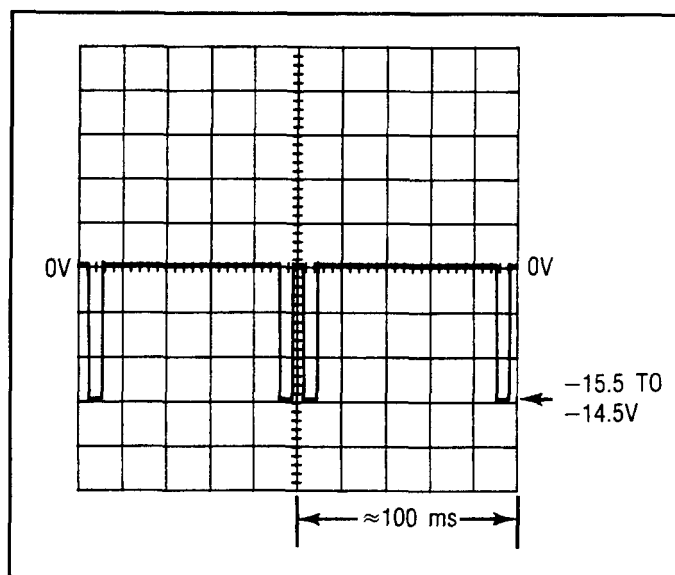


Figure 8B-36. Voltage-to-Time Converter Check, **J3** Step 3 Hint

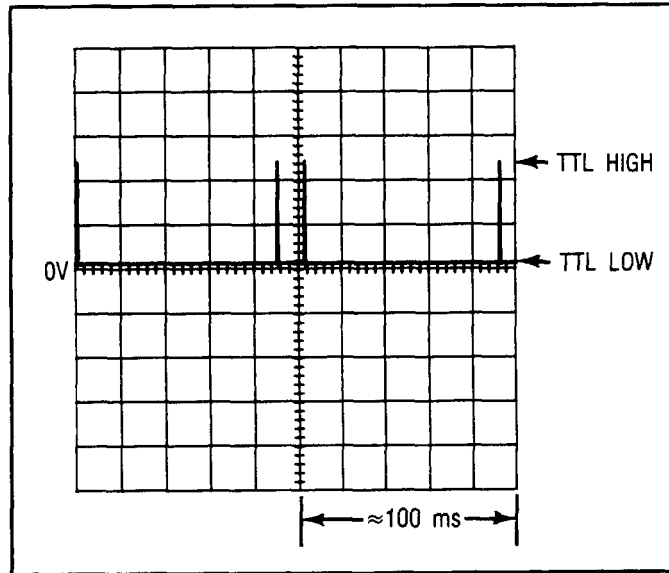
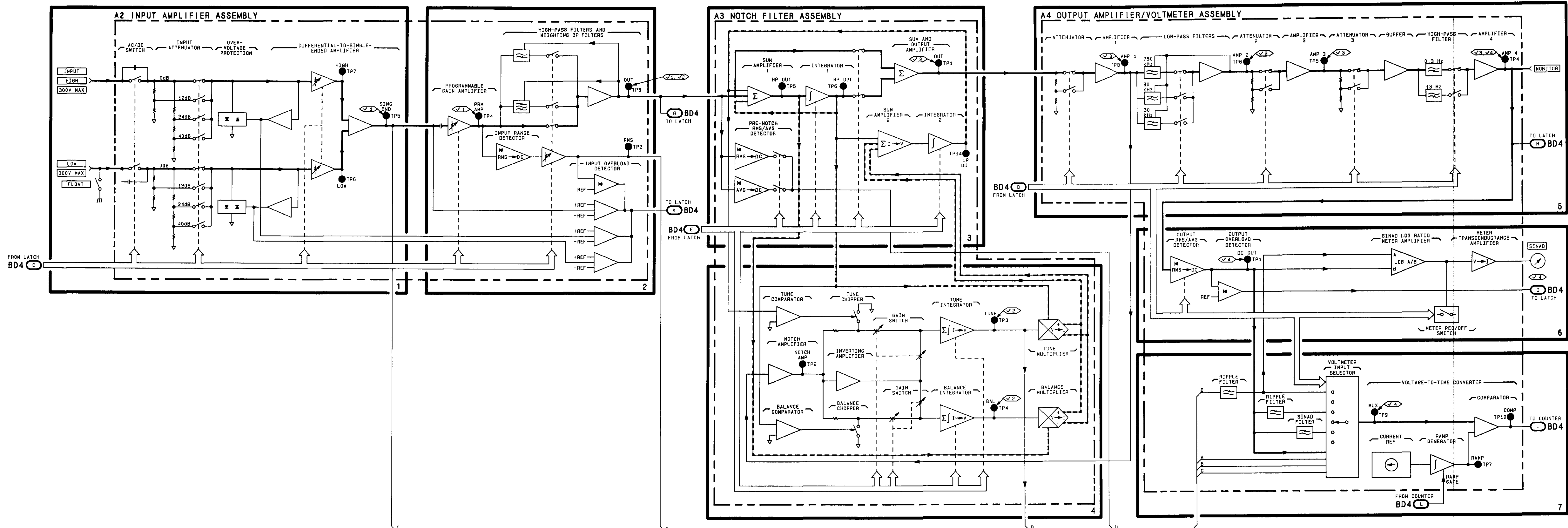


Figure 8B-37. Voltage-to-Time Converter Check, **J3** Step 4

CHANGES

All serial prefixes	On the block diagram: <ul style="list-style-type: none">• TP1, TP5, TP6 - In the A3 NOTCH FILTER ASSEMBLY, change TP5 to TP6, change TP6 to TP5, and change TP1 to TP7.



BD2
Figure 8B-101
8B-101

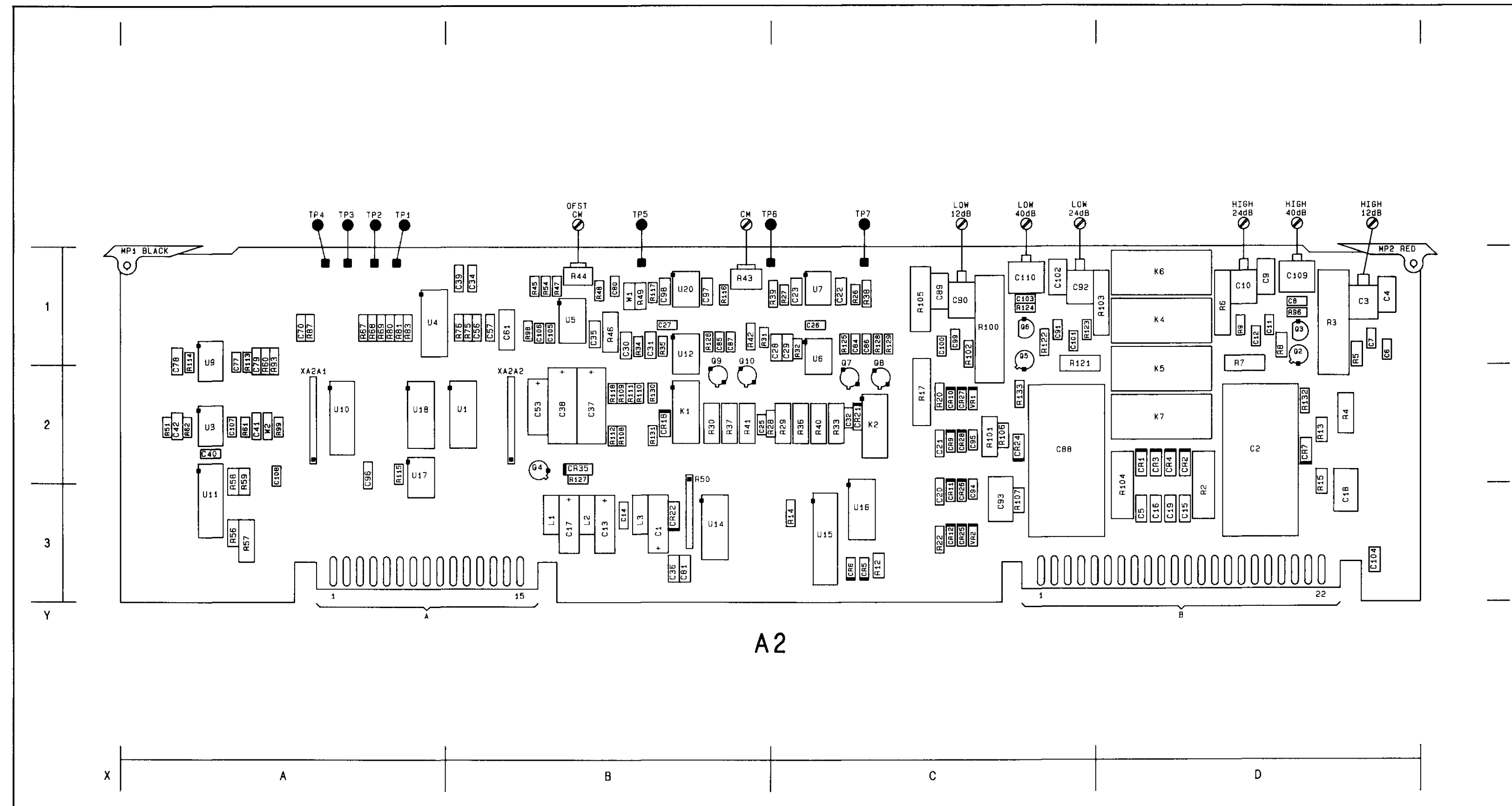


Figure 8B-102. SERVICE SHEET 1 INFORMATION

Component Locator

Component Coordinates

COMP	X, Y	COMP	X, Y	COMP	X, Y	COMP	X, Y
C1	B3	L1	B3	TP1	A1		
C2	D2	L2	B3	TP5	B1		
C3	D1	L3	B3	TP6	C1		
C4	D1			TP7	C1		
C5	D3	MP1	A1				
C6	D1	MP2	D1	U5	B1		
C7	D1			U6	C1		
C8	D1	Q2	D1	U7	C1		
C9	D1	Q3	D1	U12	B1		
C10	D1	Q5	D1	U14	B3		
C11	D1	Q6	D1	U15	B3		
C12	D1	Q7	C2	U16	C3		
C13	B3	Q8	C2	U20	B1		
C14	B3	Q9	B2				
C15	D3	Q10	B2	VR1	C2		
C16	D3			VR2	C3		
C17	B3	R2	D3	W2	A2		
C18	D3	R3	D1				
C19	D3	R4	D2				
C20	D3	R5	D1				
C21	D2	R6	D1				
C22	C1	R7	D1				
C23	C1	R8	D1				
C24	C1	R9	D1				
C25	C1	R10	D1				
C26	C1	R11	D1				
C27	B1	R12	D2				
C28	C1	R13	C3				
C29	C1	R14	D2				
C30	B1	R15	C3				
C31	B1	R16	C3				
C32	C2	R17	C3				
C33	C1	R18	C1				
C34	B1	R19	C1				
C35	B1	R20	C1				
C36	B1	R21	C1				
C37	B1	R22	C1				
C38	B1	R23	C1				
C39	B1	R24	C1				
C40	B1	R25	C1				
C41	B1	R26	C1				
C42	B1	R27	C1				
C43	B1	R28	C1				
C44	B1	R29	C1				
C45	B1	R30	C1				
C46	B1	R31	C1				
C47	B1	R32	C1				
C48	B1	R33	C1				
C49	B1	R34	C1				
C50	B1	R35	C1				
C51	B1	R36	C1				
C52	B1	R37	C1				
C53	B1	R38	C1				
C54	B1	R39	C1				
C55	B1	R40	C1				
C56	B1	R41	C1				
C57	B1	R42	C1				
C58	B1	R43	C1				
C59	B1	R44	C1				
C60	B1	R45	C1				
C61	B1	R46	C1				
C62	B1	R47	C1				
C63	B1	R48	C1				
C64	B1	R49	C1				
C65	B1	R50	C1				
C66	B1	R51	C1				
C67	B1	R52	C1				
C68	B1	R53	C1				
C69	B1	R54	C1				
C70	B1	R55	C1				
C71	B1	R56	C1				
C72	B1	R57	C1				
C73	B1	R58	C1				
C74	B1	R59	C1				
C75	B1	R60	C1				
C76	B1	R61	C1				
C77	B1	R62	C1				
C78	B1	R63	C1				
C79	B1	R64	C1				
C80	B1	R65	C1				
C81	B1	R66	C1				
C82	B1	R67	C1				
C83	B1	R68	C1				
C84	B1	R69	C1				
C85	B1	R70	C1				
C86	B1	R71	C1				
C87	B1	R72	C1				
C88	B1	R73	C1				
C89	B1	R74	C1				
C90	B1	R75	C1				
C91	B1	R76	C1				
C92	B1	R77	C1				
C93	B1	R78	C1				
C94	B1	R79	C1				
C95	B1	R80	C1				
C96	B1	R81	C1				
C97	B1	R82	C1				
C98	B1	R83	C1				
C99	B1	R84	C1				
C100	B1	R85	C1				
C101	B1	R86	C1				
C102	B1	R87	C1				
C103	B1	R88	C1				
C104	B1	R89	C1				
C105	B1	R90	C1				
C106	B1	R91	C1				
C107	B1	R92	C1				
C108	B1	R93	C1				
C109	B1	R94	C1				
C110	B1	R95	C1				
C111	B1	R96	C1				
C112	B1	R97	C1				
C113	B1	R98	C1				
C114	B1	R99	C1				
C115	B1	R100	C1				
C116	B1	R101	C1				
C117	B1	R102	C1				
C118	B1	R103	C1				
C119	B1	R104	C1				
C120	B1	R105	C1				
C121	B1	R106	C1				
C122	B1	R107	C1				
C123	B1	R108	C1				
C124	B1	R109	C1				
C125	B1	R110	C1				
C126	B1	R111	C1				
C127	B1	R112	C1				
C128	B1	R113	C1				
C129	B1	R114	C1				
C130	B1	R115	C1				
C131	B1	R116	C1				
C132	B1	R117	C1				
C133	B1	R118	C1				
C134	B1	R119	C1				
C135	B1	R120	C1				
C136	B1	R121	C1				
C137	B1	R122	C1				
C138	B1	R123	C1				
C139	B1	R124	C1				
C140	B1	R125	C1				
C141	B1	R126	C1				
C142	B1	R127	C1				
C143	B1	R128	C1				
C144	B1	R129	C1				
C145	B1	R130	C1				
C146	B1	R131	C1				
C147	B1	R132	C1				
C148	B1	R133	C1				
C149	B1	R134	C1				
C150	B1	R135	C1				
C151	B1	R136	C1				
C152	B1	R137	C1				
C153	B1	R138	C1				
C154	B1	R139	C1				
C155	B1	R140	C1				
C156	B1	R141	C1				
C157	B1	R142	C1				
C158	B1	R143	C1				
C159	B1	R144	C1				
C160	B1	R145	C1				
C161	B1	R146	C1				
C162	B1	R147	C1				
C163	B1	R148	C1				
C164	B1	R149	C1				
C165	B1	R150	C1				
C166	B1	R151	C1				
C167	B1	R152	C1				
C168	B1	R153	C1				
C169	B1	R154	C1				
C170	B1	R155	C1				
C171	B1	R156	C1				
C172	B1	R157	C1				
C173	B1	R158	C1				
C174	B1	R159	C1				
C175	B1	R160	C1				
C176	B1	R161	C1				
C177	B1	R162	C1				
C178	B1	R163	C1				
C179	B1	R164	C1				
C180	B1	R165	C1				
C181	B1	R166	C1				
C182	B1	R167	C1				
C183	B1	R168	C1				
C184	B1	R169	C1				
C185	B1	R170	C1				
C186	B1	R171	C1				
C187	B1	R172	C1				
C188	B1	R173	C1				
C189	B1	R174	C1				
C190	B1	R175	C1				
C191	B1	R176	C1				
C192	B1	R177	C1				
C193	B1	R178	C1				
C194	B1	R179	C1				
C195	B1	R180	C1				
C196	B1	R181	C1				
C197	B1	R182	C1				
C198	B1	R183	C1				
C199	B1	R184	C1				
C200	B1	R185	C1				
C201	B1	R186	C1				
C202	B1	R187	C1				
C203	B1	R188	C1				
C204	B1	R189	C1				
C205	B1	R190	C1				
C206	B1	R191	C1				
C207	B1	R192	C1				
C208	B1	R193	C1				
C209	B1	R194	C1				
C210	B1	R195	C1				
C211	B1	R196	C1				
C212	B1	R197	C1				
C213	B1	R198	C1				
C214	B1	R199	C1				
C215	B1	R200	C1				
C216	B1	R201	C1				
C217	B1	R202	C1				
C218	B1	R203	C1				
C219	B1	R204	C1				
C220	B1	R205	C1				
C221	B1	R206	C1				
C222	B1	R207	C1				
C223	B1	R208	C1				
C224	B1	R209	C1				
C225	B1	R210	C1				
C226	B1	R211	C1				
C227	B1	R212	C1				
C228	B1	R213	C1				
C229	B1	R214	C1				
C230	B1	R215	C1				
C231	B1	R216	C1				
C232	B1	R217	C1				
C233	B1	R218	C1				
C234	B1	R219	C1				
C235	B1	R220	C1				
C236	B1	R221	C1				
C237	B1	R222	C1				
C238	B1	R223	C1				
C239	B1	R224	C1				
C240	B1	R225	C1				
C241	B1	R226	C1				
C242	B1	R227	C1				
C243	B1	R228	C1				
C244	B1	R229	C1				
C245	B1	R230	C1				
C246	B1	R231	C1				

CHANGES

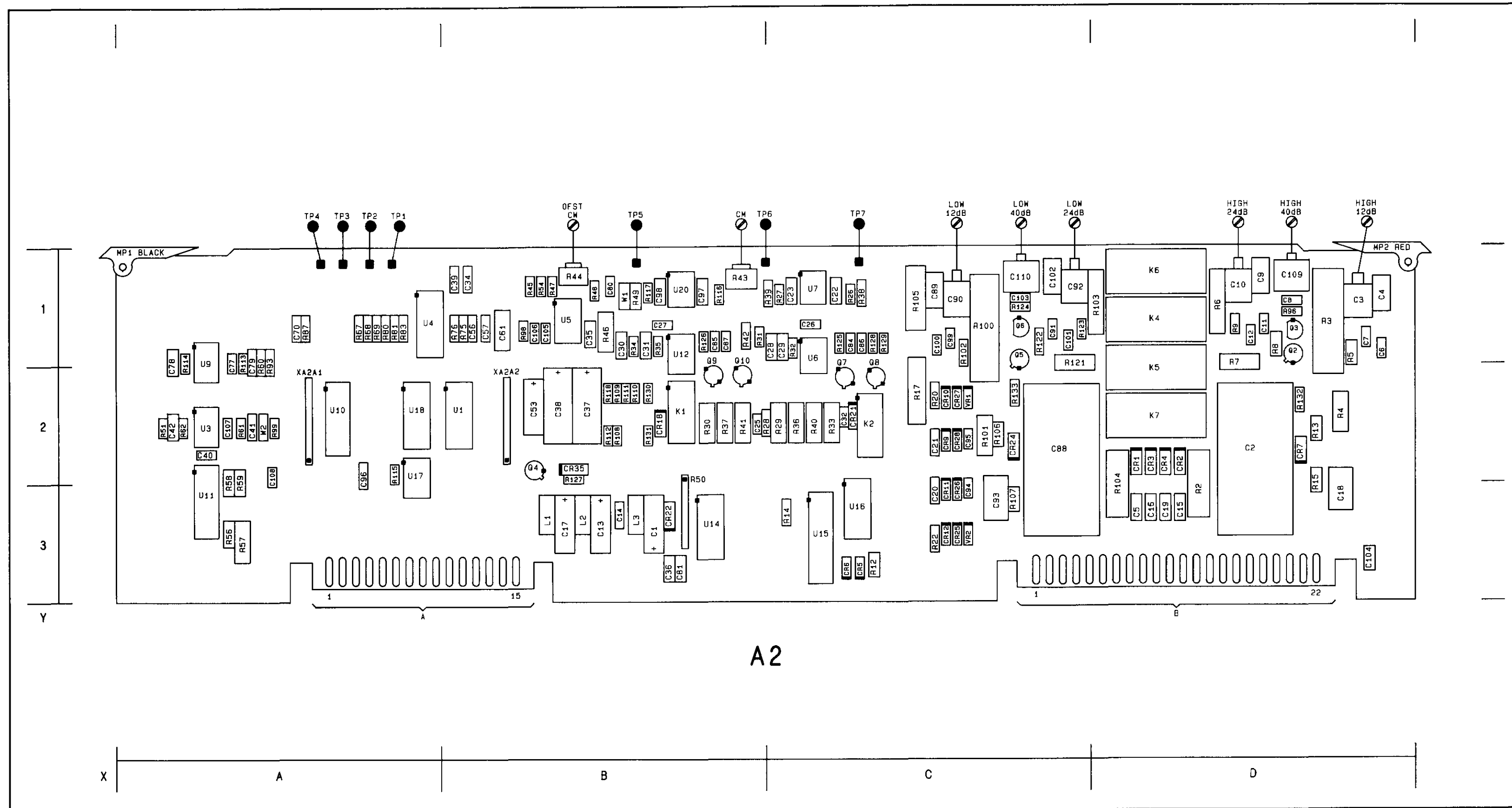
All Serial Prefixes

Under Notes:

- Note 1 - Add the following information under Note 1: "Since Q7, 8, 9, and 10 are double FET packages, they will operate correctly in the circuit if inserted with the tab either pointing up or down."

CHANGES

<p>All serial prefixes</p>	<p>Under Notes:</p> <ul style="list-style-type: none"> • Note 1 - Add the following information under Note 1: “Since Q7, 8, 9, and 10 are double FET packages, they will operate correctly in the circuit if inserted with the tab either pointing up or down.”
<p>2717A to 2742A</p>	<p>On the A13 schematic:</p> <ul style="list-style-type: none"> • 08903-60192 - Change the part number of the A13 POWER SUPPLY AND MOTHERBOARD ASSEMBLY to 08903-60192.
<p>2813A and above</p>	<p>On the A13 schematic:</p> <ul style="list-style-type: none"> • 08903-60292 - Change the part number of the A13 POWER SUPPLY AND MOTHERBOARD ASSEMBLY to 08903-60292.



A2

Component Locator

Component Coordinates

COMP	X, Y	COMP	X, Y	COMP	X, Y	COMP	X, Y
C36	B3						
C37	B2						
C38	B2						
C40	A2						
C41	A2						
C42	A2						
C53	B2						
C56	B1						
C57	B1						
C61	B1						
C70	A1						
C77	A1						
C78	A1						
C79	A1						
C81	B3						
C96	A2						
C104	D3						
C107	A2						
C108	A2						
CR35	B2						
Q4	B2						
R50	B3						
R51	A2						
R56	A3						
R57	A3						
R58	A2						
R59	A2						
R60	A1						
R61	A2						
R62	A2						
R67	A1						
R68	A1						
R69	A1						
R75	B1						
R76	B1						
R80	A1						
R81	A1						
R83	A1						
R87	A1						
R89	A1						
R99	A2						
R113	A1						
R114	A1						
R115	A2						
R127	B2						
TP2	A1						
TP3	A1						
TP4	A1						
U1	B2						
U3	A2						
U4	A1						
U9	A1						
U10	A2						
U11	A3						
U14	B3						
U16	C3						
U17	A2						
U18	A2						
W1	B1						
XA2A1	A2						
XA2A2	B2						

P/O A2 Input Amplifiers-Input Circuits **SS1**
SEE REVERSE SIDE

NOTES

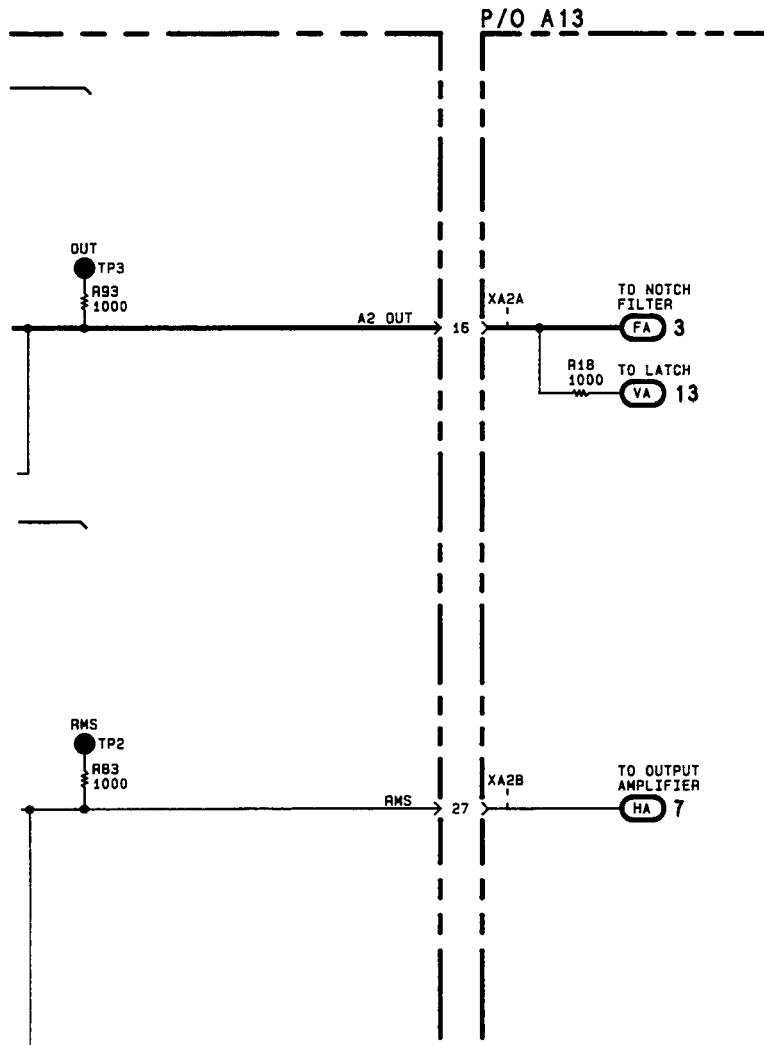
- Whenever an option plug-in filter is not installed, there is a jumper wire connecting pins 7 and 9 on the filter plug-in connectors. The front panel is labeled to the effect that on the standard instrument there are no filters installed.

Schematic General Information

Figure 8B-104. SERVICE SHEET 2 INFORMATION

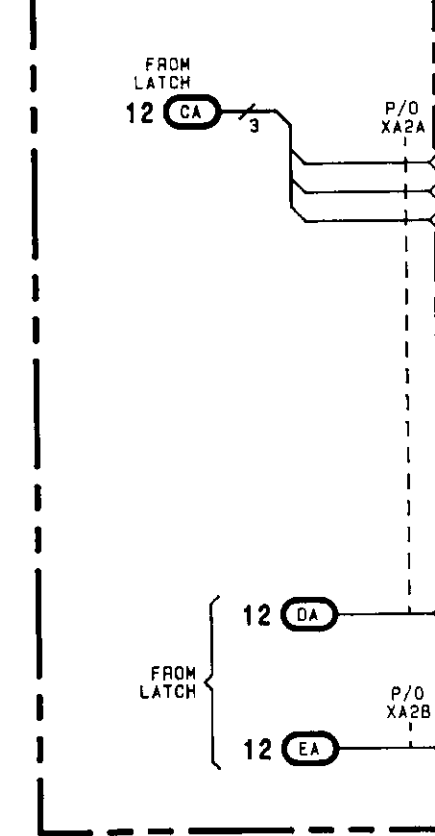
CHANGES

<p>All serial prefixes</p>	<p>On the A2 schematic:</p> <ul style="list-style-type: none"> • 08903-60170 - Use the partial schematic on page 8B-104.3. • W2 - Delete W2 jumper and replace it with R134, 10 ohm. • P/O XA2B - In the P/O A13 section, delete the connection between P/O XA2B and pin 27. Delete P/O and change XA2B to XA2A. Add XA2B to the right of pin 27. <p>On the A13 Component Locator:</p> <ul style="list-style-type: none"> • JP3 - Delete W2 and replace it with R134. <p>On the A13 Component Coordinates:</p> <ul style="list-style-type: none"> • W2 - Delete W2 and add R134 A,2.
<p>2717A to 2742A</p>	<p>On the A13 schematic:</p> <ul style="list-style-type: none"> • 08903-60192 - Change the part number of the A13 POWER SUPPLY AND MOTHERBOARD ASSEMBLY to 08903-60192.
<p>2813A and above</p>	<p>On the A13 schematic:</p> <ul style="list-style-type: none"> • 08903-60292 - Change the part number of the A13 POWER SUPPLY AND MOTHERBOARD ASSEMBLY to 08903-60292.



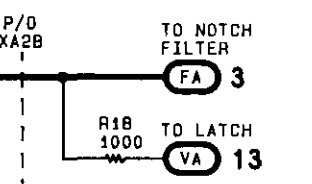
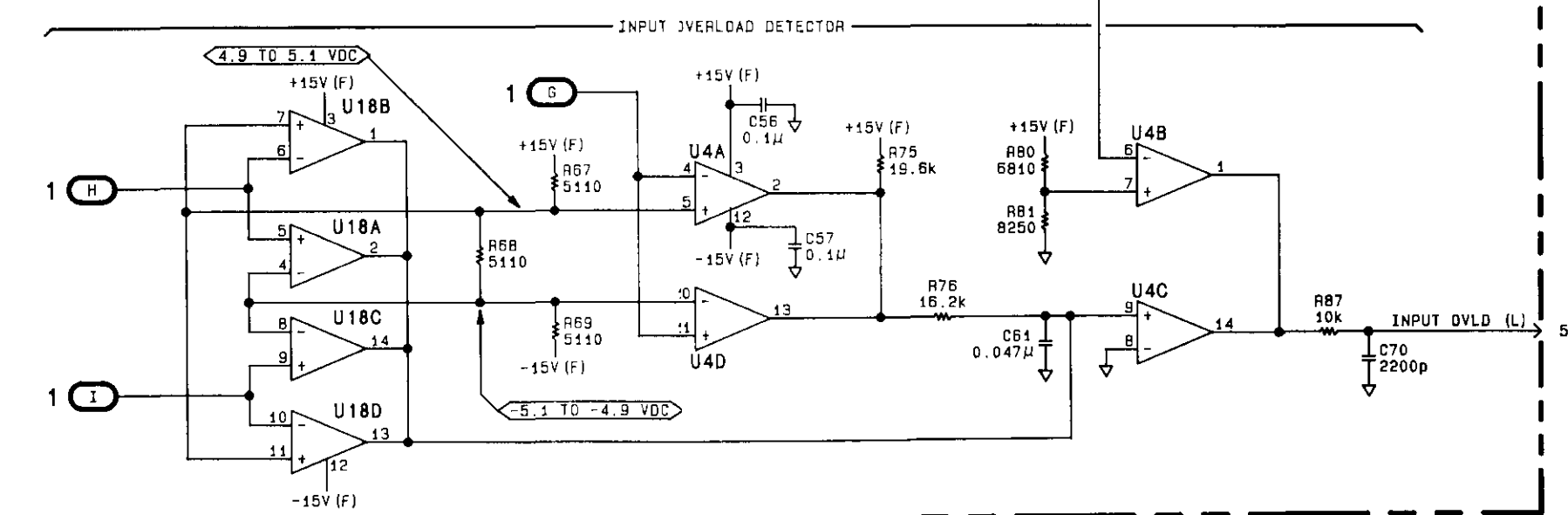
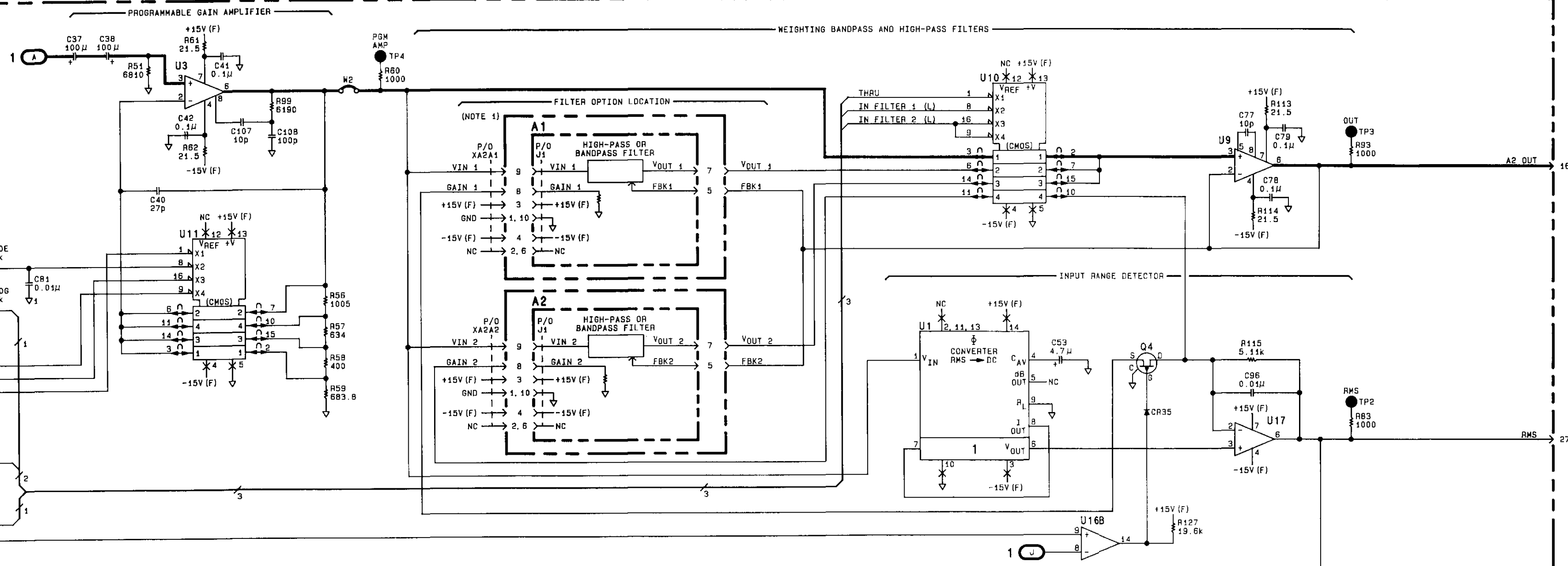
P/O A2 Input Amplifier Assembly

P/O A13 POWER SUPPLY AND MOTHERBOARD ASSEMBLY (08903-60129)



- 1 (B) +15V (F)
- 1 (C) +5V (F)
- 1 (D) ANALOG GROUND
- 1 (F) DIGITAL GROUND
- 1 (E) -15V (F)

SERIAL PREFIX: 2450A

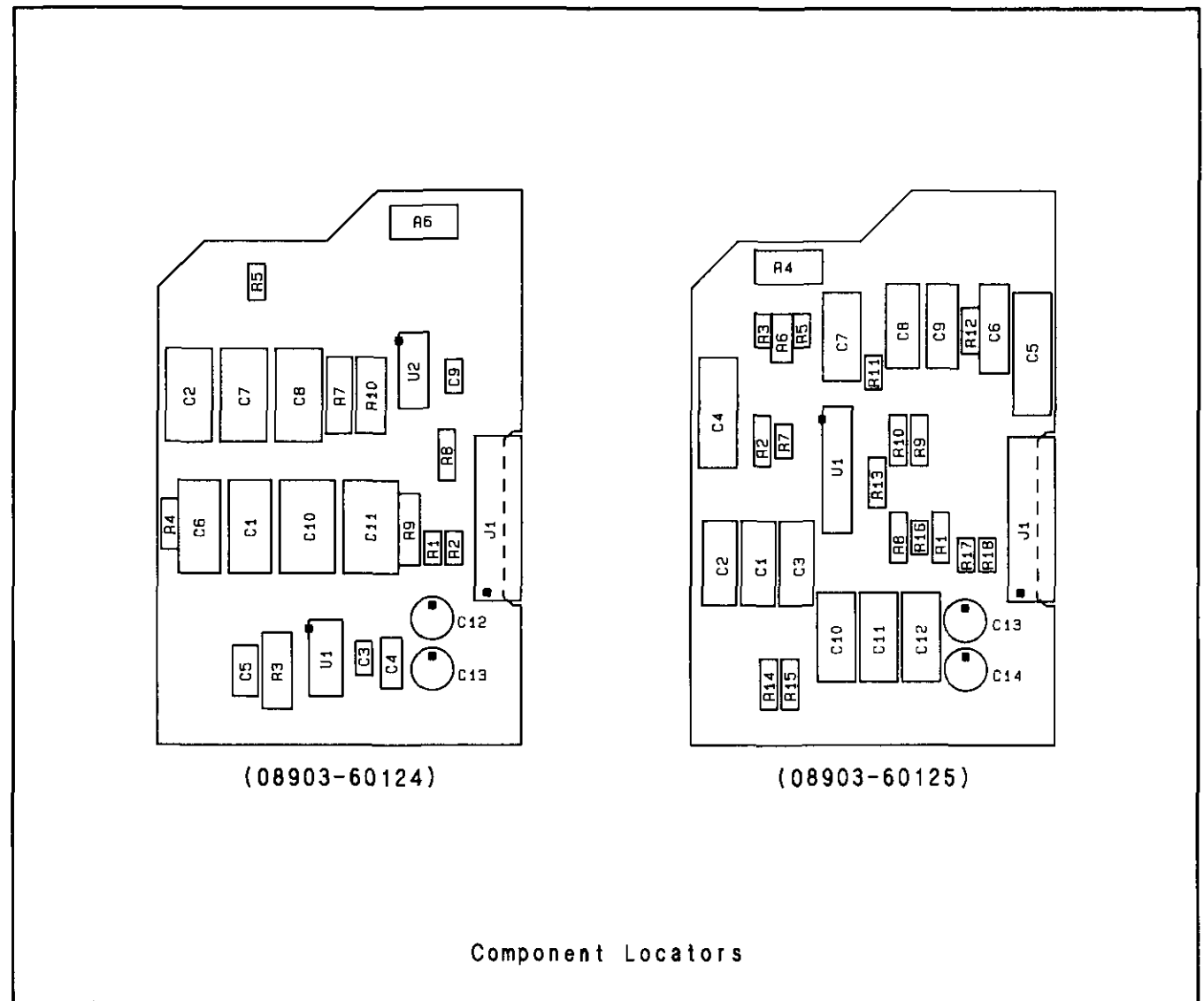


ATTENTION Static Sensitive Devices

NOTES

1. When an optional plug-in filter assembly is in the left-most position (Filter 1), it is designated as assembly A2A1. When an optional plug-in filter assembly is in the right-most position (Filter 2), it is then designated as assembly A2A2.

Schematic General Information



Component Locators

P/O A2 Input Amplifiers-
Output Circuits **SS2**
SEE REVERSE SIDE

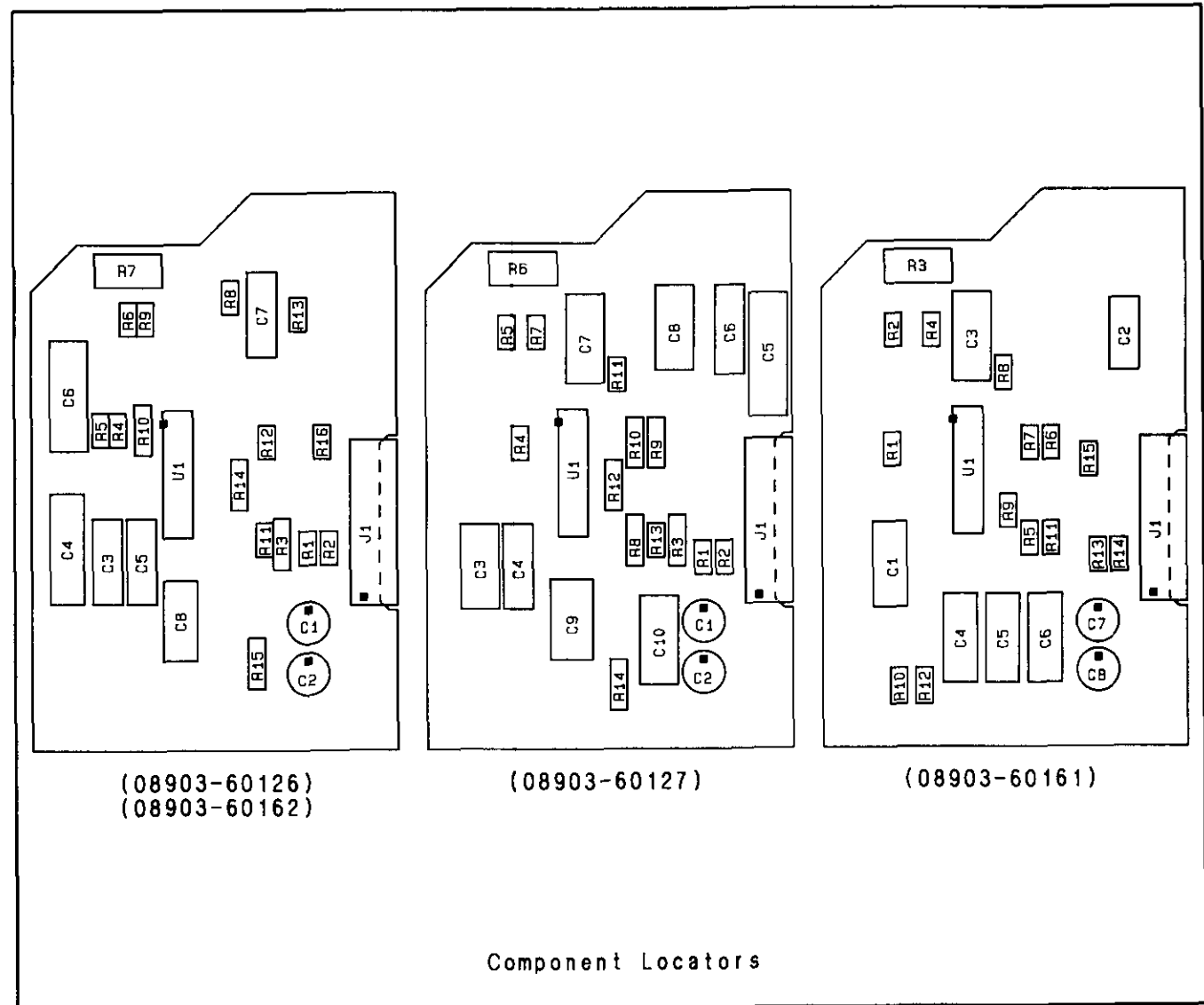
Figure 8B-106 SERVICE SHEET 2A INFORMATION

NOTES

1. When an optional plug-in filter assembly is in the left-most position (filter 1), it is designated as assembly A2A1. When an optional plug-in filter assembly is in the right-most position (filter 2), it is then designated as assembly A2A2.
2. The only difference between the CCIR and the CCIR/ARM Weighting Bandpass Filter Assemblies is the values of R6, R11, R13 and R16, listed as follows.

FILTER ASSEMBLY	R6	R11	R13	R16
CCIR (08903-60126)	383	2370Ω	3830Ω	1520Ω
CCIR/ARM (08903-60162)	464	3480Ω	4640Ω	4640Ω

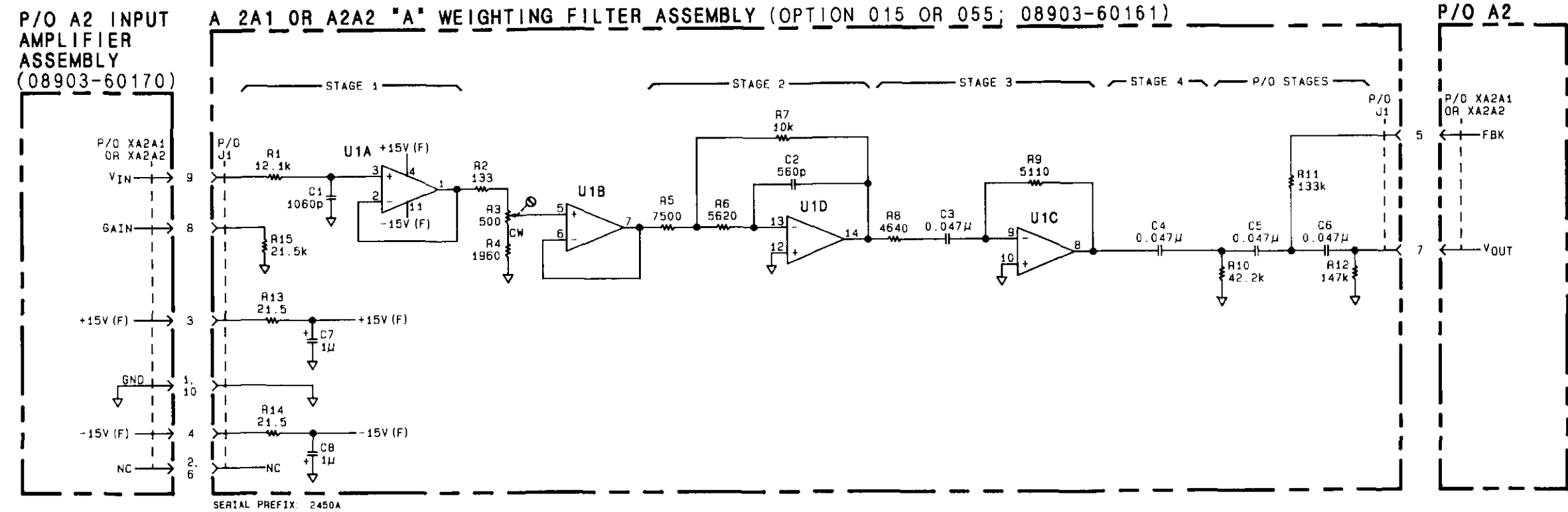
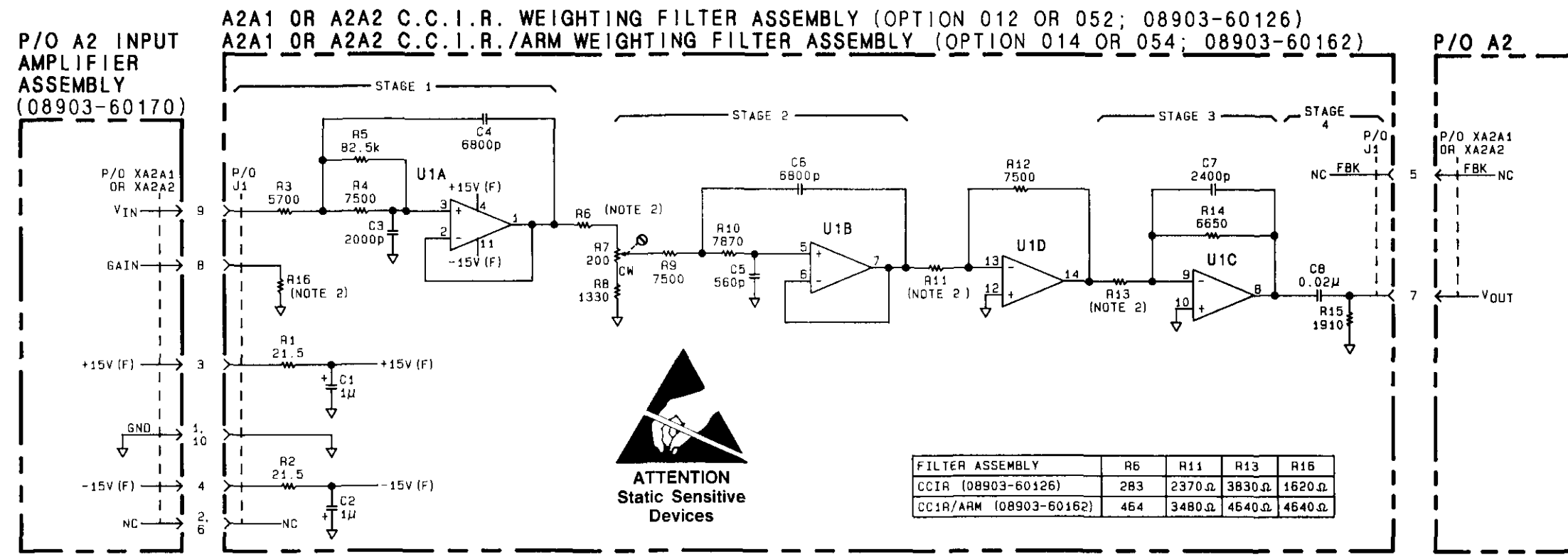
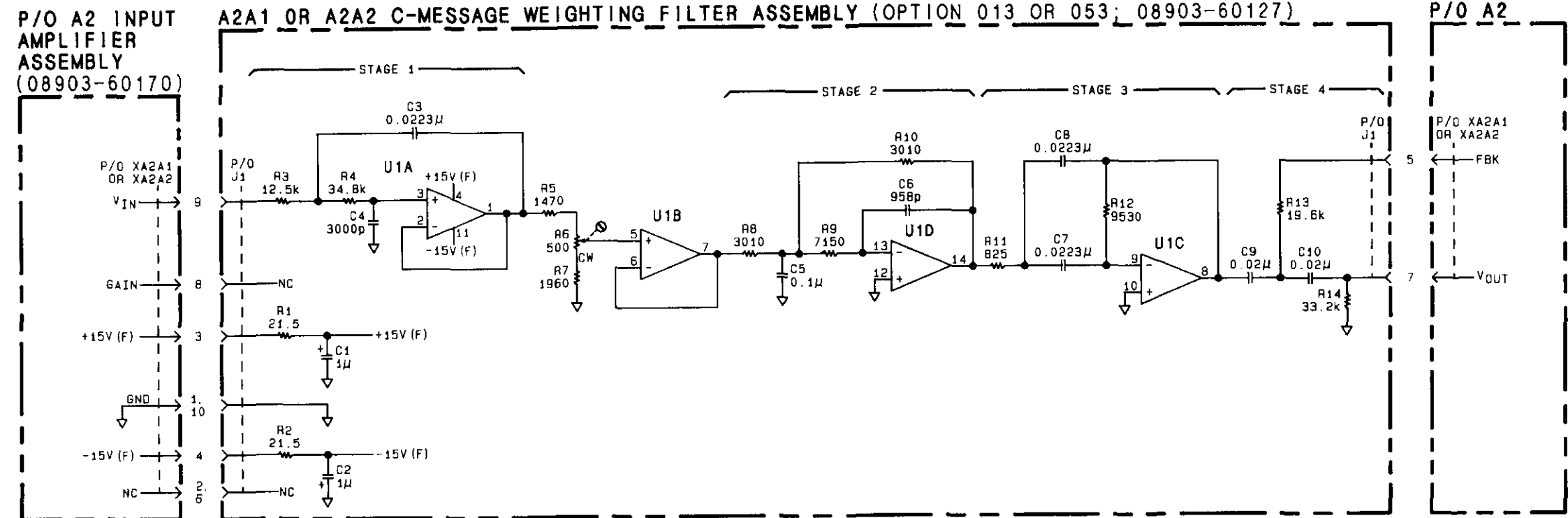
Schematic General Information



A2A1 AND/
OR A2A2
SEE REVERSE SIDE

SS2A

Figure 8B-108. SERVICE SHEET 2B INFORMATION



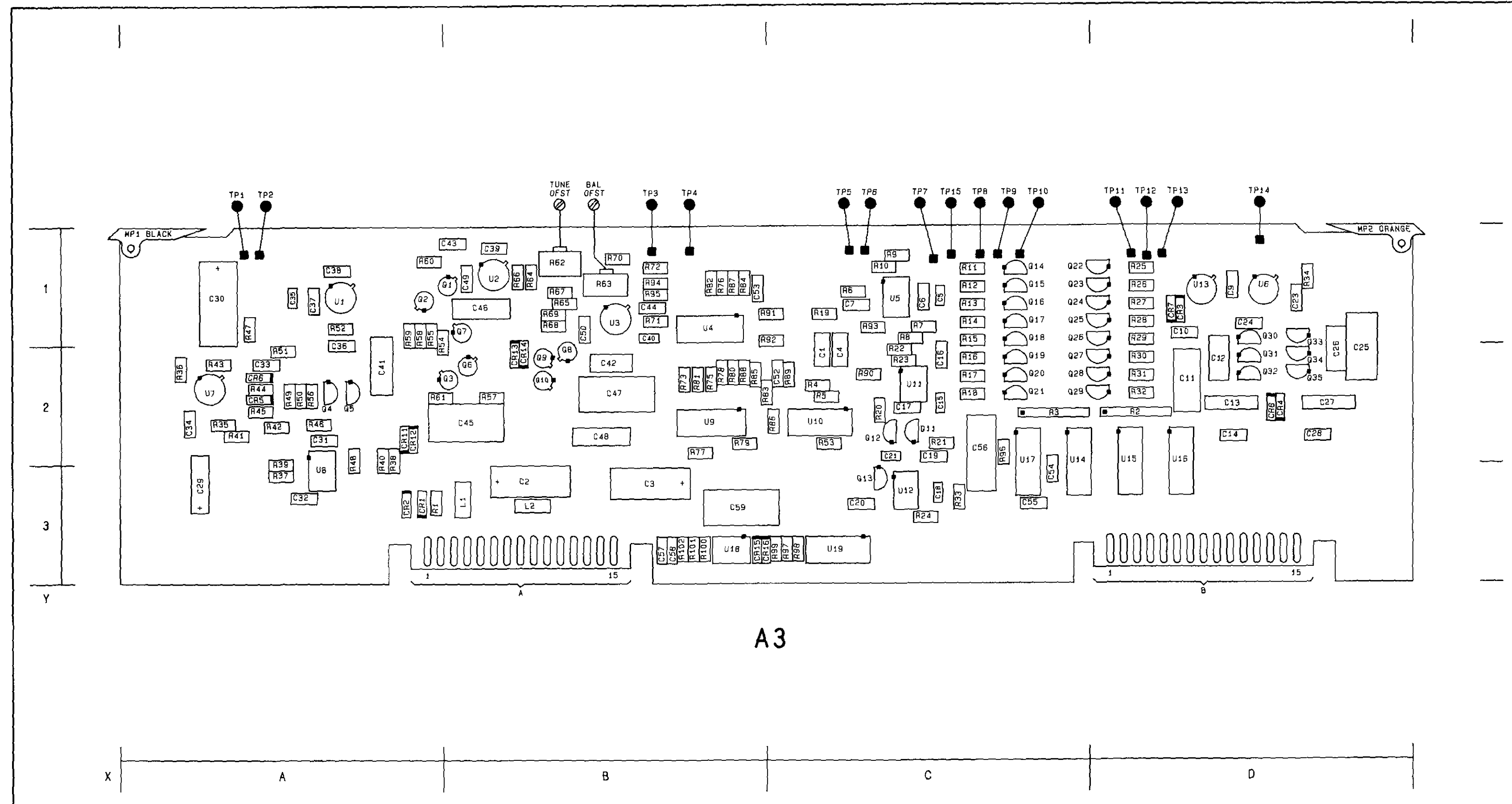


Figure 8B-110. SERVICE SHEET 3 INFORMATION

Component Locator

Component Coordinates

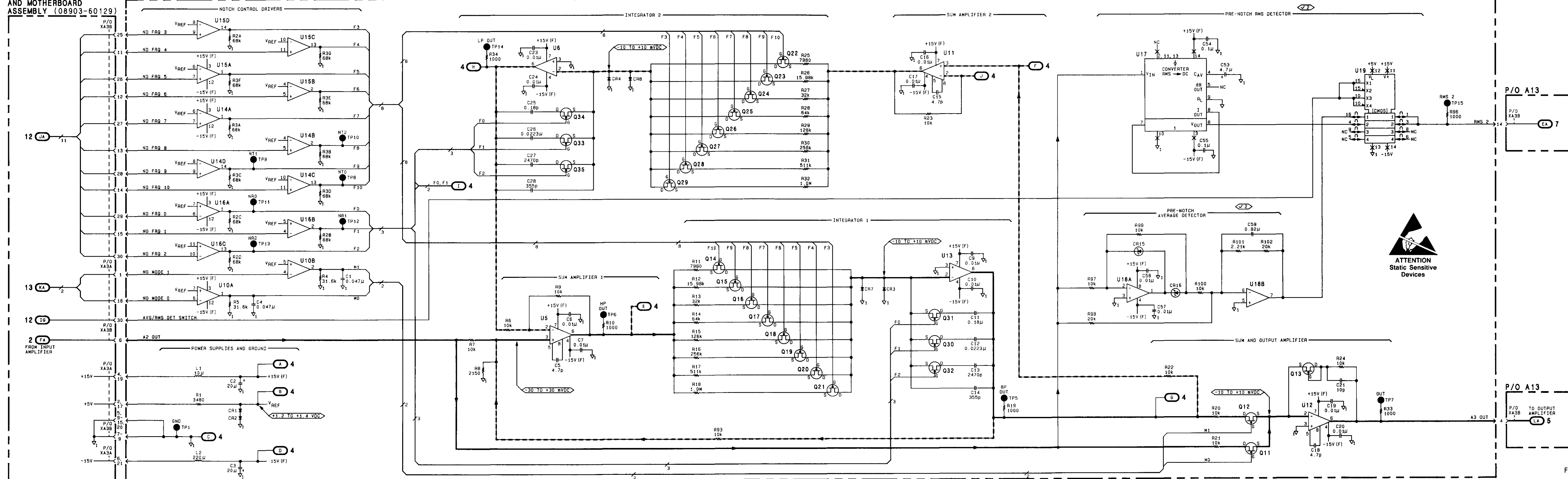
COMP	X, Y	COMP	X, Y	COMP	X, Y	COMP	X, Y
C1	D2	R18	C2				
C2	B3	R19	C2				
C3	B3	R20	C2				
C4	C2	R21	C2				
C5	D2	R22	C2				
C6	C1	R23	C2				
C7	C1	R24	C3				
C8	D1	R25	D1				
C9	D1	R26	D1				
C10	D1	R27	D1				
C11	D2	R28	D1				
C12	D2	R29	D1				
C13	D2	R30	D2				
C14	D2	R31	D2				
C15	D2	R32	D2				
C16	C2	R33	C3				
C17	C2	R34	C1				
C18	C3	R35	C1				
C19	D2	R36	C2				
C20	C3	R37	C2				
C21	C2	R38	C3				
C22	D1	R39	C3				
C23	D1	R40	C3				
C24	D1	R41	B3				
C25	D2	R42	B3				
C26	D2	R43	B3				
C27	D2	R44	B3				
C28	D2	R45	B3				
C29	D2	R46	B3				
C30	D2	R47	B3				
C31	D2	R48	B3				
C32	D2	R49	B3				
C33	D2	R50	B3				
C34	D2	R51	B3				
C35	D2	R52	B3				
C36	D2	R53	B3				
C37	D2	R54	B3				
C38	D2	R55	B3				
C39	D2	R56	B3				
C40	D2	R57	B3				
C41	D2	R58	B3				
C42	D2	R59	B3				
C43	D2	R60	B3				
C44	D2	R61	B3				
C45	D2	R62	B3				
C46	D2	R63	B3				
C47	D2	R64	B3				
C48	D2	R65	B3				
C49	D2	R66	B3				
C50	D2	R67	B3				
C51	D2	R68	B3				
C52	D2	R69	B3				
C53	D2	R70	B3				
C54	D2	R71	B3				
C55	D2	R72	B3				
C56	D2	R73	B3				
C57	D2	R74	B3				
C58	D2	R75	B3				
C59	D2	R76	B3				
C60	D2	R77	B3				
C61	D2	R78	B3				
C62	D2	R79	B3				
C63	D2	R80	B3				
C64	D2	R81	B3				
C65	D2	R82	B3				
C66	D2	R83	B3				
C67	D2	R84	B3				
C68	D2	R85	B3				
C69	D2	R86	B3				
C70	D2	R87	B3				
C71	D2	R88	B3				
C72	D2	R89	B3				
C73	D2	R90	B3				
C74	D2	R91	B3				
C75	D2	R92	B3				
C76	D2	R93	B3				
C77	D2	R94	B3				
C78	D2	R95	B3				
C79	D2	R96	B3				
C80	D2	R97	B3				
C81	D2	R98	B3				
C82	D2	R99	B3				
C83	D2	R100	B3				
C84	D2	R101	B3				
C85	D2	R102	B3				
C86	D2	R103	B3				
C87	D2	R104	B3				
C88	D2	R105	B3				
C89	D2	R106	B3				
C90	D2	R107	B3				
C91	D2	R108	B3				
C92	D2	R109	B3				
C93	D2	R110	B3				
C94	D2	R111	B3				
C95	D2	R112	B3				
C96	D2	R113	B3				
C97	D2	R114	B3				
C98	D2	R115	B3				
C99	D2	R116	B3				
C100	D2	R117	B3				
C101	D2	R118	B3				
C102	D2	R119	B3				
C103	D2	R120	B3				
C104	D2	R121	B3				
C105	D2	R122	B3				
C106	D2	R123	B3				
C107	D2	R124	B3				
C108	D2	R125	B3				
C109	D2	R126	B3				
C110	D2	R127	B3				
C111	D2	R128	B3				
C112	D2	R129	B3				
C113	D2	R130	B3				
C114	D2	R131	B3				
C115	D2	R132	B3				
C116	D2	R133	B3				
C117	D2	R134	B3				
C118	D2	R135	B3				
C119	D2	R136	B3				
C120	D2	R137	B3				
C121	D2	R138	B3				
C122	D2	R139	B3				
C123	D2	R140	B3				
C124	D2	R141	B3				
C125	D2	R142	B3				
C126	D2	R143	B3				
C127	D2	R144	B3				
C128	D2	R145	B3				
C129	D2	R146	B3				
C130	D2	R147	B3				
C131	D2	R148	B3				
C132	D2	R149	B3				
C133	D2	R150	B3				
C134	D2	R151	B3				
C135	D2	R152	B3				
C136	D2	R153	B3				
C137	D2	R154	B3				
C138	D2	R155	B3				
C139	D2	R156	B3				
C140	D2	R157	B3				
C141	D2	R158	B3				
C142	D2	R159	B3				
C143	D2	R160	B3				
C144	D2	R161	B3				
C145	D2	R162	B3				
C146	D2	R163	B3				
C147	D2	R164	B3				
C148	D2	R165	B3				
C149	D2	R166	B3				
C150	D2	R167	B3				
C151	D2	R168	B3				
C152	D2	R169	B3				
C153	D2	R170	B3				
C154	D2	R171	B3				
C155	D2	R172	B3				
C156	D2	R173	B3				
C157	D2	R174	B3				
C158	D2	R175	B3				
C159	D2	R176	B3				
C160	D2	R177	B3				
C161	D2	R178	B3				
C162	D2	R179	B3				
C163	D2	R180	B3				
C164	D2	R181	B3				
C165	D2	R182	B3				
C166	D2	R183	B3				
C167	D2	R184	B3				
C168	D2	R185	B3				
C169	D2	R186	B3				
C170	D2	R187	B3				
C171	D2	R188	B3				
C172	D2	R189	B3				
C173	D2	R190	B3				
C174	D2	R191	B3				
C175	D2	R192	B3				
C176	D2	R193	B3				
C177	D2	R194	B3				
C178	D2	R195	B3				
C179	D2	R196	B3				
C180	D2	R197	B3				
C181	D2	R198	B3				
C182	D2	R199	B3				
C183	D2	R200	B3				
C184	D2	R201	B3				
C185	D2	R202	B3				
C186	D2	R203	B3				
C187	D2	R204	B3				
C188	D2	R205	B3				
C189	D2	R206	B3				
C190	D2	R207	B3				
C191	D2	R208	B3				
C192	D2	R209	B3				
C193	D2	R210	B3				
C194	D2	R211	B3				
C195	D2	R212	B3				
C196	D2	R213	B3				
C197	D2	R214	B3				
C198	D2	R215	B3				
C199	D2	R216	B3				
C200	D2	R217	B3				
C201	D2	R218	B3				
C202	D2	R219	B3				
C203	D2	R220	B3				
C204	D2	R221	B3				
C205	D2	R222	B3				
C206	D2	R223	B3				
C207	D2	R224	B3				
C208	D2	R225	B3				
C209	D2	R226	B3				
C210	D2	R227	B3				
C211	D2	R228	B3				
C212	D2	R229	B3				
C213	D2	R230	B3				
C214	D2	R231	B3				
C215	D2	R232	B3				
C216	D2	R233	B3				
C217	D2	R234	B3				
C218	D2	R235	B3				
C219	D2	R236	B3				
C220	D2	R237	B3				
C221	D2	R238	B3				
C222	D2	R239	B3				
C223	D2	R240	B3				
C224	D2	R241	B3				
C225	D2	R242	B3				
C226	D2	R243	B3				
C227	D2	R244	B3				
C228	D2	R245	B3				
C229	D2	R246	B3				
C230	D2	R247	B3				
C231	D2	R248	B3				
C232	D2	R249	B3				
C233	D2	R250	B3				
C234	D2	R251	B3				
C235	D2	R252	B3				
C236	D2	R253	B3				
C237	D2	R254	B3				
C238	D2	R255	B3				
C239	D2	R256	B3				
C240	D2	R257	B3				
C241	D2	R258	B3				
C242	D2	R259	B3				
C243	D2	R260	B3				
C244	D2	R261	B3				
C245	D2	R262	B3				
C246	D2	R263	B3				
C247	D2	R264	B3				
C248	D2	R265	B3				
C249	D2	R266	B3				
C250	D2	R267	B3				
C251	D2	R268	B3				
C252	D2	R269	B3				
C253	D2	R270	B3				
C254	D2	R271	B3				
C255	D2	R272	B3				
C256	D2	R273	B3				
C257	D2	R274	B3				
C258	D2	R275	B3				
C259	D2	R276	B3				
C260	D2	R277	B3				
C261	D2	R278	B3				
C262	D2	R279	B3				
C263	D2	R280	B3				
C264	D2	R281	B3				
C265	D2	R282	B3				
C266	D2	R283	B3				
C267	D2	R284	B3				
C268	D2	R285	B3				
C269	D2	R286	B3				
C270	D2	R287	B3				
C271	D2	R288	B3				
C272	D2	R289	B3				
C273	D2	R290	B3				
C274	D2	R291	B3				
C275	D2	R292	B3				
C276	D2	R293	B3				
C277	D2	R294	B3				
C278	D2	R295	B3				
C279	D2	R296	B3				
C280	D2	R297	B3				
C281	D2	R298	B3				
C282	D2	R299	B3				
C283	D2	R300	B3				
C284	D2	R301	B3				
C285	D2	R302	B3				
C286	D2	R303	B3				
C287	D2	R304	B3				
C288	D2	R305	B3				
C289	D2	R306	B3				
C290	D2	R307	B3				
C291	D2	R308	B3				
C292	D2	R309	B3				
C293	D2	R310	B3				
C294	D2	R311	B3				
C295	D2	R312	B3				
C296	D2	R313	B3				
C297	D2	R314	B3				
C298	D2	R315	B3				
C299	D2	R316	B3				
C300	D2	R317	B3				
C301	D2	R318	B3				
C302	D2	R319	B3				
C303	D2	R320	B3				
C304	D2	R321	B3				
C305	D2	R322	B3				
C306	D2	R323	B3				
C307	D2	R324	B3				
C308	D2	R325	B3				
C309	D2	R326	B3				
C310	D2	R327	B3				
C311	D2	R328	B3				
C312	D2	R329	B3				
C313	D2	R330	B3				
C314	D2	R331	B3				
C315	D2	R332	B3				
C316	D2	R333	B3				
C317	D2	R334	B3				
C318	D2	R335	B3				
C319	D2	R336	B3				
C320	D2	R337	B3				
C321	D2	R338	B3				
C322	D2	R339	B3				
C323	D2	R340	B3				
C324	D2	R341	B3				
C325	D2	R342	B3				
C326	D2	R343	B3				
C327	D2	R344	B3				
C328	D2	R345	B3				
C329	D2	R346	B3				
C330	D2	R347	B3				
C331	D2	R348	B3				
C332	D2	R349	B3				
C333	D2	R350	B3				
C334	D2	R351	B3				
C335	D2	R352	B3				
C336	D2	R353	B3				
C337	D2	R354	B3				
C338	D2	R355	B3				
C339	D2	R356	B3				
C340	D2	R357	B3				
C341	D2	R358	B3				
C342	D2	R359	B3				
C343	D2	R360	B3				
C344	D2	R361	B3				
C345	D2	R362	B3				
C346	D2	R363	B3				
C347	D2	R364	B3				
C348	D2	R365	B3				
C349	D2	R366	B3				
C350	D2	R367	B3				
C351	D2	R368	B3				
C352	D2	R369	B3				
C353	D2	R370	B3				
C354	D2	R371	B3				
C355	D2	R372	B3				
C356	D2	R373	B3				
C357	D2	R374	B3				
C358	D2	R375	B3				
C359	D2	R376	B3				
C360	D2	R377	B3				
C361	D2	R378	B3				
C362	D2	R379	B3				
C363	D2	R380	B3				
C364	D2	R381	B3				
C365	D2	R382	B3				
C366	D2	R383	B3				
C367	D2	R384	B3				
C368	D2	R385	B3				
C369	D2						

CHANGES

<p>All serial prefixes</p>	<p>On the A13 schematic:</p> <ul style="list-style-type: none"> • C53 - Under PRE-NOTCH RMS DETECTOR, locate C53 and change it to <u>C56</u> .18 uF (non-polarized). • C25 - Under INTEGRATOR 2, change the value of C25 to .18 uF.
<p>2717A to 2742A</p>	<p>On the A13 schematic:</p> <ul style="list-style-type: none"> • 08903-60192 - Change the part number of the A13 POWER SUPPLY AND MOTHERBOARD ASSEMBLY to 08903-60192.
<p>2813A and above</p>	<p>On the A13 schematic:</p> <ul style="list-style-type: none"> • 08903-60292 - Change the part number of the A13 POWER SUPPLY AND MOTHERBOARD ASSEMBLY to 08903-60292.

P/O A13 POWER SUPPLY AND MOTHERBOARD ASSEMBLY (08903-60129)

P/O A3 NOTCH FILTER ASSEMBLY(08903-60163)



SS3
Figure 8B-111
8B-111

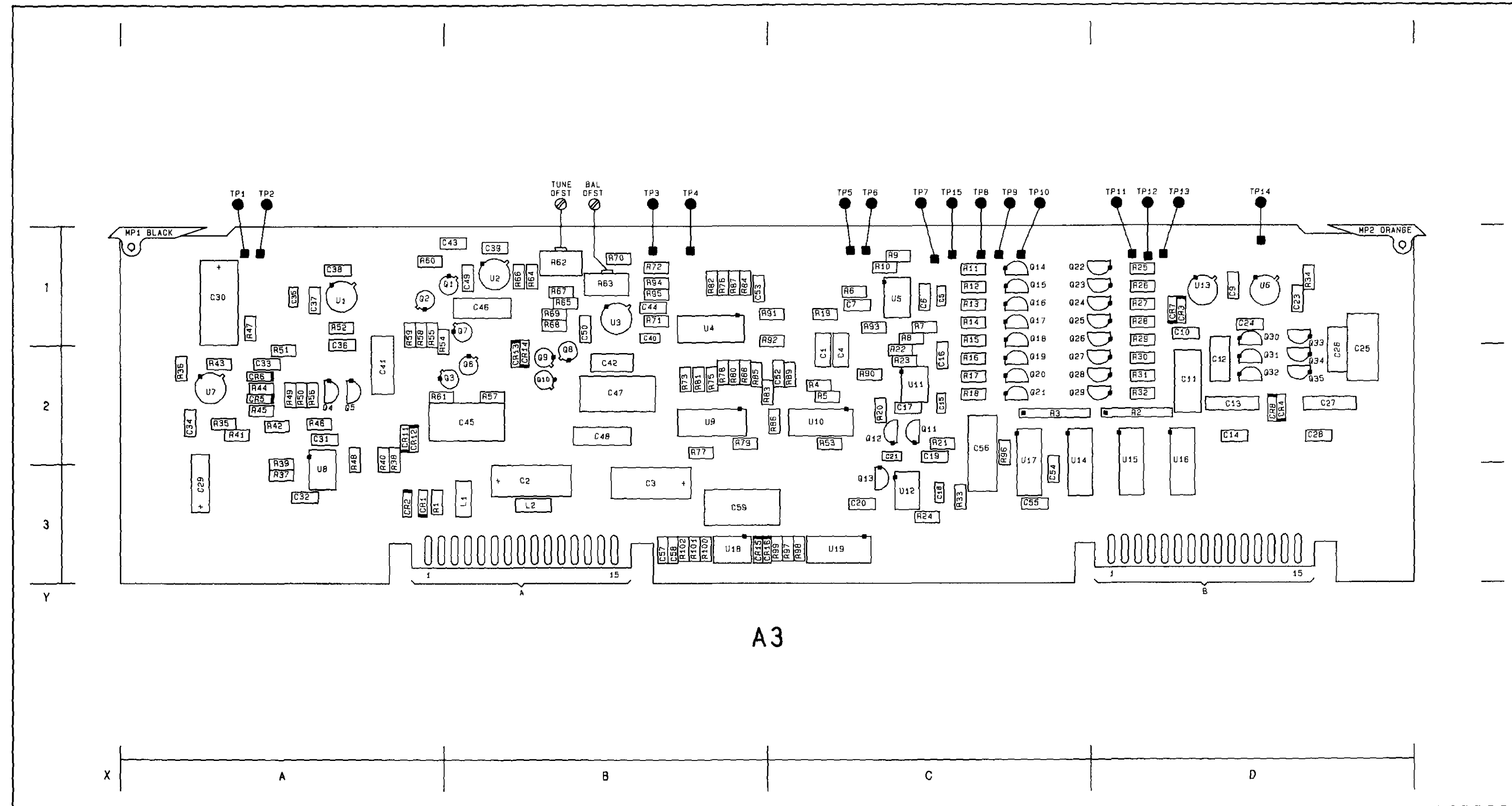


Figure 8B-112. SERVICE SHEET 4 INFORMATION

Component Locator

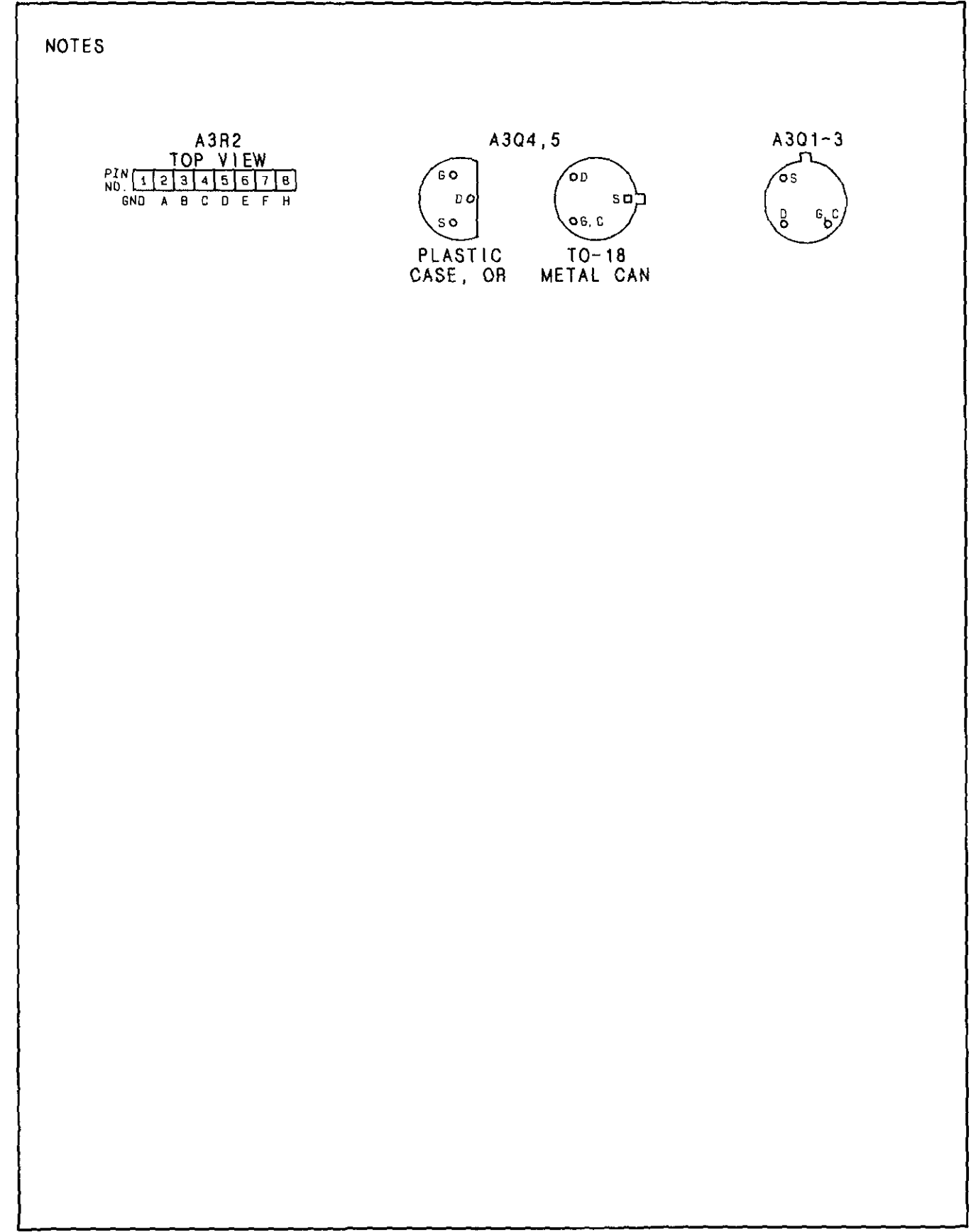
Component Coordinates

COMP	X,Y	COMP	X,Y	COMP	X,Y	COMP	X,Y
C29	A3	R80	B2				
C30	A1	R81	B2				
C31	A2	R82	B1				
C32	A2	R83	B1				
C33	A2	R84	B1				
C34	A2	R85	B2				
C35	A1	R86	B2				
C36	A1	R87	B1				
C37	A1	R88	B2				
C38	A1	R89	B2				
C39	B1	R90	B2				
C40	B1	R91	B1				
C41	A2	R92	B1				
C42	B2	R94	B1				
C43	B1	R95	B1				
C44	B1						
C45	B2	TP2	A1				
C46	B1	TP3	B1				
C47	B2	TP4	B1				
C48	B2						
C49	B1	U1	A1				
C50	B1	U2	B1				
C52	C2	U3	B1				
C53	B1	U4	B1				
		U7	A2				
		U8	A3				
		U9	B2				
		U10	B2				
		U16	B2				
Q1	B1						
Q2	A1						
Q3	B2						
Q4	A2						
Q5	B2						
Q6	B2						
Q7	B1						
Q8	B2						
Q9	B2						
Q10	B2						
R2	B2						
R35	A2						
R36	A2						
R37	A3						
R38	A2						
R39	A2						
R40	A2						
R41	A2						
R42	A2						
R43	A2						
R44	A2						
R45	A2						
R46	A2						
R47	A1						
R48	A2						
R49	A2						
R50	A2						
R51	A2						
R52	A1						
R53	C2						
R54	A1						
R55	A1						
R56	A2						
R57	B2						
R58	A1						
R59	A1						
R60	A1						
R61	A2						
R62	B1						
R63	B1						
R64	B1						
R65	B1						
R66	B1						
R67	B1						
R68	B1						
R69	B1						
R70	B1						
R71	B1						
R72	B1						
R73	B2						
R75	B2						
R76	B1						
R77	B2						
R78	B2						
R79	B2						

P/O A3 Notch Filter-Notch Generating Circuits **SS3**
SEE REVERSE SIDE

Service

Model 8903B



Schematic General Information

CHANGES

<p>2717A to 2742A</p>	<p>On the A13 schematic:</p> <ul style="list-style-type: none"> • 08903-60192 - Change the part number of the A13 POWER SUPPLY AND MOTHERBOARD ASSEMBLY to 08903-60192.
<p>2813A and above</p>	<p>On the A13 schematic:</p> <ul style="list-style-type: none"> • 08903-60292 - Change the part number of the A13 POWER SUPPLY AND MOTHERBOARD ASSEMBLY to 08903-60292.

P/O A13 POWER SUPPLY AND MOTHERBOARD ASSEMBLY (08903-60129)

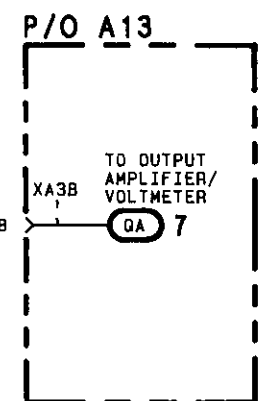
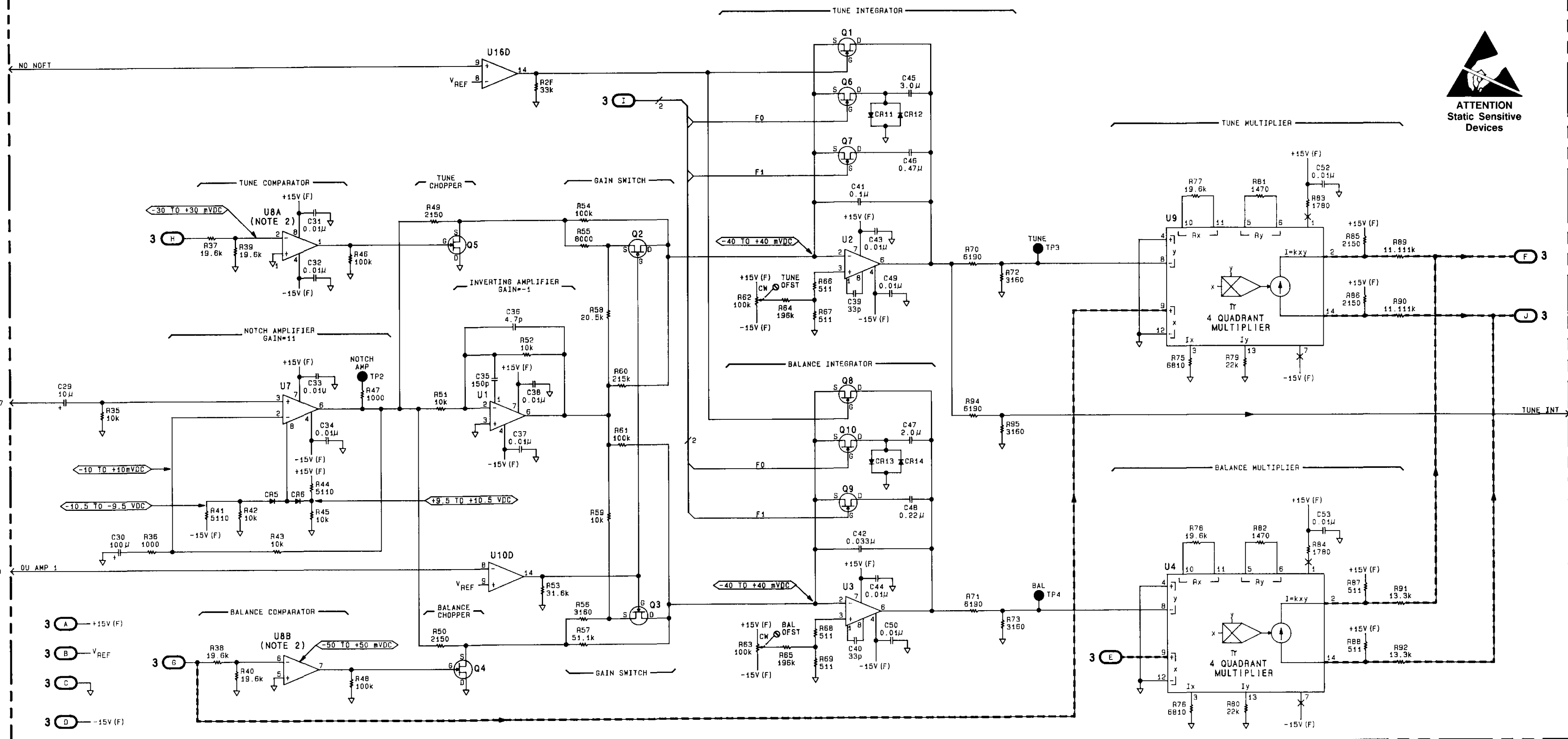
P/O A3 NOTCH FILTER ASSEMBLY (08903-60163)



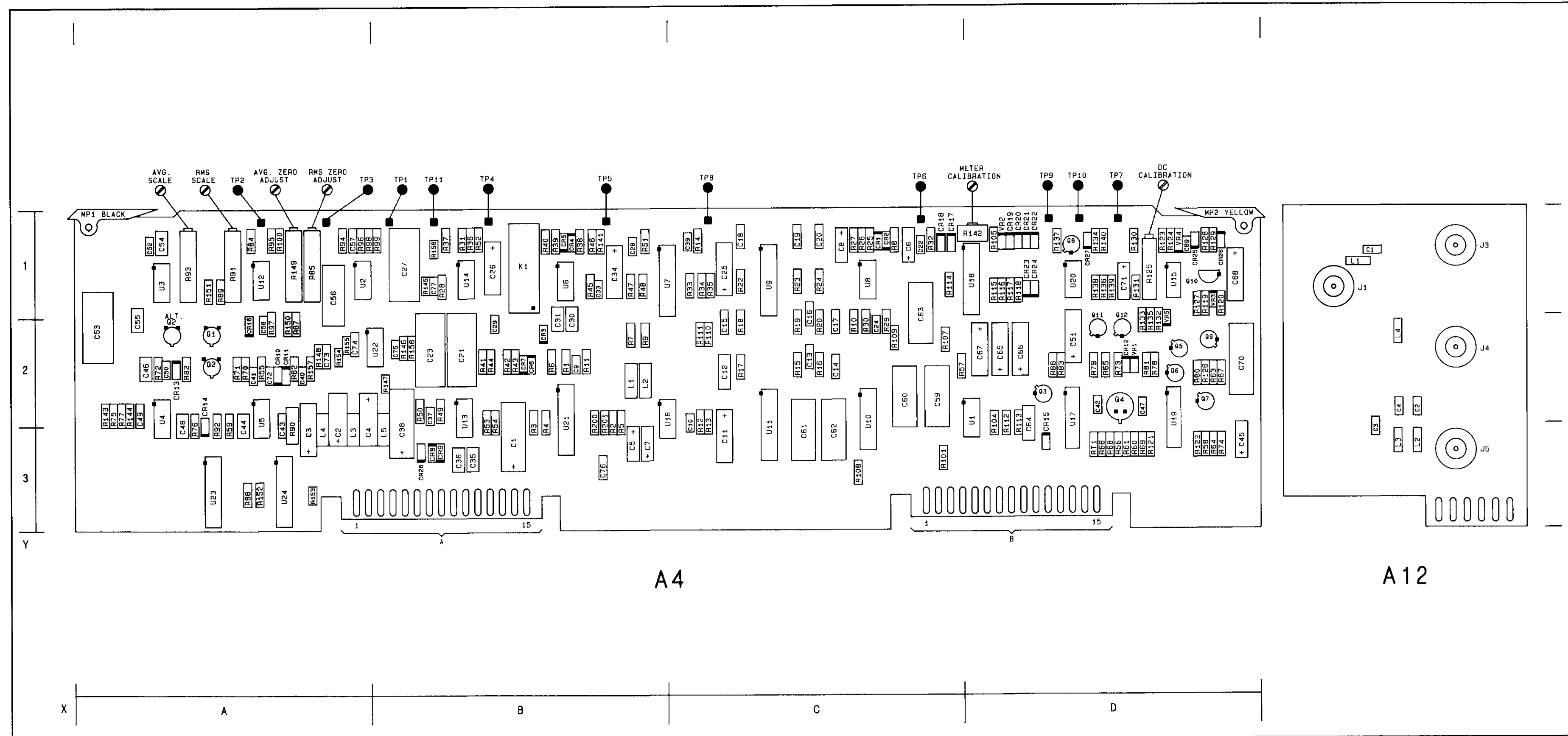
FROM LATCH P/O XA3B
12 NA

FROM OUTPUT AMPLIFIER
5 QA

FROM LATCH P/O XA3A
12 PA



SERIAL PREFIX: 2450A



Component Locator

Component Coordinates

COMP	X,Y	COMP	X,Y	COMP	X,Y	COMP	X,Y
C1	B3	R31	B1				
C2	A3	R32	C1				
C3	A3	R33	C1				
C4	A3	R34	C1				
C5	B3	R35	B1				
C6	B3	R36	B1				
C7	B3	R37	B1				
C8	C1	R38	B1				
C9	B2	R39	B1				
C10	B2	R40	C1				
C11	C2	R41	B2				
C12	C2	R42	B2				
C13	C2	R43	B2				
C14	C2	R44	B2				
C15	C2	R45	B1				
C16	C1	R46	B1				
C17	C2	R47	B1				
C18	C1	R48	B1				
C19	C1	R49	B2				
C20	C1	R50	B2				
C21	B2	R51	B1				
C22	C1	R52	B1				
C23	B2	R53	B2				
C24	C2	R54	B2				
C25	C1	R141	B1				
C26	B1						
C27	B1	TP3	A1				
C28	B1	TP4	B1				
C29	B2	TP5	C1				
C30	B2	TP6	B1				
C31	B2	TP8	C1				
C33	B1						
C34	B1	U7	C1				
C35	B3	U8	B3				
C36	B3	U9	C1				
C37	B2	U11	C1				
C38	C1	U13	B2				
C39	B3	U14	B1				
C76	B3	U21	B2				
CR1	C1						
CR2	C1						
CR3	C1						
CR4	B1						
CR5	B1						
CR6	B2						
CR7	B2						
CR8	B3						
CR9	B3						
CR20	B3						
K1	B1						
L1	B2						
L2	B2						
L3	A3						
L4	A3						
L5	B3						
R1	B2						
R2	B2						
R3	B2						
R4	B2						
R5	B2						
R6	B2						
R7	B2						
R8	C1						
R9	C2						
R10	C2						
R11	B2						
R12	C2						
R13	C2						
R14	C1						
R15	C2						
R16	C2						
R17	C2						
R18	C2						
R19	C2						
R20	C2						
R22	C1						
R23	C1						
R24	C1						
R25	C1						
R26	C1						
R27	C1						
R28	B1						
R29	C2						
R30	C2						

P/O A3 Notch Filter-Tune and Balance Circuits SS4
SEE REVERSE SIDE

NOTES

1. All the voltages shown are for no input, 1.11 SPCL and 3.1 SPCL.
2. Chassis ground is made by mechanical contact of connector to rear panel.

Schematic General Information

Figure 8B-114. SERVICE SHEET 5 INFORMATION

CHANGES

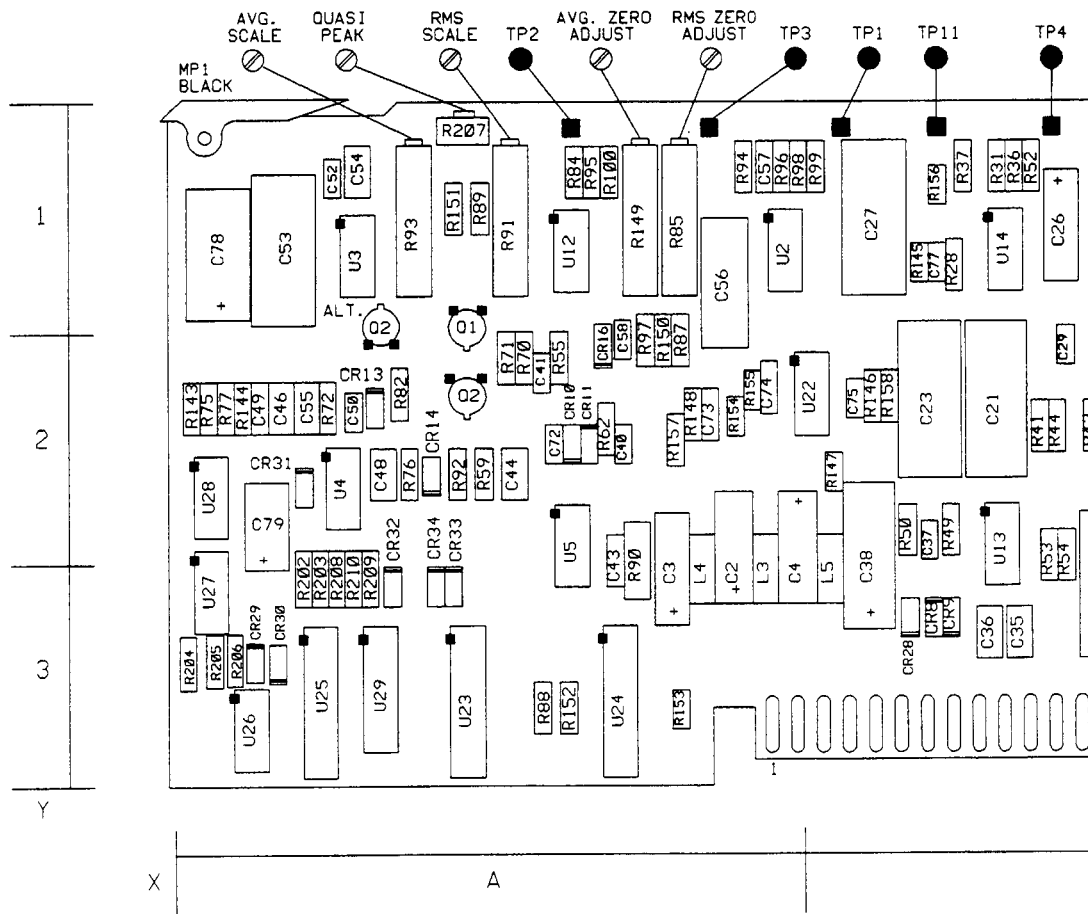
<p>All serial prefixes</p>	<p>On the A4 schematic:</p> <ul style="list-style-type: none"> • U21A - In the upper left hand corner locate U21A pin 13 and delete (F1) on the +15V supply line, locate U21A pin 4 and delete (F1) on the -15V supply line. • C32 - In the upper portion of the A4 schematic under LOW-PASS FILTERS PASS BAND GAIN-2 add C32 3.3 p in parallel to A4C16. • C18 - In the upper portion of the A4 schematic under LOW-PASS FILTERS PASS BAND GAIN-2 change the value of C18 to 91 pF. • U9A - In the upper portion of the A4 schematic under LOW-PASS FILTERS PASS BAND GAIN-2 locate U9A pin 13 and delete (F2) on the +15V supply line, locate U9A pin 4 and delete (F2) on the -15V supply line. <p>On the Component Locator:</p> <ul style="list-style-type: none"> • U1,U2,U6,U8,U12,U13 - U1, U2, U6, U8, U12 and U13 are round cans and the tabs should be in the 2:00 o'clock position. • R211 - On page 8B-114.4, in the lower left hand corner, add R211 between R209 and R210. <p>On the Component Coordinates:</p> <ul style="list-style-type: none"> • R211 - On page 8B-114.3 add R211 A,3, to the partial component coordinates table.
<p>2717A to 2742A</p>	<p>On the A13 schematic:</p> <ul style="list-style-type: none"> • 08903-60192 - Change the part number of the A13 POWER SUPPLY AND MOTHERBOARD ASSEMBLY to 08903-60192.
<p>2728A and below</p>	<p>On the A4 schematic:</p> <ul style="list-style-type: none"> • 08903-60282 - The 08903-60128 board is obsolete, to replace this board you must order the 08903-60282 (not Quasi- Peak). <p>Note: - The 08903-60282 (not Quasi-Peak) and the 08903-60283 (Quasi-Peak) are identical boards except for the positioning of W1. See partial schematic on page 8B-116.5, and the Component Locator on page 8B-114.4.</p>

CHANGES

<p>2730A to 2813A for HP8903B and 2730A to 2814A for HP8903E</p>	<p>On the A4 schematic:</p> <ul style="list-style-type: none"> • <u>08903-60183</u> - Change the A4 board part number 08903-60128 to <u>08903-60183</u> (Quasi-Peak). <p>On the Component Locator:</p> <ul style="list-style-type: none"> • <u>08903-60183</u> - Use the partial component locator on page 8B-114.3. <p>On the Component Coordinates:</p> <ul style="list-style-type: none"> • <u>08903-60183</u> - Use the partial component coordinates on page 8B-114.3.
<p>2813A and above</p>	<p>On the A13 schematic:</p> <ul style="list-style-type: none"> • <u>08903-60192</u> - Change the part number of the A13 POWER SUPPLY AND MOTHERBOARD ASSEMBLY to 08903-60292.
<p>2816A and above for HP8903B and 2818A and above for HP8903E</p>	<p>On the A4 schematic:</p> <ul style="list-style-type: none"> • <u>08903-60283</u> - Change the board part number to 08903-60283 (Quasi-Peak). <p>Note: - The 08903-60282 (not Quasi-Peak) and the 08903-60283 (Quasi-Peak) are identical boards except for the positioning of W1. See partial schematic on page 8B-116.5, and the Component Locator on page 8B-114.4.</p> <p>On the Component Locator:</p> <ul style="list-style-type: none"> • <u>08903-60283</u> - Use the new component locator on page 8B-114.4 for serial prefixes 2816A and above (8903B) and 2818A and above (8903E).

COMP	X, Y	COMP	X, Y	COMP	X, Y	COMP	X, Y	COMP	X, Y
C2	A, 3	CR10	A, 2	R72	A, 2	R152	A, 3	U26	A, 3
C3	A, 3	CR11	A, 2	R75	A, 2	R153	A, 3	U27	A, 3
C4	A, 3	CR13	A, 2	R76	A, 2	R154	A, 2	U28	A, 2
C40	A, 2	CR14	A, 2	R77	A, 2	R155	A, 2	U29	A, 3
C41	A, 3	CR16	A, 2	R82	A, 2	R157	A, 2		
C43	A, 3	CR29	A, 2	R84	A, 1	R202	A, 3		
C44	A, 2	CR30	A, 3	R85	A, 1	R203	A, 3		
C46	A, 2	CR31	A, 2	R87	A, 2	R204	A, 3		
C48	A, 2	CR32	A, 3	R88	A, 3	R205	A, 3		
C49	A, 2	CR33	A, 3	R89	A, 1	R206	A, 3		
C50	A, 2	CR34	A, 3	R90	A, 3	R207	A, 1		
C52	A, 1			R91	A, 1	R208	A, 3		
C53	A, 1	L3	A, 3	R92	A, 2	R209	A, 3		
C54	A, 1	L4	A, 3	R93	A, 1	R210	A, 3		
C55	A, 2			R94	A, 1				
C56	A, 1	MP1	A, 1	R95	A, 1	TP2	A, 1		
C57	A, 1			R96	A, 1	TP3	A, 1		
C58	A, 2	O1	A, 1	R97	A, 2				
C72	A, 2	O2	A, 2	R98	A, 1	U2	A, 1		
C73	A, 2	O2(ALT)	A, 1	R100	A, 1	U3	A, 1		
C74	A, 2			R143	A, 2	U4	A, 2		
C78	A, 1	R55	A, 2	R144	A, 2	U5	A, 2		
C79	A, 3	R59	A, 2	R148	A, 2	U12	A, 1		
		R62	A, 2	R149	A, 1	U23	A, 3		
		R70	A, 2	R150	A, 2	U24	A, 3		
		R71	A, 2	R151	A, 1	U25	A, 3		

Partial Component Coordinates for Figures 8B-114, 8B-116, and 8B-118. (2730A to 2813A for HP8903B) and (2730A to 2814A for the HP8903E)



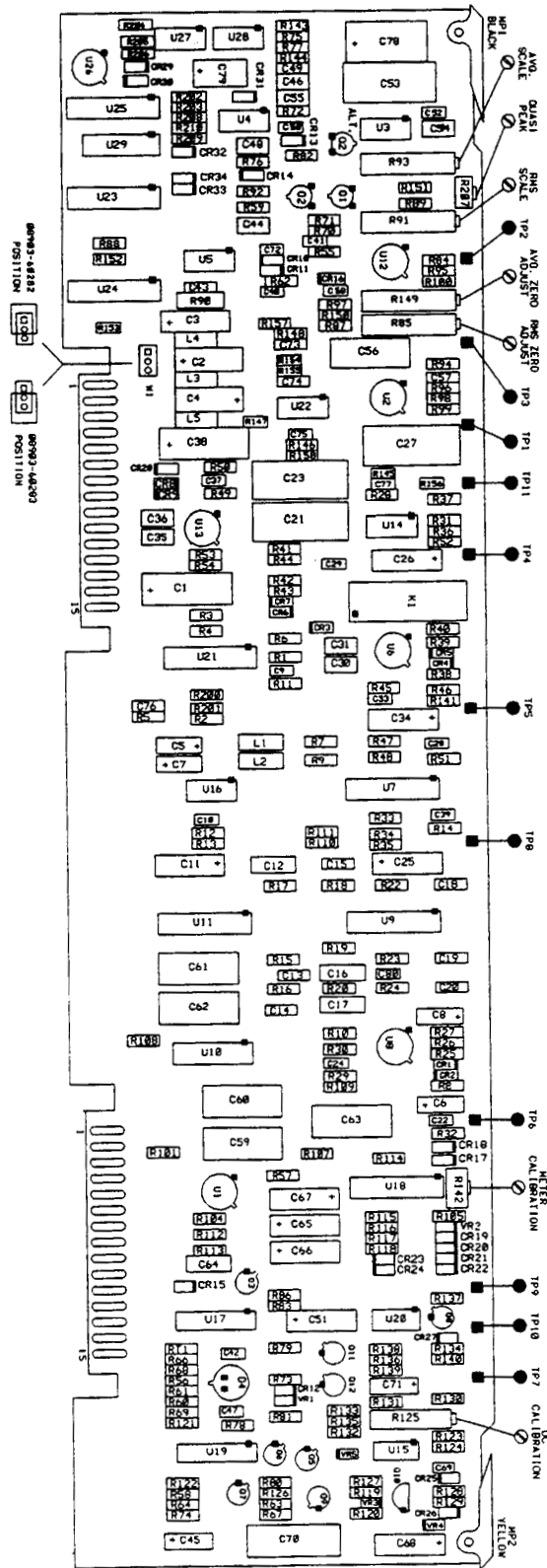
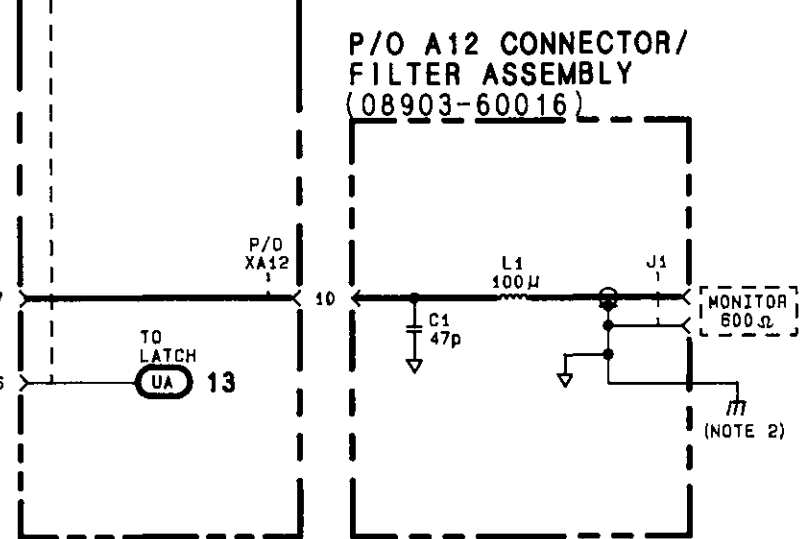
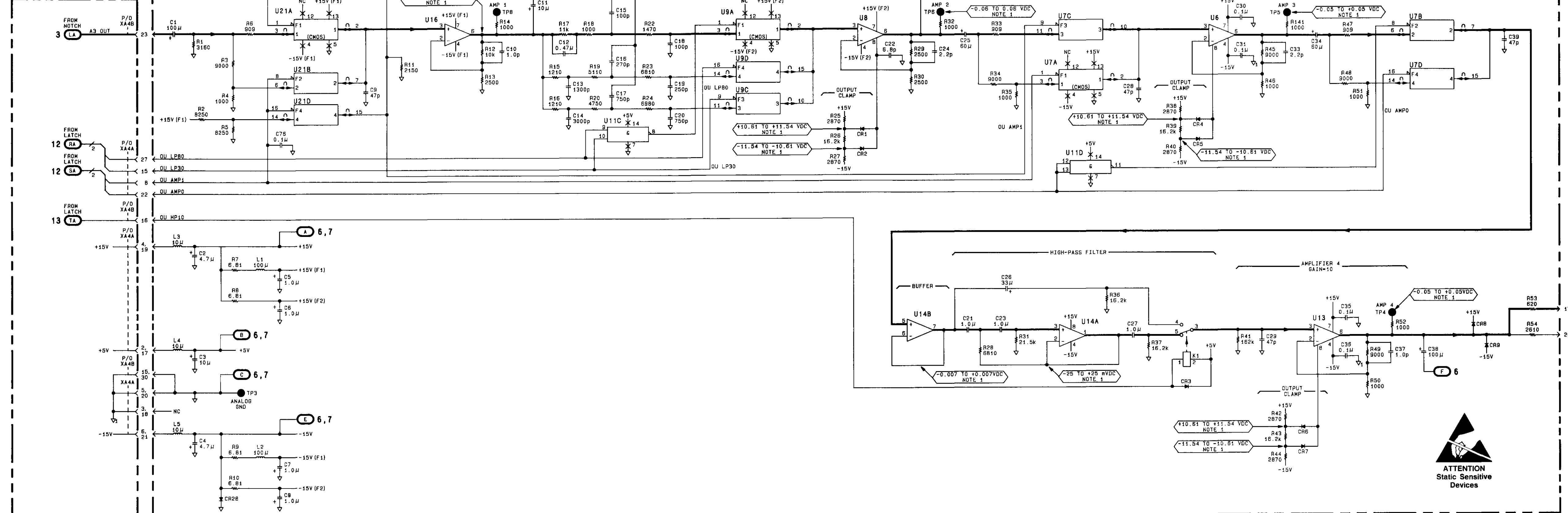


Figure 8B-114. Component Locator (8903B, 2816A and above)
Figure 8B-114. Component Locator (8903E, 2818A and above)

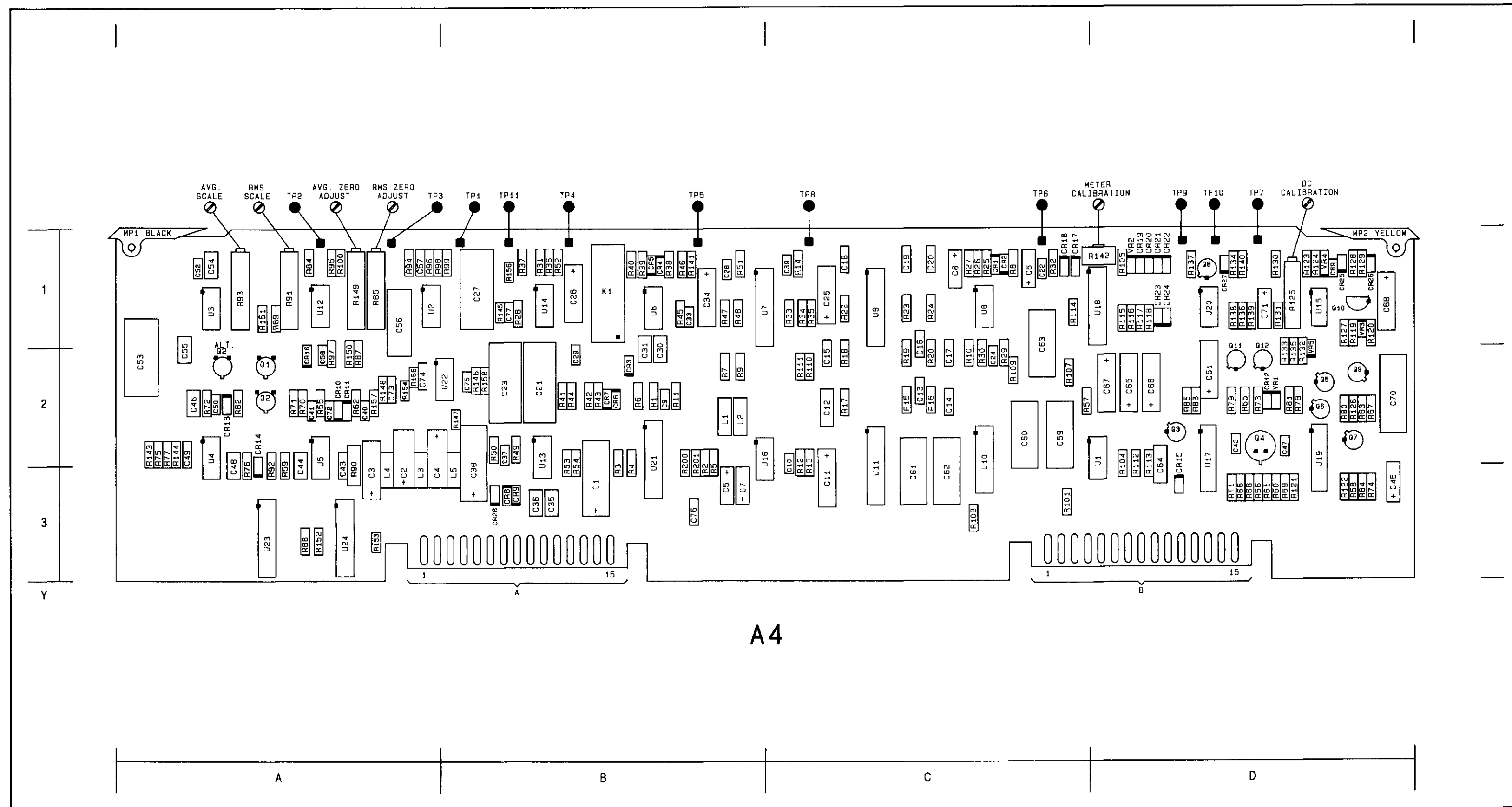
P/O A13 POWER SUPPLY AND MOTHERBOARD ASSEMBLY (08903-60129)

P/O A4 OUTPUT AMPLIFIER/VOLTMETER ASSEMBLY (08903-60128)

P/O A13



SERIAL PREFIX: 2450A



Component Locator

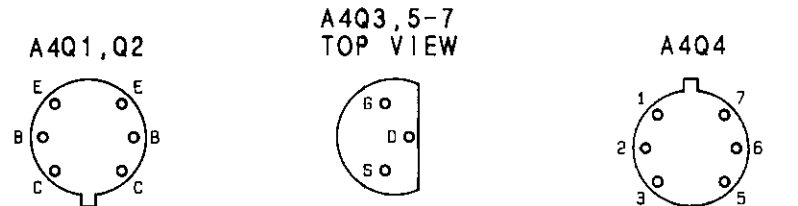
Component Coordinates

COMP	X, Y	COMP	X, Y	COMP	X, Y	COMP	X, Y
C40	A2	R142	D1				
C41	A2	R143	A2				
C42	D2	R144	A2				
C43	A2	R145	B1				
C44	A2	R146	B2				
C45	D3	R147	B2				
C46	A2	R148	A2				
C47	D2	R149	A1				
C48	A2	R150	A2				
C49	A2	R151	A1				
C50	A2	R152	A3				
C51	D2	R153	A3				
C52	A1	R154	A2				
C53	A2	R155	A2				
C54	A1	R156	B1				
C55	A2	R157	A2				
C56	A1	R158	B2				
C57	A1						
C58	A2	RT1	D3				
C72	A2						
C73	A2	B1					
C74	A2	TP2	A1				
C75	B2	TP11	B1				
C77	B1						
CR10	A2	U2	A1				
CR11	A2	U3	A1				
CR12	D2	U4	A2				
CR13	A2	U5	A2				
CR14	A2	U12	A1				
CR15	D3	U17	D2				
CR16	A2	U19	D2				
		U22	B2				
		U23	A3				
		U24	A3				
Q1	A2	VR1	D2				
Q2	A2						
Q3	D2						
Q4	D2						
Q5	D2						
Q6	D2						
Q7	D2						
R55	A2						
R56	D3						
R57	D2						
R58	D3						
R59	A2						
R60	D3						
R61	D3						
R62	A2						
R63	D2						
R64	D3						
R65	D2						
R66	D3						
R67	D2						
R68	D3						
R69	D3						
R70	A2						
R71	A2						
R72	A2						
R73	D2						
R74	D3						
R75	A2						
R76	A2						
R77	A2						
R78	D2						
R79	D2						
R80	D2						
R81	D2						
R82	A2						
R83	D2						
R84	A1						
R85	A1						
R86	D2						
R87	A2						
R88	A3						
R89	A1						
R90	A2						
R91	A1						
R92	A2						
R93	A1						
R94	A1						
R95	A1						
R96	A1						
R97	A2						
R98	A1						
R99	B1						
R100	A1						

P/O A4, Output Amplifier/Voltmeter-Output Amplifier
 A12
 SEE REVERSE SIDE **SS5**

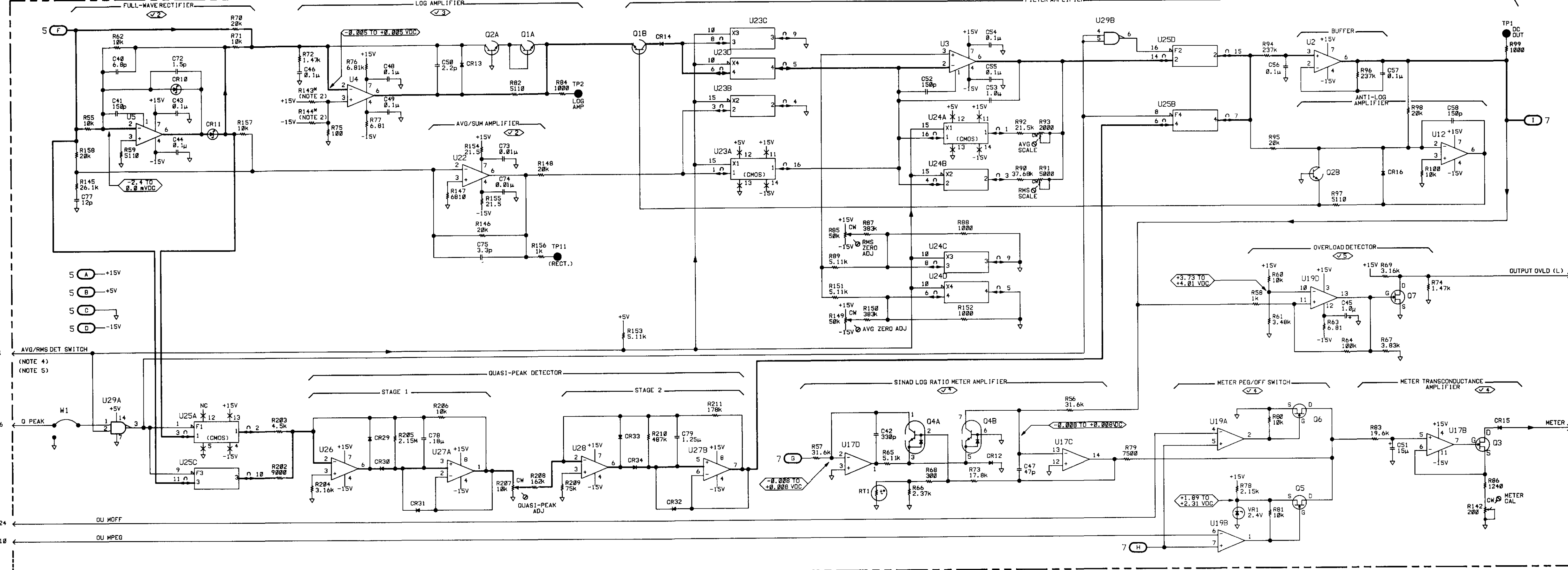
NOTES

- * Asterisk indicates factory selected values.
- These components are not normally loaded. Refer to Section 5 under VOLTMETER ADJUSTMENTS.
- All voltages shown are for 1-3 Vrms input at 1 kHz, with 1.11 SPCL and 3.1 SPCL.
- If the A4 OUTPUT AMPLIFIER/VOLTMETER ASSEMBLY (08903-60128) is to be used in an 8903A AUDIO ANALYZER as an RMS detector, pin 1 of the XA4A connector must be grounded. Otherwise, the A4 assembly will function as an AVG detector.

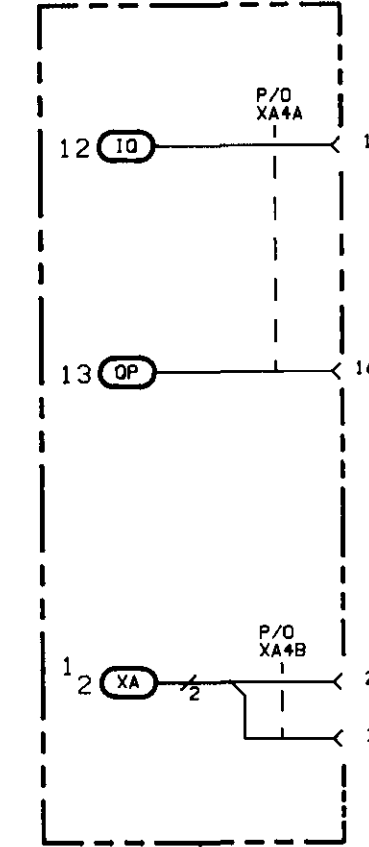


Schematic General Information

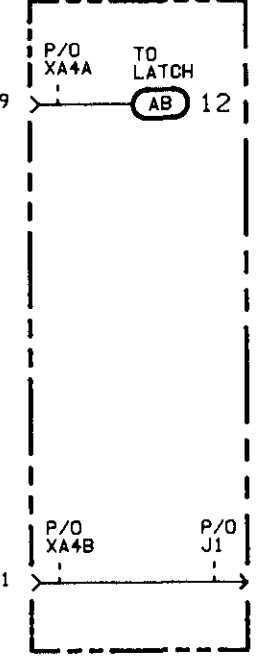
P/O A4 OUTPUT AMPLIFIER/VOLTMETER ASSEMBLY (08903-60183)



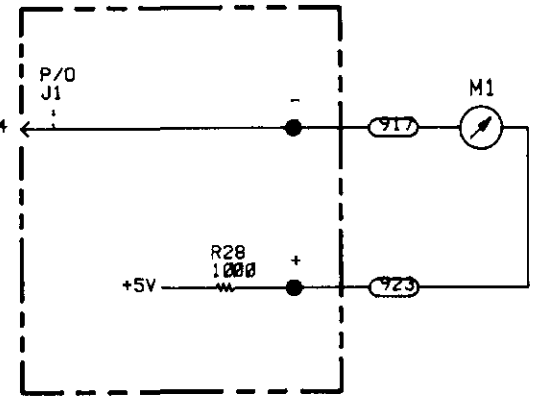
P/O A13
POWER SUPPLY AND
MOTHERBOARD
ASSEMBLY
(08903-60129)



P/O A13



P/O A1
KEYBOARD AND
DISPLAY ASSEMBLY
(08903-60166)



SERIAL PREFIX: 2738A

CHANGES

<p>All serial prefixes</p>	<p>On the Component Locator:</p> <ul style="list-style-type: none"> • U1,U2,U6,U8,U12,U13 - U1, U2, U6, U8, U12 and U13 are round cans and the tabs should be in the 2:00 o'clock position. • U29A - On the left hand side of the new A4 OUTPUT AMPLIFIER/VOLTMETER ASSEMBLY (08903-60183), locate U29A and change pin 1 to 2 and pin 2 to 1. • Delete the page number (8B-116.3) on the schematic foldout that is tied to serial prefix 2730A and replace it with a revision date of <i>rev.10MAY87</i>. • R211 - On page 8B-114.4, in the lower left hand corner of the component locator, add R211 between R209 and R210. <p>On the Component Coordinates:</p> <ul style="list-style-type: none"> • R211 - On page 8B-114.3, add R211 A,3, to the partial coordinates table.
<p>2717A to 2742A</p>	<p>On the A13 schematic:</p> <ul style="list-style-type: none"> • 08903-60192 - Change the part number of the A13 POWER SUPPLY AND MOTHERBOARD ASSEMBLY from 08903-60129 to 08903-60192.
<p>2728A and below</p>	<p>On the A4 schematic:</p> <ul style="list-style-type: none"> • SS6 - The 08903-60128 board is obsolete, to replace this board you must order the 08903-60282 (not Quasi-Peak). <p>Note: - The 08903-60282 (not Quasi-Peak) and the 08903-60283 (Quasi-Peak) are identical boards except for the positioning of W1. See partial schematic on page 8B-116.5, and the Component Locator on page 8B-116.6.</p>

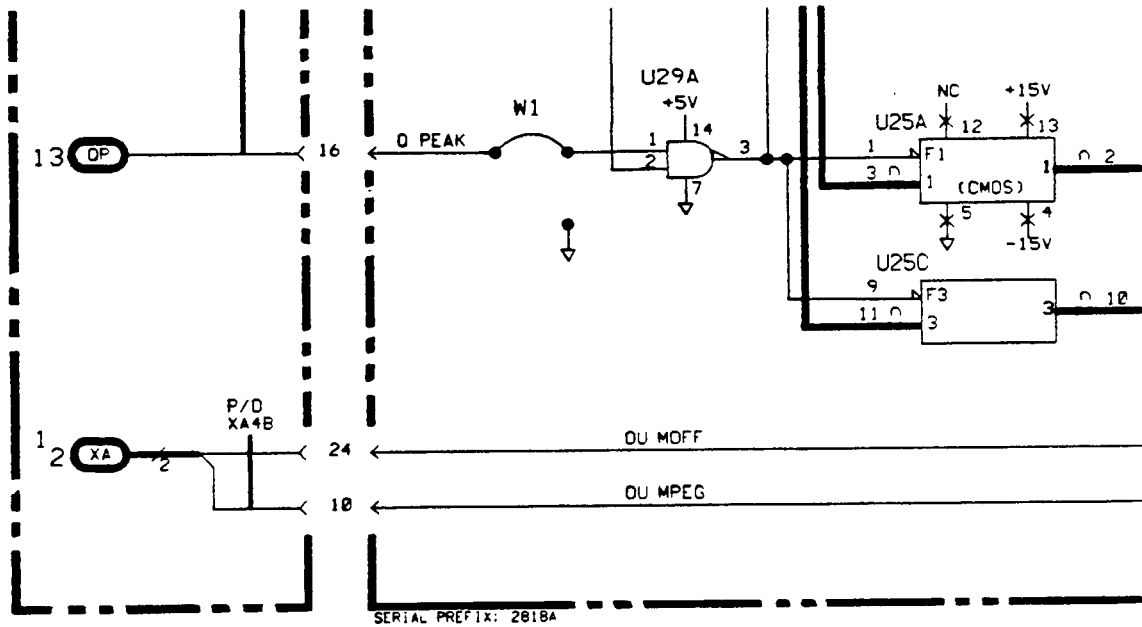
CHANGES

<p>2730A to 2813A for HP8903B and 2730A to 2814A for HP8903E</p>	<p style="text-align: center;">On the A4 schematic:</p> <ul style="list-style-type: none"> • A4 - Use the new schematic foldout on page 8B-116.3. Delete the page number (8B-116.3) and replace it with a revision date of <i>rev.10MAY87</i>. <p style="text-align: center;">On the Component Locator:</p> <ul style="list-style-type: none"> • A4 - Use the partial component locator on page 8B-114.3. <p style="text-align: center;">On the Component Coordinates:</p> <ul style="list-style-type: none"> • A4 - Use the partial component coordinates on page 8B-114.3. <p style="text-align: center;">Under "Notes":</p> <ul style="list-style-type: none"> • Add the following notes; <p>NOTE 5. When in 5.7 Special (Quasi) the AVG/RMS line is high.</p> <p>NOTE 6. Unused gates U29C and U29D have their inputs and outputs grounded.</p> <p style="text-align: center;">On the A13 schematic:</p> <ul style="list-style-type: none"> • SS6- Add the new schematic on page 8B-116.3, <i>rev.10MAY87</i>, (keep the original schematic.)
<p>2813A and above</p>	<p style="text-align: center;">On the A13 schematic:</p> <ul style="list-style-type: none"> • 08903-60292 - Change the part number of the A13 POWER SUPPLY AND MOTHERBOARD ASSEMBLY from 08903-60192 to 08903-60292.

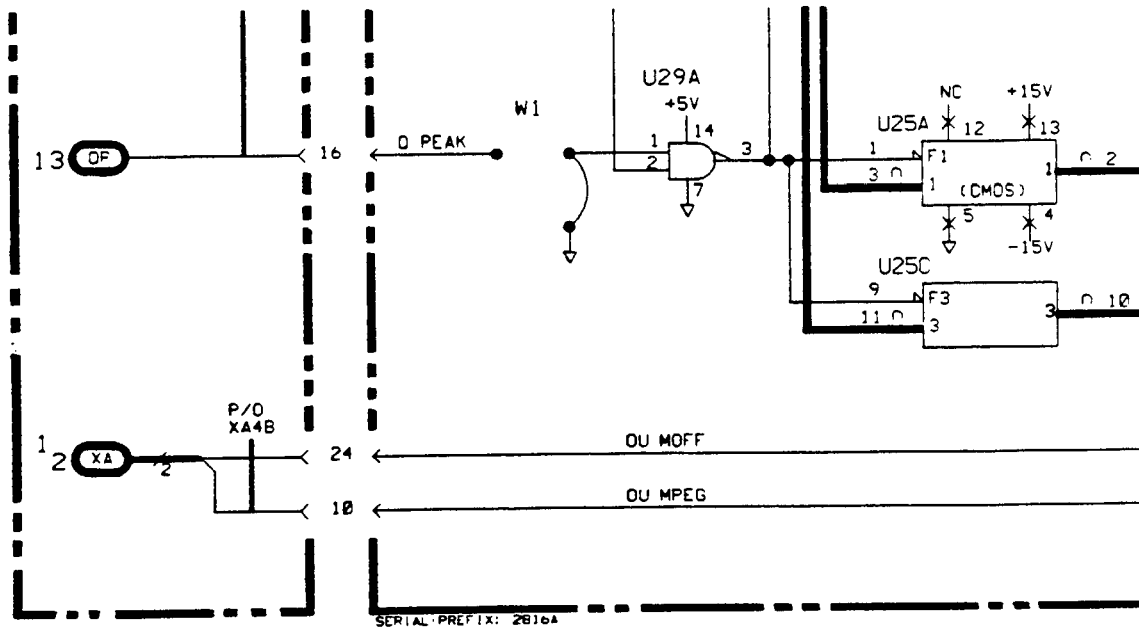
CHANGES

<p>2816A and above for HP8903B and 2818A and above for HP8903E</p>	<p style="text-align: center;">Under "Notes":</p> <ul style="list-style-type: none"> • Add the following notes; <p style="margin-left: 40px;">Note 7. The 08903-60183 does not have a W1 jumper wire.</p> <p style="margin-left: 40px;">Note 8. The 08903-60283 and the 08903-60282 are identical boards except for the position of the W1 jumper wire. See the partial schematic on page 8B-116.5, and the Component Locator on page 8B-116.6.</p> <p style="text-align: center;">On the A4 schematic:</p> <ul style="list-style-type: none"> • A4 - In the upper left hand corner of the schematic change the board part number to 08903-60283. <p style="margin-left: 40px;">Note: The 08903-60282 and 08903-60283 are identical boards except for the positioning of W1. See the partial schematic on page 8B-116.5, and the Component Locator on page 8B-116.6.</p> <ul style="list-style-type: none"> • SS6 - Use the schematic partial on page 8B-116.5. <p style="text-align: center;">On the Component Locator:</p> <ul style="list-style-type: none"> • A4 - Use the component locator on page 8B-116.6 for serial prefixes 2816A and above (8903B) and 2818A and above (8903E).

Reserved for future changes.



W1 Jumper in the 08903-60283 position.



W1 Jumper in the 08903-60282 position.

*Changes to Figure 8B-116.3 (8903E, 2818A and above)
Changes to Figure 8B-116.3 (8903B, 2816A and above)*

SS6

8B-116.5

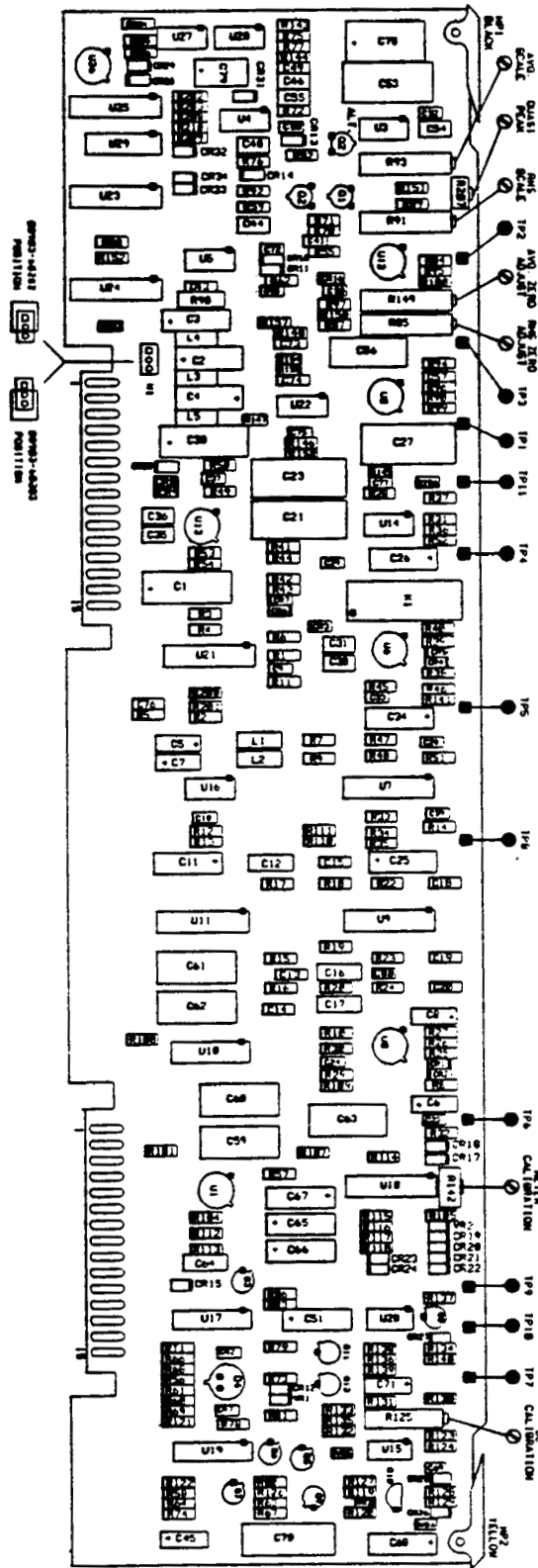
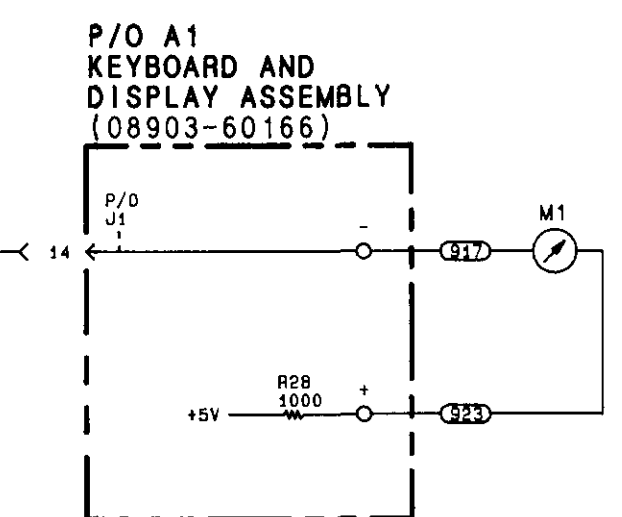
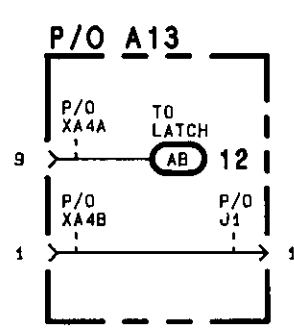
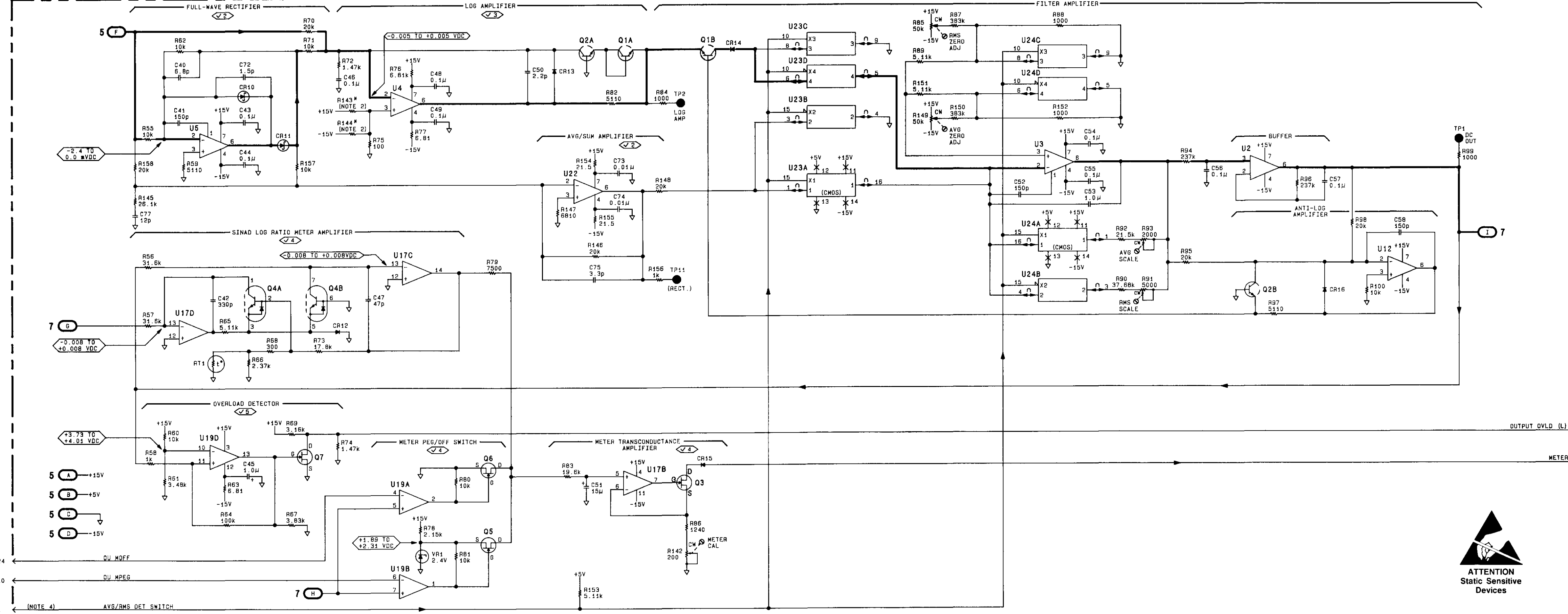
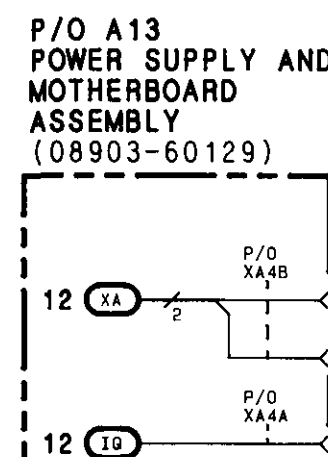
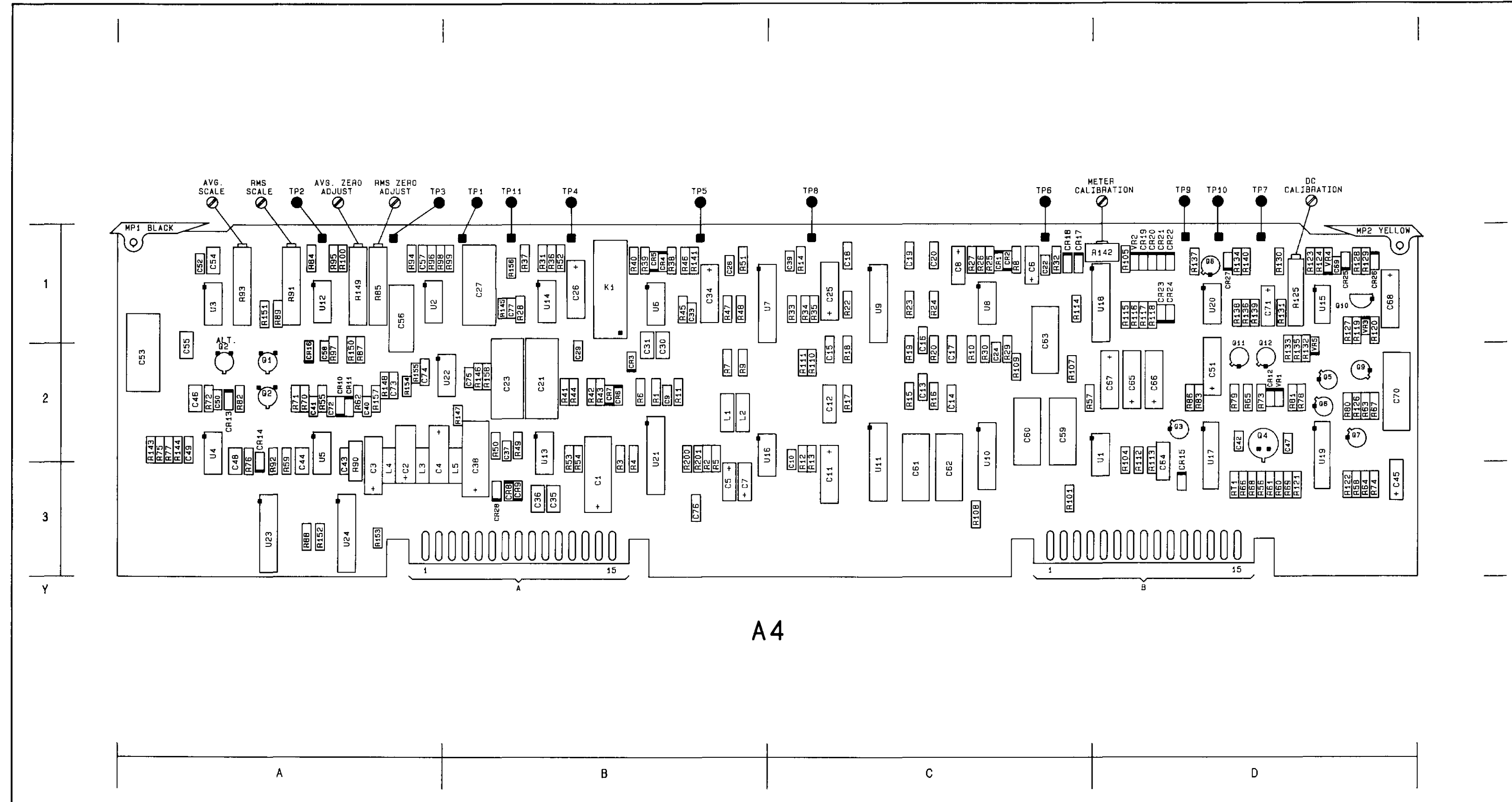


Figure 8B-116. Component Locator (8903E, 2818A and above)
Figure 8B-116. Component Locator (8903B, 2816A and above)

P/O A4 OUTPUT AMPLIFIER/VOLTMETER ASSEMBLY (08903-60128)



SERIAL PREFIX: 2450A



Component Locator

Figure 8B-118. SERVICE SHEET 7 INFORMATION

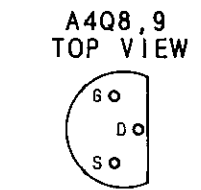
Component Coordinates

COMP	X,Y	COMP	X,Y	COMP	X,Y	COMP	X,Y
C59	C2	VR2	D1				
C60	C2	VR3	D1				
C61	C2	VR4	D1				
C62	C3	VR5	D2				
C63	C1						
C64	D2						
C65	D2						
C66	D2						
C67	D2						
C68	D1						
C69	D1						
C70	D2						
C71	D1						
CR17	C1						
CR18	C1						
CR19	D1						
CR20	D1						
CR21	D1						
CR22	D1						
CR23	D1						
CR24	D1						
CR25	D1						
CR26	D1						
CR27	D1						
Q8	D1						
Q9	D2						
Q10	D1						
Q11	D1						
Q12	D2						
R101	D3						
R104	D3						
R105	D3						
R107	D3						
R108	D3						
R109	D3						
R110	D3						
R111	D3						
R112	D3						
R113	D3						
R114	D3						
R115	D3						
R116	D1						
R117	D1						
R118	D1						
R119	D1						
R120	D1						
R121	D1						
R122	D1						
R123	D1						
R124	D1						
R125	D1						
R126	D1						
R127	D1						
R128	D1						
R129	D1						
R130	D1						
R131	D1						
R132	D1						
R133	D1						
R134	D1						
R135	D1						
R136	D1						
R137	D1						
R138	D1						
R139	D1						
R140	D1						
R200	D1						
R201	D1						
TP7	D1						
TP8	D1						
TP10	D1						
U1	D2						
U9	C1						
U10	C5						
U11	C5						
U15	D1						
U18	D1						
U19	D2						
U20	D2						
U21	D2						

P/O A1, A4 Output Amplifier/Voltmeter-Detector and Meter Circuits **SS6**
SEE REVERSE SIDE

NOTES

- Decouple probe with a 10k ohm resistor when measuring this voltage.
- Measured with respect to the +15 VDC supply.
- THE A4 OUTPUT AMPLIFIER/VOLTMETER ASSEMBLY (08903-60128) may retrofit to analyzers with serial prefixes 2306A or lower, having A3 NOTCH FILTER ASSEMBLY (08903-60105). To retrofit, carefully unsolder A4R101 and resolder this resistor between points A and B as shown on this schematic (SS7). Unsolder A4R200 and resolder this resistor between points C and D (on SS7). Solder pads and mounting holes are PROVIDED on the circuit board.
- If the A4 OUTPUT AMPLIFIER/VOLTMETER ASSEMBLY (08903-60128) is to be used in an 8903A AUDIO ANALYZER as an RMS detector, pin 1 of the XA4A connector must be grounded. Otherwise, the A4 assembly will function as an AVG detector.



Schematic General Information

CHANGES

<p>All serial prefixes</p>	<p>On the Component Locator:</p> <ul style="list-style-type: none"> • U1,U2,U6,U8,U12,U13 - U1, U2, U6, U8, U12 and U13 are round cans and the tabs should be in the 2:00 o'clock position • R211 - On page 8B-118.3, in the lower right hand corner of the component locator, add R211 between R209 and R210. <p>On the Component Coordinates:</p> <ul style="list-style-type: none"> • R211 - Add R211 A,3, to the partial component coordinate table on page 8B-114.3.
<p>2717A to 2742A</p>	<p>On the A13 schematic:</p> <ul style="list-style-type: none"> • 08903-60192 - Change the part number of the A13 POWER SUPPLY AND MOTHERBOARD ASSEMBLY from 08903-60129 to 08903-60192.
<p>2728A and below</p>	<p>On the A4 schematic:</p> <ul style="list-style-type: none"> • SS7 - The 08903-60128 board is obsolete, to replace this board you must order the 08903-60282 (not Quasi- Peak). • Note: - The 08903-60282 (not Quasi-Peak) and the 08903-60283 (Quasi-Peak) are identical boards except for the positioning of W1. See partial schematic on page 8B-116.5, and the Component Locator on page 8B-118.3.
<p>2730A to 2813A for HP8903B and 2730A to 2814A for HP8903E</p>	<p>On the A4 schematic:</p> <ul style="list-style-type: none"> • SS7 - Change the A4 board part number 08903-60128 to 08903-60183 (Quasi-Peak). <p>On the Component Locator:</p> <ul style="list-style-type: none"> • A4 - Use the partial component locator on page 8B-114.3. <p>In General Information:</p> <ul style="list-style-type: none"> • Add the following notes; • NOTE 5: When in 5.7 Special (Quasi) the AVG/RMS line is high. • NOTE 6: Unused gates U29C and U29D have their inputs and outputs grounded. <p>On the Component Coordinates:</p> <ul style="list-style-type: none"> • R211 - Use the partial component coordinates on page 8B-114.3.

CHANGES

<p>2813A and above</p>	<p>On the A13 schematic:</p> <ul style="list-style-type: none"> • 08903-60292 - Change the part number of the A13 POWER SUPPLY AND MOTHERBOARD ASSEMBLY from 08903-60192 to 08903-60292.
<p>2816A and above for HP8903B and 2818A and above for HP8903E</p>	<p>On the A4 schematic:</p> <ul style="list-style-type: none"> • In the upper left hand corner of the schematic change the A4 board part number 08903-60183 to 08903-60283. Note: The 08903-60282 is a direct replacement for the 08901-60128 for CPC. The 08903-60282 and the 08903-60283 are identical except for the positioning of W1 (see schematic partial on page 8B-116.5, and the Component Locator on page 8B-118.3). <p>On the Component Locator:</p> <ul style="list-style-type: none"> • A4 - Use the new component locator on page 8B-118.3 for serial prefixes 2816A and above (8903B) and 2818A and above (8903E).

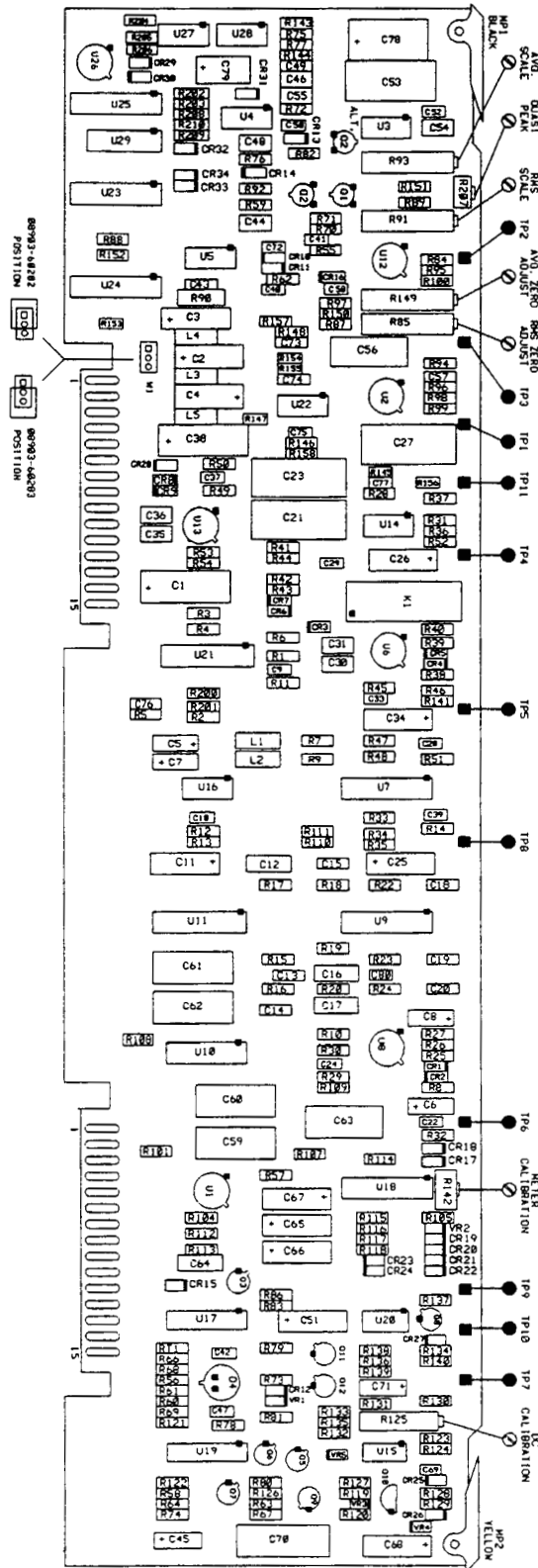
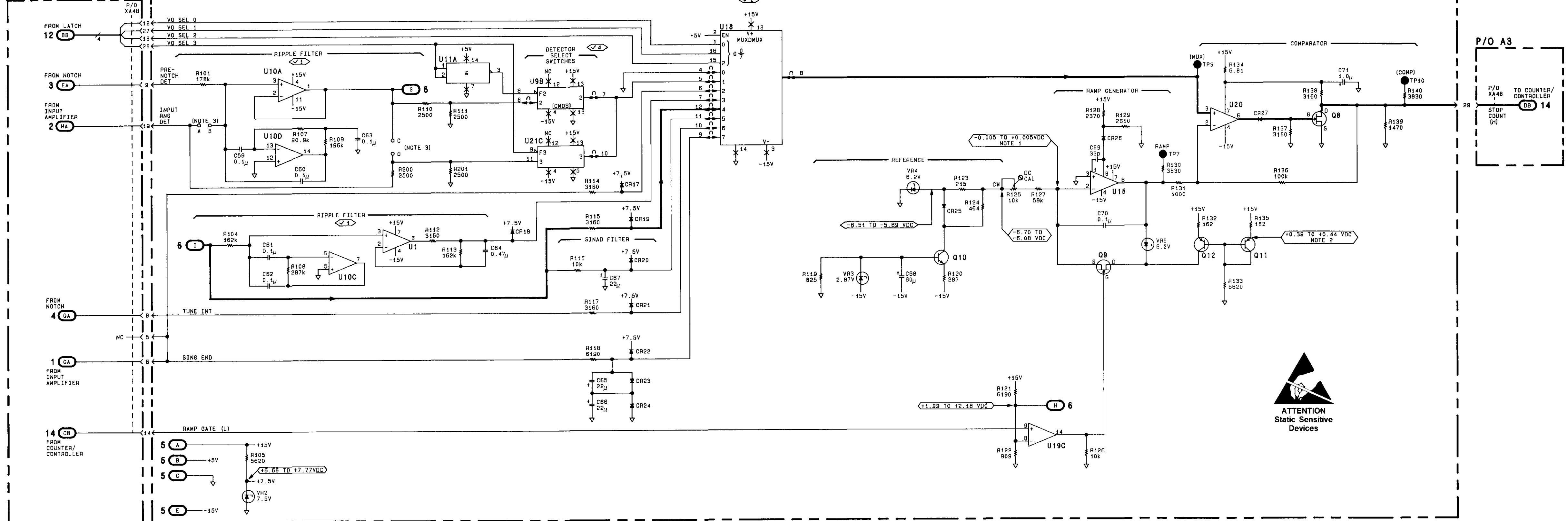


Figure 8B-118. Component Locator (8903B, 2816A and above)
Figure 8B-118. Component Locator (8903E, 2818A and above)

P/O A13 POWER SUPPLY AND MOTHERBOARD ASSEMBLY (08903-60129) P/O A4 OUTPUT AMPLIFIER/VOLTMETER ASSEMBLY (08903-60128)



SERIAL PREFIX: 2450A

SS7
Figure 8B-119
8B-119

Table 8-3. Key Scan Programs

HP 9825A (HPL)	HP 85A (BASIC)
0: fxd 0	10 FIXED 0
1: rem 728; llo 7	20 REMOTE 728
2: wrt 728, "60.SP"	30 LOCAL LOCKOUT 7
3: red 728,A	40 OUTPUT 728; "60.SP"
4: dsp A; jmp -1	50 ENTER 728; A
5: end	60 DISP A
	70 GOTO 50
	80 END

61.N Display HP-IB Status. Displays the status of the HP-IB lines selected by N. The display is in binary. See Service Sheet 19 for troubleshooting and a complete list of HP-IB mnemonics.

NOTE

Binary representations of the information in pointed brackets appear on the Audio Analyzer's displays.

- N=0 Displays <0> in the left display and <Addressed to Talk>. <Addressed to Listen> in the right display. This function reads back and displays the present state of the Talk and Listen Address Flip-Flops (A9U1A and U1B). For example, if the displays show 1 and 0, the Audio Analyzer is addressed to talk (and is unaddressed to listen). This means the Talk Address Flip-Flop is set (and the Listen Address Flip-Flop is reset).
- N=1 Displays <0> in the left display and <DAV>. <RFD>. <DAC> in the right display. This function reads back and displays the present state of the three bus handshake lines. <DAV> reflects the state of the Data Valid bus handshake line as being driven by the Audio Analyzer (1=being driven; 0=not being driven). Thus, when in Listen Only, this display will always show 0 for <DAV>. The <RFD> and <DAC> always track the bus lines Ready For Data and Data Accepted. For example, 1 for <RFD> means line Ready For Data is true (high).
- N=2 Displays <0> in the left display and <ATN>. <REN> in the right display. This function reads back and displays the present state of the ATN (Attention) bus control line and the state of the Remote Enable Flip-Flop. A 1 for either <ATN> or <REN> indicates ATN is true (low at the bus) or that the Remote Enable Flip-Flop is set.
- N=3 Displays <0> in the left display and <SPM>. <SRQ> in the right display. This function reads back and displays the state of the Serial-Poll Flip-Flop and the state of the SRQ bus control line as being driven by the Audio Analyzer. A 1 for either <SPM> or <SRQ> indicates the Audio Analyzer is in serial-poll mode (SPM) or that it is presently driving the SRQ bus control line.
- N=4 Displays PIO Port A with the most-significant bits in the left display and the least-significant bits in the right display. This function inputs and displays (without modifying) the data at PIO port A (A9U18). Leading zeros in both displays are blanked. The display is interpreted as shown in Table 8-4.
- N=5 Displays PIO Port B with the most-significant bits in the left display and the least-significant bits in the right display. This function is similar to Special Function 61.4 except PIO port B is displayed. The display is interpreted as shown in Table 8-5.
- N=6 Displays the HP-IB Status Register with <SPM> <STSO> <SRQ> <LLO> in the left display and <REM> <ADRSD> <TRIG> <HOLD/DELAY> in the right display. The status register is contained in RAM.