

Errata

Title & Document Type: 735A DC Transfer Standard Operating and Service Manual

Manual Part Number: 00735-90002

Revision Date: December 1969

About this Manual

We've added this manual to the Agilent website in an effort to help you support your product. This manual provides the best information we could find. It may be incomplete or contain dated information, and the scan quality may not be ideal. If we find a better copy in the future, we will add it to the Agilent website.

HP References in this Manual

This manual may contain references to HP or Hewlett-Packard. Please note that Hewlett-Packard's former test and measurement, life sciences, and chemical analysis businesses are now part of Agilent Technologies. The HP XXXX referred to in this document is now the Agilent XXXX. For example, model number HP8648A is now model number Agilent 8648A. We have made no changes to this manual copy.

Support for Your Product

Agilent no longer sells or supports this product. You will find any other available product information on the Agilent Test & Measurement website:

www.agilent.com

Search for the model number of this product, and the resulting product page will guide you to any available information. Our service centers may be able to perform calibration if no repair parts are needed, but no other support from Agilent is available.



Agilent Technologies

DC TRANSFER STANDARD 735A

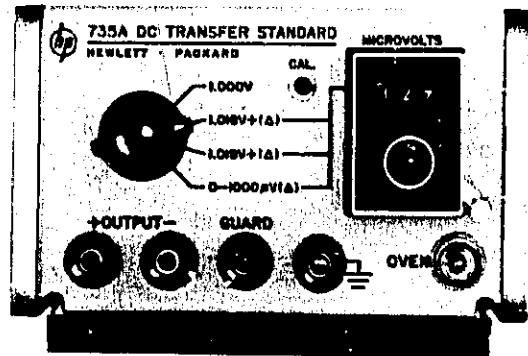

HEWLETT  PACKARD

HEWLETT  **PACKARD**

CERTIFICATION

The Hewlett-Packard Company certifies that this instrument was thoroughly tested and inspected and found to meet its published specifications when it was shipped from the factory. The Hewlett-Packard Company further certifies that its calibration measurements are traceable to the U.S. National Bureau of Standards to the extent allowed by the Bureau's calibration facility.

WARRANTY AND ASSISTANCE

All Hewlett-Packard products are warranted against defects in materials and workmanship. This warranty applies for one year from the date of delivery, or, in the case of certain major components listed in the operating manual, for the specified period. We will repair or replace products which prove to be defective during the warranty period provided they are returned to Hewlett-Packard. No other warranty is expressed or implied. We are not liable for consequential damages.

Service contracts or customer assistance agreements are available for Hewlett-Packard products that require maintenance and repair on-site.

For any assistance, contact your nearest Hewlett-Packard Sales and Service Office. Addresses are provided at the back of this manual.



OPERATING AND SERVICE MANUAL

(HP PART NO. 00735-90002)

**MODEL 735A
DC TRANSFER STANDARD**

SERIALS PREFIXED: 950-

Appendix C, Manual Backdating Changes,
adapts manual to serials prefixed 504-,
547-, and 825-.

Copyright Hewlett-Packard Company 1966
P.O. Box 301, Loveland, Colorado, 80537 U.S.A.

TABLE OF CONTENTS

<p>Section I GENERAL INFORMATION 1-1 1-1. Description 1-1 1-5. Application 1-1 1-8. Instrument Identification 1-1</p> <p>Section II INSTALLATION 2-1 2-1. Inspection 2-1 2-3. Installation 2-1 2-6. Three-Conductor Power Cable 2-1 2-9. Primary Power Requirements 2-1 2-11. Repackaging for Shipment 2-1</p> <p>Section III OPERATING INSTRUCTIONS 3-1 3-1. General 3-1 3-3. Front and Rear Panel Description 3-1 3-5. Application 3-1 3-7. Operating Procedure 3-1</p> <p>Section IV THEORY OF OPERATION 4-1 4-1. General 4-1 4-4. Overall Description 4-1 4-7. Basic Circuits 4-1 4-9. Oven Temperature Control Circuit 4-1 4-16. Precision Voltage Divider Output Circuits 4-2 4-22. Guarding 4-2</p>	<p>Section V MAINTENANCE 5-1 5-1. Introduction 5-1 5-3. Test Equipment Required 5-1 5-5. Performance Checks 5-1 5-7. Transfer Standard Output Accuracy 5-2 5-8. Output Impedance Check 5-2 5-9. Output Noise Check 5-2 5-10. Short Circuit Current 5-3 5-11. Variable Output Accuracy, Impedance and Noise Check 5-3 5-12. Adjustment and Calibration Procedure 5-3 5-14. Calibration Procedure 5-4 5-15. Troubleshooting Techniques 5-4 5-21. Servicing the Etched Circuit Boards 5-5 5-24. Removal of Oven 5-6 5-26. Removal of Q1 (Heater Transistor) 5-6</p> <p>Section VI REPLACEABLE PARTS 6-1 6-1. Introduction 6-1 6-4. Ordering Information 6-1 6-6. Non-Listed Parts 6-1</p>
--	---

APPENDIX

A CODE LIST OF MANUFACTURERS

B SALES AND SERVICE OFFICES

C -hp- MANUAL BACKDATING CHANGES

LIST OF TABLES

<p>Number Page 1-1. Specifications 1-0 5-1. Test Equipment Required 5-1 5-2. Accuracy Check 5-3</p>	<p>Number Page 5-3. Troubleshooting Summary 5-6 5-4. Troubleshooting Procedures 5-7 6-1. Reference Designation Index 6-2 6-2. Replaceable Parts 6-4</p>
---	--

LIST OF ILLUSTRATIONS

<p>Number Page 1-1. Model 735A DC Transfer Standard 1-0 3-1. Front and Rear Panel Description 3-0 3-2. Operation as a DC Standard 3-2 3-3. Operation as a Transfer Standard 3-3 4-1. 735A Block Diagram 4-0 5-1. Standard Output Accuracy Check 5-2 5-2. Output Noise Test Setup 5-3</p>	<p>Number Page 5-3. Adjustment and Calibration Test Setup 5-4 5-4. Top View 5-5 5-5. Transistor Mounting 5-7 5-6. A1 Component Location 5-8 5-7. A2 Component Location 5-8 5-8. S1 Component Location 5-9/5-10 5-9. Model 735A Schematic 5-9/5-10</p>
--	---

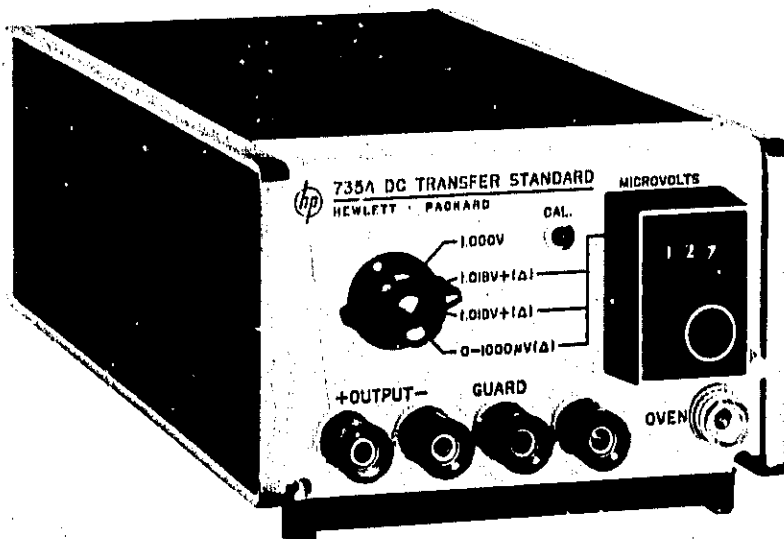

Figure 1-1. Model 735A DC Transfer Standard

Table 1-1. Specifications

<p>Standard Outputs: 1.00000 v; 1.018 $\pm \Delta\%$; 1.019 $\pm \Delta\%$; 0 to 1000 μv $\Delta\%$.</p>	<p>Output Noise: DC to 1 cps: $<1 \mu\text{v}$ p-p. 1 cps to 1 Mc: $<100 \mu\text{v}$ rms.</p>
<p>Transfer Accuracy: (after 30 min. warmup) 2 ppm between saturated standard cells or unsaturated standard cells; 10 ppm standard cell to 1 volt; 10 ppm saturated standard cell to unsaturated standard cells. (Typically better than 5 ppm.)</p>	<p>Output: Floating and guarded.</p>
<p>Stability: (After 30 min. warmup) Better than 10 ppm/month.</p>	<p>Power: 115 or 230 volts $\pm 10\%$, 50 to 1000 cps, approximately 12 watts.</p>
<p>Line Regulation: $<1 \mu\text{v}$ for 10% line change.</p>	<p>Output Terminals: Four 5-way binding posts. Positive, negative, circuit guard shield, and chassis ground; positive and negative terminals are solid copper with gold flash. A maximum of 500 volts dc may be connected between chassis ground and guard or circuit ground.</p>
<p>Output Impedance: 1 K ohm, $\pm 1\%$.</p>	<p>Effective Guarded Capacity: <25 pf (capacity) between circuit and chassis ground with shield driven.</p>
<p>Short Circuit Current: <1.5 ma</p>	<p>Dimensions: Standard 1/3 module, 3-14/32" high, 5-1/8" wide, 11" deep (87 x 130 x 279 mm).</p>
<p>Temperature Coefficient: <1 ppm/$^{\circ}\text{C}$, 0° to $+50^{\circ}\text{C}$.</p>	<p>Weight: Net: 5-1/2 lbs. (2,5 kg); shipping: 8 lbs. (3,6 kg).</p>
<p>Variable Output:</p>	
<p>RANGE: 0 to 1000 μv</p>	
<p>ACCURACY: 0.1% $\pm 1.5 \mu\text{v}$</p>	
<p>RESOLUTION: 1 μv</p>	
<p>OUTPUT IMPEDANCE: 146 ohms $\pm 1\%$</p>	
<p>*A 3-digit direct-reading 0 to 1000 μv offset voltage.</p>	

SECTION GENERAL INFORMATION

1-1. DESCRIPTION.

1-2. The -hp- Model 735A is a DC Transfer Standard (Figure 1-1) that may be used as a one volt dc standard, as a standard cell comparator, as a transfer standard for 1.000000 volt and voltages from 1.018000 volts to 1.020000 volts and as a dc supply for voltages from 0 to 1000 microvolts. For accuracy in these various functions, see Table 1-1, Specifications.

1-3. A function selector switch on the front panel selects output voltages of 1.000000 volts, 1.018000 volts +(Δ), 1.019000 volts +(Δ) and (Δ) 0-1000 microvolts. In the 1.019 + Δ position of the function switch, the output voltage may be varied from 1.019000 to 1.020000 with 1 microvolt resolution. The position of the 0-1000 microvolt control determines the last three digits. In the 1.018 + Δ position of the function switch, the output voltage may be varied from 1.018000 to 1.019000 with a 1 microvolt resolution. In the 1.000 volt position, the voltage can not be varied. The output is 1.000000 volts. The 0-1000 (Δ) microvolt position of the function switch has a resolution of 1 microvolt using the microvolt control only.

1-4. These voltages are obtained from the positive and negative OUTPUT terminals. An additional two terminals, connected to the guard (shield) and to chassis ground, are located on the front panel for versatile usage.

1-5. APPLICATION.

1-6. The stability and temperature coefficient of the 735A, as well as its small size and ruggedness, make it adaptable for comparing field instruments against working standards. Although the standard laboratory environment is still the ideal condition for checking precision dc measurements, the stability and accuracy of the standard laboratory may be obtained in the field by using the Hewlett-Packard Model 735A and accurate dc differential or null voltmeters. See Application Note 70 for further methods of using the 735A.

1-7. When using the 735A as a voltage source, the stability is within specifications independent of the load. However, in the first three positions of the function switch, the load must be 100 megohms or more for the accuracy to be within specifications. See Figure 3-2 and the example in the note.

1-8. INSTRUMENT IDENTIFICATION.

1-9. Hewlett-Packard uses a two-section eight-digit serial number (000-00000). If the first three digits of the serial number on your instrument do not agree with those on the title page of this manual, change sheets supplied with the manual will define differences between your instrument and the Model 735A described in this manual.

1-10. If E or G prefixes the serial number, the instrument is manufactured in Europe. E denotes England, and G denotes Germany.

INSTALLATION

SECTION II INSTALLATION

2-1. INSPECTION.

2-2. This instrument was carefully inspected both mechanically and electrically before shipment. It should be physically free of marks or scratches and in perfect electrical order upon receipt. To confirm this, the instrument should be inspected for physical damage in transit. Also, test the electrical performance of the instrument using the procedure outlined in Paragraph 5-5. If there is damage in shipping, file a claim with your carrier and refer to the warranty on the inside front cover of this manual.

2-3. INSTALLATION.

2-4. The 735A is a one-third module unit and is designed as a bench-type instrument. If it is desired to rack mount this instrument with other submodule units, the 1051A and 1052A combining cases are designed for this purpose. Contact your local -hp- Sales and Service Office for additional information. (See list in Appendix B for location.) The installation instructions are included with the case.

2-5. The -hp- Model 735A is fully transistorized; therefore no special cooling is required. However, the instrument should not be operated where the ambient temperature exceeds 55°C (131°F).

2-6. THREE-CONDUCTOR POWER CABLE.

2-7. To protect operating personnel, the National Electrical Manufacturers' Association (NEMA) recommends that the instrument panel and cabinet be grounded. All Hewlett-Packard instruments are equipped with a three-conductor power cable which, when plugged into an appropriate receptacle, grounds the instrument. The offset pin on the power cable three-prong connector is the ground wire.

2-8. To preserve the protection feature when operating the instrument from a two-contact outlet, use a three-prong to two-prong adapter and connect the green pigtail on the adapter to ground (-hp- Part No. 1251-0048).

2-9. PRIMARY POWER REQUIREMENTS.

2-10. The Model 735A is operated from an ac source of either 115 or 230 volts, 50 to 1000 cycles. Before connecting the instrument to a power source, check to make sure that the slide switch, located on the rear panel, designates the voltage to be used.

2-11. REPACKAGING FOR SHIPMENT.

2-12. The following is a general rule for repackaging an instrument for shipment. If you have any questions, contact your local Sales and Service Office (see lists in Appendix for location).

NOTE

If the instrument is to be shipped to Hewlett-Packard for service or repair, attach a tag to the instrument identifying the owner and indicating the service or repair to be accomplished; include the model number, and full serial number of the instrument. In any correspondence identify the instrument by model number and serial number prefix.

- a. Place instrument in original container if available. If not available, one may be purchased from your nearest -hp- Sales and Service Office.

If original container is not used,

- b. Wrap instrument in heavy paper or plastic before placing in inner container.
- c. Use plenty of packing material around all sides of instrument and protect panel faces with cardboard strips.
- d. Use a heavy carton or wooden box to house the instrument and inner container and use strong tape or metal bands to seal the shipping container.
- e. Mark shipping container with "Delicate Instrument," "Fragile" etc.

OPERATION

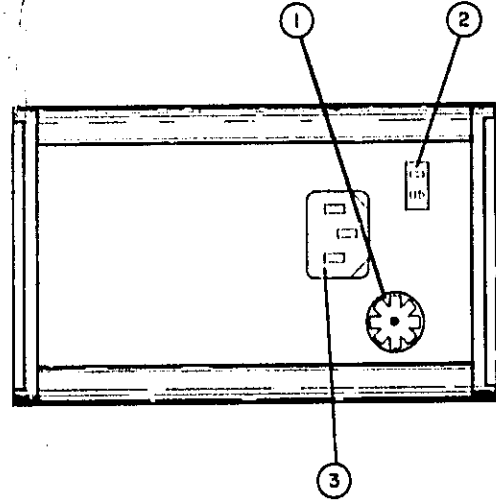
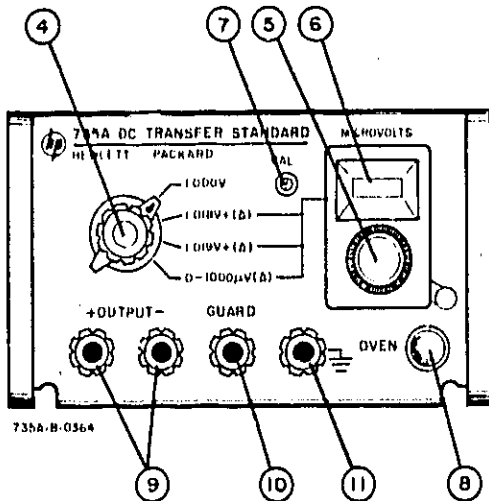

- ① Fuseholder, with 3/4 amp fuse.
- ② Slide switch: 115 V/230 V operation (its position plays source voltage to be used).
- ③ Power input connector: connects to a detachable power cable.
- ④ Function switch: selects one of four voltage outputs. Delta is from 0-1000 microvolts as selected by control ⑤ and readout ⑥. In the second and third position of the function switch, the value selected with ⑤ and read on ⑥ is added to the designated voltage at that position. Example: In the second position, (1.018 +Δ), for a voltage output of 1.018xxx volts, the delta control must be set for a readout of xxx; if 1.018 (150) is desired, the delta control must be set to read 150. In the volts position of the function switch, the output voltage will be delta only as adjusted by the control (0 to 1000 microvolts in 1 microvolt steps).
- ⑤ MICROVOLT Control: adjusts the delta voltage in microvolts. Knob in depressed position locks the readout voltage. On later models a lever on the right of the dial assembly is depressed to lock.
- ⑥ MICROVOLT Readout: digital reading of delta voltage to three places. If 1000 microvolts is desired turn the control clockwise beyond 999 for a reading of 000. (The one does not show on the readout.) The top stop will read approximately 1002 microvolts.
- ⑦ CAL: fine adjustment for 1.020000 volts or used for exact adjustment to a known voltage when the 735A is used as a transfer standard.
- ⑧ OVEN Light: glows brightly for approximately 15 minutes after connected to an external power source, then dims to glow proportionally to the power supplied to the oven heater. This indicates that the operating temperature of the oven has been reached.
- ⑨ Floating OUTPUT Terminals: the output voltage is selected by the function switch and the MICROVOLT control.
- ⑩ GUARD Terminal: connected to the internal chassis (shield).
- ⑪ Chassis Ground ($\frac{\perp}{\perp}$) Terminal: connected to the frame of the instrument and to power line ground.

Figure 3-1. Front and Rear Panel Description

SECTION III

OPERATING INSTRUCTIONS

3-1. GENERAL.

3-2. The -hp- Model 735A DC Transfer Standard has a four position function switch to select the following output voltages: 1.000 volt, fixed; 1.018 volts, variable in microvolt increments to 1.019 volts; 1.019 volts, variable in microvolt increments to 1.020 volts; and 0 to 1000 microvolts with 1 microvolt resolution. These output voltages are applied to the OUTPUT terminals designated + and - according to the position of the selector switch. The output terminal engraved Guard is connected to the two shield boxes inside the instrument which encase a major portion of the components of this instrument. The output terminal marked \oplus is connected to the outside case of the instrument and to power line ground.



DO NOT APPLY MORE THAN 500 VOLTS BETWEEN ANY TWO OF THESE THREE TERMINALS (-OUTPUT, GUARD, OR CHASSIS GROUND \oplus).

3-3. FRONT AND REAR PANEL DESCRIPTION.

3-4. Figure 3-1 gives the keyed description of the front and rear panel components.

3-5. APPLICATION.

3-6. The stability and accuracy of this instrument, its rugged construction and its selective output voltages make it more advantageous, when used as a DC Standard, than a standard cell. The 735A may be used as a Transfer Standard between saturated or unsaturated standard cells and between a known voltage and an unknown voltage (a precision voltage divider may be used). 0 to 1000 microvolts may be used as a source voltage. See -hp- Application Note 70 for additional advantages and uses.

3-7. OPERATING PROCEDURE.

3-8. Operating instructions for the 735A when used as a DC Standard are given in Figure 3-2. Operating instructions for the 735A when used as a DC Transfer Standard are given in Figure 3-3.

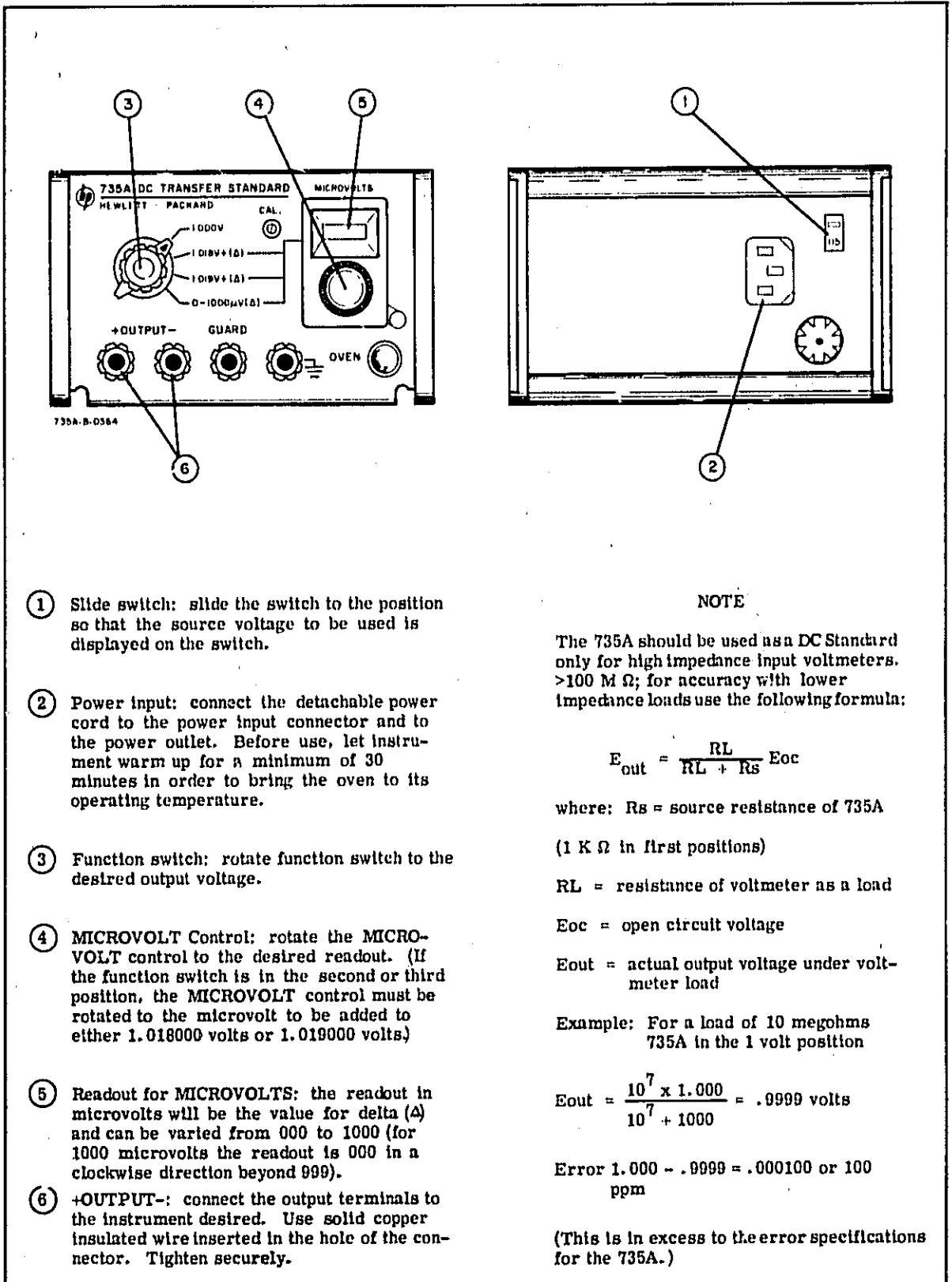

- ① Slide switch: slide the switch to the position so that the source voltage to be used is displayed on the switch.
- ② Power input: connect the detachable power cord to the power input connector and to the power outlet. Before use, let instrument warm up for a minimum of 30 minutes in order to bring the oven to its operating temperature.
- ③ Function switch: rotate function switch to the desired output voltage.
- ④ MICROVOLT Control: rotate the MICROVOLT control to the desired readout. (If the function switch is in the second or third position, the MICROVOLT control must be rotated to the microvolt to be added to either 1.018000 volts or 1.019000 volts.)
- ⑤ Readout for MICROVOLTS: the readout in microvolts will be the value for delta (Δ) and can be varied from 000 to 1000 (for 1000 microvolts the readout is 000 in a clockwise direction beyond 999).
- ⑥ +OUTPUT-: connect the output terminals to the instrument desired. Use solid copper insulated wire inserted in the hole of the connector. Tighten securely.

NOTE

The 735A should be used as a DC Standard only for high impedance input voltmeters. $>100 \text{ M } \Omega$; for accuracy with lower impedance loads use the following formula:

$$E_{\text{out}} = \frac{R_L}{R_L + R_s} E_{\text{oc}}$$

where: R_s = source resistance of 735A

(1 K Ω in first positions)

R_L = resistance of voltmeter as a load

E_{oc} = open circuit voltage

E_{out} = actual output voltage under voltmeter load

Example: For a load of 10 megohms 735A in the 1 volt position

$$E_{\text{out}} = \frac{10^7 \times 1.000}{10^7 + 1000} = .9999 \text{ volts}$$

$$\text{Error } 1.000 - .9999 = .000100 \text{ or } 100 \text{ ppm}$$

(This is in excess to the error specifications for the 735A.)

Figure 3-2. Operation as a DC Standard

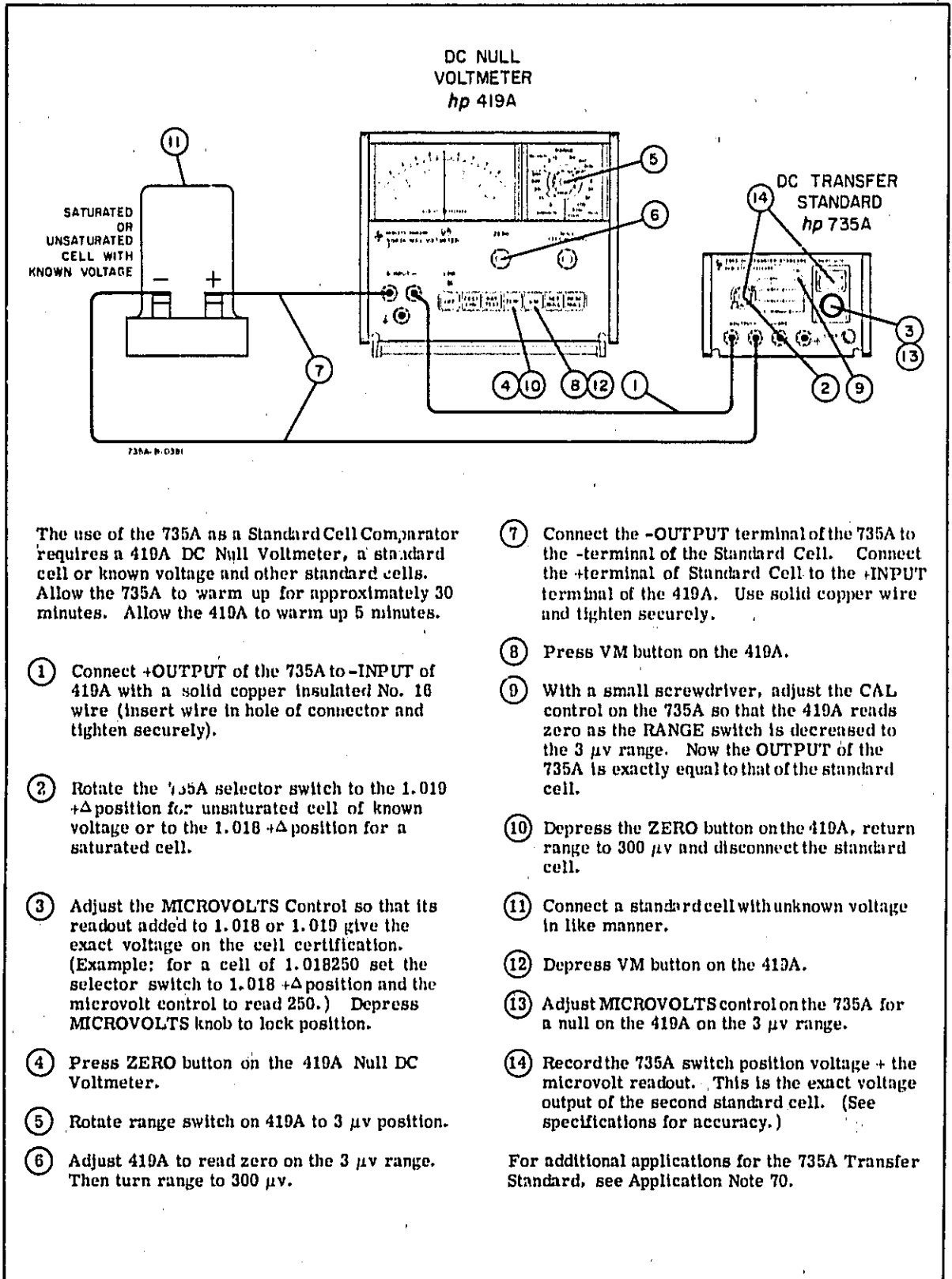

The use of the 735A as a Standard Cell Comparator requires a 419A DC Null Voltmeter, a standard cell or known voltage and other standard cells. Allow the 735A to warm up for approximately 30 minutes. Allow the 419A to warm up 5 minutes.

- ① Connect +OUTPUT of the 735A to -INPUT of 419A with a solid copper insulated No. 16 wire (insert wire in hole of connector and tighten securely).
- ② Rotate the 735A selector switch to the 1.019 +Δ position for unsaturated cell of known voltage or to the 1.018 +Δ position for a saturated cell.
- ③ Adjust the MICROVOLTS Control so that its readout added to 1.018 or 1.019 give the exact voltage on the cell certification. (Example: for a cell of 1.018250 set the selector switch to 1.018 +Δ position and the microvolt control to read 250.) Depress MICROVOLTS knob to lock position.
- ④ Press ZERO button on the 419A Null DC Voltmeter.
- ⑤ Rotate range switch on 419A to 3 μv position.
- ⑥ Adjust 419A to read zero on the 3 μv range. Then turn range to 300 μv.
- ⑦ Connect the -OUTPUT terminal of the 735A to the -terminal of the Standard Cell. Connect the +terminal of Standard Cell to the +INPUT terminal of the 419A. Use solid copper wire and tighten securely.
- ⑧ Press VM button on the 419A.
- ⑨ With a small screwdriver, adjust the CAL control on the 735A so that the 419A reads zero as the RANGE switch is decreased to the 3 μv range. Now the OUTPUT of the 735A is exactly equal to that of the standard cell.
- ⑩ Depress the ZERO button on the 419A, return range to 300 μv and disconnect the standard cell.
- ⑪ Connect a standard cell with unknown voltage in like manner.
- ⑫ Depress VM button on the 419A.
- ⑬ Adjust MICROVOLTS control on the 735A for a null on the 419A on the 3 μv range.
- ⑭ Record the 735A switch position voltage + the microvolt readout. This is the exact voltage output of the second standard cell. (See specifications for accuracy.)

For additional applications for the 735A Transfer Standard, see Application Note 70.

Figure 3-3. Operation as a DC Transfer Standard

THEORY

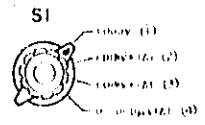
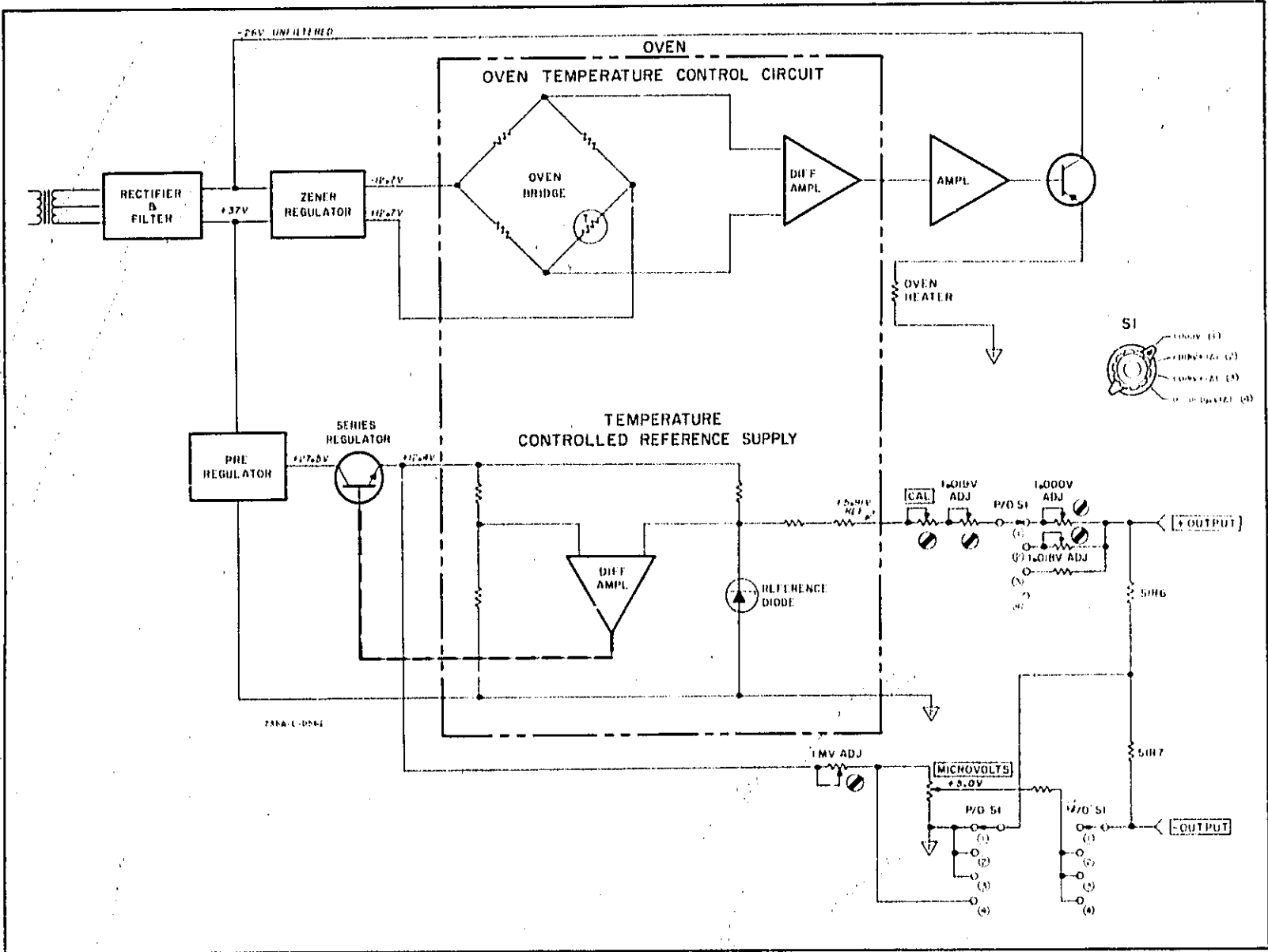

Figure 4-1. 735A Block Diagram

U-1

01782-2

SECTION IV

THEORY OF OPERATION

4-1. GENERAL.

4-2. The -hp- Model 735A DC Transfer Standard is a multipurpose laboratory instrument that may be used as a 1 volt dc standard with standard cell accuracy, as a standard cell comparator, as a transfer standard for other voltages from 1.018 volts to 1.200 volts or as a 0 to 1000 microvolt source. (See Table 1-1 for specifications.)

4-3. This dc transfer standard has four voltage outputs obtained through a selector switch. The basic stability of the 735A is derived from a zener diode reference enclosed in a temperature controlled oven. The various voltage outputs are obtained from voltage divider networks comprised of ultra-stable resistors with matched temperature coefficients. The major portion of these circuits is enclosed within a shield (Guard). Output terminals on the front panel provide positive and negative floating output, shield output and chassis ground output.



THE SHIELD MAY BE DRIVEN BY AN EXTERNAL VOLTAGE NOT TO EXCEED 500 VOLTS DIFFERENCE BETWEEN ANY TWO OF THE BLACK CONNECTORS (-OUTPUT, GUARD AND (\neq) CHASSIS GROUND).

4-4. OVERALL DESCRIPTION.

4-5. Use the 735A Block Diagram, Figure 4-1, and Schematic, Figure 5-9, as referenced for this explanation in its entirety.

4-6. The output of the power transformer is rectified for an output of +37 volts dc and a -26 volts unfiltered using circuit common ∇ as reference. These voltages are filtered and regulated by zener diodes for an output of approximately +12.7 volts and -12.7 volts. The -26 volts and ± 12.7 volts are used for the oven heater circuit. The +37 volts is applied to a dual series voltage regulator circuit utilizing a differential amplifier. The regulated output +12.4 volts is used as a source for the differential amplifier and the zener diode. A selected zener diode is used as the reference for the differential amplifier and as the source for the +5.91 volt reference supply. This diode and the differential amplifier are encased in an oven kept at a constant temperature (+80°C). The 12.4 volts is also applied through an adjustable voltage divider network to the microvolt potentiometer. The high end of this potentiometer (+5 v) and the wiper arm are connected across SIR7 in the output circuit for the fourth (Δ) position of the function switch. SIR6 is shorted in this position to obtain low output impedance (this is not shown in the Block Diagram). In the 1.000 volt position of the

function switch, this delta voltage is not used. In the second and third positions of the function switch, the negative reference ∇ and the wiper arm are connected across SIR7 in such a manner that this voltage opposes the voltage across SIR6. The reference voltage, 5.91 volts, is applied to different voltage divider networks selected by the function switch. Each network includes SIR5 and 6. This provides the 1.000 volt, a 1.019 volts which is opposed by 1000 μv - Δ resulting in the 1.018 +(Δ) output, and a 1.020 volt which is opposed by 1000 μv - Δ , resulting in the 1.019 +(Δ) output.

4-7. BASIC CIRCUITS.

4-8. The -hp- Model 735A Transfer Standard can be divided into three major circuits: 1) the oven temperature control circuit, 2) the reference voltage circuit and 3) the precision voltage divider circuit. Use the 735A Schematic Diagram, Figure 5-9, for the explanation of these circuits.

4-9. OVEN TEMPERATURE CONTROL CIRCUIT.

4-10. The A3 Reference Supply Oven contains circuits that control a heating element HRI to maintain a constant oven temperature of 80°C (176°F). Resistors A3R1, A3R4, and A3R5 are used with thermistor A3RT7 to form the legs of a bridge. A differential amplifier that consists of transistors A3Q1 and A3Q2 is used to sense the balance of the bridge. The legs of the bridge form voltage dividers from which the bases of A3Q1 and A3Q2 are biased. Q1 is an emitter follower that is used as a current amplifier to develop the power to drive the heater HRI in the A3 Reference Supply Oven.

4-11. When the ambient temperature of the oven is less than 80°C (176°F), the internal resistance of the thermistor is greater than the rated resistance at 80°C (176°F) according to the negative temperature coefficient, and the bridge is out of balance. The increased resistance of the thermistor results in the bias at the base of A3Q2 being sufficiently positive to cause A3Q2 conduction to increase.

4-12. The differential amplifier output voltage is amplified by A1Q1 and A1Q2. The output voltage at the collector of A1Q2 is applied to the base of transistor Q1, mounted on the shield, increasing Q1's conduction causing increased dissipation in the heater winding HRI.

4-13. As the ambient temperature of the oven is raised by the heat dissipation of HRI, the resistance of RT7 decreases reducing the bias level at the base A3Q2. This reduces the conduction of the differential amplifier and consequently Q1's conduction decreases, reducing the heat dissipated by HRI. As the oven temperature is raised by the heater the amount of

heat dissipated by the heater becomes less and less. Thus the desired oven temperature is approached.

4-14. When the temperature of the oven reaches the desired level of 80°C (176°F) due to the heat dissipation of HR1, the resistance of A3RT7 reaches the amount necessary to balance the bridge. The heat dissipated by the heater is then just sufficient to overcome the losses through the oven case. This maintains the desired oven temperature.

4-15. REFERENCE VOLTAGE CIRCUIT.

4-16. The source for the reference voltage is a zener diode selected, aged and temperature compensated. A dual series regulator and a differential amplifier circuit maintain a constant current through this zener diode, A3CR1. The differential amplifier uses A3CR1 as a reference and feeds the difference voltage back to control the second series regulator. The differential amplifier, diode and associated resistors are located in the oven to eliminate temperature effects.

4-17. The absolute voltage of the reference diodes varies 10% from instrument to instrument; hence A3R13 and R14 are selected at the factory to give 5.01 volts \pm 0.05% at the output of the oven.

4-18. PRECISION VOLTAGE DIVIDER OUTPUT CIRCUITS.

4-19. Two voltage sources are used for the OUTPUT in the four positions of the function switch. The 5.01 volts Reference is the primary source and the output of the dual series regulator 12.4 volts is the secondary source. Each circuit is independent of the other and an adjustment of one does not effect the other.

4-20. The total impedance of the precision voltage dividers, in all positions of the function switch, is adjusted so that one milliamperere of current flows from the 5.01 volt reference supply. This in turn adjusts the OUTPUT voltage across the precision resistor S1R6. The CAL adjustment (course and fine) varies the current and hence the OUTPUT voltage in all functions except the 0-1000 microvolt position. There are individual internal adjustments for the 1.000000 volt and 1.018 $\pm\Delta$ volt positions.

4-21. The Δ voltage or 0-1000 μv has as its source the +12.4 regulated voltage from the dual series regulator. The precision voltage divider is adjusted until 5 volts is dropped across R1, the microvolt potentiometer. The wiper arm is applied through S1R8 to the -OUTPUT terminal. In the 0-1000 microvolt position of the function switch the +5 volt terminal of potentiometer is connected to the junction of S1R6 and S1R7. S1R6 is shorted. This puts a positive voltage 0-1000 microvolts on the +OUTPUT terminal. In the 1.018 $\pm\Delta$ and 1.019 $\pm\Delta$ positions, the other end of R1 (∇) is connected to the junction of S1R6 and S1R7. This opposing voltage (1000 μv - Δ) has a separate current path and is unaffected by changes in primary current path when the function switch is changed.

4-22. GUARDING.

4-23. The 735A is equipped with a guard shield which surrounds the primary of the power transformer and the floating circuitry of the instrument. This shield may be driven to prevent leakage to ground when the 735A is used in a floating configuration. It can also be useful in reducing common mode insertion into a circuit under test.

MAINTENANCE

SECTION V MAINTENANCE

5-1. INTRODUCTION.

5-2. This section contains information necessary for the proper maintenance of the -hp- Model 735A DC Transfer Standard. This section provides the necessary Performance Checks, Adjustment and Calibration Procedures and Troubleshooting Techniques required to accomplish the above objective.

5-3. TEST EQUIPMENT REQUIRED.

5-4. The test equipment required to perform the operations outlined in this section is listed in Table 5-1. This table contains the type of instrument required, critical specifications, type of operation to be

conducted and recommended model. If the specific model recommended is not available, equipment which meets or exceeds the critical specifications listed may be substituted.

5-5. PERFORMANCE CHECKS.

5-6. The Performance Checks presented in this section are front panel procedures designed to compare the Model 735A with its published specifications. These operations may be incorporated in periodic maintenance, post-repair, or incoming quality control checks. These operations should be conducted before any attempt is made to adjust or calibrate the instrument.

Table 5-1. Test Equipment Required

Instrument	Critical Specifications	Use	Recommended Model
DC Milliammeter Clip-on Probe	Range: 1.5 ma	Performance Checks	-hp- Model 428B Clip-on DC Milliammeter
DC Null Voltmeter	Range: 3 μ v to 400 v Accuracy: $\pm 2\%$	Performance Checks Troubleshooting	-hp- Model 410A DC Null Voltmeter
Resistor	1 K ohm $\pm 1\%$, 1/2 w	Performance Checks	-hp- Part No. 0757-0150
	146.2 ohm $\pm 1/2\%$, 1/2 w	Performance Checks	-hp- Part No. 0727-0379
Saturated Standard Cell	Calibrated by National Bureau of Standards to 1 ppm	Performance Checks Calibration Procedure	
DC Differential Voltmeter	Range: 0-1 vdc Accuracy: $\pm 0.01\%$ Resolution: $\pm 0.0002\%$ of full scale	Performance Checks Calibration Procedure	-hp- Model 740B DC Standard/Differential Volt- meter
Ohmmeter	Range: 10 M maximum	Troubleshooting	-hp- Model 412A Vacuum Tube Voltmeter
Unsaturated Standard Cell	Known Accuracy	Performance Checks	
AC Voltmeter	Range: 0.001 volt Frequency: 1 cps to 1 Mc	Performance Checks	-hp- Model 403A Transis- torized AC Voltmeter
Variable Transformer	Output Voltage: 0-256 vac	Performance Checks	Superior Electric Model V216T

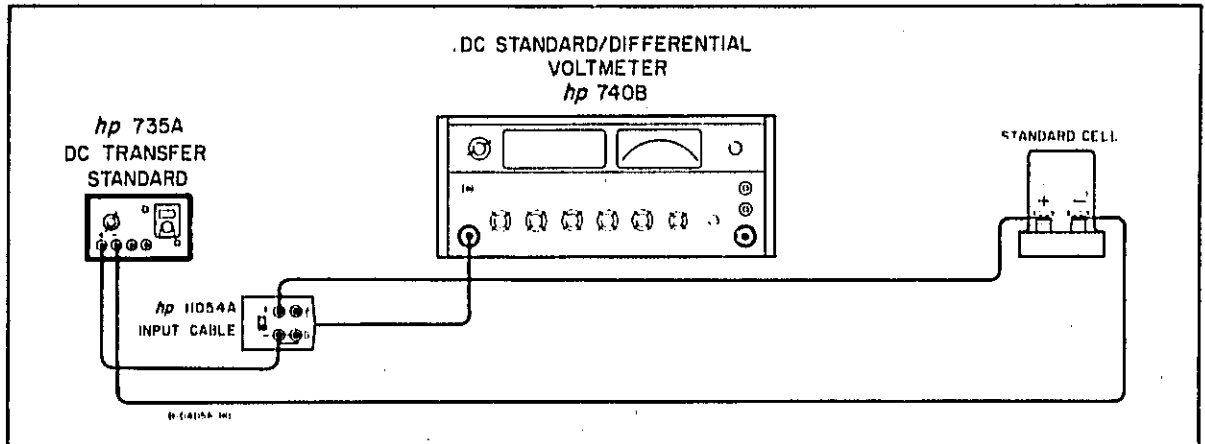

Figure 5-1. Standard Output Accuracy Check

5-7. TRANSFER STANDARD OUTPUT ACCURACY.

- a. Connect the OUTPUT of the 735A to the input of the 740B Differential Voltmeter (observe polarity).
- b. Set 735A function switch to 0-1000 μ v (Δ) position and the dial to 1000 μ volts.
- c. Set 740B Range to 10 millivolts. The reading should be 1 millivolt \pm 2.5 microvolts.
- d. Connect the 735A as shown in Figure 5-1. (Use solid copper wire tightened securely for all operations of the 735A.) Use an unsaturated standard cell and connect the positive terminal of the standard cell to the positive terminal of the 740B.
- e. Set the 735A to 1.019 + Δ position.
- f. Set the 740B to differential voltmeter mode and 100 millivolt range for this procedure.
- g. Adjust the 0-1000 μ volts on the 735A for a null on the 740B Differential Voltmeter. Push control knob into lock.
- h. Vary the line voltage of the 735A from 103 volts ac to the 127 vac (207 to 253 for 230 vac line). The output should change less than 1 μ volt. Return to 115 ac volt line.
- i. Set 735A to 1.018 + Δ position (do not change delta control). Read the difference with the 740B. The 740B should read 1 millivolt \pm 10 microvolts.
- j. Set 735A to the 1.000000 volt position. Read the difference with the 740B. The 740B should read 19 millivolts + Δ \pm 10 microvolts where Δ (delta) is the reading on the dial of the 735A obtained in step g.
- k. Set the 735A to the 1.000000 volt position. Read the difference with the 740B. The 740B should read 19 millivolts + Δ \pm 10 microvolts where Δ (delta) is the reading on the dial of the 735A obtained in step g.
- m. Absolute reference may be checked by connecting the 735A as in Figure 5-1 or Figure 5-2 using the saturated standard cell (1 ppm)

and the 1.018 + Δ position of the 735A. Adjust the 0-1000 microvolt control for the exact reading on the standard cell. Adjust CAL on the 735A for a null on the 740B Differential Voltmeter or 410A Null Voltmeter using the most sensitive range.

- n. If the 735A does not meet the criteria specified in the preceding checks, refer to Paragraph 5-14 for complete calibration procedure.

5-8. OUTPUT IMPEDANCE CHECK.

- a. Set Model 735A output to 1.000 V.
- b. Connect the Model 735A OUTPUT to DC Null Voltmeter (-hp- Model 419A) INPUT; observe polarity. Set null voltmeter RANGE to 1 V.
- c. Null voltmeter should indicate full scale deflection (1 V).
- d. Place 1 K ohm \pm 1%, 1/2 W resistor (-hp- Part No. 0757-0159) across Model 735A OUTPUT.
- e. Null voltmeter indication should decrease to 0.5 volts \pm 0.03 volts. This verifies a Model 735A output impedance of 1 K ohm \pm 1%. (The output impedance equals the external load resistor.)

5-9. OUTPUT NOISE CHECK.

- a. Connect the Model 735A as shown in Figure 5-2.
- b. Set Model 735A output to 1.018 V +(Δ) for saturated cell, 1.019 V +(Δ) for unsaturated cell.
- c. Adjust Model 735A MICROVOLTS control until the DC Null Voltmeter (-hp- Model 419A) indicates a null on the 3 μ v RANGE.
- d. Observe null meter pointer. Maximum deflection

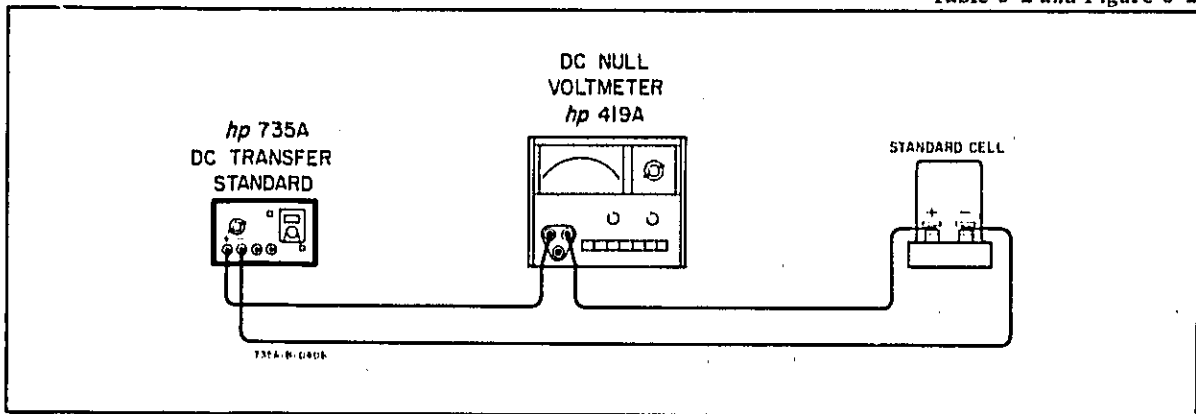

Figure 5-2. Output Noise Test Setup

from null should never exceed $\pm 0.5 \mu\text{v}$. This will verify output noise of less than $1 \mu\text{v}$ peak-to-peak. (This is in addition to any noise from the test setup.)

- e. Connect the AC Voltmeter (-hp- Model 403A) to the OUTPUT of the 735A. Set 403A RANGE to 0.001 V and FUNCTION to 1 cps - 1 Mc. The ac voltmeter should read less than $100 \mu\text{v}$.

5-10. SHORT CIRCUIT CURRENT.

- a. Set Model 735A output to 1.000 V.
- b. Short Model 735A output with small wire.
- c. Set milliammeter RANGE to 3 ma. Place DC Milliammeter (-hp- Model 428B) clip-on-probe around shorting conductor.
- d. DC milliammeter should read less than 1.5 ma.

5-11. VARIABLE OUTPUT ACCURACY, IMPEDANCE AND NOISE CHECK.

- a. Connect the Model 735A OUTPUT to DC Differential Voltmeter (-hp- Model 740A); observe polarity. Leave function switch set to 0-1000 μv (Δ) position and place the dc differential voltmeter on the 10 millivolt range.
- b. Set Model 735A MICROVOLTS control fully counterclockwise. Front panel should indicate 000 μv .
- c. Measure Model 735A output with dc differential voltmeter.
- d. Differential voltmeter should indicate between +1.5 and -1.5 μv .
- e. Continue to test Model 735A variable output accuracy using the data contained in Table 5-2. Once null is obtained, differential voltmeter should indicate voltage level within limits specified.

Table 5-2. Accuracy Check

Model 735A Microvolts Setting	Model 740B Final Indication
200 μv	198.3 to 201.7 μv
400 μv	398.1 to 401.9 μv
600 μv	597.9 to 602.1 μv
800 μv	797.7 to 802.3 μv
1000 μv	997.5 to 1002.5 μv

- f. While the Model 735A is in the 0-1000 μv (Δ) position and the MICROVOLT control is at 1000 μ volts, place a 146 ohm $\pm 1/2\%$, 1/2 w resistor (-hp- Part No. 0727-0370) across the Model 735A OUTPUT.
- g. The differential voltmeter should indicate 0.495 to 0.505 millivolts $\pm 1/2$ the variation from 1 millivolt before the resistor was added. This verifies the Model 735A variable output impedance to be 146 ohms $\pm 1\%$.

5-12. ADJUSTMENT AND CALIBRATION PROCEDURE.

5-13. The following is a complete Adjustment and Calibration Procedure for the Model 735A DC Transfer Standard. These operations should be conducted only after it has previously been established by the Performance Checks, Paragraph 5-5, that the Model 735A is in need of adjustment. Indiscriminate adjustment of the internal controls simply to "refine" settings, may actually cause more difficulty. If the procedures outlined below do not rectify any discrepancy which may exist, and all connections and settings have been rechecked, refer to Paragraph 5-15, Troubleshooting Techniques, for possible cause and recommended corrective action.

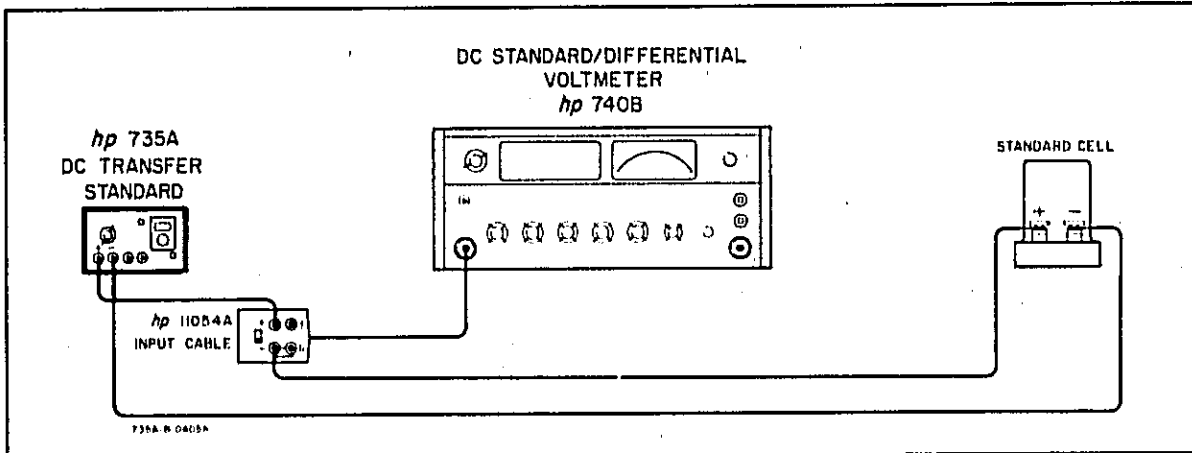
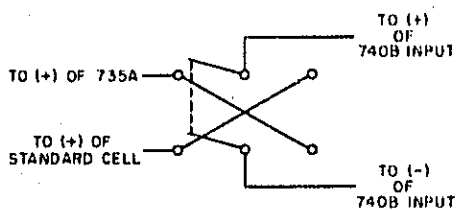

Figure 5-3. Adjustment and Calibration Test Setup

5-14. CALIBRATION PROCEDURE.

NOTE

The -hp- Model 740B Differential Voltmeter must read in a positive direction. Connect the positive terminal of the higher voltage output (either the Standard Cell or the Model 735A) to the positive input terminal of the 740B. A copper knife blade Type Switch, Leeds and Northrup No. 3294, may be used for quick disconnect and polarity reversal. (Connect as shown below.)



- a. Set the selector switch and microvolt control of the Model 735A to 1.019 v + 1000 μ v.
- b. Connect the 735A as shown in Figure 5-3 using a saturated standard cell and a Differential Voltmeter (-hp- Model 740B). The positive OUTPUT terminal of the 735A must be connected to the positive terminal of the 740B.
- c. Set the differential voltmeter on the 100 mv range.
- d. Bring A2R5 (front panel CAL adjust) to the center of its range. Adjust A2R2, designated coarse cal on the top cover of the front shield, for a differential voltmeter reading of 1.020 - Standard Cell voltage. (Fine adjustment may be accomplished with A2R5 front panel CAL adjust.)
- e. Set Model 735A to 1.018 v + 1000 μ v Δ .
- f. Set the 740B Differential Voltmeter to the 100 mv range.
- g. Adjust A2R9 (designated 1.018 v on the bottom cover of front shield) for a reading of 1.019 v - Standard Cell voltage.
- h. Set 735A to 1.019 + 000 μ v.
- j. Adjust 1 mv (A2R6) to obtain same reading on Δ vm as in (g).
- k. Set the 740B Differential Voltmeter to the 100 mv range and reverse polarity of input leads.
- m. Set 735A to 1.000 v.
- n. Adjust A2R8 for a reading on the 740B of Standard Cell - 1.000 v.
- p. Final adjustment: connect the 735A as in Figure 5-1 or Figure 5-2 using a calibrated saturated Standard Cell and a 410A Null Voltmeter or 740B Differential Voltmeter.
- q. Set the Model 735A to the exact voltage of the Saturated Standard Cell as certified by the National Bureau of Standards (1 ppm).
- r. Adjust the CAL potentiometer on the front panel of the 735A for a null on the 3 microvolt range of the 419A or the 740B on the 1mv ranging using all sensitivity controls. (This tends to correct the possible error of the 740B and affects the first three positions of the 735A Function switch.)
- s. Check the 0 - 1000 microvolt position of the function switch as described in Paragraph 5-11 steps a through e. If voltages are within limits do not readjust A2R6 (1 mv).

5-15. TROUBLESHOOTING TECHNIQUES.

5-16. This section contains procedures designed to assist in the isolation of malfunctions. These pro-

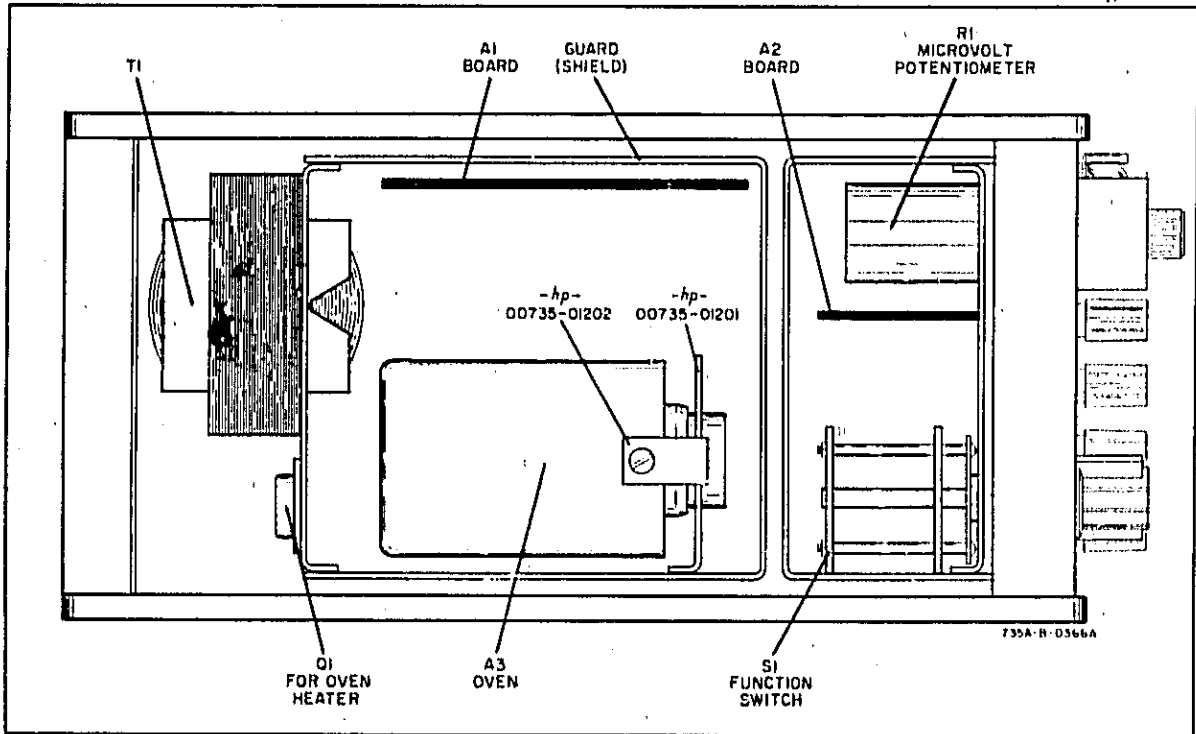

Figure 5-4. Top View

cedures are based on an analysis of the instrument circuit. These operations should be undertaken only after it has been established that the difficulty cannot be eliminated by the Adjustment and Calibration Procedure, Paragraph 5-12. An investigation should also be conducted to insure that the trouble is not a result of conditions external to the Model 735A.

5-17. Conduct a visual check of the Model 735A for possible burned or loose components, loose connections, or any other obvious conditions which might suggest a source of trouble. (Component location is shown in Figure 5-4. Top View.)

5-18. Table 5-3 contains a summary of the front panel symptoms which may be encountered. It should be used in initial efforts to select a starting point for troubleshooting operations.

5-19. Table 5-4 contains procedures which may be used as a guide in isolating malfunctions. These steps describe the normal conditions which should be encountered during the checks outlined.

5-20. The tests outlined in Table 5-4 are not designed to check all circuit parameters, rather, only to localize the malfunction. Therefore, it is quite possible that additional measurements will be required to completely isolate the problem. The voltage values described in Table 5-4 and Figure 5-9 are based on the Model 735A output set to 1.019 V + (Δ), and MICROVOLTS set to 500 μ v.

5-21. SERVICING THE ETCHED CIRCUIT BOARDS.

5-22. The -hp- Model 735A has two etched circuit boards. Figures 5-6 and 5-7 show these boards and their components. Use caution when removing them to avoid damaging mounted components. The -hp- part number of the assembly is etched on the exterior of the circuit board to identify it. Refer to Section VI for -hp- part number information.

5-23. The etched circuit boards are a plated-through type. The electrical connection between sides of the boards is made by a layer of metal plated through the component holes. When working on these boards, observe the following general rules.

- a. Use a low-heat (25 to 50 watts) small-*tip* soldering iron, and a small diameter rosin core solder.
- b. Circuit components can be removed by placing the soldering iron on the component lead on either side of the board, and pulling up on lead. If a component is obviously damaged, clip leads as close to component as possible and then remove. Excess heat can cause the circuit and board to separate, or cause damage to the component.
- c. Component lead hole should be cleaned with a toothpick or other such device before inserting new lead.

- d. To replace components, shape new leads and insert them in holes. Reheat with iron and add solder as required to insure a good electrical connection.
- e. Clean excess flux from the connection and adjoining area.
- f. To avoid surface contamination of the printed circuit, clean with weak solution of warm water and mild detergent after repair. Rinse thoroughly with clean water. When completely dry, spray lightly with Krylon (#1302 or equivalent).

- f. While holding the end of the bracket, gently pull oven from socket without disturbing the wire connected to the socket.
- g. For replacement of the oven, use the reverse order of this procedure.

5-26. REMOVAL OF Q1 (HEATER TRANSISTOR).

- a. Follow the procedure contained in Paragraph 5-25, steps a through e.
- b. Remove the transistor socket from the transistor taking care not to damage the wire connections.
- c. With an offset screwdriver (90°), remove the two screw-headed bolts retaining the transistor. (Observe the position of insulator and lock washers so that they may be replaced in the reverse order of disassembly.)

5-24. REMOVAL OF OVEN.

5-25. The components inside the oven are not separately replaceable. If the oven circuitry is not operating properly, the entire oven must be replaced. Use the following procedure for removal and replacement of the oven.

- a. Remove top cover of the instrument by removing one Phillips-head screw at the rear of the top cover; slide the top cover toward the rear and lift.
- b. Remove left (facing the front of the instrument) side cover by removing four Phillips-head screws.
- c. Remove top cover of rear shield by removing two screws.
- d. Remove the bottom screw holding the oven bracket, located on the left side of the rear shield. Loosen the top screw slightly and turn the oven in a vertical position using the oven bracket as a swivel.
- e. Secure the oven mount by tightening the top screw.



BEFORE REPLACEMENT OF THE TRANSISTOR, CHECK THE CONDITION OF THE LARGE INSULATOR BETWEEN THE TRANSISTOR AND THE SIDE OF THE SHIELD. IF NOT IN GOOD CONDITION, REPLACE. COVER BOTH SIDES OF INSULATOR WITH SILICON GREASE (DOW CORNING 5 COMPOUND) BEFORE REPLACING IN THE INSTRUMENT.

- d. Use the reverse order of this procedure for replacement of transistor. (See Figure 5-5 for order of assembly.)



WHEN TIGHTENING THE NUT WHERE THE BLUE WIRE IS ATTACHED, BE SURE THAT THE SOLDER LUG DOES NOT TOUCH THE CHASSIS OR ANOTHER LUG.

Table 5-3. Troubleshooting Summary

Trouble	Possible Cause
Front panel oven light off.	Check power cord, fuse, DS1, Q1 (mounted on inner chassis).
Front panel oven light does not dim.	Check oven voltage pins 1, 2, 3, 4, and 9. If OK, check A1Q1, A1Q2, Q1 and oven heater pins 11 and 12. (If oven is defective, replace entire oven.)
All outputs unstable over period of time.	Check oven heater circuit and voltage regulator circuits. If circuits outside the oven are OK, then replace oven.
One function output fails, all others are correct.	Check portion of output voltage divider used only in this function. (See Figure 5-8 for location of components on the switch.)
All functions fail to operate properly.	Refer to Table 5-4.

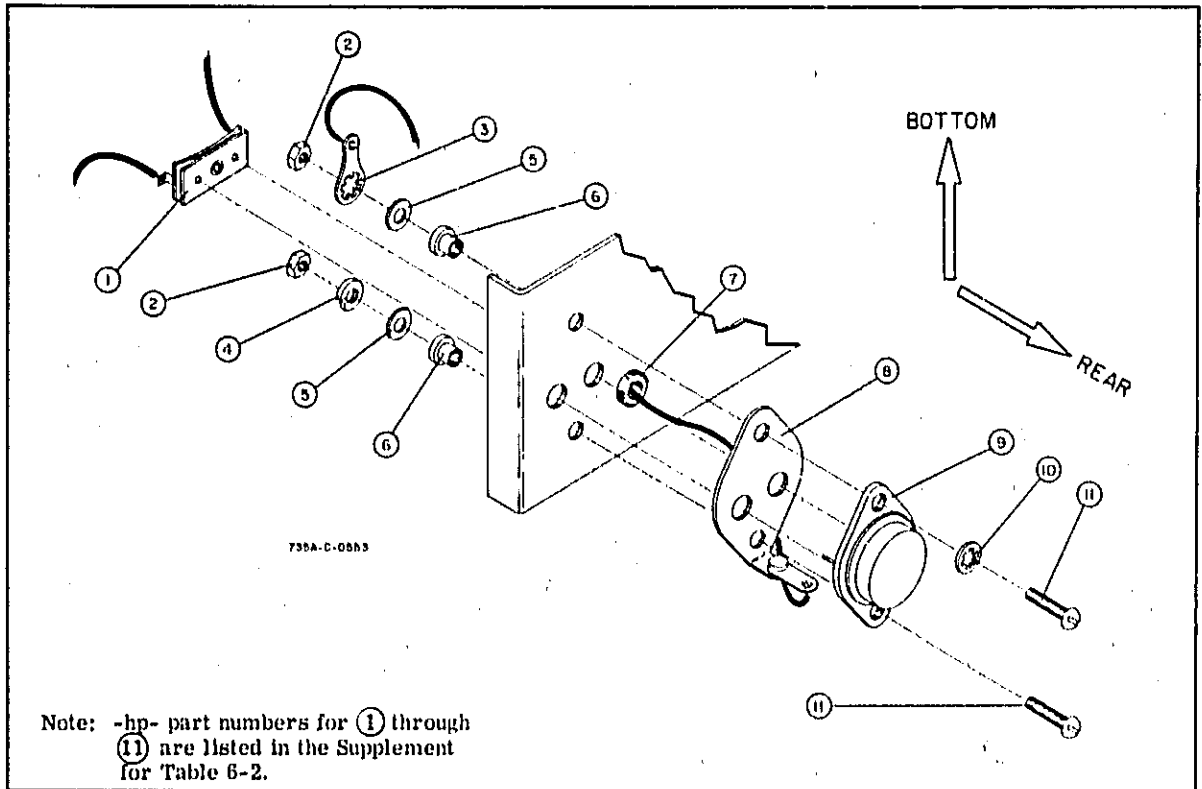

Figure 5-5. Transistor Mounting

Table 5-4. Troubleshooting Procedures

Use negative output terminal as common for all voltage measurements except in step (3). In step (3) use the junction as common and negative output as high or reverse polarity of the instrument.

- 1 Measure the dc voltage levels at the pins indicated below. DC voltage levels should be as specified:

A Pin 6, A3: +12.4 v

B Pin 7, A3: 5.01 v

If voltage levels are correct, proceed to (2). If not, go directly to (4).

- 2 Measure the dc voltage at the junction of R5 and R6 on the function switch. DC level should be 1.019 v. If correct, proceed to (3). If not, check A2R1 - A2R5, and R5 on function switch.
- 3 Measure the dc voltage at the junction of R6 and R7 on the function switch. DC level should be 0.5 mv. If not, check A2R6 and R7; MICROVOLTS control adjustment and R7 and R8 on the function switch.

- 4 Measure the dc voltage levels at the points indicated below. DC levels should be as specified. If not, check the parameters listed.

Location	DC Level	Possible Malfunction
A Jct of A1CR4 and A1C1	+36 v	A1CR3, A1CR4, A1R1 and T1
B Jct of A1R2 and A1CR5	+12.7 v	A1C1, A1R2 and A1CR5
C Jct of A1CR2 and A1R3	-25 v	A1CR5, A1CR2, A1R1 and T1
D Jct of A1R4 and A1CR6	-12.7 v	A1R3, A1R4, A1C2 and A1CR6

If all of the above are correct, proceed to 5.

- 5 Measure the dc voltage level at pin 4, A3 (base of A1Q1). DC level should be +1 v. If correct, proceed to (7). If incorrect, go directly to (8).

Table 5-4. Troubleshooting Procedures (Cont'd)

<p>6 Check the transistor bias levels for A1Q1 - A1Q4 as provided in Figure 5-5. If correct, proceed to (7). In correct, replace faulty component.</p> <p>7 Measure the dc voltages at the points indicated below. DC levels should be as prescribed. If not, check the components listed.</p>	<table border="1"> <thead> <tr> <th>Location</th> <th>DC Level</th> <th>Possible Malfunction</th> </tr> </thead> <tbody> <tr> <td>Pin 6, A3</td> <td>12.4 v</td> <td>A3Q4 and A3CR1</td> </tr> <tr> <td>Pin 5, A3</td> <td>13.5 v</td> <td>A3Q3</td> </tr> </tbody> </table> <p>8 To check oven control operation, proceed as follows. Disconnect instrument power cord for approximately 30 seconds; then reapply line power. Oven lamp (front panel) should come on brightly for approximately 15 seconds; then momentarily extinguish, and re-illuminates to a lesser brilliance. This indication verifies proper oven control.</p>	Location	DC Level	Possible Malfunction	Pin 6, A3	12.4 v	A3Q4 and A3CR1	Pin 5, A3	13.5 v	A3Q3
Location	DC Level	Possible Malfunction								
Pin 6, A3	12.4 v	A3Q4 and A3CR1								
Pin 5, A3	13.5 v	A3Q3								

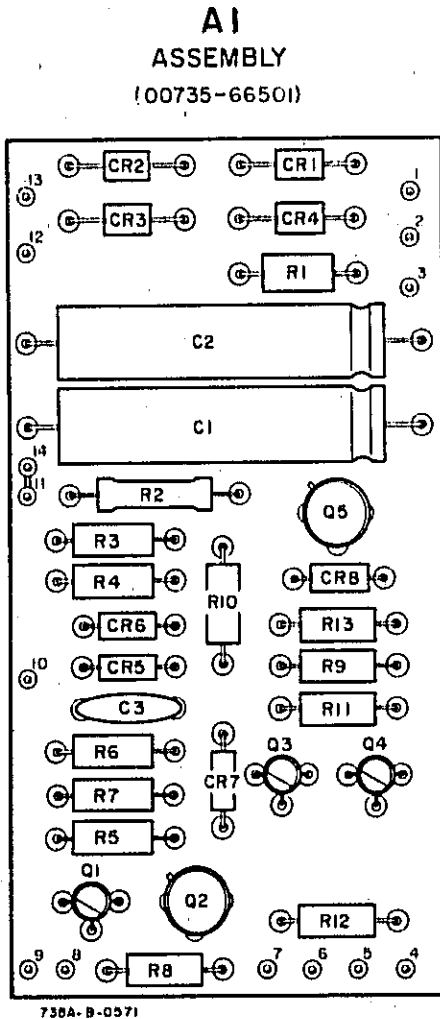

Figure 5-6. A1 Component Location

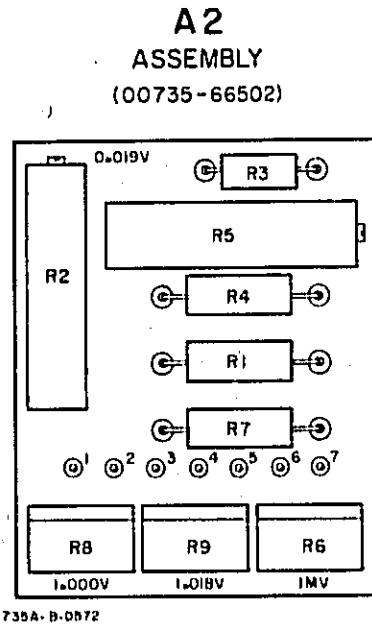

Figure 5-7. A2 Component Location

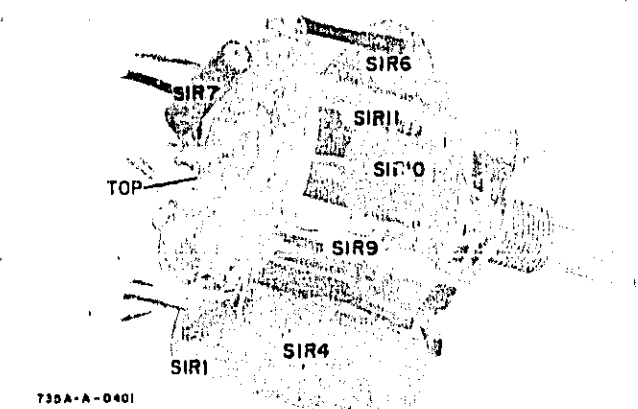
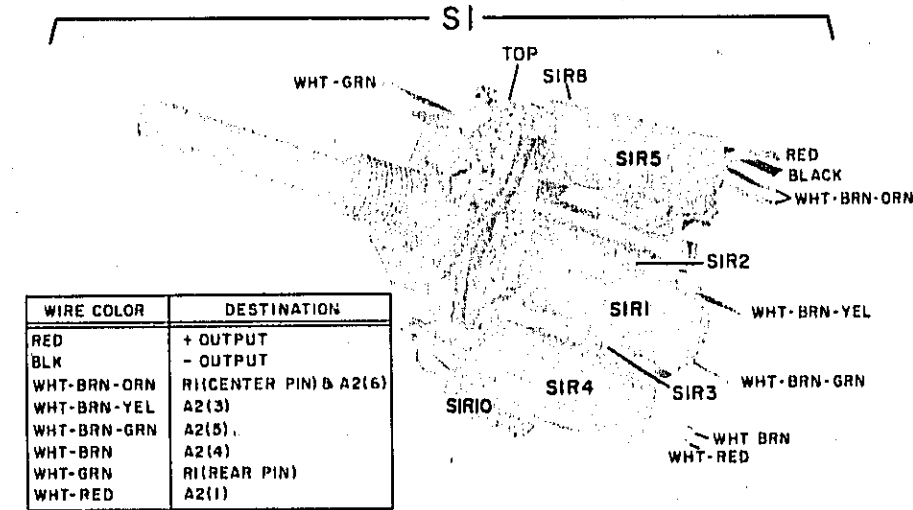
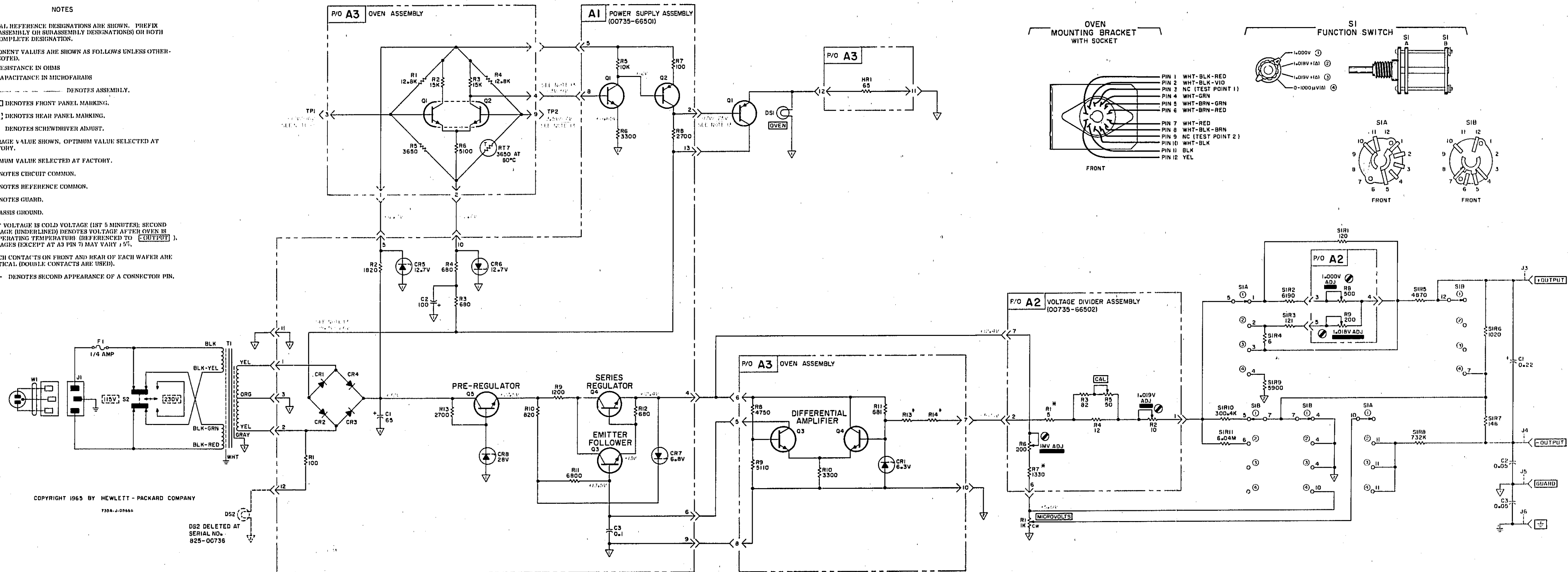

Figure 5-8. S1 Component Location

- NOTES
- PARTIAL REFERENCE DESIGNATIONS ARE SHOWN. PREFIX WITH ASSEMBLY OR SUBASSEMBLY DESIGNATION(S) ON BOTH FOR COMPLETE DESIGNATION.
 - COMPONENT VALUES ARE SHOWN AS FOLLOWS UNLESS OTHERWISE NOTED.
RESISTANCE IN OHMS
CAPACITANCE IN MICROFARADS
 - DENOTES ASSEMBLY.
 - DENOTES FRONT PANEL MARKING.
 - DENOTES REAR PANEL MARKING.
 - ⊖ DENOTES SCREWDRIVER ADJUST.
 - * AVERAGE VALUE SHOWN, OPTIMUM VALUE SELECTED AT FACTORY.
 - † OPTIMUM VALUE SELECTED AT FACTORY.
 - ▽ DENOTES CIRCUIT COMMON.
 - ▽ DENOTES REFERENCE COMMON.
 - ▽ DENOTES GUARD.
 - ⊕ CHASSIS GROUND.
 - FIRST VOLTAGE IS COLD VOLTAGE (1ST 5 MINUTES); SECOND VOLTAGE (UNDERLINED) DENOTES VOLTAGE AFTER OVEN IS AT OPERATING TEMPERATURE (REFERENCED TO OUTPUT), VOLTAGES (EXCEPT AT A3 PIN 7) MAY VARY ± 5%.
 - SWITCH CONTACTS ON FRONT AND REAR OF EACH WAFER ARE IDENTICAL (DOUBLE CONTACTS ARE USED).
 - ↔ DENOTES SECOND APPEARANCE OF A CONNECTOR PIN.



PARTS LIST

SECTION VI REPLACEABLE PARTS

6-1. INTRODUCTION.

6-2. This section contains information for ordering replacement parts. Table 6-1 lists parts in alphanumeric order of their reference designators and indicates the description and -hp- part number of each part, together with any applicable notes. Table 6-2 lists parts in alphanumeric order of their -hp- part number and provides the following information on each part:

- a. Description of the part. (See list of abbreviations below.)
- b. Typical manufacturer of the part in a five-digit code. (See Appendix A for list of Manufacturers.)
- c. Manufacturer's part number.
- d. Total quantity used in the instrument (TQ column).

6-3. Miscellaneous parts are listed at the end of Table 6-1.

6-4. ORDERING INFORMATION.

6-5. To obtain replacement parts, address order or inquiry to your local Hewlett-Packard Field Office. (See Appendix B for list of office locations.) Identify parts by their Hewlett-Packard part numbers.

6-6. NON-LISTED PARTS.

6-7. To obtain a part that is not listed, include:

- a. Instrument model number.
- b. Instrument serial number.
- c. Description of the part.
- d. Function and location of the part.

DESIGNATORS			
A = assembly H = motor BT = battery C = capacitor CR = diode DL = delay line DS = lamp E = misc electronic part	F = fuse FL = filter HR = heater J = jack K = relay L = inductor M = meter MP = mechanical part	P = plug Q = transistor QCR = transistor-diode R = resistor RT = thermistor S = switch T = transformer TC = thermocouple	V = vacuum tube, neon bulb, photocell etc. W = cable X = socket XDB = lampholder XP = fuseholder Z = network
ABBREVIATIONS			
Ag = silver Al = aluminum amp = ampere (s) Au = gold C = capacitor cer = ceramic coef = coefficient com = common comp = composition conn = connection cps = cycles per second dep = deposited DPDT = double-pole double-throw DPST = double-pole single-throw elect = electrolytic encap = encapsulated f = facial (s) FET = field effect transistor fix = fixed GaAs = gallium arsenide Ge = germanium gd = guard (ed) Ge = germanium grd = ground (ed) h = henry (ies) Hg = mercury	ID = inside diameter impg = impregnated incd = incandescent ins = insulation (ed) K = kilohm (s) = 10 ⁺³ Ke = kilocycle (s) = 10 ⁺³ L = inductor lin = linear taper log = logarithmic taper m = milli = 10 ⁻³ ma = milliamperes (s) = 10 ⁻³ Mc = megacycle (s) = 10 ⁺⁶ meg = megohm (s) = 10 ⁺⁶ met film = metal film mfr = manufacturer mtg = mounting μ = micro = 10 ⁻⁶ my = Mylar [®] na = nanoampere (s) = 10 ⁻⁹ NC = normally closed Ne = neon NO = normally open NPO = negative positive zero (zero temperature coefficient)	ns = nanosecond (s) = 10 ⁻⁹ nsr = not separately replaceable ord = order by description OD = outside diameter p = peak pc = printed circuit pf = picofarad (s) = 10 ⁻¹² piv = peak inverse voltage p/o = part of pos = position (s) poly = polystyrene pot = potentiometer p-p = peak-to-peak prec = precision (temperature coefficient, long term stability, and/or tolerance) R = resistor Rh = rhodium rms = root-mean-square rot = rotary Se = selenium sect = section (s) Si = silicon sl = slide	SPDT = single-pole double-throw SPST = single-pole single-throw Ta = tantalum TiO ₂ = titanium dioxide tog = toggle tol = tolerance trim = trimmer TSTT = transistor v = volt (s) vacw = alternating current working volt (s) var = variable vdcw = direct current working volt (s) w = watt (s) w/ = with w/v = reverse working voltage w/o = without ww = wirewound • = optimum value selected at factory, average value shown (part may be omitted) ** = no standard type number assigned (selected or special type)

[®] Dupont de Nemours

Table 6-1. Reference Designation Index

REFERENCE DESIGNATION	-hp- PART NO.	DESCRIPTION	NOTE
A1	00735-66501 (Rev. B)	Assembly: pc board includes C1 thru C3 Q1 thru Q5 C1 thru CR8 R1 thru R13	
A1C1	0180-0149	C: fxd A1 elect 65 μ f +100% -10% 60 vdcw	
A1C2	0180-0094	C: fxd A1 elect 100 μ f +100% -10% 25 vdcw	
A1C3	0150-0084	C: fxd cer 0.1 μ f +80% -20% 50 vdcw	
A1CR1-A1CR4	1901-0045	Diode: Si 100 piv	
A1CR5, A1CR6	1902-0031	Diode: breakdown 12.7 v \pm 5% 400 mw	
A1CR7	1902-0048	Diode: breakdown 6.81 v \pm 5% 400 mw	
A1CR8	1902-3277	Diode: breakdown 28 v	
A1Q1	1854-0033	TSTR: Si NPN 2N3391	
A1Q2	1853-0001	TSTR: Si PNP **	
A1Q3, A1Q4	1854-0033	TSTR: Si NPN 2N3391	
A1Q5	1854-0030	TSTR: Si NPN 2N3053	
A1R1	0687-1011	R: fxd comp 100 ohms \pm 10% 1/2 w	
A1R2	0757-0823	R: fxd prec met film 1820 ohms \pm 1% 1/2 w	
A1R3, A1R4	0687-6811	R: fxd comp 680 ohms \pm 10% 1/2 w	
A1R5	0687-1031	R: fxd comp 10 K \pm 10% 1/2 w	
A1R6	0687-3321	R: fxd comp 3300 ohms \pm 10% 1/2 w	
A1R7	0687-1011	R: fxd comp 100 ohms \pm 10% 1/2 w	
A1R8	0687-2721	R: fxd comp 2700 ohms \pm 10% 1/2 w	
A1R9	0687-1221	R: fxd comp 1200 ohms \pm 10% 1/2 w	
A1R10	0687-8211	R: fxd comp 820 ohms \pm 10% 1/2 w	
A1R11	0687-6821	R: fxd comp 6800 ohms \pm 10% 1/2 w	
A1R12	0687-6811	R: fxd comp 680 ohms \pm 10% 1/2 w	
A1R13	0687-2721	R: fxd comp 2.7 K \pm 10% 1/2 w	
A2	00735-66502	Assembly: pc board includes , R1 thru R8	
A2R1*	0811-1539	R: fxd prec ww 5 ohms \pm 1% 1/2 w	
A2R2	2100-1751	R: var ww 10 ohms \pm 10% 1 w	
A2R3	0687-8201	R: fxd comp 82 ohms \pm 10% 1/2 w	
A2R4	0811-1541	R: fxd prec ww 12 ohms \pm 1% 1/4 w	
A2R5	2100-1481	R: var 50 ohms +20% -10% 1 w	
A2R6	2100-0783	R: var ww 200 ohms \pm 5%	
A2R7*	0688-3406	R: fxd prec met film 1330 ohms \pm 1% 1/2 w	
A2R8	2100-0740	R: var ww 500 ohms \pm 5%	
A2R9	2100-0783	R: var ww 200 ohms \pm 5%	
A3	00755-86901	Oven (parts not separately replaceable)	
	00735-01201	Bracket: oven mtg	
	00735-01202	Bracket: oven mtg	
	1200-0038	Socket: 12 pin oven	
C1	0170-0038	C: fxd my 0.22 μ f \pm 10% 200 vdcw	
C2, C3	0150-0052	C: fxd cer 0.05 μ f \pm 20% 400 vdcw	
DS1	2140-0025	Lamp: incd 28 v 0.04 amp clear bulb	
	1450-0032	Holder: lamp front mtg 2 terminals	
	1450-0033	Lamp: pilot jewel 17/32 inch long	
F1	2110-0201	Fuse: 0.25 Amp S. B.	
J1	1251-2357	Connector: ac power cord receptacle	
J2		Not Assigned	
J3	1510-0026	Assembly: binding post red (+ OUTPUT)	
J4	1510-0027	Assembly: binding post black (- OUTPUT)	
J5, J6	1510-0009	Binding post: black (GUARD and \pm)	

Table 6-1. Reference Designation Index (Cont'd)

REFERENCE DESIGNATION	-hp- PART NO.	DESCRIPTION	NOTE
Q1	1850-0098 1200-0044	TSTR: Ge PNP ** Socket: TSTR	
R1	00735-64101	Insulator: anodized alum	
S1	2100-1580 00735-61991	R: var ww 1 K $\pm 5\%$ 1-1/2 w Assembly: switch function includes R1 thru R11	
	3100-1715	Switch: ort w/o components	
S1R1	0811-1534	R: fxd prec ww 120 ohms $\pm 0.02\%$ 1/4 w	
S1R2	0757-0196	R: fxd prec met flm 6.19 K $\pm 1\%$ 1/2 w	
S1R3	0757-0799	R: fxd prec met flm 121 ohms $\pm 1\%$ 1/2 w	
S1R4	0811-1545	R: fxd prec ww 6.0 ohms $\pm 0.5\%$ 1/8 w	
S1R5, S1R6	0811-1106	R: set matched prec ww (R5 4.870 K $\pm 0.01\%$) (R6 1.020 K $\pm 0.01\%$)	
S1R7	0811-1576	R: fxd prec 146 ohms $\pm 1\%$ 1/4 w	
S1R8	0698-3574	R: fxd prec met flm 732 K $\pm 1\%$ 1/2 w	
S1R9	0698-3536	R: fxd prec met flm 5900 ohms $\pm 1\%$ 1/2 w	
S1R10	0811-1535	R: fxd prec ww 300.4 K $\pm 0.2\%$ 1/4 w	
S1R11	0698-3539	R: fxd prec met flm 6.04 meg $\pm 1\%$ 1/4 w	
S2	3101-0033	Switch: s1 DPDT non-shorting 0.5 amp 125 vdc 3 amp 125 vac	
T1	9100-1325	Transformer: power 50 to 1000 cycles	
W1	8120-1348	Assembly: cable power 7.5 feet long	
		<u>MISCELLANEOUS</u>	
	5060-0727	Assembly: foot third module	
	1410-0069	Bushing: pot (CAL.)	
	1410-0289	Bushing: range switch nylon	
	5000-0711	Cover: bottom 5 x 11	
	5000-0700	Cover: side 3 x 11	
	5060-0700	Cover: top 5 x 11	
	1140-0047	Dial: Ten Turn for R1	
	5040-0700	Hinge: foot assembly	
	1400-0084	Holder: fuse extractor post type	
	0340-0099	Insulator: binding post front single	
	0340-0100	Insulator: binding post rear single	
	0370-0104	Knob: skirted bar 5/8 inch diam black (Function)	
	00735-90002	Manual: operating and service	
	00735-00205	Panel: front	
	00735-00207	Panel: rear	
	00735-00602	Shield: bottom cover 2.125 inches x 4.215 inches	
	00735-00601	Shield: top cover 2.125 inches x 4.215 inches	
	00735-00603	Shield: top cover 4.875 inches x 4.215 inches	

Table 6-2. Replaceable Parts

-hp- PART NO.	DESCRIPTION	MFR	MFR PART NO.	TQ	
0150-0052	C: fxd cer 0.05 μ f $\pm 20\%$ 400 vdcw	56289	33C17A	2	
0150-0084	C: fxd cer 0.1 μ f $+80\%$ -20% 50 vdcw	56289	33C41 obd	1	
0170-0036	C: fxd my 0.22 μ f $\pm 10\%$ 200 vdcw	56289	148P22492	1	
0180-0094	C: fxd Al elect 100 μ f $+100\%$ -10% 25 vdcw	56289	30D107G025 DH4	1	
0180-0149	C: fxd Al elect 65 μ f $+100\%$ -10% 60 vdcw	56289	Type 30D# obd	1	
0340-0099	Insulator: binding post front single	28480	0340-0099	4	
0340-0100	Insulator: binding post rear single	28480	0340-0100	3	
0370-0104	Knob: skirted bar 5/8 inch diam black (Function)	28480	0370-0104	1	
0687-1011	R: fxd comp 100 ohms $\pm 10\%$ 1/2 w	01121	EB1011	2	
0687-1031	R: fxd comp 10 K $\pm 10\%$ 1/2 w	01121	EB1031	1	
0687-1221	R: fxd comp 1.2 K $\pm 10\%$ 1/2 w	01121	EB1221	1	
0687-2721	R: fxd comp 2700 ohms $\pm 10\%$ 1/2 w	01121	EB2721	1	
0687-3321	R: fxd comp 3300 ohms $\pm 10\%$ 1/2 w	01121	EB3321	1	
0687-5601	R: fxd comp 56 ohms $\pm 10\%$ 1/2 w	01121	EB5601	1	
0687-6811	R: fxd comp 680 ohms $\pm 10\%$ 1/2 w	01121	EB6811	1	
0687-6821	R: fxd comp 6800 ohms $\pm 10\%$ 1/2 w	01121	EB6821	1	
0687-8201	R: fxd comp 82 ohms $\pm 10\%$ 1/2 w	01121	EB8201	1	
0687-8211	R: fxd comp 820 ohms $\pm 10\%$ 1/2 w	01121	EB8211	1	
0698-3406	R: fxd prec met flm 1330 ohms $\pm 1\%$ 1/2 w	75042	CEC T-O obd	1	
0698-3536	R: fxd prec met flm 5900 ohms $\pm 1\%$ 1/2 w	75042	CEC T-O obd	1	
0698-3539	R: fxd prec met flm 6.04 meg $\pm 1\%$ 1/4 w	03888	PME 65 obd	1	
0698-3574	R: fxd prec met flm 732 K $\pm 1\%$ 1/2 w	75042	CEC T-O obd	1	
0757-0196	R: fxd prec met flm 6.19 K $\pm 1\%$ 1/2 w	19701	MF7C T-O obd	1	
0757-0799	R: fxd prec met flm 121 ohms $\pm 1\%$ 1/2 w	19701	MF7C T-O obd	1	
0757-0823	R: fxd prec met flm 1820 ohms $\pm 1\%$ 1/2 w	19701	MF7C T-O obd	1	
0811-1106	R: set matched prec ww (R5 4.870 K $\pm 0.01\%$) (R6 1.020 K $\pm 0.01\%$)	28480	0811-1106	1	
0811-1534	R: fxd prec ww 120 ohms $\pm 0.02\%$ 1/4 w	28480	0811-1534	1	
0811-1535	R: fxd prec ww 300.4 K $\pm 0.2\%$ 1/4 w	28480	0811-1535	1	
0811-1539	R: fxd prec ww 5 ohms $\pm 1\%$ 1/2 w	#01686	E-20 obd	1	
0811-1541	R: fxd prec ww 12 ohms $\pm 1\%$ 1/4 w	#01686	E-20 obd	1	
0811-1545	R: fxd prec ww 6.0 ohms $\pm 0.5\%$ 1/8 w	28480	0811-1545	1	
0811-1576	R: fxd prec 146 ohms $\pm 1\%$ 1/4 w	#01686	E-20 obd	1	
1140-0047	Dial: digital readout for 10-turn pot	#000LA	3141-2 obd	1	
1200-0038	Socket: 12 pin oven	02860	77-MIP-12TM-1005	1	
1200-0044	Socket: TSTR	#07913	Type M7 (PB) obd	1	
1251-2357	Connector: ac power cord receptacle	87930	H-1061-2	1	
1400-0084	Holder: fuse extractor post type	75015	342014	1	
1410-0069	Bushing: pot (CAL.)	28480	1410-0069	1	
1410-0289	Bushing: range switch nylon	#28520	SB-437-5 obd	1	
1450-0032	Holder: lamp front mtg 2 terminals	72619	137-8536-9	1	
1450-0033	Lamp: pilot jewel 17/32 inch long	72619	137-937	1	
1510-0009	Binding post: black (GUARD and \pm)	28480	1510-0009	2	
1510-0026	Assembly: binding post red (+ OUTPUT)	28480	1510-0026	1	
1510-0027	Assembly: binding post black (- OUTPUT)	28480	1510-0027	1	
1850-0098	TSTR: Ge PNP **	28480	1850-0098	1	
1853-0001	TSTR: Si PNP **	28480	1853-0001	1	
1854-0033	TSTR: Si NPN 2N3391	24446	2N3391	3	

These code numbers are listed in the Supplement following the Code List of Manufacturers.

Table 6-2. Replaceable Parts (Cont'd)

-hp- PART NO.	DESCRIPTION	MFR	MFR PART NO.	TQ	RS
1854-0039	TSTR: Si NPN 2N3053	86684	2N3053	2	
1901-0045	Diode: Si 100 piv	04713	obd	4	
1902-0031	Diode: breakdown 12.7 v \pm 5% 400 mw	01281	PS 18270A	2	
1902-0048	Diode: breakdown 6.81 v \pm 5% 400 mw	07010	CD35858	1	
1902-3277	Diode: breakdown	07010	CD35836	1	
2100-0740	R: var ww 500 ohms \pm 5%	75042	CT-106-2 obd	1	
2100-0783	R: var ww 200 ohms \pm 5%	75042	CT-106-2 obd	2	
2100-1481	R: var 50 ohms +20% -10% 1 w	12697	76JA3CM13-2464	1	
2100-1751	R: var ww 10 ohms \pm 10% 1 w	000LJ	0400 obd	1	
2100-1580	R: var ww 1 K \pm 5% 1-1/2 w	73490	7216 obd	1	
2110-0033	Fuse: 3/4 amp 250 v	75915	F02A250V3/4A	1	
2140-0025	Lamp: incd 28 v 0.04 amp clear bulb	24446	327 obd	2	
3100-1715	Switch: rot w/o components	71500	Series 600 obd	1	
3101-0033	Switch: sl DPDT non-shorting 0.5 amp 125 vdc 3 amp 125 vac	42190	4633 obd	1	
5000-0700	Cover: side 3 x 11	28480	5000-0700	2	
5000-0711	Cover: bottom 5 x 11	28480	5000-0711	1	
5040-0700	Hinge: foot assembly	28480	5040-0700	2	
5060-0709	Cover: top 5 x 11	28480	5060-0709	1	
5060-0727	Assembly: foot third module	28480	5060-0727	2	
8120-1348	Assembly: cable power 7.5 feet long	70903	KH-4147 obd	1	
9100-1325	Transformer: power 50 to 1000 cycles	28480	9100-1325	1	
00735-00205	Panel: front	28480	00735-00201	1	
00735-00207	Panel: rear	28480	00735-00202	1	
00735-00601	Shield: top cover 2.125 inches x 4.215 inches	28480	00735-00601	1	
00735-00602	Shield: bottom cover 2.125 inches x 4.215 inches	28480	00735-00602	1	
00735-00603	Shield: top cover 4.875 inches x 4.215 inches	28480	00735-00603	2	
00735-01201	Bracket: oven mtg	28480	00735-01201	1	
00735-01202	Bracket: oven mtg	28480	00735-01202	1	
00735-61901	Assembly: switch function	28480	00735-61901	1	
00735-64101	Insulator	28480	00735-64101	1	
00735-66501	Assembly: pc board (A1)	28480	00735-66501	1	
00735-66502	Assembly: pc board (A2)	28480	00735-66502	1	
00735-66901	Oven (parts nbr)	28480	00735-66901	1	
00735-90002	Manual: operating and service	28480	00735-90001	1	

See introduction to this section

Supplement for Table 6-2
 Parts for Mounting the Power Transistor, Q1

Figure 5-5 No. Designator	Description	-hp- Part No.	TQ
1	Transistor: socket	1200-0044	1
2	Nut: 3/32" by 1/4"	2260-0001	2
3	Solder lug: internal lock	0360-0018	1
4	Washer: split	2190-0003	1
5	Washer: flat	3050-0105	2
6	Insulator	1200-0081	2
7	Grommet (on serials prefixed 504-)	0400-0009	1
8	Insulator: anodized aluminum	00735-84101	1
9	Transistor: PNP	1850-0098	1
10	Washer: internal lock	2190-0004	1
11	Screw: 7/12 inches long	2200-0008	2
-	Silicone grease, heat transfer	8500-0050	-

CODE LIST OF MANUFACTURERS

The following code numbers are from the Federal Supply Code for Manufacturers Cataloging Handbooks H4-1 (Name to Code) and H4-2 (Code to Name) and their latest supplements. The date of revision and the date of the supplements used appear at the bottom of each page. Alphabetical codes have been arbitrarily assigned to suppliers not appearing in the H4 Handbooks.

Code No.	Manufacturer	Address	Code No.	Manufacturer	Address	Code No.	Manufacturer	Address
00800	U. S. A. Common	Any supplier of U. S.	05616	Cosmo Plastic	Cleveland, Ohio	11534	Duncan Electronics Inc.	Costa Mesa, Calif.
00136	McCoy Electronics	Mount Holly Springs, Pa.	(f/o Electrical Spec. Co.)		Hockford, Ill.	11711	General Instrument Corp., Semiconductor Div.,	Newark, N. J.
00713	Sage Electronics Corp.	Rochester, N. Y.	05624	Barber Colman Co.	Hockford, Ill.	11717	Imperial Electronic, Inc.	Buena Park, Calif.
00787	Genco Inc.	Danvers, Conn.	05728	Tillen Optical Co.	Roslyn Heights, Long Island, N. Y.	11870	Melabs, Inc.	Palo Alto, Calif.
00334	Humidrol	Collon, Calif.	05729	Metro-Tel Corp.	Westbury, N. Y.	12040	National Semiconductor	Danbury, Conn.
00348	Micronip Co., Inc.	Valley Stream, N. Y.	05783	Stewart Engineering Co.	Santa Cruz, Calif.	12136	Philadelphia Handle Co.	Camden, N. J.
00373	Garlock Inc.	Cherry Hill, N. J.	05820	Wakelind Engineering Inc.	Wakelind, Mass.	12361	Glove Mfg. Co., Inc.	Shady Grove, Pa.
00656	Aerovox Corp.	New Bedford, Mass.	06004	Basick Co., Div. of Stewart Warner Corp.	Hedgeport, Conn.	12574	Gulton Ind. Inc. Data System Div.	Albuquerque, N. M.
00749	Amc. Inc.	Harrisburg, Pa.	06090	Raychem Corp.	Redwood City, Calif.	12697	Claustat Mfg. Co.	Uver, N. H.
00781	Autifast Radio Corp.	Boonton, N. J.	06125	Bausch and Lomb Optical Co.	Rochester, N. Y.	12728	Elmar Filter Corp.	W. Haven, Conn.
00815	Northern Engineering Laboratories, Inc.	Burlington, Wis.	06402	E. T. A. Products Co. of America	Chicago, Ill.	12859	Nippon Electric Co., Ltd	Tokyo, Japan
00853	Sengano Electric Co., Pickens Div.	Pickens, S. C.	06540	Anatom Electronic Hardware Co., Inc.	New Rochelle, N. Y.	12861	Metex Electronics Corp.	Clark, N. J.
00866	Sop Engineering Co.	City of Industry, Cal.	06555	Berde Electrical Instrument Co., Inc.		12930	Delta Semiconductor Inc.	Newport Beach, Calif.
00895	Carl E. Holmers Corp.	Los Angeles, Calif.	06566	General Devices Co., Inc.	Penarook, N. H.	12954	Dickson Electronics Corp.	Scottsdale, Arizona
00929	Microlab Inc.	Livingston, N. J.	06751	Components Int., Aiz. Div.	Indianapolis, Ind.	13103	Thermolyt	Dallas, Texas
01002	General Electric Co., Capacitor Dept.	Hudson Falls, N. Y.	06812	Tollington Mfg. Co., West Div.	Phoenix, Ariz.	13395	Teleclunke (GmbH)	Hanover, Germany
01009	Alphon Products Co.	Hudson, Mass.	06817			13835	Midland-Night Div. of Pacific Industries, Inc.	Mansas City, Kansas
01121	Allen-Bradley Co.	Milwaukee, Wis.	06940	Varian Assoc. Linear Div.	Van Nuys, Calif.	14099	Sem-Tech	Newbury Park, Calif.
01255	Liton Industries, Inc.	Beverly Hills, Calif.	07008	Xelvin Electric Co.	San Carlos, Calif.	14193	Calit. Resistor Corp.	Santa Anita, Calif.
01281	T-RW Semiconductors, Inc.	Lawndale, Calif.	07126	Digital Inc.	Van Nuys, Calif.	14258	American Components, Inc.	Conshohocken, Pa.
01295	Texas Instruments, Inc.	Dallas, Texas	07137	Transistor Electronics Corp.	Pasadena, Calif.	14433	ITT Semiconductor, A Div. of Int. Telephone & Telegraph Corp.	West Palm Beach, Fla.
01349	The Alliance Mfg. Co.	Alliance, Ohio	07138	Washinghouse Electric Corp. Electronic Tube Div.	Minneapolis, Minn.	14493	Hewlett-Packard Company	Loveland, Colo.
01589	Pacific Relays, Inc.	Van Nuys, Calif.	07149	Filmphm Corp.	Elmira, N. Y.	14635	Cornell Dublier Electric Corp.	Newark, N. J.
01670	Quadebnd Bibo, Sisk Co.	New York, N. Y.	07233	Cinch-Graphix Co.	New York, N. Y.	14674	Corning Glass Works	Corning, N. Y.
01930	Ampcoak Corp.	Hockford, Ill.	07256	Siltron Transistor Corp.	City of Industry, Calif.	14752	Electro Tube Inc.	San Gabriel, Calif.
01961	Pulse Engineering Co.	Santa Clara, Calif.	07261	Avnet Corp.	Corte Place, N. Y.	14903	Williams Mfg. Co.	San Jose, Calif.
02114	Ferris Tube Corp. of America	Saugerties, N. Y.	07261	Fairchild Camera & Inst. Corp. Semiconductor Div.	Culver City, Calif.	15203	Webster Electronics Co.	New York, N. Y.
02116	Wheelock Signals, Inc.	Long Beach, N. C.	07263			15287	Scientific Corp.	Northridge, Calif.
02286	Cole Rubber and Plastics Inc.	Sunnyvale, Calif.	07327	Minnesota Rubber Co.	Mountain View, Calif.	15321	Adjustable Bushing Co.	H. Hollywood, Calif.
02650	Amphenol-Borg Electronics Corp.	Broadview, Ill.	07387	Billicher Corp., The	Minneapolis, Minn.	15558	Mixon Electronics	Garden City, Long Island, N. Y.
02735	Radio Corp. of America, Semiconductor and Materials Div.	Somerville, N. J.	07397	Sylvania Elect. Prod. Inc.,	Monterey Park, Calif.	15566	Amprobe Inst. Corp.	Lynbrook, N. Y.
02771	Vocaline Co. of America, Inc.	Old Saybrook, Conn.	07397		Mountain View, Calif.	15631	Cabletronics	Costa Mesa, Calif.
02775	Hupkins Engineering Co.	San Fernando, Calif.	07700	Technical Wire Products Inc.	Cranford, N. J.	15727	Twentieth Century Coil Spring Co.	Santa Clara, Calif.
03243	Hudson Tool & Die Co.	Newark, N. J.	07879	Bodine Elect. Co.	Chicago, Ill.	15801	Fenwal Elect. Inc.	Framingham, Mass.
03508	Q-E, Semiconductor Prod. Dept.	Syracuse, N. Y.	07910	Continental Device Corp.	Hawthorne, Calif.	15816	Amelco Inc.	MI. View, Calif.
03705	Alpha Mather & Tool Co.	Dayton, Ohio	07933	Raytheon Mfg. Co., Semiconductor Div.	Mountain View, Calif.	16037	Spurce Pine Mica Co.	Spurce Pine, N. C.
03797	Eidema Corp.	Compton, Calif.	07980	Hewlett-Packard Co., Boonton Radio Div.	Boonton, N. J.	16179	Omni-Spectra Inc.	Farmington, Mich.
03818	Parker Intl. Co.	Los Angeles, Calif.	08145	U. S. Engineering Co.	Rockaway, N. J.	16352	Computer Diode Corp.	Lodi, N. J.
03877	Transistor Electric Corp.	Wakelind, Mass.	08165	Blinn, Delbert Co.	Los Angeles, Calif.	16395	Boots Aircraft Nut Corp.	Pasadena, Calif.
03888	Pyrolon Resistor Co., Inc.	Cypar Knolls, N. J.	08358	Burgess Battery Co.	Pomona, Calif.	16688	Adjustable Bushing Co., Inc. Re-Jul Meter Div.	Brooklyn, N. Y.
03954	Singer Co., Dept. Div. (Fender Plan)	Smythville, N. J.	08574	Leitch Fastener Corp.	Niagara Falls, Ontario, Canada	16758	Delta Radio Div. of G. M. Corp.	Nokoma, Ind.
04009	Alcon, Hart and Hegeman Elect. Co.	Hartford, Conn.	08664	Bristol Co., The	Los Angeles, Calif.	17109	Thermometrics Inc.	Canoga Park, Calif.
04013	Taubis Corp.	Lambertville, N. J.	08717	Sloan Company	Waterbury, Conn.	17474	Trane Company	Mountain View, Calif.
04067	Aico Electronic Int.	Great Neck, N. Y.	08718	ITT Cannon Electric Int.,	Sun Valley, Calif.	17554	Components Inc.	Biddeford, Me.
04227	Hi-Q Vision of Aerovox	Wright Beach, S. C.	08777	National Radio Lab. Int.	Phoenix Div. Phoenix, Arizona	17675	Hamiln Metal Products Corp.	Akron, Ohio
04354	Precision Paper Tube Co.	Waveling, Ill.	08792	CBS Electronics Semiconductor Operations, Div. of C. B. S. Inc.	Phoenix, N. J.	17745	Angstrom Prec. Int.	Ho. Hollywood, Calif.
04404	Dymec Division of Hewlett-Packard Co.	Palo Alto, Calif.	08806	General Electric Co. Mineral Lamp Dept.	Lowell, Mass.	17870	McGraw-Edison Co.	Manchester, N. H.
04451	Sylvania Electric Products, Microwave Devser Div.	Mountain View, Calif.	08984	Mel-Rain	Cleveland, Ohio	18042	Power Design Pacific Inc.	Palo Alto, Calif.
04673	Dakota Light, Inc.	Culver City, Calif.	09026	Barbrook Relays Div.	Indianapolis, Ind.	18053	Clevite Corp., Semiconductor Div.	Palo Alto, Calif.
04713	Malsigla, Int., Semiconductor Prod. Div.	Phoenix, Arizona	09134	Texas Capacitor Co.	Costa Mesa, Calif.	18374	Signetics Corp.	Sunnyvale, Calif.
04732	Fillion Co., Int. Western Div.	Silver City, Calif.	09145	Terh. Ind. Inc. Alphon Elect.	Houston, Texas	18476	Ty-Cor Mfg. Co., Inc.	Holliston, Mass.
04773	Automatic Electric Co.	Northlake, Ill.	09250	Electro Assemblies, Inc.	Dubank, Calif.	18486	TRW Elect. Comp. Div.	Des Plaines, Ill.
04796	Avovox Wire Co.	Hedwood City, Calif.	09353	C & K Components Inc.	Chicago, Ill.	18583	Collis Instrument, Inc.	MI. Kisco, N. Y.
04811	Precision Coil Spring Co.	El Monte, Calif.	09569	Military Battery Co. of Canada, Ltd.	Newton, Mass.	18617	Vishay Instruments Inc.	Mt. Laurel, Pa.
04870	P. M. Ho. Company	Westchester, Ill.	09927	Purdy Corp.	Toronto, Ontario, Canada	18673	E. J. DuPont and Co., Inc.	Wilmington, Del.
04919	Component Mfg. Service Co.	W. Bridgewater, Mass.	10214	General Transistor Western Corp.	Northwalk, Conn.	18911	Durant Mfg. Co.	Milwaukee, Wis.
05006	Twentieth Century Plastics, Inc.	Los Angeles, Calif.	10411	Jv-Tal, Inc.		19315	The Bendix Corp., Navigation & Control Div.	Teleboro, N. J.
05245	Components Corp.	Chicago, Ill.	10646	Carborundum Co.	Los Angeles, Calif.	19500	Thomas A. Edison Industries, Div. of McGraw-Edison Co.	West Orange, N. J.
05277	Washinghouse Electric Corp. Semi-Conductor Dept.	Chicago, Ill.	11236	CTS of Beine, Inc.	Berkeley, Calif.	19589	Concon	Baldwin Park, Calif.
05347	Ultonia, Inc.	Youngwood, Pa.	11237	Chicago Telephone of California, Inc.	Niagara Falls, N. Y.	19644	LHC Electronics	Hoiseheads, N. Y.
05397	Union Carbide Corp., Elect. Div.	New York, N. Y.	11247	Bay State Electronics Corp.	Beine, Ind.	19701	Electra Mfg. Co.	Independence, Kansas
05574	Viking Ind. Inc.	Canoga Park, Calif.	11317	Teledyne Inc., Microwave Div.	So. Pasadena, Calif.	20183	General Altonics Corp.	Philadelphia, Pa.
05593	Aico Electric-Plastics Inc.	Sunnyvale, Calif.	11314	National Seal	Waltham, Mass.	21226	Saculone, Inc.	Long Island City, N. Y.
			11453	Precision Connector Corp.	Palo Alto, Calif.	21325	Fabrit Bearing Co., The	New Britain, Conn.
					Downey, Calif.	21520	Fansteel Metallurgical Corp.	N. Chicago, Ill.
					Jamaica, N. Y.	23042	Teascan Corp.	Indianapolis, Ind.
						23783	British Radio Electronics Ltd.	Washington, D. C.
						24455	G. E. Lamp Division	Mela Park, Cleveland, Ohio

CODE LIST OF MANUFACTURERS (Continued)

Code No.	Manufacturer	Address	Code No.	Manufacturer	Address	Code No.	Manufacturer	Address
24655	General Radio Co.	West Concord, Mass.	71744	Chicago Miniature Lamp Works	Chicago, Ill.	78947	Utrinite Co.	Newtonville, Mass.
24681	Mencor Inc., Comp. Div.	Huntington, Ind.	71765	Cinch Mfg. Co., Howat B. Jones Div.	Chicago, Ill.	79136	Waldes Mohrnoel Inc.	Long Island City, N. Y.
24796	Paraflo Inc.	San Juan Capistrano, Calif.	71984	Dow Coining Corp.	Midland, Mich.	79142	Vredel Root, Inc.	Hartford, Conn.
26265	Gies Reproducer Corp.	New Rochelle, N. Y.	72136	Electro Motive Mfg. Co., Inc.	Williamston, Conn.	79251	Wentz Mfg. Co.	Chicago, Ill.
26462	Grobel File Co. of America, Inc.	Calistad, N. J.	72619	Dialight Corp.	Brooklyn, N. Y.	79777	Continental-West Electronics Corp.	Philadelphia, Pa.
26851	Compac/Hollister Co.	Hollister, Calif.	72656	Indiana General Corp., Electronics Div.	Heasby, N. J.	79963	Zierick Mfg. Corp.	New Rochelle, N. Y.
26992	Hamilton Watch Co.	Lancaster, Pa.	72699	General Instrument Corp., Cap. Div. Newark, N. J.	Newark, N. J.	80031	Meppo Division of Sessions Clock Co.	Morris-town, N. J.
27251	Specialties Mfg. Co., Inc.	Stieford, Conn.	72755	Drake Mfg. Co.	Harwood Heights, Ill.	80120	Schnitzer Alloy Products Co.	Elizabeth, N. J.
28480	Howell-Packard Co.	Palo Alto, Calif.	72875	Hugh H. Eby Inc.	Philadelphia, Pa.	80131	Electronic Industries Association, Any Brand Tube meeting EIA Standards-Washington, DC.	Washington, DC.
28520	Heyman Mfg. Co.	Kenilworth, N. J.	72928	Goodman Co.	Chicago, Ill.	80207	Unimac Switch, Div. Maxon Electronics Corp.	Wallingford, Conn.
30817	Instrument Specialties Co., Inc.	Little Falls, N. J.	72967	Elastic Stop Nut Corp.	Union, N. J.	80223	United Transformer Corp.	New York, N. Y.
33173	G. E. Receiving Tube Dept.	Owensboro, Ky.	72964	Robert M. Hadley Co.	Los Angeles, Calif.	80748	Onford Electric Corp.	Chicago, Ill.
33434	Lectich Inc.	Chicago, Ill.	72982	Eric Technological Products, Inc.	Eric, Pa.	80794	Bovins Inc.	Riverside, Calif.
36196	Stanwysk Coil Products Ltd.	Hawkesbury, Ontario, Canada	73061	Hansen Mfg. Co., Inc.	Pittston, Ind.	80411	Acro Div. of Robelshaw Controls Co.	Columbus, Ohio
36287	Cunningham, W. H. & Hill, Ltd.	Toronto Ontario, Canada	73076	H. M. Halper Co.	Chicago, Ill.	80486	All Star Products Inc.	Delaware, Ohio
37942	P. H. Mallory & Co. Inc.	Indianapolis, Ind.	73130	Heliplot Div. of Deekman Inst., Inc.	Fullerton, Calif.	80509	Avmy Label Co.	Monrovia, Calif.
39543	Mechanical Industries Prod. Co.	Akron, Ohio	73293	Hughes Products Division of Hughes Aircraft Co.	Newport Beach, Calif.	80583	Hammamund Co., Inc.	Woburn, Mass.
40920	Miniature Precision Bearings, Inc.	Keene, N. H.	73445	Amperex Elect. Co.	Hicksville, L. I., N. Y.	80640	Stevens, Ainsid, Co., Inc.	Boston, Mass.
42190	Muler Co.	Chicago, Ill.	73465	Bradley Semiconductor Corp.	New Haven, Conn.	80813	Dimeo Gray Co.	Dayton, Ohio
43390	C. A. Morgan Co.	Englewood, Colo.	73559	Cadling Electric, Inc.	Hartford, Conn.	81030	International Instruments Inc.	Orange, Conn.
44655	Omrite Mfg. Co.	Shelby, Ill.	73566	Circle T Mfg. Co.	Trenton, N. J.	81073	Clayhill Co.	LaGrange, Ill.
46384	Penn Eng. & Mfg. Corp.	Doylesdown, Pa.	73667	George H. Cavett Co., Div. MSL Industries Inc.	Philadelphia, Pa.	81095	Triad Transformers Corp.	Venice, Calif.
47804	Polaird Corp.	Cambridge, Mass.	73734	Federal Screw Products Inc.	Chicago, Ill.	81317	Winchester Elec. Div. Litton Ind., Inc.	Dakville, Conn.
48620	Precision Thermometer & Inst. Co.	Southampton, Pa.	73743	Fixtur Special Mfg. Co.	Cincinnati, Ohio	81349	Military Specification	El Segundo, Calif.
49856	Microwave & Power Tube Div.	Waltham, Mass.	73793	General Industries Co., The	Goshen, Ind.	81483	International Rectifier Corp.	Cambridge, Maryland
52090	Rowan Controller Co.	Westminster, Md.	73846	Goshen Stamping & Tool Co.	Brooklyn, N. Y.	81660	Dairy Controls, Div. Dairy Wright Corp.	Walpole, Mass.
52983	Sarobin Company	Waltham, Mass.	73899	JFD Electronics Corp.	San Jose, Calif.	82042	Carler Precision Electric Co.	Shelby, Ill.
54294	Shaltless Mfg. Co.	Selma, N. C.	73905	Jennings Radio Mfg. Corp.	Ridgeland, N. J.	82047	Sperts Faraday Inc., Copper Hewitt Electric Div.	Hoboken, N. J.
55076	Simpson Electric Co.	Chicago, Ill.	73957	Group-Pin Corp.	Neptune, N. J.	82147	Electric Regulator Division of Spicer Carbon Co.	Du Bois, Pa.
55933	Sonolone Corp.	Elmsford, N. Y.	74776	Signalnet Inc.	Worcester, Minn.	82170	Fairchild Camera & Inst. Corp. Space & Defense System Div.	Patuxent, N. J.
55938	Raytheon Co. Commercial Apparatus & Systems Div.	So. Norwalk, Conn.	74435	J. H. Winn, and Sons	Winchester, Mass.	82209	Maguire Industries, Inc.	Greenwich, Conn.
56137	Spaulding Fibre Co., Inc.	Tonawanda, N. Y.	74651	Industrial Condenser Corp.	Chicago, Ill.	82219	Sylvania Electric Prod. Inc. Electronic Tube Division	Emporium, Pa.
56789	Sprague Electric Co.	North Adams, Mass.	74868	H. F. Products Division of Amphenol-Dolg Electronics Corp.	Danbury, Conn.	82376	Astron Corp.	East Newark, N. J.
59446	Telex Corp.	Tulsa, Okla.	74970	E. F. Johnson Co.	St. Marys, Pa.	82389	Switchcraft, Inc.	Chicago, Ill.
59730	Thomas & Betts Co.	Elizabeth, N. J.	75047	International Resistance Co.	Sandwich, Ill.	82647	Metals & Controls Inc. Sensor Products	Attleboro, Mass.
60741	Teplett Electrical Inst. Co.	Bluffton, Ohio	75263	Keyline Carbon Co., Inc.	St. Marys, Pa.	82766	Phillips-Advance Control Co.	Joliet, Ill.
61775	Union Switch and Signal, Div. of Westinghouse Air Brake Co.	Pittsburgh, Pa.	75378	GTS Knights Inc.	Chicago, Ill.	82817	Hollon Mfg. Co., Inc.	Woodstock, N. Y.
62119	Universal Electric Co.	Owosso, Mich.	75382	Kulka Electric Corporation	St. Marys, Pa.	82893	Vector Electronic Co.	Glendale, Calif.
63743	Ward-Leonard Electric Co.	Mt. Vernon, N. Y.	75818	Lenz Electric Mfg. Co.	Chicago, Ill.	83014	Haitwell Corp.	Los Angeles, Calif.
64959	Western Electric Co., Inc.	New York, N. Y.	75915	Littelfuse, Inc.	Des Plaines, Ill.	83058	Carl Fastener Co.	Cambridge, Mass.
65092	Western Inst. Inc. Weston-Newark	Newark, N. J.	76005	Loid Mfg. Co.	Lisle, Pa.	83086	New Hampshire Ball Bearing, Inc.	Pittsborough, N. H.
66295	Wittek Mfg. Co.	Chicago, Ill.	76270	C. W. Wawrodt	San Francisco, Calif.	83148	ITT Wire and Cable Div.	Los Angeles, Calif.
66346	Minnesota Mining & Mfg. Co. Reverse Minicom Div.	St. Paul, Minn.	76433	General Instrument Corp., Micanol Division	Newark, N. J.	83298	Bendix Corp., Red Bank Div.	Red Bank, N. J.
70276	Allen Mfg. Co.	Hartford, Conn.	76487	James Millen Mfg. Co., Inc.	Malden, Mass.	83315	Hubbell Corp.	Mundelein, Ill.
70309	Allied Control	New York, N. Y.	76493	J. W. Miller Co.	Los Angeles, Calif.	83320	Rosam Int.	Newport Beach, Calif.
70318	Allmetal Screw Product Co., Inc.	Garden City, N. Y.	76537	Cinch-Monoduck, Div. of United Carr Fastener Corp.	San Leandro, Calif.	83332	Smith, Heiman H., Inc.	Brooklyn, N. Y.
70617	Ampex, Div. of Chrysler Corp.	Detroit, Mich.	76645	Muellet Electric Co.	Cleveland, Ohio	83385	Central Screw Co.	Palisade Park, N. J.
70485	Atlantic India Rubber Works, Inc.	Chicago, Ill.	76703	National Union	Newark, N. J.	83501	Govill Wire and Cable Co. Div. of Amerace Corp.	Brookfield, Mass.
70563	Amperite Co., Inc.	Union City, N. J.	76854	Oak Manufacturing Co.	Crystal Lake, Ill.	83594	Bulloughs Corp. Electronic Tube Div.	Pittsfield, N. J.
70674	ADC Products Inc.	Minneapolis, Minn.	77068	The Udena Corp., Electrodynamics Div.	N. Hollywood, Calif.	83740	Union Carbide Corp. Consumer Prod. Div.	New York, N. Y.
70903	Balden Mfg. Co.	Chicago, Ill.	77075	Pacific Metals Co.	San Francisco, Calif.	83777	Model Eng. & Mfg., Inc.	Huntington, Ind.
70998	Bird Electronic Corp.	Cleveland, Ohio	77271	Phonofilm Instrument and Electronic Co.	South Pasadena, Calif.	83821	Loyd Struggs Co.	Foxus, Mo.
71007	Birnbach Radio Co.	New York, N. Y.	77257	Philadelphia Steel and Wire Corp.	Philadelphia, Pa.	83947	Aeronaual Inst. & Radio Co.	Lodi, N. J.
71034	Billy Electric Co., Inc.	Eric, Pa.	77347	American Machine & Foundry Co. Polier & Blumfield Div.	Pittscon, Ind.	84171	Arco Electronics Inc.	Great Neck, N. Y.
71041	Boston Gear Works Div. of Murray Co. of Texas	Quincy, Mass.	77630	TRW Electronic Components Div.	Garden, N. J.	84396	A. J. Gieseler Co., Inc.	San Francisco, Calif.
71218	Bud Radio, Inc.	Willoughby, Ohio	77638	General Instrument Corp., Rectifier Div.	Brooklyn, N. Y.	84411	TRW Capacitor Div.	Ogallala, Neb.
71279	Cambridge Thermionics Corp.	Cambridge, Mass.	77664	Resistance Products Co.	Harrisburg, Pa.	84970	Sarkes Farzian, Inc.	Bloomington, Ind.
71286	Cantor Fastener Corp.	Panama, N. J.	77969	Rubbercraft Corp. of Calif.	Torrance, Calif.	85454	Boston Molding Company	Boston, N. J.
71313	Cardwell Condenser Corp.	Lindenhurst L. I., N. Y.	78189	Shakeproof Division of Illinois Tool Works	Elgin, Ill.	85471	A. B. Boyd Co.	San Francisco, Calif.
71400	Bussmann Mfg. Div. of McGraw-Edison Co.	St. Louis, Mo.	78277	Signa	Sp. Braintree, Mass.	85474	R. M. Bracamonte & Co.	San Francisco, Calif.
71436	Chicago Condenser Corp.	Chicago, Ill.	78283	Signal Indicator Corp.	New York, N. Y.			
71447	Calif. Spring Co., Inc.	Pico-Rivera, Calif.	78290	Stathers-Dunn Inc.	Pittman, N. J.			
71450	CTS Corp.	Eikhardt, Ind.	78474	Specialty Leather Prod. Co.	Newark, N. J.			
71468	ITT Cannon Electric Inc.	Los Angeles, Calif.	78482	Thompson-Bremer & Co.	Chicago, Ill.			
71471	Cinema, Div. Aerovox Corp.	Burbank, Calif.	78471	Tilley Mfg. Co.	San Francisco, Calif.			
71482	C. P. Close & Co.	Chicago, Ill.	78488	Stackpole Carbon Co.	St. Marys, Pa.			
71590	Centralab Div. of Globe Union Inc.	Chicago, Ill.	78493	Standard Thomson Corp.	Waltham, Mass.			
71616	Commercial Plastics Co.	Milwaukee, Wis.	78553	Tenneman Products, Inc.	Cleveland, Ohio			
71700	Cornish Wire Co., The	New York, N. Y.	78790	Trans-Jmet Engineers	San Gabriel, Calif.			
71707	Colo Coil Co., Inc.	Providence, R. I.						

CODE LIST OF MANUFACTURERS (Continued)

Code No.	Manufacturer	Address	Code No.	Manufacturer	Address	Code No.	Manufacturer	Address
85660	Keited Hoids, Inc.	Hendon, Conn.	93410	Stenco Controls, Div. of Essex Wire Corp.	Mansfield, Ohio	98144	R-Tronics, Inc.	Jamaica, N. Y.
85911	Seamless Rubber Co.	Chicago, Ill.	93632	Waters Mfg. Co.	Culver City, Calif.	98159	Rubber Tech, Inc.	Gardena, Calif.
86174	Falini Bearing Co.	Los Angeles, Calif.	93979	G. V. Controls	Livingston, N. J.	98220	Hewlett-Packard Co., Moseley Div.	Pasadena, Calif.
86197	Clifton Precision Products Co., Inc.	Clifton Heights, Pa.	94137	General Cable Corp.	Bayonne, N. J.	98278	Microdol, Inc.	So. Pasadena, Calif.
86579	Precision Rubber Products Corp.	Dayton, Ohio	94142	Phelps Dodge	Yonkers, N. Y.	98291	Selectric Corp.	Manahock, N. Y.
86584	Radio Corp. of America, Electronic Comp. & Devices Div.	Harrison, N. J.	94144	Raytheon Co., Comp. Div., Ind. Comp. Operations	Quincy, Mass.	98376	Zero Mfg. Co.	Gulbank, Calif.
86928	Spartan Mfg. Co.	Glendale, Calif.	94148	Scientific Electronics Products, Inc.	Loveland, Colo.	98410	Etc Inc.	Cleveland, Ohio
87034	Marco Industries	Anaheim, Calif.	94154	Wagner Elect. Corp., Tung-Sol Div.	Newark, N. J.	98731	General Mills Inc., Electronics Div.	Minneapolis, Minn.
87216	Philco Corporation (Lansdale Division)	Lansdale, Pa.	94197	Curtiss-Wright Corp. Electronics Div.	East Paterson, N. J.	98731	Panco Div. of Hewlett-Packard Co.	Palo Alto, Calif.
87473	Westair Fibrous Glass Products Co.	San Francisco, Calif.	94272	South Chester Corp.	Chester, Pa.	98821	North Hills Electronics, Inc.	Glen Cove, N. Y.
87664	Van Waters & Rogers Inc.	San Francisco, Calif.	94330	Wire Cloth Products, Inc.	Bellwood, Ill.	98978	International Electronic Research Corp.	Hulbank, Calif.
87930	Towar Mfg. Corp.	Providence, R.I.	94375	Aromatic Metal Products Co.	Brooklyn, N. Y.	99109	Columbia Technical Corp.	New York, N. Y.
88140	Cutter-Hammer, Inc.	Lincoln, Ill.	94682	Worcester Pressed Aluminum Corp.	Worcester, Mass.	99313	Varian Associates	Palo Alto, Calif.
88220	Gold-National Batteries, Inc.	St. Paul, Minn.	94696	Magnecraft Electric Co.	Chicago, Ill.	99378	Allee Corp.	Winchester, Mass.
88598	General Mills, Inc.	Buffalo, N. Y.	95023	George A. Philbrick Researches, Inc.	Boston, Mass.	99515	Marshall Ind., Capacitor Div.	Monrovia, Calif.
89231	Graybar Electric Co.	Oakland, Calif.	95236	Allies Products Corp.	Dania, Fla.	99707	Control Switch Division, Controls Co. of America	El Segundo, Calif.
89473	G. E. Distributing Corp.	Schenectady, N. Y.	95238	Continental Connector Corp.	Woodside, N. Y.	99800	Delevan Electronics Corp.	East Aurora, N. Y.
89665	United Transformer Co.	Chicago, Ill.	95263	Leecraft Mfg. Co., Inc.	Long Island, N. Y.	99848	Wilco Corporation	Indianapolis, Ind.
90030	United Shoe Machinery Corp.	Beverly, Mass.	95265	National Coil Co.	Shelton, Wyo.	99976	Branson Corp.	Whippany, N. J.
90179	US Rubber Co., Consumer Ind. & Plastics Prod. Div.	Passaic, N. J.	95275	Vitamom, Inc.	Bridgport, Conn.	99934	Renbrandt, Inc.	Boston, Mass.
90970	Bearing Engineering Co.	San Francisco, Calif.	95340	Gordoa Corp.	Bloomfield, N. J.	99942	Hoffman Electronics Corp. Semiconductor Div.	El Monte, Calif.
91145	ITT Cannon Elect. Inc., Salem Div.	Salem, Mass.	95354	Melindis Mfg. Co.	Rolling Meadows, Ill.	99957	Technology Instrument Corp. of Calif.	Newbury Park, Calif.
91260	Connor Spring Mfg. Co.	San Francisco, Calif.	95566	Alncol Engineering Co.	Marengo, Ill.			
91345	Miller Dial & Nameplate Co.	El Monte, Calif.	95712	Dage Electric Co., Inc.	Franklin, Ind.			
91418	Radio Materials Co.	Chicago, Ill.	95984	Slemon Mfg. Co.	Wayne, Ill.			
91506	Augat Inc.	Attitboro, Mass.	95987	Weckesser Co.	Chicago, Ill.			
91637	Dale Electronics, Inc.	Columbus, Neb.	96067	Microwave Assoc., West Int.	Sunnyvale, Calif.			
91662	Elco Corp.	Willow Grove, Pa.	96095	Hx-Q Div. of Aerovox Corp.	Osan, N. Y.			
91737	Cramer Mfg. Co., Inc.	Wakefield, Mass.	96256	Thordarson-Messner Inc.	Mt. Carmel, Ill.			
91827	H F Development Co.	Redwood City, Calif.	96296	Solar Manufacturing Co.	Los Angeles, Calif.			
91886	Malco Mfg. Co., Inc.	Chicago, Ill.	96306	Microswitch, Div. of Minn.-Honeywell	Fairport, Ill.			
91929	Honeywell Inc., Micro Switch Div.	Fairport, Ill.	96330	Critlon Screw Co.	Chicago, Ill.			
91961	Nahn-Bros. Spring Co.	Oakland, Calif.	96341	Microwave Associates, Inc.	Burlington, Mass.			
92180	Tiv-Connector Corp.	Peabody, Mass.	96501	Excel Transformer Co.	Oakland, Calif.			
92367	Elgost Optical Co. Inc.	Rochester, N. Y.	96733	San Fernando Elect. Mfg. Co.	San Fernando, Calif.			
92607	Tensolite Insulated Wire Co., Inc.	Tarrytown, N. Y.	96881	Thomson Ind. Inc.	Long Is., N. Y.			
92702	IMC Magnetics Corp.	Westbury Long Island, N. Y.	97464	Industrial Retaining Ring Co.	Ivington, N. J.			
92966	Hudson Lamp Co.	Keeney, N. J.	97539	Automatic & Precision Mfg.	Englewood, N. J.			
93332	Sylvania Electric Prod. Inc. Semiconductor Div.	Woburn, Mass.	97979	Reon Resistor Corp.	Yonkers, N. Y.			
93369	Robbins & Myers Inc.	Palisades Park, N. J.	97983	Litton System Inc., Adler-Westron Commun. Div.	New Rochelle, N. Y.			

THE FOLLOWING HP VENDORS HAVE NO NUMBER ASSIGNED IN THE LATEST SUPPLEMENT TO THE FEDERAL SUPPLY CODE FOR MANUFACTURERS HANDBOOK.

0000F	Malco Tool and Die	Los Angeles, Calif.
0000Z	Willow Leather Products Corp.	Newark, N. J.
000AB	ETA	England
000BB	Precision Instrument Components Co.	Van Nuys, Calif.
000CS	Hewlett-Packard Co., Colorado Springs	Colorado Springs, Colorado
000MM	Rubber Eng. & Development	Hayward, Calif.
000MN	A "N" D Mfg. Co.	San Jose, Calif.
000QQ	Cooltron	Oakland, Calif.
000WW	California Eastern Lab.	Burlington, Calif.
000YY	S. K. Smith Co.	Los Angeles, Calif.

**BACK DATING
MANUAL
CHANGES**

MANUAL BACKDATING CHANGES

MODEL 735A

DC TRANSFER STANDARD

Manual Serial Prefixed: 547-

-hp- Part No. 00735-00002

This manual backdating sheet makes this manual applicable to earlier instruments. Instrument-component values that differ from those in the manual, yet are not listed in the backdating sheet, should be replaced using the part number given in the manual.

Instrument Serial Prefix	Make Manual Changes	Instrument Serial Prefix	Make Manual Changes
504-	1	825-01015 and below	5
504-00150 and below	1, 2		
547-00200 and below	3		
825-00736 and below	4		

CHANGE #1

Figure 5-9. 735A Schematic and Section VI, Replaceable Parts
Delete the pre-regulator circuit consisting of A1Q5, A1CR8 and A1R13.

Section VI, Replaceable Parts

Change A1 etched circuit board from -hp- Part No. 00735-66501 Rev. B to 00735-66501 Rev. A. (Rev. B is recommended for replacement.)

Change T1 from -hp- Part No. 9100-1325 to -hp- Part No. 9100-1315. The current part is recommended for all replacements.

The large insulator under Q1 is changed from -hp- Part No. 00735-64101 to -hp- Part No. 1200-0077. The current part is recommended for all replacements.

CHANGE #2

Figure 5-9 and Section VI

Change A2R6 to -hp- Part No. 2100-0783 and A2R7* to -hp- Part No. 0698-3406. The current part is recommended for all replacements.

CHANGE #3

Section VI, Replaceable Parts

A2R2 will have the same description but change -hp- Part No. 2100-1555. The current part number is advised for all replacements.

CHANGE #4

Section VI, Replaceable Parts

Change: Panel: Front to -hp- Part No. 00735-00201.
Change: Dial Assy to -hp- Part No. 1140-0022.
Add: DS2; 2140-0025, Lamp, 28 V

CHANGE #5

Section VI, Replaceable Parts

Change J1 to -hp- Part No. 1251-0148.
Change V1 to -hp- Part No. 8120-0078.
Change Panel: rear to -hp- Part No. 00735-00202.

MANUAL CHANGES

MODEL 735A

DC TRANSFER STANDARD

Manual Part No. 00735-90002

► New or Revised Item

ERRATA

Cover Page. Change Serials Prefixed "950" to read "948".

Page 3-1. ③ Add: On later models a lever to the right of the dial assembly is depressed to lock dial.

Page 5-9. On later models A3 pin 3 (TP1) has been moved from base of A3Q1 to base of A3Q4. Change A1 pin 2 (at collector of Q2) to A1 pin 7.

Page 6-2. Change C2, C3 to 0160-0904; C: .05 microfarad 1 K vdcw. Change R6, R9 to 2100-1771; R8 to 2100-1772.

Page 6-5. Change 2110-0033 to agree with F1 in Table 6-2.

CHANGE NO. 1: FOR SERIAL NO. 948-01016 AND GREATER.

Page 6-3. Change S2 Part No. to 3101-1234. Add 5020-0700, spacer, under MISC.

Page 6-5. Add 5020-0700, spacer; MF,GR is 28480.

CHANGE NO. 2: FOR SERIAL NO. 976-01106 AND GREATER.

Page 5-9. Change schematic to reflect new values listed below.

Page 6-2. Change A1C2 to 0180-2166; 120 microfarad, 100 V. Change A1C3 to 0180-1743; C: fxd, tant 0.1 microfarad, 35 V. Change A1R4 to 0698-4633; 2.10 K, 1/4 W, 1%. Change A1R8 to 0687-4721; 4.7 K. Change A1CR5 and CR6 to 1902-C029; 12.1 V.

CHANGE NO. 3: FOR SERIAL NO. 976-01186 AND GREATER.

► Page 5-4. Paragraph 5-14d. In place of adjusting A2R2, substitute: "...remove or replace shorting links as necessary ...".

Page 5-9. Change A1R2 to 976 ohms. Change A1 schematic as shown:

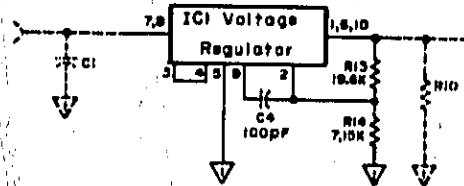

► Page 5-9. Change A2 schematic as shown:

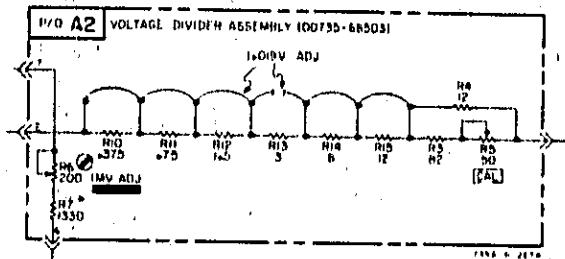

► Page 6-2. Add A1C4; 0140-0176; C: fxd 100 pF. Change A1CR7 to 5080-9034; Diode: breakdown 6.2 V. Add A1IC1; 1820-0196; IC: Voltage Regulator. Change A1R2 to 0698-4882; R: fxd 976 ohms 1/2 W 1% MF. Change A1R4 to 0757-0823; R: fxd 1.82 K 1/2 W 1% MF. Change A1R13 to 069R-3157; R: fxd 19.6 K 1/4 W 1% MF. Change A1R14 to 44471; R: fxd 7.15 K 1/4 W 1% MF. Delete Q5. Change A2 Part No. to 00735-66503.

19 October 1971

Supplement A for 00735-90002