

DIGITAL RADIOGRAPHY

FDR D-EVO II (DR-ID 1200)

Operation Manual

2nd Edition : October 2014

For Safe Operation

System
Configuration
(Product Overview)

Basic Operation

Troubleshooting

Daily Inspection and
Maintenance

Appendix

Maintenance and
Inspection

Introduction

This Operation Manual includes descriptions of matters necessary when using the FDR D-EVO II , such as the equipment overview, operation procedures and precautions to observe, as well as daily inspections and maintenance.

Accompanying documents were originally drafted in the English language.

Installation may only be conducted by authorized service personal.

Indications for use (for U.S.)

The Wired/Wireless FDR D-EVO II flat panel sensor system is intended to capture for display radiographic images of human anatomy. It is intended for use in general projection radiographic applications including pediatric and neonatal exams wherever conventional film/screen or CR systems may be used. The FDR D-EVO II is not intended for mammography, fluoroscopy, tomography, and angiography applications.

Intended use (for European Union and other countries.)

The FDR D-EVO II flat panel detector system is intended to capture for display radiographic images of human anatomy. It is intended for use in general projection radiographic applications wherever conventional film/screen or CR systems may be used.

Note : The above statements were determined by applicable medical device regulations which vary throughout the world. These statements are subject to revision when additional clearance or approval is obtained.



CAUTIONS

- 1. No part or all of this manual may be reproduced in any form without prior permission.**
 - 2. The information contained in this manual may be subject to change without prior notice.**
 - 3. FUJIFILM Corporation shall not be liable for malfunctions and damages resulting from installation, relocation, remodeling, maintenance, and repair performed by other than dealers specified by FUJIFILM Corporation.**
 - 4. FUJIFILM Corporation shall not be liable for malfunctions and damages of FUJIFILM Corporation products due to products of other manufacturers not supplied by FUJIFILM Corporation.**
 - 5. FUJIFILM Corporation shall not be liable for malfunctions and damages resulting from remodeling, maintenance, and repair using repair parts other than those specified by FUJIFILM Corporation.**
 - 6. FUJIFILM Corporation shall not be liable for malfunctions and damages resulting from negligence of precautions and operating methods contained in this manual.**
 - 7. FUJIFILM Corporation shall not be liable for malfunctions and damages resulting from use under environment conditions outside the range of using conditions for this product such as power supply, installation environment, etc. contained in this manual.**
 - 8. FUJIFILM Corporation shall not be liable for malfunctions and damages resulting from natural disasters such as fires, earthquakes, floods, lightning, etc.**
-

This system is classified as a medical device under EC Directive 93/42/EEC.

Caution : Rx Only in the United States (Federal law restricts this device to sale by or on the order of a physician.)

Open-Source Software Contained in This Product

This product contains third party's software that is made available as open source software or free software.

This software is provided "as is" with no warranty of any kind as to its merchantability or fitness for any particular purpose.

For the information on open source software contained in this product, please see the attached DVD. Source codes for certain type of open source software used in this product are available at delivery cost. If you would like to receive such source codes, please contact FUJIFILM dealer or the service representatives at the agency from which you purchased this product. (Please be noted that any inquiries concerning the contents of source codes should be directed to original licensors of open source software.)

Note : FUJIFILM has successfully performed verification and validation testing on all third party software and has confirmed its suitability to be used in this system.

Trademarks

All company names and product names described in this manual are the trademarks or registered trademarks of FUJIFILM Corporation or their respective holders.

Windows is the registered trademark of US Microsoft Corporation in the U.S.A. and other countries. SDHC Logo is a trademark of SD-3C, LLC.



Copyright © 2014 FUJIFILM Corporation. All rights reserved.

FDR D-EVO II System Operation Manuals

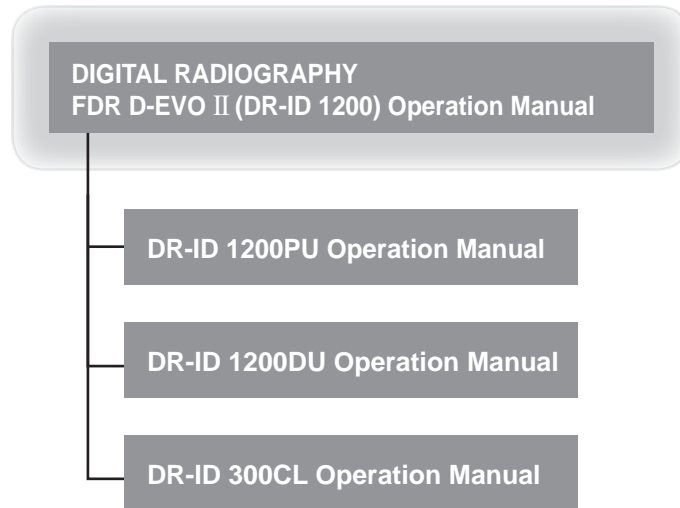

- ❶ The DR-ID 1200MC runs on a commercially available personal computer. However, operations are not required to use the FDR D-EVO II. For operations of a commercially available personal computer, see the operation manual provided by the manufacturer.

Manage and store all the Operation Manuals of the devices constituting the system together as a set.

(When the optional access point is used)

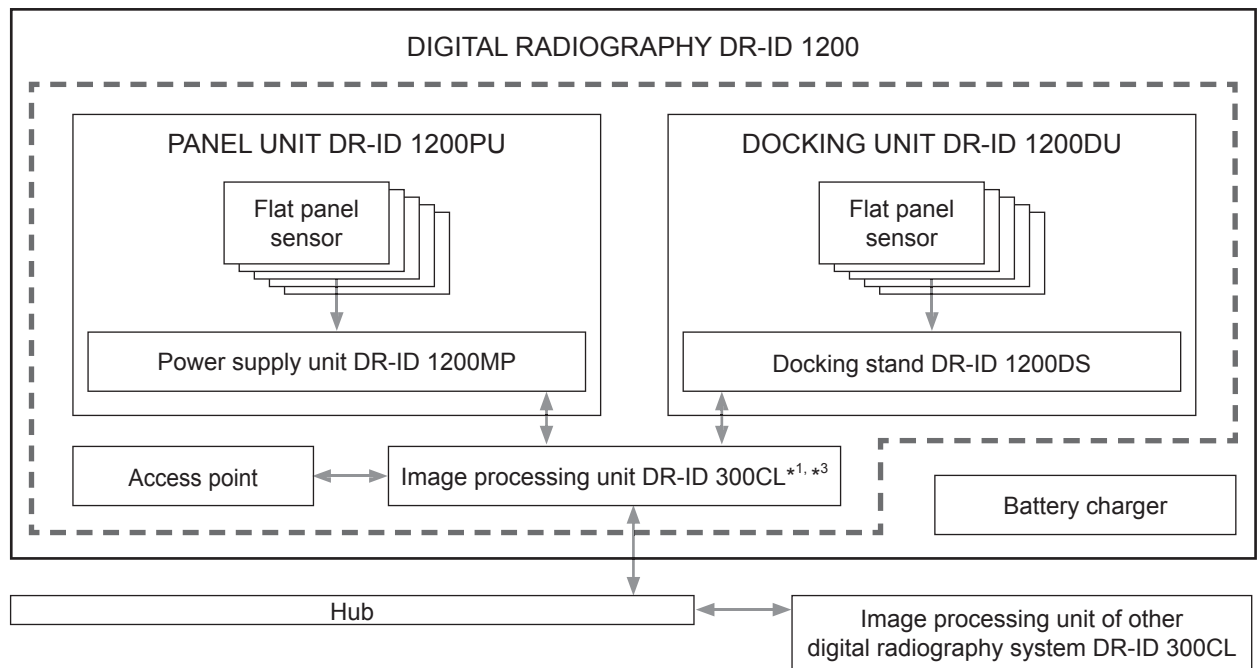

(When an access point installed in the hospital is used)

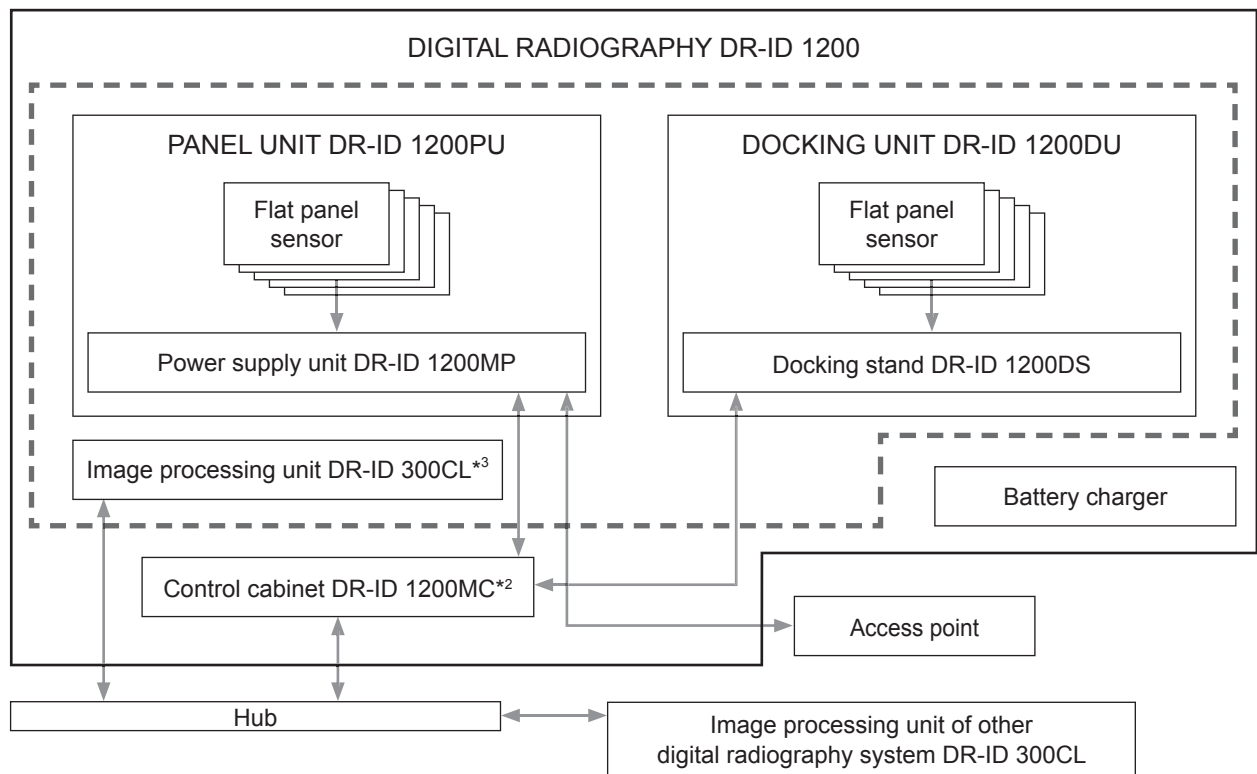

There are four types of flat panel sensors: DR-ID 1201SE, DR-ID 1202SE, DR-ID 1211SE and DR-ID 1212SE (wireless/wired communication mode). Although the contents of this manual are described by taking the example of DR-ID 1201SE, the same can also be applied to other flat panel sensors. With regard to the description specific to a certain type of flat panel sensor, the product name is given in the description.

The panel unit (DR-ID 1200PU) and the docking unit (DR-ID 1200DU) can be used simultaneously. Up to two power supply units (DR-ID 1200MP) and up to three docking stands (DR-ID 1200DS) can be used.

To use the digital radiography (DR-ID 1200), either one power supply unit or docking stand is necessary.

*1 The software for the control cabinet is installed on the image processing unit (DR-ID 300CL).

*2 Depending on the configuration, the control cabinet (DR-ID 1200MC) may not be included in the system.

If not included, the software for the control cabinet can be installed on the image processing unit (DR-ID 300CL).

For detail specification of image processing unit, please refer to “DR-ID 300CL Operation Manual”.

*3 When the image processing unit (DR-ID 300CL) is used in patient environment, run the notebook computer on battery power.

Contents at a Glance

Chapter 1 For Safe Operation
This chapter presents Warnings and Cautions we wish you to observe for safe operation of the FDR D-EVO II.

Chapter 2 System Configuration (Product Overview)
This chapter gives the various unit names and describes their functions and features of the FDR D-EVO II.

Chapter 3 Basic Operation
This chapter describes start-up, shut-down and other basic operations of the FDR D-EVO II.

Chapter 4 Troubleshooting
This chapter describes how to troubleshoot in the event of an error on the FDR D-EVO II, and provides explanations about a list of error messages each of which appears when an error occurs.

Chapter 5 Daily Inspection and Maintenance
This chapter describes daily care and maintenance we wish you to perform so that you can use the FDR D-EVO II optimally.

Appendix
Appendix A Specifications
Appendix Z Precautions for Exposure
Appendix O Use of Optional Items

Maintenance and Inspection

Radio frequency (RF) compliance information

How to Read This Manual

Basic page layout

Please have a good grasp of the basic page configuration of this Operation Manual, as illustrated below, for you to use it more efficiently.

Section title

Shows the title of an operation procedure described in the section.

Lead

Describes information we wish you to know in advance of your operating the system or information that may help you to operate it.

Operation procedure

Describes an operation procedure according to sequential numbers.

Index

A caption that facilitates you to open a desired [Chapter] quickly.

The diagram shows a page from an operation manual with several callouts pointing to specific parts. The page content includes a section title, a lead paragraph, a sub-section title, a numbered list of steps, and caution boxes. A vertical index label 'Basic Operation' is on the right side. At the bottom right, the page number '3-9' is shown next to the manual title 'FDR D-EVO II Operation Manual 897N120339A'.

3.2 Starting Up and Shutting Down the System

This section explains how to start up and shut down the system. Operations are required on the power supply unit, docking stand, flat panel sensor and image processing unit.

The image processing unit in this section is only an example. For details on the image processing unit being used, see the Operation Manual provided with the personal computer.

3.2.1 Starting Up the System

(When the DR-ID 1200PU is used)

Make sure that the power cable is connected to the image processing unit.

- 1** When the flat panel sensor is used in wireless communication mode, install the fully charged battery pack to the flat panel sensor.
When it is used in wired communication mode, connect the flat panel sensor and the power supply unit using the SE cable.
- 2** Press the ON side of the main switch of the power supply unit.
Make sure that the power status LED is lit in blue.
- 3** When the optional access point is used, connect the access point to the image processing unit.

CAUTIONS

Use the optional access point by connecting it to the preset image processing unit and to the USB connector. Do not use the optional access point by connecting it to other image processing unit and/or USB connector.

- 4** Press the ON side of the main switch of the power supply unit.
The initialization process starts.
 - All cables should be connected properly.
 - No media should be inserted into the disk drive of image processing unit.If the control cabinet is included in the system, the control cabinet starts up automatically.

CAUTIONS

If the power status LED of the control cabinet does not come on after turning on the image processing unit, turn on the control cabinet.

Basic Operation

FDR D-EVO II Operation Manual 897N120339A 3-9

Page number

Displayed in conjunction with the chapter number.

Marks

Information items to be observed when you are operating this system and the supplementary remarks are described in this manual with the respective marks.

For the safe system operation, be sure to observe Warning/Caution.



WARNING

Indicates hazardous situations that may lead to serious injuries or even death if the precaution is not or cannot be followed.



CAUTIONS

Indicates hazardous situations that may lead to mild or moderate injury or physical damages if the caution is not or cannot be followed.



Indicates procedures requiring special attention, instructions that must be followed, supplementary explanations, etc.



HINT

Shows an item helpful for further effective system operation.



Shows a more detailed operation method or an item that describes additional information.

Expressions

Messages appear on the display panel and the buttons are shown as below.

- **Buttons (example)**



Select .

The button to operate is shown.

Contents

Introduction.....	iii
FDR D-EVO II System Operation Manuals.....	v
Contents at a Glance.....	ix
How to Read This Manual.....	x

Chapter 1 For Safe Operation

1.1	Precautions Before Operating This Equipment.....	1-1
1.2	Precautions to be Observed When Using the Electric Medical Equipment.....	1-2
1.3	Safety.....	1-3
1.4	Electromagnetic Compatibility (EMC).....	1-12
1.4.1	DR-ID 1200.....	1-12
1.5	Precautions in Using the FDR D-EVO II.....	1-17
1.5.1	Handling.....	1-17
1.5.2	Before Exposure.....	1-18
1.5.3	During Exposure.....	1-19
1.5.4	During Cleaning.....	1-20
1.5.5	Storage.....	1-20
1.5.6	Precautions Related to the Load Applied to the Flat Panel Sensor.....	1-21
1.5.7	Radio Waves.....	1-22
1.5.8	Battery Pack Status Indicator.....	1-23
1.6	Locations of Labels and Signs.....	1-24
1.6.1	Locations of Labels.....	1-24
1.6.2	DR-ID 1200.....	1-26
1.6.3	DR-ID 1200PU.....	1-27
1.6.4	DR-ID 1200DU.....	1-27
1.6.4	Safety and Other Symbols.....	1-28
1.6.5	Symboles de sécurité et autres.....	1-29
1.7	Installation Conditions.....	1-30
1.7.1	Definition of Patient Environment.....	1-30
1.7.2	Installation Precautions.....	1-31
1.7.3	Precautions for Installing the Access Point (Optional).....	1-31

Chapter 2 System Configuration (Product Overview)

2.1	FDR D-EVO II.....	2-1
2.1.1	System Configuration.....	2-1
2.1.2	Features of the FDR D-EVO II.....	2-3
2.2	Unit Names and the Functions.....	2-4
2.2.1	DR-ID 1200.....	2-4
2.3	Image Processing Unit Display Configuration.....	2-9
2.4	Routine Operation Diagram.....	2-13
2.5	Wireless Specifications.....	2-14

Chapter 3 Basic Operation

3.1	Preparing the Flat Panel Sensor	3-1
3.1.1	Type of Flat Panel Sensor	3-1
3.1.2	Number of the Connectable Flat Panel Sensors	3-1
3.1.3	Connecting/Disconnecting the Flat Panel Sensor Connector.....	3-1
3.1.4	Inserting/Removing the Flat Panel Sensor into/ from the Radiographic Examination Stand	3-2
3.1.5	Changing the Direction of the Flat Panel Sensor Connector.....	3-4
3.1.6	Charging the Battery Pack for the Flat Panel Sensor	3-5
3.1.7	Charging the Image Processing Unit.....	3-6
3.1.8	Installing/Removing the Battery Pack for the Flat Panel Sensor	3-6
3.1.10	Attaching the Flat Panel Sensor to the Docking Stand.....	3-8
3.2	Starting Up and Shutting Down the System	3-9
3.2.1	Starting Up the System.....	3-9
3.2.2	Shutting Down the System	3-11
3.3	Routine Operations	3-13
Step 1	Entering the Patient Information	3-14
Step 2	Selecting the Anatomical Region and Exposure/Study Menu.....	3-15
Step 3	X-ray Exposure	3-17
	[1] Positioning the patient	3-17
	[2] X-ray exposure/Image displaying	3-18
	[3] Sleep mode.....	3-19
	[4] Extended Image Readout.....	3-19
3.4	How to Use Memory Exposure Mode.....	3-20
3.4.1	How to Start up and Use Memory Exposure Mode	3-20
3.4.2	How to Load Images.....	3-21
3.4.3	List of Error Codes.....	3-22
3.4.4	How to Terminate Memory Exposure Mode.....	3-22

Chapter 4 Troubleshooting

4.1	When a Message Appears on the Image Processing Unit.....	4-1
	[1] If a warning dialog box appears	4-1
	[2] If the message dialogue box MD11001 appears.....	4-1
	[3] If an exposed image cannot be acquired	4-2
	[4] If the dialog box containing the error message numbered 13048 appears.....	4-3
	[5] If “Unusable due to error.” appears on the image processing unit.....	4-3
	[6] If any other message dialogue box appears	4-4
4.2	How to Cope with an Error... ..	4-5
	[1] When the image processing unit hangs up... ..	4-5
	[2] When the image processing unit is turned off due to an electrical outage.....	4-5
	[3] If a hard disk of the image processing unit is damaged.....	4-6
	[4] If a white image is displayed after an exposure	4-6
	[5] Precautions for operation when the device status is “Initializing” or “Changing FPD” in the image processing unit’s “Output Device Status window”	4-6
	[6] If the flat panel sensor cannot be used in wireless communication mode	4-6
	[7] If an error occurs on an output destination device	4-7

Chapter 5 Daily Inspection and Maintenance

5.1	Daily User Inspection and Maintenance	5-1
5.1.1	Daily Inspection (DR-ID 1200).....	5-1
5.1.2	Periodical Inspection.....	5-2

Appendix A Specifications

A.1	Specifications	A-1
A.1.1	Processing Capacity (DR-ID 1200).....	A-1
A.1.2	Image Output (DR-ID 1200).....	A-1
A.1.3	Reduced Equivalent.....	A-2
A.1.4	Power Supply Conditions.....	A-3
A.1.5	Environmental Conditions.....	A-3
A.2	External View and Weight	A-5
A.2.1	DR-ID 1200.....	A-5
A.3	Characteristics.....	A-9

Appendix Z Precautions for Exposure

Z.1	Precautions for Exposure in AUTO MODE	Z-1
Z.1.1	Radiation Field.....	Z-1
Z.1.2	Depiction of the Cervical Region	Z-2
Z.1.3	Depiction of the HIP JOINT AXL – 2 Menu	Z-2
Z.1.4	EDR Image Data Analysis	Z-3
Z.2	Precautions for Exposure in SEMI-AUTO MODE	Z-4
Z.3	Precautions for Exposure in SEMI-X MODE	Z-5
Z.4	Precautions for Exposure in FIX MODE.....	Z-6
Z.5	Precautions for the Automatic X-ray Detection Function.....	Z-7
Z.5.1	Precautions for Making an Exposure.....	Z-7
Z.5.2	Precautions Related to the X-ray Exposure Time.....	Z-8
Z.6	Precautions for Use in Wireless Communication Mode	Z-9
Z.7	Other Precautions	Z-10
Z.7.1	Precautions for Exposure of a Subject in Relatively Large Contrast.....	Z-10
Z.7.2	Precautions for Flat Panel Sensor	Z-10
Z.7.3	Precautions for Assuring the Radiation Field.....	Z-10
Z.7.4	Images Output When the X-ray Shot Switch is Operated Incorrectly.....	Z-10
Z.7.5	Precautions for Urgent Use	Z-11
Z.7.6	Precautions Related to Continuous Operation	Z-11
Z.7.7	Precautions Related to Grid.....	Z-11
Z.7.8	Precautions during Calibration.....	Z-11
Z.7.9	Precautions for Exposing the Flat Panel Sensor to X-ray.....	Z-11
Z.7.10	Precautions for Extended Image Readout.....	Z-11
Z.7.10	Precautions for Using the Access Point	Z-12

Appendix O Use of Optional Items

O.1	Optional Items	O-1
O.2	Using the SE Storage Case	O-2
O.3	Using the Retaining Bracket for MP	O-3
O.4	DS Anchor Fixing Bracket	O-4
O.5	Wall Fixing Bracket.....	O-5
O.6	Access Point.....	O-6

Maintenance and Inspection

Radio frequency (RF) compliance information

Compliance with 1999/5/EC	3
---------------------------------	---

Chapter 1 For Safe Operation

1.1 Precautions Before Operating This Equipment

Before using this equipment, please read “Precautions Before Operating This Equipment” carefully so that you can operate it correctly.

Whenever you operate this equipment, be sure to observe those precautions. Failure to do so may cause you to subject to injuries or property damage to occur.

The institution where the equipment is installed is responsible for its use and maintenance.
In addition, this equipment should not be used by persons other than doctors or suitably trained staff.

This system is classified as a medical device under EC Directive 93/42/EEC.
This equipment has been designed on the assumption that the patient would not come into direct contact with it or for operation by appropriately trained operator.

Process waste correctly, as stipulated by local law or any regulations that apply.

Part of the components contains harmful substances which may pollute the ambient environment if disposed carelessly. For details on product disposal, contact our official dealer or FUJIFILM Representative.

1.2 Precautions to be Observed When Using the Electric Medical Equipment

We ask that you observe these usage precautions and use the equipment correctly.

1. This equipment should be used only by people who have the proper skills.
2. Observe the following precautions when installing the equipment.
 - 2-1. Install the equipment where water will not splash it.
 - 2-2. Install the equipment where it will not be adversely affected by air pressure, temperature, humidity, ventilation, sunlight, dust or the presence of salt, sulfur or like substances in the atmosphere.
 - 2-3. Make sure the equipment will remain in stable condition on a level surface and not be subjected to vibration or shock.
 - 2-4. Do not install the equipment in places where chemicals are stored or gases emitted.
 - 2-5. Make sure that the power frequency, voltage and power consumption are appropriate.
 - 2-6. Connect the ground wire correctly.
3. Observe the following precautions before beginning to use the device.
 - 3-1. Confirm that the ground wire has been completely connected.
 - 3-2. Make sure that all cords have been connected properly and safely.
 - 3-3. Be aware that correct diagnosis can be hindered and danger can result from using different pieces of equipment together.
 - 3-4. Make sure that the battery and power supply are installed properly.
4. Observe the following precautions when using the equipment.
 - 4-1. Make sure not to exceed the time and dose required for diagnosis.
 - 4-2. Always monitor the patient and the equipment for abnormalities.
 - 4-3. Take an appropriate action, such as stopping the equipment after ensuring the patient's safety, if any abnormalities are found in his/her health or in the equipment.
5. Observe the following precautions after using the equipment.
 - 5-1. Using the established procedure, then turn the power off.
 - 5-2. When unplugging cords, do not pull on the body of the cord itself or apply unnecessary force.
 - 5-3. Observe the following precautions when storing the equipment.
 - I Store the equipment where water will not splash it.
 - II Store the equipment where it will not be adversely affected by air pressure, temperature, humidity, ventilation, sunlight, dust or the presence of salt, sulfur or like substances in the atmosphere.
 - III Make sure the equipment will remain in stable condition on a level surface and not be subjected to vibration or shock.
 - IV Do not store the equipment in places where chemicals are stored or gases emitted.
 - 5-4. After using the accessories, recollect them and put them back in order.
 - 5-5. Make sure to clean the equipment for the next use.
6. If there is trouble with the equipment, do not attempt to fix it randomly. Instead, do what is indicated and entrust repairs to a professional.
7. Do not remodel the equipment.
8. Maintenance and Inspection
 - 8-1. Make inspect the equipment and parts periodically.
 - 8-2. If the equipment has not been used for a long time, make sure that it operates normally and safely prior to using it again.
9. Other Items
 - 9-1. When subjecting patients (particularly infants and pregnant women) to radiation, make sure not to exceed the necessary time and dose. Also, ensure that radiation is contained within the exposure plane of the flat panel sensor.
 - 9-2. Follow the Operation Manual and operate the equipment correctly.

1.3 Safety

Before using the FDR D-EVO II, read this section thoroughly to ensure that you use the product properly.

Electric Shock Warnings and Cautions

 **WARNING**

The power supply to the FDR D-EVO II is AC100 to 240V.
To avoid electric shocks, users should always take the following precautions:

- Do not open any covers when it is not necessary.
- Install the equipment in a location where it will not be exposed to water.
- Make sure that the ground wire of the equipment is connected completely.
- Check that all of the cables are completely and securely connected.
- Keep the control cabinet out of reach of patients.

 **WARNING**

Do not touch the patient's body while touching the control cabinet and the image processing unit. Otherwise, the patient may receive an electric shock.

 **WARNING**

Do not use a multiple tap connector or extension cable for powering the devices constituting the system. Otherwise, fire or electric shock may occur due to the electrical load exceeding the allowable limit.

 **WARNING**

Observe the following precautions when using the cables.

- Do not touch the plug and connector with wet hands. Otherwise, electric shock may result, causing death or severe injury.
- Hold the plug or connector when removing the cable.
Pulling the cable or carrying by holding it may damage the cable, causing fire or electric shock.
- Do not damage or remodel the cable.
Do not place a heavy object on the cable or lay it under the flat panel sensor. Do not step on, pull, forcibly bend, or bundle the cable. Otherwise, fire or electric shock may result.

 **WARNING**

Do not turn on the system with dew condensation on the flat panel sensor. Otherwise, fire or electric shock may result.

 **WARNING**

Do not use the equipment in a location where metal particles could come into the equipment. This may cause an electric shock.

 **WARNING**

Do not disassemble or remodel the equipment. Otherwise, fire or electric shock may result. Keep away from the parts inside the product, which may cause electric shock. If you touch them accidentally, death or severe injury may result.



WARNING

Do not hit or drop the equipment or subject it to severe shock. Otherwise, the equipment may be damaged. If the damaged equipment is used, fire or electric shock may result. In addition, do not apply strong pressure onto the flat panel sensor. If applied, the flat panel sensor deforms and the waterproof function may be compromised.



WARNING/AVERTISSEMENT

Do not use the flat panel sensor without the battery packs. If the battery packs are not attached, an electric shock may result.

N'utilisez pas le détecteur à panneau plat sans les batteries. Si les batteries ne sont pas connectées, un choc électrique risque de se produire.



WARNING

Make sure to use the optional parts and accessories recommended by us. Failure to use the optional parts and accessories recommended by us may result in damage to the equipment and/or electric shock and injury.



CAUTIONS

As the cables of the equipment are long, be careful not to entangle the cables during use. Also, be careful not to trip over the cables. Falls could result in injury.



CAUTIONS

Follow the specified procedure when turning off the equipment. Otherwise, the flat panel sensor could be damaged by thermal shock.



CAUTIONS

Do not store magnetic media near the DR system and control cabinet. Otherwise, magnetism generated by the equipment may cause the data to be lost.



CAUTIONS

Keep the equipment away from patient's body fluids, chemicals, water, etc. Otherwise, it may become damaged, causing fire or electric shock. If necessary, protect the flat panel sensor by covering it with a disposable bag.

Explosion Warnings



WARNING

Because this equipment is not explosion-proof, do not use combustible and explosive gases near the equipment.



WARNING

Flammable gasses may stay in the room after disinfection. If you turn the system on just after disinfection, ensure that the room is well ventilated before powering on the system.

Warnings for Abnormalities



WARNING

If any of the following occurs, immediately turn off the power of each unit, unplug the power cable from the outlet, and then contact our official dealer or FUJIFILM Representative.

- When smoke, strange odor, or abnormal sound is present.
- When a foreign object (such as a metal object) or liquid enters the product.
- When the equipment is dropped or hit and is damaged.

Avertissements relatifs aux anomalies



AVERTISSEMENT

Si l'une des conditions répertoriées ci-après se produit, mettez immédiatement chaque unité hors tension, débranchez le cordon d'alimentation de la prise secteur, puis contactez notre revendeur agréé ou notre représentant FUJIFILM.

- En cas de présence de fumée, d'une odeur étrange ou d'un bruit anormal.
- En cas de pénétration d'un corps étranger (comme un objet métallique) ou d'un liquide dans le produit.
- En cas d'endommagement de l'équipement suite à une chute ou à un impact.

Installation Precautions



CAUTIONS

Do not install the system in a location with the following conditions.

- Where the temperature changes sharply.
- Close to heat sources such as a heater.
- Where the system may be exposed to water due to water leakage or ingress.
- Where corrosive gas may be generated.
- Where there is excessive dust.
- Where the system is subject to frequent or excessive vibration/shock.
- Where the system is exposed to direct sunlight.
- Where there is no ventilator.



CAUTIONS

Use the equipment on a flat place. If the equipment falls, it may cause damage to the equipment or personal injury.



CAUTIONS

When you move the equipment, place it in the cassette storage box of a mobile X-ray unit or hold it by hand to prevent it from falling. If the cart is used to move the equipment, place it horizontally.



CAUTIONS

For veterinary or mobile applications, please contact our official dealer or FUJIFILM Representative.



CAUTIONS

When the devices are used outdoors in wireless communication mode, contact our official dealer or FUJIFILM Representative.

CAUTIONS/ATTENTION

Do not place any object in a place where removal of the power cable is prevented.
Ne placez aucun objet à un emplacement gênant le débranchement du câble d'alimentation.

CAUTIONS

To ensure optimal image quality, it is recommended that you do not use the flat panel sensor near devices (motor, transformer, switching supply, etc.) that generate electromagnetic noise.

CAUTIONS

To ensure optimal image quality, it is recommended that you do not place the cables (power cable, communication cable, etc.) of the equipment near devices (motor, transformer, switching supply, etc.) that generate electromagnetic noise and their cables.

CAUTIONS

Do not install the power supply unit in a place where it may be contacted inadvertently. In addition, take care not to make contact with the power supply unit except when operating the main switch. If the fan inside the power supply unit malfunctions, the power supply unit may become hot, causing injury.

Connection Instructions

WARNING

Make sure that the devices to be connected to the equipment are authorized for connection.

WARNING

Connect the panel unit DR-ID 1200PU and the docking unit DR-ID 1200DU only to the access point, image processing unit or the control cabinet.

Precautions on External Network Connection

CAUTIONS

When a setting of the network to which the equipment is connected has been changed, check that the change does not affect the system operation and take measures if necessary. The setting change may include the following:

- Change of connection destination
- Addition of devices
- Removal of devices
- Update of devices
- Upgrade of devices

Warnings and Cautions on Network



WARNING

Make sure to use the optional parts, accessories and networks recommended by us. Failure to use the optional parts, accessories and networks recommended by us may result in damage to the equipment and/or electric shock and injury.



CAUTIONS

Connect to the Ethernet Network of 100BASE-TX or 10BASE-T prescribed in the IEEE standard 802.3. Do not connect telephone lines to LAN connector. Only UTP-type straight LAN cables of 4-pair Category 5 cable (CAT 5E) or higher are appropriate for connection to this connector.



CAUTIONS

After connecting this system to the network with other systems, confirm that the other systems are not affected. If they are affected, take countermeasures such as network separation.

System Isolation Instructions



WARNING

To ensure complete system isolation, never install any unauthorized accessories or other such items.

When it is necessary to install authorized accessories or optional items, contact our official dealer or FUJIFILM Representative.



WARNING

Keep equipment other than those used for patients out of their reach to ensure appropriate system isolation.



WARNING

In normal use, have a patient take a proper positioning for exposure. The operator should operate the system in a place where safety from radiation is ensured. The operator should also make sure before exposure that no one but the patient is in the exposure area and the operating area of the system.

Software Precautions



CAUTIONS

Do not install additional software to the system. Do not uninstall any of the software preinstalled in the system.

The system is preinstalled with the appropriate software. If other software is installed or if the existing software is uninstalled, various operational errors may result.

Disinfection Instructions



WARNING

Confirm that the respiratory density of disinfectant including solvent is under legal regulation. Certain disinfectants may damage health. When using a disinfectant, follow instructions supplied by the manufacturers.



WARNING

Do not use the following disinfectants or sterilizers at the time of disinfection. Quality, performance and safety of the equipment cannot be assured.

- Chloric disinfectant which is strongly corrosive to metals and rubber parts.
- Disinfectant whose uses on metals, plastics, and coating are forbidden according to the instructions supplied with the disinfectant.
- Formalin gas and disinfectant sprays that may get inside the equipment.
- Ultraviolet sterilizers

Disinfectant ethanol is recommended for disinfection. Carefully read the instructions and cautions supplied with the disinfectant before use.

For details on the disinfectant, contact a FUJIFILM dealer or the service representatives at the agency from which you purchased the disinfectant.



CAUTIONS

If flat panel sensor is not disinfected, it may lead secondary infection.
Be sure to disinfect with ethanol after use.



CAUTIONS

Clean the sensor unit of the flat panel sensor with ethanol for disinfection, etc. for each patient to prevent infection.

Precautions for Charging the Battery Pack



CAUTIONS

Observe the following precautions when charging the battery pack (optional) using the battery charger (optional).

- Do not use the battery pack (125Y120005) or battery charger in combination with any battery pack or battery charger (including the power cable) other than those recommended by FUJIFILM Corporation.
- Do not disassemble or convert the battery pack or battery charger.
- If the battery pack or battery charger becomes faulty, consult our official dealer or FUJIFILM Representative.
- Do not cover the holes in the battery charger with foreign matter.
- Avoid the accumulation of dust on the battery charger.
- Insert the battery pack into the battery charger securely.
- If the insertion direction or position of the battery pack is incorrect, the battery pack is not charged properly.
- When inserting the battery pack, prevent foreign matter from getting into the battery charger.
- While charging the battery pack, do not allow the battery pack or battery charger get wet or dusty.
- Do not step on the AC adapter of the battery charger. Also, be careful not to trip over the power cable.
- Do not subject the battery pack and battery charger to severe shock (by dropping them, etc.).
- Do not place the battery charger within the reach of patients.

- Do not charge the battery pack near fire or under strong sunshine. If the built-in protection mechanisms are activated by a high temperature, the battery pack cannot be charged. Also, if the built-in protection mechanisms are damaged, the battery pack may be charged with extremely high current and voltage, and abnormal chemical reactions may occur inside the battery pack, causing it to overheat, emit smoke, explode or ignite.
- To charge the battery pack, be sure to use the designated battery charger and to observe the charging conditions specified by FUJIFILM Corporation. If the battery pack is charged in other conditions (temperature or voltage/current higher than specified, remodeled battery charger, etc.), the battery pack may be overcharged or charged with extremely high current, and abnormal chemical reactions may occur inside the battery pack, causing it to overheat, emit smoke, explode or ignite.
- Immediately stop charging the battery pack, if charging is not completed within the specified time. Otherwise, the battery pack may overheat, emit smoke, explode or ignite.
- Do not use the flat panel sensor near the power cable.
- Do not use a faulty or broken battery charger or AC adapter.
- Note that the flat panel sensor cannot be charged by using the SE communication cable that connects the flat panel sensor and the access point (optional).

Battery Pack Instructions



WARNING

- Battery pack requires regular checkup and replacement. Battery capacity begins to wane after a period of time.
- If this equipment is not in use for while, store it with the battery pack removed. Not removing the battery pack may cause malfunction.



CAUTIONS

Observe the following precautions when using the battery pack (optional).

- The battery pack (125N100050) is used with the flat panel sensor. Do not use them in other combinations.
- Charge the battery pack only with the designated battery charger. If the battery pack is charged under the charging conditions (voltage, current and charging method) different from those specified by FUJIFILM Corporation, the battery pack may emit smoke, ignite, explode or leak fluid.
- Store the battery pack in a cool and dark place. Recharge the stored battery pack every six months or every year. Otherwise a decrease in battery capacity or other problems may result.
- Do not leave the removed battery pack in the car or other places exposed to high temperature. If the battery pack is used or stored in a place where it is exposed to high temperature, the battery pack may emit smoke, ignite, explode or leak fluid.
- Use or store the battery pack only in the environmental conditions specified by FUJIFILM Corporation. If the battery pack is used or stored in a place where it is exposed to high temperature, the battery pack may emit smoke, ignite, explode or leak fluid.
- When disposing of the battery pack, consult our official dealer or FUJIFILM Representative.
- Do not disassemble or remodel the battery pack. The battery pack is equipped with built-in safety and protection mechanisms. If they are damaged, the battery pack may overheat, emit smoke, explode or ignite.
- Be careful not to drop the battery pack. The patient may be injured.
- Do not touch the terminal of the battery pack directly. There is a risk of electric shock.
- Do not connect the positive (+) and negative (-) terminals with a wire or any metal object. Do not carry or store the battery pack together with metal objects such as necklaces or hairpins. Otherwise, the battery pack may short-circuit and overcurrent may flow, causing the battery pack to overheat, emit smoke, explode or ignite. Metal objects such as necklaces or hairpins may also become hot.
- Do not throw the battery pack into fire or expose it to excessive heat. Otherwise, its insulator may melt, its gas release vent or safety mechanisms may be damaged, and/or its electrolyte may catch fire, causing the battery pack to overheat, emit smoke, explode or ignite.
- Do not use or leave the battery pack in a place where it is exposed to high temperature (80°C or higher), such as fire or a heater. If the resin separator is damaged due to heat, the battery pack may short-circuit, causing it to overheat, emit smoke, explode or ignite.

- Do not immerse the battery pack in water or seawater, and do not allow it to become wet. If the built-in protection mechanisms are damaged, the battery pack may overheat, emit smoke, explode or ignite.
- Do not pierce the battery pack with a nail, hit it with a hammer, or step on it. Otherwise, the battery pack may be damaged or deformed and short-circuit, causing it to overheat, emit smoke, explode or ignite.
- Do not subject the battery pack to strong impact or throw it. If the built-in protection mechanisms are damaged, the battery pack may be charged with extremely high current and voltage, and abnormal chemical reactions may occur inside the battery pack, causing it to overheat, emit smoke, explode or ignite.
- Do not use an apparently damaged or deformed battery pack. Otherwise, the battery pack may overheat, emit smoke, explode or ignite.
- Do not solder the battery pack directly. Otherwise, its insulator may melt, or its gas release vent or safety mechanisms may be damaged, causing the battery pack to overheat, emit smoke, explode or ignite.
- Do not reverse the positive (+) and negative (-) terminals. Otherwise, the battery pack may be reverse-charged during charging. As a result, abnormal chemical reactions may occur inside the battery pack, or extremely high current may flow during discharging, causing it to overheat, emit smoke, explode or ignite.
- The battery pack has a predetermined polarity. If you cannot connect the battery pack to the battery charger or other equipment, do not connect the battery pack forcefully. Make sure that the terminals are correctly oriented. If the battery pack is connected in reverse, it will be reverse-charged, and abnormal chemical reactions may occur inside the battery pack, causing it to overheat, emit smoke, explode or ignite.
- Do not connect the battery pack to an electrical outlet or cigarette lighter socket in a car. Overcurrent may flow to the battery pack due to high voltage applied, causing the battery pack to overheat, emit smoke, explode or ignite.
- Do not use the battery pack for equipment other than those specified. Otherwise, the guaranteed performance will be reduced and/or the service life will be shortened. Depending on the equipment to which the battery pack is connected, extremely high current may flow, causing the battery pack to be damaged, overheat, emit smoke, explode or ignite.
- If the electrolyte leaked from the battery pack enters the eyes, do not rub them. Wash the eyes immediately with clean water such as tap water, and consult a doctor. Otherwise, eye injury may result.
- Do not use the battery pack in combination with a primary battery such as a dry battery or other battery of a different capacity, type and/or brand. Otherwise, the battery pack may be overcharged during charging, and abnormal chemical reactions may occur inside the battery pack, causing it to overheat, emit smoke, explode or ignite.
- Do not put the battery pack in a microwave oven or high-pressure container. Otherwise, the battery pack may be rapidly heated or damaged, causing it to overheat, emit smoke, explode or ignite.
- If the battery pack leaks or emits an unusual odor, remove it from fire immediately. Otherwise, the leaked electrolyte may catch fire, causing the battery pack to overheat, emit smoke, explode or ignite.
- If you notice an unusual odor, heat, discoloration, deformation or any other abnormality during use, charging or storage, remove the battery pack from the equipment or battery charger, and stop using it. Otherwise, the battery pack may overheat, emit smoke, explode or ignite.
- Do not use the battery pack exposed to a strong magnetic field of an MRI system, etc.
- Do not use the battery pack immersed in liquid.

Warnings for Pediatric Use



WARNING

- If the exposure conditions for average-size adults are applied to children, it may cause excessive radiation exposure.
- Studies show that children are more radiosensitive than adults (i.e. children are at higher risk of developing cancer compared to adults exposed to the same dose of ionizing radiation). Accordingly, in pediatric use, special attention needs to be paid to avoid unnecessary exposure.
- Based on the clinical application, pathological conditions of the patient, patient size, and anatomical imaging region, adjust the exposure conditions to use the minimum amount of radiation necessary to obtain appropriate medical images.
- An additional filter can also be used for children to reduce unnecessary exposure further.

- If children cannot be exposed at an appropriate dose with the AEC, do not use the AEC.
- Adjust the exposure conditions to minimize the X-ray exposure time to avoid repeated exposure due to body movement.

Other Warnings and Cautions



WARNING

No modification of this equipment is allowed.



CAUTIONS

Install the system in accordance with what is provided by IEC 60601-1-1:2000 and IEC 60601-1:2005 Chapter 16. Contact our official dealer or FUJIFILM Representative for installation (except the flat panel sensor) of the system.



CAUTIONS

Do not hit or drop the equipment. Otherwise, injury or damage to images, etc. may result.



CAUTIONS

Be sure to inspect the system periodically.
To assure optimum performance of the equipment, it is necessary to systematically perform maintenance and inspection. For information on maintenance and inspection, contact our official dealer or FUJIFILM Representative.



CAUTIONS

Do not perform maintenance and inspection while the equipment is used for a patient.



CAUTIONS

Although the flat panel sensor conforms to IPX6, no warranty is given as to the prevention of water intrusion in the flat panel sensor. If the flat panel sensor is splashed with water, wipe off moisture and ensure that the flat panel sensor is completely dry before use.

Contraindications and Prohibitions

No contraindications present.

Classification

- According to the type of protection against electrical shock
Class 1 equipment
- According to the degree of protection against electrical shock
Type B applied part
- According to the degree of protection against harmful ingress of water
IPX0 (The flat panel sensor conforms to IPX6)
- According to the degree of safety of application in the presence of a flammable anesthetics mixture with air or with oxygen or nitrous oxide.
Equipment not suitable for use in the presence of a flammable anesthetics mixture with air or with oxygen or nitrous oxide.
- According to the mode of operation
CONTINUOUS OPERATION

1.4 Electromagnetic Compatibility (EMC)



Essential performance

- (1) DR-ID 1201SE/DR-ID 1202SE/DR-ID 1211SE/DR-ID 1212SE obtains images.
- (2) DR-ID 1200MC stores images.
- (3) DR-ID 1200MC corrects images.
- (4) Image transfer in order from DR-ID 1201SE/DR-ID 1202SE/DR-ID 1211SE/DR-ID 1212SE to the DR-ID 1200MC or the image processing unit.
- (5) Image processing unit stores and displays images after correction.
- (6) It shall fulfill and maintain the safety requirement of the standards.



DR-ID 1200 is consists of following components and conforms to IEC 60601-1-2 as a result of each component conforms to following standards.

1.4.1 DR-ID 1200

DR-ID 1200 consists of DR-ID 1200MC, DR-ID 300CL , DR-ID 1200MP , DR-ID 1200DS and DR-ID 1201SE/DR-ID 1202SE/DR-ID 1211SE/DR-ID 1212SE

This equipment has been tested and found to comply with the limits for medical devices to the IEC 60601-1-2 (EN 60601-1-2), Medical Device Directive 93/42/EEC.

These limits are designed to provide reasonable protection against harmful interference in a typical medical installation.

This equipment generates, uses and can radiate radio frequency energy and, if not installed and used in accordance with the instructions, may cause harmful interference to other devices in the vicinity.

However, there is no guarantee that interference will not occur in a particular installation.

If this equipment does cause harmful interference to other devices, which can be determined by tuning the equipment off and on, the user is encouraged to try to correct the interference by one or more of the following measures:

- Reorient or relocate the receiving device.
- Increase the separation between the equipment.
- Connect the equipment into an outlet on a circuit different from that to which the other device(s) are connected.

If the problem cannot be solved with the above measures, stop using this equipment and consult the manufacturer, our official dealer or FUJIFILM Representative for help.



WARNING

- **Do not place devices generating electromagnetic wave near this equipment.**
- **If a device(s) other than those specified is connected, predetermined EMC performance cannot be guaranteed.**

Further Information for IEC 60601-1-2 (EN 60601-1-2)

1. Medical electrical equipment needs special precautions regarding EMC and needs to be installed and put into service according to the EMC information provided in the accompanying documents.
2. Portable and mobile RF communications equipment can affect medical electrical equipment.
3. Information regarding the cable affecting EMC is as follows.

Name	Connected Device	Maximum Length	General Specification
Network Cable	Between the DR-ID 1200PU and the DR-ID 1200MC	20m (65.6 ft)	Cat5e or more, UTP type and straight cable
	Between the DR-ID 1200DU and the DR-ID 1200MC		
	Between the DR-ID 1200MC and the DR-ID 300CL		
Power Cable	DR-ID 1200MC, DR-ID 300CL	Use a hospital grade power cable. (for North America)	
		A non-hospital grade power cable can be used. (for other countries)	

4. The use of accessories, transducers and cables other than those specified, with the exception of transducers and cables sold by FUJIFILM Corporation as replacement parts for internal components, may result in increased emissions or decreased immunity of the DR-ID 1200.
5. The DR-ID 1200 should not be used adjacent to or stacked with other equipment.
If adjacent or stacked use is necessary, the DR-ID 1200 should be observed to verify normal operation in the configuration in which it will be used.
6. Basic performance of the equipment and the system
After image data are acquired from the flat panel sensor, data correction is performed by the control cabinet (DR-ID 1200MC), and the image is saved in and displayed on the image processing unit.
7. Test items (Tables 1 to 4)

Table 1

Guidance and manufacturer's declaration - electromagnetic emissions			
The DR-ID 1200 is intended for use in the electromagnetic environment specified below. The customer or the user of the DR-ID 1200 should assure that it is used in such an environment.			
Emissions test	Compliance		Electromagnetic environment - guidance
RF emissions CISPR 11	Group 1		The DR-ID 1200 uses RF energy only for their internal function. Therefore, their RF emissions are very low and are not likely to cause any interference in nearby electronic equipment.
RF emissions CISPR 11	Class B		The DR-ID 1200 is suitable for use in all establishments, including domestic establishments and those directly connected to the public low-voltage power supply network that supplies buildings used for domestic purposes.
Harmonic emissions IEC 61000-3-2	Complies	DR-ID 1200: Class A	
Voltage fluctuations/ flicker emissions IEC 61000-3-3	Complies		

Table 2

Guidance and manufacturer's declaration - electromagnetic immunity			
The DR-ID 1200 is intended for use in the electromagnetic environment specified below. The customer or the user of the DR-ID 1200 should assure that it is used in such an environment.			
Immunity test	IEC 60601-1-2 test level	Compliance level	Electromagnetic environment - guidance
Electrostatic discharge (ESD) IEC 61000-4-2	±6kV contact ±8kV air	±6kV contact ±8kV air	Floors should be wood, concrete or ceramic tile. If floors are covered with synthetic material, the relative humidity should be at least 30%.
Electrical fast transient/burst IEC 61000-4-4	±2kV for power supply lines ±1kV for input/output lines	±2kV for power supply lines ±1kV for input/output lines	Mains power quality should be that of a typical commercial or hospital environment.
Surge IEC 61000-4-5	±1kV differential mode ±2kV common mode	±1kV differential mode ±2kV common mode	Mains power quality should be that of a typical commercial or hospital environment.
Voltage dips, short interruptions and voltage variations on power supply input lines IEC 61000-4-11	<5% U_T (>95% dip in U_T) for 0.5 cycle 40% U_T (60% dip in U_T) for 5 cycles 70% U_T (30% dip in U_T) for 25 cycles <5% U_T (>95% dip in U_T) for 5 s	<5% U_T (>95% dip in U_T) for 0.5 cycle 40% U_T (60% dip in U_T) for 5 cycles 70% U_T (30% dip in U_T) for 25 cycles <5% U_T (>95% dip in U_T) for 5 s	Mains power quality should be that of a typical commercial or hospital environment. If the user of the DR-ID 1200 requires continued operation during power mains interruptions, it is recommended that the DR-ID 1200 be powered from an uninterruptible power supply or a battery.
Power frequency (50/60Hz) magnetic field IEC 61000-4-8	3 A/m	3 A/m	Power frequency magnetic fields should be at levels characteristic of a typical location in a typical commercial or hospital environment.
NOTE: U_T is the a.c. mains voltage prior to application of the test level.			

Table 3

Guidance and manufacturer's declaration - electromagnetic immunity			
The DR-ID 1200 is intended for use in the electromagnetic environment specified below. The customer or the user of the DR-ID 1200 should assure that it is used in such an environment.			
Immunity test	IEC 60601-1-2 test level	Compliance level	Electromagnetic environment - guidance
Conducted RF IEC 61000-4-6	3 Vrms 150 kHz to 80 MHz	3 Vrms	Portable and mobile RF communications equipment should be used no closer to any part of the DR-ID 1200, including cables, than the recommended separation distance calculated from the equation applicable to the frequency of the transmitter.
Radiated RF IEC 61000-4-3	3 V/m 80 MHz to 2.5 GHz	3 V/m	<p>Recommended separation distance</p> $d = 1.2\sqrt{P}$ $d = 1.2\sqrt{P} \quad 80 \text{ MHz to } 800 \text{ MHz}$ $d = 2.3\sqrt{P} \quad 800 \text{ MHz to } 2.5 \text{ GHz}$ <p>where P is the maximum output power rating of the transmitter in watts (W) according to the transmitter manufacturer and d is the recommended separation distance in metres (m).</p> <p>Field strengths from fixed RF transmitters, as determined by an electromagnetic site survey,^a should be less than the compliance level in each frequency range.^b</p> <p>Interference may occur in the vicinity of equipment marked with the following symbol:</p> 
NOTE 1: At 80 MHz and 800 MHz, the higher frequency range applies.			
NOTE 2: These guidelines may not apply in all situations. Electromagnetic propagation is affected by absorption and reflection from structures, objects and people.			
<p>a Field strength from fixed transmitters, such as base stations for radio (cellular/cordless) telephones and land mobile radios, amateur radio, AM and FM radio broadcast and TV broadcast cannot be predicted theoretically with accuracy. To assess the electromagnetic environment due to fixed RF transmitters, an electromagnetic site survey should be considered. If the measured field strength in the location in which the DR-ID 1200 is used exceeds the applicable RF compliance, the DR-ID 1200 should be observed to verify normal operation. If abnormal performance is observed, additional measures may be necessary, such as reorienting or relocating the DR-ID 1200.</p> <p>b Over the frequency range 150 kHz to 80 MHz, field strength should be less than 3 V/m.</p>			

Table 4

Recommended separation distances between Portable and mobile RF communications equipment and the DR-ID 1200			
<p>The DR-ID 1200 is intended for use in the electromagnetic environment in which radiated RF disturbances are controlled.</p> <p>The customer or the user of the DR-ID 1200 can help prevent electromagnetic interference by maintaining a minimum distance between portable and mobile RF communications equipment (transmitters) and the DR-ID 1200 as recommended below, according to the maximum output power of the communications equipment.</p>			
Rated maximum output power of transmitter W	Separation distance according to frequency of transmitter m		
	150 kHz to 80 MHz $d = 1.2\sqrt{P}$	80 MHz to 800 MHz $d = 1.2\sqrt{P}$	800 MHz to 2.5 GHz $d = 2.3\sqrt{P}$
0.01	0.12	0.12	0.23
0.1	0.38	0.38	0.73
1	1.2	1.2	2.3
10	3.8	3.8	7.3
100	12	12	23
<p>For transmitters rated at a maximum output power not listed above, the recommended separation distance d in metres (m) can be estimated using the equation applicable to the frequency of the transmitter, where P is the maximum output power rating of the transmitter in watts (W) according to the transmitter manufacturer.</p>			
<p>NOTE 1: At 80 MHz and 800 MHz, the separation distance for the higher frequency range applies.</p> <p>NOTE 2: These guidelines may not apply in all situations. Electromagnetic propagation is affected by absorption and reflection from structures, objects and people.</p>			

1.5 Precautions in Using the FDR D-EVO II

This section describes the precautions in using the FDR D-EVO II.

1.5.1 Handling

Handle the flat panel sensor carefully since they are manufactured with precision.

If the flat panel sensor or the SE communication cable is hit or dropped or is subjected to severe shock, it may be malfunction. Be aware of dropping the devices could result in injury or device breakage also may cause injury.

If the front and rear of the flat panel sensor are subject to impact by a projection, it may be damaged.

Do not apply strong pressure onto the flat panel sensor.

If applied, the flat panel sensor deforms and the waterproof function may be compromised.

Do not pull the SE communication cable.

Also, do not pull the flat panel sensor with something caught by the cable.

Make sure that the cable is not trapped under the wheels of a stretcher or wheelchair.

In addition, be careful not to catch the cable when using or storing it.

Otherwise, the cable will be damaged, causing fire, electric shock or communication failure.

Do not hold the flat panel sensor in one hand when carrying it.

Hold it in both the hands or under the arm.

When carrying or storing the flat panel sensor, remove the battery pack from it.

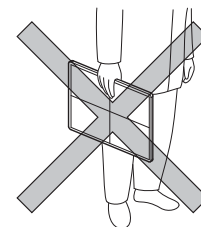
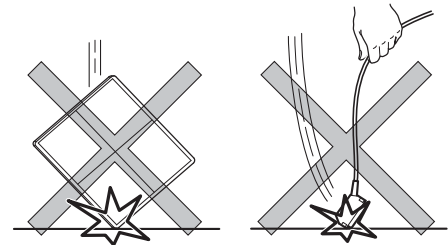

If a seal that covers a screw peels from the side surface of the flat panel sensor, contact a FUJIFILM dealer. If the seal is not attached, artifacts caused by discharge of static electricity may appear.

To ensure optimal image quality, it is recommended that you do not use the flat panel sensor near devices (motor, transformer, switching supply, etc.) that generate electromagnetic noise.

To ensure optimal image quality, it is recommended that you do not place the cables (power cable, communication cable, etc.) of the equipment near devices (motor, transformer, switching supply, etc.) that generate electromagnetic noise and their cables.

Make sure that no liquid enters the flat panel sensor from around the battery section. In addition, when attaching the battery pack, make sure that the waterproof packing attached to the connector terminal of the flat panel sensor is aligned properly. Otherwise, the flat panel sensor may be damaged.

Do not use a multiple tap connector or extension cable for powering the devices constituting the system.

Up to five flat panel sensors can be connected. If you intend to use six or more flat panel sensors, only the first five that were connected to the image processing unit can be used.

For this reason, when six or more flat panel sensors are registered, be careful not to use a wrong one, as you may confuse which flat panel sensor is connected.

Before making an exposure, make sure that the flat panel sensor identification lamp on the flat panel sensor to be used and the panel icon selected on the screen of the image processing unit are the same color.

When a flat panel sensor is communicating with a power supply unit, docking stand or access point in a room, if the flat panel sensor is moved to another room where there is another power supply unit, docking stand or access point, communication between the flat panel sensor and the device in the first room may still be established. To establish communication between the flat panel sensor and a device in the second room, connect the flat panel sensor to the device with the cable or insert it into the docking stand. The flat panel sensor is recognized and wireless communication becomes available.

Do not place the cable terminal on the floor, as doing so may cause infection.

Also, clean the cable and the terminal periodically.

Do not insert the flat panel sensor into a CR reader unit.

1.5.2 Before Exposure

The use of an air-conditioner may dramatically changes the temperature of the room where the system is installed. This may cause dew condensation on the system, resulting in quality problems. When an air-conditioner is used, change the temperature gradually to avoid temperature variation in order not to cause dew condensation.

If an exposure is made with the front and rear of the flat panel sensor facing the other way round, not only the re-exposure is required but electric parts of inside the equipment may be damaged.

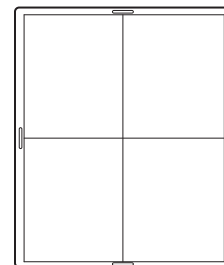

Exposure plane of the flat panel sensor

1.5.3 During Exposure

Before making an exposure, make sure that exposure conditions most appropriate for this system are set.

Do not apply an excessive force to the exposure plane.

The sensor inside the flat panel sensor may be damaged, and it may not be possible to make an exposure properly.

<Load restriction>

Entire surface load : DR-ID 1201SE, DR-ID 1202SE, DR-ID 1211SE
and DR-ID 1212SE :
310kg (683.6 lb)

Local load : DR-ID 1201SE, DR-ID 1202SE, DR-ID 1211SE and
DR-ID 1212SE :
160kg (352.8 lb) / \varnothing 40mm (1.6 in.)
(Based on FUJIFILM measurement specifications)

Use the flat panel sensor on a flat floor or platform.

When an excessive force is applied to the unit when it is tilted, the sensor inside the flat panel sensor may be damaged.

Do not place a metal plate, etc., which blocks radio waves, before the antenna. Otherwise, data may not be sent correctly from the flat panel sensor.

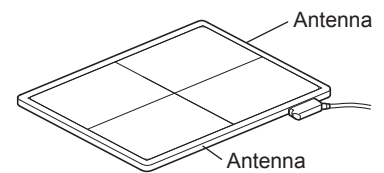
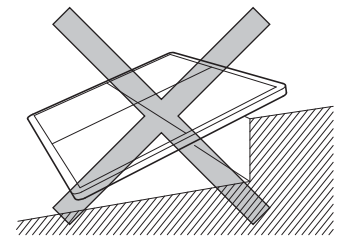
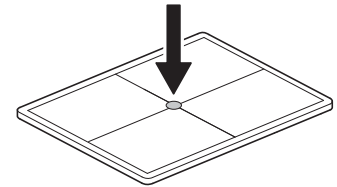
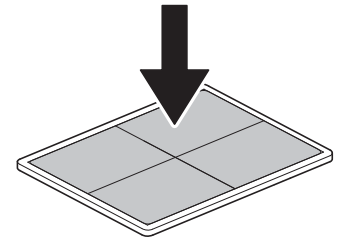

When the SE communication cable is connected to the flat panel sensor to make an exposure on a bed, follow the precautions below. Otherwise a load may be applied locally to the SE communication cable connectors, causing damage to the flat panel sensor.

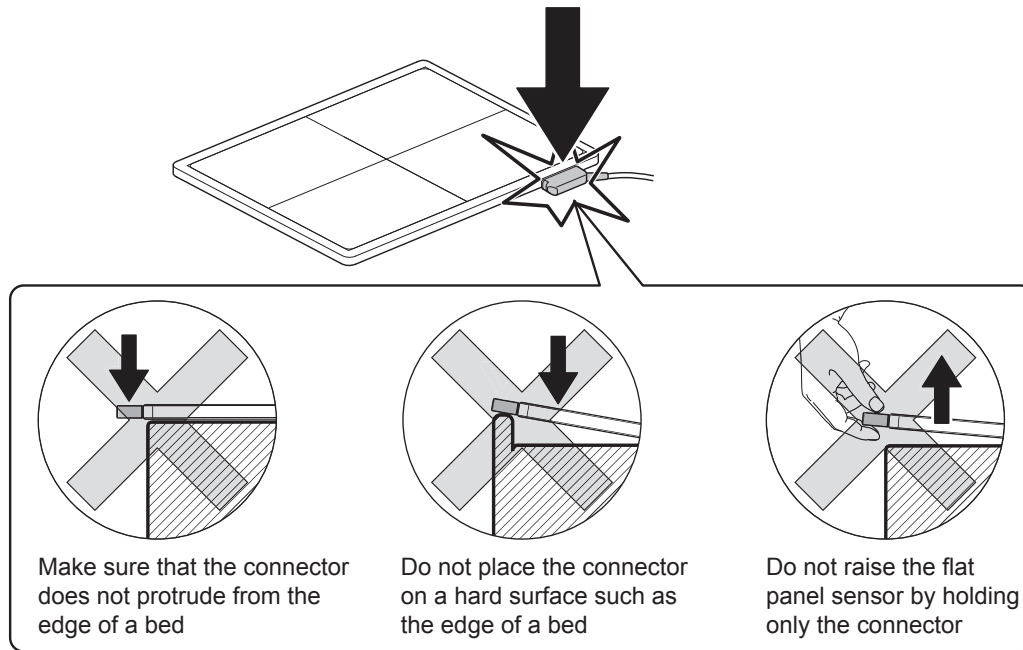

1.5.4 During Cleaning

To clean the outer surfaces, use a cleaning cloth tightly wrung out of commercially available ethanol (or diluted neutral detergent).



CAUTIONS

- Be sure to turn off the power before cleaning each part of the device.
- Do not use an excessive amount of ethanol (or neutral detergent), as doing so may allow the liquid to enter from the gap on the outer surfaces, resulting in the damage to the flat panel sensor, or cause the labels to come off.
- Do not use a solvent such as thinner or benzene, as it corrodes the outer surfaces.
- For other available disinfectants, consult our official dealer.

1.5.5 Storage

When the flat panel sensor and the image processing unit are not in use, store them in a place where they do not fall or drop.

1.5.6 Precautions Related to the Load Applied to the Flat Panel Sensor

If excessive load is applied to the flat panel sensor, use it on a flat floor or platform. When making an exposure for the patient in a wheelchair or adjustable bed or on a stretcher, the flat panel sensor may be deformed (slightly warped).

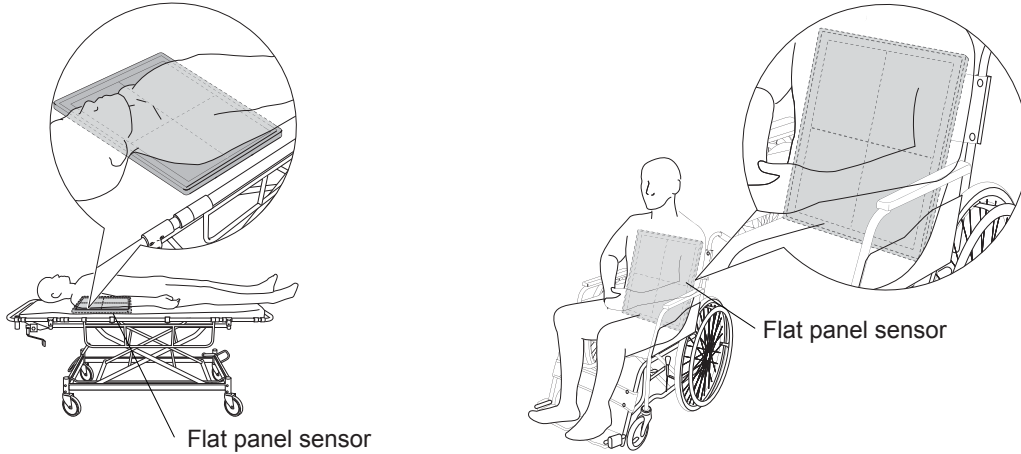

In case that the flat panel sensor is deformed, make sure that X-ray images are not adversely affected before continuing the use of the flat panel sensor.

The precautions below must also be observed when making an exposure.

- Do not have the patient stand on the flat panel sensor.
- Do not place the hard devices such as spine board on the flat panel sensor.

Excessive load is applied locally and the flat panel sensor may be damaged.

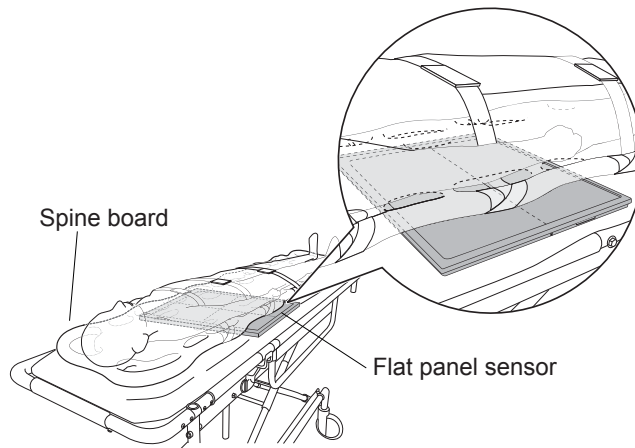

Even when the flat panel sensor is used on a flat floor or platform, it may be damaged if the applied load exceeds the limit.

1.5.7 Radio Waves

Wireless specifications for the flat panel sensor and access point are as follows.

	Flat panel sensor	Access point (optional)
Wireless specification	IEEE802.11n	IEEE 802.11n
Transmit frequency	5.2, 5.3, 5.6, 5.8, 2.4 GHz	5.2, 5.3, 5.6, 5.8, 2.4 GHz
Modulation	OFDM	OFDM
Frequency tolerance	±20 ppm	±20 ppm
Data transfer rate	35 Mbps	35 Mbps
Transfer power	17 dBm or less	15.91 dBm or less

For wireless specifications of the image processing unit, see “DR-ID 300CL Operation Manual”.



CAUTIONS

- **Radio waves available outdoors vary, depending on the country where the system is used. (For U.S.)**
Radio waves in the 5.2GHz frequency band can be used indoors only.
When radio waves in the 5.3GHz and 5.6GHz frequency bands are selected, the DFS function will operate.
- **When the FDR D-EVO II and any other wireless equipment are operating on the same frequency channel in a hospital, it may take time to show an image on the image processing unit monitor.**



CAUTIONS

The available scientific evidence does not show that any health problems are associated with using low power wireless devices. There is no proof, however, that these low power wireless devices are absolutely safe. Low power Wireless devices emit low levels of radio frequency energy (RF) in the microwave range while being used. Whereas high levels of RF can produce health effects (by heating tissue), exposure of low-level RF that does not produce heating effects causes no known adverse health effects. Many studies of low-level RF exposures have not found any biological effects. Some studies have suggested that some biological effects might occur, but such findings have not been confirmed by additional research. DR-ID 1201SE/DR-ID 1202SE/DR-ID 1211SE/DR-ID 1212SE has been tested and found to comply with FCC/IC radiation exposure limits set forth for an uncontrolled environment and meets the FCC radio frequency (RF) Exposure Guidelines and RSS-102 of the IC radio frequency (RF) Exposure rules.

Les connaissances scientifiques dont nous disposons n'ont mis en évidence aucun problème de santé associé à l'usage des appareils sans fil à faible puissance. Nous ne sommes cependant pas en mesure de prouver que ces appareils sans fil à faible puissance sont entièrement sans danger. Les appareils sans fil à faible puissance émettent une énergie radioélectrique (RF) très faible dans le spectre des micro-ondes lorsqu'ils sont utilisés. Alors qu'une dose élevée de RF peut avoir des effets sur la santé (en chauffant les tissus), l'exposition à de faibles RF qui ne produisent pas de chaleur n'a pas de mauvais effets connus sur la santé. De nombreuses études ont été menées sur les expositions aux RF faibles et n'ont découvert aucun effet biologique. Certaines études ont suggéré qu'il pouvait y avoir certains effets biologiques, mais ces résultats n'ont pas été confirmés par des recherches supplémentaires. DR-ID 1201SE/DR-ID 1202SE/DR-ID 1211SE/DR-ID 1212SE a été testé et jugé conforme aux limites d'exposition aux rayonnements énoncées pour un environnement non contrôlé et respecte les règles des radioélectriques (RF) de la FCC lignes directrices d'exposition et d'exposition aux fréquences radioélectriques (RF) CNR-102 de l'IC.

1.5.8 Battery Pack Status Indicator

The status and operable time of the battery pack used for the flat panel sensor are shown by the exposure unit battery indicator in the connected devices status at the lower right of the image processing unit's display.

The battery pack status indicator shows the remaining capacity of the battery pack. Each icon is described below.



For details of the connected devices status, see the "Console Advance (DR-ID 300CL) Reference Guide".

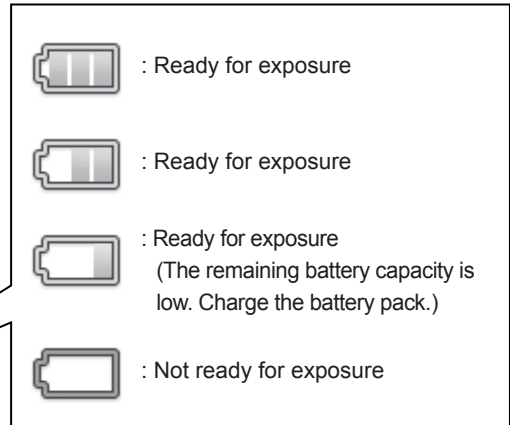

Check the operable time on the image processing unit's display when the flat panel sensor is in use. Note that the displayed time differs, depending on the mode being used.

1.6 Locations of Labels and Signs

Locations of labels and signs affixed to the FDR D-EVO II, and the relevant safety signs are shown below.

1.6.1 Locations of Labels

Flat panel sensor (DR-ID 1201SE)

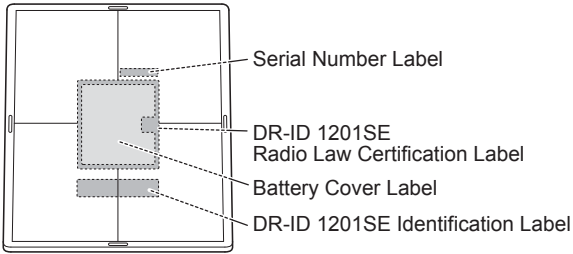

<Exposure plane>

Flat panel sensor (DR-ID 1202SE)

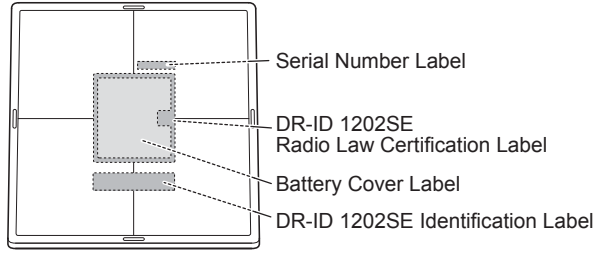

<Exposure plane>

Flat panel sensor (DR-ID 1211SE)

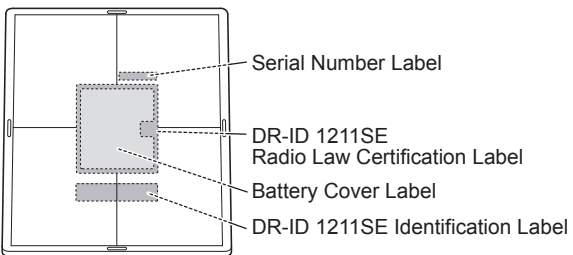

<Exposure plane>

Flat panel sensor (DR-ID 1212SE)

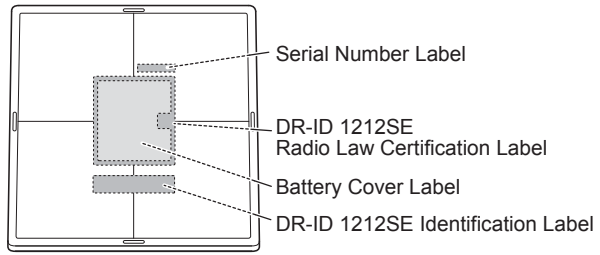

<Exposure plane>

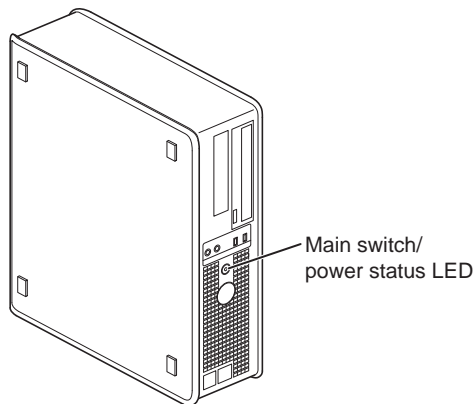

Control cabinet (DR-ID 1200MC)



If the control cabinet is not included in the system, the DR-ID 1200MC identification label is placed on the CD case of the software for the control cabinet.

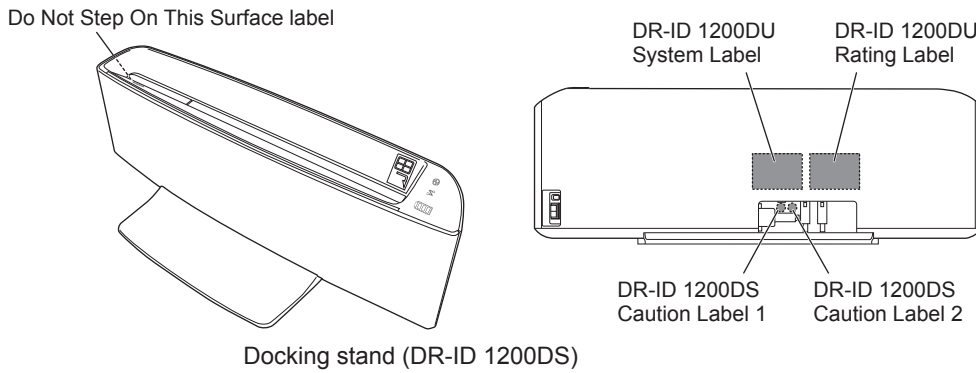
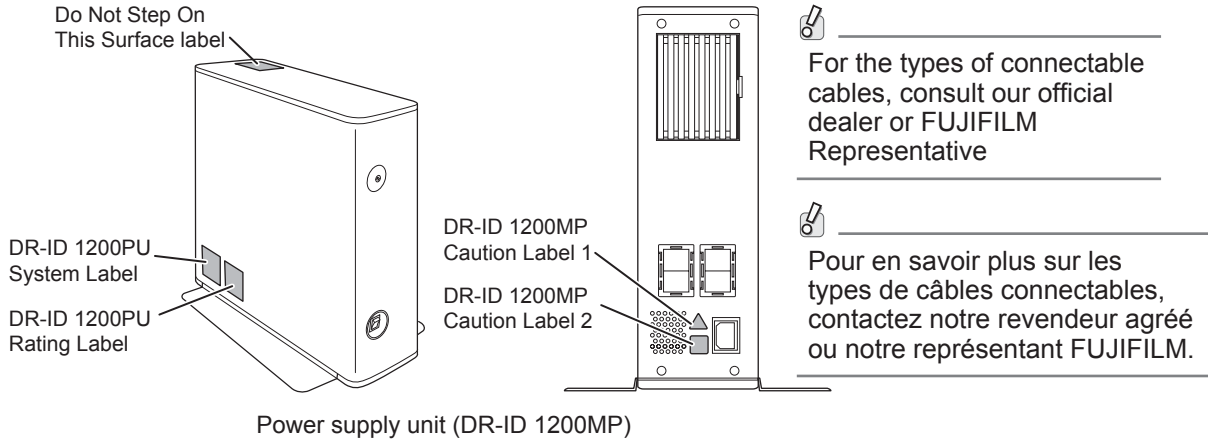

For the types of connectable cables, consult our official dealer or FUJIFILM Representative

Pour en savoir plus sur les types de câbles connectables, contactez notre revendeur agréé ou notre représentant FUJIFILM.

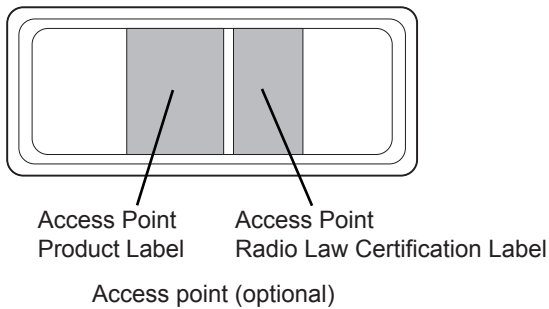
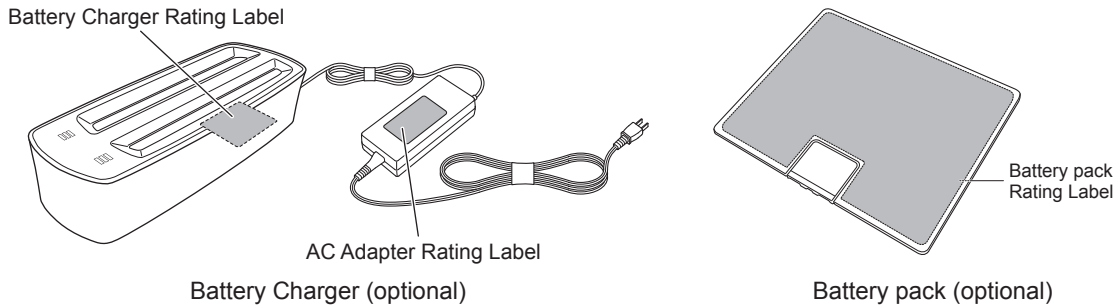

For details on the locations of labels for the image processing unit, see the "Console Advance (DR-ID 300CL) Operation Manual".

1.6.2 DR-ID 1200

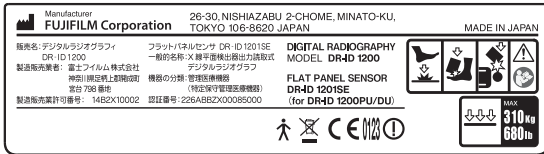

DR-ID 1201SE Identification Label

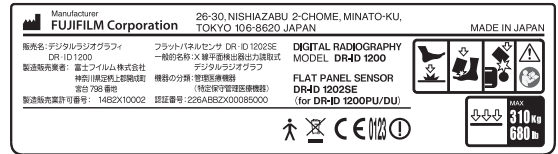

DR-ID 1202SE Identification Label

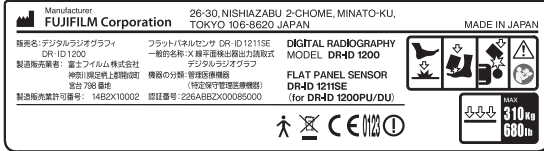

DR-ID 1211SE Identification Label

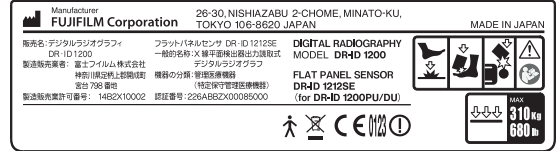

DR-ID 1212SE Identification Label

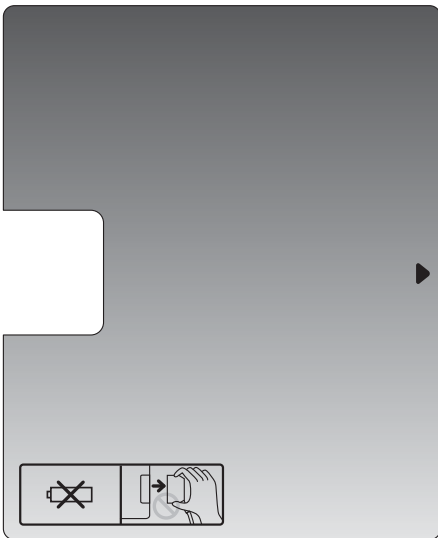

Battery Cover Label

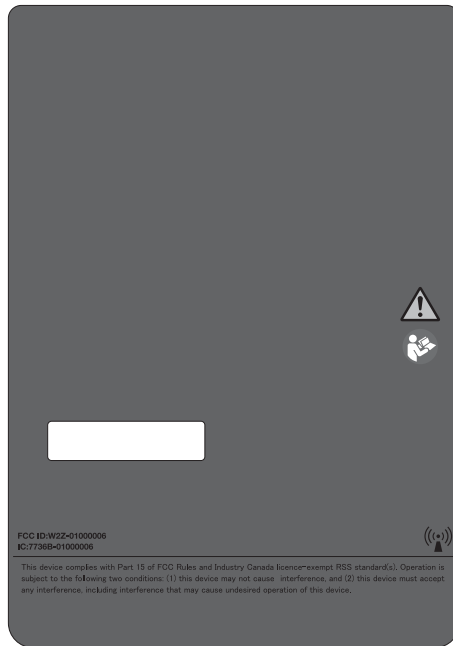

DR-ID 1201SE/DR-ID 1202SE/
 DR-ID 1211SE/DR-ID 1212SE
 Radio Law Certification Label

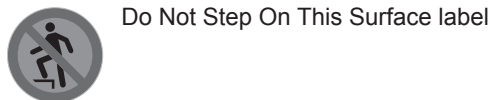

Serial Number Label

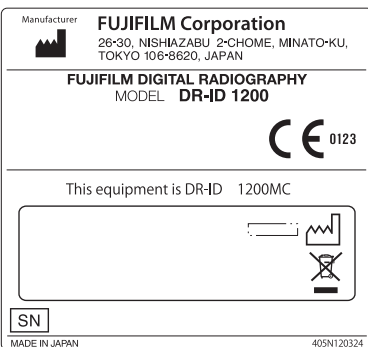

DR-ID 1200MC Identification Label

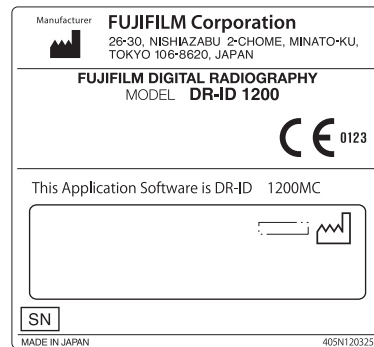

DR-ID 1200MC Identification Label
 (for the system without the DR-ID 1200MC)

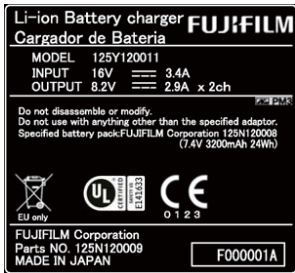

Battery Charger Rating Label



AC Adapter (Battery Charger) Rating Label



Battery Pack Rating Label

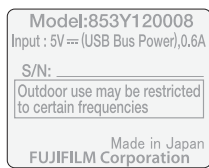

Access Point Product Label (for Europe)

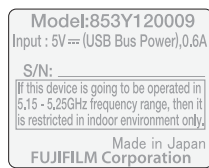

Access Point Product Label (for North America)



Access Point Radio Law Certification Label



For details on the labels of the image processing unit, see the “Console Advance (DR-ID 300CL) Operation Manual”.

1.6.3 DR-ID 1200PU

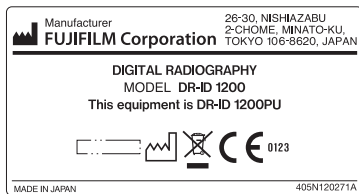

DR-ID 1200PU System Label

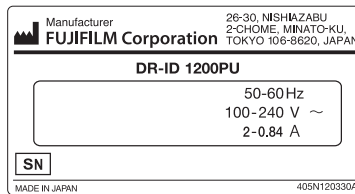

DR-ID 1200PU Rating Label



DR-ID 1200MP Caution Label 1



DR-ID 1200MP Caution Label 2

1.6.4 DR-ID 1200DU

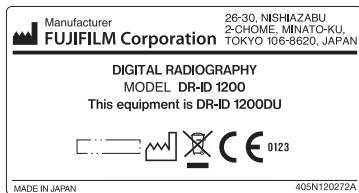

DR-ID 1200DU System Label

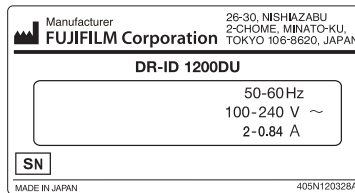

DR-ID 1200DU Rating Label





















DR-ID 1200DS Caution Label 1



DR-ID 1200DS Caution Label 2

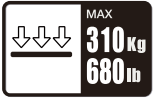

















1.6.4 Safety and Other Symbols

The following safety symbols are used in the labels or on its body.

Symbol	Description
	This symbol indicates compliance of the equipment with Directive 93/42/EEC.
	This symbol indicates compliance of the equipment with Directive 93/42/EEC. This symbol indicates that the equipment is classified as Class 2 equipment in the R&TTE Directive.
	Caution (See "1.6.1 Locations of Labels" (page 1-24).)
	OFF (To indicate disconnection from the mains, at least for mains switches or their positions, and all those cases where safety is involved.)
	ON (To indicate connection to the mains, at least for mains switches or their positions, and all those cases where safety is involved.)
	Protective earth (ground)
	Alternating current
	This symbol indicates that the equipment is a Type B Applied Part.
	Ready (To indicate the machine is ready for operation.)
	Electric energy
	General mandatory action sign
	This symbol indicates that this product is not to be disposed of with your household waste, according to the WEEE Directive (2002/96/EC) and your national law. This product should be handed over to a designated collection point. Improper handling of this type of waste could have a possible negative impact on the environment and human health due to potentially hazardous substances that are generally associated with EEE. At the same time, your cooperation in the correct disposal of this product will contribute to the effective usage of natural resources. For more information about waste, please contact our official dealer or FUJIFILM Representative.
	Year of manufacture
	Environmentally Friendly Use Period (EFUP)
	Caution for local load (See "1.5.3 During Exposure" (page 1-19).) / Do not drop the flat panel sensor to the user/patient
	Entire surface load
	This symbol includes RF transmitters or indicates equipment that intentionally applies RF electromagnetic energy for diagnosis or treatment.
	Refer to Instruction Manual/Booklet
	No stepping on surface

1.6.5 Symboles de sécurité et autres

Les symboles de sécurité suivants sont utilisés sur les étiquettes ou sur le corps de l'équipement.

Symbole	Description
	Ce symbole indique la conformité de l'équipement à la directive 93/42/CEE.
	Ce symbole indique la conformité de l'équipement à la directive 93/42/CEE. Ce symbole indique que l'équipement appartient à la catégorie 2 de la classification de la directive R&TTE.
	Attention (Voir « 1.6.1 Emplacement des étiquettes » (page 1-24).)
	HORS TENSION (Pour indiquer une déconnexion de l'alimentation secteur, au moins au niveau des interrupteurs secteurs ou leur position, et tous les cas dans lesquels la sécurité est en jeu.)
	SOUS TENSION (Pour indiquer une connexion à l'alimentation secteur, au moins au niveau des interrupteurs secteurs ou leur position, et tous les cas dans lesquels la sécurité est en jeu.)
	Protection via mise à la terre (masse)
	Courant alternatif
	Ce symbole indique que l'équipement est une pièce appliquée de type B.
	Prêt (Pour indiquer que la machine est prête à être utilisée.)
	Énergie électrique
	Symbole général d'action obligatoire
	Ce symbole indique que ce produit ne doit pas être mis au rebut avec les déchets ménagers, conformément à la directive DEEE (2002/96/CE) et à la législation nationale en vigueur. Ce produit doit être remis à un centre de collecte approprié. Une manipulation incorrecte de ce type de déchet peut avoir un impact négatif sur l'environnement et sur la santé humaine, en raison des substances potentiellement dangereuses généralement associées aux EEE. Votre coopération pour la mise au rebut correcte de ce produit contribuera en outre à une utilisation efficace des ressources naturelles. Pour en savoir plus sur les déchets, contactez notre revendeur agréé ou notre représentant FUJIFILM.
	Année de fabrication
	
	Attention relative à une charge placée de façon localisée / Ne faites pas tomber le détecteur à panneau plat sur l'utilisateur/le patient
	Charge sur l'intégralité de la surface
	Ce symbole inclut les émetteurs RF ou indique un équipement émettant intentionnellement de l'énergie électromagnétique RF à des fins de diagnostic ou de traitement.
	Consultez le mode d'emploi
	Ne montez pas sur la surface

1.7 Installation Conditions

1.7.1 Definition of Patient Environment

For the products that can be installed in patient environment, see “2.1.1 System Configuration” (page 2-1).



CAUTIONS

In the X-ray room, do not install the power supply unit, control cabinet, docking stand, access point, image processing unit and battery charger (optional) in areas where the user could easily trip over them. Falls could result in injury.

■ Bed in a patient room or bed-type radiographic examination stand

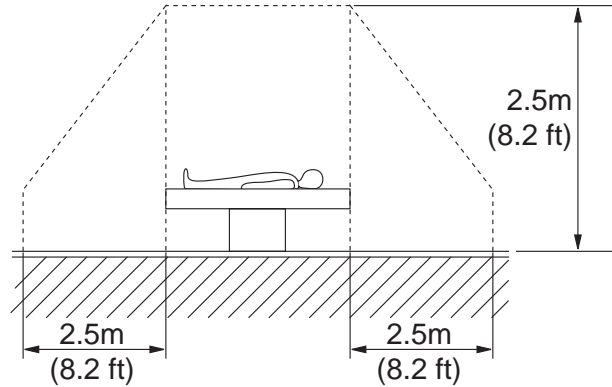
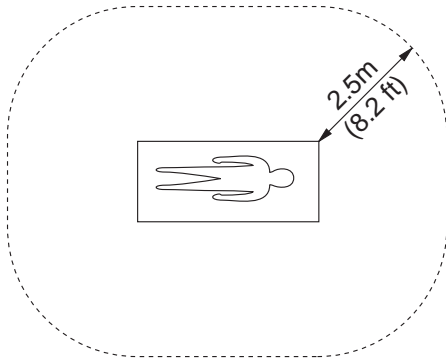

■ Upright-type radiographic examination stand

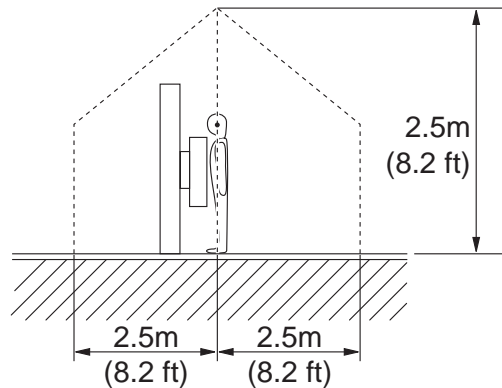
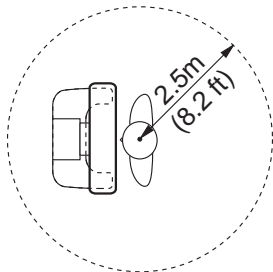

1.7.2 Installation Precautions

■ Using in an open space

Install the flat panel sensor, the access point and the image processing unit at a distance of less than 10m (32.8 ft) from each other. If any distance is over 10m (32.8 ft), a wireless communication error may occur.

■ Using in an X-ray room

The access point should be installed in the X-ray room.

If the access point is not installed properly, wireless communication may become unstable. If this happens, the messages below may appear.

These messages are only examples.

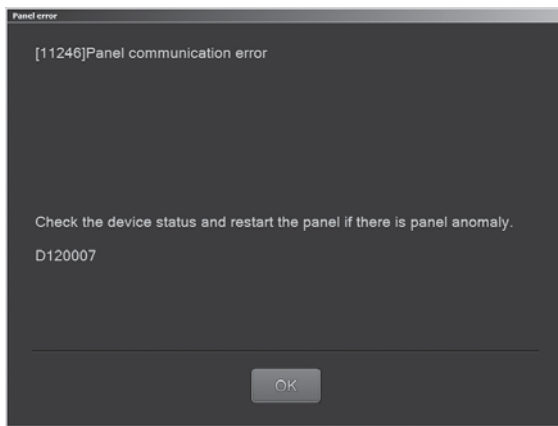

Example 1
Panel communication error

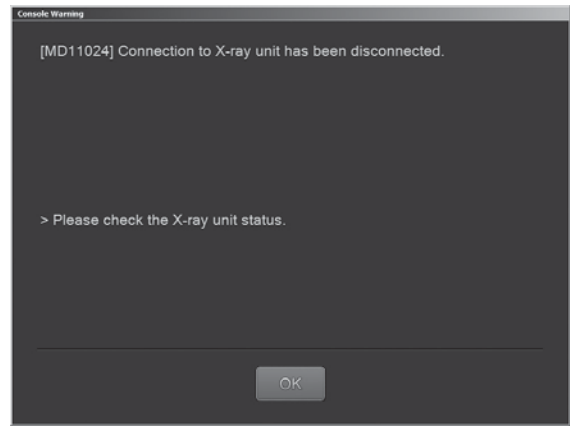

Example 2
Connection to X-ray unit has been disconnected.

1.7.3 Precautions for Installing the Access Point (Optional)

Install the optional access point in a place where the operation is not hindered.

When the access point is installed onto a personal computer, be sure that the label attached on the access point does not face the front side.

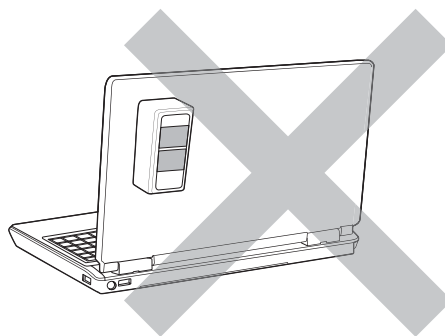

In addition, install the access point in an appropriate place to prevent it from colliding with a moving mobile X-ray unit. If any impact is applied to the optional access point, it may be damaged.



For Safe Operation

Chapter 2 System Configuration (Product Overview)

2.1 FDR D-EVO II

2.1.1 System Configuration

(When the optional access point is used)

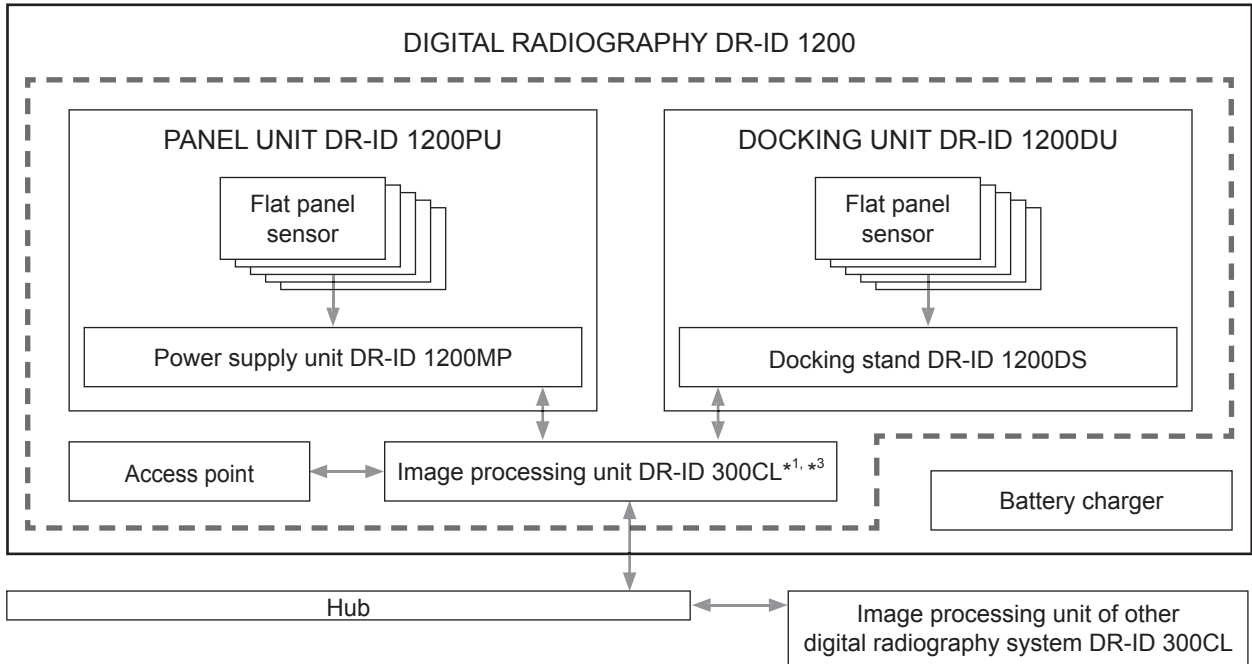

(When an access point installed in the hospital is used)

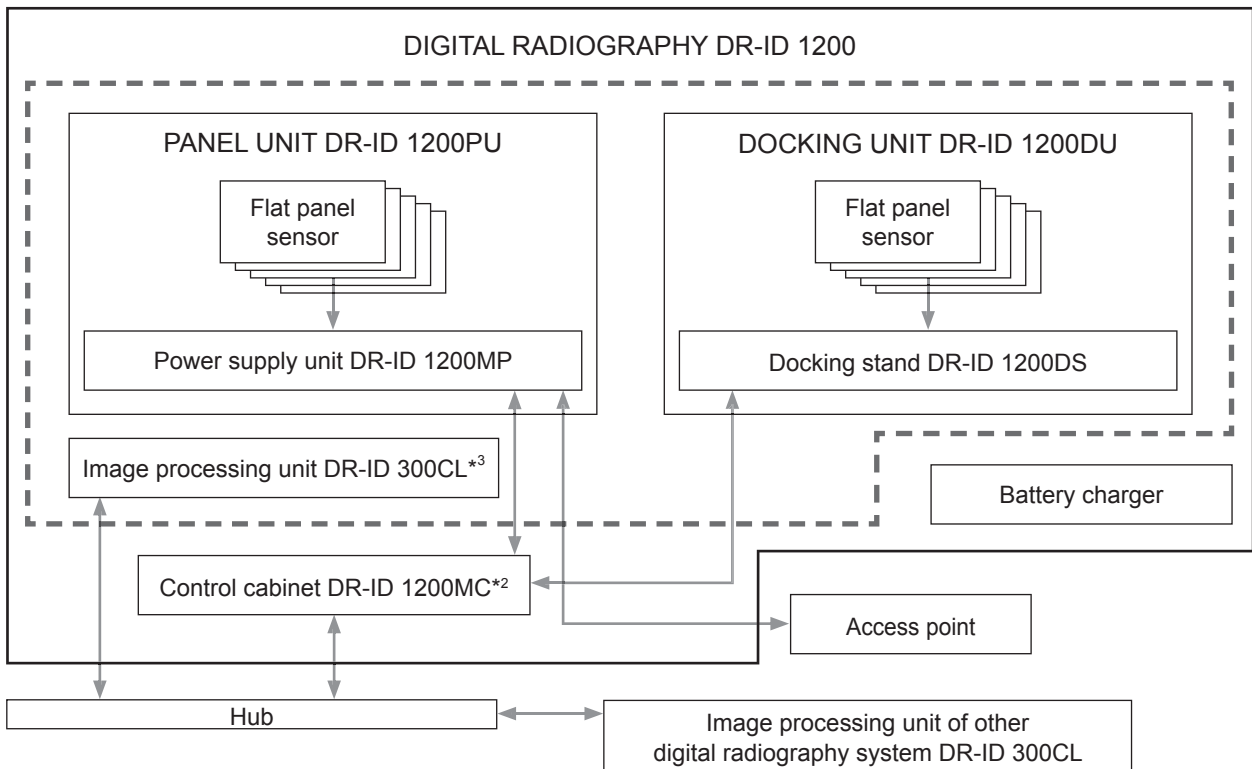

- The products in  can be installed in patient environment. However, the image processing unit cannot be installed while it is being charged.
 - The FDR D-EVO II consists of the panel unit DR-ID 1200PU or docking unit DR-ID 1200DU, the control cabinet DR-ID 1200MC and the image processing unit.
 - The panel unit DR-ID 1200PU consists of the flat panel sensor DR-ID 1201SE, DR-ID 1202SE, DR-ID 1211SE and DR-ID 1212SE, and the power supply unit DR-ID 1200MP.
 - The panel unit DR-ID 1200PU can be operated in conjunction with the X-ray equipment, and it can be used for exposures in wired mode.
 - The docking unit DR-ID 1200DU consists of the flat panel sensor DR-ID 1201SE, DR-ID 1202SE, DR-ID 1211SE and DR-ID 1212SE, and the docking stand DR-ID 1200DS.
 - With the docking unit DR-ID 1200DU, the exposure ready status can be displayed with the lamp on the docking stand. In addition, the flat panel sensor to be used for exposure can be identified with the lamp indication on the docking stand.
 - The image processing unit DR-ID 300CL is configured by installing image processing software on a commercially available personal computer conforming to IEC 60950-1 or equivalent.
 - Up to five flat panel sensors can be connected.
 - When the DR-ID 1200PU is used, up to two flat panel sensors can be connected to one power supply unit in wired communication mode. Up to two power supply unit can be used. When the flat panel sensors are used with three to four different techniques, two power supply units are required.
 - When the DR-ID 1200DU is used, only one flat panel sensors can be connected to one docking stand in wired communication mode. Up to three docking stand can be used.
 - When the DR-ID 1200DU and a mobile X-ray unit are used, power to the access point is supplied by connecting it to the image processing unit DR-ID 300CL.
- *1 The software for the control cabinet is installed on the image processing unit (DR-ID 300CL).
- *2 Depending on the configuration, the control cabinet (DR-ID 1200MC) may not be included in the system. If not included, the software for the control cabinet can be installed on the image processing unit (DR-ID 300CL).
For detail specification of image processing unit, please refer to “DR-ID 300CL Operation Manual”.
- *3 When the image processing unit (DR-ID 300CL) is used in patient environment, run the notebook computer on battery power.

2.1.2 Features of the FDR D-EVO II

This section describes the main features of the FDR D-EVO II.

- 1 Light-weight, thin and roundish design of the flat panel sensor facilitates lifting and enhances operability, for example, when it is set under a patient lying on a bed.
- 2 By utilizing FUJIFILM's proprietary ISS (Irradiation Side Sampling) method, vapor deposition technique of CsI scintillator, particle blend technique of GOS scintillator, and also noise reduction IC, images with high sensitivity and high sharpness are obtained even in low-density areas.
- 3 After an X-ray irradiation process is completed, the exposed image appears on the monitor of the image processing unit in about one second at the shortest. In addition, since images are compressed with our unique compression technology (CIP) during communication, exposures can be made efficiently at short intervals.
- 4 The flat panel sensor has sleep mode and extra sleep mode. This power-saving design almost eliminates the need of replacing the battery pack. In addition, since a removable battery pack is adopted, it can be replaced even if the battery runs down.
- 5 The docking stand and the optional battery charger assist smooth exposure operations. The system can be used even in an emergency since only 3 minutes of charge time are required to make about 30 exposures.
- 6 Up to 100 images can be stored temporarily in the memory of the flat panel sensor. The memory exposure mode can be activated easily by operating the button on the back of the flat panel sensor. Even if the image processing unit is not available, exposures can be made only by using the flat panel sensor.
- 7 Extended Image Readout enables a long exposure for up to ten seconds.
- 8 The flat panel sensor can be used cleanly since all surfaces have been coated with an antibacterial agent.
- 9 Since the external dimensions and thickness of the flat panel sensor are the same as those of existing cassette for general exposure (compliant with ISO 4090), the flat panel sensor can be loaded onto the exposure stand that has been used. In addition, since operation on battery power and wireless communication are available, one flat panel sensor can be used for multiple devices such as upright type and supine-position type radiography devices.
- 10 The flat panel sensor has the X-ray automatic detection function (SmartSwitch).
With this function, the flat panel sensor detects even a small amount of X-ray precisely to start an exposure without connecting it to the X-ray device.
- 11 By using a notebook computer as the image processing unit, and also by using the optional access point, the need of carrying cables is eliminated and the system can be used for rounds.
In addition, exposures can also be made outdoors depending on the frequency band of radio wave.
- 12 Up to 100 flat panel sensors can be registered. Among the registered flat panel sensors, up to five flat panel sensors can be used.
- 13 On each side of the flat panel sensor, there is an LED showing the center position. The color of this LED can be selected from among five colors (orange, purple, lime yellow, blue and pink). When multiple flat panel sensors are used, they can be identified with the color of the LED.
In addition, the battery pack level can always be checked with the indicator LED on the back of the flat panel sensor.
- 14 Since the flat panel sensor can be shared with multiple systems, the number of flat panel sensors can be optimized.

2.2 Unit Names and the Functions

Unit names and the functions of the FDR D-EVO II are described below.

2.2.1 DR-ID 1200

■ DR-ID 1200PU

* Exposure plane is shown in this figure.

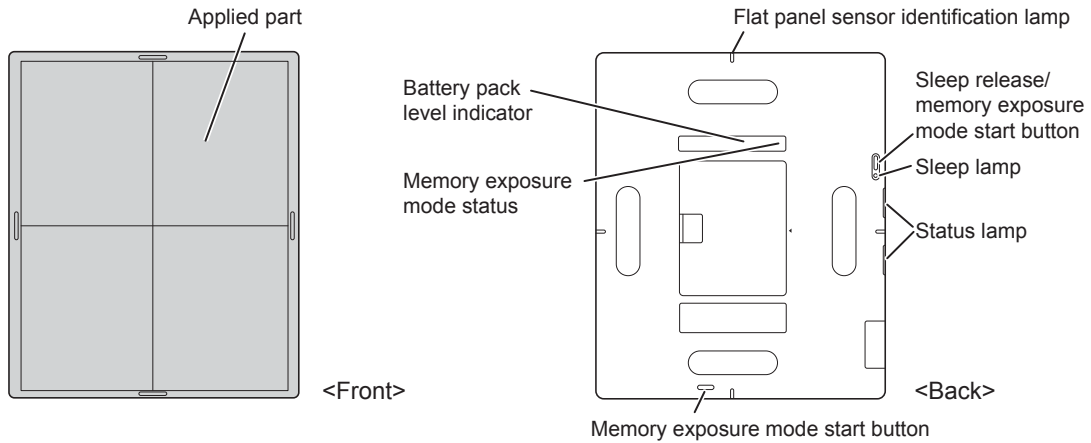

Flat panel sensor (DR-ID 1201SE, DR-ID 1202SE, DR-ID 1211SE and DR-ID 1212SE)

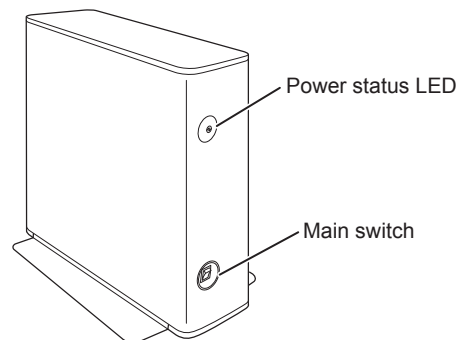

Power supply unit (DR-ID 1200MP)

Name	Description					
Flat panel sensor	The DR-ID 1201SE and DR-ID 1202SE incorporate a GOS indirect panel. The DR-ID 1211SE and DR-ID 1212SE incorporate a CsI indirect panel.					
Flat panel sensor identification lamp	The flat panel sensor currently in use is identified by the color of this lamp. The color of this lamp is selected from among lime yellow, blue, purple, orange and pink at the time of installation. If the color is not specified, this lamp is lit in white. This lamp on the flat panel sensor currently in use is lit in the same color as the panel icon selected on the display of the image processing unit.					
Sleep lamp	This LED shows the sleep status. <table border="1" style="width: 100%; margin-top: 10px;"> <tr> <td rowspan="2" style="text-align: center; vertical-align: middle;"> (Blue)</td> <td style="text-align: center;">Off</td> <td style="text-align: center;">Sleep off or Sleep state</td> </tr> <tr> <td style="text-align: center;">On</td> <td style="text-align: center;">Extra sleep state</td> </tr> </table> <p>* When the flat panel sensor is not operated for 2 minutes, it is placed in the sleep mode. Extra sleep mode, which can further save power, can also be set. To specify or change the setting of sleep mode or extra sleep mode, contact a FUJIFILM dealer.</p>	(Blue)	Off	Sleep off or Sleep state	On	Extra sleep state
(Blue)	Off		Sleep off or Sleep state			
	On	Extra sleep state				
Sleep release/memory exposure mode start button	Releases the extra sleep mode.					
Memory exposure mode start button	When this button is held pressed for 2 seconds while pressing the sleep release/memory exposure mode start button, the memory exposure mode starts up. The memory exposure mode can be started up when no exposure menu is registered and calibration is not being performed.					



Battery pack level indicator

Memory exposure mode status

In the memory exposure mode, the number of exposed images or an error during the start-up of memory exposure mode is displayed.

Name	Description																						
Status lamp	Indicates the equipment status by LEDs. <table border="1" style="width: 100%; margin-top: 10px;"> <tr> <td rowspan="3" style="text-align: center; vertical-align: middle;">READY (Green)</td> <td style="text-align: center;">On</td> <td style="text-align: center;">Exposure possible</td> </tr> <tr> <td style="text-align: center;">Blinks for 1.0 second</td> <td style="text-align: center;">During exposure sequence</td> </tr> <tr> <td style="text-align: center;">Off</td> <td style="text-align: center;">Not ready</td> </tr> <tr> <td rowspan="2" style="text-align: center; vertical-align: middle;">POWER (Blue) (The power on/off state of the flat panel sensor is displayed.)</td> <td style="text-align: center;">On</td> <td style="text-align: center;">Power ON</td> </tr> <tr> <td style="text-align: center;">Off</td> <td style="text-align: center;">Power OFF</td> </tr> <tr> <td rowspan="2" style="text-align: center; vertical-align: middle;">ERROR (Orange)</td> <td style="text-align: center;">Blinks for 1.0 second</td> <td style="text-align: center;">Error occurred</td> </tr> <tr> <td style="text-align: center;">Off</td> <td style="text-align: center;">Normal</td> </tr> <tr> <td rowspan="2" style="text-align: center; vertical-align: middle;">LINK (White)</td> <td style="text-align: center;">On</td> <td style="text-align: center;">Connected</td> </tr> <tr> <td style="text-align: center;">Off</td> <td style="text-align: center;">Communication not possible.</td> </tr> </table> <p>* When the battery pack is not attached, all LEDs are off.</p>	READY (Green)	On	Exposure possible	Blinks for 1.0 second	During exposure sequence	Off	Not ready	POWER (Blue) (The power on/off state of the flat panel sensor is displayed.)	On	Power ON	Off	Power OFF	ERROR (Orange)	Blinks for 1.0 second	Error occurred	Off	Normal	LINK (White)	On	Connected	Off	Communication not possible.
READY (Green)	On		Exposure possible																				
	Blinks for 1.0 second		During exposure sequence																				
	Off	Not ready																					
POWER (Blue) (The power on/off state of the flat panel sensor is displayed.)	On	Power ON																					
	Off	Power OFF																					
ERROR (Orange)	Blinks for 1.0 second	Error occurred																					
	Off	Normal																					
LINK (White)	On	Connected																					
	Off	Communication not possible.																					
Power supply unit (DR-ID 1200MP)	A device supplying power to the flat panel sensor and connecting between the flat panel sensor, image processing unit and control cabinet.																						
Main switch	Supplies the power to the flat panel sensor and the inside of the power supply unit.																						
Power status LED	Displays ON/OFF of the power supply unit.																						

HINT

For details on the flat panel sensor identification lamp and battery pack level indicator, see “3.1.9 Lamp Indications on the Flat Panel Sensor”.

■ DR-ID 1200DU

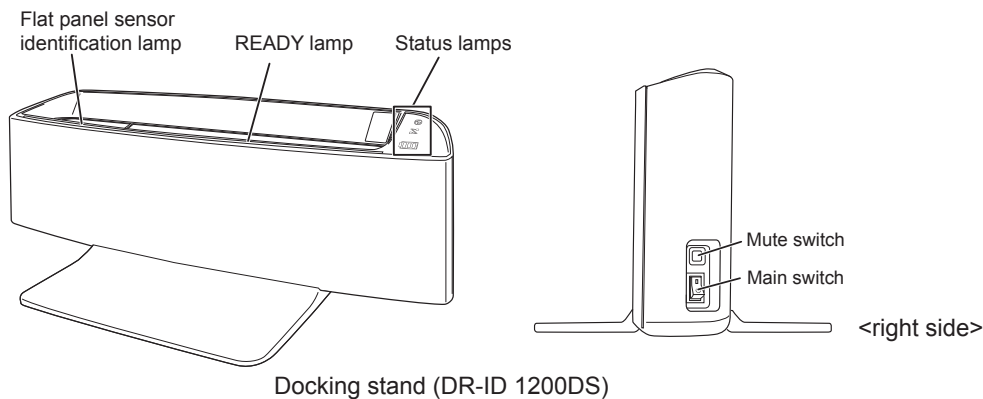

Name	Description							
Docking stand (DR-ID 1200DS)	Supplies the power to the flat panel sensor and connects the flat panel sensor and the image processing unit.							
Main switch	Supplies the power to the docking stand and the flat panel sensor							
Status lamps	<p>POWER (Blue) (The power on/off state of the docking stand is displayed.)</p> <p>LINK (White)</p>	<table border="0"> <tr> <td style="text-align: center;">On</td> <td>Power ON</td> </tr> <tr> <td style="text-align: center;">Off</td> <td>Power OFF</td> </tr> <tr> <td style="text-align: center;">On</td> <td>Connected (This lamp is lit when communication with the control cabinet is established after inserting the flat panel sensor.)</td> </tr> </table>	On	Power ON	Off	Power OFF	On	Connected (This lamp is lit when communication with the control cabinet is established after inserting the flat panel sensor.)
On	Power ON							
Off	Power OFF							
On	Connected (This lamp is lit when communication with the control cabinet is established after inserting the flat panel sensor.)							
 Battery pack level indicator	<p>Battery pack level indicator </p>	Indicates the charge level of the battery pack for the flat panel sensor in yellowish green. Lights in orange when an error occurs.						
Mute switch	This switch is used to mute the buzzer that sounds when an exposure is ready, a flat panel sensor is inserted or the battery pack of a flat panel sensor is fully charged.							
Flat panel sensor identification lamp	This lamp is lit in the same color as the flat panel sensor identification lamp on the flat panel sensor currently in use.							
READY lamp (Green)	This lamp is lit when the flat panel sensor currently in use is ready for exposure.							



- Note that the flat panel sensor inserted into the docking stand can only be charged or used for communication. It cannot be used for exposures.
- If the battery pack level indicator of the docking stand lights in orange, press the main switch to turn it off and press the switch again to turn the power back on.

■ DR-ID 1200MC

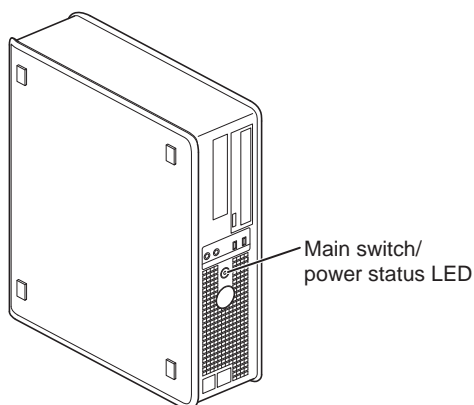

Control cabinet (DR-ID 1200MC)

Name	Description
Control cabinet (DR-ID 1200MC)	A personal computer used for controlling the flat panel sensor and performing image processing.
Main switch	Supplies the power to the control cabinet.
Power status LED	Displays ON/OFF of the control cabinet.



Depending on the configuration, the control cabinet (DR-ID 1200MC) may not be included in the system. If not included, the software for the control cabinet can be installed on the image processing unit (DR-ID 300CL). For detail specification of image processing unit, please refer to "DR-ID 300CL Operation Manual".

■ SE cable

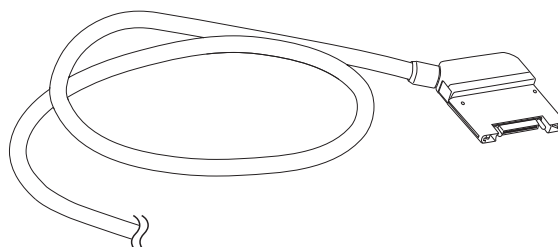

Name	Description
SE cable	A cable that connects the flat panel sensor and the power supply unit. This cable is used for adding the second and subsequent flat panel sensors, changing over the connection between the flat panel sensors, and other usages. Cable length: Approx. 10m (32.8 ft), Approx. 20m (65.6 ft)

■ SE communication cable

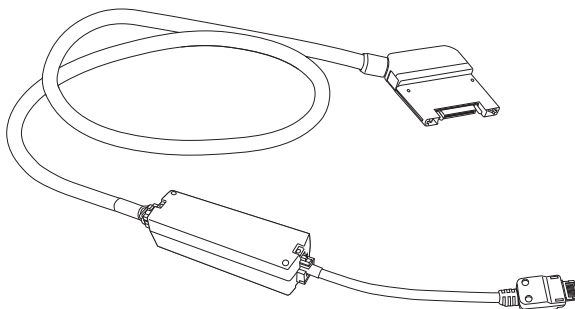

Name	Description
SE communication cable	<p>A cable used for connecting the flat panel sensor and the optional access point. This cable is used for wired communication if wireless communication is not available.</p> <p>In addition, this cable is used for registering or recognizing the flat panel sensor. Cable length: Approx. 1m (3.3 ft)</p>

■ Battery charger (Optional)

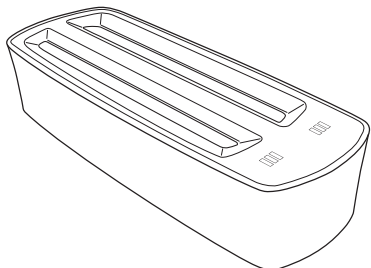

Battery charger

Name	Description
Battery charger	Charges the battery pack for the flat panel sensor. Two packs can be charged at the same time.
Charge status indicator LED	Indicates charge status.

■ Image processing unit

- ▶ For the unit names and functions of the image processing unit, see the “DR-ID 300CL Operation Manual”.

2.3 Image Processing Unit Display Configuration

When the self-initialization process ends, the Patient Information Input Screen will appear on the image processing unit display.

▶ For details, see "DR-ID 300CL Operation Manual".

■ Patient Information Input Screen

Patient information input field
Input patient information.

Tool button

Operates the Patient Information Database function to input patient information.

Clear
Clears patient information (except for technologist).

Screen keyboard
Used to input characters in the patient information input field.

Reserves a study.

Terminates patient information input, and proceeds to exposure menu selection.

Displays the "Study List screen".

Connected devices status
Connected devices status display field. Displays the status of connected devices. For details, see the next page.

■ Study Screen

Patient information display field
Displays patient information.

Exposure menu list
This list shows exposure menus selected on the "Exposure Menu Selection screen".

Selected exposure menu number display field

Exposure unit display field
The Tube, Technique, and Imaging panels can be uniquely arranged and displayed.

Technologist display field
Displays the name of logged-in technologist (user).

Image display field
The read image appears.

Shot Ready (exposure ready status indicator)
Exposure (image reading) can be performed when the indicator is lit green. Exposure (image reading) cannot be performed when the indicator is not lit.

■ Connected Devices Status

Details on each icon and its display area are described below.

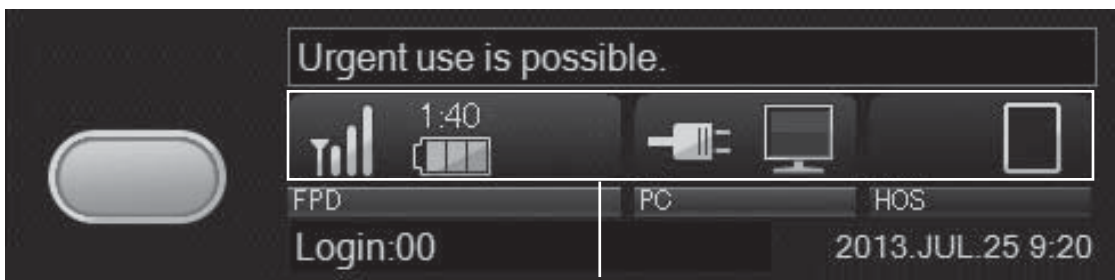

Other indicator icons display area

Other indicator icons display area

The status of the flat panel sensor, power supply unit, docking stand and image processing unit is shown with an icon. Up to six icons can be displayed. The status of each connected device is shown in three categories.

Device information displayed in each category is as follows.

Category	Device information
Status of exposure unit	(1) Exposure unit communication indicator (2) Exposure unit battery indicator
Status of the image processing unit and personal computer	(3) Console event indicator (4) Console battery indicator
Other (Status of output unit, hospital LAN, etc.)	(5) Output status indicator (6) Hospital wireless communication indicator

The information is displayed in each category as shown below.

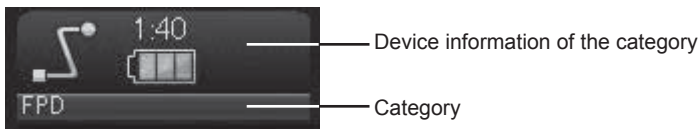

Locations of category information can be customized in the user utility. For details, see “DR-ID 300CL Reference Guide”.

(1) Exposure Unit Communication Indicator

The following icons display communication status of the flat panel sensor corresponding to the selector selected in the exposure unit display field of the “Study screen”.

If the flat panel sensor is connected with wired communication, the following icons are displayed.

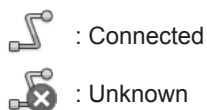

If the flat panel sensor is connected wirelessly, the following icons are displayed.

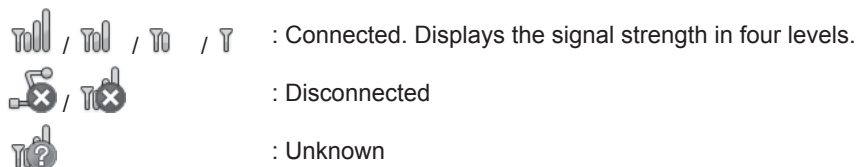

CAUTIONS

While  is displayed, radiography is not recommended since wireless communication is unstable.

(2) Exposure Unit Battery Indicator

When the exposure unit is connected to the image processing unit, the battery status is indicated with the following icons.

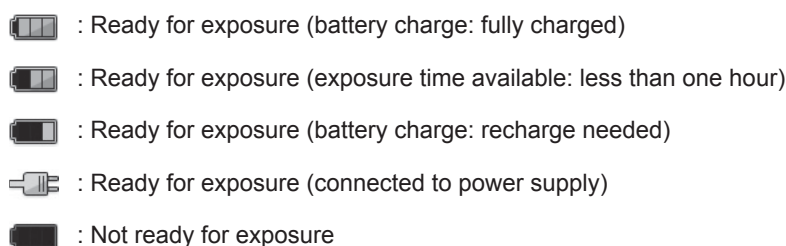

CAUTIONS

When an exposure is ready to be made (the READY status lamp on the flat panel sensor is lit green), the power consumption of the flat panel sensor increases. Although the indicator icon of the remaining battery level changes to low and the value of the operable time display decreases temporarily, these are not failures.



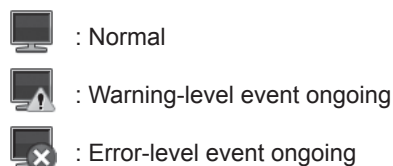

(3) Console Event Indicator

The following icons display the status of the image processing unit.





(4) Console Battery Indicator

The status of the PC battery and of PC connection to the AC adapter are shown by the icons below.

-  : Ready for use
-  : Ready for use
-  : Ready for use (battery charge: recharge needed)
-  : Ready for use (charging or the AC adapter connected)
-  : Not ready for use



(5) Output Status Indicator

The following icons display the output status.

-  : Waiting for image output
-  : Processing image output
-  : Output error

(6) Hospital Wireless Communication Indicator

The status of wireless communication between the image processing unit and the hospital LAN is shown by the icons below.

-  : Connected. Radio field strength is displayed in four levels.
-  : Switching connection
-  : Disconnected

CAUTIONS

While  is displayed, image transfer to the hospital LAN becomes unstable although wireless communication is established.

2.4 Routine Operation Diagram

The system configuration and the routine operation diagram for the FDR D-EVO II is as follows.

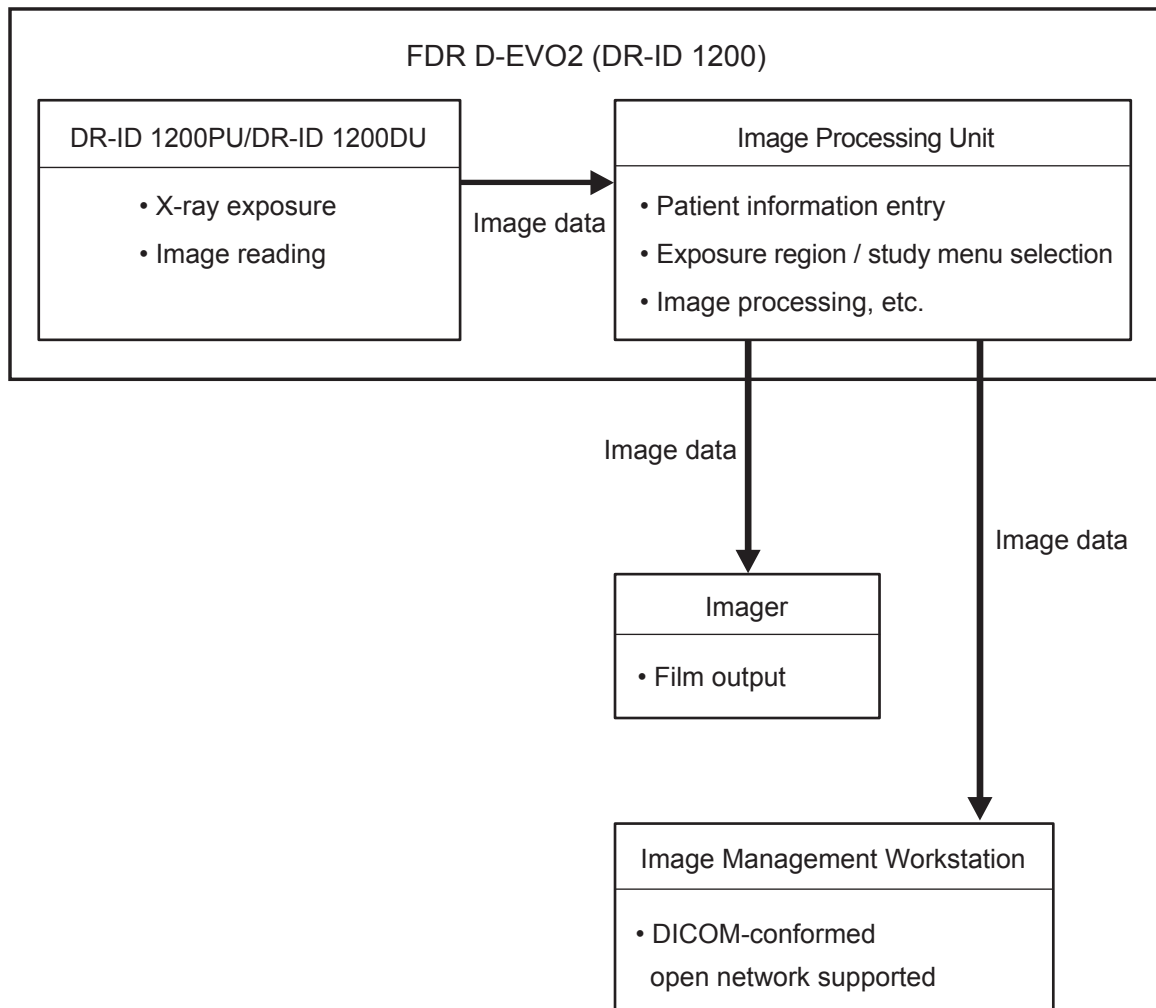

2.5 Wireless Specifications

- 1 Technical Specification : IEEE802.11n (protocol) , 2.4GHz, W52, W53, W56, W58 (frequency)
- 2 Intended environment : Room size of 10m x 10m x 3m (32.8 ft x 32.8 ft x 9.8 ft) (height) or less (general X-ray room)
(The electric shield does not exist excluding the installation stand or bed.)
- 3 Installation : Do not place devices generating electromagnetic wave (CT,MRI, diathermy, RFID etc.) near this equipment.
We recommend not to use any other wireless devices such as cellular/smart phones, portable phones, microwave ovens, WAPs, etc. within 2m (6.6 ft) of the wireless FDR D-EVO II system.
When other wireless devices are used within 2m (6.6 ft), wireless data communication may be delayed.
(Data will not be lost; if a timeout occurs a retry can be performed after the cause of interference has been removed)
Do not cover the Flat Panel Sensor (DR-ID 1201SE/DR-ID 1202SE/DR-ID 1211SE/DR-ID 1212SE) with a shield such as a metallic plate as this will interfere with a wireless communication.
- 4 Information being transmitted : System Control Signal, (Img_req_CMD, etc.)
Image Data of the Flat Panel Sensor
Note: Patient Information is not transmitted by wireless interface of Access point
- 5 Wireless range : max. 10m (32.8 ft) from the Access point as tested. Actual range may vary.
- 6 Data transfer rate : 35Mbps (DR-ID1200 : between the Flat Panel Sensor and Console PC)
(This value is FUJIFILM measuring result of wireless module, and actual data rate may vary.)
- 7 Transfer Power : 17 dBm or less
- 8 Modulation : OFDM (Provided by IEEE802.11n)
- 9 Wireless Data Security : Wireless FDR D-EVO II system (DR-ID 1201SE/DR-ID 1202SE/DR-ID 1211SE/DR-ID 1212SE) will be utilizing the IEEE 802.11n.
The Wireless Access Point (WAP) has a feature that limits the maximum number of the Flat Panel Sensor per access point to ensure data integrity. Further the WAP has MAC Address Filtering (unique IP address) and Wireless LAN Segmentation to ensure handshaking with only the registered wireless FDR D-EVO II Flat Panel Sensors (DR-ID 1201SE/DR-ID 1202SE/DR-ID 1211SE/DR-ID 1212SE).
In addition to the MAC address filtering, the wireless communication between DR-ID 1201SE/DR-ID 1202SE/DR-ID 1211SE/DR-ID 1212SE (Flat Panel Sensor) and access point is secured by WPA2-PSK encryption with AES (Advanced Encryption Standard). Data security feature will be enabled during installation by a FUJIFILM field service engineer. No patient information is transmitted between DR-ID 1201SE/DR-ID 1202SE/DR-ID 1211SE/DR-ID 1212SE (Flat Panel Sensor) and access point., between access point and the console.
- 10 Handshaking/Pairing : The Wireless Access Point and DR-ID 1201SE/DR-ID 1202SE/DR-ID 1211SE/DR-ID 1212SE (Flat Panel Sensor) will be paired during installation by a FUJIFILM field service engineer to ensure one-to-one wireless connection. FUJIFILM field service engineer will measure the wireless transmission condition in the primary area, so the FDR D-EVO II system can be used stable.
- 11 Frequency Tolerance : ± 20 ppm

Quality of Service (QoS)

Item	Standard	DR-ID 1201SE/DR-ID 1202SE/ DR-ID 1211SE/DR-ID 1212SE	Unit	Remarks
Form of electric wave	Spectrum diffusion			
Center frequency	HT20	5180 - 5825 2412 - 2472	MHz	36ch,40ch,44ch,48ch W52
	HT40	5190 - 5795 2422 - 2462	MHz	38ch,46ch W52
Channel interval	IEEE802.11n	20(HT20) / 40(HT40)	-	
Transmission rate	IEEE802.11n	HT20:MCS0-15 HT40:MCS0-15	-	
Modulation	OFDM			
Output power		Power		
	Max	17	dBm	
Frequency Tolerance	- 20 ~ +20		ppm	MAX
Reception sensitivity PER : Packet Error Rate <10%	IEEE 802.11n (5GHz)	MCS0=-89	dBm	HT20
		MCS1=-86	dBm	
		MCS2=-83	dBm	
		MCS0=-86	dBm	HT40
		MCS1=-83	dBm	
		MCS2=-80	dBm	
	IEEE 802.11n (2.4GHz)	MCS0=-88	dBm	HT20
		MCS1=-85	dBm	
		MCS2=-82	dBm	
		MCS0=-85	dBm	HT40
		MCS1=-82	dBm	
		MCS2=-79	dBm	



For details on the wireless specification of the image processing unit, see the “Console Advance (DR-ID 300CL) Operation Manual”.

Chapter 3 Basic Operation

3.1 Preparing the Flat Panel Sensor

This section describes how to prepare the flat panel sensor.

3.1.1 Type of Flat Panel Sensor

DR-ID 1201SE, DR-ID 1202SE, DR-ID 1211SE, DR-ID 1212SE

The battery pack (optional) is required when the flat panel sensor is used in wireless communication mode.

3.1.2 Number of the Connectable Flat Panel Sensors

To enable the flat panel sensor, its ID needs to be registered in advance by our official dealer or FUJIFILM Representative.

Up to a hundred flat panel sensors can be registered.

Up to five flat panel sensors can be connected.

When the DR-ID 1200PU is used, up to two flat panel sensors can be connected to one power supply unit in wired communication mode. Up to two power supply unit can be used.

When the DR-ID 1200DU is used, only one flat panel sensors can be connected to one docking stand in wired communication mode. Up to three docking stand can be used.



Depending on the configuration, the control cabinet (DR-ID 1200MC) may not be included in the system. If not included, the software for the control cabinet can be installed on the image processing unit (DR-ID 300CL). For detail specification of image processing unit, please refer to "DR-ID 300CL Operation Manual".

3.1.3 Connecting/Disconnecting the Flat Panel Sensor Connector

1 Disconnect the connector.

Press the latches on both sides of the connector.

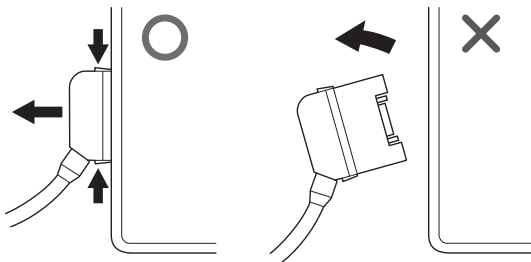

2 Connect the connector.

Press the connector into the insertion section.

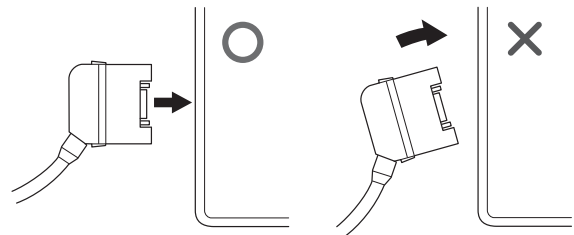

Make sure that the latches on both sides are properly engaged when connecting the connector. If the connector is inserted incompletely, the power may turn off.



When multiple flat panel sensors are used, make sure that the READY lamp among the status lamps of the flat panel sensor to be used for an exposure is lit.



Connect/Disconnect the connector straight to the flat panel sensor. If connected/disconnected at an angle, the connector may be damaged.

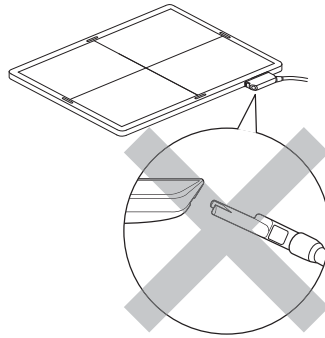

3.1.4 Inserting/Removing the Flat Panel Sensor into/from the Radiographic Examination Stand

Follow the procedure below to insert/remove the flat panel sensor into/from the radiographic examination stand.

▶ For details, see the Operation Manual for the radiographic examination stand.



CAUTIONS

For the positioning at the time of inserting/removing the flat panel sensor, see the Operation Manual for the radiographic examination stand.



CAUTIONS

Make sure that the flat panel sensor is installed in the radiographic examination stand securely.



CAUTIONS

Be careful not to have your fingers caught when inserting/removing the flat panel sensor into/from the radiographic examination stand.



CAUTIONS

When pulling out/pushing in the tray of the radiographic examination stand after setting the flat panel sensor on it, be careful not to drop the flat panel sensor or damage the tray.



CAUTIONS

Before inserting/removing the flat panel sensor into/from the radiographic examination stand, pull out the tray completely. Otherwise, the flat panel sensor may be damaged.

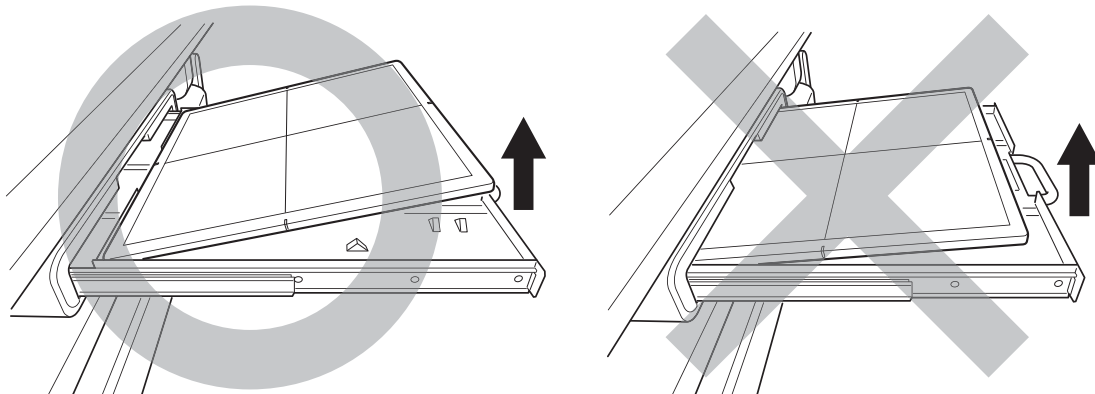

For the effective area of the flat panel sensor, see page A-6.

[1] Upright type

CAUTIONS

When inserting the flat panel sensor into the radiographic examination stand, direct the exposure plane toward the X-ray tube.

1 Pull out the tray.

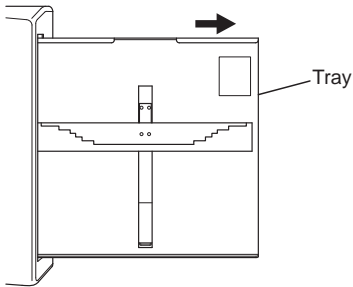

2 Insert the flat panel sensor into the cassette receive with the green mark of the flat panel sensor up, and then move it downwards.

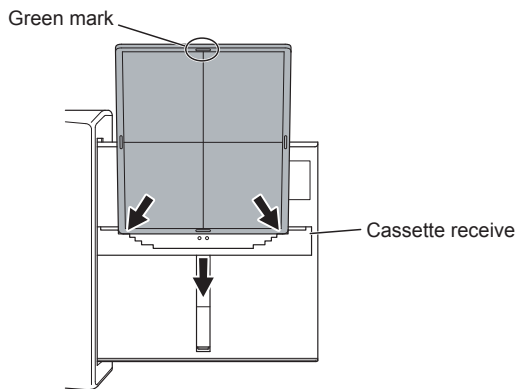

3 Set the flat panel sensor to the upper part of the tray.

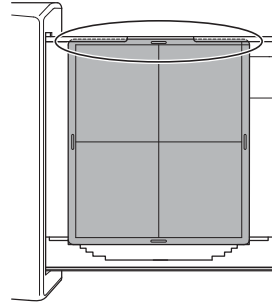

4 Push the tray back into place after setting the flat panel sensor.

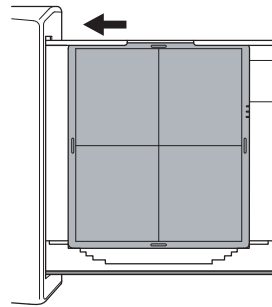

5 Remove the flat panel sensor after use.

Pull out the tray, push the cassette receive downwards, and then remove the flat panel sensor. Push the tray back into place.

[2] Bed type



CAUTIONS

When inserting the flat panel sensor to the radiographic examination stand, direct the exposure plane upwards.

- 1** Pull out the tray by using the handle.

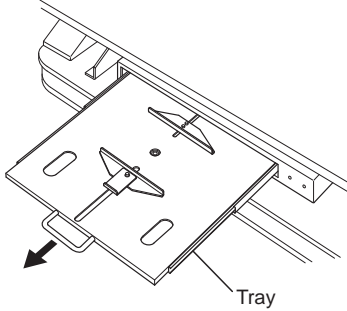

- 2** Pull the cassette stopper, and set the flat panel sensor so that its center mark is aligned with the center of the stopper.

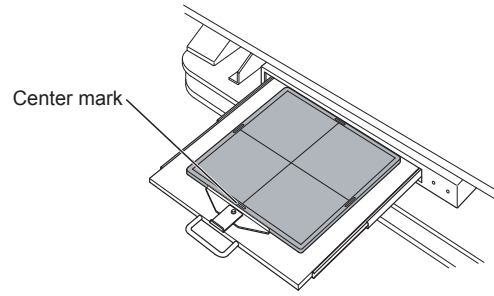
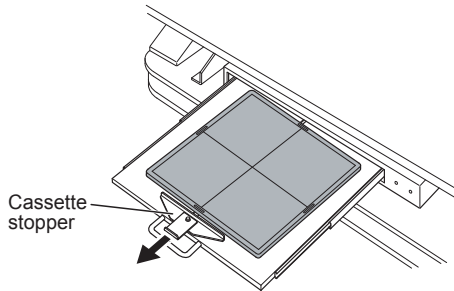

- 3** Push the tray back into place by using the handle after setting the flat panel sensor.

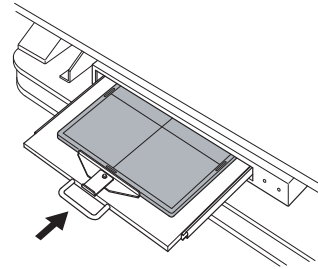

- 4** Remove the flat panel sensor after use.

Hold the handle and pull out the tray. Remove the flat panel sensor while pulling the cassette stopper, and then push the tray back into place.

3.1.5 Changing the Direction of the Flat Panel Sensor Connector

The direction of the connector of the flat panel sensor can be changed, depending on how it is inserted into the radiographic examination stand.

To change the direction, contact our official dealer or FUJIFILM Representative.

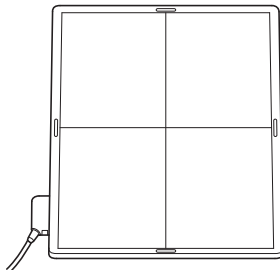

When shipped

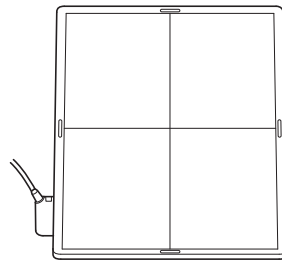

After changing the direction

3.1.6 Charging the Battery Pack for the Flat Panel Sensor

Charge the battery pack (optional) using the battery charger (optional).



CAUTIONS

Do not charge the battery pack other than those designated by FUJIFILM Corporation. If the battery pack is charged under the charging conditions (voltage, current and charging method) different from those specified by FUJIFILM Corporation, the battery pack may emit smoke, ignite, explode or leak fluid.



CAUTIONS

When setting the battery pack into the battery charger, make sure that the orientation of the battery pack is correct as shown in the figure in Step 1. If the battery pack is forcibly set in the wrong orientation, both the battery pack and the battery charger may be damaged and emit smoke, ignite, leak fluid or cause electric shock.



When the battery pack installed in the flat panel sensor is fully charged, it is possible to perform exposures for a maximum of approximately 500 images. However, the number varies depending on the usage conditions.



The capacity of the battery pack is displayed on the battery pack level indicator of the flat panel sensor and on the screen of the image processing unit.



When the remaining capacity of the battery pack of the flat panel sensor becomes less than approx. 10 minutes, a pop-up window appears on the image processing unit display, and exposure cannot be performed. If this happens, replace or charge the battery pack.



When the remaining capacity of the battery pack installed in the flat panel sensor becomes low, the battery pack level indicator is lit in orange and exposures cannot be performed. If this happens, connect the SE cable to the flat panel sensor to charge the battery pack.

1 Set the battery pack in the battery charger.

When the battery pack is set, a buzzer sound is generated and the charge status indicator LED lights.

Two battery packs can be charged at the same time.

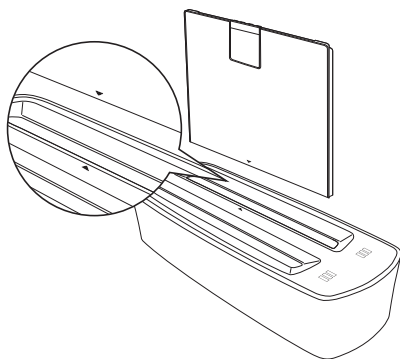

2 When battery charge is completed, remove the battery pack.

When battery charge is completed, the charge status indicator LED changes from blinking to lighting.

3.1.7 Charging the Image Processing Unit

For details, refer to the manual of the personal computer.

3.1.8 Installing/Removing the Battery Pack for the Flat Panel Sensor

Follow the procedure below to install/remove the battery pack for the flat panel sensor.



When installing/removing the battery pack, place the flat panel sensor on a flat place.



Do not remove the battery pack until a processed image appears in the window of the image processing unit after the exposure.

1 Remove the battery cover.

Place the flat panel sensor with the back side facing upward, press the “●” portion of the lock lever and then slide it in the direction of the arrow to remove the battery cover.

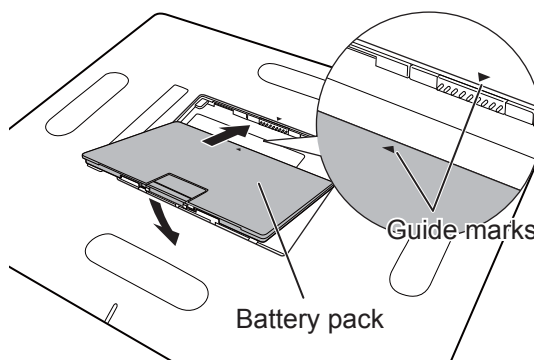
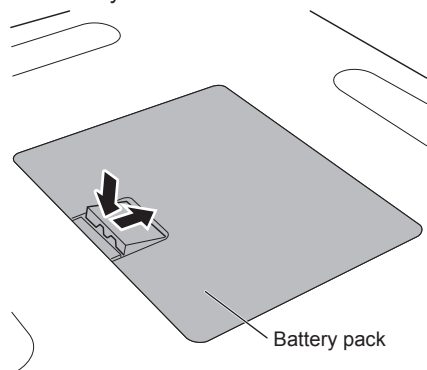

- To remove the battery pack, perform the same procedure as Step 1 (removing the battery cover).
- To install the battery cover, perform the same procedure as Step 2 (installing the battery pack).

2 Install the battery pack.

Slide the battery pack along the dent of the battery section of the flat panel sensor toward the connector terminal. Align the guide mark of the battery pack with that of the flat panel sensor, and push the battery pack in to install it.

Make sure that battery pack is securely installed.



Pushing the battery pack in with the guide marks misaligned may damage the connector terminal.



When attaching the battery pack, make sure that the waterproof packing attached to the connector terminal of the flat panel sensor is aligned properly.



When the battery pack is installed in the flat panel sensor, the power is automatically turned on.

3.1.9 Lamp Indications on the Flat Panel Sensor

This section explains the indications of the flat panel sensor identification lamp and the battery pack level indicator. For other lamp indications, see “2.2.1 DR-ID 1200”.

■ Flat panel sensor identification lamp

The flat panel sensor is active	: Blinking in white
While in sleep/extra sleep mode	: Blinking in identification color
While detecting an impact	: Blinking in red

■ Battery pack level indicator

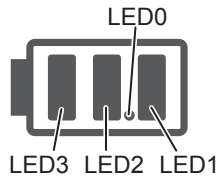

(When the battery pack is being charged)

Fully charged	LED1, 2, 3: Lit in green
Available time: 60 minutes or more	LED3: Blinking in green, LED1, 2: Lit in green
Available time: 30 minutes or more but less than 60 minutes	LED2 : Blinking in green, LED1: Lit in green
Available time: Less than 30 minutes	LED1: Blinking in green

(When the battery pack is not charged)

Available time: 60 minutes or more	LED1, 2, 3: Lit in green
Available time: 20 minutes or more but less than 60 minutes	LED1, 2: Lit in green
Available time: Less than 20 minutes	LED1: Lit in green
Available time: 10 minutes or less	LED0: Lit in orange

3.1.10 Attaching the Flat Panel Sensor to the Docking Stand



CAUTIONS

- Handle the docking stand carefully. Do not hit or drop the docking stand or subject it to severe shock to avoid possible damage.
- If any damage such as cracking, chipping or peeling is found on the docking stand, use it after repair. Otherwise, personal injury may result. Consult a FUJIFILM dealer for repair.
- If excessive force is applied to the docking stand, it may be damaged. In addition, do not apply excessive force to the flat panel sensor inserted in the docking stand.
- When moving the docking stand that has already been installed, consult our official dealer or local representative.
- Do not pull the cable forcibly. Otherwise, the cable may be broken or the docking stand may be damaged.

- 1** Disconnect the connector from the flat panel sensor and then attach the adapter for the docking stand.

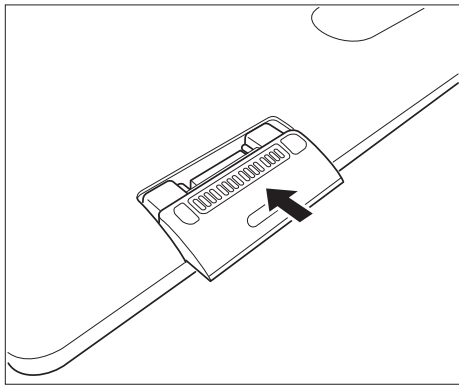

- 2** Insert the flat panel sensor.

Check the position of the adapter for the docking stand, align the flat panel sensor with the docking stand, and slowly insert the flat panel sensor straight into the docking stand until it stops along the right and left guides of the docking stand.

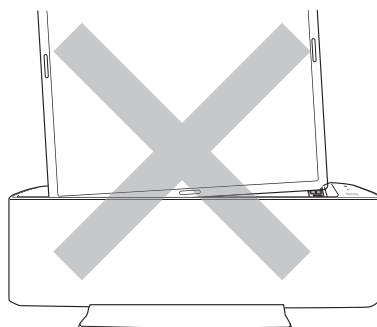
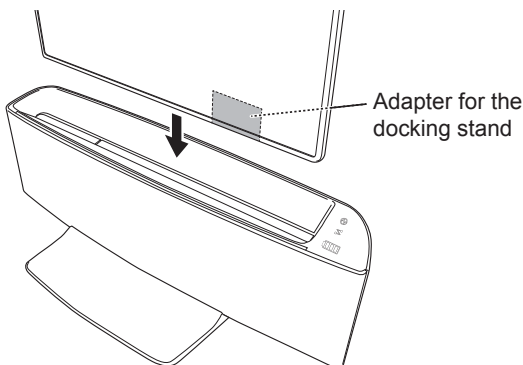

HINT

When removing the adapter for the docking stand from the flat panel sensor, slide the lock key on the adapter for the docking stand toward the right side.

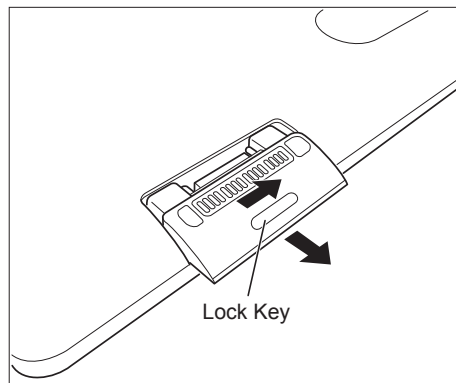

3.2 Starting Up and Shutting Down the System

This section explains how to start up and shut down the system. Operations are required on the power supply unit, docking stand, flat panel sensor and image processing unit.



The image processing unit in this section is only an example. For details on the image processing unit being used, see the Operation Manual provided with the personal computer.

3.2.1 Starting Up the System

(When the DR-ID 1200PU is used)



Make sure that the power cable is connected to the image processing unit.

1 When the flat panel sensor is used in wireless communication mode, install the fully charged battery pack to the flat panel sensor.

When it is used in wired communication mode, connect the flat panel sensor and the power supply unit using the SE cable.

2 Press the ON side of the main switch of the power supply unit.

Make sure that the power status LED is lit in blue.

3 When the optional access point is used, connect the access point to the image processing unit.



CAUTIONS

Use the optional access point by connecting it to the preset image processing unit and to the USB connector. Do not use the optional access point by connecting it to other image processing unit and/or USB connector.

4 Press the ON side of the main switch of the power supply unit.
The initialization process starts.

- All cables should be connected properly.
- No media should be inserted into the disk drive of image processing unit.

If the control cabinet is included in the system, the control cabinet starts up automatically.



CAUTIONS

If the power status LED of the control cabinet does not come on after turning on the image processing unit, turn on the control cabinet.

5 The Patient Information Input Screen below appears following the opening screen on the image processing unit monitor.

Patient Information Input Screen

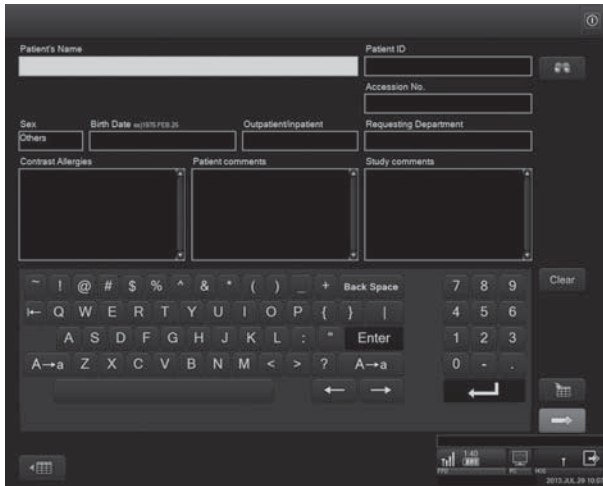

CAUTIONS

An error occurs if the system is started up immediately after shutdown. To restart the system including the control cabinet, make sure that the power status LED of the control cabinet is off, and then press the power switch for the image processing unit.

CAUTIONS

- Do not connect/disconnect the flat panel sensor to/from the power supply unit or to/from the docking stand while the message “Calibrating...” is displayed in the connected devices status after the system startup. Otherwise, the system does not start up normally, resulting in an error.
- may be displayed in the connected devices status while information on radio wave strength is being acquired from the flat panel sensor.

(When the DR-ID 1200DU is used)



Make sure that the power cable is connected to the image processing unit.

1 Turn on the main switch on the docking stand.

Make sure that the POWER lamp among the status lamps is lit in blue.

2 Install the fully charged battery pack to the flat panel sensor.

3 When the optional access point is used, connect the access point to the image processing unit.

CAUTIONS

Use the optional access point by connecting it to the preset image processing unit and to the USB connector. Do not use the optional access point by connecting it to other image processing unit and/or USB connector.

4 Turn on the image processing unit.

- 5** The Patient Information Input Screen appears on the image processing unit monitor as shown in Step **5** on Page 3-8.



CAUTIONS

- Do not connect/disconnect the flat panel sensor to/from the power supply unit or to/from the docking stand while the message “Calibrating...” is displayed in the connected devices status after the system startup. Otherwise, the system does not start up normally, resulting in an error.
- may be displayed in the connected devices status while information on radio wave strength is being acquired from the flat panel sensor.

3.2.2 Shutting Down the System

(When the DR-ID 1200PU is used)

- 1** Confirm that the equipment is not running. Touch the button at the upper right of the image processing unit display, and then the **Shut Down** button from the displayed menu. Touch the **OK** button in the displayed confirmation window.

The image processing unit will shut down in a few minutes. If the control cabinet is included in the system, the control cabinet will also turn off automatically.

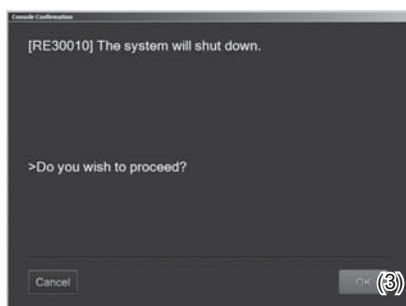
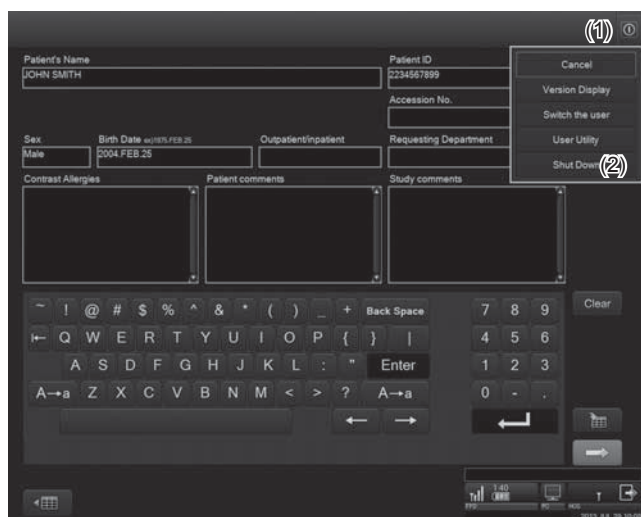

- 2** Turn off the display as necessary.
- 3** Make sure that calibration of the flat panel sensor is completed.
When completed, the READY lamp of the flat panel sensor turns off.
- 4** When the optional access point is used, remove the access point from the image processing unit.

5 Press the OFF side of the main switch of the power supply unit.

Make sure that the power status LED is off.

6 Remove the battery pack from the flat panel sensor. Set these battery packs in the battery charger.

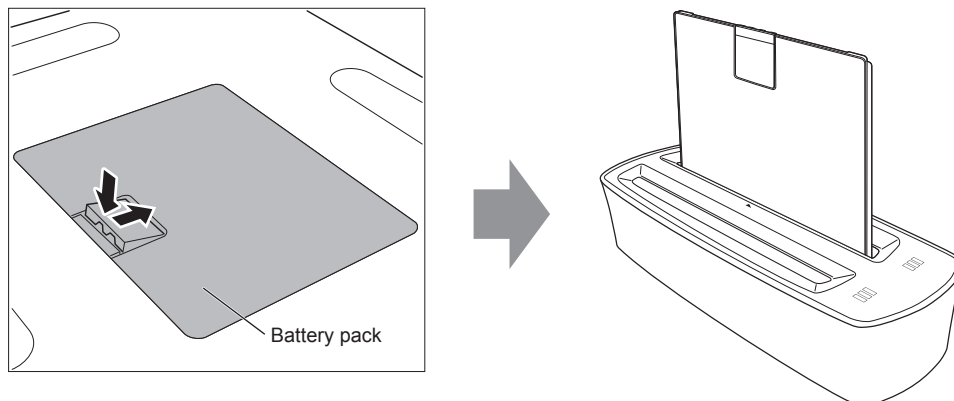

CAUTIONS

If the control cabinet is included in the system, do not turn off the control cabinet with the main switch. Shutdown operation may not be performed normally.

CAUTIONS

When the system is shut down, image quality adjustment is performed for obtaining optimal diagnostic images.

Do not disconnect the SE cable or SE communication cable until system shutdown when the flat panel sensor is used in wired communication mode.

Remove the battery pack after confirming system shutdown when the flat panel sensor is used in wireless communication mode.

(When the DR-ID 1200DU is used)

1 Perform Steps **1** 1 and **2** on Page 3-9.

2 When the optional access point is used, remove the access point from the image processing unit.

3 Make sure that calibration of the flat panel sensor is completed.

When completed, the READY lamp of the flat panel sensor turns off.

4 Turn off the main switch on the docking stand.

Make sure that the POWER lamp among the status lamps is off.

5 Remove the battery pack from the flat panel sensor. Set these battery packs in the battery charger.

3.3 Routine Operations

FDR D-EVO II routine operations can be broadly divided into the following three steps.

Step 1 Entering the Patient Information  (See page 3-14.)



Step 2 Selecting the Anatomical Region and Exposure/Study Menu  (See page 3-15.)



Step 3 X-ray Exposure  (See page 3-17.)



HINT

Operations that are actually performed on the FDR D-EVO II are only those described in “ Step 3 X-ray Exposure”. Other operations are performed on the image processing unit.

 For details, see “DR-ID 300CL Operation Manual”.

Step 1 Entering the Patient Information

1 The Patient Information Input Screen below is displayed on the image processing unit display immediately after startup.

Enter patient information items appropriately, and then touch the  button.



Not all the items of patient information need to be input.
Input any one of the items in order to proceed to the next operation.



When the optional card reader is provided, patient information can be input by reading from a magnetic card.



Observe the following when the message “Calibrating...” is displayed in the connected devices status.

- Do not subject the flat panel sensor to shock.
- Do not deliver radiation.
- Do not connect/disconnect the flat panel sensor to/from the power supply unit or to/from the docking stand.

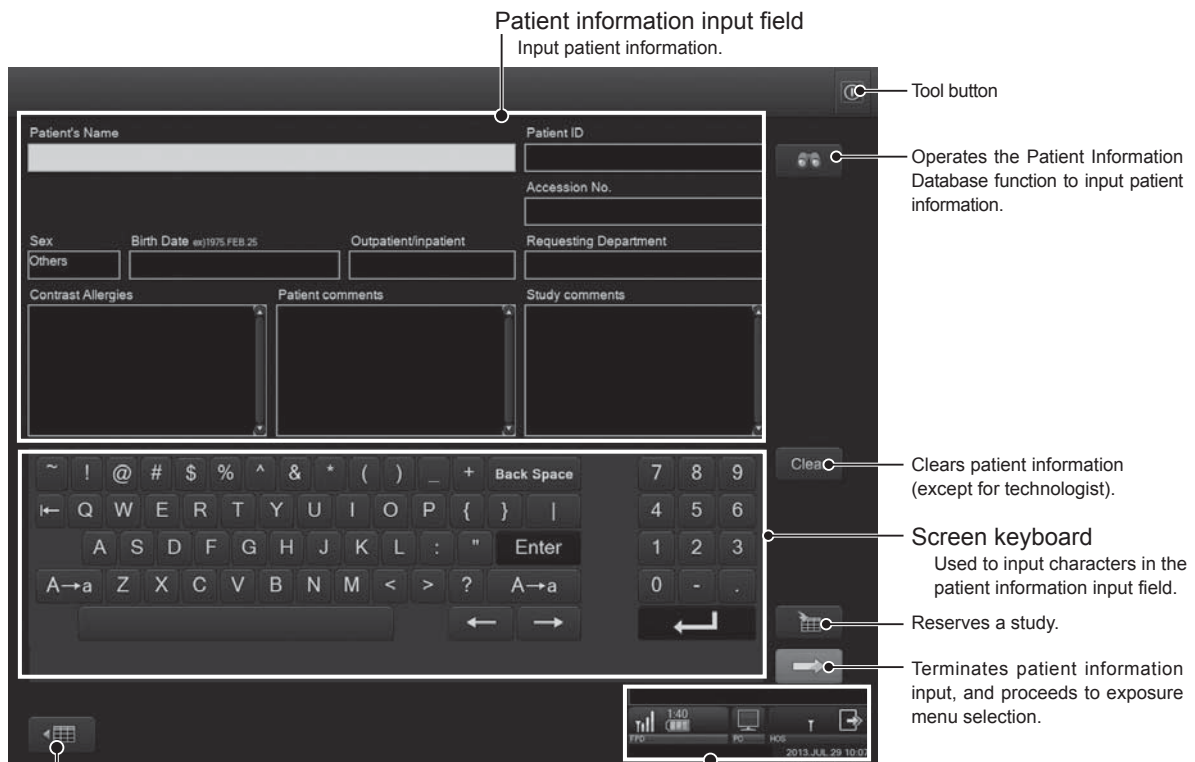

Displays the “Study List screen”.

Connected devices status
Connected devices status display field.
Displays the status of connected devices.

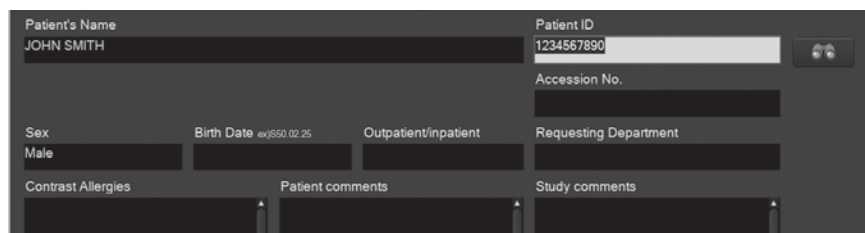

Patient information includes the following items.

Patient's Name / Sex / Birth Date / Outpatient/Inpatient / Patient ID / Accession No. / Requesting Department / Contrast Allergies / Patient comments / Study comments



HINT

You can change patient information input items and their display order in the User Utility settings.

Step 2 Selecting the Anatomical Region and Exposure/Study Menu

1 The Exposure Menu Selection Screen is displayed.

Select an anatomical region from the display group list, and then select an exposure menu from the exposure menu list registered to the display group on the lower side. (More than one menu can be selected.)

The selected exposure menu(s) is displayed in the selected exposure menu list on the right side of the screen.

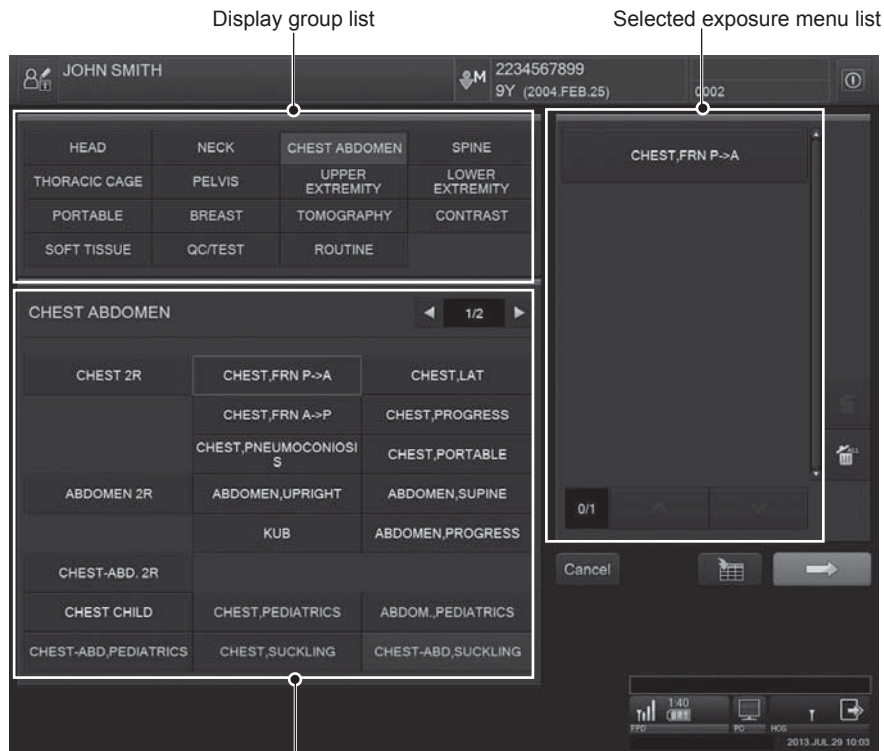

Exposure menu list registered to the display group

2 Touch after selecting exposure menu(s).

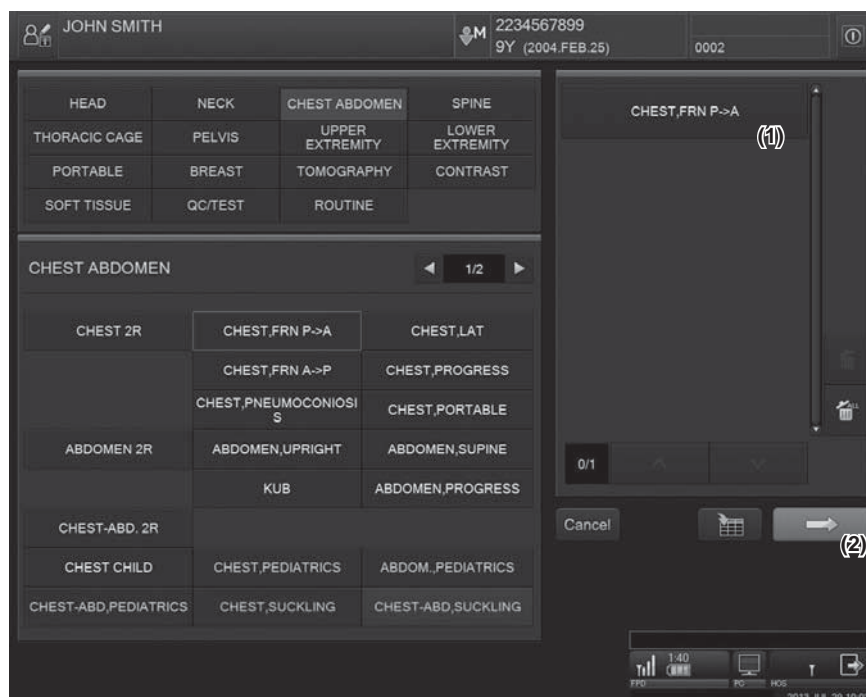

3 The Study Screen is then displayed.

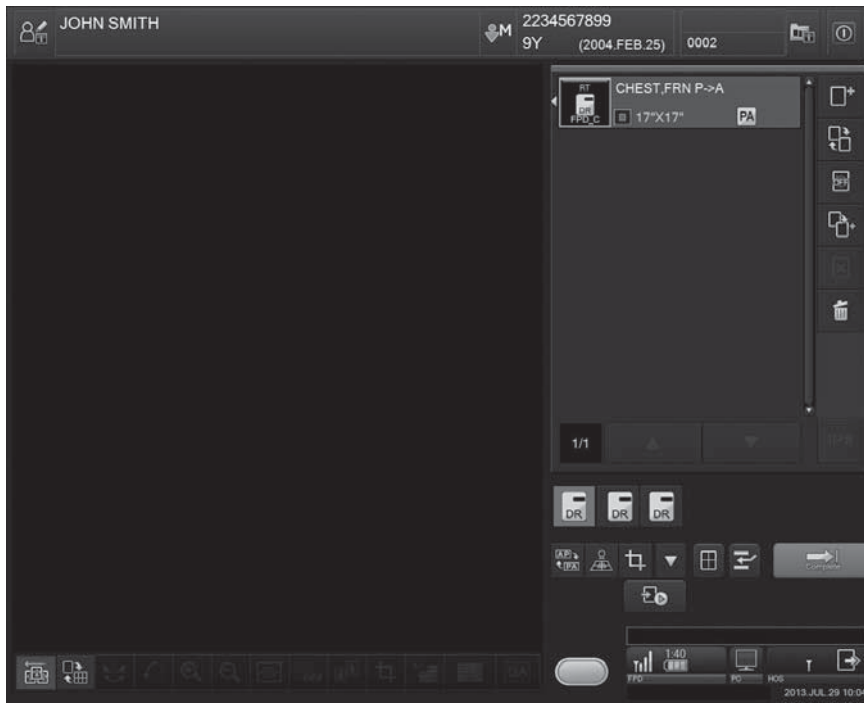

When registering an exposure menu(s), move the flat panel sensor and image processing unit or access point close to each other, so that they are within the range of wireless communication.



If the units are out of the range of wireless communication, the message may appear when an exposure menu(s) is registered. In this case, move the flat panel sensor and image processing unit or access point close to each other, so that they are within the range of wireless communication, and then follow the displayed message.

For details, see “4.1 When a Message Appears on the Image Processing Unit”.

Step 3 X-ray Exposure

When settings on the image processing unit have been completed, you can perform an exposure.



CAUTIONS

- **Make sure to identify a patient against the name or birth date and then have him (her) take a proper positioning for exposure.**
- **Make sure to confirm the exposure menu to be used and then have a patient take a proper positioning for exposure.**
- **When multiple panels are used, make sure that the READY lamp among the status lamps of the flat panel sensor is lit in order to confirm that it is the correct one for the selected technique.**
- **After starting exposing operation, do not disconnect or connect the connector. If the connector is disconnected or connected, radiography may become impossible or normal images cannot be obtained.**



HINT

Mobile exposures can be made by carrying the flat panel sensor, notebook computer (image processing unit) and the optional access point.

[1] Positioning the patient

Position the patient.



CAUTIONS

Exercise due care so that an intravenous line or drain tube put to a patient does not hook into the equipment.



For the exposure position of the upright-type/bed-type radiographic examination stand, see its Operation Manual.

When making an exposure directly using the flat panel sensor, set the exposure position by reference to the effective area.

- For details on the effective area, see page A-6.

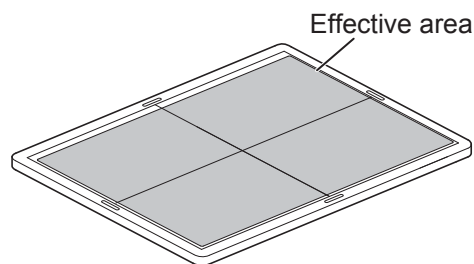

- When the automatic X-ray detection function is used, see “Z.5 Precautions for the Automatic X-ray Detection Function”.

[2] X-ray exposure/Image displaying



Make an exposure after confirming that Shot Ready (exposure ready status indicator) is lit green in the connected devices status of the image processing unit. When the automatic X-ray detection function is used, if the flat panel sensor is subjected to X-ray radiation without ShotReady lit in green, no image will be acquired although X-ray radiation is applied.



After the exposure, do not move the image processing unit and the flat panel sensor until a processed image appears in the window of the image processing unit.

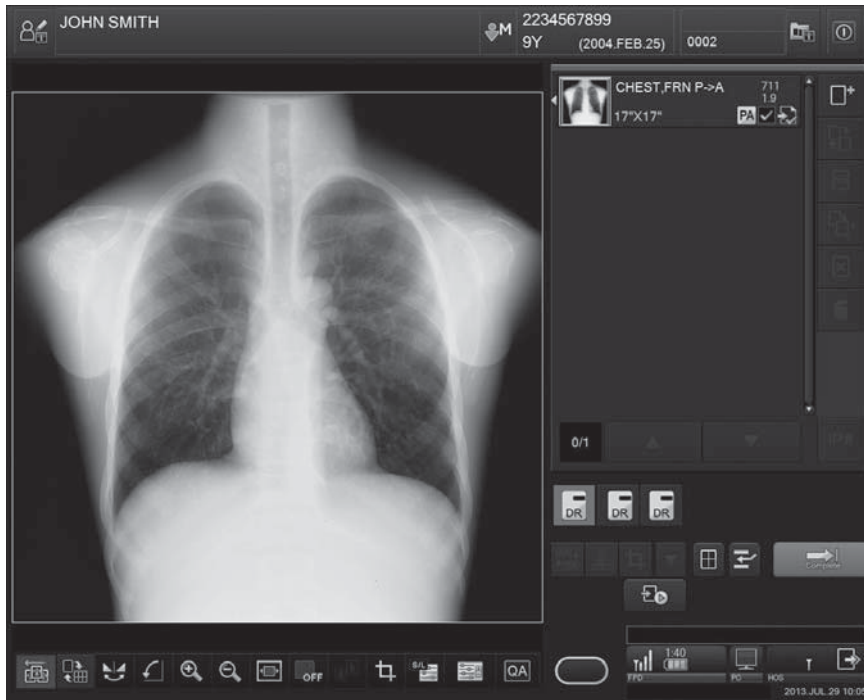

Touch the  button at the lower right to complete the study.

To prepare for exposures of the next patient, repeat **Step 1** through **Step 3**.

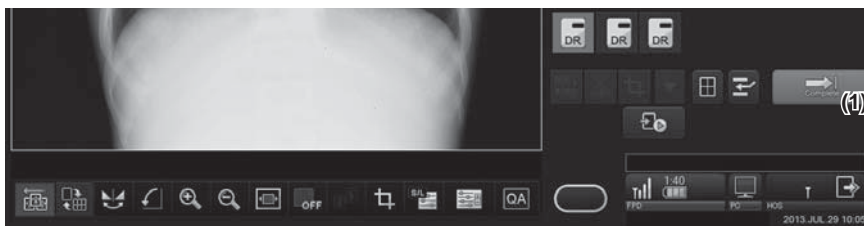

The registration of the next new patient should be processed after more than 2 seconds.

[3] Sleep mode

When sleep mode is enabled, if no operation is performed for about two minutes without an exposure menu registered, the flat panel sensor will enter sleep mode and the power state is changed to the power-saving state. Once an exposure menu is registered, sleep mode is canceled automatically. In addition, when the SE cable is connected to the flat panel sensor, or when the flat panel sensor is inserted into the docking stand, sleep mode is canceled automatically.

Extra sleep mode, which can further save power, can also be set. If a specified time has elapsed after all flat panel sensors enter sleep mode, they enter extra sleep mode. When the sleep release/memory exposure mode start button is pressed, extra sleep mode is canceled.



In sleep mode or extra sleep mode, the operating time of the battery pack becomes longer since the power is saved. If the flat panel sensor is being calibrated, or if it detects an impact, it may take longer time to enter sleep mode, or sleep mode may be canceled temporarily. When the setting of sleep mode or extra sleep mode needs to be changed, consult our official dealer or local representative.

[4] Extended Image Readout

When the Extended Image Readout mode is enabled, a long exposure for up to ten seconds is available. To set the Extended Image Readout mode, consult our official dealer or local representative. For details on how to use the Extended Image Readout mode, see the “Console Advance (DR-ID 300CL) Reference Guide”.

3.4 How to Use Memory Exposure Mode

In the memory exposure mode, a maximum of 100 exposures can be made only with the flat panel sensor, without using the image processing unit.

3.4.1 How to Start up and Use Memory Exposure Mode

- 1 Press and hold the memory exposure mode start button and the sleep release/memory exposure mode start button at the same time for 2 seconds.

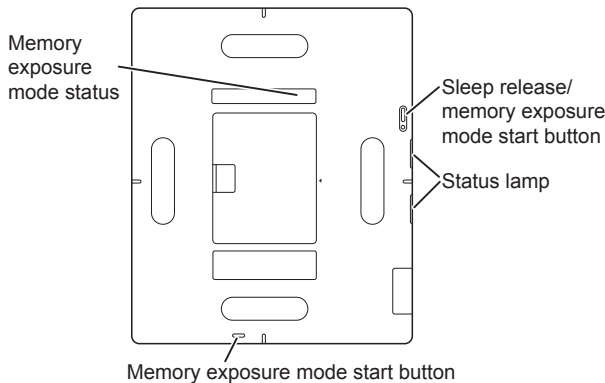

When the number of images stored on the flat panel sensor is displayed in the memory exposure mode status, the start-up process is completed.

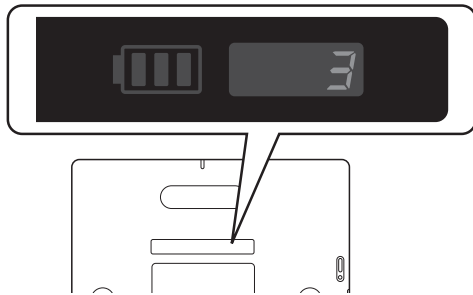

HINT

Before the start-up process is completed, calibration of the flat panel sensor may be performed. During calibration, "888" blinks in the memory exposure mode status.



When calibration is completed, the number of images stored on the flat panel sensor is displayed.



CAUTIONS

When the memory exposure mode is started up while the flat panel sensor is in use, a message is displayed on the screen of the image processing unit, indicating that communication is disconnected. Since this is not an error, select "OK" to continue operation. However, if the following error codes are displayed, take appropriate measures according to the instructions displayed on the screen: 10XXX (error codes beginning with "10"), 11112, 11244, 11227, 11228 or 11751.

HINT

When the memory exposure mode is started up, the flat panel sensor enters X-ray detection mode. For details on X-ray detection mode, see "Z.5 Precautions for the Automatic X-ray Detection Function".

- 2 When the READY lamp among the status lamps is automatically lit in green, make an exposure.

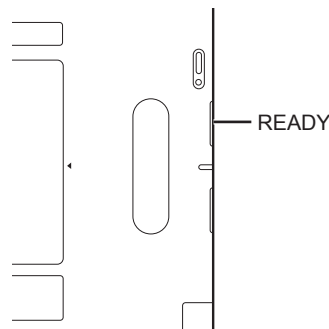

- 3 Make sure that the number of images displayed in the memory exposure mode status has increased.



When the READY lamp among the status lamps is automatically lit in green, the next exposure can be made.

HINT

The value displayed as the number of images is used for managing the images. For example, when "3" is displayed before an exposure and then "4" is displayed after the exposure, the number of the exposed image is "4".



CAUTIONS

- Note that when the flat panel sensor is used in the memory exposure mode, if a strong impact is applied to the flat panel sensor, a white image may be obtained, incrementing the number of images.
- Manage the records of exposed images to identify the correspondence between the image number and the patient name.

3.4.2 How to Load Images

- 1** Connect/insert the flat panel sensor to/into each device.

(When the DR-ID 1200PU is used)

Connect the flat panel sensor to the power supply unit using the SE cable.

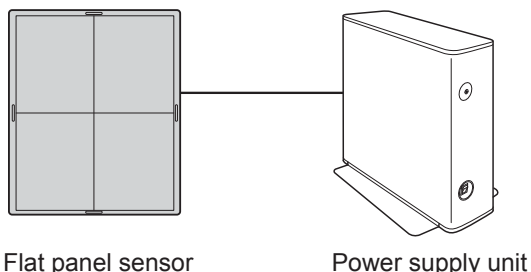

(When the DR-ID 1200DU is used)

Insert the flat panel sensor into the docking stand.

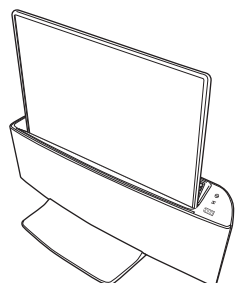

For details on how to insert the flat panel sensor into the docking stand, see “3.1.10 Attaching the Flat Panel Sensor to the Docking Stand” on Page 3-8.

- 2** To load images stored on the flat panel sensor into the image processing unit, display the “Image Reader Status window” on the image processing unit, select the flat panel sensor and then “Get Image (FPD → CSL)”.

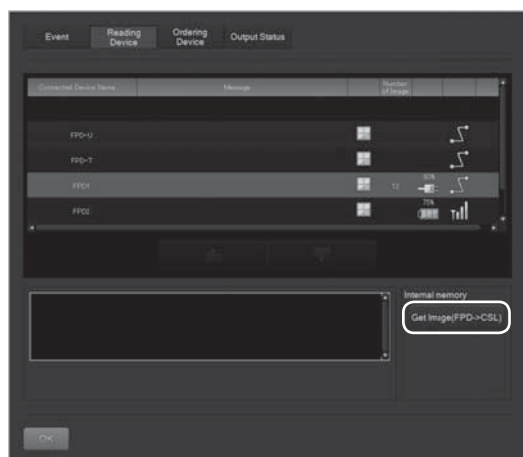

Images stored in the flat panel sensor are loaded onto the image processing unit.



When calibration of the flat panel sensor is in progress, an error may occur. If this happens, wait for a while and then try image loading again.

- 3** Display the “Study screen” of the patient corresponding to the loaded images, and select the exposure menu to be linked with the images.
- 4** Select the selector of the flat panel sensor in which the image is stored and then select [Image Box].
- 5** On the “Image Library screen”, select the image of which the number is to be linked with the exposure menu and then select [Import].



HINT

When an image that has not been linked with an exposure menu is left, if images are acquired from the flat panel sensor, the acquisition date and time is added to the image No. of the image that was acquired previously.

- ▶ For details, see the “Console Advance (DR-ID 300CL) Reference Guide”.

3.4.3 List of Error Codes

If an error occurs while starting up or using the memory exposure mode, the corresponding error code is displayed in the memory exposure mode status. Terminate the memory exposure mode and then perform the countermeasure against each error. Error codes are listed in the table below.

Error code	Occurrence condition	Countermeasure
E01	Calibration of the flat panel sensor is in progress.	Wait for a while and then start up the memory exposure mode again.
	An exposure menu is registered on the image processing unit.	Terminate or suspend the study on the image processing unit.
	The SE cable or SE communication cable is connected to the flat panel sensor.	Disconnect the SE cable or SE communication cable from the flat panel sensor.
	The flat panel sensor is inserted into the docking stand.	Remove the flat panel sensor from the docking stand.
E03	An X-ray is irradiated when exposure is not available.	Connect the flat panel sensor to the image processing unit or remove and attach the battery pack and then restart the memory exposure mode.
E04	The flat panel sensor detects an impact.	Connect the flat panel sensor to the image processing unit.
E05	The remaining capacity of the battery pack is low.	Replace the battery pack.
E06, E07, E17, E18	The temperature of the flat panel sensor or battery pack is abnormal.	Check if the operating temperature is within the temperature range specified in the environmental operating conditions.
E08, E09, E11 to E14, E16, E19	An abnormality occurred on the flat panel sensor.	Consult our official dealer or local representative.
E10	Calibration has failed.	Restart the memory exposure mode.
E15	Image storage has failed.	Consult our official dealer or local representative.

If the same error occurs repeatedly, consult our official dealer or local representative.

3.4.4 How to Terminate Memory Exposure Mode

(DR-ID 1200PU)

Remove the battery pack from the flat panel sensor.

Or connect the flat panel sensor to the power supply unit or to the optional access point by using the SE cable or SE communication cable.

(DR-ID 1200DU)

Remove the battery pack from the flat panel sensor.

Or insert the flat panel sensor into the docking stand.



HINT

Images exposed in the memory exposure mode are not lost even if the battery pack is removed from the flat panel sensor.

Chapter 4 Troubleshooting

4.1 When a Message Appears on the Image Processing Unit

This section describes the warning dialog box and error messages.

If an error which cannot be handled or the same error recurs frequently, contact our official dealer or FUJIFILM Representative.

If an error of unknown cause occurs, do not continue the operation and contact our official dealer or FUJIFILM Representative.

[1] If a warning dialog box appears

If a communication error or an unexpected error has occurred, a warning dialog box pops up on the screen. In such a case, after checking error details and closing the box, take appropriate action immediately. Be sure not to continue the operation of the image processing unit without taking an appropriate action.

If any operation is performed while a warning dialog box is displayed, another screen may be displayed, hiding the dialog box behind. In this case, press the [Enter] key to close the hidden box. When a warning dialog box that contains an error code beginning with "10" appears, follow the steps below.

- 1** Read a message in the warning dialog box, and then click [OK] in the dialog box.
- 2** Detach the battery packs for all flat panel sensors.
- 3** Confirm that the flat panel sensors are turned off.
- 4** Reattach the battery packs to the flat panel sensors. Then the system restarts.

[2] If the message dialogue box MD11001 appears

The following message dialogue box appears not only when the image processing unit starts up but also when a communication error occurs in the flat panel sensor or image processing unit.

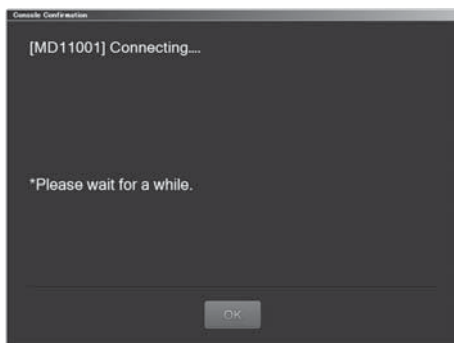

Check if the flat panel sensor is within the reach of radio waves. If the unit is out of the range, move the image processing unit and the flat panel sensor closer to each other.

In addition, confirm that there are no obstacles which are interrupting the communication.

When the problem is not solved within a short time after the message box is displayed, perform the following procedure.



When acquiring data is interrupted, the image data is maintained in the flat panel sensor if reconnection is successfully made or until power supply of flat panel sensor is turned off, so image data will not be lost. In the case of the memory exposure mode, images stored in the flat panel sensor are not lost even if the flat panel sensor is turned off.

- 1** Select [OK] on the message box.
- 2** Check if the equipment connected with the image processing unit is turned on.

If any equipment is turned off, turn it on and wait for a while.

- 3** If the problem is not solved, shut down the image processing unit.

- 4** Make sure that the power status LED of the control cabinet is off, and then restart the image processing unit.

This step is not required if the control cabinet is not included in the system.



If the power status LED of the control cabinet does not turn off even after approximately 10 minutes have passed following the shutdown of the image processing unit, press and hold the main switch of the control cabinet.

When the image processing unit is restarted and the same error message box is displayed, contact our official dealer or FUJIFILM Representative.

[3] If an exposed image cannot be acquired





Do not remove the battery pack from the flat panel sensor until an exposed image is acquired. If removed, the image data and the exposure menu data used for the exposure will be lost.

If an exposed image cannot be acquired, the following error message may be displayed.

- 1** If wireless communication is disconnected during image reading, the following message dialog is displayed.

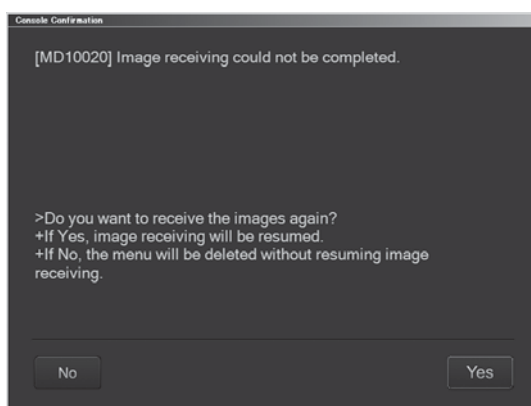
<Error message of "MD10020">



Move the flat panel sensor close to the access point, check the displayed icon () to make sure that proper wireless communication is established, and then select "Yes". If the status is not improved, connect the flat panel sensor and the access point using the SE communication cable and then select "Yes". If you select "No", the image data and the exposure menu data used for the exposure will be lost.

- 2** If an exposure is made under a condition where wireless communication is unstable, the following message dialog may be displayed. Select “OK” to acquire the image and then check the acquired image.

<Error message of “11409”>

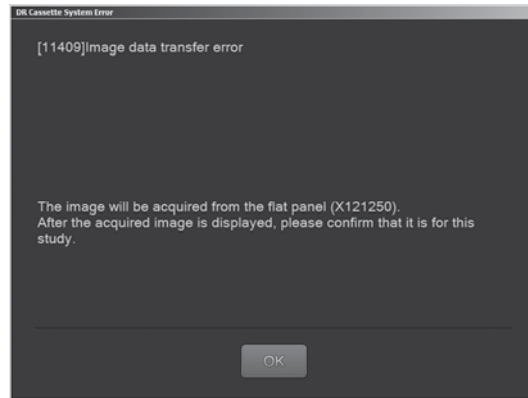

- [4] If the dialog box containing the error message numbered 13048 appears**

The dialogue box appears when a severe shock is applied to the flat panel sensor. Make sure that the exterior of the flat panel sensor is not damaged or deformed and that no abnormality is found in the exposed image.

- [5] If “Unusable due to error.” appears on the image processing unit**



If “Unusable due to error.” is displayed on the image processing unit, remove the battery pack from the flat panel sensor and install it again.

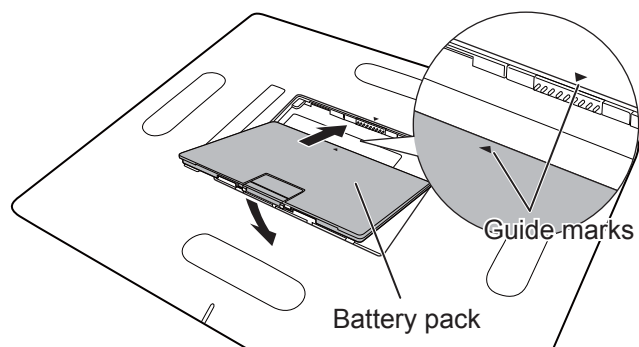

[6] If any other message dialogue box appears

If a message dialogue box other than those [1] – [5] appears on the image processing unit monitor, read the message carefully and take appropriate action.

4.2 How to Cope with an Error...

[1] When the image processing unit hangs up...

If an inappropriate processing is performed while this equipment is operating, the screen may freeze and the system may hang up (processing disabled). In that case, shut down the equipment forcibly according to the following procedure, and then restart it.

1 Press the [Ctrl] + [Alt] + [Del] keys simultaneously.

2 “Windows Security” is displayed.

Select [Start Task Manager].

3 “Windows Task Manager” is displayed.

Select “ProcessManagerMain.exe” in the list in the “Processes” tab, and then click [End Process].

4 The message box is displayed.

Click [End Process] to terminate the image processing unit.

Depending on equipment status, an error message may not be displayed.

5 The desktop screen of the operating system is displayed.

Close the “Windows Task Manager window”, and then select the [Start] button at the lower left of the screen. Select [Restart] from the displayed menu.



CAUTIONS

- Make sure to shut down the system following the above procedures in case of a hang-up of the image processing unit. If the personal computer is turned off without shutdown, an error may occur on the computer.
- Note that forcible shutdown processing of the equipment is an emergency action. Do not use this action under normal situations.

6 If the control cabinet is included in the system, press and hold the main switch of the control cabinet to turn it off.

7 Turn off the main switch on the power supply unit and on the docking stand.

[2] When the image processing unit is turned off due to an electrical outage

When the image processing unit is turned off due to an electrical outage, etc., take the following actions according to the condition when the power comes back on.

■ If the power comes back on soon after an electrical outage

Wait until the image processing unit restarts.

When the image processing unit has restarted, shut down the image processing unit by following the normal procedure.

🔍 For details of system shutdown, see the “DR-ID 300CL Operation Manual”.

To restart the image processing unit, follow the procedure for the system startup.

[3] If a hard disk of the image processing unit is damaged

If one of the hard disks is damaged, a window indicating so will appear. In such a case, press the F1 key and contact our official dealer.

[4] If a white image is displayed after an exposure

If a white image is displayed, a LAN communication error may have occurred.

Check if the LAN communication connectors are properly connected between the flat panel sensor and the power supply unit or and between the power supply unit and the control cabinet. Make an exposure again after confirmation.

[5] Precautions for operation when the device status is “Initializing” or “Changing FPD” in the image processing unit’s “Output Device Status window”

When a flat panel sensor is added or replaced or when the battery of a flat panel sensor is replaced, “Initializing” or “Changing FPD” is displayed for all the flat panel sensors in the device status field of the image processing unit’s “Output Device Status window”. While either of the status messages is displayed, you cannot make an exposure. Wait until the message disappears.

When the flat panel sensor is turned on by connecting the cable for wired communication or by attaching the battery pack immediately after the system starts up or an X-ray exposure is made, it may take time before the next exposure becomes available.





Even if “Initializing” or “Changing FPD” is displayed for all the flat panel sensors, only those which are added or replaced or those whose battery is replaced will be initialized.

[6] If the flat panel sensor cannot be used in wireless communication mode

If the flat panel sensor is not recognized in a wireless communication mode, use the cable to connect the system in wired communication mode.

[7] If an error occurs on an output destination device

If an error occurs on an output destination device,  is displayed in the connected devices status. In such a case, operate as follows.
Select .



The “Output Device Status window” is displayed.

Select  after checking the connection status, and then take an appropriate action.

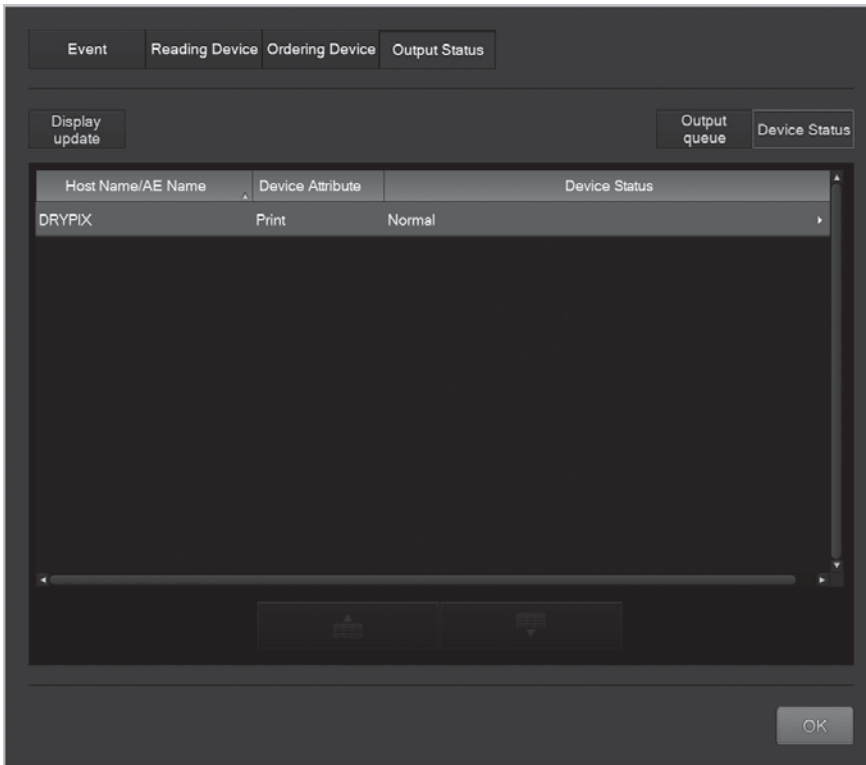

“Output Device Status window”

4

Troubleshooting

Chapter 5 Daily Inspection and Maintenance

5.1 Daily User Inspection and Maintenance

During maintenance and inspection, strictly observe precautions contained in “Chapter 1 For Safe Operation” in this manual for you to use the FDR D-EVO II under best conditions.

5.1.1 Daily Inspection (DR-ID 1200)

Inspection Before Use

- Make sure that the equipment starts up normally.
- Make sure that the equipment communicates with connected devices normally.
- Make sure that the time displayed is correct.
- 🔑 See “3.2 Starting Up and Shutting Down the System” (page 3-9).

Inspection During Use

- Make sure that images are output normally.
- 🔑 See “3.3 Routine Operations” (page 3-13).

Inspection After Use

- Shut down the equipment.
- 🔑 See “3.2 Starting Up and Shutting Down the System” (page 3-9).

Cleaning instructions

Use a neutral detergent or ethanol to clean the outer surfaces.



CAUTIONS

- Do not use a solvent such as thinner or benzene, as it corrodes the outer surfaces.
 - Make sure not to let water, detergent and ethanol get inside the equipment.
-

5.1.2 Periodical Inspection

Inspection Every Three Months

Once every three months, remove any dirt or dust accumulated in each part of the equipment using a vacuum cleaner or air duster, clean each part with a slightly moistened soft cloth and then wipe off any moisture with a dry cloth.

▶ See “2.2 Unit Names and the Functions” (page 2-4).



CAUTIONS

Be sure to turn off the power before cleaning each part of the device.

■ DR-ID 1200

DR-ID 1200

NO.	Unit	NO.	Unit	NO.	Unit	NO.	Unit
1	Flat panel sensor	2	Power supply unit	3	Power supply unit Air filter (1)	4	Image processing unit

Air filter

Clean the air filter on the rear of the power supply unit with a vacuum cleaner. Remove the louver while pressing the lever on the right side, and then clean the air filter with a vacuum cleaner after detaching it from the louver.

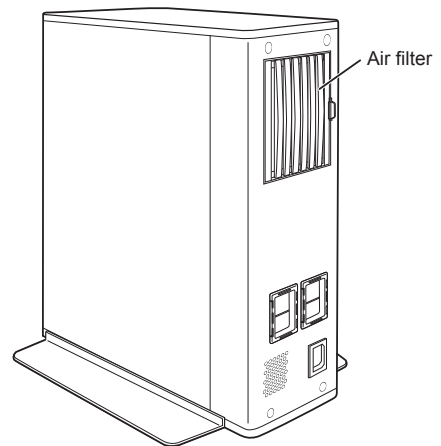

DR-ID 1200MC

NO.	Unit	NO.	Unit
1	Control cabinet	2	Periphery of devices

Optional

NO.	Unit	NO.	Unit	NO.	Unit
1	Battery charger	2	Battery pack	3	Access Point



CAUTIONS

- Ensure sufficient space when cleaning the equipment on a table, etc.
- If the image processing unit is secured in place, unlock it before cleaning.

Appendix A Specifications

A.1 Specifications

Specifications of the FDR D-EVO II are shown below.

A.1.1 Processing Capacity (DR-ID 1200)

- **Routine processing (when the two-image output format is used in standard mode)**

(1) **Exposure interval**

The exposure interval of the FDR D-EVO II is at least 9 seconds.

However, the interval varies depending on the region, the load to network communication, etc.

A.1.2 Image Output (DR-ID 1200)

- **Standard processing**

(1) **Film output**

Connection to the Imager makes it possible to obtain hard copies at the image reduction ratios and in the formats below.

- For standard pixel-density images (DR-ID 1201SE and DR-ID 1211SE)

Output size	Reduction ratio	
	Two-image output	One-image output
14" × 17" (35 × 43cm)	61%	100%
14" × 14" (35 × 35cm)	61%	100%
10" × 12"	85%	100%
8" × 10"	100%	100%
18 × 43cm	100%	100%

- For standard pixel-density images (DR-ID 1202SE and DR-ID 1212SE)

Output size	Reduction ratio	
	Two-image output	One-image output
17" × 17" (43 × 43cm)	50%	82%
14" × 17" (35 × 43cm)	61%	100%
14" × 14" (35 × 35cm)	61%	100%
10" × 12"	85%	100%
8" × 10"	100%	100%
18 × 43cm	100%	100%

[Fig. A.1]

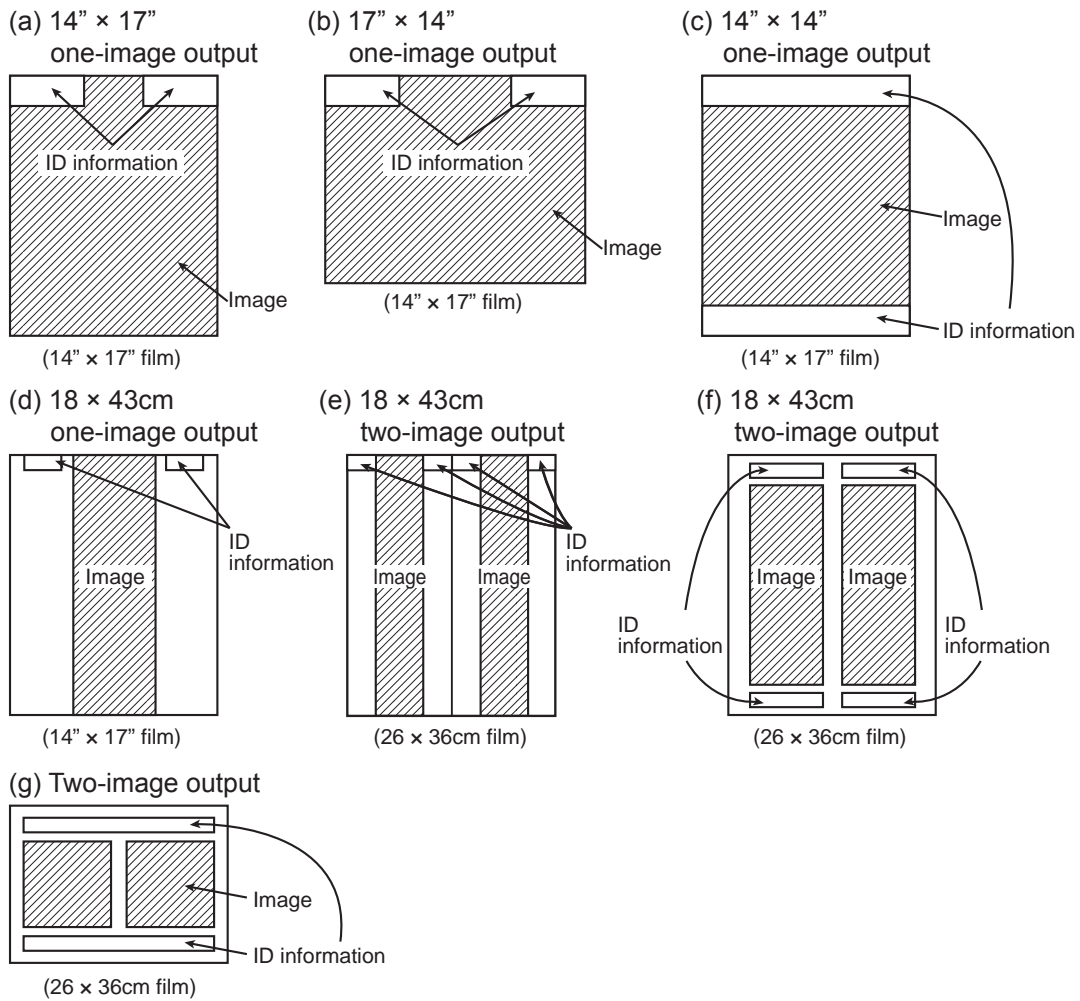

For one-image output using 17" × 14", 14" × 17", 14" × 14" or 18 × 43cm, images are output on 14" × 17" film. In other cases, images are output on 26 × 36cm film.



Depending on the printer connected or image processing unit software version used, image outputs in the following formats are available.

- 100%-size output of 14" × 14" image on 14" × 14" film
- 100%-size output of 8" × 10" image on 8" × 10" film, as well as reduced image output on films of other sizes
- 100%-size output of 10" × 12" image on 10" × 12" film

A.1.3 Reduced Equivalent

Peak reduced equivalent on the front panel of the flat panel sensor: 0.5 mmAl

A.1.4 Power Supply Conditions

■ DR-ID 1200PU

Rated voltage: 100-240V~
 Input current : 2-0.84A
 Frequency : 50-60Hz

■ DR-ID 1200DU

Rated voltage: 100-240V~
 Input current : 2-0.84A
 Frequency : 50-60Hz

■ DR-ID 1200MC*

Rated voltage: 115/230V ~
 Input current : 4.0/2.0A
 Frequency : 50-60Hz

* Since the DR-ID 1200MC is general-purpose electrical equipment, the electric rating above is an example.

A.1.5 Environmental Conditions

■ DR-ID 1200PU

(1) Operating Conditions

Temperature : 15°C (15%RH) - 30°C (80%RH)
 Humidity : 15%RH (15°C) - 80%RH (30°C) (no dew condensation)
 Atmospheric pressure : 700hPa - 1060hPa

(2) Non-operating Conditions

(Environmental conditions under which power can be supplied)

Temperature : 5°C - 35°C
 Humidity : 10%RH - 80%RH (no dew condensation)
 Atmospheric pressure : 700hPa - 1060hPa

(3) Storage Conditions

Temperature : -30°C - 50°C
 Humidity : 10%RH - 90%RH (no dew condensation)
 Atmospheric pressure : 700hPa - 1060hPa

■ DR-ID 1200DU

(1) Operating Conditions

Temperature : 15°C (15%RH) - 30°C (80%RH)
 Humidity : 15%RH (15°C) - 80%RH (30°C) (no dew condensation)
 Atmospheric pressure : 700hPa - 1060hPa

(2) Non-operating Conditions

(Environmental conditions under which power can be supplied)

Temperature : 5°C - 35°C
 Humidity : 10%RH - 80%RH (no dew condensation)
 Atmospheric pressure : 700hPa - 1060hPa

(3) Storage Conditions

Temperature : -30°C - 50°C
 Humidity : 10%RH - 90%RH (no dew condensation)
 Atmospheric pressure : 700hPa - 1060hPa



CAUTIONS

- When the flat panel sensor is used in high temperature condition for long period of time, it may cause image artifacts and/or failure of the device.
- When using the DR-ID 1201SE or DR-ID 1211SE, if the temperature is 37°C and the humidity is 90% RH (no dew condensation), continuous use of 30 minutes or less is possible. Using Manual Mode (energy saving mode) from the image processing unit when the temperature and humidity are the same allows up to 1 hour of continuous use.

■ DR-ID 1200MC

(1) Operating Conditions

Temperature	: 10°C - 35°C
Humidity	: 20%RH - 80%RH (no dew condensation)
Atmospheric pressure	: 700hPa - 1060hPa

(2) Non-operating Conditions

(Environmental conditions under which power can be supplied)

Temperature	: -40°C - 65°C
Humidity	: 5%RH - 95%RH (no dew condensation)
Atmospheric pressure	: 700hPa - 1060hPa



For details on the power supply conditions and environmental conditions of the image processing unit, see the "Console Advance (DR-ID 300CL) Operation Manual".

■ Battery charger (optional)

(1) Operating Conditions

Temperature	: 0°C - 35°C
Humidity	: 10%RH - 85%RH (no dew condensation)

(2) Non-operating Conditions

(Environmental conditions under which power can be supplied)

Temperature	: -20°C - 60°C
Humidity	: 10%RH - 95%RH (no dew condensation)



CAUTIONS

Charge the battery pack in the operating environment.

A.2 External View and Weight

The external view and weight of the FDR D-EVO II are shown below.



Specifications, dimensions and weight are subject to change for improvement without prior notice.

A.2.1 DR-ID 1200

■ DR-ID 1200PU/DR-ID 1200DU

	Width (mm(in.))	Depth (mm(in.))	Height (mm(in.))	Weight (kg(lb))
Flat panel sensor (DR-ID 1201SE)	460(18.1)	384(15.1)	15(0.6)	2.6(5.8)* ¹
Flat panel sensor (DR-ID 1202SE)	460(18.1)	460(18.1)	15(0.6)	3.2(7.1)* ¹
Flat panel sensor (DR-ID 1211SE)	460(18.1)	384(15.1)	15(0.6)	2.6(5.8)* ¹
Flat panel sensor (DR-ID 1212SE)	460(18.1)	460(18.1)	15(0.6)	3.2(7.1)* ¹
Power supply unit	120(4.7)	388(15.3)* ²	361(14.2)	8.7(19.2)
Docking stand	579(22.8)	93(3.7)	202(8.0)	5.5(12.1)

*1 The weight of the battery pack is included.

*2 Protrusions are excluded

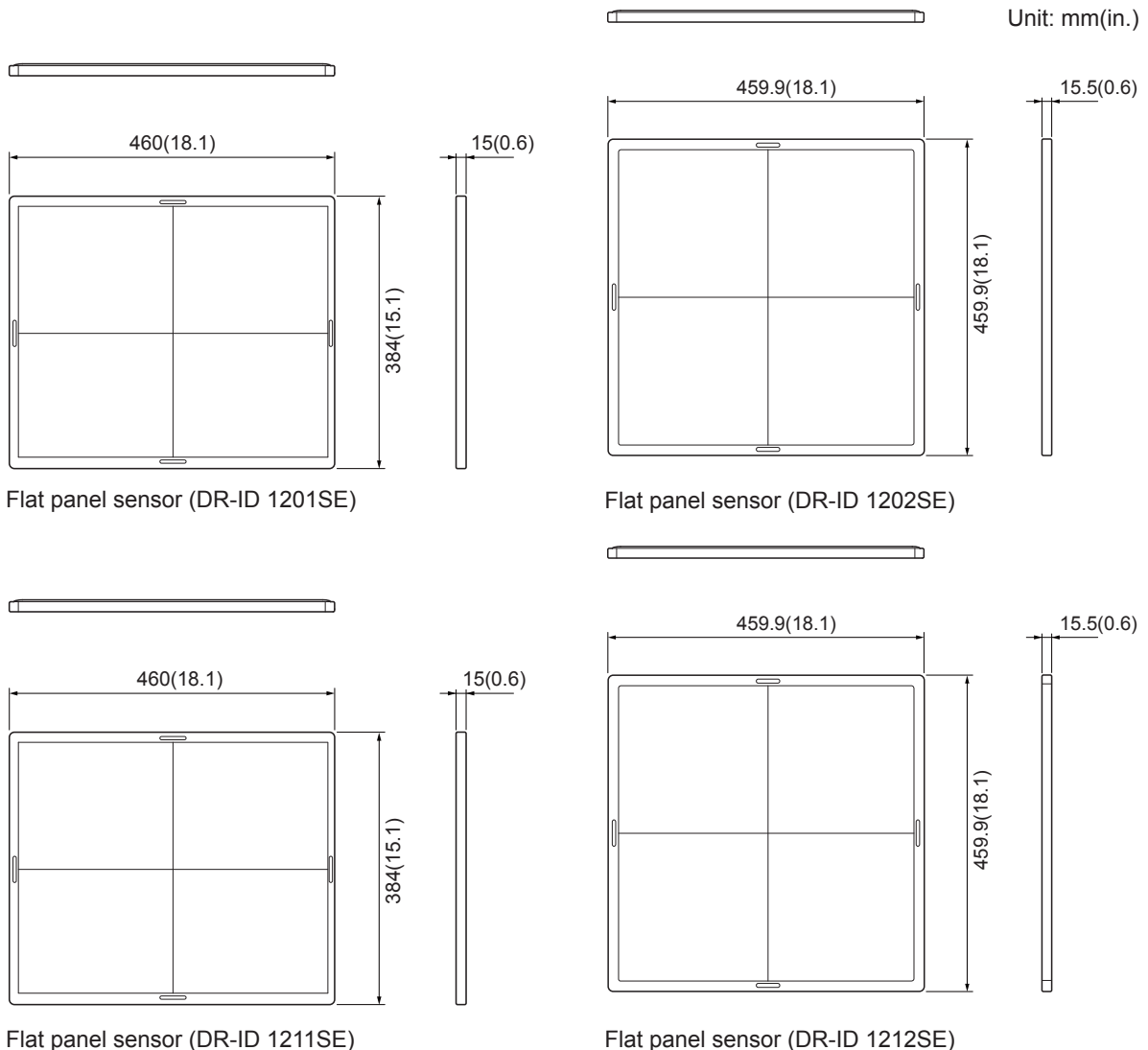

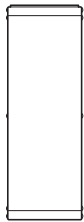

Unit: mm(in.)

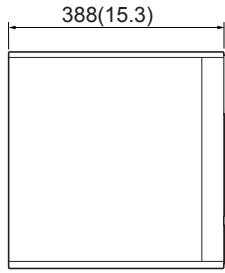
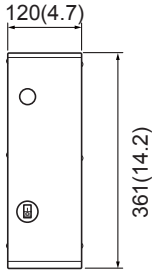

Power supply unit

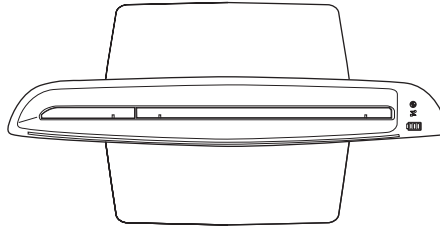

Unit: mm(in.)

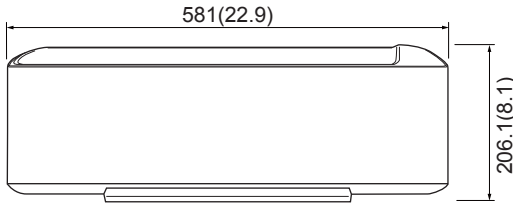

Docking stand

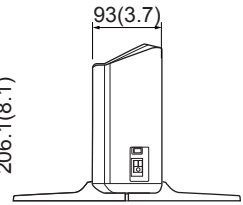

The effective area of the flat panel sensor is as shown in the figure below.

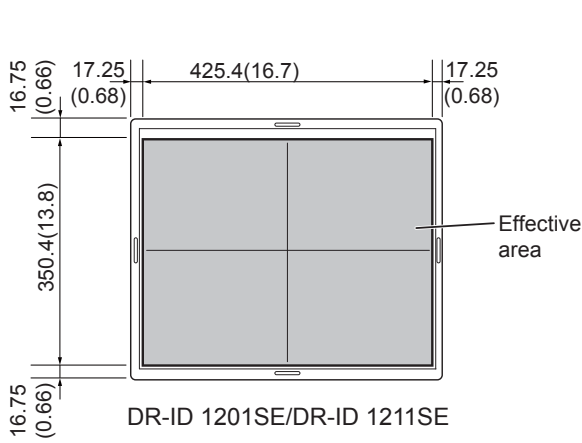

DR-ID 1201SE/DR-ID 1211SE

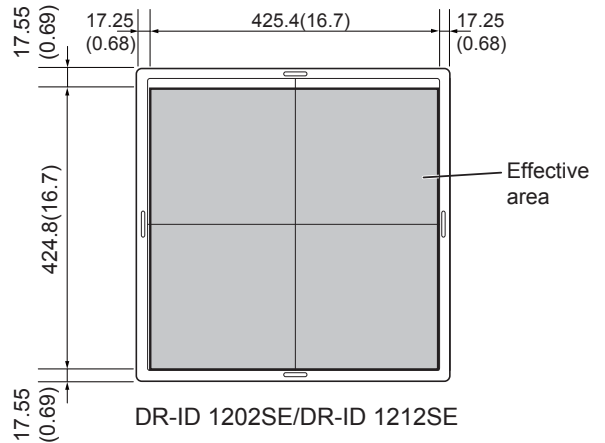

DR-ID 1202SE/DR-ID 1212SE

■ DR-ID 1200MC *

	Width (mm(in.))	Depth (mm(in.))	Height (mm(in.))	Weight (kg(lb))
Control cabinet	114(4.5)	353(13.9)	399(15.7)	8.3(18.3)

* The exterior, external dimensions and weight are examples since this is a general-purpose electric device.

Unit: mm(in.)

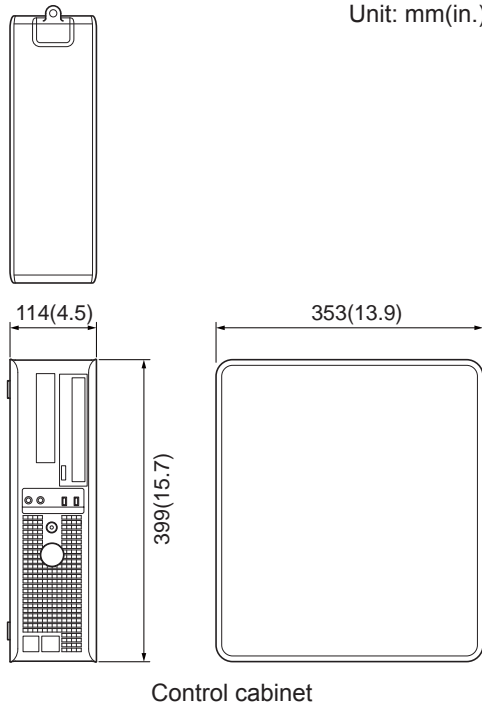

■ Battery charger (optional)

	Width (mm(in.))	Depth (mm(in.))	Height (mm(in.))	Weight (kg(lb))
Battery charger	92.5(3.6)	259(10.2)	56(2.2)	0.6(1.3)
AC adapter	153(6.0)	67(2.6)	35(1.4)	Approx.0.51(1.1)

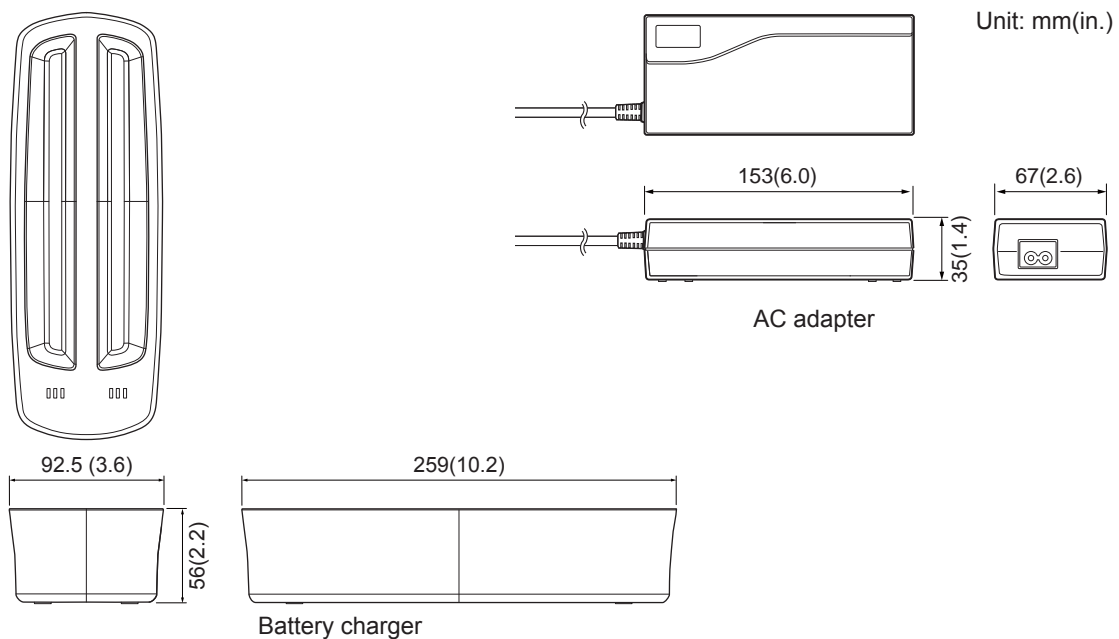

■ Access point (optional)

	Width (mm(in.))	Depth (mm(in.))	Height (mm(in.))	Weight (kg(lb))
Access point	39(1.5)	95(3.7)	27(1.1)	Less than approx. 0.1(0.2)

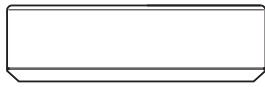

Unit: mm(in.)

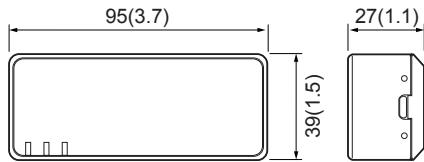

Access point

A.3 Characteristics

(1) Sensitometric Response Characteristics and Dynamic Range

FDR D-EVO II has a linear response against the exposure range where it can depict the clinical information. The flat panel sensor covers a dynamic range of 0.088 - 88 μ Gy at least at RQA5.

(2) Spatial Resolution Properties

A typical MTF value of DR-ID 1201SE/DR-ID 1202SE at 1cyc/mm, RQA5 is 0.75 (high sharpness mode) and 0.60 (standard sharpness mode).

A typical MTF value of DR-ID 1211SE/DR-ID 1212SE at 1cyc/mm, RQA5 is 0.80.

The level of uncertainty is estimated as less than $\pm 10\%$

(3) DQE (Detective Quantum Efficiency)

Typical DQE value of DR-ID 1201SE/DR-ID 1202SE at 8.8 μ Gy in 1cyc/mm is 0.30.

Typical DQE value of DR-ID 1211SE/DR-ID 1212SE at 8.8 μ Gy in 1cyc/mm is 0.54.

The level of uncertainty is estimated as less than $\pm 10\%$

(4) Display

To deliver the detector characteristics above, it is recommended to use a monitor with the following specifications:

- Image matrix size : Minimum 2336x2836 pixels (DR-ID 1201SE/DR-ID 1211SE)
- Image matrix size : Minimum 2832x2836 pixels (DR-ID 1202SE/DR-ID 1212SE)
- Gray scale: Minimum 12 bit
- DICOM calibrated

(5) Image Quality Evaluation

Fujifilm typically conducts reader studies that compare new FDR D-EVO II detector models to chosen marketed devices. These studies, involving an assessment of image quality by board-certified radiologists, have demonstrated that the images acquired using the FDR D-EVO II detectors are deemed to be of diagnostic capability. Additionally, reader studies have concluded that, when used in conjunction with FUJIFILM's recommended exposure conditions as a reference, both the GOS-based and Csl-based FDR D-EVO II detectors can provide acceptable diagnostic capability and image quality at reasonably low dose levels typically used for pediatric use.

(6) Typical Patient Dose

As with any new product/application, Fujifilm provides applications training support to each customer to establish the dose levels that meet the image quality standards of the medical facility. As part of this training, we provide both recommended technique charts as well as guidance for optimizing AEC conditions for each detector type. When using any FDR D-EVO II detector, typical patient dose levels should not exceed that of screen/film or Computed Radiography.



Appendix Z Precautions for Exposure

Z.1 Precautions for Exposure in AUTO MODE

In AUTO MODE, stable image output can be obtained by means of the following.

- (1) Radiation field
- (2) EDR image data analysis
- (3) Detailed depiction of the cervical region

However, problems may arise due to differences in the multiple diaphragms or scattered rays of the X-ray equipment. For such problems, contact our official dealer or FUJIFILM Representative and use other recording modes, such as SEMI-AUTO MODE or FIX MODE.

Z.1.1 Radiation Field

- 1 Do not set the radiation field extremely small. Be sure to subject one-third or more of the length of each side of the bucky of the DR system to X-ray exposure.
- 2 Make sure that none of the sides of the radiation field overlap with the contrast medium. Errors will result if they overlap.

Available for Each Anatomical Region/Method

	Plain	Contrast Medium	Tomography
Head	4	4	4
Neck	4	4	–
Chest	4	4 (1 for esophagus)	–
Abdomen	4	4 (1 for stomach and intestines)	–
Pelvis	4	4	–

3 Notes on PRIEF

- [PRIEF 4] Used, with some exceptions, for both plain and contrast medium exposure menus, from the head to the pelvis.
The diaphragm shape will be any convex polygon, including rectangles, circles, ellipses, tracks, etc.

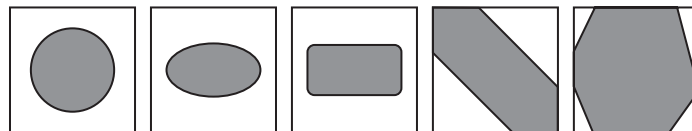

- [PRIEF 1] Used with esophagus, stomach and intestines contrast medium menus.

Z.1.2 Depiction of the Cervical Region

- 1 The radiation field must not include the whole head. Be sure to secure transparent portions on both sides of the neck.

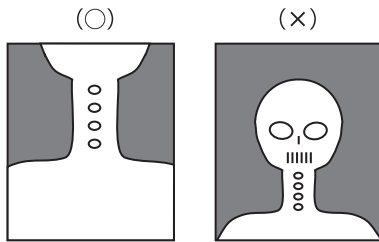

Use the “Head” menu to include the whole head in the radiation field.

- 2 For exposure of the pharynx or larynx, be sure that the neck comes to the center of the radiation field so that the frontal and lateral orientations can be recognized appropriately.

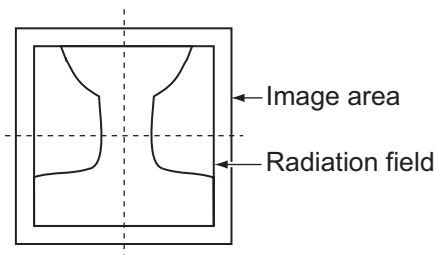

- 3 In pharynx and/or larynx exposure, do not use lead characters in the oblique line section.

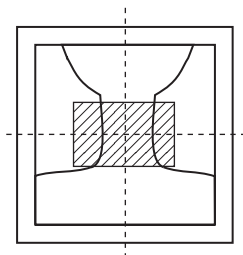

Z.1.3 Depiction of the HIP JOINT AXL – 2 Menu

- 1 Make sure to position the region of interest within the slanted-line area shown below. Do not collimate further inside.
- 2 Positioning should be done so that the condyle and the femur run along the longer edge. (Do not position them against the shorter edge.)

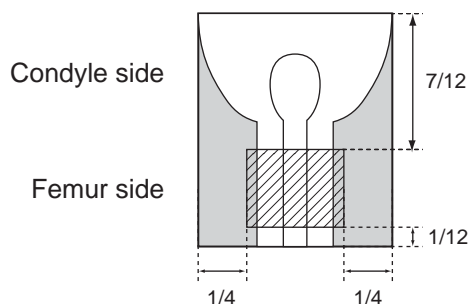

Z.1.4 EDR Image Data Analysis

- 1 Image unevenness due to grid misalignment, X-ray beam misalignment, or shadow of clothes may cause EDR image data analysis problems resulting in unstable density on the image.
- 2 If the target includes such materials as gypsum, denture, etc., stable density may not be obtained, because such materials make it difficult to analyze EDR image data.
In such cases, use FIX MODE.
- 3 The EDR performs processing for the image area trimmed by the DR system.
When using lead characters or metals for measurement, place them inside the radiation field, and then make an exposure.
- 4 Precautions when using AUTO MODE.

Auto mode	Precautions
I	As this mode is available for extracting information on the skin, secure the positioning so that the direct X-rays are incident to an area other than the target.
II	No special precautions.
III	Be sure to use a Ba contrast medium.
IV	1 Be sure to secure the positioning so that the X-rays are incident to the area directly outside the target. 2 As the reading latitude is fixed, it is necessary to control the tube voltage according to the thickness of the target, as usual.
V	As the reading latitude is fixed, it is necessary to control the tube voltage according to the thickness of the target, as usual.
VI	No special precautions.
VII	No special precautions.

Z.2 Precautions for Exposure in SEMI-AUTO MODE

These precautions are common to Semi I, II, III and III(**).

- 1 Position the portion you need to display often in the center areas (10cm × 10cm(3.9 in. × 3.9 in.) (Semi I), 7cm × 7cm(2.8 in. × 2.8 in.) (Semi II), 5cm × 5cm(2.0 in. × 2.0 in.) (Semi III)) of the images trimmed by the DR system.

Position the portion you need to display often in each of the 5cm × 5cm(2.0 in. × 2.0 in.) center areas of the half-split images (both upper and lower halves and right and left halves) and quarter-split image trimmed by the DR system.

- 2 Never position anything other than the subject in the aforementioned areas. If anything other than the subject is positioned in such areas, the image density will become lower.

In addition, do not position any metals or artificial bones in such areas. The image density will become higher if such objects are positioned in these areas.

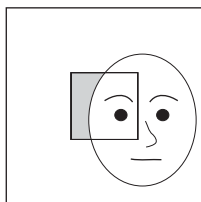

(×)

- 3 It is necessary to control tube voltage according to subject thickness, as usual.

The following precautions should be observed for Semi IV.

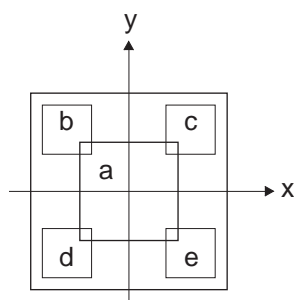

Area	Center Coordinate (x:y) cm(in.)	Size (cm(in.))
a	(0(0), 0(0))	10 × 10(3.9 × 3.9)
b	(-5(-2.0), 7(2.8))	6 × 6(2.4 × 2.4)
c	(5(2.0), 7(2.8))	6 × 6(2.4 × 2.4)
d	(-5(-2.0), -7(-2.8))	6 × 6(2.4 × 2.4)
e	(5(2.0), -7(-2.8))	6 × 6(2.4 × 2.4)

- (1) Do not position transparent portions (areas other than the subject) in the aforementioned five areas.

- (2) It is necessary to control tube voltage according to subject thickness, as usual.

- ⦿ For details of the menus preset in SEMI-AUTO MODE, see the “DR-ID 300CL Operation Manual” and “DR-ID 300CL Reference Guide (Image Processing Parameters)”.

Z.3 Precautions for Exposure in SEMI-X MODE

The user will select one of the nine areas of the image trimmed by the DR system, on which SEMI-AUTO MODE applies. (See the illustration below.)

The same precautions as for SEMI-AUTO MODE apply.

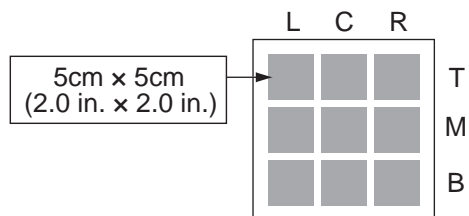

Z.4 Precautions for Exposure in FIX MODE

As reading conditions are fixed, exposure conditions must be controlled in the same way as for conventional X-ray exposure.

The reading conditions (sensitivity and latitude) have been preset according to the relevant menu in FIX MODE. Select the exposure conditions which correspond to that menu accordingly.

Z.5 Precautions for the Automatic X-ray Detection Function

Z.5.1 Precautions for Making an Exposure

- 1 The flat panel sensor cannot detect X-rays automatically unless Shot Ready (exposure ready status indicator) on the image processing unit, the READY lamp among the status lamps on the flat panel sensor, or the READY lamp on the docking stand is lit green. Even if the indicator is not lit green, radiation can be delivered but an image will not be output. Make sure that the indicator is lit green before making an exposure.
- 2 Check the tube current of the X-ray equipment in advance, and set exposure conditions based on the tube current by referring to the table below. If the conditions are not met, X-rays cannot be detected automatically and an image may not be acquired.

Tube current	Tube voltage	Exposure time	SID	Radiation field
More than 40 mA	Set the tube voltage according to the anatomical region and body thickness.	More than 1 ms (*3)	Set the SID according to the anatomical region.	Do not limit the radiation field to the bone region (*1) only.
More than 20 mA and less than 40 mA	Set the tube voltage to more than 50 kV according to the anatomical region and body thickness.		Set the SID to 100 cm (39.4 in.) or less and do not limit the radiation field to the bone region (*1) only. Alternatively, set the SID according to the anatomical region and include the directly exposed area (*2).	
More than 10 mA and less than 20 mA			100 cm (39.4 in.) or less	Include the directly exposed area (*2).
Less than 10 mA	The automatic X-ray detection function cannot be used.			

*1 When making an exposure, for example, for a finger or knee, set the radiation field to at least 6 cm × 10 cm (2.4 in. × 3.9 in.) for the former and at least 10 cm × 10 cm (3.9 in. × 3.9 in.) for the latter, so that the field is not limited to the bone region only.

*2 The areas of the flat panel sensor, which are directly exposed to X-rays that do not pass through the subject, must have a width of more than 3 cm (1.2 in.) from the subject.

*3 Depending on the X-ray equipment, the actual exposure time may differ from the set time. Before use, make sure that the flat panel sensor can detect X-rays automatically.

- 3 As illustrated below, if the subject whose thinnest part is at least 40 cm (15.7 in.) in thickness covers the entire surface of the flat panel sensor, it cannot detect X-rays automatically and an image may not be acquired. In this case, make an exposure for the region including the directly exposed area or switch to the High Sensitivity Mode. While the high sensitivity mode is being set, a shock might cause a blank image.

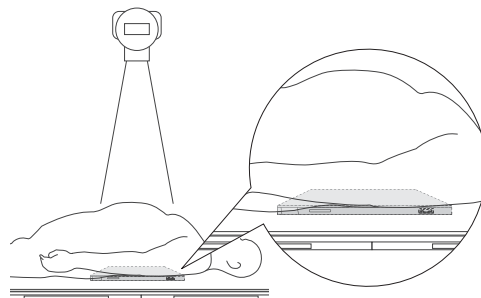

Figure of an exposure for the subject covering the entire surface of the flat panel sensor

- 4 When an exposure menu is registered and the system is ready for an exposure, the flat panel sensor enters X-ray detection mode. If an exposure is not made for a period of time while an exposure menu is registered, the operating time of the flat panel sensor's battery pack may be reduced to half. In addition, the battery pack cannot be charged with an exposure menu registered, even if the flat panel sensor has a wired connection. For these reasons, do not keep the system on standby, unless you make an exposure.

Z.5.2 Precautions Related to the X-ray Exposure Time

When delivering radiation, do not set the exposure time beyond the maximum limit specified for the flat panel sensor at the time of installation. Otherwise, vertical artifacts may appear in the image.

Z.6 Precautions for Use in Wireless Communication Mode

Care should be taken when the devices are used in wireless communication mode. Thoroughly read the following precautions in order to use the devices properly.

■ Icons Displayed on the Image Processing Unit

An icon indicating the status of wireless communication is displayed in the connected devices status at the lower right of the image processing unit display. Before an exposure is made, check the displayed icon to make sure that proper wireless communication is established.

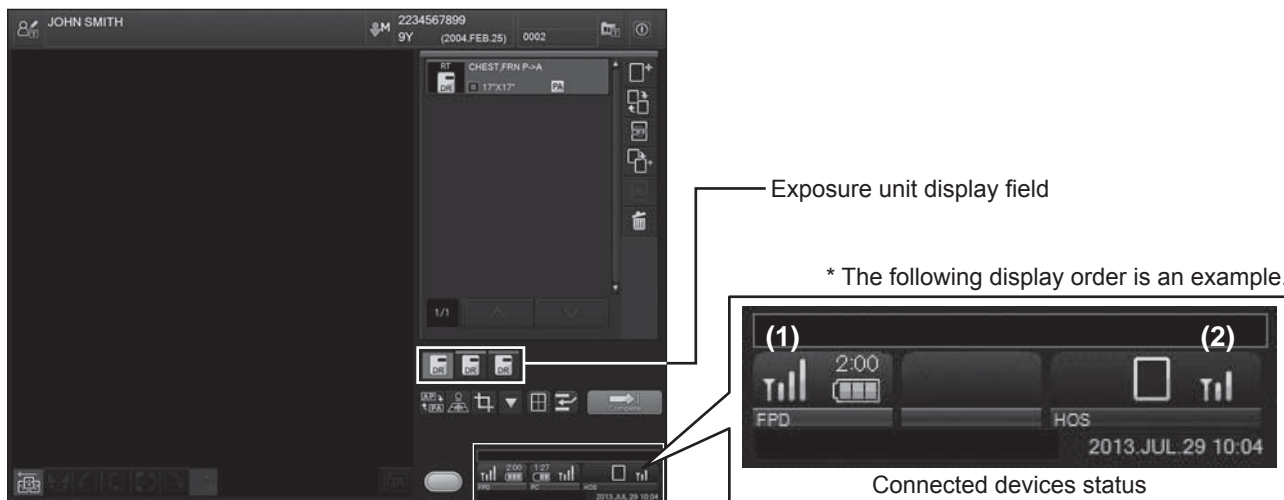

(1) Exposure unit communication indicator

The wireless communication status of the flat panel sensor assigned to the selector is displayed.

(2) Hospital wireless communication indicator

Displays the status of wireless communication between the image processing unit and the in-hospital LAN.

Details on the icons regarding wireless communication displayed in the areas (1) and (2) are as follows.

Icon	Description	Display Area
	Communication is established. The radio wave strength is displayed in four levels. While is displayed, wireless communication or image transfer to the hospital LAN becomes unstable.	(1) and (2)
	Exposure is not available. (Communication with the flat panel sensor is disconnected.)	(1)
	Wireless communication is not available. (Since the radio wave strength is weak, wireless communication cannot be used. If this icon is displayed in the area (1), exposures cannot be made.)	(1) and (2)
	Information on the radio wave strength is being received.	(1)
	The in-hospital LAN connection is being switched.	(2)

For details on other icons, see the “Console Advance (DR-ID 300CL) Reference Guide”.

Z.7 Other Precautions

Z.7.1 Precautions for Exposure of a Subject in Relatively Large Contrast

- 1 Exposures using a contrast medium may cause artifacts around it.
- 2 When exposing a subject with any metal objects implanted, artifacts may appear around them.
- 3 For exposures with objects of large X-ray absorption, such as lead characters and metals for measurement, artifacts may appear around them. Place such objects outside a subject.

Z.7.2 Precautions for Flat Panel Sensor

Generally, when performing a high sensitivity exposure shortly after an exposure that the flat panel sensor excessively receives direct X-ray, the output image may contain image lags of the previous exposure. This phenomenon rarely occurs and does not occur insofar as normal sensitivity exposures are performed.

Exposures at longer intervals can reduce occurrences of this phenomenon. Also observe precautions as follows.

- Continuous high sensitivity exposures to vertebral body part (chest/lumbar spine) should be performed at longer intervals than normal exposures.
- A high sensitivity exposure shortly after a high-dose exposure should be performed at sufficiently long interval.
- When performing high-dose exposures repeatedly, do not use collimation of the radiation field, lead characters or metals for measurement at the same position.

Z.7.3 Precautions for Assuring the Radiation Field



CAUTIONS

- **It is important to read the following before using the FDR D-EVO II digital detector clinically.**
- **Do not make the radiation field larger than the size of the flat panel sensor. Especially when the high tube voltage is set, the radiation field size should not be larger than the subject unless necessary.**

The FDR D-EVO II is a digital X-ray detector designed for use both within and outside of a standard radiographic bucky. Radiation field can be set up to 14" × 17" (DR-ID 1201SE/DR-ID 1211SE) or up to 17" × 17" (DR-ID 1202SE/DR-ID1212SE) and this product may be used with the X-ray equipment in any situation where a film cassette may be used.

The collimator will open up to 14"× 17" for DR-ID 1201SE/DR-ID 1211SE and 17"× 17" for DR-ID 1202SE/DR-ID 1212SE, when the FDR D-EVO II cassette is inserted in the bucky tray of the X-ray equipment with positive beam limitation (PBL).

Follow the X-ray system manufacturer's instructions to assure the indicated field size matches and does not exceed the actual radiation field size for the available range of SIDs.

Z.7.4 Images Output When the X-ray Shot Switch is Operated Incorrectly

In case that you press the X-ray shot switch only momentarily after selecting exposure menus, sufficient X-ray dose may not be achieved. The output image contains image lags of the previous exposure occasionally.

If this happens, select exposure menus again, and then make an exposure.

Z.7.5 Precautions for Urgent Use

When you start a study before completion of the calibration at the time of startup, the operation will be in Urgent Use Mode. At this time, “Urgent use is possible” appears in the “Output Device Status window” of the image processing unit.

- There is no guarantee that the image taken in Urgent Use Mode can be used for diagnostic purposes. Vertical artifact could appear in the image, if the temperature difference is large from the previous shutdown of the system. Check the image quality before use.
- Move from the Study Screen to the Patient Information Input Screen immediately after exiting Urgent Use Mode, so that the calibration will start over automatically.

Z.7.6 Precautions Related to Continuous Operation

If you plan to continuously run the system for over 24 hours, perform post-operation check, and then restart the system.

Otherwise, calibration will not be performed normally, and image quality cannot be guaranteed as a result.

Z.7.7 Precautions Related to Grid

Depending on the type of the grid used, its stripes may appear in the image after making an exposure. To avoid such moire effects, sway the grid from side to side, or use the Grid Pattern Removal Processing Software in conjunction with the grid with 40 lines.

Z.7.8 Precautions during Calibration

Observe the following when the READY status lamp on the flat panel sensor is blinking or when the message “Calibrating...” is displayed on the image processing unit.

- Do not subject the flat panel sensor to shock.
- Do not deliver radiation.
- Do not connect/disconnect the flat panel sensor to/from the power supply unit or to/from the docking stand.

Z.7.9 Precautions for Exposing the Flat Panel Sensor to X-ray

When you expose the flat panel sensor to X-ray at any other time except during radiography, artifacts could appear in the image. If artifacts appeared in the image due to X-ray irradiation, perform a test X-ray radiography after waiting for more than 2 minutes and then restart exposure after confirming that the artifacts disappear.

Z.7.10 Precautions for Extended Image Readout

If any impact is applied to the flat panel sensor while an image is being acquired with Extended Image Readout, artifacts may appear in the image. Before removing the flat panel sensor from the radiographic examination stand, be sure to check the acquired image on the image processing unit. In addition, note that when Extended Image Readout is enabled, the system cannot be used in an emergency since the system start-up time becomes longer.

Z.7.10 Precautions for Using the Access Point

When making an exposure with the access point, do not remove the USB cable until the image appears on the image processing unit and ShotReady lights green.

Also, with the supplied Velcro tape and clamp or by other means, secure the USB cable before use to prevent it from being disconnected accidentally.

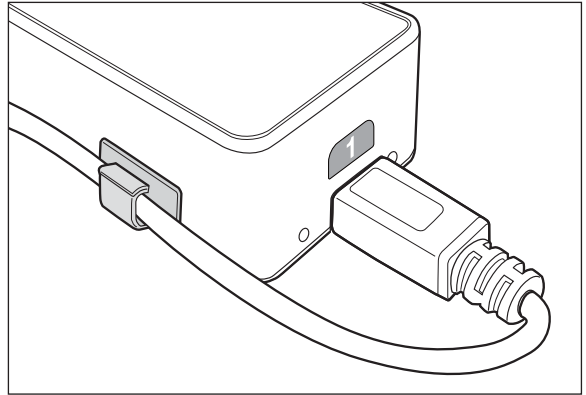
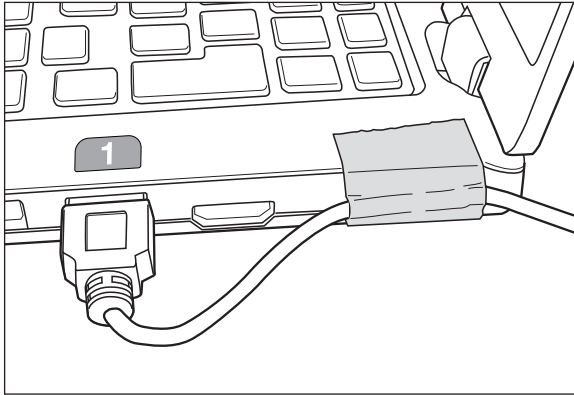

Appendix O Use of Optional Items

O.1 Optional Items

Name	Description
SE storage case	A case used for carrying and storing the flat panel sensor. ▶ For the external view and precautions, see “O.2 Using the SE Storage Case” (page O-2).
Battery pack	A battery pack for the flat panel sensor. ▶ For precautions, charging and installing/removing, see pages 1-8, 1-9, 3-6, 3-7 and 3-8.
Battery charger	A battery charger for the battery pack. ▶ For precautions, external view and charging, see pages 1-8, 1-9, 2-5, 3-6 and 3-7.
Retaining bracket for MP	A set of an anchor and a fixture, which is used for securing the power supply unit to the floor. ▶ For the external view, see “O.3 Using the Retaining bracket for MP” (page O-3).
SE cable	A cable that connects the flat panel sensor and the power supply unit. This cable is used for adding the second and subsequent flat panel sensors, changing over the connection between the flat panel sensors, and other usages.
Relay unit for AC bucky	A relay unit consisting of the relay and terminal block for the AC bucky. Four types are available : For 100V, 120V, 200V, and 220V
Magnetic clamp for flat panel sensor cable	A clamp for fixing the SE cable to the radiographic examination stand, etc.
Adapter for the docking stand	An adapter used for attaching the flat panel sensor to the docking stand.
DS Anchor Fixing Bracket	An anchor and fixing tool set used for fixing the docking stand to the floor. ▶ For the external view, see “O.4 DS Anchor Fixing Bracket” (page O-4).
Wall Fixing Bracket	An anchor and fixing tool set used for fixing the docking stand to the floor. ▶ For the external view, see “O.5 Wall Fixing Bracket” (page O-5).
SE communication cable	A cable used for connecting the flat panel sensor and the optional access point. This cable is used for wired communication if wireless communication is not available. In addition, this cable is used for registering or recognizing the flat panel sensor. Cable length : Approx. 1m (3.3 ft)
Access point	An access point used for wireless communication between the flat panel sensor and the image processing unit.

O.2 Using the SE Storage Case

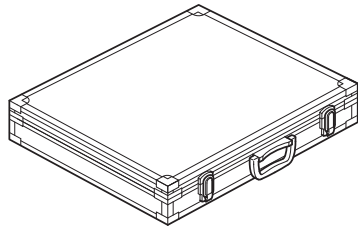

SE storage case for 35
(DR-ID 1201SE/DR-ID 1211SE)

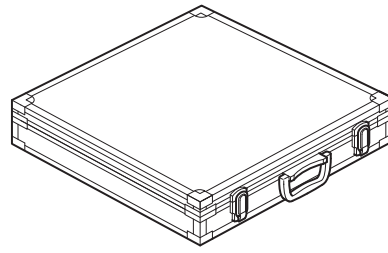

SE storage case for 43
(DR-ID 1202SE/DR-ID 1212SE)



CAUTIONS

- Do not store the SE storage case in a location with the following conditions.
 - Where the SE storage case is exposed to direct sunlight.
 - Where the temperature and humidity change dramatically.
 - Where there is excessive dust.
 - Where chemicals are stored.
 - Where the SE storage case may be exposed to water due to water leakage or ingress.
- Store the flat panel sensor and the cable properly in the SE storage case. Otherwise, they may be caught under the case lid and damaged.
- Do not connect the flat panel sensor to the SE cable or SE communication cable while it is stored in the SE storage case.
- Do not store anything other than the flat panel sensor in the SE storage case.
- Carefully carry the SE storage case when the flat panel sensor is inside.
- The SE storage case and/or the flat panel sensor inside may be damaged if the case is subject to an impact.
- Do not open/close the SE storage case in a location where there is excessive dust or dirt.
- Do not put the SE storage case on an unstable place. If it falls or drops, personal injury may result.
- Be careful not to have your hand or an object caught when closing the SE storage case.

When storing the flat panel sensor in the SE storage case, place it with the exposure plane down. For details, see the illustrations below.

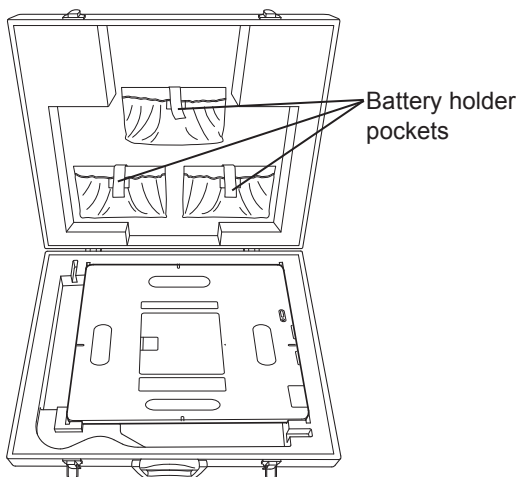

SE storage case for 35
(DR-ID 1201SE/DR-ID 1211SE)

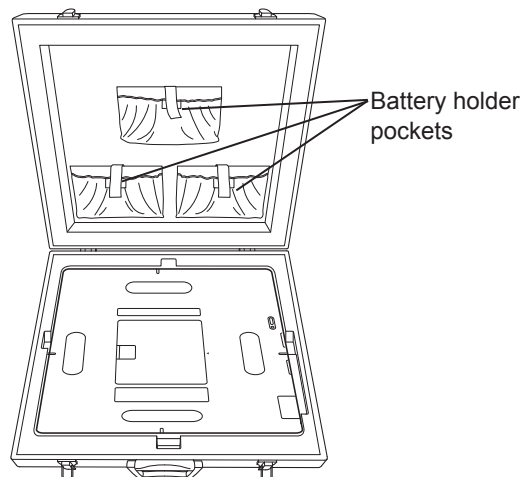

SE storage case for 43
(DR-ID 1202SE/DR-ID 1212SE)

O.3 Using the Retaining Bracket for MP

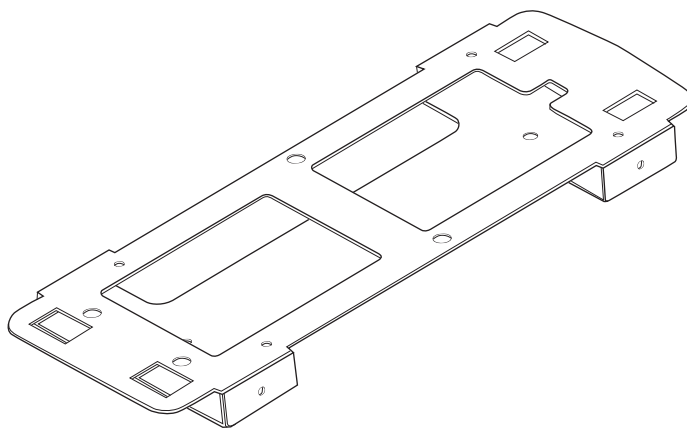

Contact a FUJIFILM dealer for installation of the Retaining bracket for MP.

O.4 DS Anchor Fixing Bracket

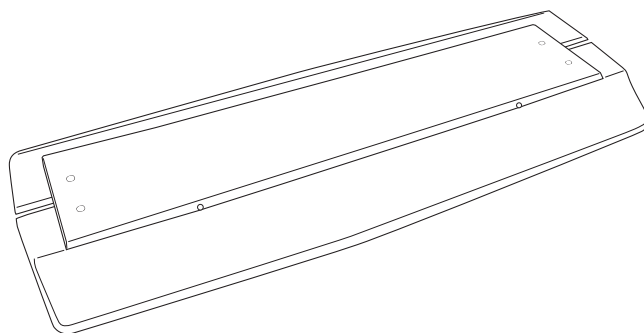

Contact a FUJIFILM dealer for installation of the DS anchor fixing bracket.

O.5 Wall Fixing Bracket

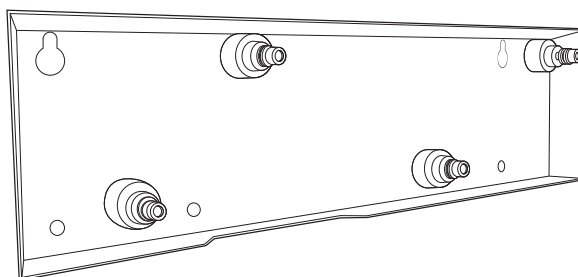

Contact a FUJIFILM dealer for installation of the wall fixing bracket.

O.6 Access Point

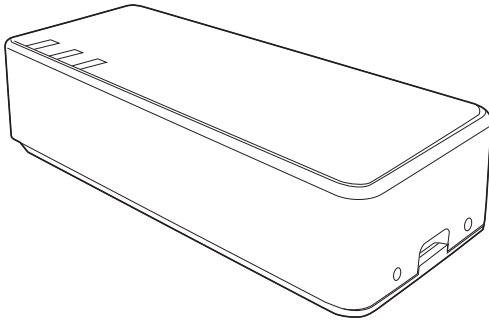

Precautions for Use



CAUTIONS

- The Access Point incorporates a wireless device that complies with the technical standards. Do not disassemble or modify the Access Point. In addition, do not remove the name plate attached to this product. If the name plate is not attached, use of this product is prohibited.
- Use of the Access Point is allowed in the area of purchase.
- Make sure that there are no shielding materials between the Access Point and the communication device. For example, if there is a metal plate or concrete wall between them, wireless communication may not be available. In addition, do not cover the plane with the status lamps.
- Do not use the Access Point near the following devices.
 - Industrial, scientific and medical equipment such as a microwave oven, pacemaker, etc.
 - Local private radio stations for mobile object identification used in factory production lines, etc. (radio stations requiring a license)
 - Specified low power radio stations (radio stations requiring no license)
- Do not use the Access Point near radios, televisions, mobile phones or PHS phones as far as possible. If these devices are placed near the wireless LAN products, audio or video noise may occur due to electromagnetic waves generated from the wireless LAN products including the Access Point.
- Do not use the Access Point near a heat source. In addition, do not cover the ventilation holes.
- Do not allow the Access Point get wet or dusty.
- Take care not to trip over the cable. If the cable is disconnected or almost disconnected, wireless communication may not be established.
- Do not subject the Access Point to severe shock (by dropping it, etc.).
- When using the Access Point, place it at least 20cm (7.9in.) away from the body.
- To supply power to the Access Point, connect it to the FUJIFILM-specified personal computer supporting USB 3.0.
- Use the Access Point by connecting it to the preset image processing unit and to the USB connector.
- Directly connect the Access Point and the image processing unit only with the supplied USB cable. Do not use a hub for connection.
- Do not delete or change the USB driver installed in the image processing unit.
- Do not place the supplied Velcro tape over the Access Point Product Label and Access Point Radio Law Certification Label.

Precautions for LAN Connection



CAUTIONS

- For the LAN connection, use the dedicated LAN conversion cable. In addition, when connecting or disconnecting the LAN conversion cable, be sure to hold the connector portion. If it is connected or disconnected while holding the cable, the cable may be broken.
- Radio waves available outdoors vary, depending on the country where the system is used. (For U.S.)
Radio waves in the 5.2GHz frequency band can be used indoors only.
When radio waves in the 5.3GHz and 5.6GHz frequency bands are selected, the DFS function will operate.
- When the Access Point and a personal computer is connected using the USB cable, do not connect the Access Point and the personal computer via the LAN connection.

Precautions for Using the DFS (Dynamic Frequency Selection) Function



CAUTIONS

- The Access Point supports the DFS function conforming to IEEE 802.11n. If a radar wave is detected while setting a channel, the channel may be changed automatically in order to avoid interference to weather radar, etc.
- During start-up, the Access Point checks if there are any radar waves. While the check is in progress, communication with the Access Point is not available.
- If a radar wave is detected, the radar wave is monitored for a specified time (about 1 minute). While monitoring the radar wave, wireless communication is not available. In addition, about 30 minutes are required until the channel in which a radar wave was detected becomes available.

- For details of the access point, see "Access point Operation Manual".



Maintenance and Inspection

1 Maintenance and Inspection Items Assigned to Specified Dealer

For periodical inspection of the equipment and necessary arrangements, consult our official dealer or local representative.

Periodical Maintenance

Make sure that the periodical maintenance and inspection assigned to our official dealer or FUJIFILM Representative are performed as specified.

Maintenance and Inspection Items Assigned to Specified Dealer

Periodical Maintenance and Inspection Items	Period
Checking of the image	Every year
Checking of the operation record by referring to the error log	Every year
Checking of the units	Every 2 years

Main Periodical Replacement Parts

Name of Periodical Replacement Parts	Period
Relay (optional)	Every 1 year (Number of exposures : 90,000)

* It is recommended that the battery pack be replaced, if the battery storage capacity becomes lower than 60%.

The battery pack should be replaced when the operable time is less than the following.

- DR-ID 1201SE/DR-ID 1202SE/DR-ID 1211SE/DR-ID 1212SE: 100 minutes (1 hour and 40 minutes)
- * Refer to the operable time displayed on the image processing unit when the battery pack is fully charged and no exposure menu is registered.
- * Depending on the usage environment, etc., the displayed time is slightly different from the actual operable time.

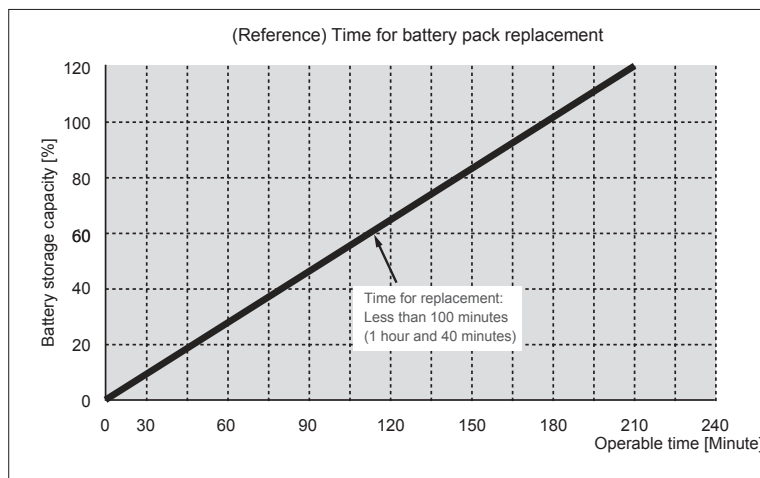

The cycles of periodical maintenance and inspection and of parts replacement differ depending on the usage and the daily operation time.

For details, contact our official dealer or FUJIFILM Representative.

Radio frequency (RF) compliance information

Compliance with 1999/5/EC

Manufacturer's Name: FUJIFILM Corporation
Manufacturer's Address: 26-30, Nishiazabu 2-Chome, Minato-Ku, Tokyo 106-8620 JAPAN

declares that the product:

Product Name: PANEL UNIT
Model Number: DR-ID 1200PU
(DR-ID 1200MP, DR-ID 1201SE, DR-ID 1202SE, DR-ID 1211SE and DR-ID 1212SE)
DR-ID 1200DU
(DR-ID 1200DS, DR-ID 1201SE, DR-ID 1202SE, DR-ID 1211SE and DR-ID 1212SE)

The product complies with the requirements of the R&TTE Directive 1999/5/EC.

The formal "Declaration of Conformity" can be obtained in the following-mentioned address.
Address: 798, Miyanodai, Kaisei-machi, Ashigarakami-gun, Kanagawa 258-8538 JAPAN

The shipment schedule country is as follows.

AT	BE	BG	CH	CY
CZ	DE	DK	EE	ES
FI	FR	GB	GR	HR
HU	IE	IS	IT	LI
LT	LU	LV	MK	MT
NL	NO	PL	PT	RO
SE	SI	SK	TR	



[BG] Bulgarian	С настоящето, FUJIFILM, декларира, че DR-ID 1200PU, DR-ID 1200DU е в съответствие със съществените изисквания и другите приложими разпоредби на Директива 1999/5/EC.
[CS] Czech	FUJIFILM tímto prohlašuje, že DR-ID 1200PU, DR-ID 1200DU splňuje základní požadavky a všechna příslušná ustanovení Směrnice 1999/5/ES.
[DA] Danish	Undertegnede FUJIFILM erklærer herved, at følgende udstyr DR-ID 1200PU, DR-ID 1200DU overholder de væsentlige krav og øvrige relevante krav i direktiv 1999/5/EF.
[DE] German	Hiermit erklärt FUJIFILM, dass sich das Gerät DR-ID 1200PU, DR-ID 1200DU in Übereinstimmung mit den grundlegenden Anforderungen und den übrigen einschlägigen Bestimmungen der Richtlinie 1999/5/EG befindet.
[EN] English	Hereby, FUJIFILM, declares that this DR-ID 1200PU, DR-ID 1200DU is in compliance with the essential requirements and other relevant provisions of Directive 1999/5/EC.
[ES] Spanish	Por la presente, FUJIFILM, declara que este DR-ID 1200PU, DR-ID 1200DU cumple con los requisitos esenciales y otras exigencias relevantes de la Directiva 1999/5/EC.

[ET] Estonian	Käesolevaga kinnitab FUJIFILM seadme DR-ID 1200PU, DR-ID 1200DU vastavust direktiivi 1999/5/EÜ põhinõuetele ja nimetatud direktiivist tulenevatele teistele asjakohastele sätetele.
[FI] Finish	FUJIFILM vakuuttaa täten että DR-ID 1200PU, DR-ID 1200DU tyyppinen laite on direktiivin 1999/5/EY oleellisten vaatimusten ja sitä koskevien direktiivin muiden ehtojen mukainen.
[FR] French	Par la présente, FUJIFILM déclare que l'appareil DR-ID 1200PU, DR-ID 1200DU est conforme aux exigences essentielles et aux autres dispositions pertinentes de la directive 1999/5/CE.
[EL] Greek	ΜΕ ΤΗΝ ΠΑΡΟΥΣΑ Ο ΚΑΤΑΣΚΕΥΑΣΤΗΣ FUJIFILM ΔΗΛΩΝΕΙ ΟΤΙ DR-ID 1200PU, DR-ID 1200DU ΣΥΜΜΟΡΦΩΝΕΤΑΙ ΠΡΟΣ ΤΙΣ ΟΥΣΙΩΔΕΙΣ ΑΠΑΙΤΗΣΕΙΣ ΚΑΙ ΤΙΣ ΛΟΙΠΕΣ ΣΧΕΤΙΚΕΣ ΔΙΑΤΑΞΕΙΣ ΤΗΣ ΟΔΗΓΙΑΣ 1999/5/ΕΚ
[HU] Hungarian	A FUJIFILM ezzennel kijelenti, hogy a DR-ID 1200PU, DR-ID 1200DU típusú berendezés teljesíti az alapvető követelményeket és más 1999/5/EK irányelvben meghatározott vonatkozó rendelkezéseket.
[HR] Croatian	Ovime, FUJIFILM, potvrđuje da je DR-ID 1200PU, DR-ID 1200DU u skladnost sa osnovnim zahtjevima i drugim važnim odredbama Direktive 1999/5/EC.
[IS] Icelandic	Hér með lýsir FUJIFILM yfir því að DR-ID 1200PU, DR-ID 1200DU er í samræmi við grunnkröfur og aðrar kröfur, sem gerðar eru í tilskipun 1999/5/EC
[IT] Italian	Con la presente FUJIFILM dichiara che questo DR-ID 1200PU, DR-ID 1200DU è conforme ai requisiti essenziali ed alle altre disposizioni pertinenti stabilite dalla direttiva 1999/5/CE.
[LV] Latvian	Ar šo FUJIFILM deklarē, ka DR-ID 1200PU, DR-ID 1200DU atbilst Direktīvas 1999/5/EK būtiskajām prasībām un citiem ar to saistītajiem noteikumiem.
[LT] Lithuanian	Šiuo FUJIFILM deklaruoja, kad šis DR-ID 1200PU, DR-ID 1200DU atitinka esminius reikalavimus ir kitas 1999/5/EB Direktyvos nuostatas
[MK] Macedonian	FUJIFILM, изјавува дека овој DR-ID 1200PU, DR-ID 1200DU е во согласност со суштинските барања и други релевантни одредби на Директивата 1999/5/EC.
[MT] Maltese	Hawnhekk, FUJIFILM, jiddikjara li dan DR-ID 1200PU, DR-ID 1200DU jikkonforma mal-ħtiġijiet essenzjali u ma provvedimenti oħrajn relevanti li hemm fid-Dirrettiva 1999/5/EC.
[NL] Dutch	Hierbij verklaart FUJIFILM dat het toestel I DR-ID 1200PU, DR-ID 1200DU in overeenstemming is met de essentiële eisen en de andere relevante bepalingen van richtlijn 1999/5/EG.
[NO] Norwegian	FUJIFILM erklærer herved at utstyret DR-ID 1200PU, DR-ID 1200DU er i samsvar med de grunnleggende krav og øvrige relevante krav i direktiv 1999/5/EF.
[PL] Polish	Niniejszym FUJIFILM deklaruje że DR-ID 1200PU, DR-ID 1200DU jest zgodny z zasadniczymi wymaganiami i innymi właściwymi postanowieniami Dyrektywy 1999/5/EC.
[PT] Portuguese	Eu, FUJIFILM, declaro que o DR-ID 1200PU, DR-ID 1200DU cumpre os requisitos essenciais e outras provisões relevantes da Directiva 1999/5/EC.

[RO] Romanian	Prin prezenta, FUJIFILM, declară că aparatul DR-ID 1200PU, DR-ID 1200DU este în conformitate cu cerințele esențiale și cu alte prevederi pertinente ale Directivei 1999/5/CE.
[SK] Slovak	FUJIFILM týmto vyhlasuje, že DR-ID 1200PU, DR-ID 1200DU spĺňa základné požiadavky a všetky príslušné ustanovenia Smernice 1999/5/ES.
[SL] Slovenian	FUJIFILM izjavlja, da je ta DR-ID 1200PU, DR-ID 1200DU v skladu z bistvenimi zahtevami in drugimi relevantnimi določili direktive 1999/5/ES.
[SV] Swedish	Härmed intygar FUJIFILM, att denna DR-ID 1200PU, DR-ID 1200DU är förenligt med de grundläggande kraven och andra relevanta bestämmelser i direktivet 1999/5/EG.
[TR] Turkish	İşbu belge ile FUJIFILM, bu DR-ID 1200PU, DR-ID 1200DU ürününün 1999/5/EC sayılı Yönerge'nin temel şartlarıyla ve diğer ilgili hükümleriyle uyumlu olduğunu beyan eder.

FUJIFILM



Manufacturer :

FUJIFILM Corporation

26-30, NISHIAZABU 2-CHOME, MINATO-KU, TOKYO 106-8620, JAPAN



0123



European Authorized Representative:

FUJIFILM Europe GmbH

Heesenstrasse 31, 40549 Duesseldorf, Germany

FUJIFILM MEDICAL SYSTEMS U.S.A., INC.

419 WEST AVENUE, STAMFORD CT 06902, U.S.A.