

Faxitron™
Trident® HD
Specimen Radiography System



User Guide

MAN-05478-002 Revision 004

HOLOGIC®

Trident[®] HD

Specimen Radiography System

User Guide

For Software Version 1.0

Part Number MAN-05478-002

Revision 004

March 2019

HOLOGIC[®]

Technical Support

USA: +1.877.371.4372

Europe: +32 2 711 4690

Asia: +852 37487700

Australia: +1 800 264 073

All Other: +1 781 999 7750

Email: BreastHealth.Support@hologic.com

© 2018-2019 Hologic, Inc. Printed in the USA. This manual was originally written in English.

Hologic, Faxitron, Trident, and associated logos are trademarks and/or registered trademarks of Hologic, Inc., and/or its subsidiaries in the United States and/or other countries. All other trademarks, registered trademarks, and product names are the property of their respective owners.

This product may be protected by one or more U.S. or foreign patents as identified at www.Hologic.com/patents

Table of Contents

List of Figures	ix
List of Tables	xi
1: Introduction	1
1.1 Intended Use.....	1
1.2 System Capabilities.....	1
1.3 User Profiles.....	2
1.4 Quality Control Requirements.....	2
1.5 Where to Find the Installation Instructions.....	2
1.6 Where to Find Technical Description Information.....	2
1.7 Warranty Statement.....	2
1.8 Technical Support.....	3
1.9 Product Complaints.....	3
1.10 Hologic Cybersecurity Statement.....	3
1.11 Symbols.....	4
1.12 Descriptions of Warnings, Cautions, and Notes.....	5
2: General Information	7
2.1 System Overview.....	7
2.2 Safety Information.....	8
2.3 Warnings and Precautions.....	8
2.4 Interlocks.....	13
2.5 Compliance.....	13
2.5.1 Compliance Requirements.....	13
2.5.2 Compliance Statements.....	14
2.6 Label Locations.....	15
3: Components, Controls, and Indicators	17
3.1 System Components.....	17
3.1.1 Imaging Cabinet Components.....	18
3.2 System Connections.....	20
3.3 How to Lock and Unlock a Caster.....	21
3.4 How to Move the Console.....	21
3.5 How to Turn On the System and Log In.....	21
3.5.1 Windows 10 Information.....	23
3.6 How to Log Out.....	24
3.7 How to Turn Off the System.....	24
3.7.1 How to Remove All Power from the System.....	24

Trident HD Specimen Radiography System User Guide

Table of Contents

4: User Interface	25
4.1 About the Taskbar.....	25
4.2 Select Patient Screen	27
4.2.1 Open a Patient.....	28
4.2.2 Add a New Patient	28
4.2.3 Edit the Patient Information.....	29
4.2.4 Split the Patient Records.....	30
4.2.5 Delete a Patient	33
4.2.6 Filters for Patients.....	33
4.2.7 How to Refresh the Worklist.....	35
4.2.8 How to Query the Worklist.....	35
4.2.9 Admin	35
4.2.10 Close the Patient List.....	35
4.3 Procedure Screen.....	36
4.3.1 Add a Procedure	37
4.3.2 Simple and Advanced Button.....	38
4.3.3 Retrieve	38
4.3.4 Close a Patient.....	39
4.3.5 How to Select an Output Group.....	39
4.4 How to Access Image Review Features	39
4.5 How to Use the Output Groups.....	39
4.5.1 Add or Edit an Output Group	39
4.6 How to Use the On-Demand Outputs	40
4.6.1 How to Archive.....	40
4.6.2 How to Export.....	40
4.6.3 Print	41
5: The Images	43
5.1 Image Display Screen	43
5.2 How to Set the Exposure Techniques.....	44
5.3 How to Acquire an Image.....	45
5.4 How to Review the Images.....	47
5.4.1 Image Review Tools	48
5.5 Send the Images to the Output Devices.....	51
6: Sample Clinical Sequences	53
6.1 Example Imaging Workflow	53
6.2 Example Sequence of Operation	54
7: Quality Control	61
7.1 Required Quality Control Procedures	61
7.2 How to Access the Quality Control Tasks.....	61
7.2.1 Gain Calibration.....	62

8: Maintenance, Cleaning, and Disinfecting	63
8.1 General Information	63
8.1.1 For General Cleaning	63
8.1.2 For Disinfecting	63
8.1.3 To Prevent Possible Injury or Equipment Damage	64
8.2 Component Specific Care	64
8.2.1 How to Clean the Image Display Monitor	64
8.2.2 Power Cord	65
8.3 Maintenance	65
8.3.1 Preventive Maintenance Schedules	65
8.3.2 About Reclamation	66
9: System Administration Interface	67
9.1 Admin Screen	67
9.2 About Screen	69
9.3 Change the User Language Preference	70
9.4 Set Multi Line Procedure Tabs	71
9.5 System Tools	71
9.5.1 System Tools for the Radiologic Technologist Manager	72
9.6 Archive Tool	73
9.7 How to Change the Default Lock Out Time	76
Appendix A: System Specifications	77
A.1 Product Measurements	77
A.2 Operation and Storage Environment	77
A.2.1 General Conditions for Operation	77
A.2.2 General Conditions for Transport and Storage	78
A.3 Console Technical Information	78
A.3.1 General Information	78
A.3.2 Network Environment	78
A.4 Electrical Input	79
A.5 X-ray Tube Technical Information	79
A.5.1 X-Ray Generator	79
A.6 Imaging System Technical Information	79
A.6.1 Image Receptor	79
Appendix B: System Messages and Alerts	81
B.1 Error Recovery and Troubleshooting	81
B.2 Types of Messages and Alert messages	81
B.2.1 Fault Levels	81
B.2.2 System Messages	82
B.3 Troubleshooting	82

Trident HD Specimen Radiography System User Guide

Table of Contents

Glossary of Terms _____ **83**

Index _____ **85**

List of Figures

Figure 1: Trident HD System	7
Figure 2: Label Locations.....	15
Figure 3: System Components	17
Figure 4: Specimen Tray Positions	18
Figure 5: Specimen Tray Markings.....	19
Figure 6: Power and Network Connections.....	20
Figure 7: System Power Switch.....	21
Figure 8: Computer Power Switch	22
Figure 9: Login Screen.....	22
Figure 10: Startup Screen.....	23
Figure 11: The Taskbar	25
Figure 12: Select Patient Screen.....	27
Figure 13: Add Patient Screens	28
Figure 14: Edit Patient Information Screens.....	29
Figure 15: Split Patient Records Screen	30
Figure 16: Select the Correct Procedure to Split Patient Records.....	31
Figure 17: Select the Correct Patient to Split Patient Records.....	32
Figure 18: Filter Tab in the Patient Filter Screen.....	33
Figure 19: Procedure Screen.....	36
Figure 20: Add Procedure Dialog Box	37
Figure 21: Tools Tab, Simple	38
Figure 22: Tools Tab, Advanced	38
Figure 23: Print Screen	41
Figure 24: Image Display Screen.....	43
Figure 25: Imaging Enabled	45
Figure 26: X-RAY Button	45
Figure 27: X-RAY Button while the Exposure Is in Progress.....	46
Figure 28: Tools Tab in the Procedure Screen.....	47
Figure 29: The Image Review Tools	48
Figure 30: The Comments Tab	49
Figure 31: Priors Tab	50
Figure 32: Display Modes.....	50
Figure 33: Admin Screen.....	67
Figure 34: System Tab of the About Screen.....	69
Figure 35: System Tools Button	71
Figure 36: System Tools Screen.....	72
Figure 37: Archive Button.....	73
Figure 38: Multi Patient On Demand Archive Screen	73
Figure 39: Export Screen.....	75
Figure 40: Console Measurements.....	77

List of Tables

Table 1: System Labels	16
Table 2: The Taskbar Sections	25
Table 3: Filter Tab Options (Require Access Privileges)	34
Table 4: The Procedure Screen	36
Table 5: Required Procedures	61
Table 6: User Preventive Maintenance.....	65
Table 7: Service Preventive Maintenance	66
Table 8: Admin Screen Functions	67
Table 9: Radiologic Technologist Manager—System Tools Functions.....	72

Chapter 1 Introduction

Read all this information carefully before operating the system. Follow all warnings and precautions as stated in this manual. Keep this manual available during procedures. Physicians should tell patients about all potential risks and adverse events described in this manual with respect to the operation of the system.



Note

Hologic configures some systems to meet specific requirements. Your system configuration may not have all the options and accessories included in this manual.

1.1 Intended Use

\mathbb{R}_x Only United States federal law restricts this device to use by, or on the order of, a physician.

The Trident® specimen radiography system is a cabinet x-ray system used to provide digital x-ray images of surgical and core biopsy specimens from various anatomical regions in order to allow rapid verification that the correct tissue has been excised during the biopsy procedure.

Doing the verification in the same room as the procedure or nearby improves workflow, thus reducing the time the patient needs to be under examination.

1.2 System Capabilities

The Trident system acquires and displays the radiographic images of surgical and core specimens taken from various anatomical regions. The system has the capability to transfer the images to external devices. The images acquired with this system are intended to confirm removal of a suspected lesion or pathology; the system is not intended for diagnostic purposes.

Specimen radiography systems are used in diagnostic imaging departments, pathology departments, or in surgical suites. Radiologic Technologists, surgical personnel, surgeons, radiologists and pathologists can use specimen radiography equipment.

Hologic recommends that users receive training in basic ionizing radiation safety before using the system.

1.3 User Profiles

- A Primary System User (for example, an operating room nurse) can perform basic system functions, except ones that require Manager privileges. The Primary System User is referred to in this document as the User.
- System Managers can perform all system functions, add and delete user accounts, and delete patients. The System Manager is referred to in this document as the Manager.
- Service personnel have full access to all system functions.

1.4 Quality Control Requirements

Perform all Quality Control tests within the correct time frame.

1.5 Where to Find the Installation Instructions

Installation instructions are available in the *Service Manual*.

1.6 Where to Find Technical Description Information

Technical description information is available in the *Service Manual*.

1.7 Warranty Statement

Except as otherwise expressly stated in the Agreement: i) Equipment manufactured by Hologic is warranted to the original Customer to perform substantially in accordance with published product specifications for one (1) year starting from the date of shipment, or if Installation is required, from the date of Installation (“Warranty Period”); ii) digital imaging mammography x-ray tubes are warranted for twenty-four (24) months, during which the x-ray tubes are fully warranted for the first twelve (12) months and are warranted on a straight-line prorated basis during months 13-24; iii) replacement parts and remanufactured items are warranted for the remainder of the Warranty Period or ninety (90) days from shipment, whichever is longer; iv) consumable Supplies are warranted to conform to published specifications for a period ending on the expiration date shown on their respective packages; v) licensed Software is warranted to operate in accordance with published specifications; vi) Services are warranted to be supplied in a workman-like manner; vii) non-Hologic Manufactured Equipment is warranted through its manufacturer and such manufacturer’s warranties shall extend to Hologic’s customers, to the extent permitted by the manufacturer of such non-Hologic Manufactured Equipment. Hologic does not warrant that use of Products will be uninterrupted or error-free, or that Products will operate with non-Hologic authorized third-party products. These warranties do not apply to any item that is: (a) repaired, moved, or altered other than by Hologic authorized service personnel; (b) subjected to physical (including thermal or electrical) abuse, stress, or misuse; (c) stored, maintained, or operated in any manner inconsistent with applicable Hologic specifications or instructions, including Customer’s refusal to allow Hologic recommended Software upgrades; or (d) designated as supplied subject to a non-Hologic warranty or on a pre-release or “as-is” basis.

1.8 Technical Support

Refer to the copyright page of this manual for contact information for product support.

1.9 Product Complaints

Report any complaints or problems in the quality, reliability, safety, or performance of this product to Hologic. If the device has caused or added to patient injury, immediately report the incident to Hologic.













1.10 Hologic Cybersecurity Statement

Hologic continuously tests the current state of computer and network security to examine possible security problems. When necessary, Hologic provides the updates to the product.

For Cybersecurity Best Practices documents for Hologic products, refer to the Hologic Internet site at www.Hologic.com.

1.11 Symbols

This section describes the Symbols on this system.

Symbol	Description
	"ON" for part of the equipment
	Potential Equalization terminal
	Discard electrical and electronic equipment separately from standard waste. Send decommissioned material to Hologic or contact your service representative.
	Manufacturer
	Date of Manufacture
	Caution—Radiation
	Warning Electricity
	Caution
	Follow instructions for use
	This system transmits radio frequency (RF) energy (non-ionizing radiation)
	Catalog number
	Serial number

1.12 Descriptions of Warnings, Cautions, and Notes

Descriptions of Warnings, Cautions, and Notes used in this manual:



WARNING!

The procedures that you must follow accurately to prevent possible dangerous or fatal injury.



Warning:

The procedures that you must follow accurately to prevent injury.



Caution:

The procedures that you must follow accurately to prevent damage to equipment, loss of data, or damage to files in software applications.



Note

Notes show additional information.

Chapter 2 General Information

2.1 System Overview



Figure 1: Trident HD System

Figure Legend

1. Image Display Monitor
2. Control Display
3. Imaging Cabinet

2.2 Safety Information

Read and understand this manual before you use the system. Keep the manual available during the operation of the unit.

Always follow all the instructions in this manual. Hologic does not accept responsibility for injury or damage from incorrect system operation. Hologic can arrange for training at your site.

The system has safety interlocks, but the user must understand how to safely operate the system and be aware of the health hazards of x-ray radiation.

2.3 Warnings and Precautions



WARNING!

Only trained Service Engineers authorized through Hologic can open any of the panels. This system contains lethal voltages.



WARNING!

Electrical equipment used near flammable anesthetics can cause an explosion.



WARNING!

The user must correct problems before the system is used. Contact an approved service representative for preventive maintenance.



WARNING!

The protection provided by the equipment is reduced if the equipment is used in a method not specified by Hologic.



WARNING!

Always place the Trident system a minimum of 1.5 meters (5 feet) from the patient.



WARNING!

No modification of this equipment is allowed.



WARNING!

Do not attempt to use any console that could present a shock hazard. Immediately contact Hologic or your distributor.



WARNING!

To prevent shock hazard, do not use the system unless the blades of the polarized plug can be fully inserted in the electrical outlet.



WARNING!

Before each use, check that the power cord is in good condition and is fully inserted in the electrical outlet.



WARNING!

Make sure that the power cord for the system console is in good condition. A damaged power cord can be an electrical shock hazard. When disconnecting the console from power, always grasp the plug at the insertion point and pull lightly. NEVER pull on the cord to unplug the unit.



WARNING!

Before moving the console, make sure that the power cord and any cables are unplugged and wrapped securely around the cord management plate.



WARNING!

Before adjusting the position of the console, make sure the power cord and any cables are safely positioned out of the way.



WARNING!

To prevent fire or shock hazard, do not expose the system to rain or moisture.



Warning:

This device contains dangerous material. Send decommissioned material to Hologic or contact your service representative.



Warning:

Control the access to the equipment according to local regulations for radiation protection.

Trident HD Specimen Radiography System User Guide

Chapter 2: General Information



Warning:

Do not use the system if the glass is cracked or damaged.



Warning:

This system can be dangerous to the user. Always follow the safety precautions for x-ray exposures.



Warning:

Cables and cords can pose a tripping hazard. Position cords safely out of the way. When not in use, wind cords securely around the cord management plate.



Warning:

Before moving the console, make sure the caster locks are unlocked. Trying to move the system with the casters locked can cause the console to tip over.



Warning:

Before moving the system, rotate the Image Display monitor to a position that provides clear visibility while pushing the console.



Warning:

Do not move the console with excessive force or speed. Do not make quick stops.



Warning:

When moving the console, be aware of bumps, ramps, inclines, or declines. Use extra caution when moving the console on an uneven or sloped surface.



Warning:

Make sure there is adequate space to completely open the Imaging Cabinet door and to safely insert or remove the specimen tray.



Warning:

Keep the Imaging Cabinet door closed when not in use. Leaving the door open can pose a tripping hazard.



Warning:

Use the Imaging Cabinet door handle to open and close the door. Closing the Imaging Cabinet door incorrectly can cause a pinch hazard.



Caution

Risk of data loss. Do not put any magnetic media near or on devices that create any magnetic fields.



Caution

To prevent possible damage from thermal shock to the Digital Image Receptor, follow the recommended procedure to turn off the equipment.



Caution

Use the least possible amount of cleaning fluids. The fluids must not flow or run.



Caution

To prevent damage to the electronic components, do not use disinfectant sprays on the system.



Caution

To prevent damage to the console and its components, use only the recommended cleaning methods.



Caution

Do not spill or put fluids or liquids on the touch screen or the touch pad. Fluids or liquids on the touch screen and the touch pad can cause a malfunction. Make sure that the touch screen and touch pad are clean and dry before using the system.



Caution:

The system is a laboratory device and not a normal computer. Do not make changes to the hardware or software that are not authorized. Install this device behind a firewall for network security. The computer virus protection or network security for this laboratory device is not provided (for example, a computer firewall). The network security and anti-virus provisions are the responsibility of the user.



Caution

To prevent possible damage to the system, follow the recommended procedure to turn off the equipment.



Caution

The system must be installed and put into service according to the guidance provided in these instructions to ensure its electromagnetic compatibility.

Trident HD Specimen Radiography System User Guide

Chapter 2: General Information



Caution

Portable and mobile RF communications can affect medical electrical equipment.



Caution

To prevent low image quality, perform system calibrations when prompted.



Caution

To prevent low image quality, make sure to remove all patient material from the Imaging Cabinet and specimen tray. Use the recommended cleaning methods to clean and disinfect the Imaging Cabinet and specimen tray.



Caution

To prevent damage, use care when handling and cleaning the specimen tray.



Caution

The weight and mobility of this system require the following precautions:

- Be careful when you move the system on uneven or sloped surfaces.
 - Make sure the wheels are locked when the system is stationary.
 - Before you move the console, make sure the cables are stored in a safe position on the console.
 - Before you move the console, rotate the Image Display screen to allow for an unobstructed view.
 - Do not make quick stops. Do not move with excessive force or speed.
-

2.4 Interlocks

The x-ray generation stops automatically and an error message appears when there is an interruption of an x-ray exposure such as when the mAs timer or maximum exposure timer times out or the cabinet door is opened.

2.5 Compliance

This section describes the system compliance requirements and the responsibilities of the manufacturer.

2.5.1 Compliance Requirements

The manufacturer has the responsibility for the safety, reliability, and performance of this equipment with the following provisions:

- The equipment is used according to the instructions for use.
- The assembly operations, extensions, adjustments, changes, or repairs are performed only by authorized persons.
- The network and communication equipment must be installed to meet IEC Standards.



Caution:

This system is intended for use by healthcare professionals only. This system may cause radio interference or may disrupt the operation of nearby equipment. It may be necessary to take mitigation measures, such as re-orienting or relocating the equipment or shielding the location.



Caution:

The emissions characteristics of this equipment make it suitable for use in industrial areas and hospitals (CISPR 11 class A). If it is used in a residential environment (for which CISPR 11 class B is normally required), this equipment might not offer sufficient protection to radio frequency communication services. The user may need to take mitigation measures, such as relocating or re-orienting the equipment.



Caution:

The Medical Electrical (ME) Equipment or ME System should not be used adjacent to or stacked with other equipment. If adjacent or stacked use is necessary, make sure that the ME Equipment or ME System operates correctly in this configuration.



Caution:

Changes or modifications not expressly approved by Hologic could void your authority to operate the equipment.

2.5.2 Compliance Statements

The manufacturer states this device is made to meet the following requirements:

UL, IEC, EN:

- UL 61010-1: 2012 - Safety Requirements for Electrical Equipment for Measurement, Control, and Laboratory Use; Part 1: General Requirements
- IEC 61010-1 § 6.7
- IEC 61010-1: 2010, 3rd Edition - Safety Requirements for Electrical Equipment for Measurement, Control, and Laboratory Use; Part 1: General Requirements
- IEC 61010-2-091: 2012, 3rd Edition - Safety Requirements for Electrical Equipment for Measurement, Control, and Laboratory Use; Part 2-091: Particular Requirements for Cabinet X-ray Systems
- EN 61326-1: 2013 Electrical Equipment for Measurement, Control, and Laboratory Use – EMC Requirements, General Requirements
- EN 55011 and CISPR 11 (Class A) - Industrial, Scientific and Medical (ISM) Radio-Frequency Equipment – Electromagnetic Disturbance Characteristics - Limits and Methods of Measurement

CFR:

- 21 CFR § 1020.40 - Cabinet X-ray Systems
- 47 CFR Part 15.5 - General Conditions of Operation

CAN/CSA:

- CAN/CSA-C22.2 No. 61010-1, 3rd Edition - Safety Requirements for Electrical Equipment for Measurement, Control, and Laboratory Use – Part 1: General Requirements

2.6 Label Locations

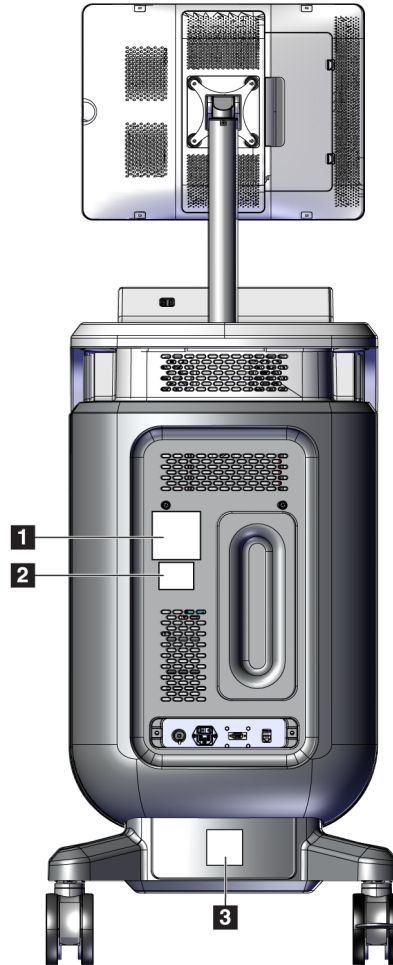

Figure 2: Label Locations

Trident HD Specimen Radiography System User Guide

Chapter 2: General Information

Table 1: System Labels

1	
<i>System Nameplate</i>	
2	3
<i>X-ray Device Warning</i>	<i>Electrical Shock Warning</i>

Chapter 3 Components, Controls, and Indicators

3.1 System Components

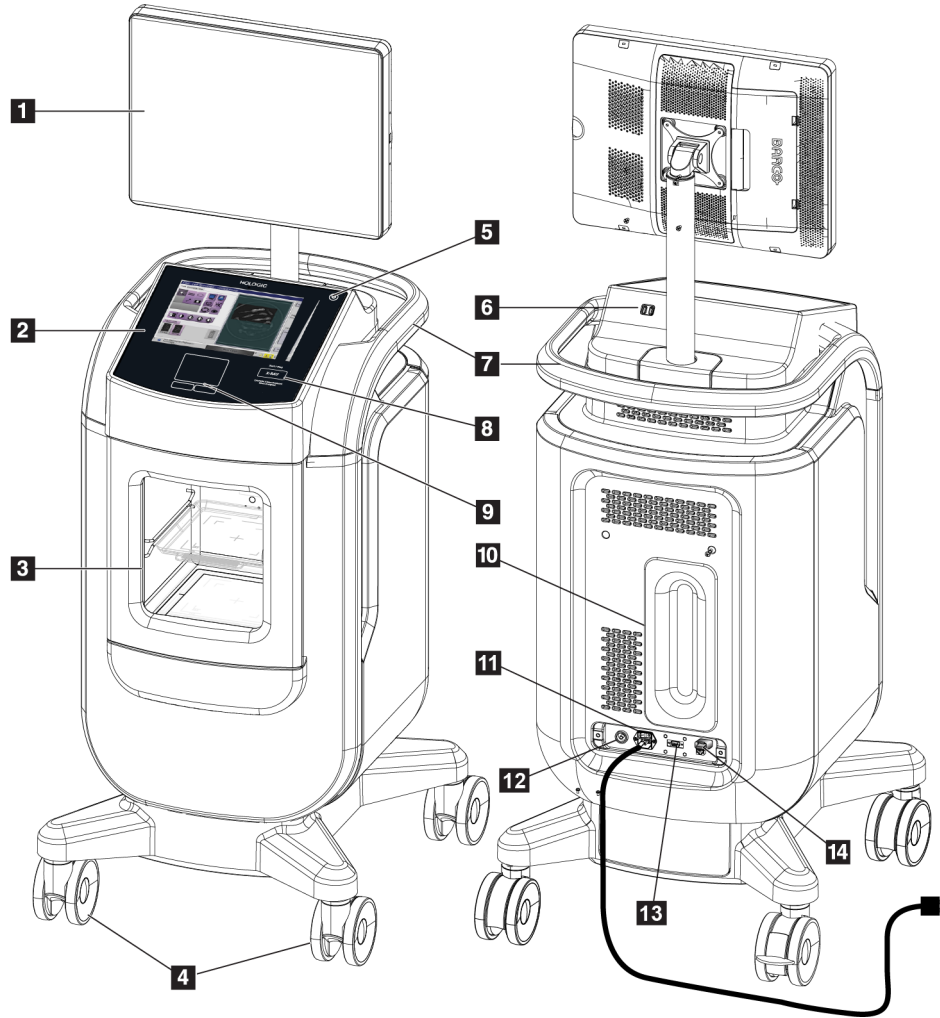

Figure 3: System Components

Figure Legend

- | | |
|-------------------------------------|---|
| 1. Image Display Monitor | 9. Touchpad |
| 2. Control Display | 10. Cord Management Plate |
| 3. Imaging Cabinet | 11. System Power Switch and Power Cord Connection |
| 4. Casters | 12. Potential Equalization Connection |
| 5. Computer Power On/Restart Button | 13. Service Port |
| 6. USB Ports | 14. Ethernet Port |
| 7. Console Handle | 15. [Bar Code Scanner] |
| 8. X-RAY Activation Button | |

3.1.1 Imaging Cabinet Components

The console houses a shielded imaging cabinet. The placement of the specimen tray determines the magnification level of the image.

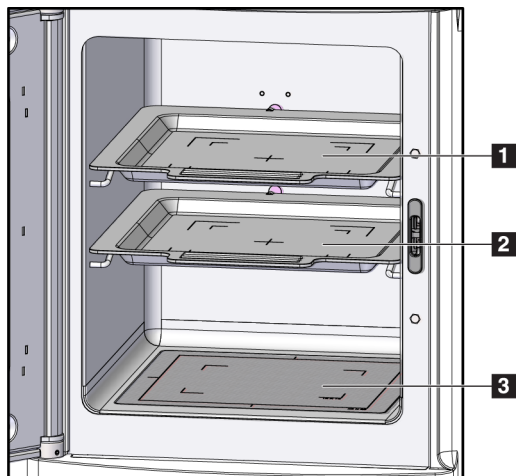

Figure 4: Specimen Tray Positions

Figure Legend

1. Specimen Tray location for 2.0x magnification
2. Specimen Tray location for 1.5x magnification
3. Specimen Tray location for 1.0x magnification (contact image)

Specimen Tray

The specimen tray has markings to show the 1.5x magnification margins and the 2.0x magnification margins.

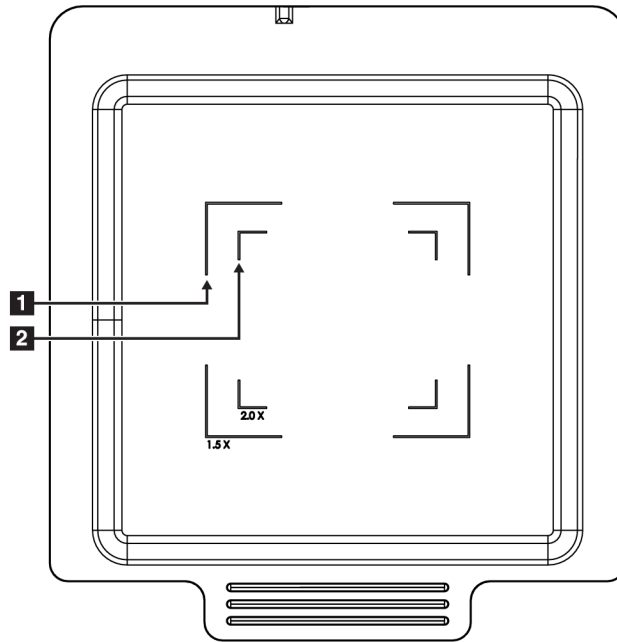

Figure Legend

1. 1.5x Magnification Margins
2. 2.0x Magnification Margins

Figure 5: Specimen Tray Markings



Caution

To prevent damage, use care when handling and cleaning the specimen tray.



Note

Store the specimen tray inside the Imaging Cabinet.

3.2 System Connections

Power and Network Connections

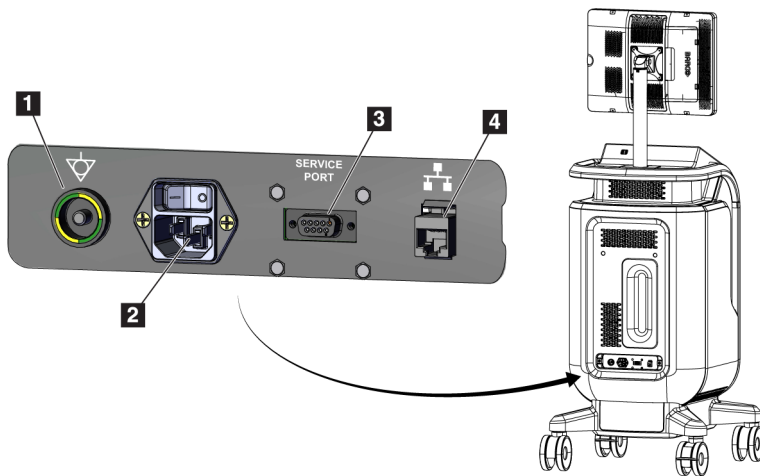

Figure Legend

1. Potential Equalization Connection
2. Power Cord Connection
3. Service Port
4. Ethernet Port

Figure 6: Power and Network Connections

1. Put the system in a location where you can easily access power connections and network connections.
2. Connect the system power cord to the electrical outlet.
3. If desired, connect the network cable to the ethernet port.

USB Connections

The console has two USB ports located at the back of the control display.

Wi-Fi Connections

Wi-Fi is configured through system settings.

3.3 How to Lock and Unlock a Caster

- To lock a caster, step on the locking lever on the wheel until the lever locks.
- To unlock a caster, lift the locking lever on the wheel to the UP position.

3.4 How to Move the Console



Note

The power cord wraps on the back side of the console to provide safe storage of the cord during console movement.

1. Make sure that the computer system and console are completely turned OFF.
2. Make sure that the power cord is unplugged and any network cables are disconnected.
3. Wrap the power cord on the cord management plate.
4. Make sure all components and cables are in a safe position on the console.
5. Position the Image Display monitor so that you have an unobstructed view while pushing the console.
6. Unlock the caster locks.
7. Move the console by pushing the console handle.
8. Lock the casters when the console is in the correct location.

3.5 How to Turn On the System and Log In

1. Make sure the console casters are locked.
2. Connect the system to power. If desired, connect the system to the network.
3. Turn ON the system power switch on the back of the console.

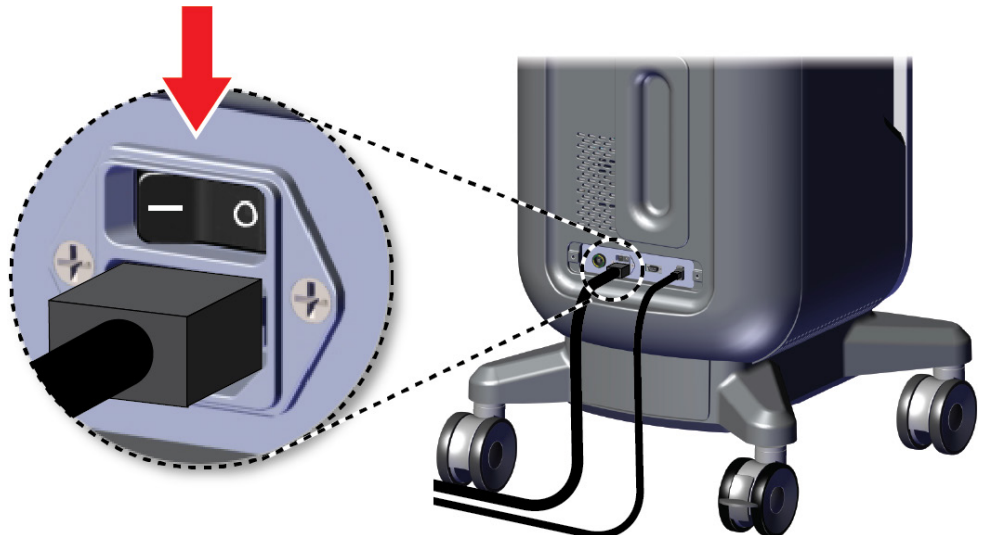

Figure 7: System Power Switch

Trident HD Specimen Radiography System User Guide

Chapter 3: Components, Controls, and Indicators

4. Press the computer power button on the control display. The computer powers on and the *Login* screen opens.



Figure 8: Computer Power Switch

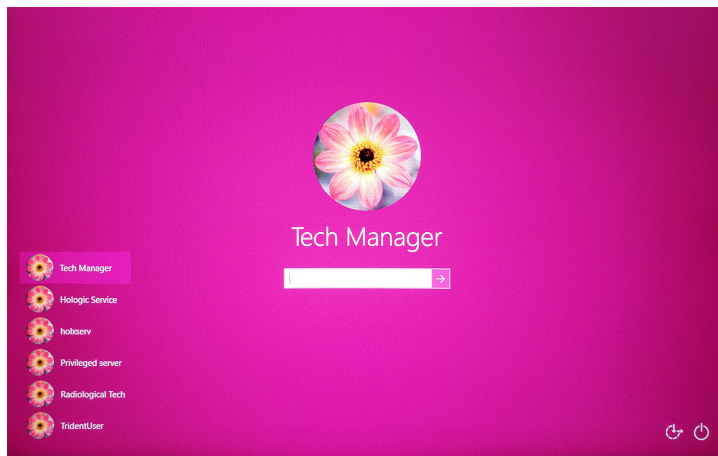

Figure 9: Login Screen

5. Enter your user name and password then select the **arrow** icon. After a moment, the *Startup* screen opens.



Note

To hide the virtual keyboard, tap the pink background

- At the *Startup* screen, select the **Patient List** button.

Faxitron™ Trident® HD Specimen Radiography System

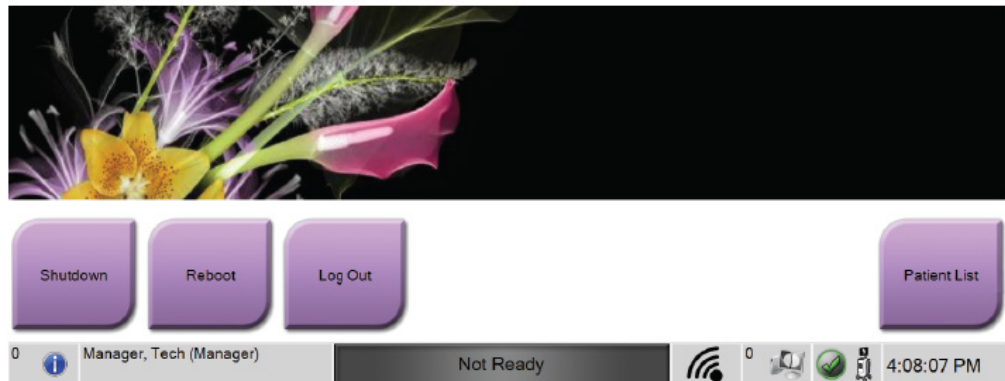

Figure 10: Startup Screen



Note

The *Startup* screen includes a **Shutdown** button that turns off the computer and a **Reboot** button that restarts the computer.



Note

Refer to [System Components](#) on page 17 for locations of power buttons.



Note

To change the system language or other preferences, refer to [System Administration Interface](#) on page 67.

3.5.1 Windows 10 Information

The Trident system software runs on the Windows 10 operating system. The touch screen will respond to certain Windows 10 touch gestures.

- Swipe right to show the task view.
- When the Trident system application is minimized, swipe up to show the Windows taskbar.
- Tap the **Windows** icon on the taskbar to open the Windows Start menu.
- In task view, tap the Trident system application window to return to the full screen Trident system application.

3.6 How to Log Out

1. In the *Procedure* screen, select the **Close Patient** button.
2. In the *Select Patient* screen, select the **Close** button.
3. At the *Startup* screen, select the **Log Out** button. At the confirmation prompt, select the **Yes** button. The *Login* screen opens.

3.7 How to Turn Off the System

1. Close any open patient procedures.
2. In the *Select Patient* screen, select the **Close** button.
3. At the *Startup* screen, select the **Shutdown** button. At the confirmation prompt, select the **Yes** button. The computer system shuts down but the console remains on.
4. To shut down the console, turn OFF the system power switch on the back of the console.

3.7.1 How to Remove All Power from the System

1. Make sure that the computer system and console are completely turned OFF.
2. Disconnect the power cord from the electrical outlet.

Chapter 4 User Interface

4.1 About the Taskbar

The Taskbar at the bottom of the screen displays additional icons, which you can select to access information or perform system tasks.

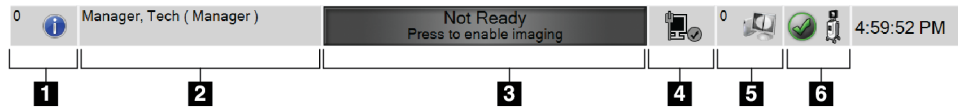



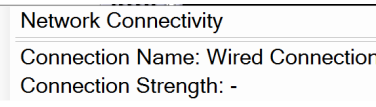



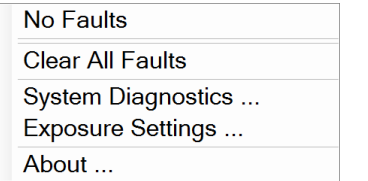

Figure 11: The Taskbar

Table 2: The Taskbar Sections

	Description	Menu
1 	<p>Alarm Information</p> <p>Select the Information icon to display the Alarm menu. This section of the taskbar flashes a yellow color if an alarm exists.</p> <p>Select Acknowledge All to remove the flashing indication.</p> <p>Select Manage Alarms to display and close any open alarms.</p>	<div style="border: 1px solid gray; padding: 5px;"> No Alarms Acknowledge All Manage Alarms ... </div>
2	<p>Current User</p> <p>Select the user name to display the Users menu.</p> <p>Log Out returns you to the <i>Login</i> screen.</p> <p>My Settings opens the <i>Edit Operator</i> screen to review or edit Operator information or to change your password.</p> <p>Print prints the displayed patient list to a connected printer.</p> <p>Note: this popup menu is inactive in the <i>Procedure</i> screen.</p>	<div style="border: 1px solid gray; padding: 5px;"> Users Menu <hr/> Log Out ... My Settings ... <hr/> Print ... </div>
3	<p>Imaging Status</p> <p>Shows the imaging status: Not Ready, Ready, or X-ray in progress.</p> <p>Select this section to enable or disable imaging.</p> <p>When imaging is disabled, this section is gray and shows a Not Ready status. When the imaging status is Not Ready, the X-RAY activation button is also disabled.</p> <p>When imaging is enabled, this section changes to green and shows a Ready status. When the imaging status is Ready, the X-RAY activation button lights up on the control display.</p> <div style="text-align: center; margin: 10px 0;"> <div style="background-color: #4CAF50; color: white; padding: 5px; display: inline-block;"> Ready Press to disable imaging </div> </div> <p>When the imaging status is Ready, select this section to disable imaging. To prevent accidental X-ray activation, keep the system in Not Ready mode until you are ready to acquire an image.</p>	

<p>4</p>  	<p style="text-align: center;">Network Connections</p> <p>Select the Network icon to display the Network Connectivity menu.</p> <p>Connection Name shows the current network connection in use. Connection Strength shows the strength of the wireless network connection.</p> <p>A network connection is required to:</p> <ul style="list-style-type: none"> • obtain scheduled patient procedures from a Modality Worklist Provider • archive, export, or print acquired images • Query Retrieve images from an archive 	
<p>5</p> 	<p style="text-align: center;">Output Devices</p> <p>Select the workstation icon to open the <i>Manage Queues</i> screen. The number next to the icon is the number of jobs that remain in the queue.</p> <p>The <i>Manage Queues</i> screen displays the status of jobs in the queue and job information for the selected output, and allows you to filter the queue display.</p>	
<p>6</p>   	<p style="text-align: center;">System Status</p> <p>If the System Status (console) icon has a green check mark next to it, the system is ready for use. Select the System Status icon to display the Faults menu.</p> <p>If the System Status icon is red with a number next to it, the system needs to wait the number of minutes shown before the next image can safely be taken.</p> <p>If the System Status icon has a yellow exclamation mark next to it and this taskbar section flashes yellow, there is an error. Select the System Status icon for more information about the error.</p> <p>Clear All Faults deletes all error messages.</p> <p>System Diagnostics accesses subsystem settings. You can also toggle the cabinet light on and off.</p> <p>Exposure Settings allows you to change the exposure techniques. Refer to How to Set the Exposure Techniques on page 44.</p> <p>About displays information about the system. Refer to About Screen on page 69.</p>	

4.2 Select Patient Screen

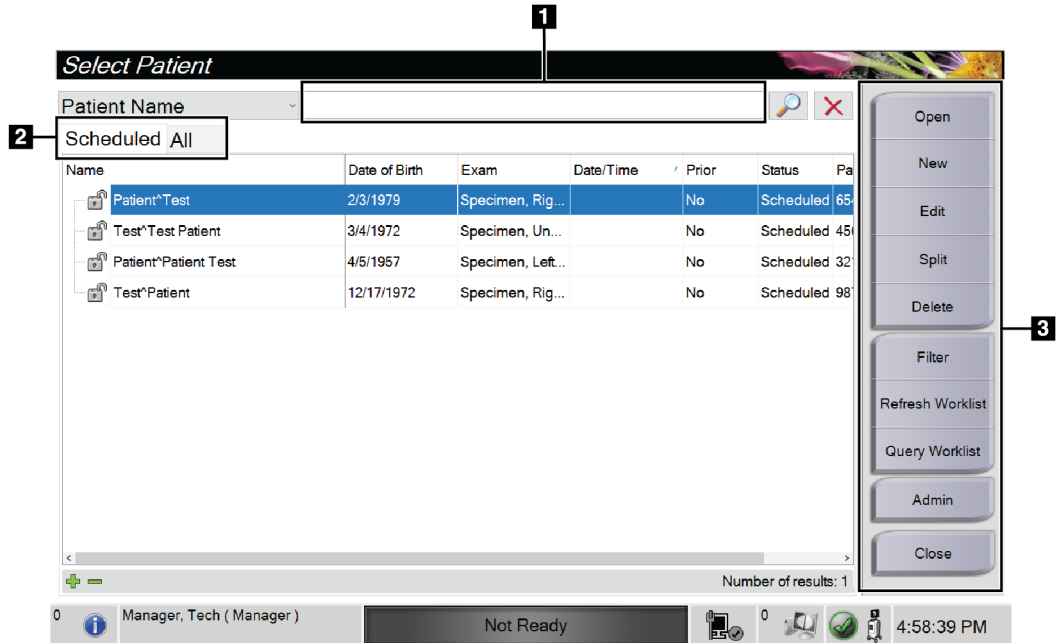

Figure 12: Select Patient Screen

Figure Legend

1. Quick Search	Search the local database for the Patient Name, Patient ID, or Accession Number.
2. Tabs	<p>The filter tabs at the top of the screen are configurable. A Manager can delete tabs and create new tabs (refer to Filters for Patients on page 33).</p> <ul style="list-style-type: none"> The Scheduled tab shows the scheduled procedures. The All tab shows all procedures for all users.
3. Buttons	<p>Many functions are accessed from this screen by selecting a particular button:</p> <ul style="list-style-type: none"> Open: Open the selected patient—refer to Open a Patient on page 28. New: Add a new patient — refer to Add a New Patient on page 28. Edit: Edit the patient information — refer to Edit the Patient Information on page 29. Split: Move images to a different procedure — refer to Split the Patient Records on page 30. Delete: Delete a patient from the worklist — refer to Delete a Patient on page 33. Filter: Configure the Patient Filters — refer to Filters for Patients on page 33. Refresh Worklist: Update the Scheduled Patient Worklist information — refer to How to Refresh the Worklist on page 35 Query Worklist: Search for a patient in the Modality Worklist — refer to How to Query the Worklist on page 35. Admin: Access the <i>Admin</i> screen — refer to Admin Screen on page 67. Close: Exit and return to the <i>Startup</i> screen.

4.2.1 Open a Patient

1. Select a tab to show the desired list of patients.
2. Select a patient from the list. The **Open** button becomes active.
3. Select **Open** to access the *Procedure* screen for that patient.

4.2.2 Add a New Patient

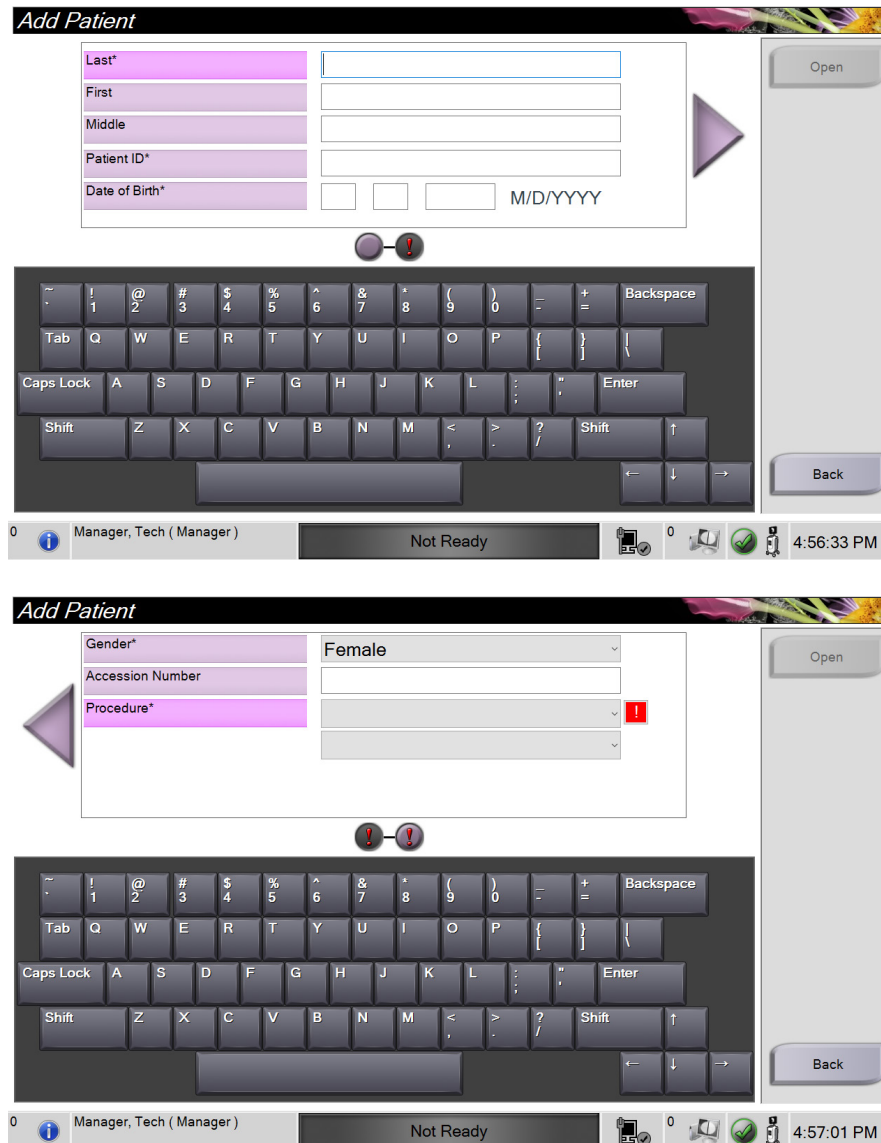

Figure 13: Add Patient Screens

1. In the *Select Patient* screen, select the **New** button. The *Add Patient* screen opens.
2. Enter the new patient information and select a procedure.
3. Select the **Open** button. The *Procedure* screen for the new patient opens.

4.2.3 Edit the Patient Information

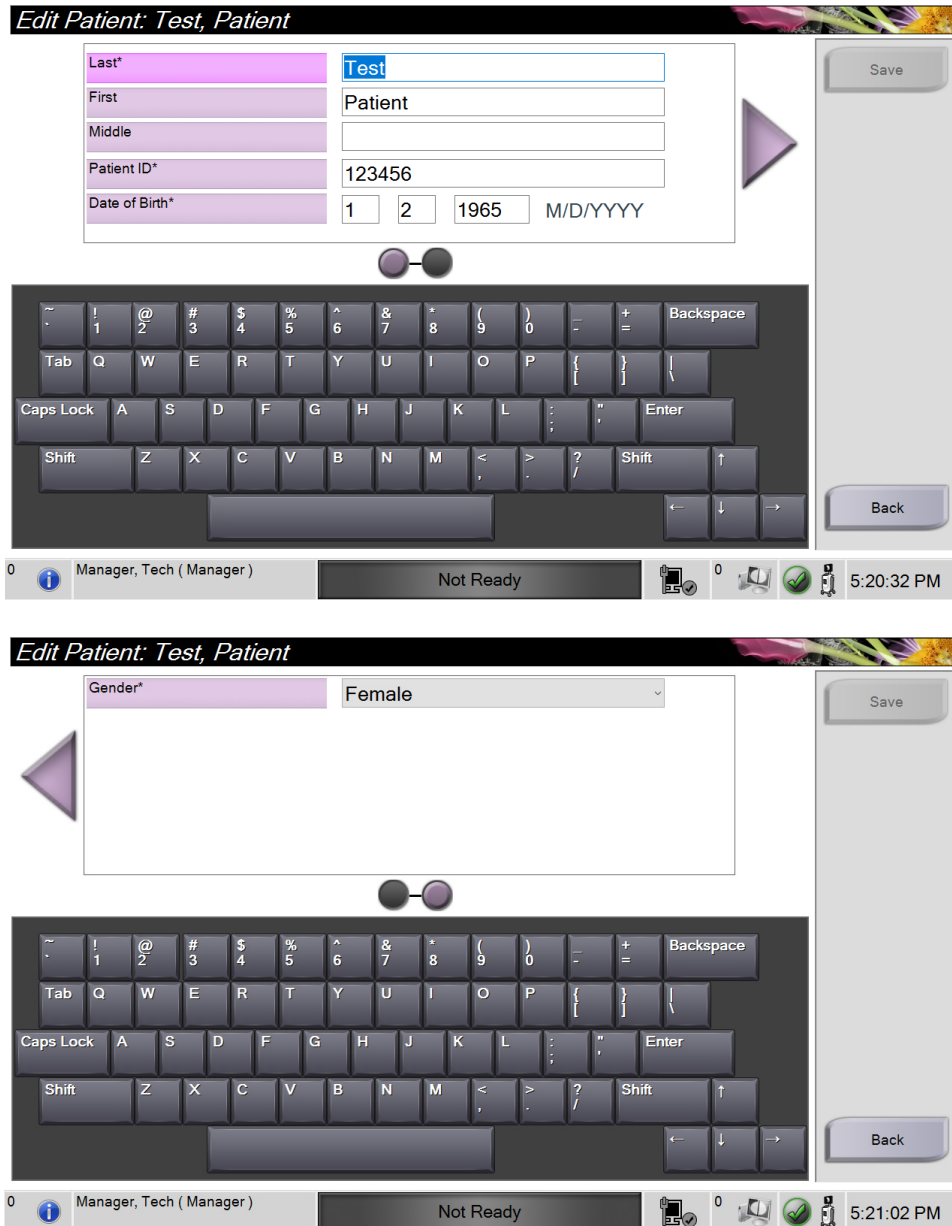

Figure 14: Edit Patient Information Screens

1. In the *Select Patient* screen, select the patient name then select the **Edit** button.
2. In the *Edit Patient* screen, make changes then select the **Save** button.
3. Select **OK** to the *Update Successful* message.

4.2.4 Split the Patient Records

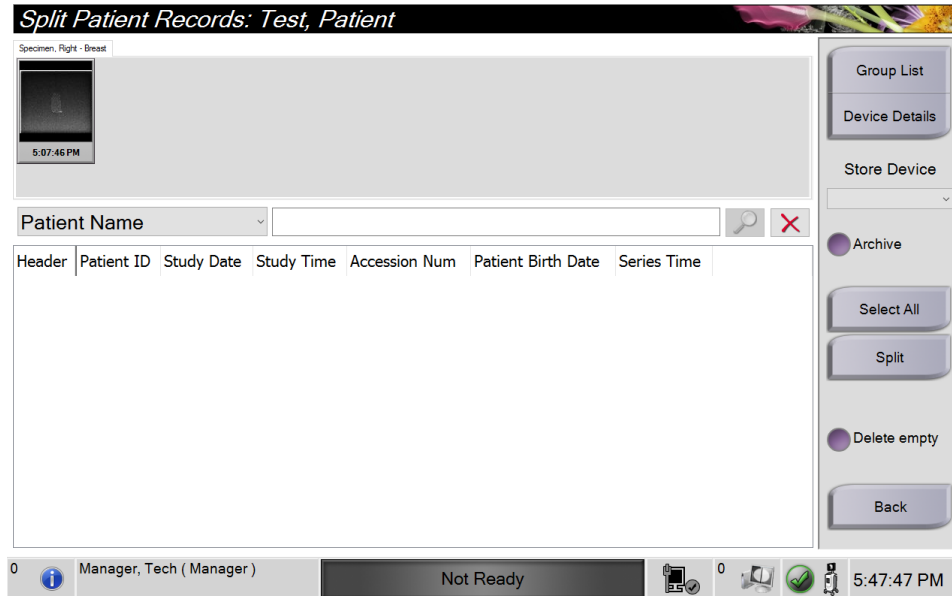

Figure 15: Split Patient Records Screen

The Split function lets you move images when you acquired the images in the incorrect procedure or the incorrect patient.



Note

You cannot split images for protected patients.



Note

Archived patient records still need correction on PACS or other archive systems after using the Split function.

Images Acquired in the Wrong Procedure

1. In the *Select Patient* screen, select the patient.
2. Select the **Split** button. The *Split Patient Records* screen opens.
3. Select the images to move. If all images are being moved, select **Select All**.
4. Select your search criteria (for example, Patient Name or Accession Number) using the drop-down list below the images.
5. Enter the same patient information and select the **Search** button (the magnifying glass).
6. When the Patient name appears, select the correct procedure for the images.

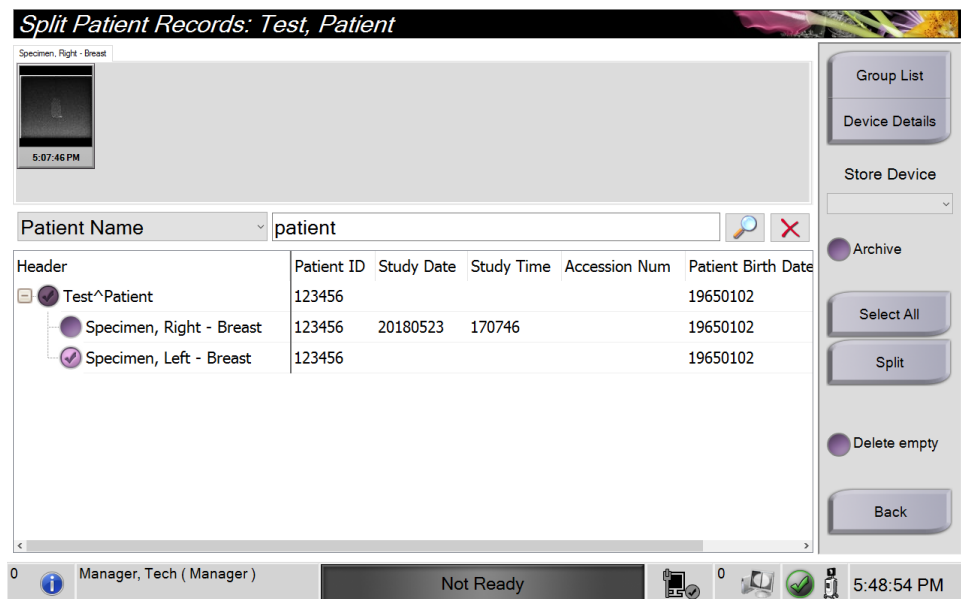

Figure 16: Select the Correct Procedure to Split Patient Records

7. If ALL the images are being moved and you want to delete the incorrect procedure, select **Delete Empty**.
8. If you want to archive the images or save them to a stored device, select **Archive**. Verify that the correct outputs are selected.
9. Select **Split**, then select **OK** in the *Split Successful* message.

Images Acquired in the Wrong Patient

1. In the *Select Patient* screen, select the patient that has the images that need to be moved.
2. Select the **Split** button. The *Split Patient Records* screen opens.
3. Select the images to move. If all images are being moved, select **Select All**.
4. Select your search criteria (for example, Patient Name or Accession Number) using the drop-down list below the images.
5. Enter the search criteria and select the **Search** button (the magnifying glass).
6. When the Patient name appears, select the correct procedure.

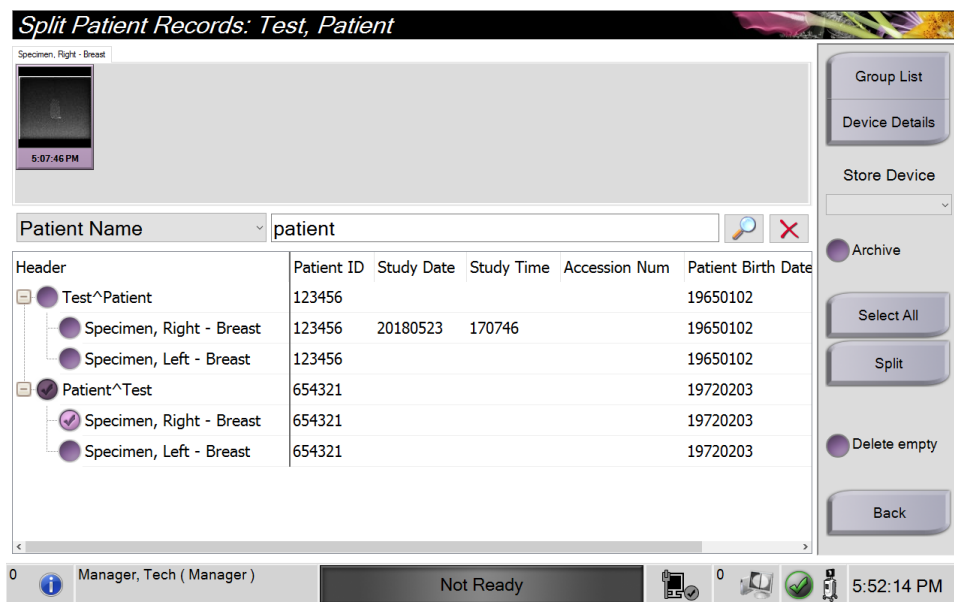

Figure 17: Select the Correct Patient to Split Patient Records

7. If ALL images are being moved and you want to delete the incorrect patient from the Patient List, select **Delete Empty**.
8. If you want to archive the images or save them to a stored device, select **Archive**. Verify that the correct outputs are selected.
9. Select **Split**, then select **OK** in the *Split Successful* message.

4.2.5 Delete a Patient

1. In the *Select Patient* screen, select one or more patients.
2. Select the **Delete** button.
3. When the confirmation dialog box opens, select **Yes**.



Note

A Primary System User can not delete patients, but a Manager can.



Note

Reclamation normally removes the requirement to delete patients.

4.2.6 Filters for Patients

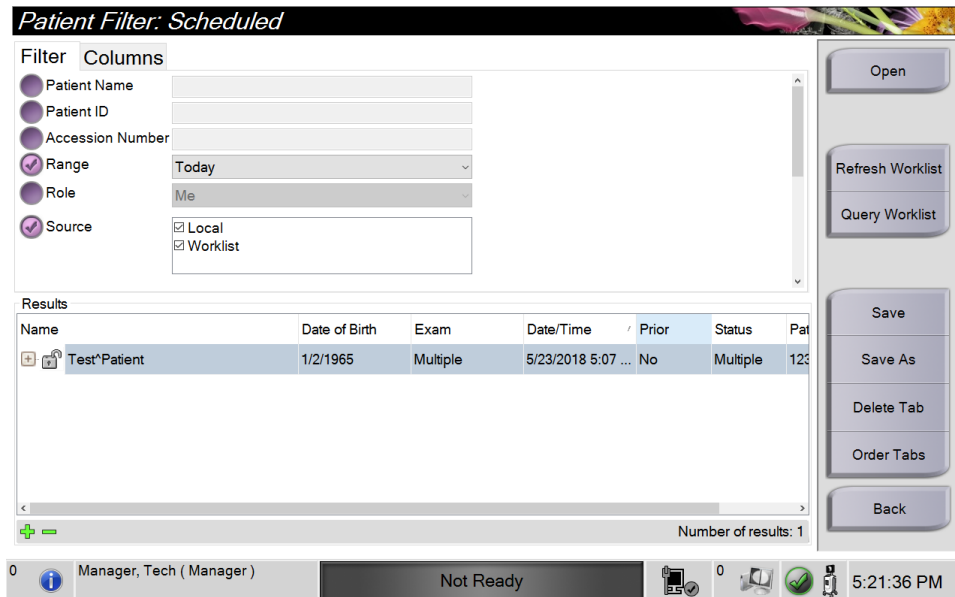

Figure 18: Filter Tab in the Patient Filter Screen

After selecting the **Filter** button in the *Select Patient* screen, the *Patient Filter* screen for the selected tab opens.

Filter Tab

Use the **Filter** tab to change the filter options for the patient list. When you select or cancel an option, the change shows in the Results area of the screen.



Note

You must have Manager level access to save these new filters to the selected tab in the *Select Patient* screen. (Refer to [Other Functions of the Filter Tab](#) on page 34.)



Note

When you select a line in the results list then select the **Open** button, the *Procedure* screen for the selected patient opens.

Other Functions of the Filter Tab

The **Filter** tab allows users with access privileges to add, change, or delete tabs in the *Select Patient* screen. Refer to the following table.

Table 3: Filter Tab Options (Require Access Privileges)

Change the current patient filter parameters.	<ol style="list-style-type: none"> 1. Select a tab on the <i>Select Patient</i> screen. 2. Select the Filter button. 3. Select the filter options. 4. Select the Save button. 5. Make sure the name of the tab you selected is in the name box. 6. Select OK.
Create a new tab for the <i>Select Patient</i> screen.	<ol style="list-style-type: none"> 1. Select a tab on the <i>Select Patient</i> screen. 2. Select the Filter button. 3. Select the filter options for the tab. 4. Select the Save As button. 5. Enter a new name for the tab. 6. Select OK.
Delete a tab from the <i>Select Patient</i> screen.	<ol style="list-style-type: none"> 1. Select a tab on the <i>Select Patient</i> screen. 2. Select the Filter button. 3. Select the Delete button. 4. Select Yes in the confirmation dialog box.

Columns Tab

Use the **Columns** tab to add more search options (for example, Age, Gender, Notices) to the filtered list. The options show as columns in the results area. To add more columns to a filtered list, select the **Columns** tab then select the options.



Note

You must have Manager level access to save these new columns to the patient filter.



Note

When you select a line in the results list then select the **Open** button, the *Procedure* screen for the selected patient opens.

Order Tabs Button

Select the **Order Tabs** button to change the order of the patient list tabs.

4.2.7 How to Refresh the Worklist

Select the **Refresh Worklist** button to update the patient lists.

4.2.8 How to Query the Worklist

Use the Query Worklist feature to search for a patient or a list of patients. Use one or more fields to query the Modality Worklist Provider. All fields to query are configurable. The default fields are as follows: Patient name, Patient ID, Accession Number, Requested Procedure ID, Scheduled Procedure Date. The scheduled procedure displays and the patient is added to the local database.

4.2.9 Admin

Select the **Admin** button to access the *Admin* screen and the system administration functions. Refer to [System Administration Interface](#) on page 67 for more information.

4.2.10 Close the Patient List

Select the **Close** button to exit the patient list and return to the *Startup* screen.

4.3 Procedure Screen

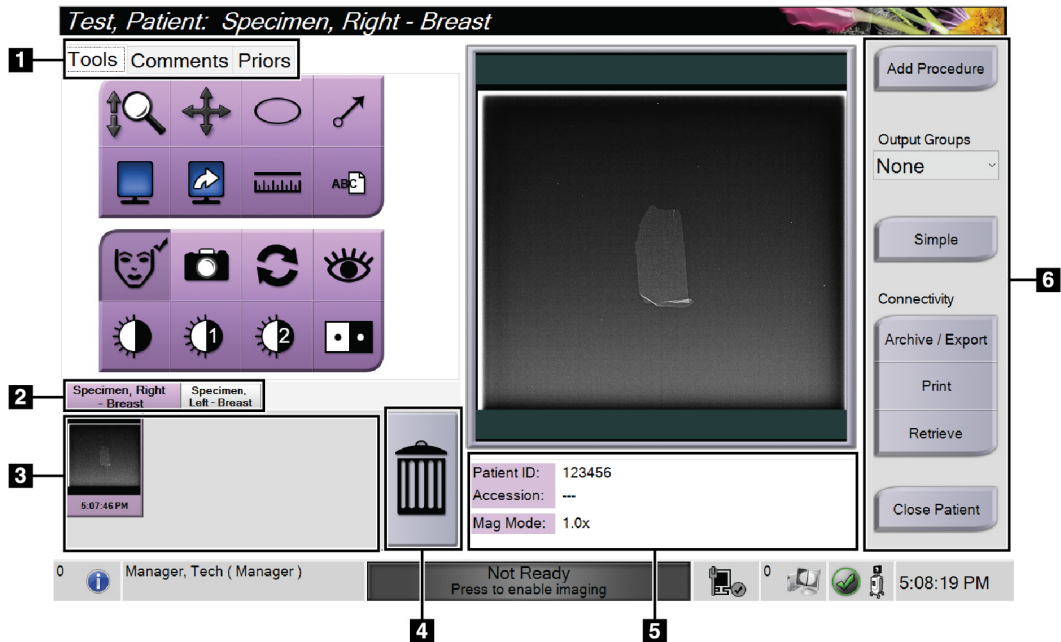

Figure 19: Procedure Screen

Table 4: The Procedure Screen

<p>1. Tabs</p>	<p>Select the Tools tab to review the images – refer to Image Review Tools on page 48.</p> <p>Select the Comments tab to add comments to the images – refer to Comments Tab on page 49.</p> <p>Select the Priors tab to review prior images for the patient – refer to Priors Tab on page 50.</p>
<p>2. Procedure Tabs</p>	<p>Shows the current procedures for the patient. Select the tab to select the desired procedure for the patient.</p> <p>Note: The tabs can be changed to display one or two lines of text – refer to Set Multi Line Procedure Tabs on page 71.</p>
<p>3. Thumbnails</p>	<p>Shows small icons of images related to the selected patient.</p> <p>A thumbnail image with a camera icon is a snapshot image. A snapshot image differs in size and resolution from the original image.</p>
<p>4. Trash Icon</p>	<p>Deletes a selected thumbnail image.</p> <p>Note: You cannot recover deleted images.</p>
<p>5. Procedure Information</p>	<p>Shows the Patient ID, Accession Number, and Magnification Level.</p>

Table 4: The Procedure Screen

<p>6. Buttons</p>	<p>Many functions are accessed from this screen by selecting a particular button:</p> <p>Add Procedure: Add a new procedure—refer to Add a Procedure on page 37.</p> <p>Simple and Advanced: Choose to show a larger or smaller set of image review tools on the Tools tab — refer to Simple and Advanced Button on page 38.</p> <p>Archive/Export: Send images to an output — refer to How to Use the On-Demand Outputs on page 40.</p> <p>Print: Print — refer to Print on page 41.</p> <p>Retrieve: Query the configured devices with the current patient information.</p> <p>Close Patient: Exit the patient and procedure — refer to Close a Patient on page 39.</p>
-------------------	--

4.3.1 Add a Procedure

1. To add another procedure, select the **Add Procedure** button to access the Add Procedure dialog box.

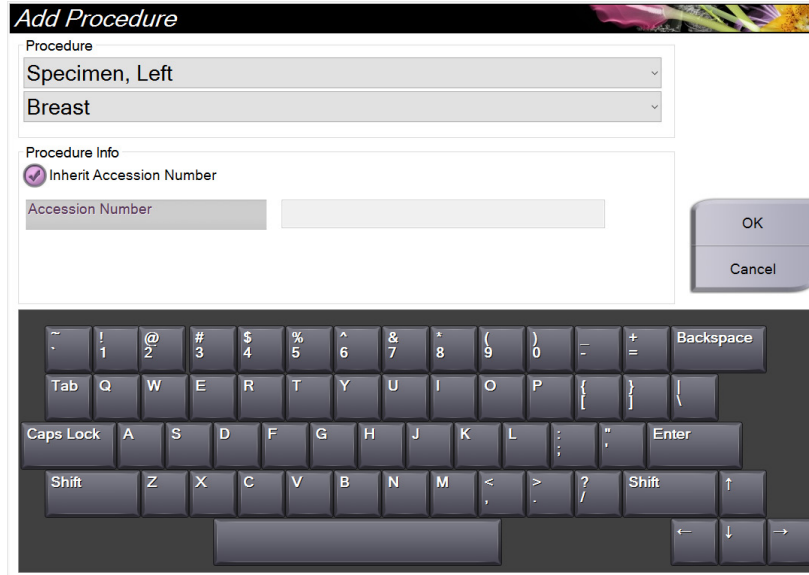

Figure 20: Add Procedure Dialog Box

2. Use the drop-down lists to select the type of procedure to add.
3. The current Accession Number is automatically used. To use a different Accession Number, deselect the "Inherit Accession Number" check box and enter the desired number.
4. Select **OK**. A new procedure tab is added for the procedure that was selected.

4.3.2 Simple and Advanced Button

You can show a smaller or larger set of image review tools on the **Tools** tab. This button toggles the set of tools that are displayed.

Select the **Simple** button to show the simplified version of the **Tools** tab with less image review tools.

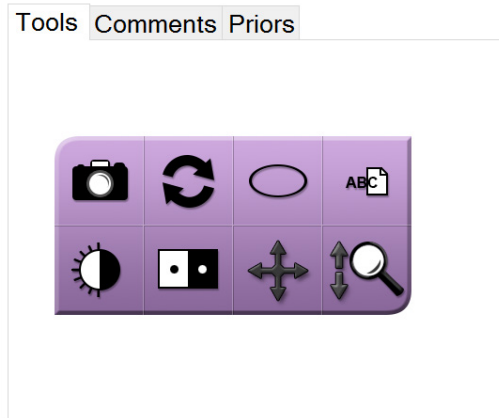

Figure 21: Tools Tab, Simple

Select the **Advanced** button to show the advanced version of the **Tools** tab with more image review tools.

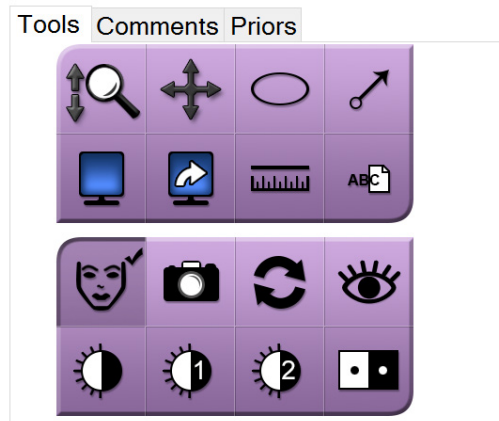

Figure 22: Tools Tab, Advanced

For information about the image review tools, refer to [Tools Tab](#) on page 48.

4.3.3 Retrieve

Select the **Retrieve** button to query the configured devices with the current patient information. The **Retrieve** button performs the same function as the **Query Retrieve** button in the *Admin* screen.

4.3.4 Close a Patient

Select the **Close Patient** button. The system returns to the *Select Patient* screen and automatically saves to the configured output devices any images that were not sent previously.

4.3.5 How to Select an Output Group

Select an output device set from the Output Groups drop-down list in the *Procedure* screen.

**Note**

Images are not sent if an Output Group is not selected.

4.4 How to Access Image Review Features

Select the **Tools** tab in the *Procedure* screen to access the image review features and tools. Refer to [Tools Tab](#) on page 48 for information.

4.5 How to Use the Output Groups

The images are sent automatically to the output devices in the selected Output Group when a patient is closed.

4.5.1 Add or Edit an Output Group

**Note**

The configuration of Output Groups occurs during installation, but you can edit existing groups or add new groups.

To add a new Output Group:

1. Access the *Admin* screen.
2. Select the **Manage Output Groups** button.
3. Select the **New** button, enter the information, then select the output device(s).
4. Select **Add**, then select **OK** in the *Update Successful* message.
5. You can select any group to set as the default.

To edit an Output Group:

1. Access the *Admin* screen.
2. Select the **Manage Output Groups** button.
3. Select the **Edit** button, then make the changes.
4. Select **Save**, then select **OK** in the *Update Successful* message.

4.6 How to Use the On-Demand Outputs

The On-Demand Outputs are: Archive, Print, or Export. You can manually Archive, Print, or Export an image until the procedure is closed.

When you press an On-Demand output button, you have the option to send the image to any of the configured Outputs.

4.6.1 How to Archive

1. Select the **Archive** button.
2. Select a storage device:
 - Select the **List Store Device** button and make your selection from the options that display.
 - OR -
 - Select the **List Output Group** button and make your selection from the options that display.
3. Select the **Send** button to copy all selected images from the opened case study to the selected device.



Note

Use the Manage Queue utility in the taskbar to review the archive status.

4.6.2 How to Export

1. Select the **Export** button.
2. Select a device (target) from the drop-down list.
3. Select the **START** button to copy all images from the open procedure to the selected device.



Note

To make the patient-related information not known in the output image, select the Anonymized check box.

4.6.3 Print

1. In the *Procedure* screen, select the **Print** button. The *Print* screen opens. Refer to the [figure](#) on page 41 to prepare your print information.
2. Select the film format from the Options area of the page.
3. Select a thumbnail image.
4. Select the image display box on the right side of the screen to put the selected thumbnail image on the film.
5. To put other thumbnail images on the film, repeat steps 2 to 4.
6. To print a different film format of the same images, select the **New Film** button and repeat steps 1 to 4.
7. Select the **Print** button to print your films.

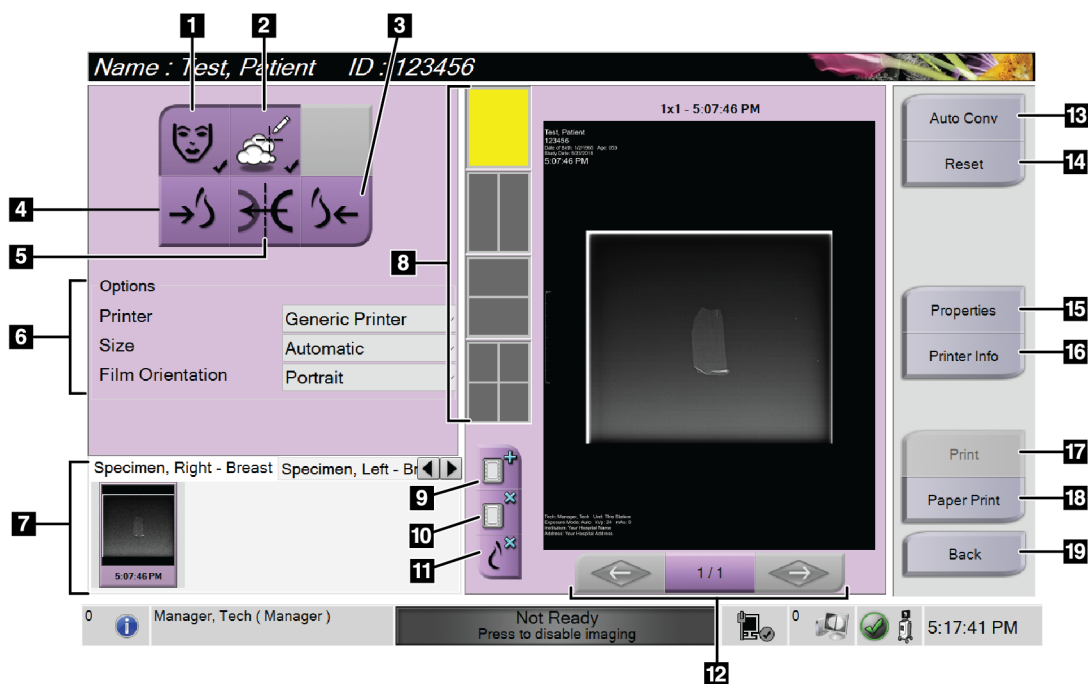

Figure 23: Print Screen

Figure Legend

1. Show or hide patient data.
2. Show or hide markings and annotations.
3. Print the image from a ventral perspective.
4. Print the image from a dorsal perspective.
5. Reverse (mirror) the image.
6. Select the printer options.
7. View thumbnail images.
8. Select the film format (number of tiles).
9. Create a new film.
10. Delete the current film.
11. Delete an image from the current film.
12. Step through the film pages.
13. Create (automatically) one film for each Conventional image.
14. Return the screen to previous settings.
15. Open the *Properties* screen for selection of printer defaults.
16. Show the printer IP address, AE Title, Port and capability for True Size print.
17. Start the print process.
18. Print the image on paper.
19. Return to the *Procedure* screen.

Chapter 5 The Images

5.1 Image Display Screen

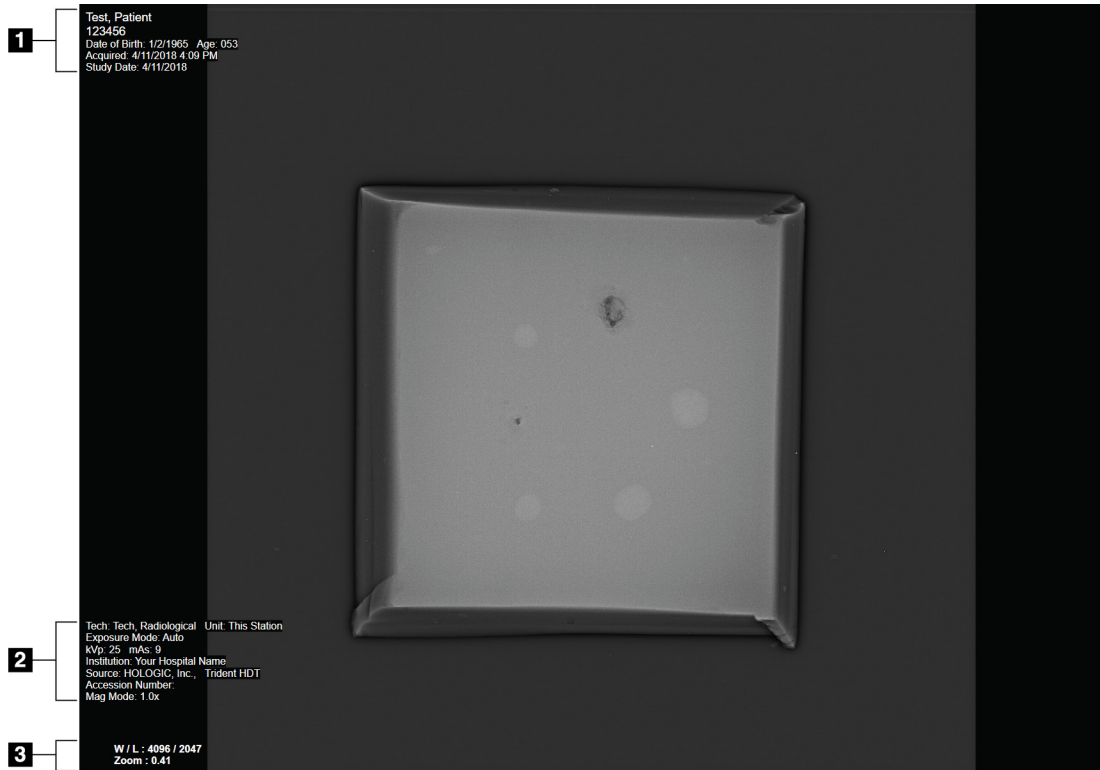

Figure 24: Image Display Screen

After you make an exposure, the acquired image opens on the Image Display monitor. Patient and procedure information can be displayed on the *Image Display* screen. To turn patient and procedure information on or off, go to the **Tools** tab in the *Procedure* screen and select the **Patient Information** button.

Figure Legend

1. Patient Information and Exam Date
2. Procedure and Facility Information including exposure techniques and technologist information
3. Image Review Tool information such as window/level and zoom values

5.2 How to Set the Exposure Techniques

Two exposure control modes (or AEC modes) are available for selecting exposure techniques.

- Auto mode is the recommended mode for exposure techniques. In Auto mode, the system automatically selects the kV and mAs values.
- Manual mode can be used if desired. In Manual mode, the user selects the kV and mAs.

To change the exposure mode:

1. Select the **console** icon in the taskbar to open the Faults menu.
2. In the Faults menu, select **Exposure Settings**. The *Exposure Settings* screen opens.
3. Under "AEC Mode", use the + or - buttons to select the mode.
4. In Manual mode, select the kV and mAs values.
 - To increase or decrease an Exposure Technique in one step increments, select then release the + or - button.
 - To move quickly through the values for an Exposure Technique, select and hold the + or - button.
5. Select the **Back** button to return to the original screen.



Note

If you change the exposure settings, the new exposure techniques become the default values until a patient is closed.

5.3 How to Acquire an Image

1. Center the specimen on the specimen tray within the markings for the magnification level needed.
2. Position the specimen tray in the Imaging Cabinet for the magnification level needed.
3. Close the Imaging Cabinet door.
4. Select the **X-ray Enable** bar to enable the x-ray. The bar changes to green and displays a Ready status. The **X-RAY** button illuminates green on the bottom right side of the Control display.



Figure 25: Imaging Enabled

5. Press and release the **X-RAY** button.



Figure 26: X-RAY Button

During the exposure:

- The **X-RAY** button changes to yellow to indicate that the x-ray emission sequence has started. The radiation symbol illuminates below the **X-RAY** button. (See the following figure.)



Figure 27: X-RAY Button while the Exposure Is in Progress

- An audible tone sounds with each exposure; 10 individual beeps are heard during the exposure sequence.

After the exposure ends:

- The image opens on the Image Display monitor and a thumbnail image appears in the thumbnail area of the *Procedure* screen. The image is automatically accepted.
6. To acquire another image, select the **X-ray Enable** bar, then press the **X-RAY** button.

To stop an exposure before automatic termination, press the **X-RAY** button. An error message is displayed.

To start another exposure after you stopped one before automatic termination:

1. Select **OK** in the error message.
2. Select the **console** icon in the taskbar.
3. Select **Clear All Faults**.
4. Enable the X-ray.
5. Press the **X-RAY** button.

To delete an image, select the thumbnail image then select the **trash can** icon.



Note

You cannot restore a deleted image.

Refer to [Sample Clinical Sequences](#) on page 53 for additional information.

5.4 How to Review the Images

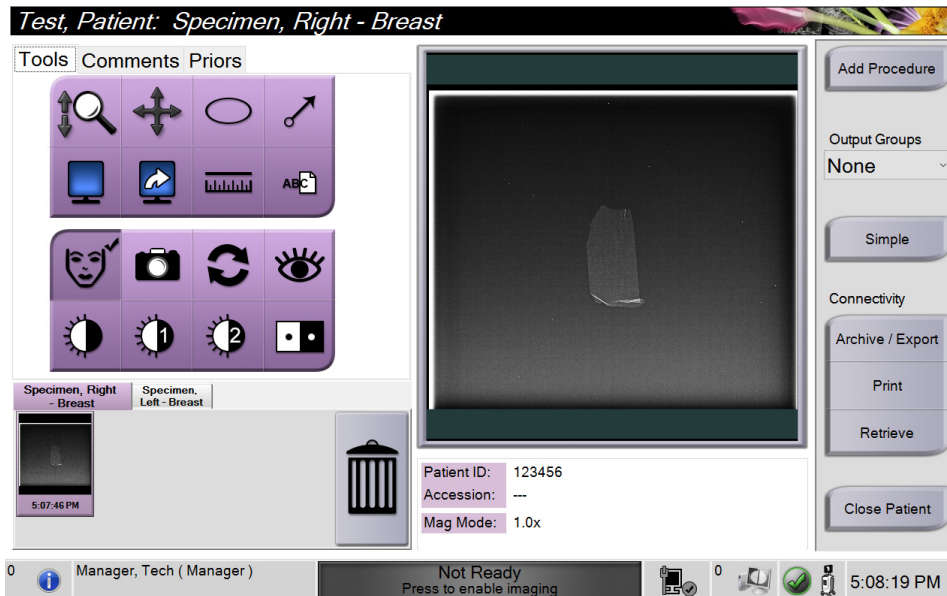

Figure 28: Tools Tab in the Procedure Screen

1. Select a thumbnail image. The image opens in the preview area of the *Procedure* screen and on the Image Display monitor.
 - When the image review tools are used, the preview image shows the relationship between the area that is selected with the tool and the whole image.
2. Use the image review tools (refer to [Tools Tab](#) on page 48) to enhance the whole image or areas of interest in the image.

5.4.1 Image Review Tools

Tools Tab

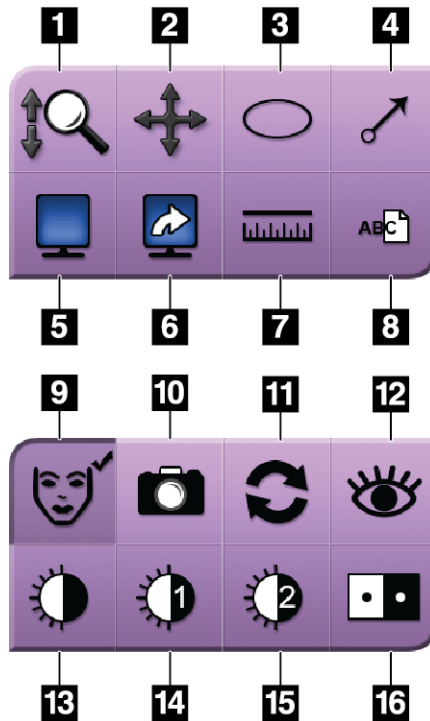

Figure 29: The Image Review Tools

Figure Legend

1. The **Zoom** tool magnifies the whole image.
2. The **Pan** tool is used to move the view to a different portion of the image by dragging.
3. The **Ellipse** tool draws an elliptical pattern in the image. You can change the size and move this pattern within the display area, and you can add the text to this pattern.
4. The **Arrow** tool creates an arrow to point to an area of interest. You can change the size, move the arrow within the display area, and add the text to this pattern.
5. The **Multi-Up Display** tool selects the number of tiles to display.
6. The **Image Tile Advance** tool sets the active Multi-Up tile.
7. The **Ruler** tool displays a measurement of the distance between two points. To move the measurement line, click and drag the line to the new location.
8. The **Text** tool adds a text note to the image without a marking.

9. The **Patient Information** tool activates the patient information display.
10. The **Camera** button captures a snapshot of the image display area and adds the snapshot to the current procedure.
11. The **Reset** tool returns an enhanced image to the original state.
12. The **Enhanced Visualization** tool adjusts the image sharpness with a slider.
13. The **Window/Level** tool is used with the mouse to change the brightness and contrast. To reset the Window/Level to the original values, double-click the image.
14. The **Pre-defined Window/Level** tools set the values most used.
15. The **Pre-defined Window/Level** tools set the values most used.
16. The **Invert** tool changes blacks to white and whites to black.



Note

The Ruler, W/L Presets, and Enhanced Visualization tool are inactive for snapshot images.



Note

To save markings and comments, use the **Camera** button to create a snapshot of the image with the markings and comments.

You can toggle between two sets of image review tools in the **Tools** tab. Select the **Advanced** button to show all the image review tools. Select the **Simple** button to show only the basic image review tools.

When an image review tool is active, a check mark is displayed on the tool button.

To save markings and annotations on an image, select the **Camera** tool to capture an image of the *Image Display* screen. A thumbnail of the snapshot is added to the **Procedure** tab and the snapshot image is saved to the procedure.

Comments Tab

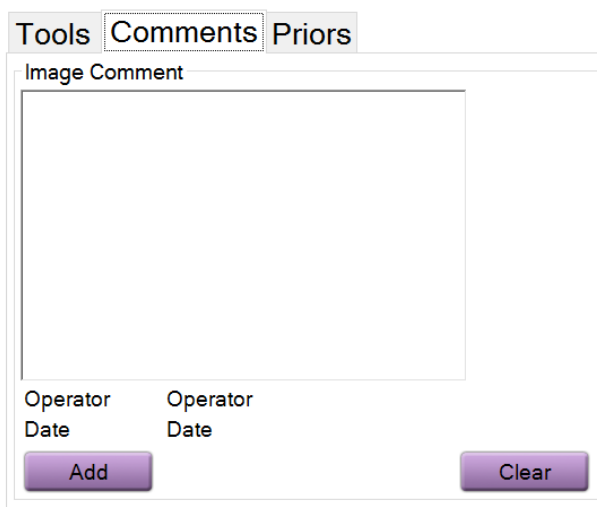

Figure 30: The Comments Tab

This feature allows you to make notes or comments about image content. This information is saved in the DICOM header. The information is not displayed on the Image Display monitor.

To add comments to an image:

1. Select the **Add** button. A screen with a virtual keyboard opens.
2. In the Image Comment box, select an option from the list.
3. Use the virtual keyboard to add comments in the Additional Item area.
4. Select the **Save** button to save the comments and return to the *Procedure* screen.

Priors Tab

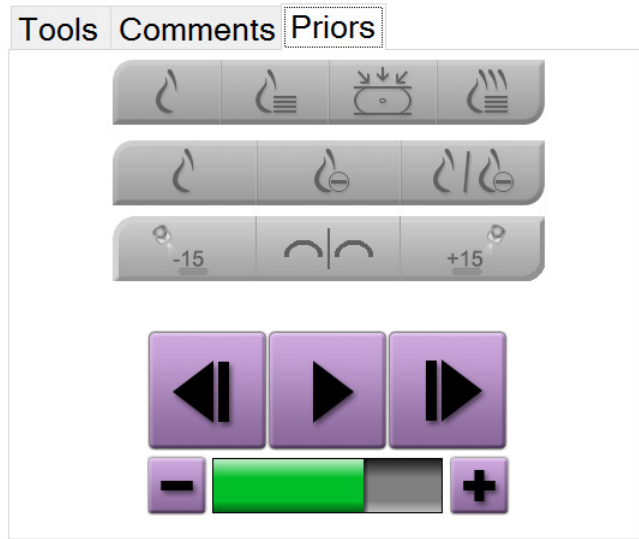

Figure 31: Priors Tab

You can retrieve or import prior DICOM images for a patient and view them on the system. The type of image you are viewing determines which buttons you can use.

Display Modes

Use the buttons in the Display Modes area of the screen to select the type of view to show on the Image Display monitor. You can change between conventional 2D, synthesized 2D, tomosynthesis projections, and reconstructions to show the combination images.

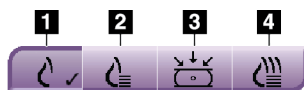

Figure 32: Display Modes

Figure Legend

1. **Conventional** button shows conventional 2D images.
2. **Generated 2D** button shows a synthesized 2D image generated from a set of tomosynthesis images.
3. **Projections** button shows the 15° projection images.
4. **Reconstructions** button shows reconstructed slices.

Contrast Views

- **Low Energy** button
- **Subtracted** button
- **Low Energy/Subtracted Split** button

Stereo Pair Views

- Select the **-15** button to show that stereo image.
- Select the **+15** button to show that stereo image.
- Select the middle button to make a 2-up horizontal layout with the +15 degree image on top and the -15 degree image on the bottom.

Cine Views

- Use the arrow buttons to manually move through a set of tomosynthesis images one at a time.
- Use the play/pause button to show the set of images as a movie.
- The green bar shows the speed of the cine. Use the + and - buttons to adjust the cine speed.

5.5 Send the Images to the Output Devices

You can send the images to output devices or use the Export function to copy images to a temporary storage device. Refer to [How to Use the Output Groups](#) on page 39 for instructions.

Chapter 6 Sample Clinical Sequences

6.1 Example Imaging Workflow

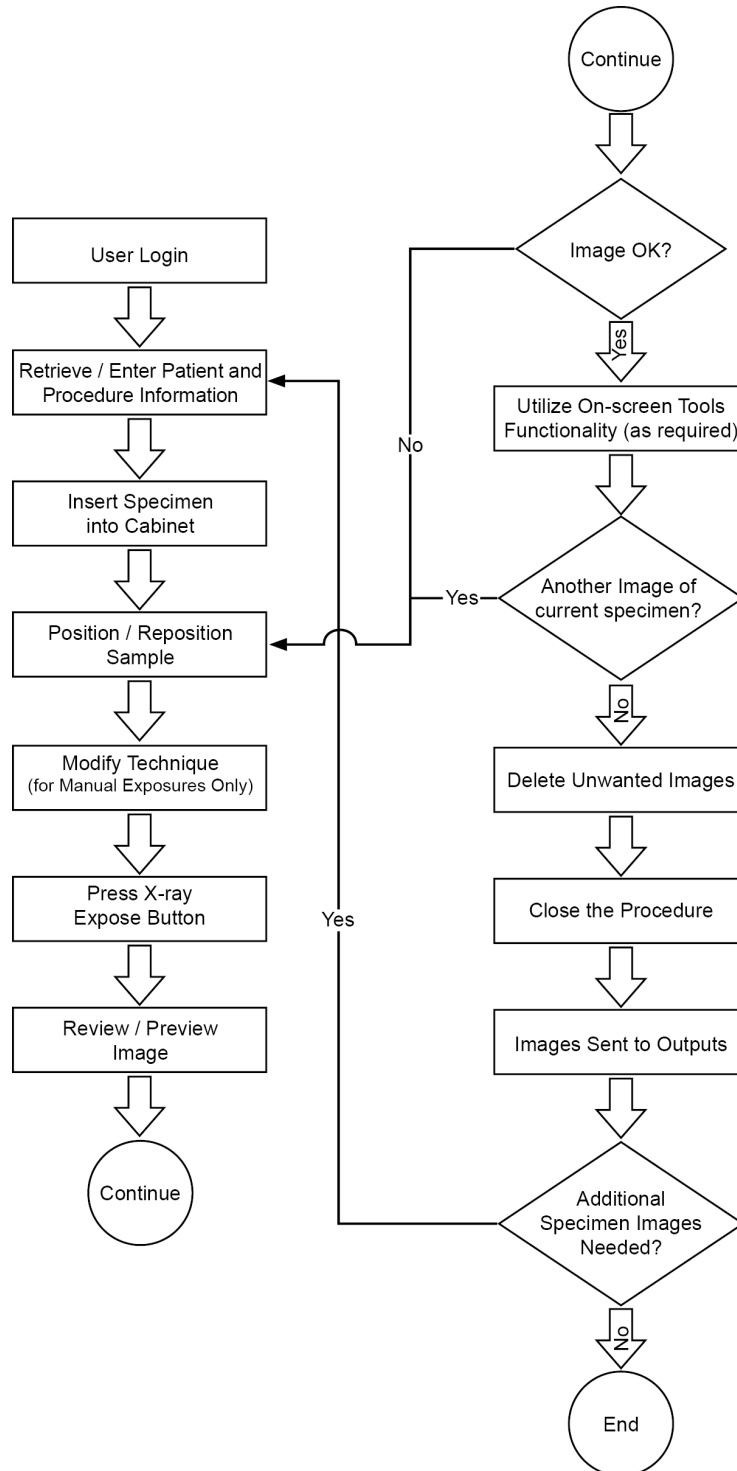

6.2 Example Sequence of Operation

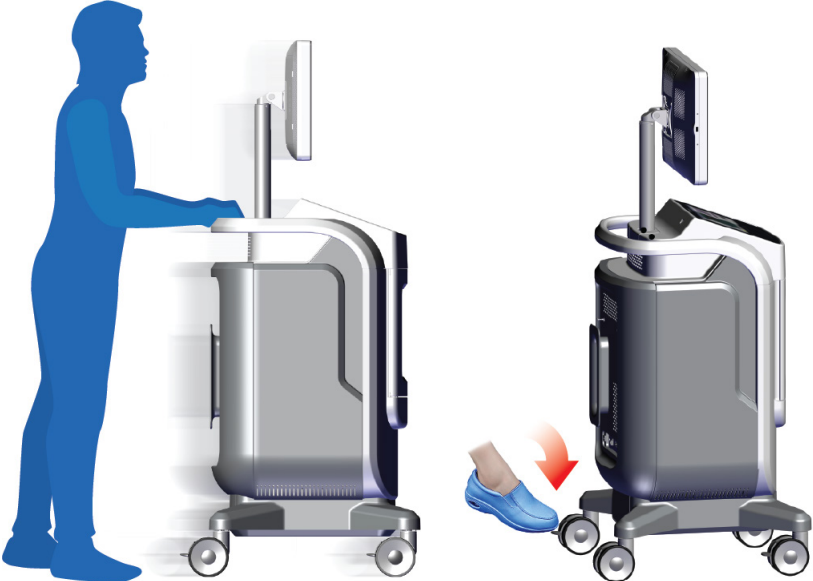
Step	Where This Action Is Done
Move the console to the correct location. Lock the casters.	 An illustration showing a person in a blue silhouette moving a large, grey, mobile console. The console has a monitor on a stand. To the right, a foot in a blue shoe is shown stepping on one of the casters, with a red arrow pointing down, indicating the action of locking the casters.
Connect the system to power and the network.	 An illustration of the console's rear panel. Two cables are plugged into the back: a power cord and a network cable. Red arrows point from the cables to their respective ports on the wall outlet.

Start the system and log in.

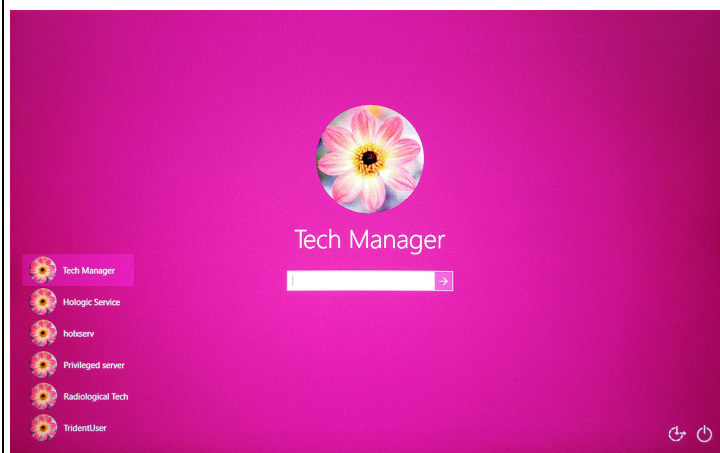
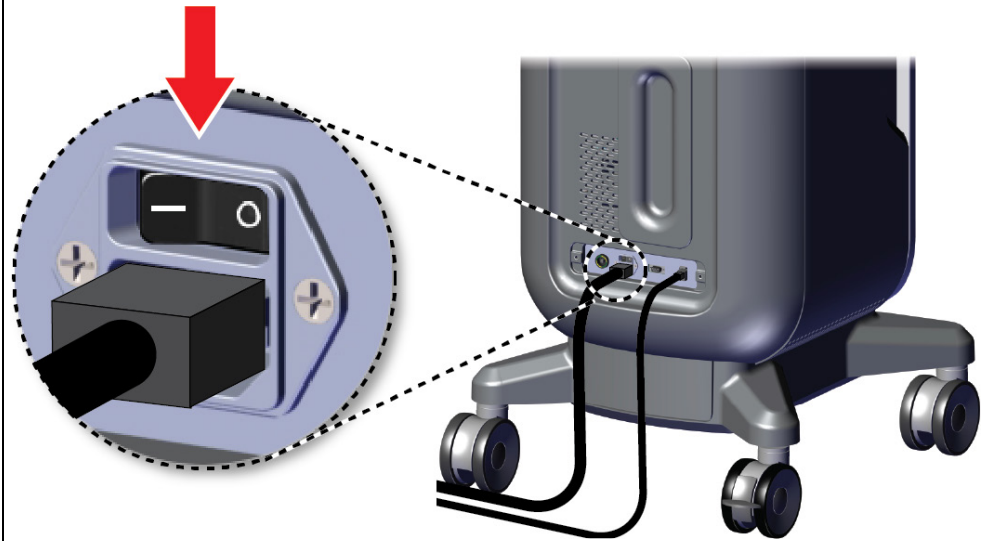

Trident HD Specimen Radiography System User Guide

Chapter 6: Sample Clinical Sequences

Select the patient and procedure.

Faxitron™ Trident® HD Specimen Radiography System



0 Manager, Tech (Manager) Not Ready 4:08:07 PM

Select Patient

Patient Name

Scheduled All

Name	Date of Birth	Exam	Date/Time	Prior	Status	Pa
Patient*Test	2/3/1979	Specimen, Rig...		No	Scheduled	65
Test*Test Patient	3/4/1972	Specimen, Un...		No	Scheduled	45
Patient*Patient Test	4/5/1957	Specimen, Left...		No	Scheduled	32
Test*Patient	12/17/1972	Specimen, Rig...		No	Scheduled	98

Number of results: 4



Test, Patient: Specimen, Right - Breast

Tools Comments Priors

Specimen, Right - Breast | Specimen, Left - Breast

Patient ID: 123456
Accession: ---
Mag Mode: 1.0x

Add Procedure
Output Groups: None
Simple
Connectivity
Archive / Export
Print
Retrieve
Close Patient



Prepare the specimen per facility policy and center on the specimen tray.

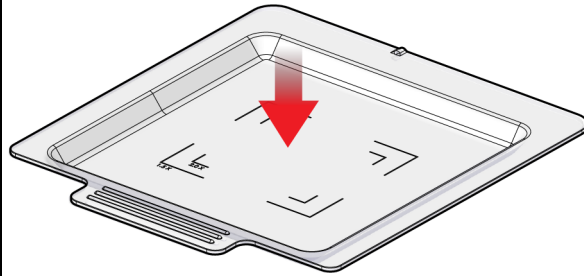

Position the specimen tray in the imaging cabinet for the required magnification level. Close the door.

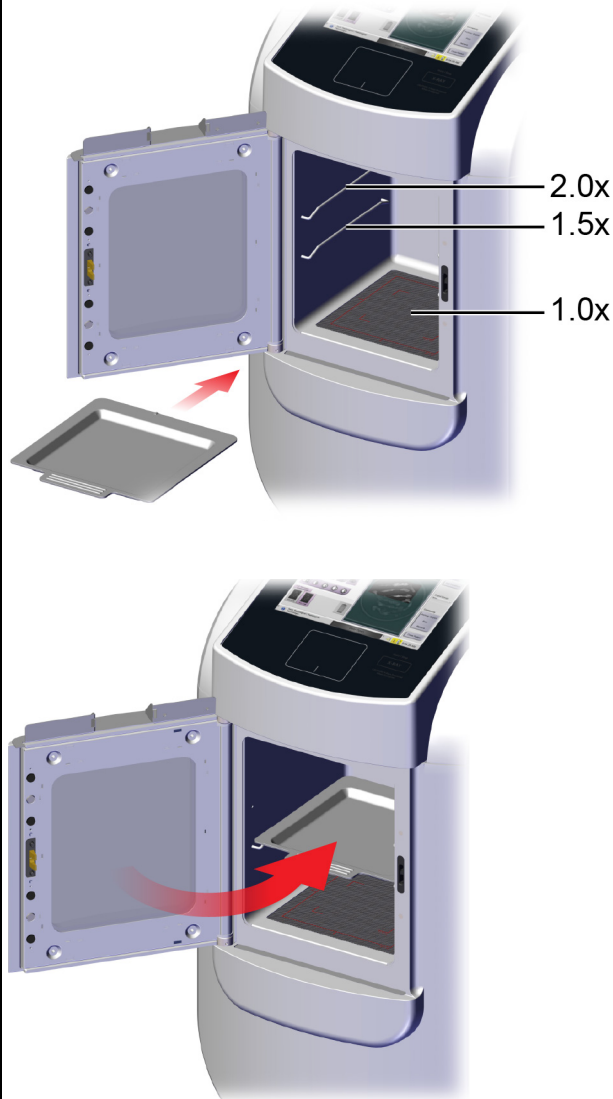

Trident HD Specimen Radiography System User Guide

Chapter 6: Sample Clinical Sequences

Acquire the image.

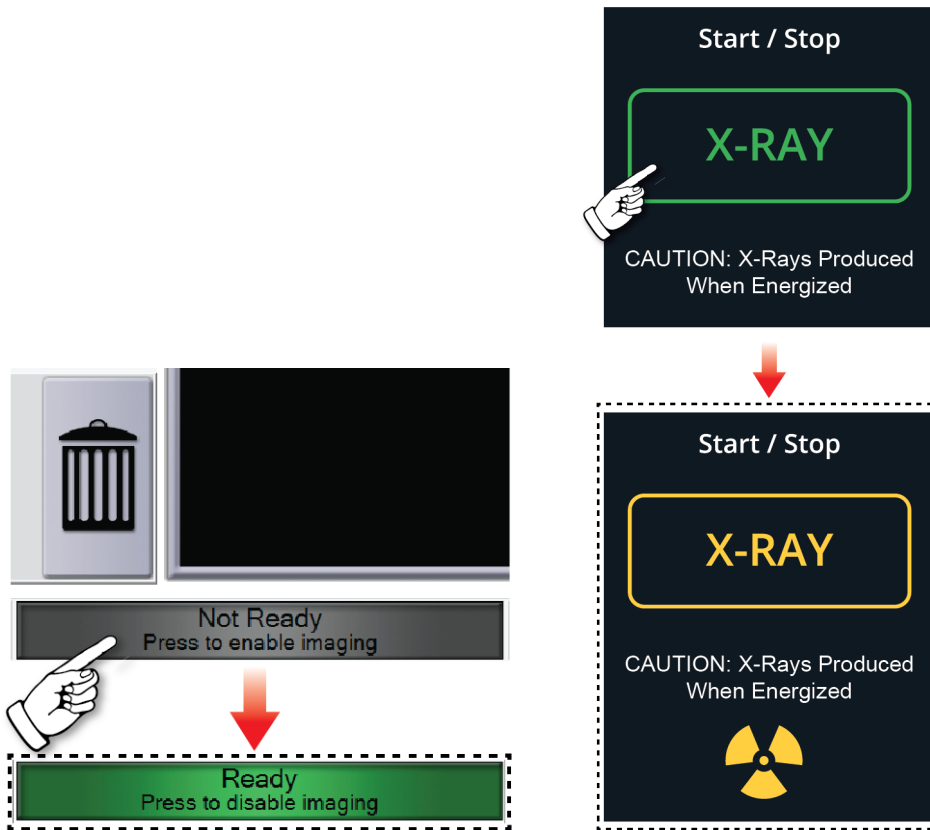

Review the image.

The screenshot shows the main interface for reviewing a specimen image. At the top, it says "Test, Patient: Specimen, Right - Breast". Below this are tabs for "Tools", "Comments", and "Priors". The "Tools" tab is active, displaying a grid of icons for zooming, panning, and other image manipulation functions. To the right of the image is a vertical toolbar with buttons for "Add Procedure", "Output Groups" (set to "None"), "Simple", "Connectivity", "Archive / Export", "Print", "Retrieve", and "Close Patient". Below the image, there are fields for "Patient ID: 123456", "Accession: ---", and "Mag Mode: 1.0x". At the bottom, a status bar shows "Manager, Tech (Manager)", "Not Ready Press to enable imaging", and the time "5:08:19 PM".

This is a close-up of the "Tools" toolbar. It contains two rows of icons. The first row includes a magnifying glass with a double-headed arrow, a four-way arrow, an oval, and a cursor arrow. The second row includes a monitor icon, a refresh icon, a ruler, and an "ABC" icon. The third row includes a face icon, a camera icon, a circular arrow, and an eye icon. The fourth row includes a half-moon icon, a moon with "1", a moon with "2", and a square with a dot.

This screenshot shows the "Comments" section. It has tabs for "Tools", "Comments", and "Priors", with "Comments" selected. Below the tabs is a text area labeled "Image Comment". At the bottom, there are fields for "Operator" and "Date", each with a corresponding label. There are "Add" and "Clear" buttons at the bottom.

Archive or export the images, then close the patient.

This diagram shows two red arrows pointing to the "Archive / Export" and "Close Patient" buttons from the interface. The "Archive / Export" button is above the "Close Patient" button.

Trident HD Specimen Radiography System User Guide

Chapter 6: Sample Clinical Sequences

Remove the specimen tray from the imaging cabinet. Follow facility policy for specimen handling.

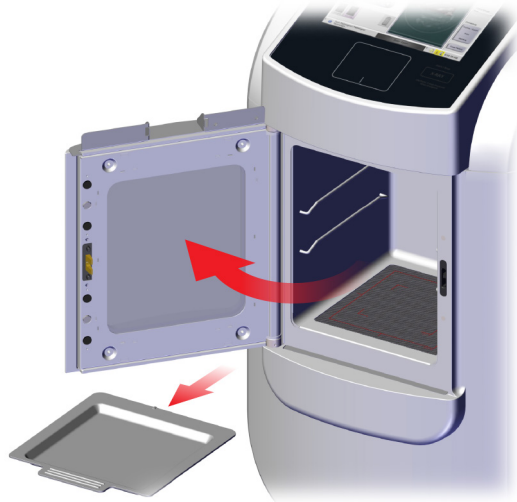

Turn off the system.

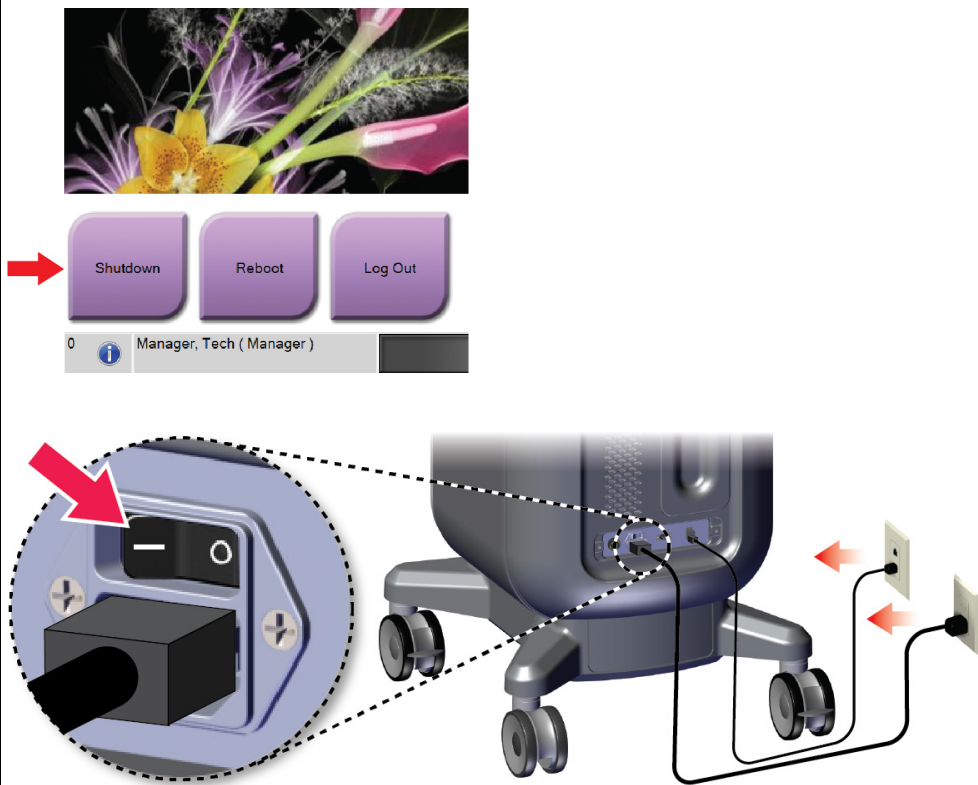

Clean the system.

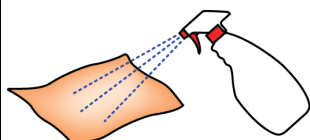

Chapter 7 Quality Control

7.1 Required Quality Control Procedures

The following procedures are necessary for correct system operation.

Table 5: Required Procedures

Test	Frequency
Gain Calibration	Monthly

7.2 How to Access the Quality Control Tasks

From the *Admin* screen, select one of the following buttons: **Gain Calibration** or **Test Patterns**. All Quality Control Tasks can be accessed this way at any time.



7.2.1 Gain Calibration

Do the Gain Calibration monthly and when artifacts are seen.



Note

When the system shows the Gain Calibration message, do the procedure before you shut down the system. If you do the Gain Calibration at a different time, access the procedure through the *Admin* screen.

1. Select **Yes** to do the calibration now.
2. If you select to do the calibration now, you are prompted to select the Gain Calibration mode (*Automatic*, *Automatic with Shutdown*, or *Manual*).
3. Select the Gain Calibration mode.
4. Make sure that the acrylic block and the contact surface (bottom) of the Imaging Cabinet are clean. When the message to insert the Specimen Stage appears, remove the specimen tray and place the acrylic block in the Imaging Cabinet.



Note

Artifacts that appear on the acrylic block provided by the manufacturer must not be overlooked. Such artifacts will have an impact on detector calibration.

5. Make sure that there are no other items in the Imaging Cabinet and close the Cabinet door.
6. Images are taken in the following manner:
 - *Automatic Gain Calibration*: The system takes six images and does the Gain Calibration automatically, then logs out the user.
 - *Automatic with Shutdown Gain Calibration*: The system takes six images and does the Gain Calibration automatically, then shuts down the system.
 - *Manual Gain Calibration*:
 - a. Press the **X-RAY** button.
 - b. Wait for the system to return to the **READY** state, then press the **X-RAY** button.
 - c. Repeat step b until you acquire six images.
7. When the Gain Calibration is finished, a message about successful completion is displayed.

Chapter 8 Maintenance, Cleaning, and Disinfecting

8.1 General Information

8.1.1 For General Cleaning

This procedure includes cleaning the unit and the surfaces that the specimens do not contact.

Use a lint-free cloth and apply a diluted dishwashing liquid to clean components and surfaces.



Caution:

Use the least possible amount of cleaning fluids. The fluids must not flow or run.

8.1.2 For Disinfecting

To disinfect the system's components and surfaces, Hologic recommends the following disinfecting solutions:

- 10% chlorine bleach solution and water with one part commercially available chlorine bleach solution (normally 5.25% chlorine and 94.75% water) and nine parts water. Mix this solution daily for best results.
- Commercially available isopropyl alcohol solution (70% isopropyl alcohol by volume, not diluted)
- 3% maximum concentration of hydrogen peroxide solution

After you apply any of the above solutions, use a clean cloth to clean the system, observing appropriate contact (wet) times.



Caution:

To prevent damage to the electronic components, do not use disinfectant sprays on the system.

8.1.3 To Prevent Possible Injury or Equipment Damage

Do not use a corrosive solvent, abrasive detergent, or polish. Select a cleaning/disinfecting agent that does not damage the plastics, aluminum, or carbon fiber.

Do not use strong detergents, abrasive cleaners, high alcohol concentration, or methanol at any concentration.

Do not expose equipment parts to steam or high temperature sterilization.

Do not let liquids enter the internal parts of the equipment. Do not apply cleaning sprays or liquids to the equipment. Always use a clean cloth and apply the spray or liquid to the cloth. If liquid enters the system, disconnect the electrical supply and examine the system before returning it to use.



Caution:

Wrong cleaning methods can damage the equipment, decrease imaging performance, or increase the risk of electric shock.

Always follow instructions from the manufacturer of the product you use for cleaning. The instructions include the directions and precautions for the application and contact time, storage, wash requirements, protective clothing, shelf life, and disposal. Follow the instructions and use the product in the most safe and effective method.

8.2 Component Specific Care

8.2.1 How to Clean the Image Display Monitor

- Do not touch the display when working with specimens.
- Use care when you clean the outer surface of the display area.
- Always use a clean, soft, lint-free cloth to clean the display area. Microfiber cloths, available at most stores, are recommended.
- Strong chemicals and abrasives can damage the display and should never be used.
- Never use a spray or flow a liquid onto the display.
- Never apply pressure to the display area.
- Never use a detergent with fluorides, ammonia, alcohol, or abrasives.
- Never use bleach.
- Never use steel wool.
- Never use a sponge with abrasives.

There are many commercially available products to clean LCD displays. Any product that is free of ingredients or abrasives described above and used according to the directions of the manufacturer can be safely used.

8.2.2 Power Cord

How to Inspect the Power Cord

1. Once every quarter, visually inspect the power cord for cuts, damage to the cover, or strain relief.
2. If the power cord appears damaged, contact Hologic for replacement of the power cord.

8.3 Maintenance

8.3.1 Preventive Maintenance Schedules

Table 6: User Preventive Maintenance

Action	Recommended Frequency			
	Each Use	Each Week	Each Month	As Required
Clean and disinfect the specimen tray	✓			
Clean and disinfect the contact surface	✓			
Perform Gain Calibration			✓	
Clean and disinfect the Imaging Cabinet chamber				✓
Clean and disinfect the cabinet door handle				✓
Clean and disinfect the control display surface				✓

Table 7: Service Preventive Maintenance

Action	Done Annually
Perform Check Sensor Status	✓
Condition the X-Ray Source	✓
Perform kV Verification	✓
Perform mAs Verification	✓
Perform Flat Field Artifact Evaluation	✓
Perform X-Ray Tub Alignment Evaluation	✓
Perform System Resolution Test	✓
Perform AEC Function Test	✓
Perform ACR Phantom Test	✓
Perform X-Ray Leakage Test	✓
Change image detector filter	✓
Check for mechanical integrity and missing hardware	✓
Inspect wiring for power and ground integrity	✓

8.3.2 About Reclamation

Reclamation is an automatic function that makes disk space available for storing newly acquired images. Configurable parameters let a given number of images collect before reclamation starts and older images are removed from the system.

Chapter 9 System Administration Interface

9.1 Admin Screen

This section tells about the functions available in the *Admin* screen. To access this screen, select the **Admin** button in the *Select Patient* screen.



Note

A Manager and a Hologic Service User have access to all functions on the Admin screen. A Primary Specimen User has access to some functions.



Figure 33: Admin Screen

Table 8: Admin Screen Functions

Section	Button	Screen Function
Operators	Manage Operators	Add, delete, or change Operator information.
	My Settings	Change the information for the current Operator.
	Training	Access training videos.
	User Manual	Access the <i>User Guide</i> and other user documents.
	Windows OS Tools	Access local users and groups, security policy, and group policy.
Procedures	Procedure Editor	Add, edit, or delete the procedures.
	Procedure Order	Change the procedure list order.

Trident HD Specimen Radiography System User Guide

Chapter 9: System Administration Interface

Table 8: Admin Screen Functions

Section	Button	Screen Function
Quality Control	Gain Calibration	Perform the Gain Calibration procedure.
	QC Report	Create a QC Report.
	Test Patterns	Select and send the test patterns to output devices.
System	System Tools	The Interface for Service for the configuration of and identification of problems.
	System Diagnostics	Shows the status of all subsystems.
	Preferences	Set the system preferences.
	About	Shows system information.
	Exposure Report	Create a report of the number of exposures.
	Archive	Send local studies to networked storage or export to removable media devices.
Connectivity	Query Retrieve	Query the configured devices.
	Import	Import images and data.
	Manage Output Groups	Add, delete, or edit output groups.
	Incoming Log	Shows log entries for images that do not import during manual import or DICOM store.

You must have permissions to access all features. The permission level controls the functions you can change.

9.2 About Screen

The *About* screen provides information about the machine, such as system level, IP address, and serial number. This type of data can be useful when working with Hologic to configure the system or resolve a system issue.

The screen is accessed in two ways:

- From the *Select Patient* screen, select the **System Status** icon [] on the taskbar, then select **About**.
- From the *Admin* screen, select the **About** button in the System group.

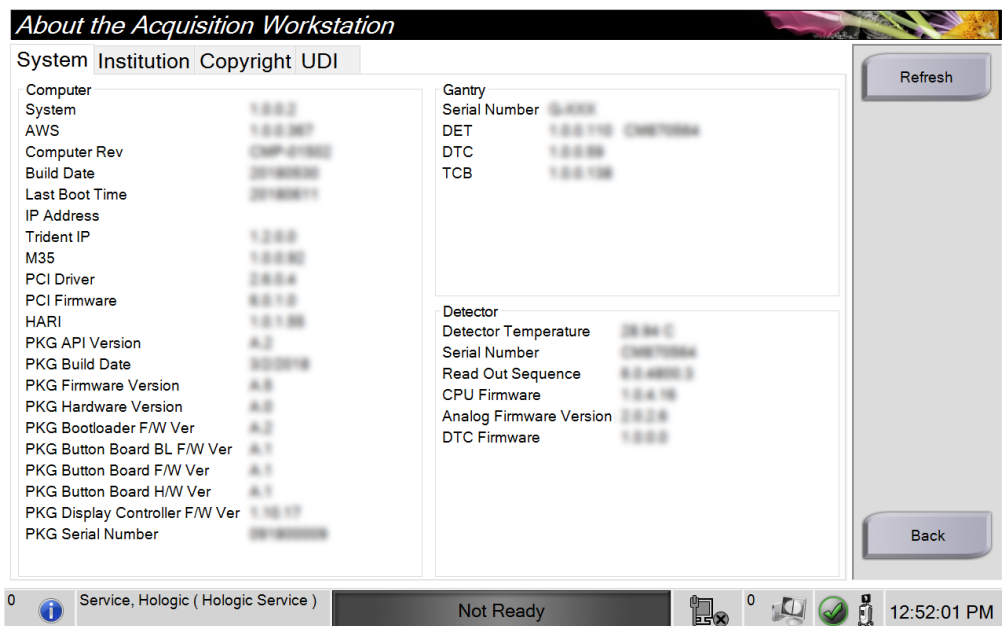

Figure 34: System Tab of the About Screen

There are four tabs on the *About* screen:

- **System Tab** lists system configuration information.
- **Institution Tab** lists the name and address of the organization assigned to this machine.
- **Copyright Tab** lists the copyrights of Hologic and third-party software installed on this machine.
- **UDI Tab** lists the unique device identifier(s) of this machine.

9.3 Change the User Language Preference

Users can set the language on the user interface to automatically change to their individual preference when logging in.

1. At the *Select Patient* screen, select the **Admin** button.



Note

You can also access **My Settings** through the taskbar. Select the User Name area then select **My Settings** in the pop-up menu.

2. In the Operators group of the *Admin* screen, select the **My Settings** button. The *Edit Operator* screen opens.
3. Use the **Right Arrow** button to go to the fourth page of the Edit Operator screen. (You can also use the round buttons above the virtual keyboard to select the fourth page.)
4. In the Locale field, select the language from the drop-down list.
5. Select **Save**, then select **OK** to the *Update Successful* message. The user interface changes to the selected language.

9.4 Set Multi Line Procedure Tabs

You can set the operator preferences to display more of the procedure name in the top of the procedure tabs. To change the procedure tabs from a single line of text to multiple lines of text:

1. At the *Select Patient* screen, select the **Admin** button.



Note

You can also access **My Settings** through the taskbar. Select the User Name area then select **My Settings** in the pop-up menu.

2. In the Operators group of the *Admin* screen, select the **My Settings** button. The *Edit Operator* screen opens.
3. Use the **Right Arrow** button to go to the fourth page of the Edit Operator screen. (You can also use the round buttons above the virtual keyboard to select the fourth page.)
4. Select Use Multi Line Procedure Tabs. A check mark appears when the Multi Line option is selected.
5. Select **Save**, then select **OK** to the *Update Successful* message. The **Procedure** tabs change to the selected amount of lines.

9.5 System Tools

Managers and users with Service permissions can access the System Tools utility. The System Tools utility contains the configuration information about the system. To access the utility, select **System Tools** from the System group in the *Admin* screen.

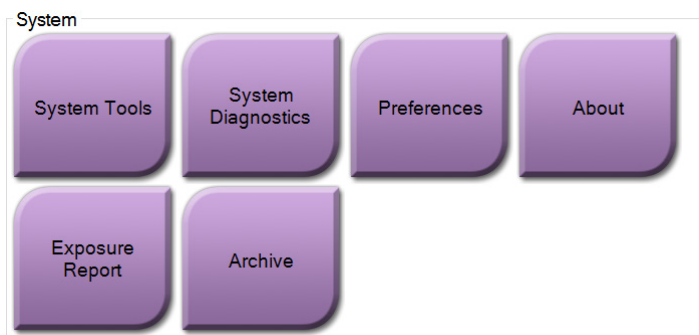

Figure 35: System Tools Button

9.5.1 System Tools for the Radiologic Technologist Manager

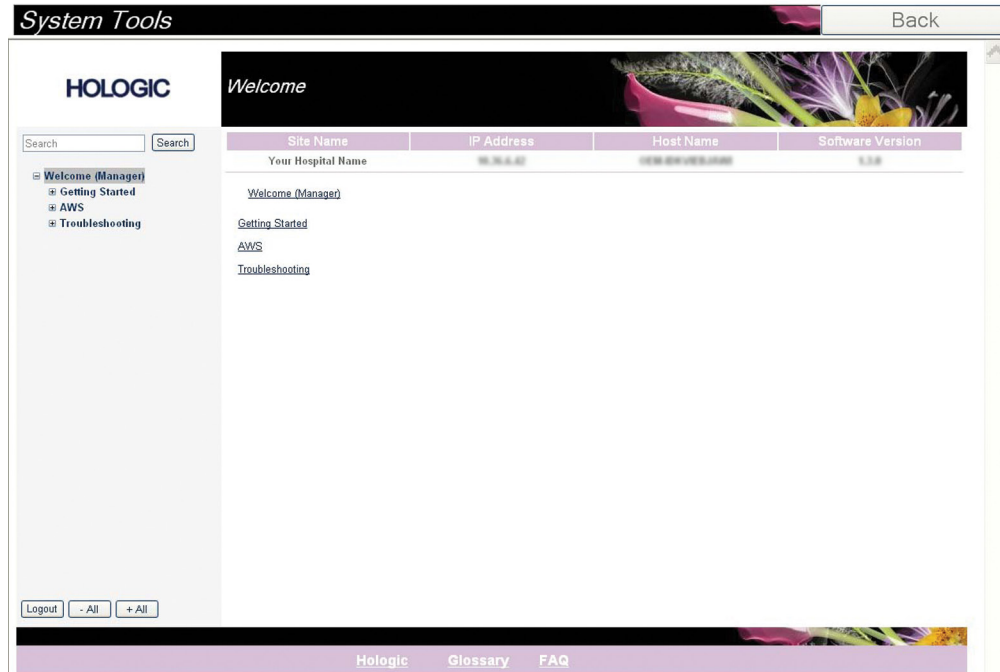

Figure 36: System Tools Screen

Table 9: Radiologic Technologist Manager – System Tools Functions

Section	Screen Functions
Getting Started	<p>About: The introduction to the service tool.</p> <p>FAQ: List of common questions.</p> <p>Glossary: List of terms and descriptions.</p> <p>Platform: List of directories, software version numbers, and system software statistics.</p> <p>Shortcuts: List of Windows shortcuts.</p>
AWS	<p>Connectivity: List of Installed Devices.</p> <p>Film & Image Information: Create an Exposure Report or a QC Report.</p> <p>User Interface: Change the options in the Software application.</p> <p>Internationalization: Select the local language and culture.</p>
Troubleshooting	<p>AWS: Allows for download of images.</p> <p>Computer: System Management and Network Information.</p> <p>Log: Change the event record options.</p> <p>Backups: Control the backups for the system.</p>

9.6 Archive Tool

The archive feature in the *Admin* screen lets you:

- Send local studies to an archive.
- Export studies to removable media.

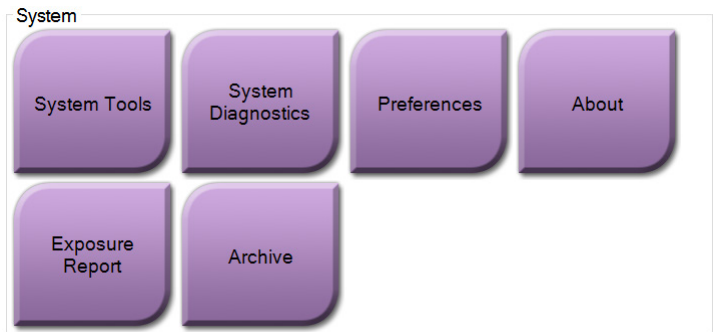

Figure 37: Archive Button

1. From the System Tools group in the *Admin* screen, select the **Archive** button. The *Multi Patient On Demand Archive* screen opens.
2. To search for a patient, enter at least two characters in the Search parameters area and select the magnifying glass.

A list of patients that match the search criteria is displayed.

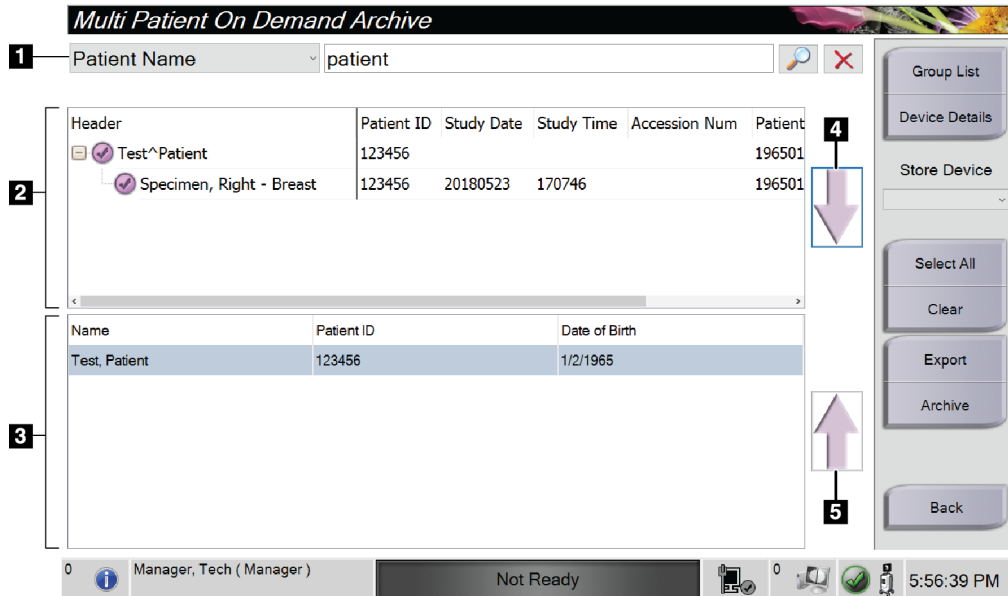

Figure Legend

1. Search parameters
2. Patient List area
3. Patients To Be Archived area
4. Add selection in the Patient List area to the Patients To Be Archived area
5. Remove the selection from the Patients To Be Archived area

Figure 38: Multi Patient On Demand Archive Screen

To Archive:

1. Select the patients and the procedures to archive.
 - Select patients from the patient list, or do a search with the search parameters (item 1) and select patients from the search results.
-



Note

The **Select All** button (in the right panel of the screen) selects all the patients in the Patient List area. The **Clear** button (in the right panel of the screen) clears selections.

- Select the procedures for each patient.
 - Select the **Down Arrow** (item 4) on the screen to move the selected patients to the Patients To Be Archived area (item 3).
 - Select the **Up Arrow** (item 5) on the screen to remove the selected patients from the Patients To Be Archived area (item 3).
2. Select a storage device.
 - Select an option from the Store Device drop-down list.
- OR-
- Select the **Group List** button, then select an option.
3. Select the **Archive** button. The list in the Patients To Be Archived area copies to the selected archive devices.
-



Note

Use the Manage Queue utility in the taskbar to review the archive status.

To Export:

1. Select the patients and the procedures to export.
 - Select patients from the patient list, or do a search with one of the search parameters (item 1) and select patients from the search results.



Note

The **Select All** button (in the right panel of the screen) selects all the patients in the Patient List area. The **Clear** button (in the right panel of the screen) clears selections.

- Select the procedures for each patient.
 - Select the **Down Arrow** (item 4) on the screen to move the selected patients to the Patients To Be Archived area (item 3).
 - Select the **Up Arrow** (item 5) on the screen to remove the selected patients from the Patients To Be Archived area (item 3).
2. Select the **Export** button.
 3. In the *Export* dialog box, select the Target from the drop-down list of media devices.

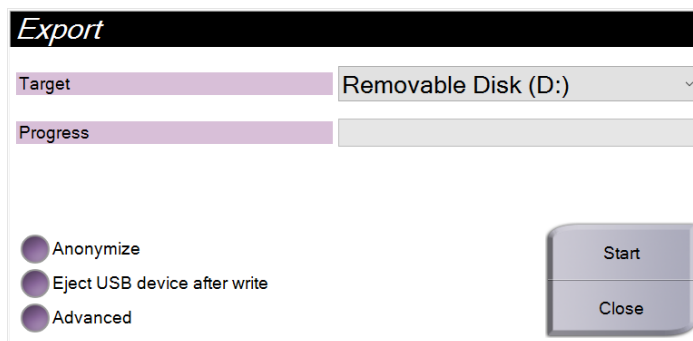

Figure 39: Export Screen

4. Select other options, if necessary:
 - **Anonymize**: to anonymize patient data.
 - **Eject USB device after write**: to eject the USB device after the patient data has exported.
 - **Advanced**: to select a folder on your local system to keep the selections, and also to select the Export types.
5. Select the **Start** button to copy the selected images to the selected device.

9.7 How to Change the Default Lock Out Time

After a set time of inactivity, the system will "lock out" the user. The user is then required to log in again before returning to their place in the procedure. The amount of time of inactivity is configurable. The default time is 60 minutes.

1. Select the Windows icon to open the Windows Start menu.
2. Find "Local Security Policy".
3. Navigate to **Security Settings > Local Policies > Security Options**.
4. Find "Interactive logon: Machine inactivity limit".
5. Adjust the time as desired.

Appendix A System Specifications

A.1 Product Measurements

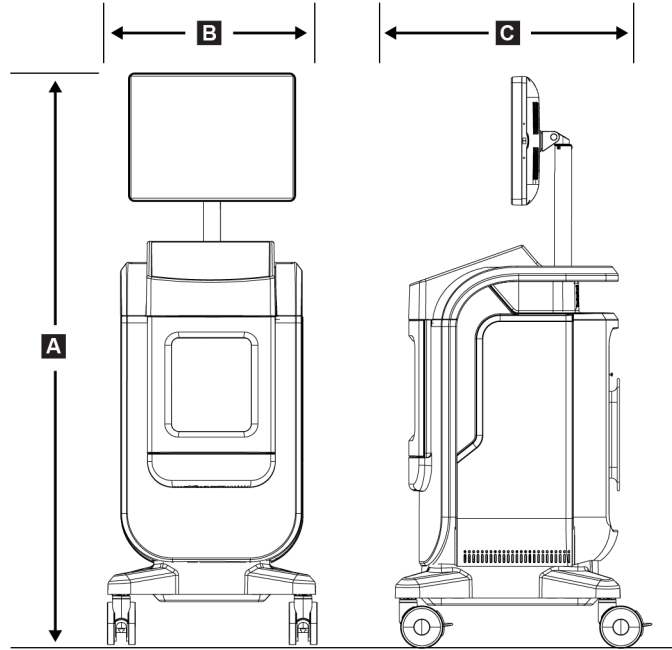

Figure 40: Console Measurements

A.	Height	169 cm (66.5 inches)
B.	Width	61 cm (24 inches)
C.	Depth	66.1 cm (26 inches)
	Weight	132.2 kg (291 pounds)

A.2 Operation and Storage Environment

A.2.1 General Conditions for Operation

This equipment is designed for safe and effective operation under the following conditions for Indoor Use:

Altitude	To 3,048 m (10,000 feet)
Degree of Pollution	Pollution Degree 2
Temperature Range	15 °C (59 °F) to 30 °C (86 °F)
Relative Humidity Range	20% to 80% without condensing moisture

A.2.2 General Conditions for Transport and Storage

Console

<i>Temperature Range</i>	<i>–10 °C (14 °F) to 40 °C (104 °F) after being stored for 48 hours</i> <i>10 °C (50 °F) to 35 °C (95 °F) for up to 12 hours</i>
<i>Maximum rate of temperature change</i>	<i>Less than 10 °C (50 °F) per hour</i>
<i>Relative Humidity Range</i>	<i>20% to 90% without condensing moisture</i>

X-ray Detector

<i>Temperature Range</i>	<i>10 °C (50 °F) to 30 °C (86°F) after being stored for 48 hours</i> <i>10 °C (50 °F) to 35°C (95 °F) for up to 12 hours</i>
<i>Maximum rate of temperature change</i>	<i>Less than 10 °C (50 °F) per hour</i>
<i>Relative Humidity Range</i>	<i>20% to 90% without condensing moisture</i>

(Put in a package for storage in a building.)

A.3 Console Technical Information

A.3.1 General Information

<i>Operating System</i>	<i>Windows 10</i>
<i>Solid State Drive Capacity</i>	<i>512 GB</i>
<i>Memory</i>	<i>8 GB RAM</i>
<i>Storage Media</i>	<i>USB 3.0</i>
<i>Image Display Monitor</i>	<i>no less than 1600 x 1200 pixel resolution</i>
<i>Control Display</i>	<i>touch screen</i>

A.3.2 Network Environment

<i>Network Interface</i>	<i>10/100/1000 BASE-T Ethernet</i>
<i>Wi-Fi</i>	<i>a/b/g/n/ac 2.4 and 5 GHz bands</i>

A.4 Electrical Input

<i>Line Voltage Range</i>	100/120/208/230/240 VAC
<i>Mains supply voltage fluctuations</i>	±10% of nominal voltage
<i>Transient overvoltages</i>	To the levels of Overvoltage Category II
<i>Operating Frequency</i>	50/60 Hz ±2%
<i>Peak Line Current</i>	<6 amps
<i>Power Consumption</i>	700 watts maximum
<i>Line Connection</i>	Standard line cord and plug - medical grade

A.5 X-ray Tube Technical Information

<i>Source-to-Image Distance (SID)</i>	43 cm ±0.5 cm (16.9 inches ±0.2 inches)
<i>Focal Spot</i>	no more than 55 microns
<i>Tube Voltage</i>	20 kV to 50 kV
<i>Duty Cycle</i>	16%; 20 second exposure every 125 seconds
<i>Anode Material</i>	Tungsten
<i>X-Ray Window</i>	Beryllium 200 µm

A.5.1 X-Ray Generator

<i>kV Range</i>	20 kV to 50 kV
<i>mA</i>	1 mA
<i>mAs</i>	20 mAs maximum

A.6 Imaging System Technical Information

A.6.1 Image Receptor

<i>Fluid Ingress</i>	The Image Receptor is protected from accidental spillage on the Cabinet floor.
<i>Active Imaging Area</i>	Full-field Detector: 16 cm x 18 cm nominal
<i>Dynamic Range and Linearity</i>	Detector Subsystem response is linear with linearity of 0.999 over a dynamic range of 400:1 in x-ray exposure.
<i>Uniformity</i>	Detector Subsystem can correct pixel-to-pixel gain variations.
<i>Image Pixel Size</i>	70 µm
<i>Digital Image Receptor MTF</i>	Modulation Transfer Function (MTF) not less than 40% at 7.1 lp/mm

Appendix B System Messages and Alerts

B.1 Error Recovery and Troubleshooting

Most faults and alert messages are cleared without result to your workflow. Follow the instructions on the screen or correct the condition, then clear the status from the Taskbar. Some conditions require a system restart or indicate that more action is necessary (for example to call Hologic Technical Support.) This chapter describes the message categories and your actions to return the system to normal operation. If errors repeat, contact Hologic Technical Support.

B.2 Types of Messages and Alert messages

B.2.1 Fault Levels

There are five fault levels: Warning, Minor, Major, Critical, and Alerts.

Warning Faults

The Warning faults are not displayed to the user. These faults are recorded in the log files.

Warning fault designs:

- Release through the software or communications commands.
- Do not cancel an exposure that is in progress.
- Do not prevent the start of a new exposure.

Minor Faults

Minor fault designs:

- Release through the software or communications commands.
- Do not cancel an exposure that is in progress.
- Requires a response before a new exposure can start.

Major Faults

Major fault designs:

- Release through the software or communications commands.
- Cancel an exposure that is in progress.
- Prevent the start of a new exposure.

Critical Faults

Critical fault designs:

- Not released through the software or communications commands.
- Cancel an exposure that is in progress.
- Prevent the start of a new exposure.

Alert Messages

The Alert Messages are routine messages that can prevent an exposure. An Alert message remains active until the required action is complete or the condition does not exist.

B.2.2 System Messages

Select the system status icon on the Taskbar to get information about the cause and correction of a system problem. When you correct the problem, the System Message area displays a Ready status.

B.3 Troubleshooting

- To restart the System after a critical fault, select the **Start** button that displays on the desktop.
- If you select the Exit button, a message advises you that this option shuts down the computer.

Glossary of Terms

AEC

Automatic Exposure Control

Annotations

Markings on an image to indicate an area of interest.

DICOM

Digital Imaging and Communications in Medicine

PACS

Picture Archiving and Communications System. A computer and network system that transmits and archives digital medical images.

ROI

Region of Interest

SID

Source to Image Distance

Index

A

- about screen • 69
- access
 - quality control • 2, 61
- acquire images • 45
- add
 - add patient • 28
 - add procedure • 37
- admin screen • 67
- advanced • 38
- alerts • 81, 82
- archive • 40, 73

C

- cabinet • 18
- calibration, gain • 62
- casters • 21
- cleaning solutions and methods • 63
- close patient procedure • 39
- complaints, product • 3
- compliance • 13
 - compliance requirements • 13
 - compliance statements • 14
- components • 17
 - cabinet • 18
 - specimen tray • 19
- connections
 - connections • 20
 - network connectivity • 25
 - USB connection • 17, 20
 - Wi-Fi connection • 20, 25
- controls and indicators • 17
- controls, system • 17
- cybersecurity statement • 3

D

- data loss • 8
- delete patient • 33
- display
 - window level • 48

E

- export, images • 40

F

- faults • 81, 82
- filters for patients • 33
 - columns tab • 35
 - filter tab • 34

G

- gain calibration • 62

I

- images • 43
 - output options • 51
 - print • 41
- indicators, system • 17
- intended use • 1
 - user profiles • 2
- interlocks • 13

L

- label locations • 15
- language • 70
- lock out time • 76
- locks, casters • 21
- log in • 21
- log out • 24

M

- maintenance
 - general • 63
- messages and alerts • 81, 82
- multi line procedure tab • 71
- my settings • 25, 70

N

- network connectivity • 25

O

- on-demand outputs • 40
- open patient procedure • 28
- output devices
 - icons • 25
 - output set • 51
- output groups, manage • 51
- output sets • 39

P

- patient
 - add patient • 28
 - delete patient • 33
 - edit patient • 29
 - filters for patients • 33
 - open patient procedure • 28
 - split patient records • 30
- permissions, by user group • 2
- power controls • 17
- print • 41
- procedure
 - add procedure • 37
 - close patient procedure • 39
 - procedure screen • 36
 - advanced • 38
 - simple • 38

Q

- quality control • 2, 61
- query the worklist • 35

R

- radiation safety • See warnings and precautions
- refresh the worklist • 35
- remove all power • 24
- requirements
 - compliance requirements • 13
 - quality control • 2, 61
- retrieve • 38

S

- safety
 - general information • 8
- screen
 - about screen • 69
 - add patient • 28
 - add procedure • 37
 - admin screen • 67
 - filters for patients • 33
 - print • 41
 - procedure screen • 36
 - query the worklist • 35
- select
 - output sets • 39
 - patient • 27
- send images to outputs • 51
- simple • 38
- specifications • 77
- specimen cabinet • 18
- specimen tray • 19
- split patient records • 30
- startup • 21
- statement
 - compliance statements • 14
 - cybersecurity statement • 3
 - warranty statement • 2
- symbols • 4
- system
 - administration • 67
 - capabilities • 1
 - components • 17
 - connections • 20
 - controls, system • 17
 - indicators, system • 17
 - log in • 21
 - log out • 24
 - messages • 82
 - overview • 7
 - power controls • 17
 - specifications • 77
 - startup • 21
 - tools, system • 71
 - turn off system • 24
 - turn on system • 21
 - Windows 10 • 23

T

- taskbar • 25
- technical support • 3
- tools, system • 71
- tray • 19
- turn off system • 24
- turn on system • 21

U

- USB connection • 17, 20
- user interface • 25

W

- warnings and precautions • 8
- warnings, cautions and notes, defined • 5
- warranty statement • 2
- Wi-Fi connection • 20, 25
- window level • 48
- Windows 10 • 23
- workflow • 53
- worklist • 35
 - query the worklist • 35
 - refresh the worklist • 35
- workstation
 - controls and indicators • 17

X

- x-ray
 - acquire images • 45
 - cleaning solutions and methods • 63
 - indicators • 18

HOLOGIC®



Hologic Inc.
36 Apple Ridge Road
Danbury, CT 06810 USA
1 800 447 1856

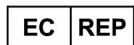

Hologic Ltd.
Heron House Oaks Business Park, Crewe Road
Wythenshawe, Manchester. M23 9HZ, UK
+44 (0)161 946 2206

Brazilian Contact: Imex Medical Group do Brasil
Rua das Embaúbas, 601- Fazenda Santo Antônio
São José /SC - Brasil - 88104-561
+55 48 3251-8800
www.imexmedicalgroup.com.br

