

242D

Resistance Measuring System

General Purpose Bridge Combines Speed, Accuracy for Calibration and Quality Control

- 10ppm Direct-reading accuracy
- 1ppm Comparison accuracy with 0.1ppm resolution
- Direct or percent deviation readout
- Matched generator-detector
- Complete guarding and shielding

The Model 242D Resistance Measuring System brings increased accuracy and reliability to resistance measurements from 10m Ω to 120M Ω , with operational speed ideally suited for production and quality control.

Direct reading accuracy of 10ppm is maintained over a wide range without the need for correction tables or computations of any kind. (An optional accuracy of 5ppm is available at additional cost. See below.)

The key to the 242D's performance is the systems design approach, with all factors affecting precise resistance measurement considered during the design process. Three compatible, precision instruments have been joined into



one complete measurement system. They are: a decade resistance standard, a Kelvin ratio bridge, and a DC generator-detector.

Complete guarding and shielding is used to reduce leakage and noise problems for both high and low resistance measurement. Yoke balance and lead compensation in the Kelvin bridge circuit permits accurate low-resistance measurements previously unobtainable in a system of this type because of lead and contact resistances. All bridge ratio resistors and each resistor in the first four decades are individually adjustable to 1ppm. Resistors used in the system have extremely low temperature coefficients to reduce the effects of temperature changes.

In addition to performance accuracy, operational features are designed so that minimum time is required for each measurement. Separate resistance and deviation dials simplify component checking and temperature coefficient measuring. Resistance transfers can be made in minutes, with assurance of reliability and repeatability.

Versatility of the 242D is enhanced by the ability to use the DC generator-detector as a separate instrument. The generator can be used wherever a variable, guarded and power-limited DC supply is required, or its detector can be used separately as a voltmeter, with ranges from $\pm 3\mu\text{V}$ to $\pm 1000\text{VDC}$.

The 242D System consists of Model 801B DC Generator Detector, Model 240C Kelvin Ratio Bridge and Model RS925D Decade Resistance Standard.

5ppm Version

For applications which require greater accuracy, the Model 242D/SP3632 is available with the following specifications:

Adjustment Accuracy

$\pm (5\text{ppm} + 1\text{ m}\Omega)$ on multiplier ranges 0.1, 1.0 and 10.0 covering measured resistance values from 100 Ω to 1M Ω . (Will remain within stated specifications for 30 days provided temperature is maintained within $\pm 1^\circ\text{C}$ and relative humidity within $\pm 10\%$ of initial calibration conditions.)

Specifications

242D Resistance Measuring System

The limiting factors of any measurement are the accuracy, resolution and sensitivity of the measurement system. Thus, the goal of good design is to provide (1) an accuracy limited only by the state of the art, (2) resolution capable of taking full advantage of the accuracy, and (3) sensitivity sufficient to permit full use of the resolution. The graphs illustrate the performance capability of the Model 242D Resistance Measuring System in terms of these essential design goals.

Standard Equipment

Model 242D comes with a 21806 Cabinet, 8306 Kelvin Klips® Cable Set, 19125 Interconnection Kit, and a 19625 Instruction Manual.

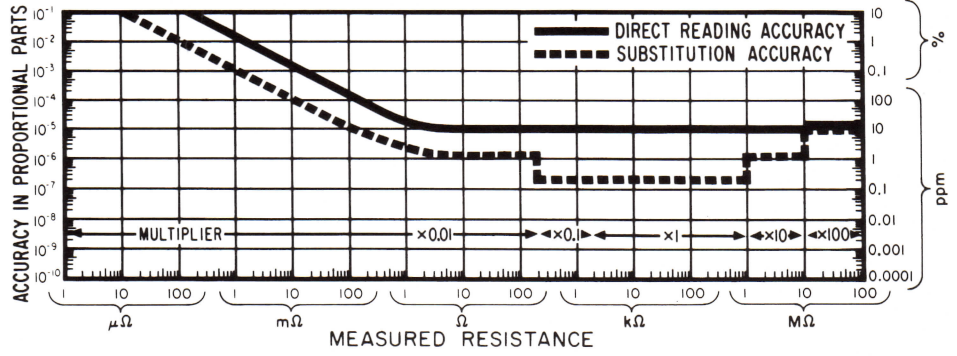

Bridge and Standard Accuracy

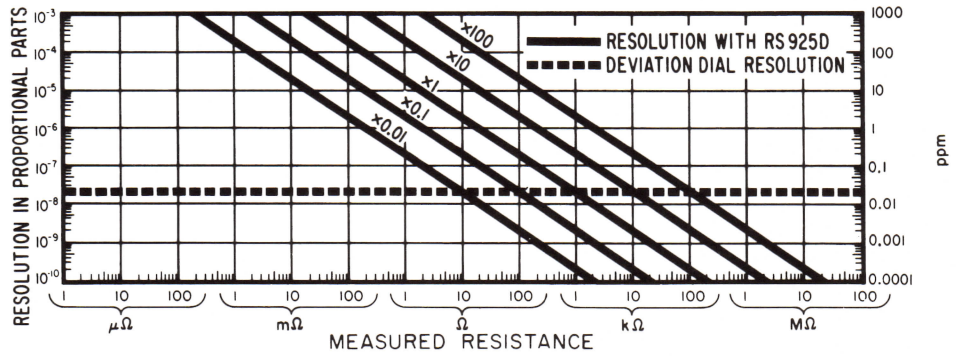

Bridge and Standard Resolution at Maximum Power

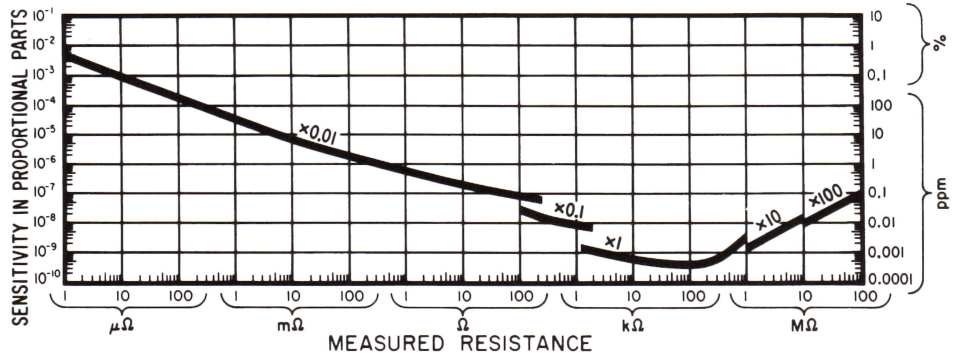

System Sensitivity

- Dimensions:**
 Width: 19.5 in. (49.5cm)
 Height: Panel: 17.5 in. (44.5cm)
 Overall: 20.4 in. (51.8cm)
 Depth: 14.0 in. (35.6cm)
Weight:
 70 lbs (32kg) net

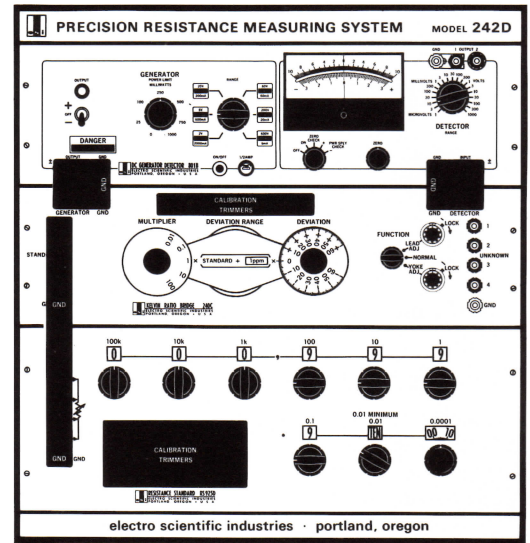

RS925D Decade Resistance Standard

Resistance measurements are simplified by this four-terminal, continuously variable 1.2-M Ω resistance standard. Decades range from 100k Ω per step to 10m Ω per step. A continuous rheostat with 100 microhms per division provides resolution to 20 microhms. The first four decades may be individually trimmed for increased accuracy.

Resistance Range

10m Ω to 1.2M Ω provided by eight resistance decades and rheostat with 20 $\mu\Omega$ resolution.

Initial Adjustment Accuracy

$\pm(20\text{ppm} + 1\text{m}\Omega)$ at any setting.

Accuracy after Adjustment

100k Ω	$\pm 1.5\text{ppm}$
10k Ω	$\pm 1.0\text{ppm}$
1k Ω	$\pm 1.5\text{ppm}$
100 Ω	$\pm 2.0\text{ppm}$

Stability after Adjustment

$\pm(20\text{ppm} + 0.5\text{m}\Omega)$ per year

Short-Term Resistance Repeatability

Mean value of variation of total switch contact resistance less than 100 $\mu\Omega$.

Calibration Conditions

23 $^{\circ}\text{C}$, four-terminal measurement. 30% to 70% relative humidity.

Temperature Coefficient

100 Ω steps and higher	$\pm 3\text{ppm}/^{\circ}\text{C}$
10 Ω steps	$\pm 15\text{ppm}/^{\circ}\text{C}$
1 Ω steps and lower	$\pm 20\text{ppm}/^{\circ}\text{C}$
Wiring and switches	$\pm 50\mu\Omega/^{\circ}\text{C}$

Power Coefficient for Typical Measurement Duty Cycle

100 Ω steps and higher	$\pm 0.1\text{ppm}/\text{mW}/\text{step}$
10 Ω steps	$\pm 0.3\text{ppm}/\text{mW}/\text{step}$
1 Ω steps	$\pm 0.4\text{ppm}/\text{mW}/\text{step}$
0.1 Ω and 0.01 Ω steps	$\pm 1.0\text{ppm}/\text{mW}/\text{step}$
Wiring and switches	$\pm 50\mu\Omega/\text{W}$ total

Power Rating

1.0W/step or 5.0W total, or 2.0A maximum current.

Breakdown Voltage

1500V peak to case

Dimensions

Width: 19 in. (48.25cm)

Height: 7 in. (17.8cm)

Depth: 8 in. (20.3cm)

Weight:

14 lbs (6.4kg) net

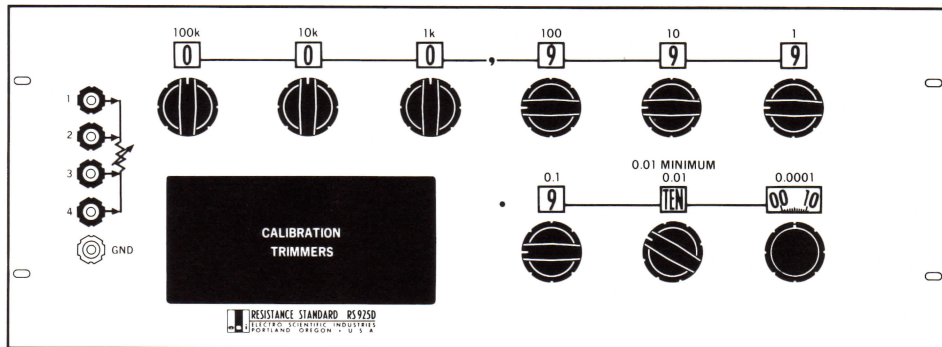

240C Kelvin Ratio Bridge

The Model 240C Kelvin Ratio Bridge used in the Model 242D system allows comparison of resistors to 0.5ppm either by interchanging the units or reading their values directly. Direct readout is possible to an accuracy of 0.001% using the Model RS 925D Resistance Standard. This bridge can also be used to determine deviation of an unknown resistor from a standard.

Multipliers

Multiplier Ratios	Accuracy after Trimming (ppm)	Temperature Coefficient (ppm/ $^{\circ}\text{C}$)
$\times 0.01$	2.0	3.0
$\times 0.1$	1.0	2.5
$\times 1.0$	0.5	2.0
$\times 10.0$	1.0	3.0
$\times 100.0$	2.0	3.0

Power Coefficient

0.1ppm/mW

Deviation Dial Ranges

0.1ppm/dial division	$\pm 6\text{ppm}$
1.0ppm/dial division	$\pm 60\text{ppm}$
0.001%/dial division	$\pm 0.06\%$
0.01%/dial division	$\pm 0.6\%$

Resolution

$\frac{1}{4}$ dial division

Linearity

± 1 dial division

Lead Adjustment

Panel control compensates for unknown lead resistance up to 0.1 Ω .

Yoke Adjustment

100ppm and 0.1 Ω

Yoke Resistance

Approximately 25m Ω internal to bridge

Breakdown Voltage

1500V peak to case

Dimensions

Width: 19 in. (48.25cm)

Height: 5.25 in. (13.3cm)

Depth: 7 in. (17.8cm)

Weight:

11 lbs (5kg) net

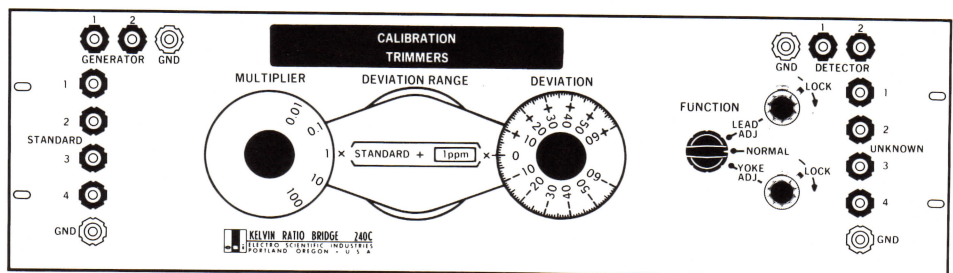
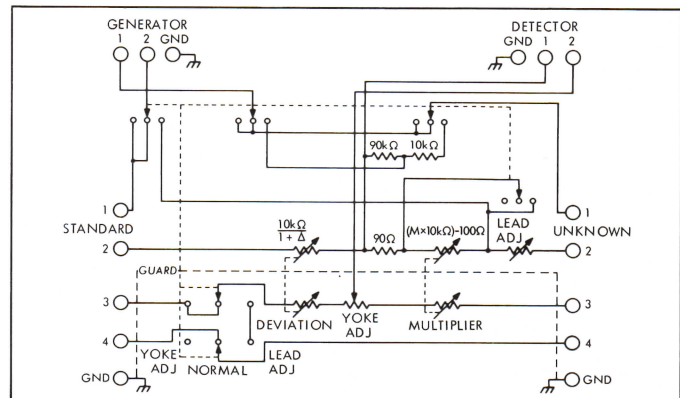

Model 801B

The Model 801B is an integral part of the Model 242D Precision Resistance Measuring System.

DC Generator

Ranges

Six, continuously variable 0 to 600V.
Power-limited to 1W.

Regulation

Active circuit line regulator reduces effect of line transients by factor of more than 10.

Resistance to Chassis

Terminal 1 greater than $10^{14}\Omega$; terminal 2 greater than $10^{11}\Omega$.

DC Detector

Ranges

Calibrated $\pm 3\mu\text{V}$ to $\pm 1000\text{VDC}$ end scale in 8 zero-centered ranges.

Sensitivity

$3\mu\text{V}$ end scale (calibrated); $0.75\mu\text{V}$ end scale (uncalibrated).

Accuracy

$\pm 5\%$ of end scale, $\pm 0.1\mu\text{V}$

Limits of Zero Control

$\pm 15\mu\text{V}$

Input Resistance

3 μV to 3mV	100k Ω
10mV to 30mV	1M Ω
100mV to 300mV	10M Ω
1V to 1000V	100M Ω

Response Time

95% of final reading within 4 seconds on 3 μV range, within 1.5 seconds on 10 μV to 100V ranges

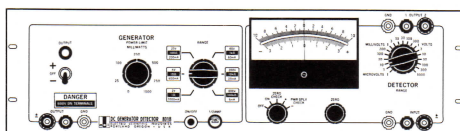

Superimposed AC Rejection

With frequencies of 60Hz or higher (except modulator frequency 160 to 170Hz) AC voltages 80dB greater than end scale will affect reading less than 2%. (Voltage must be limited to 300VAC rms.)

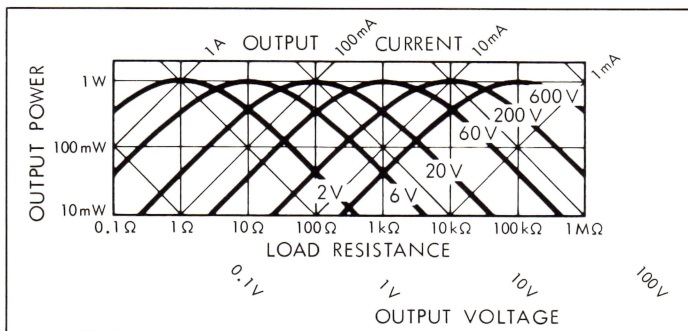
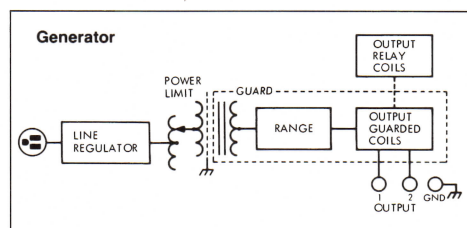

Detector

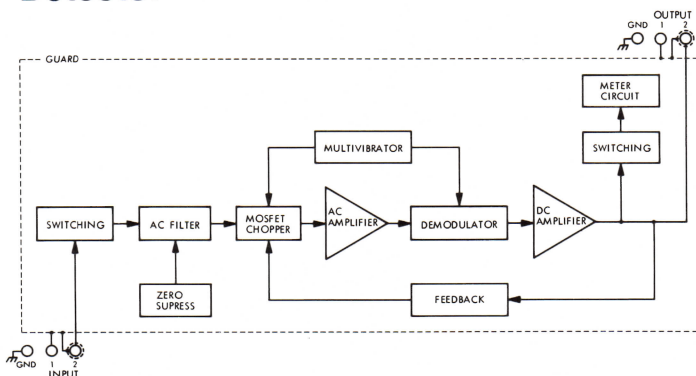

Warranty

WARRANTY OF QUALITY

Electro Scientific Industries, Inc., warrants its products to be free from defects in material and workmanship. Rigorous quality control permits the following standard new equipment warranties:

1. One year on components and instruments utilizing active circuitry.
2. Two years on components and instruments exclusively utilizing passive circuitry.

During the warranty period, we will service or, at our option, replace at the factory any device that fails in normal use to meet its published specifications. Batteries, tubes and relays that have given normal service are excepted. Special systems will have warranty periods as listed in their quotation.

DISCLAIMER OF IMPLIED WARRANTIES

THE FOREGOING WARRANTIES OF ESI ARE IN LIEU OF ALL OTHER WARRANTIES, EXPRESS OR IMPLIED. ESI SPECIFICALLY DISCLAIMS ANY IMPLIED WARRANTIES OR MERCHANTABILITY OR FITNESS FOR A PARTICULAR PURPOSE.

In no event will ESI be liable for special or consequential damages. Purchaser's sole and exclusive remedy in the event any item fails to comply with the foregoing express warranties of ESI shall be to return the item to ESI, shipping charges prepaid, and at the option of ESI obtain a replacement item or a refund of the purchase price.

Where an ESI product will interconnect with components not supplied by ESI, ESI does not warrant the ESI product against failures caused by mismatch of the non-ESI product, nor will ESI be liable for damages to the non-ESI component resulting from the mismatch.

Unless specifically requested by the customer, ESI does not inspect or test an instrument for compliance with applicable safety, governmental or industry standards. Customers who desire an inspection or test for conformity to a standard should specify the standard with particularity. Not all instruments can be modified to conform with standards adopted after the instrument was manufactured, and such modifications are not repairs, nor is failure to comply with a standard adopted after the date of manufacture a defect.

For complete information regarding warranties, terms and conditions, refer to page 14 of ESI's "Impedance Instruments Catalog," number I510-381-30KDD, or contact ESI.