

XR100 FastSDD User Manual

X-Ray Detector & Preamplifier



1.1.1 Amptek, Inc

14 DeAngelo Dr, Bedford MA 01730 USA

Phone: +1 781 275 2242 Fax: +1 781 275 3470

Email: Amptek.Sales@ametek.com

Web: <http://www.amptek.com>



TUV Rheinland Certification Available on Request

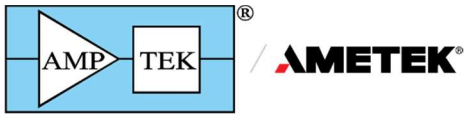

1.2 Table of Contents

1	Warnings and Precautions	3
2	Description	5
2.1	Core detector technology	5
2.2	Preamplifiers and signal processors.....	5
3	25 mm ² FAST SDD® Specifications	6
3.1	Specification Table	6
3.2	Efficiency.....	7
3.3	Energy resolution and electronic noise.....	7
3.4	Spectra	9
4	XR100 Preamplifier Specifications	10
4.1	XR100 Mechanicals	10
5	Detector Mechanical Specifications.....	11
5.1	Dimensions.....	11
5.2	Construction.....	12
6	Electrical Interface	14
6.1	Detector Output Connection Diagram.....	14
6.2	XR100 Preamplifier Output Connection Diagram	14
6.3	Preamplifier Output Signal.....	15
6.4	Preamplifier Reset Signal	15
6.5	Shaped peak and input to the ADC Signals.....	16
6.6	Cooling	16
6.7	Supply Voltages.....	18
7	Operating Notes with Amptek power supply	19
8	Operating Notes without Amptek power supply.....	19
8.1	Equipment Required	19
8.2	Absolute Maximum Ratings.....	19
8.3	Connections and Turn-On Procedure (without PX5 or other Amptek DPP/supply)	19
9	Troubleshooting.....	20
10	Warranty and Technical Questions.....	21
10.1	Warranty	21
10.2	Technical Questions	21
11	X-Ray Fluorescence Process Example: Titanium Atom (Ti = 22)	22
12	Amptek K and L Emission Line Lookup Chart.....	23

1 Warnings and Precautions



CAUTION: READ MANUAL BEFORE USING THE XR-100-FastSDD[®]



DOUBLE INSULATED. FOR INDOOR USE ONLY.

DO NOT DROP THE DETECTOR, CAUSE MECHANICAL SHOCK TO THE DETECTOR, OR CAUSE DAMAGE TO THE DETECTOR

- 1.1 Mechanical shock can damage components inside the TO-8 package.
- 2.1 There is vacuum inside the TO-8 for cooling. Damage to the package can cause a vacuum leak, preventing good cooling. **DAMAGE TO THE PACKAGE IS NOT COVERED UNDER WARRANTY.**

DO NOT TOUCH THE THIN WINDOW ON THE END OF THE DETECTOR

3.1 BROKEN WINDOWS DAMAGED BY IMPROPER HANDLING WILL NOT BE COVERED BY WARRANTY.

- 4.1 The detector window is made from either thin beryllium (13 μm or less) or from thin Si_3N_4 (as thin as 40 nm). The windows are extremely brittle and shatter easily.
- 5.1 Do not permit any object to come into contact with the window.
- 6.1 The window cannot be repaired or replaced. If the window breaks, the detector must be replaced.
- 7.1 Keep the red protective cover installed when not in use.

AVOID RADIATION DAMAGE TO THE DETECTOR

8.1 A RADIATION DAMAGED DETECTOR WILL NOT BE COVERED UNDER WARRANTY.

- 9.1 The detector will experience radiation damage if it is exposed to a high flux environment, e.g. directly from a synchrotron.
- 10.1 If the flux is low enough for spectroscopic operation, e.g. a count rate of a few hundred kcps, there will be no radiation damage in many years of continuous operation. But there are beams that produce a flux many orders of magnitude higher than this, and these will cause damage.
- 11.1 Also, avoid radiation exposure to the electronics, the preamplifier and signal processor.

High voltage is present inside the preamplifier. This is typically -130 V. The current is limited to $<100 \mu\text{A}$ so is not a personal hazard.

For best performance the detector and preamplifier should be mounted to a heat sink. They should be kept away from incandescent lamps and not held in the hand. The thermoelectric cooler dissipates up to 2 W. A low thermal resistance path to a heat sink is needed to keep the detector cool, which is needed for the lowest electronic noise and for spectrum stability.

For best performance pay attention to possible sources of electromagnetic interference. Use a single point electrical ground, use the shortest length cables possible, and keep the system far from sources of electromagnetic interference, such as computer monitors, high power high voltage power supplies, etc. The signals from the detector are very small so performance can be degraded by EMI.

 **WARNING**

This product contains the following chemicals, which are known to the State of California to cause cancer, birth defects or other reproductive harm if exposed to them through improper use, storage, or disposal of the product:

Prop 65 Chemical	Type of Toxicity	CAS No.	Product part containing the chemical
Beryllium	Cancer	--	Detector window

Please consult this owner's manual for proper use, storage, care and disposal of the product. For more information, go to: www.p65warnings.ca.gov

2 Description

2.1 Core detector technology

Amptek provides a family of high performance, compact X-ray detectors and associated signal processing electronics. The radiation detectors are custom photodiodes, including the traditional Si-PIN diodes, **S**ilicon **D**rift **D**etectors (SDDs), and CdTe Schottky diodes. The detector is mounted on a two-stage thermoelectric cooler along with the key preamplifier components. The cooler keeps the detector and key components at -25°C or below, reducing electronic noise without cryogenic liquid nitrogen and drawing $<1\text{W}$. This cooling permits high performance in a compact, convenient package, and has been critical to the development of portable XRF analyzers and of high performance, benchtop XRF and EDS systems.

Amptek's detectors represent the state-of-the-art in X-ray spectroscopy, delivering the best energy resolution, best efficiency at low energies, highest count rates, highest peak to background ratios, all at low cost and suitable for portable systems, vacuum systems, etc. They are used by OEMs and by laboratory researchers. The core enabling technologies include the detectors themselves (which are designed and manufactured by Amptek), the low noise JFET and CMOS technology, and the packaging which enables good cooling in a robust system.

The sketch above illustrates a detector mounted on a thermoelectric cooler, on a TO-8 header. The input FET and other components are also mounted on the cooler. A nickel cover (also shown) is welded to the TO-8 header with vacuum inside the enclosure for optimum cooling. In the cover is a window (shown green above) to enable soft X-ray detection. This is typically beryllium for energies $> 2\text{ keV}$, with Si_3N_4 available for lower energies. The entire assembly shown above is sometimes called the "detector", though strictly speaking it is the photodiode which detects the X-rays.

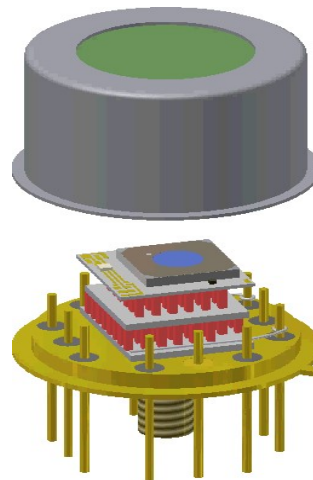

2.2 Preamplifiers and signal processors

The detector assembly shown above must be connected to a preamplifier (a circuit board containing those portions of the preamp not in the TO-8). Amptek uses reset-style charge sensitive preamplifiers for the lowest noise and highest count rates. Each type of Amptek detector (FAST SDD[®], SDD, Si-PIN, and CdTe) requires its own preamp circuit. These are available in several different standard package options: as an XR100 box, as a standard OEM preamp (PA210 or PA230) or in a custom board.

The output of the preamplifier must be connected to signal processing electronics (which includes pulse shaping and a multichannel analyzer) and power supplies. Amptek has several different options for these, including the X123 (where all are integrated in a single, small box), the DP5/PC5 board stack (bare boards, for integrating into customer systems), and the PC5 module (usually used in the laboratory). Please refer to Amptek's website for more information.

3 Detector Specifications

3.1 25mm² FAST SDD[®] Specification Table

General		
Detector Type	Silicon Drift Detector (SDD)	
Detector Size	25 mm ²	
Collimated Area	17 mm ²	
Thickness	500 μm	
Collimator Type	Internal Multilayer	
Preamplifier Type	CMOS reset type	
Energy resolution @ 5.9 keV (⁵⁵ Fe)		
122 to 129 eV FWHM (guaranteed) at T _{pk} =4.0 μs		
126 eV (typical) at 1.0 μs		
134 eV (typical) at 0.2 μs		
Energy resolution @ C K _α : 45 eV (typical)		
Other Performance		
Peak to background	≥ 20,000:1 (typical)	
Signal risetime	< 35 ns	
Maximum input count rate	> 1 Mcps	
Throughput count rate stability	Determined by signal processor & its settings	
Window Options		
Be	1/3 mil (8 μm) 1/2 mil (12.5 μm) 1 μm Parylene on each	
C series (low energy)	C1	C2
	90 nm Si ₃ N ₄	40 nm Si ₃ N ₄
	250 nm Al	30 nm Al
	30 mm ²	30 mm ²
Grid: Hexagonal, 15 μm thick Si, 78% open area C2 is NOT LIGHT TIGHT		
Signal Output		
Sensitivity	3.6 mV/keV	
Gain stability	<20 ppm/°C	
Polarity	Positive signal	
Reset range	-0.05 to 2 V (typical)	
Cooling		
Cooling performance	ΔT > 85°C	

Cooler type	Two stage thermoelectric
Temp monitor	Diode
Power	
HV Bias	-100 V to - 180V @ 25 μA
Max cooling power	3.5 V / 0.45A
Total power	< 2 W (full cooling)
Other	
Operating range	-35 °C to +80 °C Performance degrades at elevated detector temperatures.
Storage & shipping	-40 °C to +85 °C, 10% to 90% RH noncondensing
RoHS	Compliant
Lifetime	Typical 5 to 10 years, depending on use
Warranty Period	1 year

1.2.1.1 Preamplifier Options

Amptek's FAST SDD[®] is available with the XR-100 preamplifier, with the PA210 or PA230 OEM preamplifiers, or as part of the X-123 and X-55.

1.2.1.2 Signal Processing Options

Amptek's FAST SDD[®] may be used with Amptek's DP5 or DP5-X, or the PX5, or as part of the X-123 or X-55.

1.2.1.3 Specification Notes

- Performance listed here is measured at full cooling (<220K).
- The "peak to background ratio" is the ratio of counts in the Mn K_α peak channel to the counts at 1 keV.
- "Gain stability" refers to the change in sensitivity when the preamp temperature changes but the detector temperature is stable.

1.2.1.4 Operating Notes

- Detector must be operated with an appropriate heat sink.
- The FAST SDD[®] is suitable for vacuum applications. Amptek provides several system configurations.

3.2 70 mm² FAST SDD® Specification Table

General	
Detector Type	Silicon Drift Detector (SDD)
Detector Size	70 mm ²
Collimated Area	50 mm ²
Thickness	500 μm
Collimator Type	Internal Multilayer
Preamplifier Type	CMOS reset type
Energy resolution @ 5.9 keV (⁵⁵ Fe)	
123 to 135 eV FWHM (guaranteed) at T _{pk} =4.0 μs	
127 eV (typical) at 1.0 μs	
139 eV (typical) at 0.2 μs	
Energy resolution @ C K _α : 45 eV (typical)	
Other Performance	
Peak to background	≥ 20,000:1 (typical)
Signal risetime	< 60 ns
Maximum input count rate	> 1 Mcps
Throughput & count rate stability	Determined by signal processor & its settings
Window Options	
Be	1/2 mil (12.5 μm) 1 μm Parylene on each
C series (low energy)	C2
	40 nm Si ₃ N ₄
	30 nm Al
	30 mm ²
Grid: Hexagonal, 15 μm thick Si, 78% open area C2 is NOT LIGHT TIGHT	
Signal Output	
Sensitivity	3.6 mV/keV
Gain stability	<20 ppm/°C
Polarity	Positive signal
Reset range	-0.05 to 2 V (typical)
Cooling	
Cooling performance	ΔT > 85°C

Cooler type	Two-stage thermoelectric
Temp monitor	Diode
Power	
HV Bias	-100 V to -180V @ 25 μA
Max cooling power	3.5 V / 0.45A
Total power	< 2 W (full cooling)
Other	
Operating range	-35 °C to +80 °C Performance degrades at elevated detector temperatures.
Storage & shipping	-40 °C to +85 °C, 10% to 90% RH noncondensing
RoHS	Compliant
Lifetime	Typical 5 to 10 years, depending on use
Warranty Period	1 year

1.2.1.5 Preamplifier Options

Amptek's FAST SDD® is available with the XR-100 preamplifier, with the PA210 or PA230 OEM preamplifiers, or as part of the X-123 and X-55.

1.2.1.6 Signal Processing Options

Amptek's FAST SDD® may be used with Amptek's DP5 or DP5-X, or the PX5, or as part of the X-123 or X-55.

1.2.1.7 Specification Notes

- Performance listed here is measured at full cooling (<220K).
- The "peak to background ratio" is the ratio of counts in the Mn K_α peak channel to the counts at 1 keV.
- "Gain stability" refers to the change in sensitivity when the preamp temperature changes but the detector temperature is stable.

1.2.1.8 Operating Notes

- Detector must be operated with an appropriate heat sink.
- The FAST SDD® is suitable for vacuum applications. Amptek provides several system configurations.

3.3 25 mm² x 1mm FAST SDD® Specification Table

General	
Detector Type	Silicon Drift Detector (SDD)
Detector Size	25 mm ²
Collimated Area	17 mm ²
Thickness	1000 μm
Collimator Type	Internal Multilayer
Preamplifier Type	CMOS reset type
Energy resolution @ 5.9 keV (⁵⁵ Fe)	
122 to 131 eV FWHM (guaranteed) at T _{pk} =4.0 μs	
126 eV (typical) at 1.0 μs	
134 eV (typical) at 0.2 μs	
Other Performance	
Peak to background	≥ 20,000:1 (typical)
Signal risetime	< 35 ns
Maximum input count rate	> 1 Mcps
Throughput & count rate stability	Determined by signal processor & its settings
Window Options	
Be	1/2 mil (12.5 μm) 1 μm Parylene on each
Signal Output	
Sensitivity	3.6 mV/keV
Gain stability	<20 ppm/°C
Polarity	Positive signal
Reset range	-0.05 to 2 V (typical)
Cooling	
Cooling performance	ΔT > 85°C
Cooler type	Two-stage thermoelectric
Temp monitor	Diode
Power	
HV Bias	-100 V to -180V @ 25 μA
Max cooling power	3.5 V / 0.45A
Total power	< 2 W (full cooling)

Other	
Operating range	-35 °C to +80 °C Performance degrades at elevated detector temperatures.
Storage & shipping	-40 °C to +85 °C, 10% to 90% RH noncondensing
RoHS	Compliant
Lifetime	Typical 5 to 10 years, depending on use
Warranty Period	1 year

Preamplifier Options

Amptek's FAST SDD® is available with the XR-100 preamplifier, with the PA210 or PA230 OEM preamplifiers, or as part of the X-123 and X-55.

1.2.1.9 Signal Processing Options

Amptek's FAST SDD® may be used with Amptek's DP5 or DP5-X, or the PX5, or as part of the X-123 or X-55.

1.2.1.10 Specification Notes

- Performance listed here is measured at full cooling (<220K).
- The "peak to background ratio" is the ratio of counts in the Mn K_α peak channel to the counts at 1 keV.
- "Gain stability" refers to the change in sensitivity when the preamp temperature changes but the detector temperature is stable.

1.2.1.11 Operating Notes

- Detector must be operated with an appropriate heat sink.

The FAST SDD® is suitable for vacuum applications. Amptek provides several system configurations

3.1 Efficiency

The intrinsic efficiency is the probability that an X-ray incident on the detector window (in the active region) will interact in the detector and thus deposit its energy, creating a signal pulse. It is the product of (a) the probability of transmission through the window and (b) the probability of interacting in the 500 μm silicon depth (the detector is fully depleted). The low energy portion of the curves is dominated by the stopping in the window, while the high energy portion is dominated by transmission through the active depth of the SDD. The plot below shows the computed intrinsic efficiency for a 500 μm thick silicon detector with Amptek’s standard window options. See the Amptek website for more information.

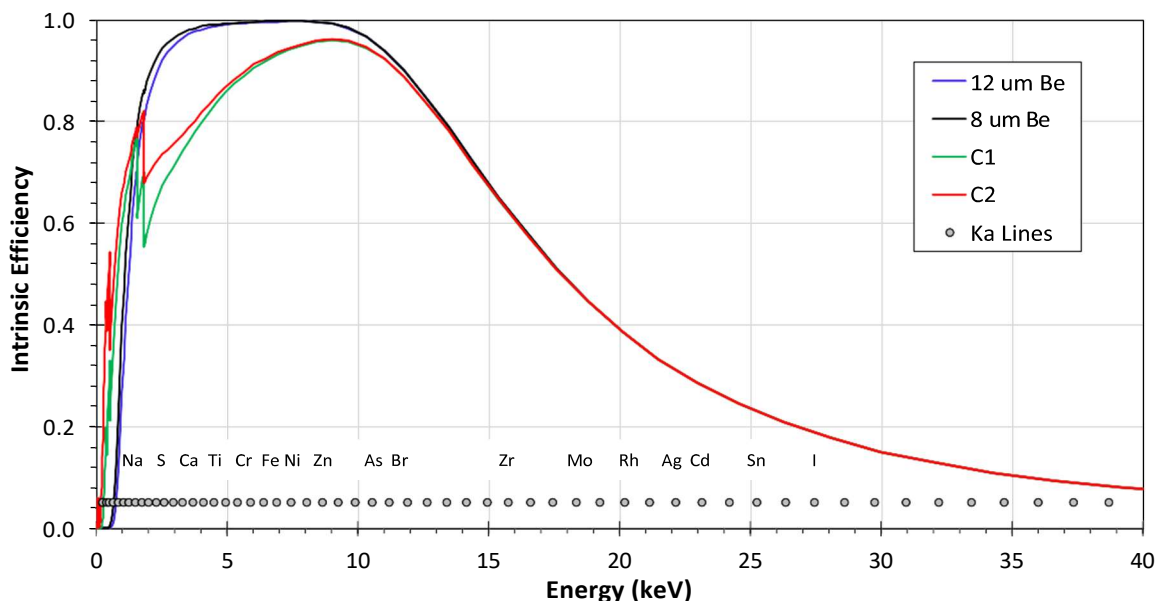

Figure 1. Plot showing efficiency versus energy for the windows available for the 25 mm² FAST SDD®.

3.2 Energy resolution and electronic noise

The energy resolution, δE , is a function of the energy E of the X-ray and of the intrinsic electronic noise, ENC , which for a given detector depends on the peaking time (T_{peak}) and the detector temperature:

$$(\delta E)^2 = K_F E + ENC(T_{peak}, T_{DET})^2$$

where $K_F E$ is due to “Fano broadening” and equals 119 eV at the 5.895 keV K_α line of Mn. Fano broadening is the theoretical limit for a noiseless detector. The plots below illustrate the resolution for a typical 25 mm² FAST SDD®. The first plot shows the resolution at the 5.895 keV K_α line of Mn, measured with ⁵⁵Fe. The second plot shows the electronic noise and the third plot shows how the resolution depends on X-ray energy, for various values of the noise.

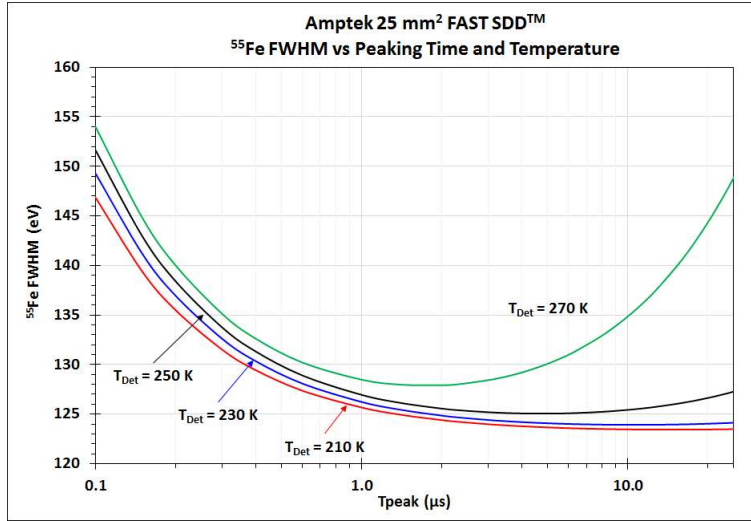
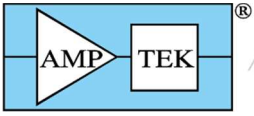

Figure 2. Plot showing typical ⁵⁵Fe resolution vs T_{peak} and temperature for the 25 mm² FAST SDD®.

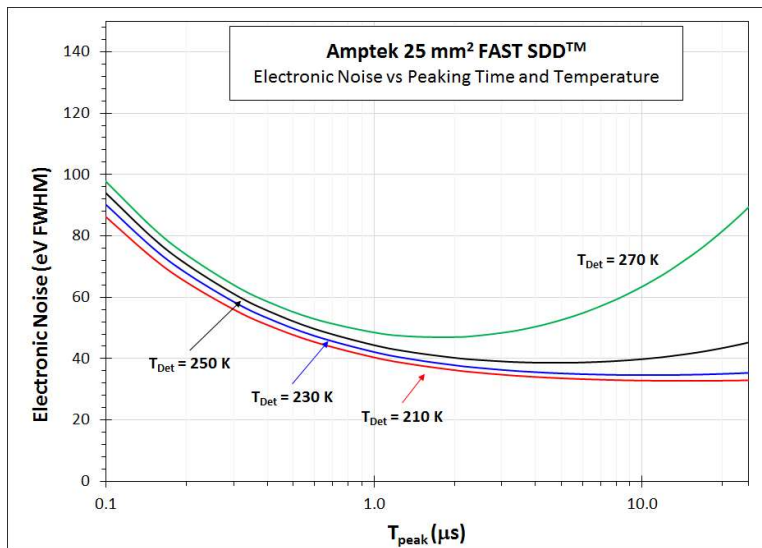

Figure 3. Plot showing typical electronic noise vs T_{peak} and temperature for the 25 mm² FAST SDD®.

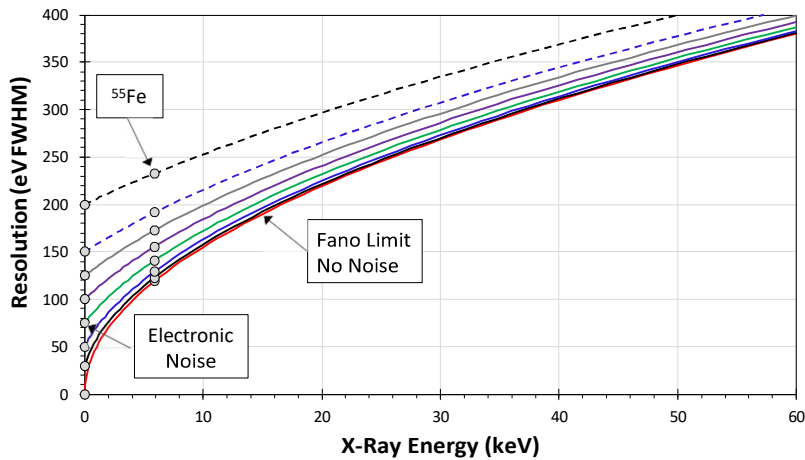
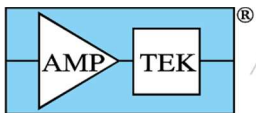

Figure 4. Plot showing resolution vs energy, as a function of electronic noise, for all detectors.



3.3 Spectra

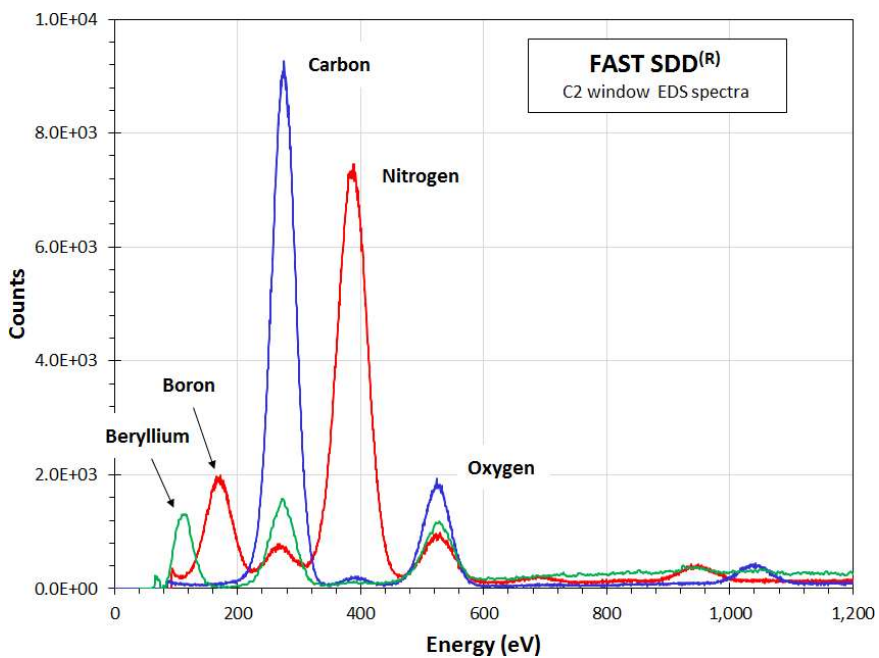
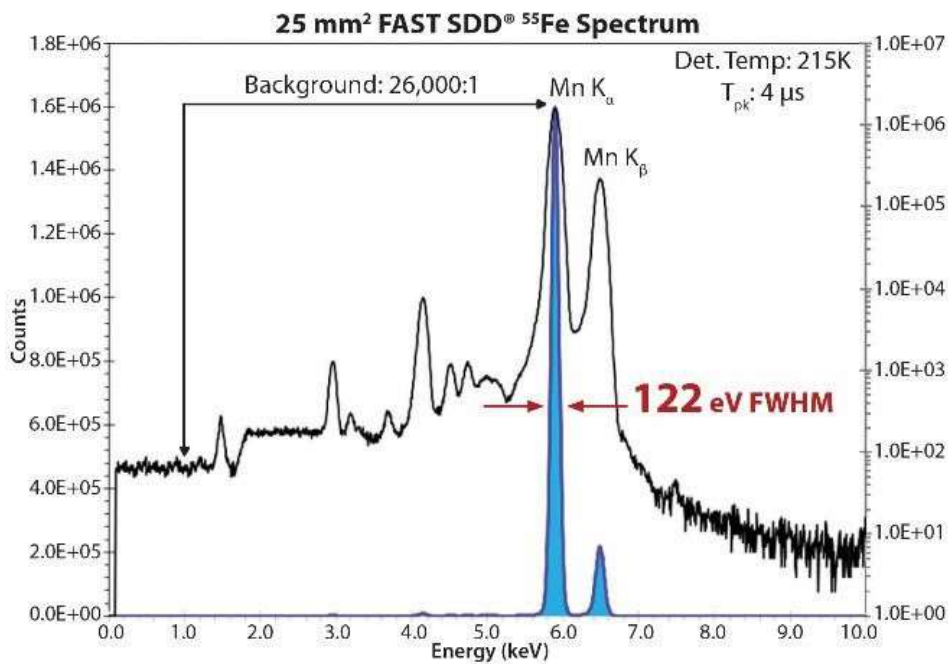

Figure 5. Typical spectra measured with the 25 mm² FAST SDD[®].

4 XR100 Preamp Specifications

General	
Preamp Type:	Reset style charge sensitive preamplifier.
Power	
HV Bias	-100 V to -180V @ 25 μ A
Max cooling power	3.5 V / 0.45 A
Low voltages	+/- 8 to 9 V @15 mA. No more than 50 mV p-p
Mechanical	
Case size (without extender)	3.00" x 1.75" x 1.13" 7.6 cm x 4.4 cm x 2.9 cm
Weight	4.4 oz (125 g)
XR100 Power Connector	
Type	6 pin LEMO
Pin 1	Temperature monitor diode
Pin 2	Detector Bias.
Pin 3	-9 V power
Pin 4	+9 V power
Pin 5	Cooler power return
Pin 6	Cooler power
Case	Ground and shield

XR100 Signal Connector	
Type	BNC Coax
Other	
Operating range	-35 °C to +80 °C @components
Storage & shipping	-40 °C to +85 °C, 10% to 90% RH noncondensing
TUV Certification	Certificate #: CU 72072412 02 Tested to: UL 61010-1: 2004 R7 .05 CAN/CSA-C22.2 61010-1: 2004
RoHS	Compliant
Warranty Period	1 year

1.2.1.12 XR100 Options

- The XR-100 preamplifiers are available with extender lengths of none, 1.5", 5", and 9".
- The XR-100 is available with a circuit to regulate the detector temperature when not used with Amptek power supplies.
- The XR-100 may be used inside a vacuum chamber or with a vacuum feedthrough. Contact Amptek for more information.

4.1 XR100 Mechanicals

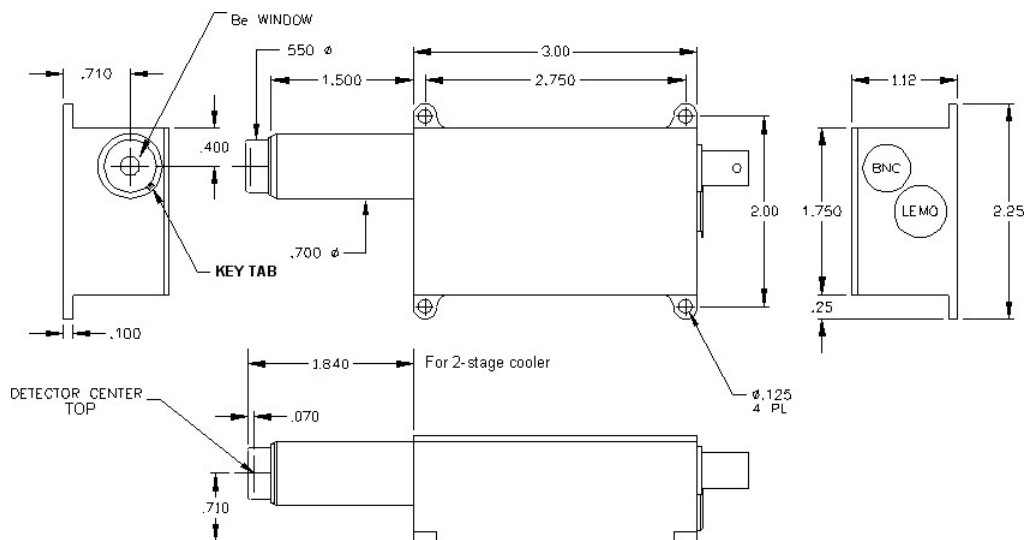

Figure 6. Mechanical design of standard XR-100 (1.5" extender). Visit amptek.com or contact Amptek for dimensions of the other configurations (5" extender, 9" extender, etc.).

5 Detector Mechanical Specifications

1.1 All dimensions shown are in inches unless otherwise specified.

2.1 All dimensions are “typical” unless a tolerance is listed.

5.1 Dimensions

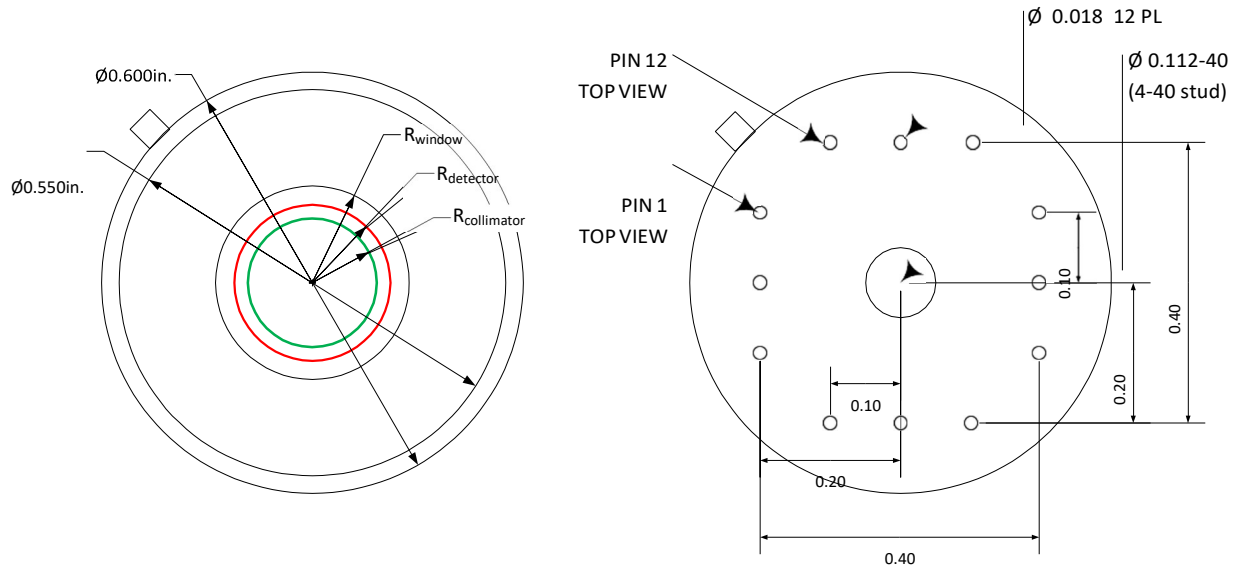
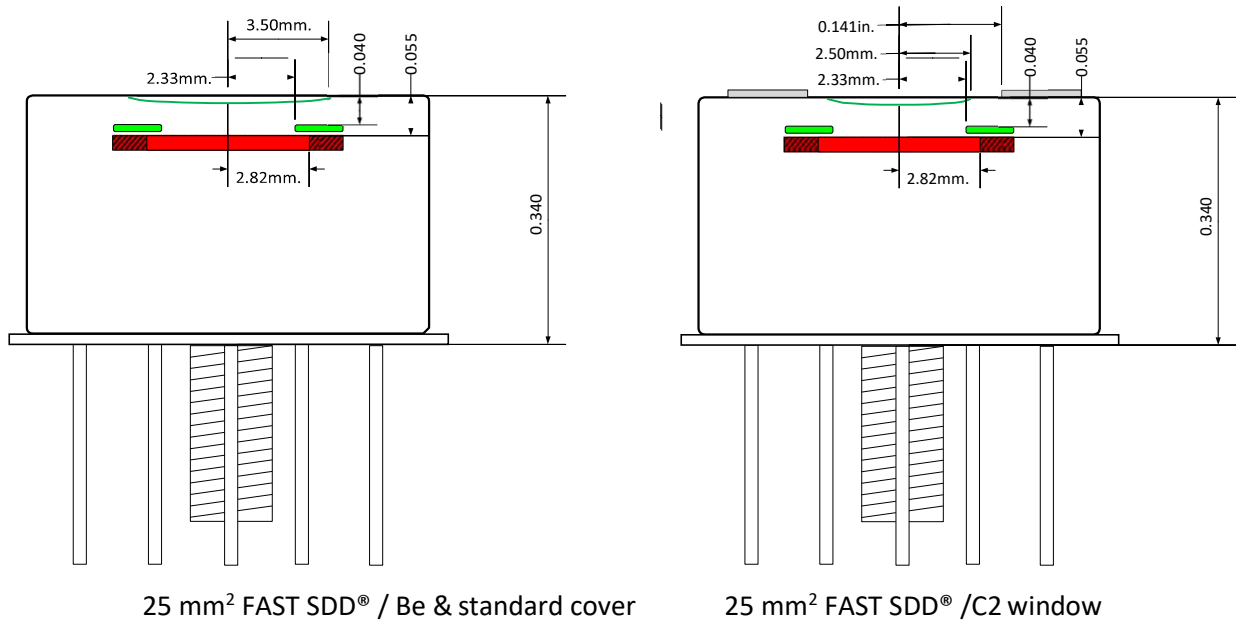

Figure 7. Top and bottom views of the detector package.



25 mm² FAST SDD® / Be & standard cover

25 mm² FAST SDD® /C2 window

Figure 8. Cross-sections of the two package options for the 25 mm² FASTSDD®.

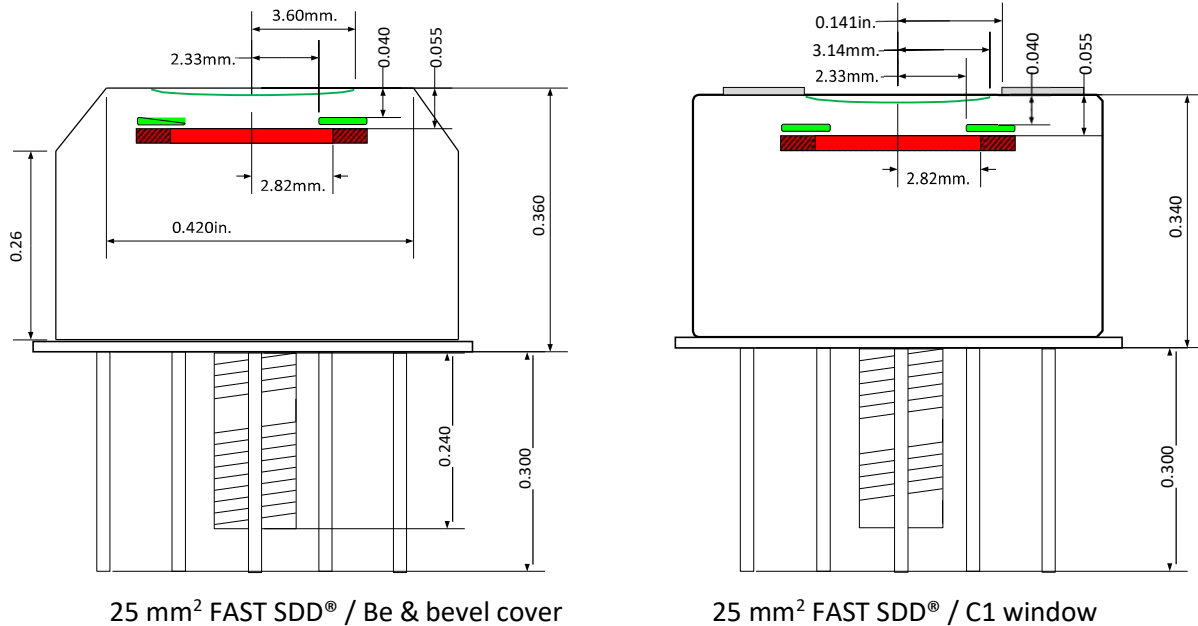

Figure 9. Cross-sections of the two package options for the 25 mm² FASTSDD®.

Compatibility

- The 25 mm² and 70 mm² FAST SDD® detectors are electrically compatible with one another.
- Amptek's FAST SDD® detectors are NOT electrically compatible with the standard SDD, Si-PIN, CdTe, or other Amptek detectors.

5.2 Construction

The detector element (the SDD itself) is mounted on a substrate, which is mounted on a thermoelectric cooler, which is attached to the TO-8 header. A multilayer collimator is mounted on the detector to mask the edges of the active volume. Interactions outside the active volume can cause spectral anomalies. Over this assembly is a cover (typically nickel) containing a window (typically beryllium) through which low energy X-rays pass. With the C1 and C2 windows, a nickel washer is mounted on the front surface to provide additional protection.

- *Window:* The Be windows are attached to the cover with a lead-free solder. The C Series windows are attached with epoxy.
- *Cover:* Standard units are 0.25 mm (10 mils) thick nickel, with an O.D. of 0.55".
- *Header:* Made of Kovar. O.D. is 0.60".
- *Multilayer collimator:* Base metal is 100 μm of tungsten (W), the first layer is 35 μm of chromium (Cr), the second layer is 15 μm of titanium (Ti), and the last layer is 75 μm of aluminum (Al).
- *Substrate:* Alumina (Al₂O₃)

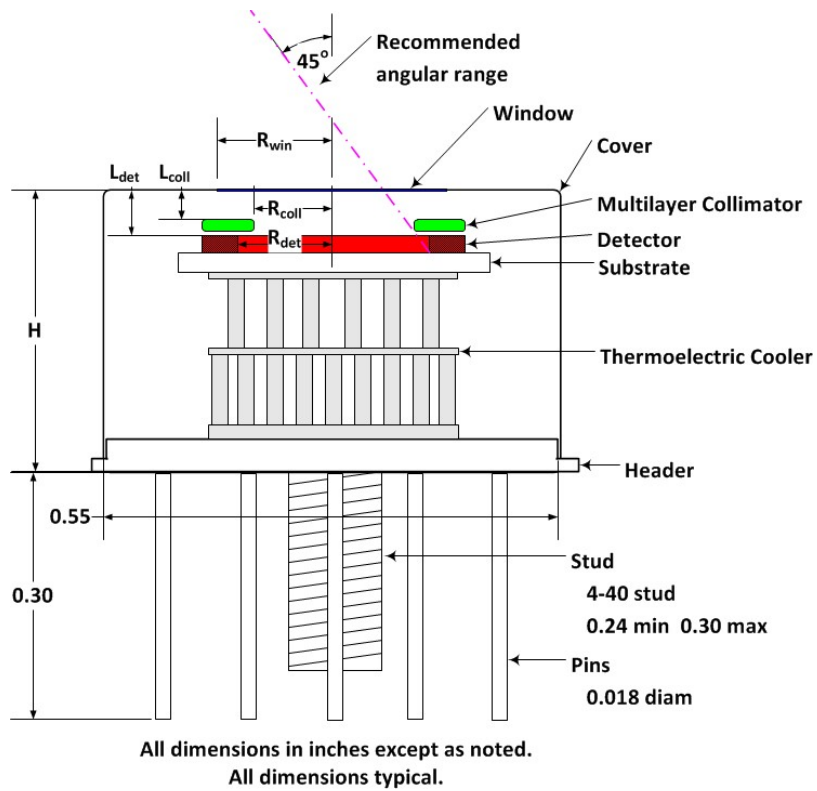

Figure 10. Cross-sections of the package for the 25 mm² FAST SDD®, showing construction details.

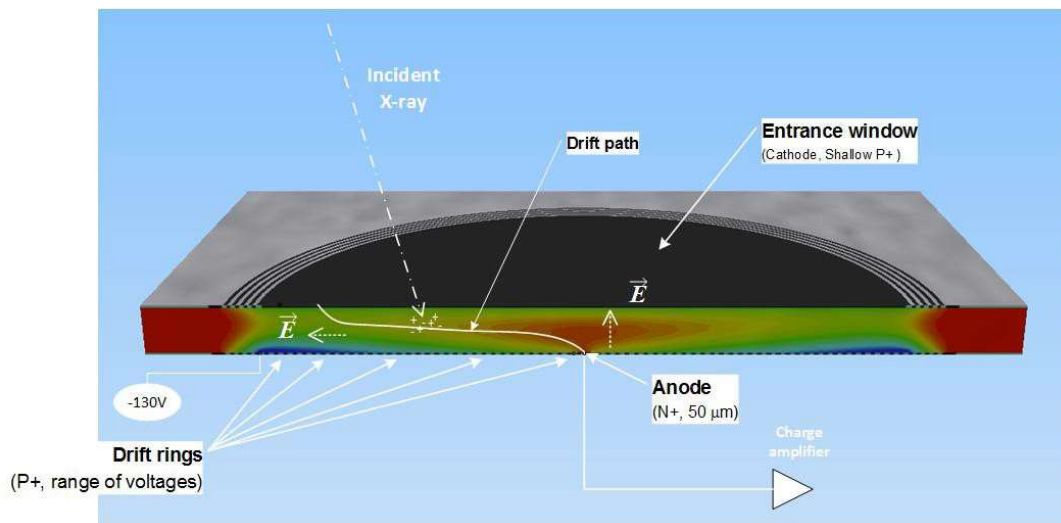

Figure 11. Illustration of the design and operation of a silicon drift detector (SDD).

6 Electrical Interface

6.1 Detector Output Connection Diagram

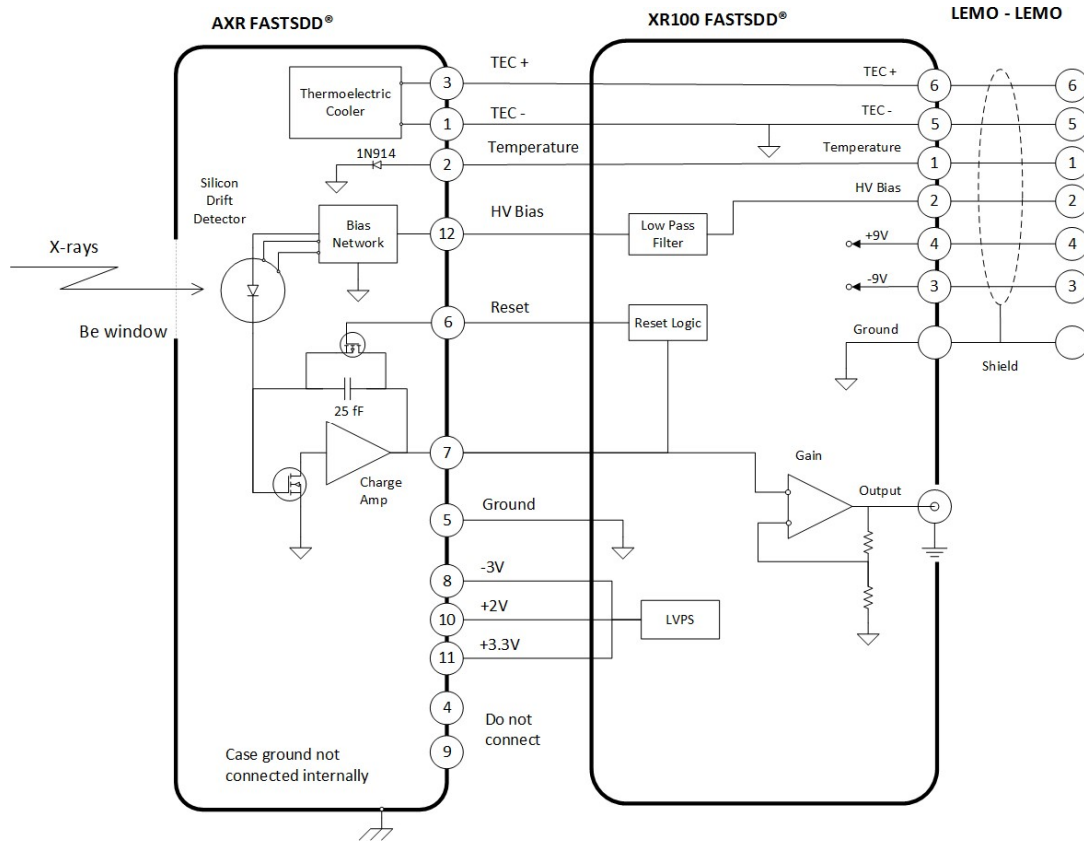
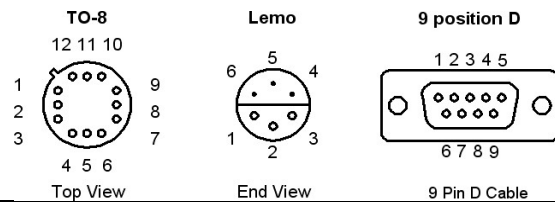

Figure 12. Block diagram of detector and preamp connections for the FAST SDD®.

6.2 XR100 Preamplifier Output Connection Diagram



	6 pin LEMO on XR100 LEMO P/N ERA.1S.306.CLL		9 pin D Connector on ACH-403 cable Standard 9-pin D
1	Temperature Monitor	1	+9 V Preamp Power
2	HV Bias (-130 V)	2	-9 V Preamp Power
3	-9 V Preamp Power	3	Cooler power (3.5 V / 0.45 A MAX)
4	+9 V Preamp Power	4	Temperature Monitor
5	Cooler power return	5	HV Bias (-130 V)
6	Cooler power (3.5 V / 0.45 A MAX)	6	Ground (signal & chassis)
Shield	Ground (signal and chassis)	7	Cooler power return
		8, 9	Ground (signal & chassis)

6.3 Preamplifier Output Signal

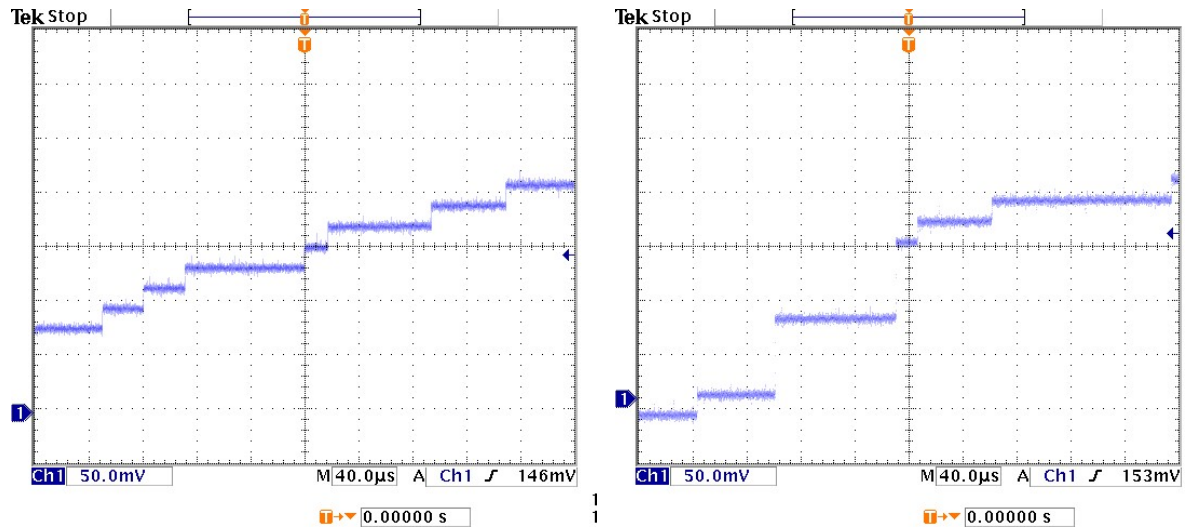

Figure 13. Plots illustrating the typical signals seen from a FAST SDD® preamplifier and DPP. These traces illustrate typical output pulses with a FAST SDD® detector. Each X-ray interaction results in a positive going step of ~ 3.6 mV/keV. On the right, one can distinguish the 5.9 and the 22.1 keV steps.

6.4 Preamplifier Reset Signal

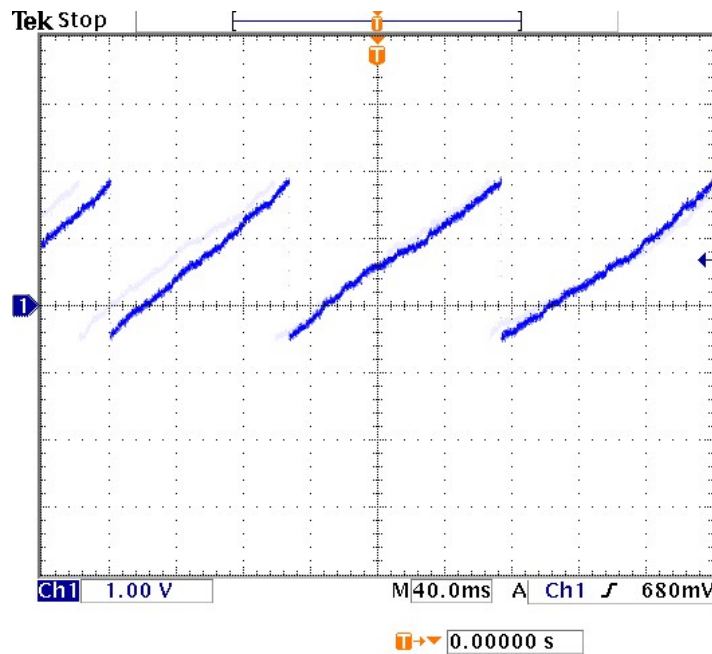

Figure 14. Plot showing the preamp output on a different voltage and time scale to illustrate the reset. The small steps from each signal integrate towards the positive rail, where a reset signal is generated. This results in a sawtooth of several volt amplitude. The period depends on the total current through the detector (signal current plus leakage current).

6.5 Shaped peak and input to the ADC Signals

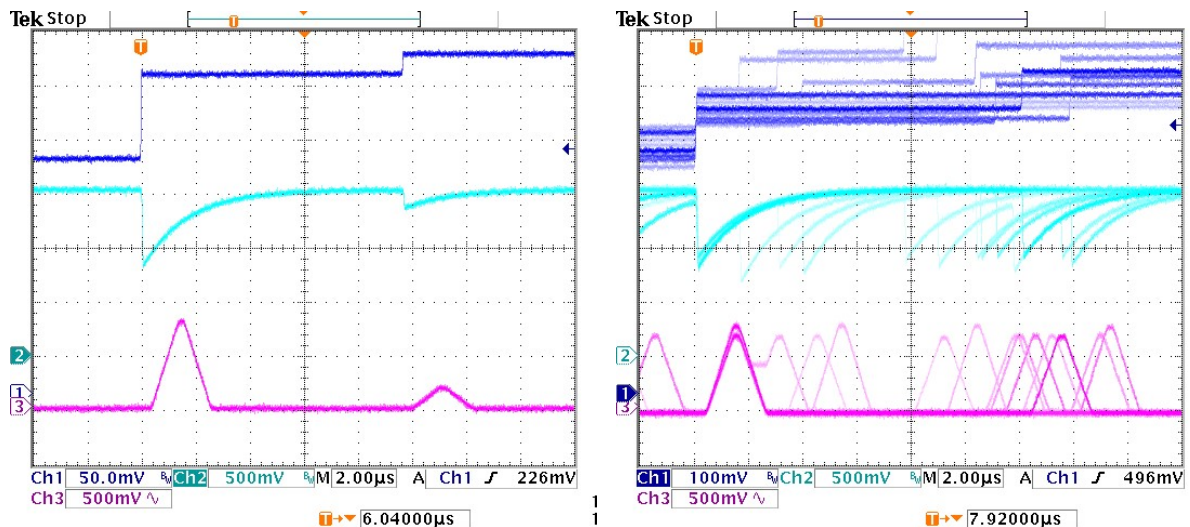

Figure 15. Traces showing the preamplifier output (dark blue), the input to the ADC of an Amptek processor (light blue) and the shaped output from an Amptek processor (magenta) for typical pulses. The trace on the left shows two pulses which are well separated in time. The plot on the right shows several pulses, illustrating the random timing and occasional pulse pileup.

Note that the ADC input has an offset of approximately 1.8 V, with negative going pulses exhibiting an exponential 1.6 us tail. A 1V step into the ADC corresponds to a full scale event in the histogram.

6.6 Cooling

Recommended temperature

What is the recommended operating temperature for the detector (i.e. the photodiode itself)? The electronic noise is improved as cooling is reduced. If the goal is the best possible energy resolution, the lowest possible noise, then operate the detector as cold as possible, with the maximum voltage across the cooler. But this has a couple of disadvantages: (1) power dissipation (and heat sink requirements) increase rapidly as the detector is cooled, and (2) the detector temperature will vary as the ambient temperature varies, and gain is a function of detector temperature, so the stability of the spectrum suffers.

For most users, stability and power are more important than achieving the absolute minimum noise. For the best stability run the detector at the maximum ambient temperature that is expected (e.g. 35 °C) at full cooling. Note the temperature the detector reaches (perhaps 236 K in this example). Then use a set point that is slightly higher (240 K in this example). That way, the detector temperature is as cold as feasible, for stability, in this particular instrument.

Temperature controller

The XR-100FastSDD includes a closed loop temperature controller that regulates the cooler temperature. By default it is enabled and set for maximum cooling and therefore does not regulate on its own. The thermoelectric cooler can achieve 85 °C temperature differential, so at room temperature the detector can reach 220 K to 230 K.

The PX5 includes a power supply for the thermoelectric cooler which provides its own regulation. When the XR-100FastSDD is to be used with a PX5, set the XR-100FastSDD control to maximum cooling

and let the PX5 regulate. If the PX5 and XR-100FastSDD are set to different temperature set points, whichever set point is set the warmest will control the detector temperature.

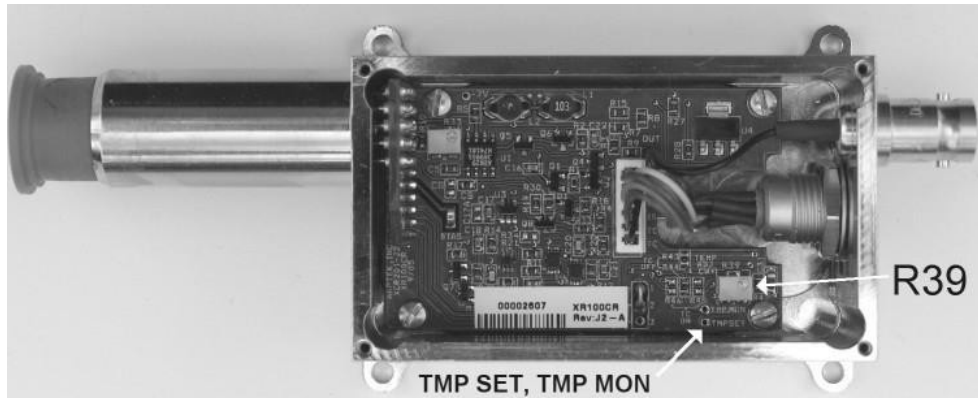

Figure 16. Photograph of open XR100-FastSDD box.

The figure above shows how to adjust the controller on the XR-100FastSDD. Remove the top cover and adjust the R39 pot to achieve the desired TMP SET value. This is the set point temperature. It reads in mV with the calibration curve shown in the next section. TMP MON shows the measured temperature in mV with the same calibration curve.

Temperature sensor

The temperature sensor in Amptek’s detectors is a forward connected 1N914 diode. At a fixed current the forward voltage is a function only of temperature as shown below. Amptek’s standard processors use a 730 μ A current yielding the calibration curve shown. The calibration will change if a different current is used.

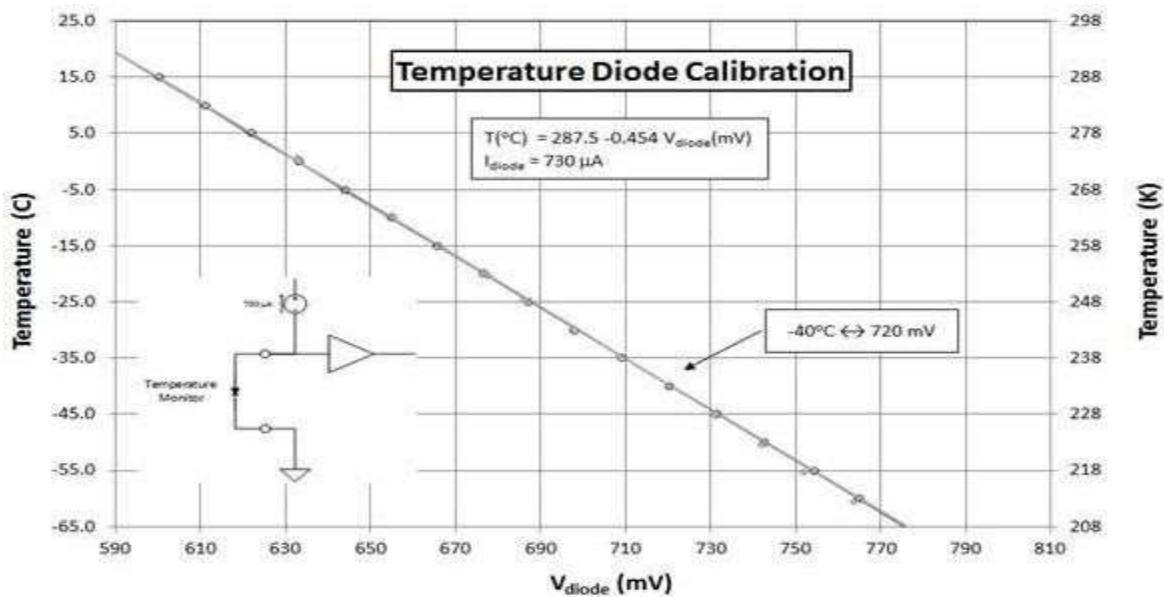

Figure 17. Temperature diode calibration curve.

Thermoelectric cooler

The plot below shows the typical voltage across the cooler and the current through the cooler, as a function of the temperature across the cooler at a base temperature of 30 °C. Cooling is improved at a higher base temperature.

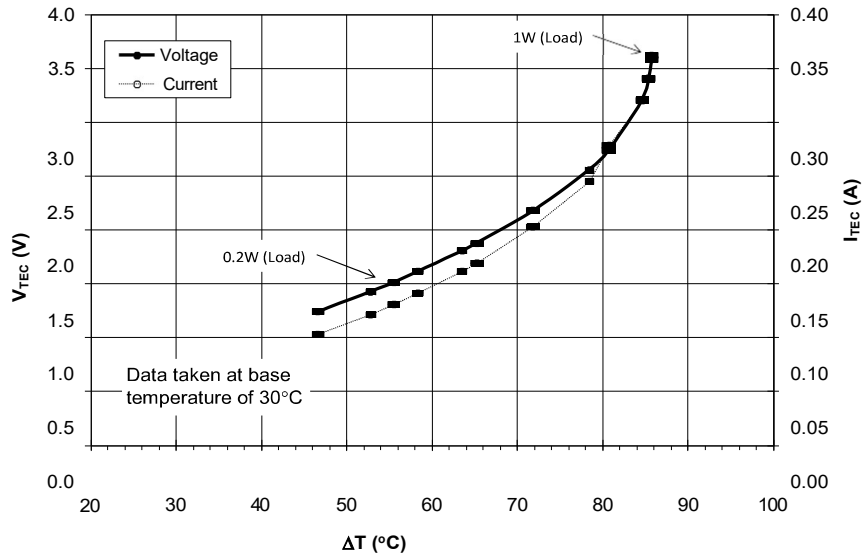

Figure 18. Thermoelectric cooler typical voltage and current curves.

Note that ΔT is difference between the temperature of the detector and that of the base, the TO-8 header and stud. This is typically warmer than the ambient environment. Good performance requires the base to be kept as cold as feasible. Note that the power drawn by the cooler decreases rapidly with ΔT . If maximum cooling ($\Delta T = 85$ °C) occurs at 1 W, at 0.5 W ΔT is about 78 °C, and at 0.2 W, ΔT is 55 °C.

6.7 *Supply Voltages*

High Voltage

The recommended bias voltage for Amptek’s FAST SDD® is typically -130 V at a current of 25 μ A. Any single FAST SDD® will operate with bias voltages over a large range, a factor of two, with little variation in performance. The upper and lower limits will vary from one unit to the next, so a high voltage power supply should be adjustable over a range of -100 to -180V.

There must be very low noise and ripple on the HVPS. Amptek’s power supplies include several low pass filter stages.

Low Voltage Supplies

The preamp power should be between +/- 8 and 9 VDC at 15 mA. There must be < 50 mV p-p noise (lower noise is recommended).

7 Operating Notes

With Amptek power supply

If the XR-100FastSDD is to be used with a power supply from Amptek, e.g. a PX5, PC5, or X-123, then follow the instructions in the “Quick Start” guide provided to you and in the “User Manual” for your power supply.

Without Amptek power supply

If the XR-100FastSDD is to be used with your own power supplies, then follow these instructions.



CAUTION: SUPPLY VOLTAGES MUST BE PROPERLY CURRENT LIMITED when using the XR-100FastSDD without a PX5 power supply. **Current should be limited to values listed below.**

7.1 Equipment Required

- Power Supplies
 - A dual tracking +/-9 VDC @ 35 mA with voltage meter & current limit
 - A zero to +3.5 VDC @ 0.7 A adjustable with voltage and current meter
 - A zero to -135 VDC adjustable @ 25 μ A (see HV requirements)
 - Equivalent supplies, such as Amptek’s PX5 or PC5, may be used.
- Multimeter with high input impedance (>1000 M Ω).
- Signal processing electronics. For a FAST SDD[®], a digital pulse processor such as Amptek’s PX5 or DP5 is strongly recommended. The signal processing electronics should include pulse shaping and multichannel analysis functions.
- Oscilloscope
- Low energy radioactive x-ray source (preferably ⁵⁵Fe)
- AC power outlet strip (preferably with surge suppression & EMI/RFI filtering).

7.2 Absolute Maximum Ratings

- Cooler power.+0.7 AMPS
- Preamp power.+/- 9 VOLTS
- Detector Bias (HV)....
 - -250 VOLTS for 0.5mm thick detectors built by 2022 or earlier.
 - -500 VOLTS for 1mm thick detectors, and all XR100 SDD’s starting 2023.

Connections and Turn-On Procedure (without PX5 or other Amptek DPP/supply)

- 1) Turn all power supplies OFF. Plug all equipment to be used into one common AC power outlet strip. This will help prevent ground loops, which is crucial in getting good performance.
- 2) Set voltages and current limits on all power supplies as noted above. Turn supplies off.
- 3) Connect the LEMO CONNECTOR cable to the XR-100FastSDD, according to the pin assignments given in section 6.1 of this manual.
- 4) Attach the OUTPUT of the XR-100FastSDD to the INPUT of the signal processor. A BNC connector is provided on the rear panel of the XR-100FastSDD. The output pulses of the XR-100FastSDD are POSITIVE.

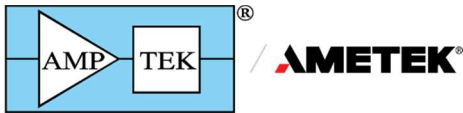

- 5) Attach the OUTPUT of the XR-100FastSDD to one oscilloscope input and the OUTPUT of the shaping amplifier to a second oscilloscope input.
- 6) Turn ON the +/-9 VDC power supplies to power the charge sensitive preamplifier. Verify that both the + and - Volt outputs are between 8 and 9 Volts. NEVER EXCEED 9 VOLTS.
- 7) Increase the - HV supply to - 130 V. The output of the preamplifier should exhibit a sawtooth waveform as in section 6.3 at a fairly high frequency.
- 8) ALWAYS INCREASE THE - HV POWER SLOWLY TO PROTECT THE INPUT FET. WHEN TURNING OFF THE XR-100FastSDD, DECREASE THE - HV SLOWLY TO ZERO VOLTS BEFORE TURNING OFF THE XR-100FastSDD. IF THE FET IS DAMAGED DUE TO HIGH VOLTAGE TRANSIENTS, THE WARRANTY WILL BE VOID.
- 9) Power the temperature sensor using a current source, as shown in section 0, and monitor $V_{\text{temperature}}$ (mV) with a meter.
- 10) While observing the meter slightly increase the cooler supply current until the temperature reading starts to change on the meter. Observe that the voltage is increasing, indicating that the temperature is decreasing. The reset frequency will decrease as the detector cools.
- 11) Once the temperature gets below -40 °C the performance of the XR-100FastSDD system will not change with a temperature variation of a few degrees. Now the XR-100FastSDD is fully operational.
- 12) THE COOLER IS FRAGILE AND WILL BE PERMANENTLY DAMAGED IF EXCESSIVE CURRENT OR IF REVERSE POLARITY IS APPLIED. THE WARRANTY WILL BE VOID IF THE COOLER IS DAMAGED DUE TO EXCESSIVE CURRENT OR REVERSE POLARITY, OR IF THE THIN Be WINDOW IS DAMAGED.
- 13) Remove the red protective cover from the detector of the XR-100FastSDD. Place the X-ray source in front of the detector.
- 14) The output of the signal processor should show the X-ray pulses as shown in section 6.3.
- 15) Once the temperature has stabilized (about one minute), start taking data on the MCA. For normal operation there is no need to monitor the temperature.

8 Troubleshooting

The XR-100FastSDD has undergone extensive testing and burn-in before leaving the factory. If the performance of the system is not similar to the one recorded at the factory before shipping please perform the following tests:

If no spectrum is observed and no counts are observed:

- 8.1 Double check all the power supply voltages and the signal connection.
- 8.2 Make sure the XR-100FastSDD output is connected to a high impedance (not 50 Ω).
- 8.3 Using an oscilloscope verify the presence of the periodic reset signal shown in section 6.3. If there is no reset sawtooth the detector is not functioning.
- 8.4 Verify that the reset period decreases when you place a source in front of the detector.
- 8.5 Check your signal processor. There are many settings in a modern signal processor (gain, input offset, thresholds, etc.) which can prevent the processor from observing the X-rays.
- 8.6 If a spectrum is observed but the resolution is worse than expected or the spectrum is otherwise distorted:
- 8.7 Check the detector temperature and the heat sink.

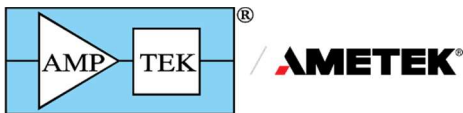

First, make sure that cooling is properly enabled. Observe the temperature the detector reaches.

Second, check the heat sink. The thermoelectric cooler draws up to 1.5 W from the detector to the XR-100 box. If this box is thermally isolated, it will heat up and the detector will heat up.

Third, inspect the Be window on the detector. There is vacuum inside the detector. If the seal on the window is damaged and air enters the detector will not cool fully.

8.8 Look for interference noise.

Connect the XR-100FastSDD output to its signal processor and this to an oscilloscope. Remove all X-ray sources.

8.9 Look for periodic noise pick-up on the scope by changing the time-base dial on the scope back and forth. If you find any periodic signal on the scope (other than the Reset Waveforms), try to eliminate its source or place the XR-100FastSDD away from the pick-up area. Any periodic signal detected on the scope will degrade the resolution of the XR-100FastSDD.

The XR-100 produces very small signals which are susceptible to electromagnetic interference. PLACE THE XR-100FastSDD AWAY FROM ANY COMPUTER TERMINAL OR CRT MONITOR. KEEP THE XR-100FastSDD DETECTOR AWAY FROM MAGNETIC FIELDS.

8.10 If you are using an Amptek signal processor and/or power supply refer to its User Manual and to Amptek's "Troubleshooting guide" and to Amptek's "Grounding and shielding" application note.

8.11 IF ANY QUESTIONS REMAIN CONTACT THE FACTORY FOR FURTHER ASSISTANCE AND RETURN PROCEDURES. If you are using an Amptek signal processor please follow the instructions for "Saving a .MCA file and obtaining diagnostic data," which can be found on your installation CD.

9 Warranty and Technical Questions

9.1 Warranty

AMPTEK, INC. warrants to the original purchaser this instrument to be free from defects in materials and workmanship for a period of one year from shipment. AMPTEK, INC. will, without charge, repair or replace (at its option) a defective instrument upon return to the factory. This warranty does not apply in the event of misuse or abuse of the instrument or unauthorized alterations or repair. AMPTEK, INC. shall not be liable for any consequential damages, including without limitation, damages resulting from the loss of use due to failure of this instrument. All products returned under the warranty must be shipped prepaid to the factory with documentation describing the problem and the circumstances under which it was observed. The factory MUST be notified prior to return shipment. The instrument will be evaluated, repaired, or replaced, and promptly returned if the warranty claims are substantiated. A nominal fee will be charged for unsubstantiated claims. Please include the model and serial number in all correspondence with the factory.

9.2 Technical Questions

- Please refer to <http://amptek.com/technical-support/>
- Please have the model and serial numbers of your Amptek device(s) available. Please have available a description of the signal processing and other electronics used with the device.
- Contact Amptek at amptek.sales@ametek.com or +1 781-275-2242.

10 X-Ray Fluorescence Process Example: Titanium Atom (Ti = 22)

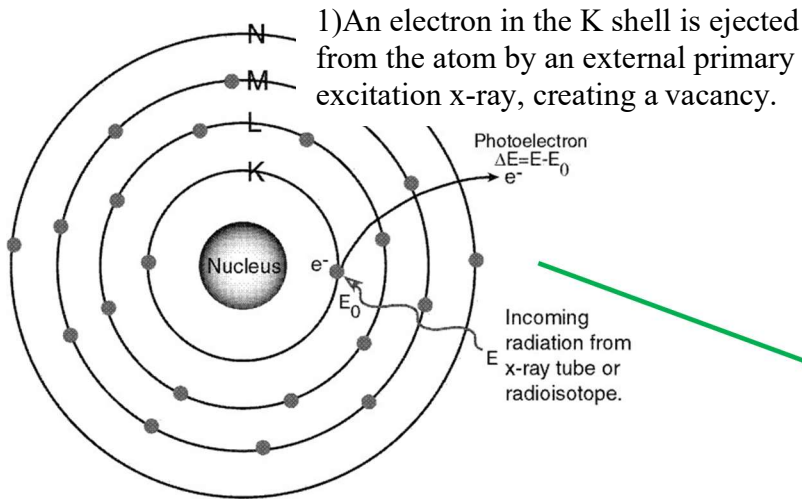

2) An electron from the L or M shell “jumps in” to fill the vacancy. In the process, it emits a characteristic x-ray unique to this element and in turn, produces a vacancy in the L or M shell.

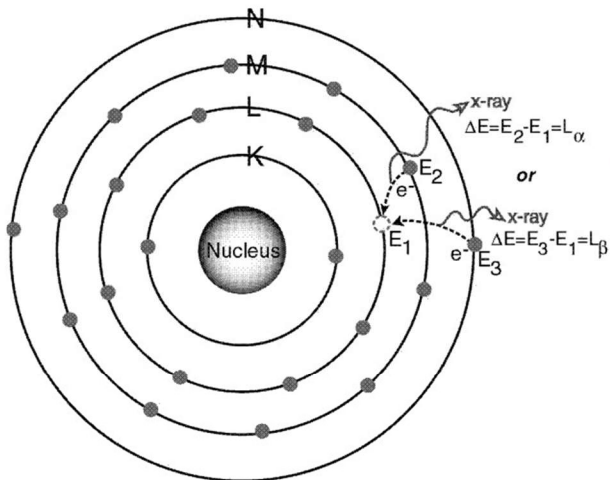
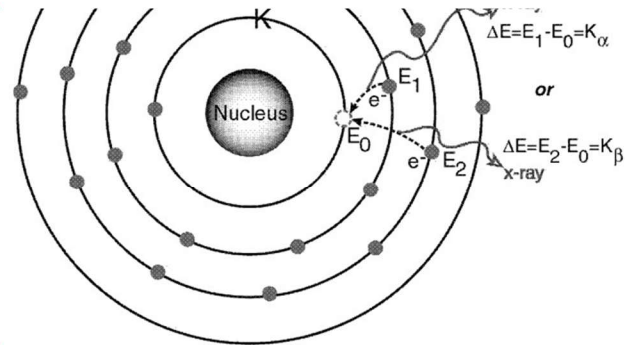

3a) When a vacancy is created in the L shell by either the primary excitation x-ray or by the previous event, an electron from the M or N shell “jumps in” to occupy the vacancy. In this process, it emits a characteristic x-ray unique to this element and in turn, produces a vacancy in the M or N shell.

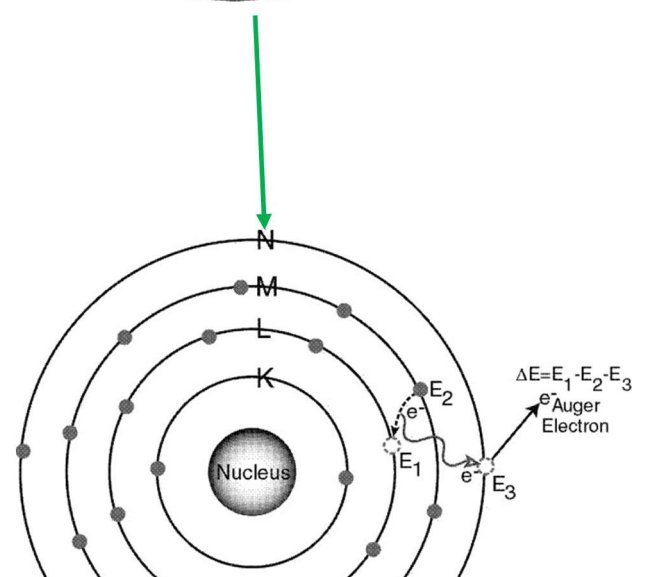

“Auger” Electron

3b) The excitation energy from the inner atom is transferred to one of the outer electrons causing it to be ejected from the atom.

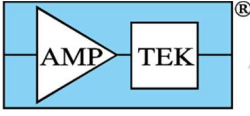

11 Amptek K and L Emission Line Lookup Chart

AMP		TEK		Amptek K and L Emission Line Lookup Chart																
<p>Amptek Inc. 14 DeAngelo Drive Bedford, MA, 01730 USA 781-275-2242 Fax: 781-275-3470 sales@amptek.com www.amptek.com</p>				<p>X-Ray and Gamma Ray Detectors</p> <p>SDD - Si-PIN - CdTe Detectors</p>												<p>VIIIA</p> <p>He 2</p>				
Group IA	IIA	Key to Energy Values in keV		IIIB	IVB	VB	VIB	VII B	VIII B	IIIB	IVB	V B	VI B	VII B	VIII B	IIIA	IVA	V A	VIA	VII A
H 1	Li 3	Be 4	B 5	C 6	N 7	O 8	F 9	Ne 10	Na 11	Mg 12	Al 13	Si 14	P 15	S 16	Cl 17	Ar 18	Kr 36	Xe 54	Rn 86	Actinides 89-103
0.055	0.108	0.185	0.277	0.392	0.523	0.677	0.851	1.026	1.239	1.49	1.55	1.74	1.83	2.01	2.14	2.31	2.46	2.62	2.82	3.19
1.04	1.07	1.25	1.30	1.36	1.41	1.46	1.51	1.56	1.61	1.66	1.71	1.76	1.81	1.86	1.91	1.96	2.01	2.06	2.11	2.16
3.31	3.59	4.09	4.46	4.95	5.43	5.90	6.49	7.06	7.65	8.26	8.90	9.57	10.26	10.98	11.73	12.50	13.29	14.11	14.98	15.94
13.39	14.96	14.16	15.83	14.96	16.74	15.77	17.67	16.61	18.62	17.48	19.61	18.37	21.66	19.28	21.66	20.21	22.72	21.18	23.82	22.17
30.97	34.98	32.20	36.38	55.80	63.21	57.45	65.21	59.31	67.23	61.12	69.30	62.99	71.40	64.91	73.55	66.83	75.74	70.81	80.26	72.87
86.10	97.48	88.48	100.14	90.88	102.85	93.38	105.59	95.89	108.41	100.80	114.18	103.32	117.15	105.97	120.16	108.74	123.24	111.68	126.36	114.78
12.03	14.77	12.34	15.23	12.65	15.71	12.97	16.20	13.29	19.70	13.94	17.74	14.28	19.28	14.62	18.83	14.96	19.39	15.31	19.97	16.02
33.44	37.80	34.72	39.26	36.03	40.75	37.36	42.27	38.73	43.96	40.12	45.40	41.53	47.03	42.99	48.72	44.48	50.39	46.00	52.18	47.53
4.65	5.04	4.84	5.26	5.03	5.49	5.23	5.72	5.43	5.96	5.64	6.21	5.85	6.46	6.06	6.71	6.27	6.98	6.49	7.25	6.72
88.48	100.14	90.88	102.85	93.38	105.59	95.89	108.41	100.80	114.18	103.32	117.15	105.97	120.16	108.74	123.24	111.68	126.36	114.78	129.54	117.65
12.03	14.77	12.34	15.23	12.65	15.71	12.97	16.20	13.29	19.70	13.94	17.74	14.28	19.28	14.62	18.83	14.96	19.39	15.31	19.97	16.02
33.44	37.80	34.72	39.26	36.03	40.75	37.36	42.27	38.73	43.96	40.12	45.40	41.53	47.03	42.99	48.72	44.48	50.39	46.00	52.18	47.53
4.65	5.04	4.84	5.26	5.03	5.49	5.23	5.72	5.43	5.96	5.64	6.21	5.85	6.46	6.06	6.71	6.27	6.98	6.49	7.25	6.72
88.48	100.14	90.88	102.85	93.38	105.59	95.89	108.41	100.80	114.18	103.32	117.15	105.97	120.16	108.74	123.24	111.68	126.36	114.78	129.54	117.65
12.03	14.77	12.34	15.23	12.65	15.71	12.97	16.20	13.29	19.70	13.94	17.74	14.28	19.28	14.62	18.83	14.96	19.39	15.31	19.97	16.02
33.44	37.80	34.72	39.26	36.03	40.75	37.36	42.27	38.73	43.96	40.12	45.40	41.53	47.03	42.99	48.72	44.48	50.39	46.00	52.18	47.53
4.65	5.04	4.84	5.26	5.03	5.49	5.23	5.72	5.43	5.96	5.64	6.21	5.85	6.46	6.06	6.71	6.27	6.98	6.49	7.25	6.72
88.48	100.14	90.88	102.85	93.38	105.59	95.89	108.41	100.80	114.18	103.32	117.15	105.97	120.16	108.74	123.24	111.68	126.36	114.78	129.54	117.65
12.03	14.77	12.34	15.23	12.65	15.71	12.97	16.20	13.29	19.70	13.94	17.74	14.28	19.28	14.62	18.83	14.96	19.39	15.31	19.97	16.02
33.44	37.80	34.72	39.26	36.03	40.75	37.36	42.27	38.73	43.96	40.12	45.40	41.53	47.03	42.99	48.72	44.48	50.39	46.00	52.18	47.53
4.65	5.04	4.84	5.26	5.03	5.49	5.23	5.72	5.43	5.96	5.64	6.21	5.85	6.46	6.06	6.71	6.27	6.98	6.49	7.25	6.72
88.48	100.14	90.88	102.85	93.38	105.59	95.89	108.41	100.80	114.18	103.32	117.15	105.97	120.16	108.74	123.24	111.68	126.36	114.78	129.54	117.65
12.03	14.77	12.34	15.23	12.65	15.71	12.97	16.20	13.29	19.70	13.94	17.74	14.28	19.28	14.62	18.83	14.96	19.39	15.31	19.97	16.02
33.44	37.80	34.72	39.26	36.03	40.75	37.36	42.27	38.73	43.96	40.12	45.40	41.53	47.03	42.99	48.72	44.48	50.39	46.00	52.18	47.53
4.65	5.04	4.84	5.26	5.03	5.49	5.23	5.72	5.43	5.96	5.64	6.21	5.85	6.46	6.06	6.71	6.27	6.98	6.49	7.25	6.72
88.48	100.14	90.88	102.85	93.38	105.59	95.89	108.41	100.80	114.18	103.32	117.15	105.97	120.16	108.74	123.24	111.68	126.36	114.78	129.54	117.65
12.03	14.77	12.34	15.23	12.65	15.71	12.97	16.20	13.29	19.70	13.94	17.74	14.28	19.28	14.62	18.83	14.96	19.39	15.31	19.97	16.02
33.44	37.80	34.72	39.26	36.03	40.75	37.36	42.27	38.73	43.96	40.12	45.40	41.53	47.03	42.99	48.72	44.48	50.39	46.00	52.18	47.53
4.65	5.04	4.84	5.26	5.03	5.49	5.23	5.72	5.43	5.96	5.64	6.21	5.85	6.46	6.06	6.71	6.27	6.98	6.49	7.25	6.72
88.48	100.14	90.88	102.85	93.38	105.59	95.89	108.41	100.80	114.18	103.32	117.15	105.97	120.16	108.74	123.24	111.68	126.36	114.78	129.54	117.65
12.03	14.77	12.34	15.23	12.65	15.71	12.97	16.20	13.29	19.70	13.94	17.74	14.28	19.28	14.62	18.83	14.96	19.39	15.31	19.97	16.02
33.44	37.80	34.72	39.26	36.03	40.75	37.36	42.27	38.73	43.96	40.12	45.40	41.53	47.03	42.99	48.72	44.48	50.39	46.00	52.18	47.53
4.65	5.04	4.84	5.26	5.03	5.49	5.23	5.72	5.43	5.96	5.64	6.21	5.85	6.46	6.06	6.71	6.27	6.98	6.49	7.25	6.72
88.48	100.14	90.88	102.85	93.38	105.59	95.89	108.41	100.80	114.18	103.32	117.15	105.97	120.16	108.74	123.24	111.68	126.36	114.78	129.54	117.65
12.03	14.77	12.34	15.23	12.65	15.71	12.97	16.20	13.29	19.70	13.94	17.74	14.28	19.28	14.62	18.83	14.96	19.39	15.31	19.97	16.02
33.44	37.80	34.72	39.26	36.03	40.75	37.36	42.27	38.73	43.96	40.12	45.40	41.53	47.03	42.99	48.72	44.48	50.39	46.00	52.18	47.53
4.65	5.04	4.84	5.26	5.03	5.49	5.23	5.72	5.43	5.96	5.64	6.21	5.85	6.46	6.06	6.71	6.27	6.98	6.49	7.25	6.72
88.48	100.14	90.88	102.85	93.38	105.59	95.89	108.41	100.80	114.18	103.32	117.15	105.97	120.16	108.74	123.24	111.68	126.36	114.78	129.54	117.65
12.03	14.77	12.34	15.23	12.65	15.71	12.97	16.20	13.29	19.70	13.94	17.74	14.28	19.28	14.62	18.83	14.96	19.39	15.31	19.97	16.02
33.44	37.80	34.72	39.26	36.03	40.75	37.36	42.27	38.73	43.96	40.12	45.40	41.53	47.03	42.99	48.72	44.48	50.39	46.00	52.18	47.53
4.65	5.04	4.84	5.26	5.03	5.49	5.23	5.72	5.43	5.96	5.64	6.21	5.85	6.46	6.06	6.71	6.27	6.98	6.49	7.25	6.72
88.48	100.14	90.88	102.85	93.38	105.59	95.89	108.41	100.80	114.18	103.32	117.15	105.97	120.16	108.74	123.24	111.68	126.36	114.78	129.54	117.65
12.03	14.77	12.34	15.23	12.65	15.71	12.97	16.20	13.29	19.70	13.94	17.74	14.28	19.28	14.62	18.83	14.96	19.39	15.31	19.97	16.02
33.44	37.80	34.72	39.26	36.03	40.75	37.36	42.27	38.73	43.96	40.12	45.40	41.53	47.03	42.99	48.72	44.48	50.39	46.00	52.18	47.53
4.65	5.04	4.84	5.26	5.03	5.49	5.23	5.72	5.43	5.96	5.64	6.21	5.85	6.46	6.06	6.71	6.27	6.98	6.49	7.25	6.72
88.48	100.14	90.88	102.85	93.38	105.59	95.89	108.41	100.80	114.18	103.32	117.15	105.97	120.16	108.74	123.24	111.68	126.36	114.78	129.54	117.65
12.03	14.77	12.34	15.23	12.65	15.71	12.97	16.20	13.29	19.70	13.94	17.74	14.28	19.28	14.62	18.83	14.96	19.39	15.31	19.97	16.02
33.44	37.80	34.72	39.26	36.03	40.75	37.36	42.27	38.73	43.96	40.12	45.40	41.53	47.03	42.99	48.72	44.48	50.39	46.00	52.18	47.53
4.65	5.04	4.84	5.26	5.03	5.49	5.23	5.72	5.43	5.96	5.64	6.21	5.85	6.46	6.06	6.71	6.27	6.98	6.49	7.25	6.72