© Copyright Agilent
Technologies 2000

All rights reserved.
Reproduction, adaption, or
translation without prior
written permission is
prohibited, except as
allowed under the
copyright laws.

Agilent Part No.
37718-90218

Printed in U.K. September
2000.

Warranty

The information contained
in this document is subject
to change without notice.

*Agilent Technologies
makes no warranty of any
kind with regard to this
material, including, but
not limited to, the implied
warranties or
merchantability and fitness
for a particular purpose.*

Agilent Technologies shall
not be liable for errors
contained herein or for
incidental or consequential
damages in connection
with the furnishing,
performance, or use of this
material.

WARNING

Warning Symbols Used on
the Product



The product is marked
with this symbol when the
user should refer to the
instruction manual in order
to protect the apparatus
against damage.

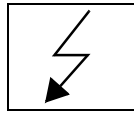

The product is marked
with this symbol to
indicate that hazardous
voltages are present



EN 60825 1991

The product is marked
with this symbol to
indicate that a laser is
fitted. The user should
refer to the laser safety
information in the
Verification Manual.

OmniBER 718 SONET User Guide

About This Book

This book tells you how to select the features that you want to use for your test.

The selections available are presented in the following groups:

- Transmit and receive interfaces
- Test features, for example, the addition of errors and alarms to the test signal
- Measurements including test timing
- Storing, logging and printing results with general printer information
- Using instrument and disk storage
- Using the “Other” features.

The selections available will depend on the options fitted to your instrument. The examples given in this book cover all options and therefore may include selections which are not available on your instrument.

1 Introduction

- Product Description 14
- Conventions 15
- Connecting to the Network 16
- Connecting Accessories 20
- Front Panel Soft Recovery (Cold Start) 21
- OmniBER 718 Option Guide 22

2 Setting the Interfaces

- Setting PDH/DSn Transmit Interface (Option 012) 26
- Setting DSn THRU Mode 28
- Setting SONET Transmit Interface 29
- Setting Jitter Transmit Interface 33
- Setting Wander Transmit Interface 35
- Setting SONET THRU Mode 37
- Using Smart Test 40
- Setting PDH/DSn Receive Interface 45
- Setting SONET Receive Interface 47
- Setting Jitter Receive Interface 48
- Setting Extended Jitter Receive Interface 49
- Setting Wander Receive Interface 50

3 Selecting Test Features

- Using Transmit Overhead Setup 52
- Using Receive Overhead Monitor 54

Setting Overhead Trace Messages 56
Setting Overhead Labels 57
Generating Overhead Sequences 58
Using Receive Overhead Capture 60
Adding Frequency Offset to SONET Signal 62
Adding Frequency Offset to the DS_n Signal 64
Setting up Signaling Bits 65
Setting Transmit Structured Payload/Test Signal 68
Setting Receive Structured Payload/Test Signal 70
Setting Transmit N x 64 kb/s/N x 56 kb/s
Structured Payload/Test Signal 71
Setting Receive N x 64 kb/s/N x 56 kb/s
Structured Payload/Test Signal 73
Inserting an External DS_n Payload/Test Signal 74
Dropping an External Payload/Test Signal 77
Adding Errors and Alarms at the SONET Interface 80
Adding Errors and Alarms to a DS_n Signal 81
Using FEAC Codes 82
Setting DS_n Spare Bits 84
Adding Pointer Adjustments 85
Using Pointer Graph Test Function 93
Stressing Optical Clock Recovery Circuits 95
Generating Automatic Protection Switch (APS) Messages 97
Inserting and Dropping the Data Communications Channel 102
Using DS1 LOOP Codes 103

4 Making Measurements

Using Overhead BER Test Function 108
Performing a Trouble Scan 109

Test Timing 111
Making SONET Analysis Measurements 112
Making DSn Analysis Measurements 113
Measuring Frequency 114
Measuring Optical Power 115
Measuring Round Trip Delay 116
Monitoring Signaling Bits 118
Measuring Service Disruption Time 119
Performing a SONET Tributary Scan 122
Performing a SONET Alarm Scan 125
Performing a DSn Alarm Scan 126
Measuring Jitter 127
Measuring Extended Jitter 129
Measuring Wander 131
Measuring Jitter Tolerance 134
Measuring Jitter Transfer 138
Measuring Pointer Adjustment (Tributary) Jitter 144

5 ATM Operation

Setting up the Transmitter for ATM Payloads 150
Setting up the Convergence Sublayer 153
Setting Foreground Traffic 155
Setting Background Traffic 157
Setting Foreground and Background Distributions 158
Transmitting ATM Alarms 161
Adding ATM Errors 163
Viewing ATM Results 165
Setting up the Receiver for ATM Payloads 166
Setting up the Receiver ATM signal 168

Policing ATM Traffic 170
Measuring ATM Delay Performance 172
Measuring ATM Alarms 175
ATM Service Disruption 176

6 Packet over SONET (POS)

POS Protocol Stack 180
Setting up the Transmitter for POS Payloads 181
Setting HDLC Framing, Scrambling and HDLC Frame Check Sequence 183
Setting IP Packet (Datagram) Length and Inter-Packet Gap 186
Setting IP Header 188
Setting IP Addresses 189
Setting IP Payload 190
Adding POS Alarms 191
Adding POS Errors 192
Setting up the Receiver for POS Operation 193
Setting up the Receiver POS signal 195
Viewing POS Results 196
POS Applications 197
Channelized Testing 198
Fully Exercising POS Hardware Architecture 200
Throughput Testing 204
Continuity Test 208
POS Service Disruption 211
HDLC Frame Stuffing 214
Jitter Tolerance Testing of POS Equipment 217

7 Storing, Logging and Printing

- Saving Graphics Results to Instrument Store 222
- Recalling Stored Graph Results 223
- Viewing the Bar Graph Display 225
- Viewing the Graphics Error and Alarm Summaries 227
- Logging Graph Displays 229
- Logging Results 231
- Logging on Demand 241
- Logging Jitter Tolerance Results 245
- Logging Jitter Transfer Results 247
- Logging Results to Parallel (Centronics) Printer 249
- Logging Results to GP-IB Printer 250
- Logging Results to Internal Printer 251
- Logging Results to RS-232-C Printer 252
- Printing Results from Disk 253
- Connecting a Printer to a Parallel Port 254
- Changing Internal Printer Paper 255
- Cleaning Internal Printer Print Head 258

8 Using Instrument and Disk Storage

- Storing Configurations in Instrument Store 260
- Titling Configuration in Instrument Store 261
- Recalling Configurations from Instrument Store 262
- Formatting a Disk 263
- Labeling a Disk 264
- Managing Files and Directories on Disk 265
- Saving a Screen Dump to Disk 272
- Saving Graphical Results to Disk 274

Saving Data Logging to Disk 276
Saving Configurations to Disk 277
Recalling Configuration from Disk 278
Recalling Graphics Results from Disk 279
Copying Configuration from Instrument Store to Disk 280
Copying Configuration from Disk to Instrument Store 282
Copying Graphics Results from Instrument Store to Disk 284

9 Selecting and Using "Other" Features

Coupling Transmit and Receive Settings 288
Setting Time & Date 289
Enabling Keyboard Lock 290
Enabling Beep on Received Error 291
In-Band DS1 Loopcode 156MTS Compatibility 292
Suspending Test on Signal Loss 293
REI-L Result/Enable 294
AIS-L Result/Enable 295
Graph Storage Resolution 296
Setting Error Threshold Indication 297
Setting Screen Brightness and Color 298
To Generate a New Jitter Mask 299
To change the parameters of a User-defined jitter mask 301
Running Self Test 303
Trigger Output 306

10 STS-1 SPE Background Patterns

11 ETSI/ANSI Terminology

ETSI/ANSI Conversion and Equivalent Terms 312

12 Glossary of Terms

1

"Product Description " page 14

"Conventions " page 15

"Connecting to the Network " page 16

"Connecting Accessories " page 20

"Front Panel Soft Recovery (Cold Start) " page 21

"OmniBER 718 Option Guide " page 22

Introduction

Product Description

Product Description

The OmniBER Communications Performance Analyzer provides all the test capability you need to fully verify the performance of today's high-capacity transmission systems and networks.

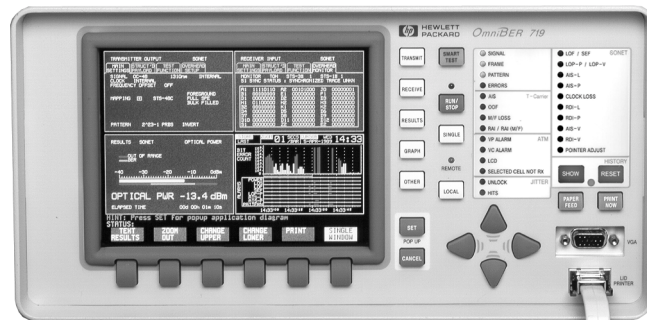

The main features of a dual standard (SDH/SONET) instrument are as follows:

- Multi-rate transmission testing from DS0 to OC-48.
- Supports concatenated payloads of VT 1.5 to STS-48c.
- Full PDH/T-carrier testing.
- Direct measurement of protection switching time.
- Powerful thru-mode testing for SONET ring turn-up.
- Comprehensive SONET overhead testing.
- Packet over SONET/SDH (POS) and ATM payloads up to 2.5 Gb/s.
- Fast access to key measurement tasks via Smart Test.
- Optical power and line frequency measurements.
- J0 section trace for DWDM testing
- J1 and J2 path trace for network path testing
- Optional integrated graphical printer.
- Transmit and Receive can be independently configured.

Conventions

Conventions

The conventions used in this manual to illustrate instrument keys and display information are as follows:

TRANSMIT

This is an example of a hardkey. Hardkeys (located to the right of the display) are used to give access to different sets of instrument settings, or select dedicated instrument functions. The key shown here displays the transmit settings.

PARALLEL

This is an example of a softkey. Softkeys (located below the display) are used to select instrument settings. The values associated with softkeys change as you move the display cursor from one instrument setting to another.



These are the cursor control keys. They are used to move the display cursor from one instrument setting to another.



This is an example of a pop-up menu. Pop-up menus are an alternative way of selecting instruments settings (instead of using softkeys). To access a pop-up menu, highlight an instrument setting, then use the **SET** key.



This symbol (when it appears next to settings on the display) indicates that there is a pop-up application associated with the instrument setting. To access a pop-up application, highlight the instrument setting which has this symbol, then use the **SET** key.



This symbol appears at the bottom right of the display when an optical transmit module is fitted to the instrument. The symbol's background changes from black to yellow when the optical output goes active.

Connecting to the Network

Connecting to the Network

The network connectors are located on the modules at the side of the instrument. The connections available depend on the options fitted to your instrument.

Before Connecting, note the Warning and Caution information given.

Removing/Inserting Modules

Modules should only be removed or inserted by trained personnel.

All Connectors

CAUTION

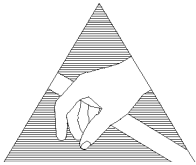

When connecting or disconnecting, ensure that you are grounded or, make contact with the metal surface of the Mainframe with your free hand to bring you, the module, and the mainframe to the same static potential.

Modules remain susceptible to ESD damage while the module is installed in the Mainframe

Additional ESD information is required when servicing, see your Verification manual for further information.

Connecting to the Network

Optical Interface Connectors

For your protection, review all laser information given in this manual and the Verification manual before installing or using the instrument.

WARNING

To prevent personal injury, avoid use that may be hazardous to others, and maintain the module in a safe condition. Ensure the information given below is reviewed before operating the module.

Laser Product Classification

All optical modules are classified as Class I (non-hazardous) laser product in the USA which complies with the United States Food and Drug Administration (FDA) Standard 21 CFR Ch.1 1040.10, and are classified as Class 1 (non-hazardous) laser products in Europe which complies with EN 60825-1 (1994).

To avoid hazardous exposure to laser radiation, it is recommended that the following practices are observed during system operation:

- **ALWAYS DEACTIVATE THE LASER BEFORE CONNECTING OR DISCONNECTING OPTICAL CABLES.**
- When connecting or disconnecting optical cables between the module and device-under-test, observe the connection sequences given below.

Connecting: Connect the optical cable to the input of the device-under-test **before** connecting to the module's *Optical Out* connector.

Disconnecting: Disconnect the optical cable from the module's *Optical Out* connector **before** disconnecting from the device-under-test. Always fit the fibre optic connector dust caps over the laser aperture.

- NEVER examine or stare into the open end of a broken, severed, or disconnected optical cable when it is connected to the module's *Optical Out* connector.
- Arrange for service-trained personnel, who are aware of the hazards involved, to repair optical cables.

Connecting to the Network

CAUTION

1. Use of controls or adjustments or performance of procedures other than those specified herein may result in hazardous radiation exposure.
 2. Always fit the fibre optic connector dust caps on each connector when not in use. Before connection is made, *always* clean the connector ferrule tip with acetone or alcohol and a cotton swab. Dry the connector with compressed air. Failure to maintain cleanliness of connectors is liable to cause excessive insertion loss.
-

Laser Warning Symbols

The front panel of the optical module has the following label:

CLASS 1 LASER PRODUCT

NOTE

CLASS 1 LASER PRODUCT translates as follows:

Finnish - LUOKAN 1 LASERLAITE

Finnish/Swedish - KLAS 1 LASER APPARAT

This label indicates that the radiant energy present in this instrument is non-hazardous.

OPTICAL IN

Allows connection of an optical signal, wavelength 1200 to 1600 nm, at a maximum input power level of -8 dBm. **NEVER EXCEED +3 dBm.**

Accepts SONET signals OC-1, OC-3, OC-12 and OC-48 and SDH signals STM-0, STM-1, STM-4 and STM-16 depending on the instrument options fitted.

OPTICAL OUT

Provides optical signals OC-1, OC-3, OC-12 or OC-48 at wavelength 1290 nm to 1330 nm, at a typical power level of +1 dBm. Also provides SDH signals STM-0, STM-1, STM-4 and STM-16 depending on the instrument options fitted.

Connecting to the Network

Cleaning Optical Connectors

It is recommended that the optical connectors be cleaned at regular intervals using the following materials:

Description	Part Number
Blow Brush	9300-1131
Isopropyl Alcohol	8500-5344
Lens Cleaning Paper	9300-0761
Adhesive Tape Kit	15475-68701

CAUTION

Do not insert any tool or object into the IN or OUT ports of the instrument as damage to or contamination of the optical fibre may result.

- 1 Recall Default settings (STORED SETTINGS 0) and remove the power from the OmniBER 718.
- 2 Remove the adapters from the IN and OUT ports. Use an 11 mm spanner to slacken the nut securing the adapter. On re-assembly tighten the nut using a torque spanner to 1.5 Nm.
- 3 Using the blow brush with the brush removed blow through the ferrule of the standard flexible connector and the adapter.

CAUTION

If the optical fibre of the fixed connector requires further cleaning this entails disassembly of the module which should only be carried out by suitably trained service personnel.

- 4 Apply some isopropyl alcohol to a piece of the cleaning paper and clean the barrel of the adapter. Using a new piece of cleaning paper, clean the face of the adapter. Repeat this operation, using a new piece of cleaning paper each time.
- 5 Lightly press the adhesive side of the tape provided against the front of the adapter, then remove it quickly - repeat twice. This removes any particles of cleaning paper which may be present.
- 6 Replace the adapters on the flexible connector.

Connecting Accessories

Connecting Accessories

LID Provides the output for the option 602 printer which is fitted in the cover (LID) of the instrument.

VGA Provides the output for a display monitor.

HANDSET Allows connection of a telephone handset for communication across the network.

Printer
HP-IB (GPIB),
RS232,
PARALLEL ONLY

The port selected for external printer use is not available for remote control. See "Connecting a Printer to a Parallel Port " page 254.

Remote Control
HP-IB (GPIB),
RS232,
10 BASE -T

Remote control connection is given in the Remote Control Manual. The port selected for remote control use is not available for an external printer.

10 Base-T Lan Connection Radiated Emissions

To ensure compliance with EN 55011 (1991) a category 5, STP patch lead, RJ45 cable should be used to connect the LAN port on the processor module marked "10 Base-T".

Front Panel Soft Recovery (Cold Start)

Front Panel Soft Recovery (Cold Start)

Use the following procedure if you need to perform a front panel soft recovery (i.e. cold start) of the instrument.

Soft Recovery Procedure

- 1 Switch off the instrument.
- 2 On the instrument front panel - press and hold softkeys 0 and 4 simultaneously (the softkeys immediately below the display; key 0 is on the extreme left).
- 3 Power up the OmniBER 718 while holding the softkeys pressed.
- 4 When the LOS LED has flashed OFF and then ON again, the keys can be released.
- 5 The LOS LED will flash OFF/ON again several times (7), followed by an audible 'beep' and the display indicating 'Initializing Instrument'.
- 6 Once the initialization is complete the display will indicate:
'Firmware Revision Update'
'Default settings assumed'
Hit any key to attempt restart'
- 7 Hit any key, then wait approximately 10 seconds. The instrument should return to its default settings and normal operation.

OmniBER 718 Option Guide

This guide explains the features offered with each OmniBER Mainframe and its associated options. There are three mainframes as follows:

- The 37718A
- The 37718B
- The 37718C

The instrument test interfaces are:

2.5 Gb/s, 622 Mb/s, 155 Mb/s, 52 Mb/s, DS1 (1.5 Mb/s), DS3 (45 Mb/s), E1 (2 Mb/s), E2 (8Mb/s), E3 (34 Mb/s).

Mainframe test rate capability

Mainframe	Test Rate Capability
37718A	2.5 Gb/s, 622 Mb/s, 155 Mb/s and 52 Mb/s
37718B	622 Mb/s, 155 Mb/s and 52 Mb/s
37718C	155 Mb/s and 52 Mb/s

Note that 52 Mb/s and 155 Mb/s electrical testing is included in the base mainframe.

SDH/SONET Interface

Interface	Option
SDH only	001
Dual standard SDH/SONET (ANSI/ITU-T)	002

OmniBER 718 Option Guide

Tributary test options

	Option
PDH/T-carrier DS1, DS3, 2 Mb/s, 8 Mb/s, 34 Mb/s and 140 Mb/s	012
2 Mb/s into DS3 mapping (also requires option 012)	014
Replaces BNC connector with WECO 560	620

Optical interface

An optical interface must be ordered if an 37718A or 37718B is required.

	Option
1310 nm only	104
1550 nm only	105
Dual wavelength 1310 nm/1550 nm	106
Replaces FC/PC adapters with SC	610
Replaces FC/PC adapters with ST	611

Jitter

	Option
Adds jitter to all rates	200

OmniBER 718 Option Guide

ATM/POS

	Option
ATM payloads (requires option 350)	300
POS payloads (requires option 350)	310
Advanced payload engine	350

Please note that in earlier versions of the OmniBER the list of ATM options included options 300, 301 and 302. These options have now been merged into one ATM option 300 (as listed above). A new Advanced payload engine option 350 has been added which must be ordered with an ATM or POS option.

Accessory options

	Option
Remote Omnibook controller	600
RS-232-C, GPIB and LAN remote control interfaces	601
80-column in-lid printer	602

“Setting PDH/DSn Transmit Interface (Option 012)” page 26

“Setting DSn THRU Mode” page 28

“Setting SONET Transmit Interface” page 29

“Setting Jitter Transmit Interface” page 33

“Setting Wander Transmit Interface” page 35

“Setting SONET THRU Mode” page 37

“Using Smart Test” page 40

“Setting PDH/DSn Receive Interface” page 45

“Setting SONET Receive Interface” page 47

“Setting Jitter Receive Interface” page 48

“Setting Extended Jitter Receive Interface” page 49

“Setting Wander Receive Interface” page 50

Setting the Interfaces

This chapter tells you how to set the instrument interfaces to match the network being tested.

Setting the Interfaces

Setting PDH/DSn Transmit Interface (Option 012)

Description

DSn transmit interface settings should match network equipment settings of Rate, Termination and Line Code and determine the Payload to be tested.

TIP:

To set the Transmitter and Receiver to the same interface settings choose **OTHER SETTINGS CONTROL COUPLED**.

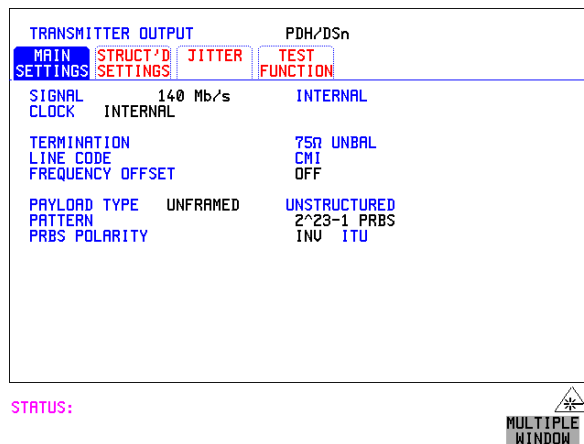

HOW TO:

- 1 Choose the required SIGNAL rate from 2 Mb/s, 8 Mb/s, 34 Mb/s, 140 Mb/s PDH, plus DS1, DS3 T-carrier interfaces.
- 2 Choose the required CLOCK SYNC source, internally generated, externally generated or recovered from the received PDH/DSn signal. If you select an external clock source, connect the external source to the appropriate port on the OmniBER clock module.
- 3 If DS1 or DS3 is chosen, choose the required OUTPUT LEVEL.
- 4 If you have chosen 2 Mb/s as the SIGNAL rate, choose the required TERMINATION. (At all other signal rates the impedance is fixed).

Setting the Interfaces

Setting PDH/DSn Transmit Interface (Option 012)

- 5 If you have chosen 8 Mb/s, 2 Mb/s or DS1 as the SIGNAL rate, choose the required LINE CODE. (At 140 Mb/s, 34 Mb/s and DS3 coding is fixed).
- 6 If required, choose the FREQUENCY OFFSET value.
See “Adding Frequency Offset to the DSn Signal” page 64.
- 7 Choose the required PAYLOAD TYPE.
If **STRUCTURED** is required **FRAMED** must be chosen.
If **STRUCTURED** is chosen the DSn test signal must be set up. See “Setting Transmit Structured Payload/Test Signal” page 68.
If you have chosen 2 Mb/s, DS1 or DS3 as the DSn SIGNAL rate, the Framed choice is expanded to provide a menu of framing types.
- 8 Choose the PATTERN type and the PRBS POLARITY.

Additional Patterns at DS1

- 9 If you select a DS1 SIGNAL, two 8-bit patterns and a 55 Octet pattern are added to the list of available patterns. The 8-bit patterns are as follows:

Table 1 **8-Bit Patterns**

Type	Pattern
1-in-8	F01000000
2-in-8	F01100000

Note 1: F indicates the position of the framing bit with respect to the 8-bit pattern when the framed data is generated

Note 2: Both 8-bit patterns and the 55 Octet pattern can only be selected as a payload for the whole DS1, i.e. they can not be selected as a pattern for an individual 64 kb/s channel.

Note 3: Bit errors can be added to both 8-Bit and 55 Octet test patterns as with the other available test patterns.

The 55 Octet pattern uses the Daly pattern as per ANSI T1.403

Setting the Interfaces

Setting DSn THRU Mode

Setting DSn THRU Mode

Description

THRU mode is used to non-intrusively monitor DSn lines where no protected monitor points are available.

Note that since THRU mode locks some user settings, you must set SIGNAL RATE (DS1 or DS3), before selecting THRU mode.

Two modes of operation are possible:

Monitor Mode: This is when the Entire Frame Error Rate field is set to **OFF**. In this mode the received signal is passed through or transmitted unchanged, and the instrument monitors errors and alarms as normal DS1 operation.

Full Frame Overwrite Mode: In this mode any bit in the entire frame can be errored at a user defined rate. The bit that is errored can be any bit in the frame, including the frame bit (hence the title of “Full Frame Overwrite”). The error rates available are:

Data error rates: 1.0E-3, 1.0E-4, 1.0E-5, 1.0E-6, 1.0E-7 and user programmable in 0.1 steps from 1.1E-3 to 1.0E-9

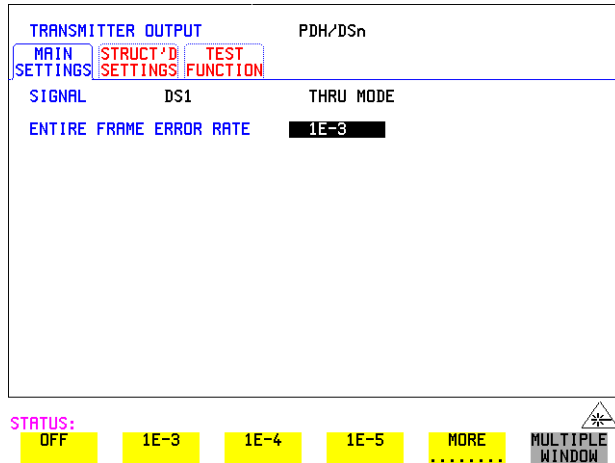

HOW TO:

- 1 Make the required SIGNAL RATE choice on the PDH/DSn **TRANSMIT** and **RECEIVE** displays.
- 2 Select THRU MODE as shown in the figure above.
- 3 Select an entire frame error rate from the choices given or use the USER softkey to program an error rate.

Setting SONET Transmit Interface

Payload Selection

One of the key features of the OmniBER 718 is the ability to test concatenated payloads. The following gives a brief description of concatenated payloads, and the benefits of using them.

Concatenated Payloads

Bulk filled or contiguous payload structures e.g. (STS-48c) are designed for carrying broadband services. The entire payload area is used to carry the service with no structured mapping or channelization.

In the case of a concatenated STS-48 (denoted STS-48c), the virtual container area is entirely filled by a single STS-48c SPE. This STS-48c SPE consists one Path Overhead and a single container capable of carrying a tributary signal operating at rates up to approximately 2.5 Gb/s. Once assembled a STS-48c SPE is multiplexed, switched and transported through the network as a single entity.

Benefits: Test the entire bandwidth in one go, and reduce test times. The following table illustrates the reduced test times using concatenated payloads.

	Test Time (based on 100 errors)	
Performance test limit	STS-48c SPE payload	STS-3c SPE payload
10^{-14}	48 days	>2 years
10^{-13}	4.8 days	77 days
10^{-12}	11.6 hours	7.7 days
10^{-11}	1.2 hour	18.5 hour
10^{-10}	7 minutes	1.9 hours

Setting the Interfaces

Setting SONET Transmit Interface

Description

SONET transmit interface settings should match the network equipment settings of Rate, Wavelength and Mapping, determine the payload to be tested and set background conditions to prevent alarms while testing.

TIP:

If you wish to set the OmniBER 718 transmitter and receiver to the same interface settings choose **OTHER** **SETTINGS CONTROL** **COUPLED**

Laser On/Off Control

If you wish to switch off the laser when connecting/disconnecting cables, set the field between the wavelength and INTERNAL selections to OFF. When the laser is on the laser symbol at the bottom right of the display is illuminated (yellow).

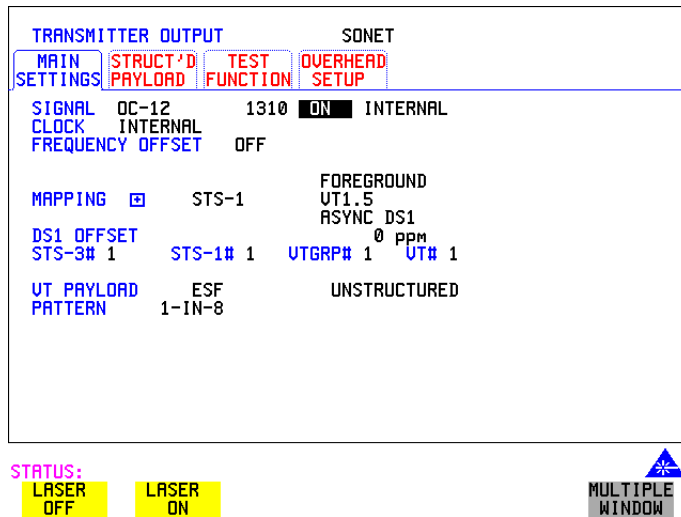

HOW TO:

- 1 Make your choice of SIGNAL rate.
If Option 106, Dual Wavelength optical module, is fitted and an optical rate is chosen, choose the required wavelength (1550 or 1310).
If STS-1 is chosen, choose the required interface level.
Choose **INTERNAL** unless **THRU MODE** is required. If **THRU MODE** is chosen, see "Setting SONET THRU Mode " page 37.
- 2 Make your choice of CLOCK synchronization source. The clock can be internally sourced from the instrument, recovered from the signal at the optical RECEIVE port or externally sourced from the CLOCK REF IN ports (MTS 64 kb/s, BITS 1.5 Mb/s or 10 MHz REF).

Setting the Interfaces

Setting SONET Transmit Interface

- 3 If required choose the FREQUENCY OFFSET value. See “Adding Frequency Offset to SONET Signal” page 62.
- 4 Choose the required **F/G MAPPING** and PAYLOAD TYPE, then **B/G MAPPING** and BACKGROUND selection. The FOREGROUND selection is the channel that is chosen for test purposes. The BACKGROUND patterns are not used for test purposes and are either the same as the test channel or set to UNEQUIPPED.

Mapping may be selected from a pictorial display by moving the cursor to MAPPING and pressing **SET**.

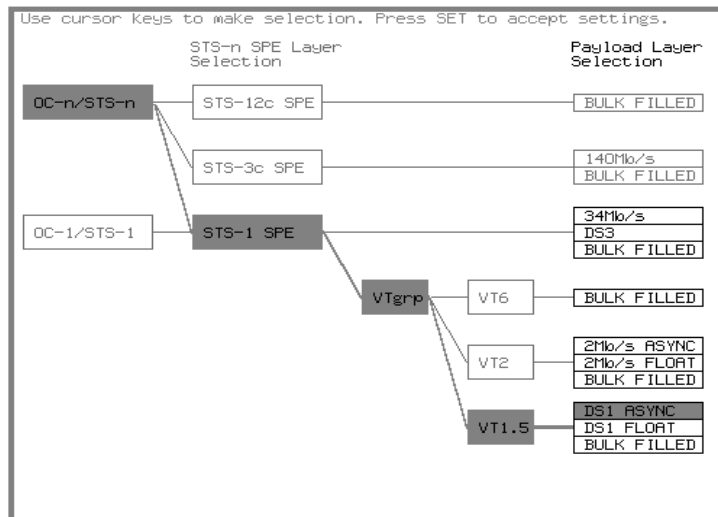

Use **→** and **←** to move between STS Layer choice, VT Layer choice and Payload Layer choice. Use **↑** and **↓** to choose the mapping.

Use **SET** to confirm your choice and return to the **SONET MAIN SETTINGS** display.

- 5 If VT-6 mapping is chosen, VT CONCATENATION selection is enabled, choose **OFF** or the tributary at which the concatenation begins, VT6-2C through VT6-6C.
The BACKGROUND, PATTERN IN OTHER VT-6s is fixed at NUMBERED, that is, each VT-6 contains a unique number to allow identification in case of routing problems.
- 6 If required, choose DS1/2M/34M/DS3 OFFSET value. See “Adding Frequency Offset to SONET Signal” page 62

Setting the Interfaces

Setting SONET Transmit Interface

- 7 If FULL SPE, VT-6, VT-2 or VT-1.5 mapping is chosen, choose the test tributary, including the STS-3 for an OC-12/OC-48 signal.
- 8 Choose the payload framing under PAYLOAD TYPE or VT PAYLOAD.
If **STRUCTURED** is required **FRAMED** must be chosen.
If **STRUCTURED** is chosen, the Payload test signal must be set up. See “Setting Transmit Structured Payload/Test Signal” page 68.
If **INSERT** is chosen, see “Inserting an External DS_n Payload/Test Signal” page 74.
If you have chosen 2 Mb/s, DS1 or DS3 under Mapping, the Framed choice is expanded to provide a menu of framing types.
- 9 Choose the PATTERN type and PRBS polarity.

TRANSMITTER OUTPUT		SONET		
MAIN SETTINGS	STRUCT'D PAYLOAD	JITTER	TEST FUNCTION	OVERHEAD SETUP
SIGNAL	OC-48	1310nm	INTERNAL	
CLOCK	EXTERNAL		MTS 2M CLK	
FREQUENCY OFFSET	OFF			
BACKGROUND				
BACKGROUND STS-1's			UNEQUIPPED	
PATTERN IN OTHER VT-1.5s			2 ¹⁵ -1 PRBS	

STATUS:

MULTIPLE WINDOW

- 10 Choose the mapping required in the background (non-test) STS's. Refer to Appendix A for a table of background patterns for STS-1 SPE.
- 11 If VT mapping is chosen for the test STS, choose the PATTERN IN OTHER VT's.

Setting the Interfaces

Setting Jitter Transmit Interface

Setting Jitter Transmit Interface

Description:
Option 200 required for jitter and option 012 for PDH/DSn.

You can add jitter to the transmitted DSn or SONET signal at DS1, DS3, 2 Mb/s, 34 Mb/s, STS-3, OC-3, OC-12, and OC-48. You can source the jitter modulation internally or from an external source. Jitter measurement up to 2.5 Gb/s is available when ATM or POS is selected as a payload.

TRANSMITTER OUTPUT		SONET	
MAIN SETTINGS	STRUCT'D PAYLOAD	JITTER	TEST FUNCTION OVERHEAD SETUP
JITTER / WANDER	JITTER	ON	
JITTER	SIGNAL FREQUENCY	622Mb/s	
MODULATION SOURCE	JITTER CONTROL	INTERNAL	
		OFF	
RANGE		20.0 UI	
MODULATION FREQUENCY		2 Hz	
AMPLITUDE		1.00 UI	

STATUS:



HOW TO:

- 1 If you are adding jitter to the DSn signal, set up the DSn transmit interface. See Chapter "Setting PDH/DSn Transmit Interface (Option 012)".
- 2 If you are adding jitter to the SONET signal, set up the SONET transmit interface. See "Setting SONET Transmit Interface" page 29.
- 3 Choose JITTER/WANDER **JITTER**.
If you wish to add wander to the DSn or SONET signal, See "Setting Wander Transmit Interface" page 35.
- 4 Choose JITTER **ON**.
If you wish to perform a Jitter Tolerance measurement, choose **AUTO TOLERANCE**. See "Measuring Jitter Tolerance" page 134.
If you wish to perform a Jitter Transfer measurement choose **TRANSFER FUNCTION**. See "Measuring Jitter Transfer" page 138.

Setting the Interfaces

Setting Jitter Transmit Interface

Choose the modulation source.

If adding jitter to the DS_n signal and **EXTERNAL** is chosen, connect the external source to the MOD IN port of the DS_n Jitter TX module. Up to 10 UI of external jitter modulation can be added at the MOD IN port.

If adding jitter to the SONET signal and **EXTERNAL** is chosen, connect the external source to the MOD IN port of the SONET Clock module. Up to 20 UI of external jitter modulation can be added at the MOD IN port.

- 5 If you have selected an **INTERNAL** Modulation Source, choose the JITTER CONTROL setting required.

You can choose the jitter range, jitter modulating frequency and jitter amplitude if **OFF** is chosen.

If you choose **SWEPT**, the OmniBER 718 will "sweep" through the ITU-T jitter mask (G.823 for PDH, GR-499 or G.824 for DS_n, G.958, G.825 or GR-253 for SONET) adjusting the jitter amplitude according to the jitter frequency. With the **SWEPT** field selected, press SET on the instrument front panel for a display of the jitter mask sweep (an example is given below).

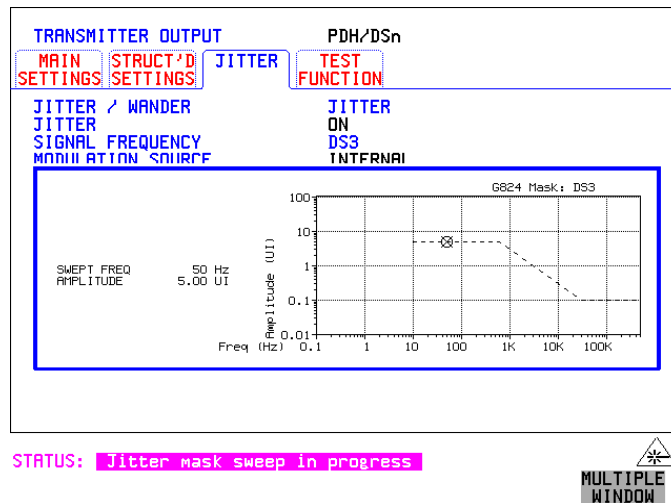

If you choose **SPOT**, you can choose the "spot" jitter frequency. The jitter amplitude is adjusted and controlled according to your jitter frequency choice.

TIP:

If, when using the SWEPT MASK capability, a problem occurs around a certain frequency, this may require closer examination. Stop the sweep at that point by choosing **SPOT**. You can then control the "spot" jitter frequency to make closer examination of the problem.

Setting the Interfaces

Setting Wander Transmit Interface

Setting Wander Transmit Interface

Description:

You can add Wander to the 2 Mb/s DS_n signal and the STS-3, OC-3, OC-12 or OC-48 SONET signal. Wander is also available when you select an ATM or POS payload.

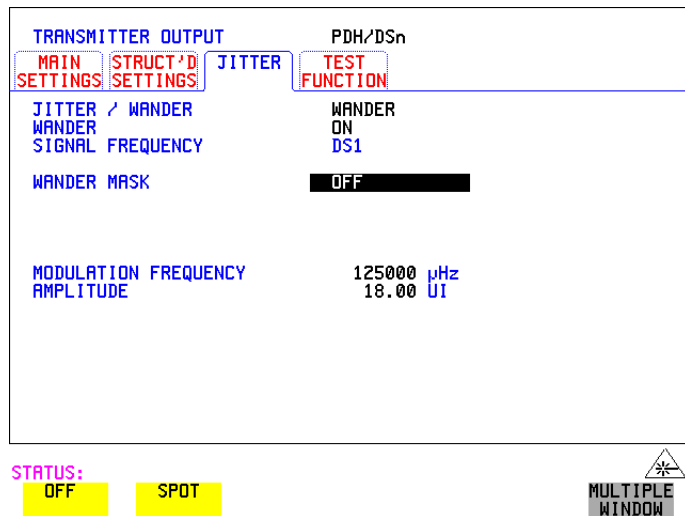

HOW TO:

DS_n Wander (2 Mb/s)

- 1 Set up the PDH transmit interface, choose CLOCK and select the SOURCE required from the menu. If you select EXTERNAL connect the external source to the REF IN port on the CLOCK module. See “Setting PDH/DS_n Transmit Interface (Option 012)” page 26.
- 2 Choose JITTER/WANDER **WANDER**.
If you wish to add jitter to the DS_n signal, See “Setting Jitter Transmit Interface” page 33.
- 3 Choose WANDER **ON**.
- 4 Choose the WANDER MASK setting required.
You can choose the wander modulating frequency and wander amplitude if **OFF** is chosen.
If you choose **SPOT**, you can choose the "spot" wander frequency. The wander amplitude is adjusted and controlled according to your wander frequency choice.

Setting the Interfaces

Setting Wander Transmit Interface

SONET Wander (STS-3, OC-3, OC-12, OC-48)

- 5 Set up the SONET transmit interface. See "Setting SONET Transmit Interface" page 29.
- 6 Choose JITTER/WANDER **WANDER**.
If you wish to add jitter to the SONET signal, see "Setting Jitter Transmit Interface " page 33.
- 7 Choose WANDER **ON**.
- 8 Choose the WANDER MASK setting required.
You can choose the wander modulating frequency and wander amplitude if **OFF** is chosen.
If you choose **SPOT**, you can choose the "spot" wander frequency. The wander amplitude is adjusted and controlled according to your wander frequency choice.

Setting the Interfaces

Setting SONET THRU Mode

Setting SONET THRU Mode

Description

THRU mode is used to non-intrusively monitor SONET lines where no protected monitor points are available. To enable THRU mode select the **TRANSMIT MAIN SETTINGS** page. Select SIGNAL RATE before selecting THRU mode.

The entire frame can be errored at a user defined rate if PAYLOAD OVERWRITE and TOH+POH CHANNEL OVERWRITE are both set to **OFF**. If either overwrite is enabled the ENTIRE FRAME ERROR RATE function is disabled.

There are nominally three modes of operation as follows:

1. Transparent mode: This is the case when the PAYLOAD OVERWRITE field is set to OFF. The received signal is passed through the transmitter completely unchanged. The figure below illustrates the settings for this mode.

TRANSMITTER OUTPUT SONET

MAIN STRUCT'D JITTER TEST OVERHEAD
SETTINGS PAYLOAD FUNCTION SETUP

SIGNAL STS-3 THRU MODE
CLOCK STS-3 RX
PAYLOAD OVERWRITE OFF
TOH+POH CHANNEL OVERWRITE OFF
ENTIRE FRAME ERROR RATE OFF

RX SIGNAL RE-TRANSMITTED UNCHANGED.

STATUS: Loss Of Frame alarm

OFF STS-3C STS-1 UT-6 MORE MULTIPLE WINDOW

2. Hitless THRU Mode:

This mode enables you to change the channel under test and the payload mapping without causing errors in the line signal or any other payload channel, or having to switch out of THRU mode. When you select a Payload Overwrite choice (other than OFF) an additional field is displayed which allows you to enable/disable Payload Overwrite. If Payload Overwrite is disabled the instrument remains transmitting while you select another channel/tributary (see figure on next page). In this mode any Section or Line CV errors are recalculated before transmission.

Setting the Interfaces

Setting SONET THRU Mode

3. Payload Overwrite: In this mode you can overwrite the payload as explained in the following text. Any Path CV errors are recalculated before transmission. Use the *HOW TO* procedure to setup your instrument for THRU Mode operation.

OC-1/STS-1, OC-3/STS-3

You can substitute a new payload, Section and Line Overhead (TOH) and Path overhead (POH) in the received OC-1/STS-1 or OC-3/STS-3 signal for testing.

OC-12, OC-48

The overhead and payload may be overwritten for STS-3c SPE and STS-1. PAYLOAD OVERWRITE is not available for STS-12C or STS-48C. TOH+POH CHANNEL overwrite is available for STS-12C and STS-48C.

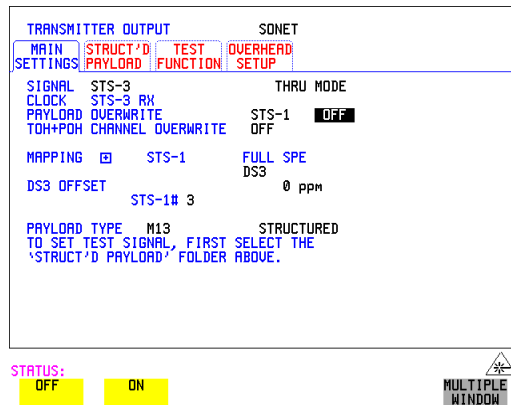

HOW TO:

- 1 Make the required SIGNAL RATE choice, and select THRU MODE on the SONET **TRANSMIT** display, See "Setting SONET Transmit Interface " page 29.
- 2 Make the PAYLOAD OVERWRITE choice required.
Hitless Mode: The Payload Overwrite enable/disable field (next to the PAYLOAD OVERWRITE field) defaults to OFF.

If STS-3c SPE, STS-1 SPE, VT-6, VT-2 or VT-1.5 is chosen, the Section, Line and Path CVs are recalculated before transmission and the Mapping, Selected VT, VT Payload, Pattern, Tributary Offset and Pattern in other VT's settings are displayed. To choose the settings in these, See "Setting SONET Transmit Interface " page 29, steps 4 through 10.

Setting the Interfaces

Setting SONET THRU Mode

- 3 Switch the PAYLOAD OVERWRITE enable/disable field to ON. Test functions are available whilst Payload Overwrite is enabled. Select the **TEST FUNCTION** folder and setup as required.
- 4 Make the TOH+POH CHANNEL OVERWRITE choice required.
The Section, Line and Path CVs are recalculated before transmission.

Setting the Interfaces

Using Smart Test

Using Smart Test

Smart Setup

The Smart Setup feature simplifies instrument operation by:

- Allowing the instrument to auto-configure on the incoming signal. It will attempt to identify signal structure, and detect mixed payload signal structures and alarms.

The OmniBER 718 automatically displays all of the J1 trace identifiers. Once the received signal has been identified you can select a channel of interest and explore further into the payload.

Smart Tests

Allows you to quickly access the most commonly used instrument features such as:

- Signal quality
- Functional tests
- Jitter tests
- ATM tests
- POS tests
- Settings (stored, logging, Tx/Rx coupling and trigger output enable)

HOW TO:

- 1 Connect the 37718A to the network and choose if necessary the required SONET **RECEIVE** interface on the 37718A (Smartsetup will select PDH or SDH/SONET, but can not select between SDH and SONET).
- 2 Press **SMART TEST**.

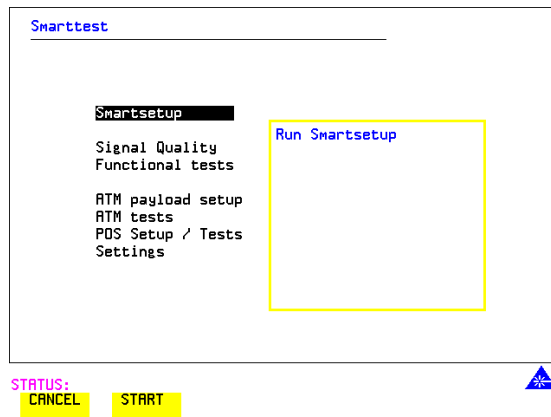

Setting the Interfaces

Using Smart Test

- With Smartsetup highlighted, press **START** to auto-discover information about the receive signal. Or press **CANCEL** to exit Smart Tests.

An example of a typical display after choosing to RUN Smartsetup is shown below.

Note: The channel information displayed is the one obtained the last time a SCAN was performed. If you have changed the input signal since the last Smartsetup you must perform a RESCAN now. If you have selected a PDH/DSn interface and a PDH/DSn signal is received, a channel mapping display indicating the framing and status of each channel is given, see below.

Smartsetup OC-12 (Optical)

STS#	Payload	Path trace
1	STS-1 Uneq	
2	STS-1 Uneq	
3	STS-1 Uneq	
4	STS-1 Uneq	
5	STS-1 Uneq	
6	STS-1 DS3/34M	HEWLETT-PACKARD, 37718 OMNIBER, 0000U0
7	STS-1 Uneq	
8	STS-1 Uneq	
9	STS-1 Uneq	
10	STS-1 Uneq	
11	STS-1 Uneq	
12	STS-1 Uneq	

STATUS: **CANCEL** **EXPLORE FURTHER** **RESCAN**

Smartsetup DS3 signal

DS3

DS2

KEY:

- Unframed
- Framed
- PRBS
- Aligned

Tributary Framing Status

DS3#1	M13	Live/Unknown
-------	-----	--------------

STATUS: **CANCEL** **SET UP RM**

Setting the Interfaces

Using Smart Test

SET UP RX key

If you select an individual channel using the cursor control keys, and then select **SET UP RX**, the instrument exits smartsetup and sets the receiver to the test pattern detected in the selected channel.

To run a Smart Test (Signal Quality - Frequency Measurement):

- 1 Ensure a valid signal is connected to the instrument's Receive port.
- 2 Press **SMART TEST**.
- 3 Use the up and down cursor control keys to select Signal quality.
- 4 Use the left and right cursor control keys to access the tests.
- 5 Use the up and down cursor control keys to select Frequency Measurement.

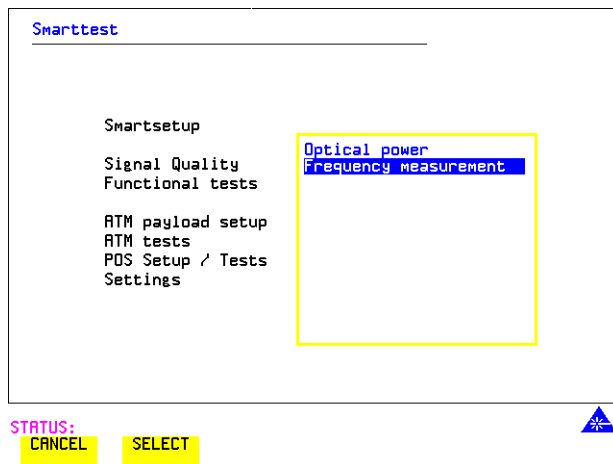

- 6 Press **START** to display the frequency screen. Or press **CANCEL** to exit Smart Tests.

To run an ATM Smart Test

- 1 Ensure a valid signal is connected to one of the instrument's Receive ports.
- 2 Press **SMART TEST**.
- 3 Use the down cursor control key to select ATM payload setup or ATM tests.
- 4 Use the right cursor control key to access the setups/tests.

Setting the Interfaces Using Smart Test

- 5 Use the down cursor control key to select required setup/test.

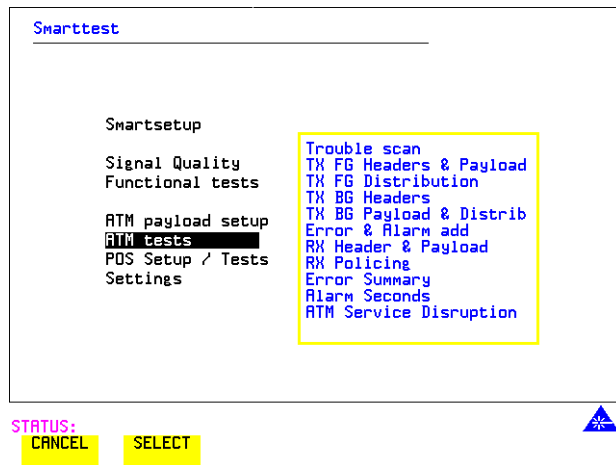
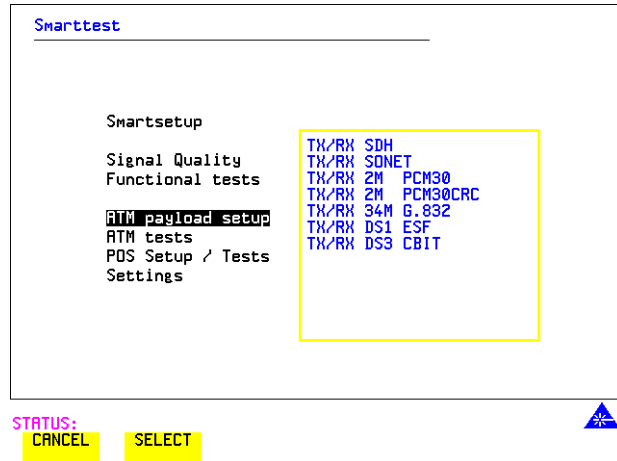

Note: It is not possible for OmniBER to find ATM in a PDH payload in Smartsetup.

Setting the Interfaces

Using Smart Test

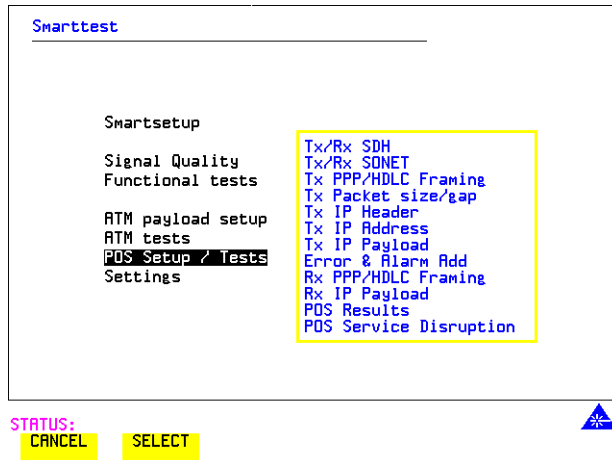

To run a POS Smart Test

- 1 Ensure a valid signal is connected to one of the instrument's Receive ports.
- 2 Press **SMART TEST**.
- 3 Use the down cursor control key to select POS Setup/Tests.
- 4 Use the right cursor control key to access the setups/tests.
- 5 Use the down cursor control key to select required setup/test.
- 6 Press **SELECT** to display the required Setup screen. Or press **CANCEL** to exit Smart Tests.

Setting the Interfaces

Setting PDH/DSn Receive Interface

Setting PDH/DSn Receive Interface

Description

DSn Receive interface settings should match the network equipment settings of Rate, Termination and Line Code and determine the Payload to be tested.

TIP:

To set the transmitter and receiver to the same interface settings choose **OTHER SETTINGS CONTROL COUPLED**.

RECEIVER INPUT		PDH/DSn	
MAIN SETTINGS	STRUCT'D SETTINGS	JITTER	TEST FUNCTION
SIGNAL		DS3	
TERMINATION		75Ω UNBAL	
LINE CODE		B3ZS	
LEVEL		TERMINATE	
PAYLOAD TYPE		UNFRAMED	UNSTRUCTURED
PATTERN		2 ²³ -1 PRBS	
PRBS POLARITY		INU	

STATUS:
PDH/DSn SDH SONET

MULTIPLE WINDOW

HOW TO:

- 1 Choose the required SIGNAL rate.
- 2 If you have chosen 2 Mb/s as the SIGNAL rate, choose the required TERMINATION. (At all other rates the impedance is fixed.)
- 3 If you have chosen 8 Mb/s, 2 Mb/s or DS1 as the SIGNAL rate, choose the required LINE CODE. (At 140 Mb/s, 34Mb/s and DS3 coding is fixed.)
- 4 If you are measuring at the network equipment monitor point, set the LEVEL field to **MONITOR**. In this case the received signal will be 20 to 30 dB below the normal level.
Choose the GAIN required to return the received signal to normal.
Choose EQUALIZATION **ON** to compensate for cable losses if required.
- 5 Choose the PAYLOAD TYPE.

Setting the Interfaces

Setting PDH/DSn Receive Interface

If **STRUCTURED** is required **FRAMED** must be chosen.

If **STRUCTURED** is chosen, the PDH/DSn test signal must be set up. See “Setting Transmit Structured Payload/Test Signal” page 68.

If you chose 2 Mb/s, DS1 or DS3 as the PDH/DSn SIGNAL rate, the FRAMED choice is expanded to provide a menu of framing types.

- 6 Choose the PATTERN type and the PRBS POLARITY required.

Additional Patterns at DS1

- 7 If you select a DS1 SIGNAL, two 8-bit patterns and a 55 Octet pattern are added to the list of available patterns. They are as follows:

Table 2 **8-Bit Patterns**

Type	Pattern
1-in-8	F01000000
2-in-8	F01100000

Note 1: F indicates the position of the framing bit with respect to the 8-bit pattern when the framed data is generated

Note 2: Both 8-bit patterns and the 55 Octet pattern can only be selected as a payload for the whole DS1, i.e. they can not be selected as a pattern for an individual 64 kb/s channel.

The 55 Octet pattern uses Daly pattern as per ANSI T1.403.

Setting the Interfaces

Setting SONET Receive Interface

Setting SONET Receive Interface

Description

SONET Receive interface settings should match the network equipment settings of Rate and Mapping, and determine the payload to be tested.

TIP:

If you wish to set the OmniBER 718 transmitter and receiver to the same interface settings, choose **OTHER** **SETTINGS CONTROL** **COUPLED**. This causes the receiver to be configured to the same settings as the transmitter.

RECEIVER INPUT SONET

MAIN SETTINGS STRUCT'D PAYLOAD TEST FUNCTION OVERHEAD MONITOR

SIGNAL LEVEL STS-3 TERMINATE

MAPPING STS-1 UT1.5 ASYNC DS1

 STS-1# 1 UTGRP# 1 UT# 1

UT PAYLOAD PATTERN ESF UNSTRUCTURED

 QRSS

STATUS: PDH/DSn SDH SONET MULTIPLE WINDOW

HOW TO:

- 1 Choose the required SIGNAL source either electrical or optical. If STS-1 or STS-3 is chosen, choose the required LEVEL. If the LEVEL chosen is **MONITOR** choose the required GAIN.
- 2 Choose mapping and type of payload.
- 3 If VT-6 mapping is chosen, and CONCATENATION is enabled, choose the tributary at which the concatenation begins. If VT-6, VT-2 or VT-1.5 mapping is chosen, choose the test tributary, including the STS-3 for an OC-12/OC-48 signal.
- 4 Choose the payload framing under PAYLOAD TYPE or VT PAYLOAD. If **STRUCTURED** is required **FRAMED** must be chosen. If **STRUCTURED** is chosen the Payload test signal must be set up. See “Setting Receive Structured Payload/Test Signal” page 70. If DROP is chosen, see “Dropping an External Payload/Test Signal” page 77.
- 5 Choose the PATTERN type and PRBS polarity.

Setting the Interfaces

Setting Jitter Receive Interface

Setting Jitter Receive Interface

Description:
Option 200 required for Jitter operation.

Jitter and error measurements are made simultaneously when a jitter option is fitted. Jitter measurement up to 2.5 Gb/s is also available when ATM or POS is selected as a payload. The jitter receive interface is selected with **RECEIVE PDH/DSn JITTER** or **RECEIVE SONET JITTER** MEASUREMENT TYPE **JITTER**.

The choices made on the jitter receive interface determine the jitter measurement range, the threshold level for determining a jitter hit and which filters are used in the jitter measurement.

RECEIVER INPUT		PDH/DSn
MAIN SETTINGS	STRUCT'D SETTINGS	JITTER
		TEST FUNCTION
MEASUREMENT TYPE	JITTER	
SIGNAL FREQUENCY	DS3	
RECEIVER RANGE	16 UI	
HIT THRESHOLD	1.0 UI	
FILTER	HP1	
FILTER VERSION	0.172/GR-499	
FILTER VALUES	10 Hz HP1	

STATUS:



HOW TO:

- 1 Choose the RECEIVER RANGE - the jitter measurement range.
- 2 Choose the HIT THRESHOLD level - if the received jitter exceeds the value chosen a jitter hit is recorded.
- 3 Choose the FILTER you wish to include in the peak to peak and RMS jitter measurement. The choices are:
OFF, LP, HP1, HP2, 12kHz HP, LP+HP1, LP+HP2, LP+12kHz HP
- 4 If you have selected a PDH/DSn Receive Interface you can also select FILTER VERSION, O.171 or O.172/GR-499. The selection is not available with a SONET Receive Interface.

Setting the Interfaces

Setting Extended Jitter Receive Interface

Setting Extended Jitter Receive Interface

Description:

Extended Jitter measurements are made in a jitter bandwidth of 0.1 Hz to 25 kHz. These measurements are made at the upper end of the standard wander frequency range and the lower end of the standard jitter frequency range. The extended jitter receive interface is selected with **RECEIVE PDH/DSn JITTER** or **RECEIVE SONET JITTER** MEASUREMENT TYPE **EXTENDED**.

The choices made on the jitter receive interface determine the threshold level for determining a jitter hit. The measurement Range and the Filters are not selectable.

RECEIVER INPUT		SONET		
MAIN SETTINGS	STRUCT'D PAYLOAD	JITTER	TEST FUNCTION	OVERHEAD MONITOR
MEASUREMENT TYPE	EXTENDED			
SIGNAL FREQUENCY	622Mb/s OPT			
RECEIVER RANGE	256 UI			
JITTER BANDWIDTH	0.1 Hz - 25 kHz			
HIT THRESHOLD	5 UI			
FILTER	FIXED			

STATUS:



HOW TO:

- 1 Choose MEASUREMENT TYPE **EXTENDED**.
- 2 Choose the HIT THRESHOLD level - if the received jitter exceeds the value chosen a jitter hit is recorded.

Setting the Interfaces

Setting Wander Receive Interface

Setting Wander Receive Interface

Description:

You can measure Wander at all DS_n and SONET rates. An external timing reference should be selected on the **TRANSMIT** **PDH/DS_n** or **SONET** **MAIN SETTINGS** display to ensure accurate Wander results.

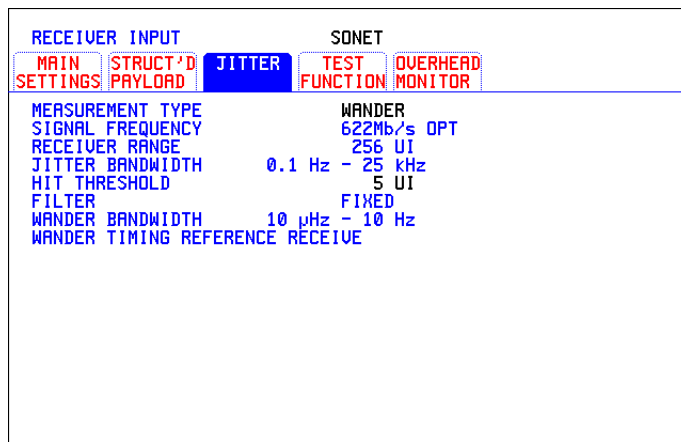

STATUS:



HOW TO:

- 1 Choose an external timing reference on the **TRANSMIT** **SONET** **MAIN SETTINGS** display. See, "Setting SONET Transmit Interface" page 29.
- 2 If you intend to measure wander on a DS_n signal, set up the DS_n receive interface. See, "Setting PDH/DS_n Receive Interface" page 45.
- 3 If you intend to measure wander on a SONET signal, set up the SONET receive interface. See, "Setting SONET Receive Interface" page 47.
- 4 Choose MEASUREMENT TYPE **WANDER**.
- 5 Choose the wander HIT THRESHOLD - if the received wander exceeds the value chosen a wander hit is recorded.

“Using Transmit Overhead Setup”	page 52
“Using Receive Overhead Monitor”	page 54
“Setting Overhead Trace Messages”	page 56
“Setting Overhead Labels”	page 57
“Generating Overhead Sequences”	page 58
“Using Receive Overhead Capture”	page 60
“Adding Frequency Offset to SONET Signal”	page 62
“Adding Frequency Offset to the DS _n Signal”	page 64
“Setting up Signaling Bits”	page 65
“Setting Transmit Structured Payload/Test Signal”	page 68
“Setting Receive Structured Payload/Test Signal”	page 70
“Setting Transmit N x 64 kb/s/N x 56 kb/s Structured Payload/Test Signal”	page 71
“Setting Receive N x 64 kb/s/N x 56 kb/s Structured Payload/Test Signal”	page 73
“Inserting an External DS _n Payload/Test Signal”	page 74
“Dropping an External Payload/Test Signal”	page 77
“Adding Errors and Alarms at the SONET Interface”	page 80
“Adding Errors and Alarms to a DS _n Signal”	page 81
“Using FEAC Codes”	page 82
“Setting DS _n Spare Bits”	page 84
“Adding Pointer Adjustments”	page 85
“Using Pointer Graph Test Function”	page 93
“Stressing Optical Clock Recovery Circuits”	page 95
“Generating Automatic Protection Switch (APS) Messages”	page 97
“Inserting and Dropping the Data Communications Channel”	page 102
“Using DS1 LOOP Codes”	page 103

Selecting Test Features

Selecting Test Features

Using Transmit Overhead Setup

Description

You can set an overhead byte to a known static state to aid troubleshooting, for example to quickly check for "stuck bits" in path overhead bytes. Transport Overhead, Path Overhead, Trace Messages and Labels can be set using this feature.

```
TRANSMITTER OUTPUT          SONET
MAIN STRUCT'D TEST OVERHEAD
SETTINGS PAYLOAD FUNCTION SETUP
SETUP TOH STS-3# 1 STS-1# 1
H1/H2 DECIMAL POINTER VALUE : 0
S1 SYNC BYTE : STRATUM3 TRACEABLE
A1 11110110 A2 00101000 J0 FIXED
B1 xxxxxxxx E1 00000000 F1 00000000
D1 00000000 D2 00000000 D3 00000000
H1 xxxx00xx H2 xxxxxxxx H3 xxxxxxxx
B2 xxxxxxxx K1 00000000 K2 00000000
D4 00000000 D5 00000000 D6 00000000
D7 00000000 D8 00000000 D9 00000000
D10 00000000 D11 00000000 D12 00000000
S1 00001010 Z2 00000000 E2 00000000
```

STATUS:



MULTIPLE
WINDOW

HOW TO:

- 1 Set up the SONET transmit interface and payload required. See "Setting SONET Transmit Interface " page 29.
- 2 Choose the type of overhead to **SETUP**.
If OC-12 or OC-48 is chosen as the SONET interface, choose the STS-3# and STS-1# you wish to set up.
If STS-3 is chosen as the SONET interface, choose the STS-1# you wish to set up.
DEFAULT - Use to set all overhead bytes to the standard values defined by Bellcore/ANSI.
If a test function is active then the overhead byte value is determined by the choices made in the Test Function.
If **TOH** (Transport Overhead) is chosen, choose the STS-1 to be displayed.
Many bytes in **STARS-1# 2** and **STARS-1#3** are unlabeled as the other overhead functions have not yet been defined.

Selecting Test Features

Using Transmit Overhead Setup

If **STS-1# 1,2,3** is chosen, the hexadecimal value of all 81 bytes of the STS-3 section & line overhead selected are displayed (all 324 bytes of an OC-12 or 1,296 bytes of an OC-48 are displayed 81 bytes at a time by selecting each STS-3 in turn). The value of the bytes can be set using **DECREASE DIGIT** **INCREASE DIGIT**  .

If BYTE NAMES is chosen, the labels for the **STS-1# 1,2,3** overhead bytes are displayed.

- 3 If POH (Path Overhead) is chosen, choose the TYPE of overhead within STS-1 under test to be setup.
J1 and J2 bytes can be set under Path Overhead or Trace Messages. H4 byte has a choice of sequences for VT-2, VT-1.5 and VT-6 mapping:
Full Sequence - 48 byte binary sequence.
Reduced Sequence - Binary count sequence of 0 to 3 i.e. 111111(00 to 11).
COC1 Sequence - Binary count sequence of 0 to 3 i.e. 110000(00 to 11).
H4 byte is transmitted as all zero's for 34 Mb/s and DS3.
- 4 If TRACE MESSAGES is chosen, see "Setting Overhead Trace Messages " page 56.

NOTE

Any bit of an overhead byte which is displayed as x or s cannot be set at any time. All other bits can be set to 0 or 1.

TIP:

You can set all overhead bytes to the default state by selecting SETUP **DEFAULT**.

You can set all overhead bytes and test functions to the default state by recalling Stored Settings [0] on the **OTHER** display.

Selecting Test Features

Using Receive Overhead Monitor

Using Receive Overhead Monitor

Description

When first connecting to a SONET network, a start up confidence check can be made by viewing the behavior of all the overhead bytes. If the SONET network shows alarm indications, some diagnosis of the problem may be gained from viewing all the overhead bytes. The OVERHEAD MONITOR display is updated once per second (once per 8000 frames) approximately.

TIP:

A snapshot of the received overhead can be logged to the chosen logging device. See "Logging on Demand " page 241.

```
RECEIVER INPUT          SONET
MAIN  STRUCT'D  TEST  OVERHEAD
SETTINGS PAYLOAD FUNCTION MONITOR
MONITOR TOH STS-3# 1 STS-1# 1
S1 SYNC STATUS : STRATUM3 TRACEABLE

A1 11110110 A2 00101000 J0 00000001
B1 10111001 E1 00000000 F1 00000000
D1 00000000 D2 00000000 D3 00000000
H1 01100000 H2 00000000 H3 00000000
B2 10100101 K1 00000000 K2 00000000
D4 00000000 D5 00000000 D6 00000000
D7 00000000 D8 00000000 D9 00000000
D10 00000000 D11 00000000 D12 00000000
S1 00001010 Z2 00000000 E2 00000000

STATUS:
TOH POH TRACE LABELS APS MULTIPLE
      MESSAGES MESSAGES WINDOW
```

HOW TO:

- 1 Set up the receive SONET interface and payload as required. See "Setting SONET Receive Interface" page 47.
- 2 Choose the type of overhead to MONITOR.
- 3 If **TOH** (Transport Overhead) is chosen, choose the STS-3 # and STS-1# to be displayed.
Many bytes in **STS-1# 2** and **STS-1#3** are unlabeled because the other overhead functions have not yet been defined.
If **STS-1# 1,2,3** is chosen, the hexadecimal value of all 81 bytes of section overhead is displayed (all 324 bytes of an OC-12 or 1,296 bytes of an OC-48 are displayed 81 bytes at a time by selecting each STS-3 in turn).
If BYTE NAMES is chosen, the labels for the **STS-1# 1,2,3** overhead bytes are displayed.

Selecting Test Features

Using Receive Overhead Monitor

- 4 If POH (Path Overhead) is chosen, choose the source of the overhead, SPE or VTSPE.
J1 and J2 bytes can be monitored under Path Overhead or Trace Messages
- 5 If TRACE MESSAGES is chosen, you can monitor a data message to verify portions of the network.
If the 16 byte CRC7 message structure is detected, the 15 characters within the message are displayed.
If the CRC7 structure is not detected in J1, the 64 byte message format is assumed and displayed.
If the CRC7 structure is not detected for J0 or J2, all 16 bytes are displayed.
- 6 If LABELS is chosen, the S1 sync status, STS path label (C2) and the VT Path label (V5) are monitored.
- 7 If APS MESSAGES is chosen, choose the TOPOLOGY, **LINEAR** (GR-253) or **RING** (GR-1230). The K1 and K2 bytes are monitored.

TIP:

If any abnormal behavior is observed on a particular path or section overhead byte, or an associated group of bytes (3XA1,3XA2; D1 - D3, D4 - D12), the **RECEIVE TEST FUNCTION** display of **OVERHEAD CAPTURE** can be used to "Zoom" in on the suspect byte or bytes on a frame by frame basis. See "Using Receive Overhead Capture " page 60.

Selecting Test Features

Setting Overhead Trace Messages

Setting Overhead Trace Messages

Description

You can insert a data message to verify portions of the network:

J0 verifies the section overhead.

J1 verifies the STS-1 SPE or STS-3c SPE path connection.

J2 verifies the VT SPE path connection.

TRANSMITTER OUTPUT		SONET	
MAIN SETTINGS	STRUCT'D PAYLOAD	TEST FUNCTION	OVERHEAD SETUP
SETUP	TRACE		
WITHIN ALL STS-3's ALL STS-1's			
J0	FIXED	→	00000001
J1	TEST 64 (SPE)	→	"HP37718A COMMUNICATIONS PERFORMANCE ANALYZER, GB00000109 0x"
J2	TEST (UT-SPE)	→	"HP:- GB00000109"



STATUS: MULTIPLE WINDOW

HOW TO:

- 1 Choose the message for insertion in the chosen trace channel.

How to Edit User Messages

There are two ways you can edit a user message as follows;

- Use the edit keys at the bottom of the display JUMP, PREVIOUS CHAR, NEXT CHAR  and  that are displayed when you position the cursor on a User message or:
- Use the POP UP alphanumerical keypad that is displayed when you press the front panel **SET** key. Detailed instructions on how to change instrument settings using the POP UP keypad is given in the Quick Start Guide (page 13) under the heading "Changing Instrument Settings".

Selecting Test Features

Setting Overhead Labels

Setting Overhead Labels

Description

Choosing LABELS in TRACE MESSAGES allows the setting of the S1 SYNC STATUS, STS PATH LABEL (C2) and VT PATH LABEL (V5).

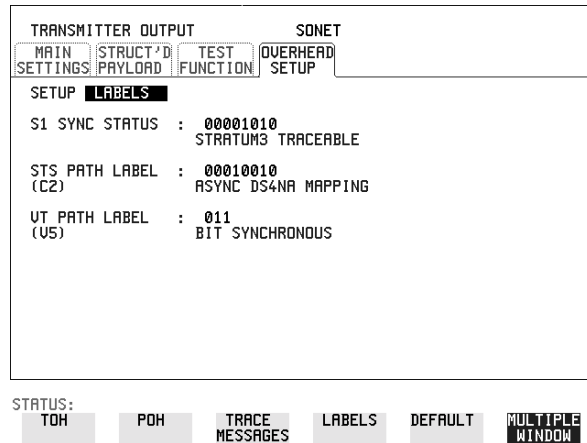

How to Edit User Defined Labels

- 1 Choose the overhead label that you want to edit.
- 2 Edit the label using the softkeys at the bottom of the display. If you select USER, use the softkeys at the bottom of the display to edit the label key, or press **SET**, then use the softkeys and pop-up keypad to edit the label. Detailed instructions on how to change instrument settings using the pop-up keypad is given in the Quick Start Guide (page 13) under the heading “Changing Instrument Settings”.

Generating Overhead Sequences

Description

You may insert a sequence of patterns into a functional group of overhead bytes for testing or troubleshooting purposes.

TRANSMITTER OUTPUT		SONET	
MAIN	STRUCT'D	TEST	OVERHEAD
SETTINGS	PAYLOAD	FUNCTION	SETUP
TEST FUNCTION	SONET	SEQUENCES	
SINGLE RUN	STOPPED	-SEQUENCE STOPPED	
SOH	3xA1, 3xA2	STS-3# 2	
A	F6F6F6282828		
B	D9B12429252D		
C	162626F42458		
D	B7C8C4FB0856		
E	1929B2F55556		
SEQUENCE	64000	FRAMES OF	A THEN
	91		B
	0		C
	0		D
	0		E

STATUS:

MULTIPLE WINDOW

HOW TO:

- 1 Set up the SONET transmit interface and payload required. See “Setting SONET Transmit Interface” page 29.
- 2 Select **TEST FUNCTION** , SONET, SEQUENCES as shown above.
- 3 Choose the type of sequence required.
 SINGLE RUN - runs the sequence once and then stops.
 REPEAT RUN - runs the sequence repeatedly until STOPPED is chosen.
- 4 Choose the overhead type as required.
 SOH- Section Overhead
 LOH- Line Overhead
 POH - Path Overhead
- 5 Choose the byte or bytes of overhead required.
- 6 Set up the required number of data patterns and the number of frames in which each data pattern should appear.
 Your sequence is derived from up to 5 blocks of hexadecimal data. Each block can be transmitted in up to 64,000 frames.
 The data and the number of frames are set using **DECREASE DIGIT** **INCREASE DIGIT** **←** **→**.

Selecting Test Features

Generating Overhead Sequences

7 Start the sequence by choosing **START**.

NOTE

When you start the sequence illustrated, one Out of Frame alarm and one Loss of Frame alarm should occur every eight seconds.

A1A2 Boundary Function

A1A2 provide a frame alignment pattern (A1=F6 H, A2=28 H). Use A1A2 to test the 6 framing bytes at the A1A2 boundary in the section overhead (see display on previous page). The 6 bytes across the boundary are:

STS-n

STS-3 channel:	#n-2	#n-1	#n	#1	#2	#3
Overhead byte:	A1 #3	A1 #3	A1 #3	A2 #1	A2 #1	A2 #1

A network element, typically only uses three of these bytes (which ones are not defined in the standards, so will vary between manufacturers) to gain and maintain frame synchronization. In many cases the A1A2 bytes selected are those at the A1A2 boundary (i.e. the A1 bytes in the last STS-1 channel and the A2 bytes in the first STS-1 channel). Therefore, the ability to stress test across the boundary is necessary to verify a correct synchronization algorithm within a network element.

Selecting Test Features

Using Receive Overhead Capture

Using Receive Overhead Capture

Description

Section, Line and Path overhead provide network support functions, responding dynamically to network conditions and needs. It is therefore useful to capture overhead activity on a frame by frame basis.

TIP:

The Overhead Capture display can be logged to the chosen logging device. See "Logging on Demand " page 241.

RECEIVER INPUT		SONET	
MAIN SETTINGS	STRUCT'D PAYLOAD	TEST FUNCTION	OVERHEAD MONITOR
TEST FUNCTION	SONET	O/H CAPTURE	
SOH	3xA1,3xA2	STS-3# 2	
TRIGGER	ON NOT	F6F6F6282828	
CAPTURE	STOPPED		
DATA			FRAME COUNT
D9B12429252D			91
F6F6F6282828			64000
D9B12429252D			91
F6F6F6282828			64000
D9B12429252D			91
F6F6F6282828			64000
D9B12429252D			91
F6F6F6282828			64000

STATUS:

MULTIPLE WINDOW

HOW TO:

- 1 Set up the receive SONET interface and payload as required. See "Setting SONET Receive Interface" page 47.
- 2 Select **TEST FUNCTION**, SONET, O/H CAPTURE as shown above.
- 3 Choose the overhead type as required.
SOH- Section Overhead
LOH- Line Overhead
POH- Path Overhead
- 4 Choose the Byte or bytes of overhead to be captured.

Choose the TRIGGER to determine the start point of the capture.

OFF - starts immediately the capture is initiated. Can be used to provide a frame by frame monitor of the chosen byte or bytes.

ON -captures activity after your specified overhead state has occurred. Can be used for transient detection from a specified expected state.

Selecting Test Features

Using Receive Overhead Capture

ON NOT - captures activity after the first occurrence of a deviation from your specified overhead state. Can be used for transient detection from a specified expected state.

- 5 Up to 16 records of overhead state are provided. Each record will represent between 1 and 64,000 frames. A capture is started by pressing CAPTURE **START** and terminates when up to 16 records have been captured. The capture can be terminated earlier by pressing CAPTURE **STOP**.

Selecting Test Features

Adding Frequency Offset to SONET Signal

Adding Frequency Offset to SONET Signal

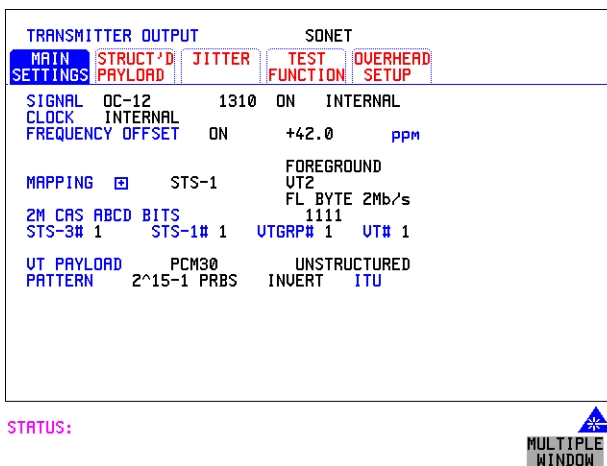

Description

Frequency offset can be added to the SONET interface rate signal and to the payload signal.



HOW TO:



SONET Line Rate Offset

- 1 Choose the amount of frequency offset required.
You can set the Frequency Offset in the range -999 ppm to +999 ppm in 1 ppm steps using **DECREASE DIGIT** **INCREASE DIGIT**  and  or press **SET** for a pop-up numerical keypad.
The amount of applied Frequency Offset can be varied while measurements are taking place.
If the value of the SONET line rate offset chosen is sufficient to cause the maximum stuff rate to be exceeded, the asynchronous payload is offset to prevent bit errors occurring and the maximum stuff rate is maintained. When Floating Byte 2 Mb/s is chosen, in conjunction with SONET line rate offset, the chosen tributary will be offset as the line rate is offset. (No pointer movements).

Selecting Test Features

Adding Frequency Offset to SONET Signal

Tributary Offset ± 100 ppm

- 1 Choose the amount of tributary offset required.
You can set the Offset in the range -100 ppm to +100 ppm in 1 ppm steps using **DECREASE DIGIT** **INCREASE DIGIT**  and  or press **SET** for a pop-up numerical keypad.
The amount of applied Frequency Offset can be varied while measurements are taking place.
Tributary offset affects the stuff rate but does not cause pointer movements and can be used to test mapping jitter. If the combined value of SONET line rate offset and tributary offset chosen is sufficient to cause the maximum stuff rate to be exceeded the payload is offset to prevent bit errors occurring and the maximum stuff rate is maintained.

Adding Frequency Offset to the DS_n Signal

Description

Option 012 required.

You can add frequency offset to the interface DS_n SIGNAL at all rates. Frequency Offset can be added at preset ITU-T/ANSI values or as User defined values in the range ±100 ppm. The preset values change with the SIGNAL rate chosen as shown:

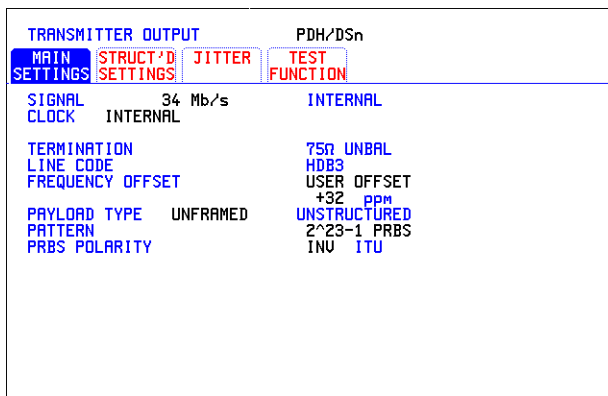

DS-1 (1.544 Mb/s)	±32 ppm	-32 ppm
2 Mb/s (E1)	±50 ppm	-50 ppm
8 Mb/s	±30 ppm	-30 ppm
34 Mb/s (E3)	±20 ppm	-20 ppm
DS-3 (44.736 Mb/s)	±20 ppm	-20 ppm
140 Mb/s	±15 ppm	-15 ppm



STATUS:



HOW TO:

- 1 Choose the FREQUENCY OFFSET required.
- 2 If you choose USER OFFSET, you can set the frequency offset to be between -100 ppm and +100 ppm in 1 ppm steps. Select the field immediately below USER OFFSET and use **DECREASE DIGIT**, **INCREASE DIGIT**,  and  to set the frequency offset. (The amount of frequency offset can be varied while measurements are taking place.)

Selecting Test Features

Setting up Signaling Bits

Setting up Signaling Bits

Description

When transmitting 2.048 Mb/s signals with timeslot-16 CAS (PCM30 or PCM30CRC) multiframing the state of A,B,C,D signaling bits can be set. The signaling bits of all timeslots are set to the user-defined 4-bit value.

When transmitting a DS1 framed, structured signal the values of the A,B signaling bits for D4 and SLC-96 payloads, and A,B,C,D signaling bits for ESF payloads can be defined.

HOW TO

Transmit a DS1 payload signal with user-defined signaling bits

DSn Operation

The screenshot shows the TRANSMITTER OUTPUT display with the following settings:

TRANSMITTER OUTPUT		PDH/DSn
MAIN SETTINGS	STRUCT'D	TEST FUNCTION
TEST SIGNAL	DS2	56 kb/s
DS1 PAYLOAD	1	ESF
		DS1 56kb
		1
PATTERN		2^11-1 PRBS
PRBS POLARITY		NORM
B/G PATTERN		RIS
B/G PATTERN 56 kb/s		NUMBERED
DS1 ESF ABCD BITS		1111

STATUS: D4 ESF SLC-96 MULTIPLE WINDOW

- 1 Choose **PDH/DSn** on the **TRANSMIT** display.
Choose SIGNAL **DS1** or **DS3**, and PAYLOAD TYPE **STRUCTURED** on the **MAIN SETTINGS** display
- 2 Choose TEST SIGNAL **56 kb/s** or **Nx56 kb/s** on the **STRUCTURED SETTINGS** display.
- 3 Set the A,B bits (for D4 and SLC-96) and A,B,C,D bits (for ESF) as required.

SONET Operation

- 1 Choose **SONET** on the **TRANSMIT** display.
- 2 Set MAPPING to VT-1.5.
- 3 Choose MAPPING **FL BYTE DS1**, **ASYNC DS1** or **DS3** and VT PAYLOAD **STRUCTURED** on the **MAIN SETTINGS** display. If you choose

Selecting Test Features

Setting up Signaling Bits

- FL BYTE DS1** proceed to step 5.
- Choose TEST SIGNAL **56 kb/s** or **Nx56 kb/s** on the **STRUCTURED SETTINGS** display .
 - Set the A,B bits (for D4 and SLC-96) and A,B,C,D bits (for ESF) as required.
 - Floating Byte DS1 selection:** Set the ABCD bits for **NO-F-BIT** or **ESF** framing and/or the AB bits for **D4 VT PAYLOAD** framing as required.

HOW TO

Transmit a 2 Mb/s signal with user-defined signaling bits

DSn Operation

TRANSMITTER OUTPUT		PDH/DSn
MAIN SETTINGS	STRUCT'D SETTINGS	TEST FUNCTION
SIGNAL		2 Mb/s
CLOCK SYNC	INTERNAL	
TERMINATION		75Ω UNBAL
LINE CODE		HDB3
FREQUENCY OFFSET		OFF
PAYLOAD TYPE	PCM30CRC	UNSTRUCTURED
PATTERN		2 ¹⁵ -1 PRBS
PRBS POLARITY		INU ITU
2M CAS ABCD BITS		1111

STATUS:
 UNFRAMED
 PCM30
 PCM31
 PCM30CRC
 PCM31CRC
 MULTIPLE WINDOW

- Choose **PDH/DSn** on the **TRANSMIT** display.
- Choose SIGNAL **2 Mb/s** and PAYLOAD TYPE **PCM30** or **PCM30CRC** on the **MAIN SETTINGS** display.
- If UNSTRUCTURED is chosen set the 2M CAS ABCD bits value on the **MAIN SETTINGS** display.
If STRUCTURED is chosen set the 2M CAS ABCD bits value on the **STRUCTURED SETTINGS** display.

Selecting Test Features

Setting up Signaling Bits

SONET Operation

TRANSMITTER OUTPUT		SONET	
MAIN SETTINGS	STRUCT'D PAYLOAD	JITTER	TEST FUNCTION
SIGNAL	DC-12	1310	ON
CLOCK	INTERNAL		INTERNAL
FREQUENCY OFFSET	OFF		
MAPPING	<input checked="" type="checkbox"/> STS-1		BACKGROUND
2M CAS ABCD BITS			UT2
STS-3#	2	STS-1#	3
UT PAYLOAD		UTGRP#	5
PATTERN		UT#	1
			FL BYTE 2Mb/s
			1111
			UNSTRUCTURED
			ITU

STATUS:

PCM30	PCM31	PCM30CRC	PCM31CRC	INSERT 2Mb/s	MULTIPLE WINDOW
-------	-------	----------	----------	--------------	-----------------

- 1 Choose **SONET** on the **TRANSMIT** display.
- 2 Set MAPPING to VT-2.
- 3 Choose MAPPING **ASYNC 2Mb/s** or **FL BYTE 2Mb/s** and VT PAYLOAD **PCM30** or **PCM30CRC** on the **MAIN SETTINGS** display.
- 4 If UNSTRUCTURED is chosen set the 2M CAS ABCD bits value on the **MAIN SETTINGS** display.
If STRUCTURED is chosen set the 2M CAS ABCD bits value on the **STRUCTURED SETTINGS** display.

Setting Transmit Structured Payload/Test Signal

Description

Structured DS_n Payload/Test Signal settings determine the payload or the DS_n test signal to be tested and set any background (non test) conditions to prevent alarms while testing.

TIP:

If you wish to set the OmniBER 718 transmitter and receiver to the same Payload settings, choose **OTHER SETTINGS CONTROL COUPLED**.

Interested in International Gateway Testing?

If your instrument has option 014 fitted you can map an E1 or 2Mb/s signal into DS3 as shown below:

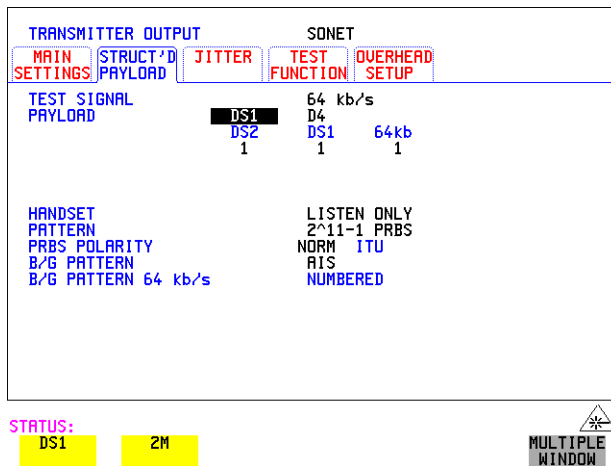

HOW TO:

- 1 Choose the required TEST SIGNAL rate. If Nx64 kb/s or N X 56 kb/s is chosen, see "Setting Transmit N x 64 kb/s/N x 56 kb/s Structured Payload/Test Signal " page 71.
- 2 Choose the PAYLOAD framing pattern.
If TEST SIGNAL 2Mb/s is chosen **INSERT 2 Mb/s** is added to the PAYLOAD menu. See "Inserting an External DS_n Payload/Test Signal " page 74.
If TEST SIGNAL DS1 is chosen **INSERT DS1** is added to the menu. See "Inserting an External DS_n Payload/Test Signal " page 74.
- 3 Choose the test tributary in the structured payload, under 34Mb, 8Mb, 2Mb, 64 kb/s or DS2, DS1, 56 kb/s.

Selecting Test Features

Setting Transmit Structured Payload/Test Signal

- 4 Choose the PATTERN type and PRBS POLARITY.
- 5 Choose the B/G PATTERN. (background)
The B/G PATTERN in the non test 56/64 kb/s timeslots is fixed as NUMBERED, that is, each timeslot contains a unique number to allow identification in case of routing problems.

Signaling

- 6 If a 2 Mb/s PAYLOAD with PCM30 or PCM30CRC framing, or 56 kb/s or Nx56kb/s Test Signal is chosen. See, "Setting up Signaling Bits " page 65.

Selecting Test Features

Setting Receive Structured Payload/Test Signal

Setting Receive Structured Payload/Test Signal

Description

Structured DS_n Payload/Test Signal settings determine the payload or the DS_n test signal to be tested.

TIP:

If you wish to set the OmniBER 718 transmitter and receiver to the same Payload settings, choose **OTHER SETTINGS CONTROL** , **COUPLED** .

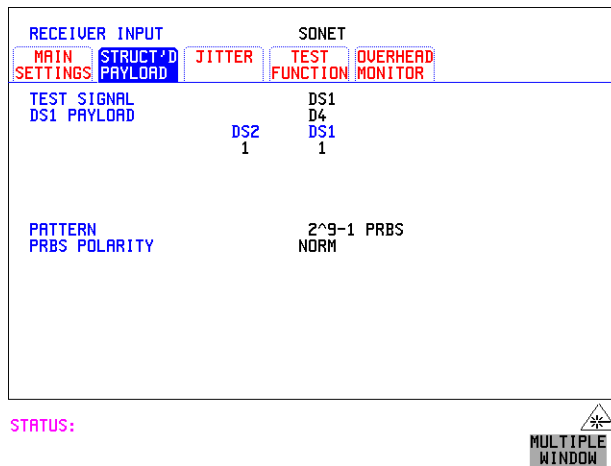

HOW TO:

- 1 Choose the required Test Signal rate. If N x 64 kb/s or N x 56 kb/s is chosen, see "Setting Receive N x 64 kb/s/N x 56 kb/s Structured Payload/Test Signal " page 73.
- 2 Choose the Framing pattern of the PAYLOAD.
If TEST SIGNAL 2 Mb/s is chosen, **DROP 2 Mb/s** is added to the menu. See "Dropping an External Payload/Test Signal " page 77.
If TEST SIGNAL DS1 is chosen, **DROP DS1** is added to the menu.
See "Dropping an External Payload/Test Signal " page 77.
- 3 Choose the test tributary within the structured payload, under 34Mb, 8Mb, 2Mb, 64 kb or DS2, DS1, 56 kb/s.
- 4 Choose the PATTERN type and PRBS polarity.

Setting Transmit N x 64 kb/s/N x 56 kb/s Structured Payload/Test Signal

Description

Wideband services such as high speed data links and LAN interconnection require a bandwidth greater than 56/64 kb/s but less than DS1/2 Mb/s for example 112 kb/s or 336 kb/s. These wide band signals are sent in a DS1/2 Mb/s frame by sharing the signal across multiple timeslots.

N x 64kb/s/N x 56 kb/s structured payload allows a test pattern to be inserted across a number of timeslots even if the chosen timeslots are non-contiguous.

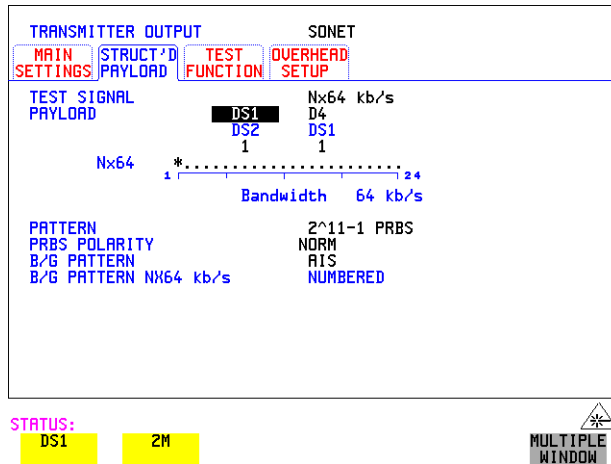

HOW TO:

- 1 Choose the required Test Signal rate.
- 2 If your instrument has option 014 fitted you can map an E1 or 2Mb/s signal into DS3. Select DS1 or 2M as shown in the figure above.
- 3 Choose the Framing pattern of the 2M or DS1 PAYLOAD.
- 4 Choose the test timeslots within the structured payload using **DESELECT ALL**, **DESELECT**, **SELECT**, **←** and **→** softkeys. As each timeslot is selected, an * marks the chosen timeslot.
- 5 Choose the PATTERN type and PRBS polarity.
- 6 Choose the B/G PATTERN.

Selecting Test Features

Setting Transmit N x 64 kb/s/N x 56 kb/s Structured Payload/Test Signal

- 7** The B/G PATTERN in the non-test 56/64 kb/s timeslots is fixed as NUMBERED, that is, each timeslot contains a unique identification number.

Signaling

- 8** If a 2 Mb/s PAYLOAD with PCM30 or PCM30CRC framing, or 56 kb/s or Nx56kb/s Test Signal is chosen. See, "Setting up Signaling Bits " page 65.

Setting Receive N x 64 kb/s/N x 56 kb/s Structured Payload/Test Signal

Description

Wideband services such as high speed data links and LAN interconnection require a bandwidth greater than 56/64 kb/s but less than DS1/2 Mb/s e.g. 112 kb/s or 336 kb/s. These wide band signals are sent in a DS1/2 Mb/s frame by sharing the signal across multiple timeslots.

N x 64kb/s and N x 56 kb/s structured payload/test signal allows the test Timeslots to be chosen for error measurement even when the Timeslots are non contiguous.

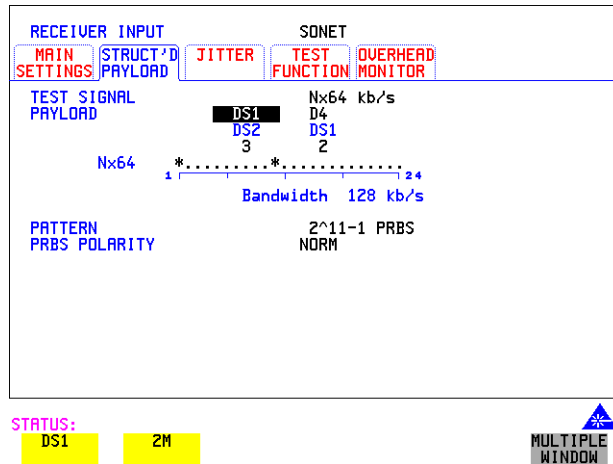

HOW TO:

- 1 Choose the required Test Signal rate.
- 2 If your instrument has option 014 fitted you can map an E1 or 2Mb/s signal into DS3. Select DS1 or 2M as shown in the figure above.
- 3 Choose the Framing pattern of the 2M or DS1 PAYLOAD.
- 4 Choose the test timeslots within the structured payload using **DESELECT ALL** **DESELECT** **SELECT** **←** and **→** softkeys. As each timeslot is chosen an * marks the chosen timeslot. In the example above Timeslots 3, 5, 9, 21, 22, 23 are chosen for test.
- 5 Choose the PATTERN type and PRBS polarity.

Selecting Test Features
Inserting an External DS_n Payload/Test Signal

Inserting an External DS_n Payload/Test Signal

Description

You can insert 2 Mb/s 34 Mb/s or 140 Mb/s into an STS-N line signal when option 012 is fitted. DS3, DS1, E3 and E1 can be inserted when option 014 is fitted.

RATE	Availability	Option
DS3	SDH & SONET	001, 012, 002
34Mb/s	SDH & SONET	001, 012,002
2Mb/s	PDH, SDH & SONET	001, 012, 002
DS1	DS _n , SDH & SONET	001, 012, 002

HOW TO:

Insert 34 Mb/s, 140 Mb/s & DS3

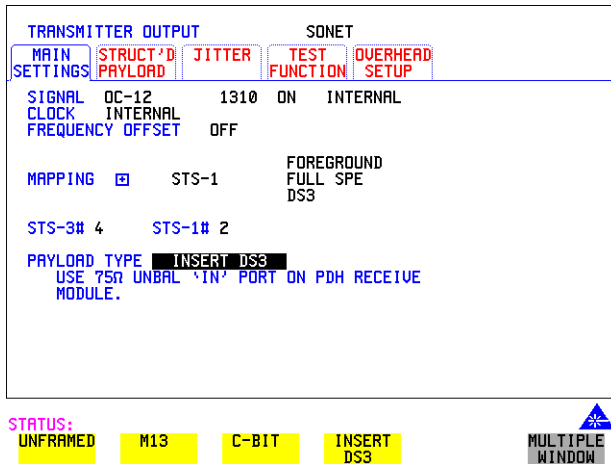

- 1 Press **TRANSMIT**, select **SONET** and the **MAIN SETTINGS** page.
- 2 Set up the required transmit SONET interface, set appropriate MAPPING then choose VT PAYLOAD **INSERT 34 Mb/s**, **INSERT DS3** or **INSERT 140 Mb/s** as required. Connect your external source to the appropriate port as indicated on the instrument display (when you position the cursor on the PAYLOAD TYPE field and select INSERT).

Selecting Test Features

Inserting an External DSn Payload/Test Signal

Insert 2 Mb/s or DS1 (Unstructured SONEt Payload)

TRANSMITTER OUTPUT		SONET					
MAIN SETTINGS	STRUCT'D PAYLOAD	JITTER	TEST FUNCTION	OVERHEAD SETUP			
SIGNAL	DC-12	1310	ON	INTERNAL			
CLOCK	INTERNAL						
FREQUENCY OFFSET	OFF						
MAPPING	<input checked="" type="checkbox"/>	STS-1	BACKGROUND VT1.5 ASYNCS DS1				
STS-3#	2	STS-1#	3	UTGRP#	7	UT#	1
VT PAYLOAD	INSERT DS1						
LINE CODE	AMI						
USE 'MUX' PORT ON PDH TX MODULE.							

STATUS: UNFRAMED D4 ESF SLC-96 INSERT DS1 MULTIPLE WINDOW

- 1 Connect the external payload to the MUX port of the PDH/DSn Transmit module. If 2 Mb/s connect to 75Ω MUX port. If DS1 connect to 100Ω MUX port.
- 2 Set up the required transmit SONET interface, and choose VT-2 or VT-1.5 MAPPING and VT PAYLOAD **INSERT 2 Mb/s** or **INSERT DS1**.

Insert 2 Mb/s or DS1 (Structured SONEt Payload or Structured DSn)

TRANSMITTER OUTPUT		SONET	
MAIN SETTINGS	STRUCT'D PAYLOAD	TEST FUNCTION	OVERHEAD SETUP
TEST SIGNAL			DS1
DS1 PAYLOAD			INSERT DS1
LINE CODE			AMI
		DS2	DS1
		5	1
B/G PATTERN			AS F/G

STATUS: UNFRAMED D4 ESF SLC-96 INSERT DS1 MULTIPLE WINDOW

- 1 Connect the external payload to the MUX port of the DSn Transmit module. If 2 Mb/s connect to 75Ω MUX port. If DS1 connect to 100Ω MUX port.

Selecting Test Features

Inserting an External DSn Payload/Test Signal

Structured SONET Payload

- 2 Set up the required transmit SONET interface. See "Setting SONET Transmit Interface " page 29.
- 3 Set up the SONET structured payload. See "Setting Transmit Structured Payload/Test Signal " page 68.
- 4 Choose 2M PAYLOAD/DS1 PAYLOAD **INSERT 2 Mb/s** or **INSERT DS1** .
- 5 Choose the LINE CODE.

Structured DSn

- 6 Set up, the required transmit DSn interface, See "Setting PDH/DSn Transmit Interface (Option 012) " page 26.
- 7 Set up the DSn Test Signal interface. See "Setting Transmit Structured Payload/Test Signal " page 68
- 8 Choose 2M PAYLOAD/DS1 PAYLOAD **INSERT 2 Mb/s** or **INSERT DS1** .
- 9 Choose the LINE CODE.

Selecting Test Features

Dropping an External Payload/Test Signal

Dropping an External Payload/Test Signal

Description

You can drop 2Mb/s 34 Mb/s or 140 Mb/s from an STS-N line signal when option 012 is fitted. DS3, DS1, E3 and E1 can be dropped when option 014 is fitted

HOW TO:

Drop 34 Mb/s, DS3 and 140 Mb/s

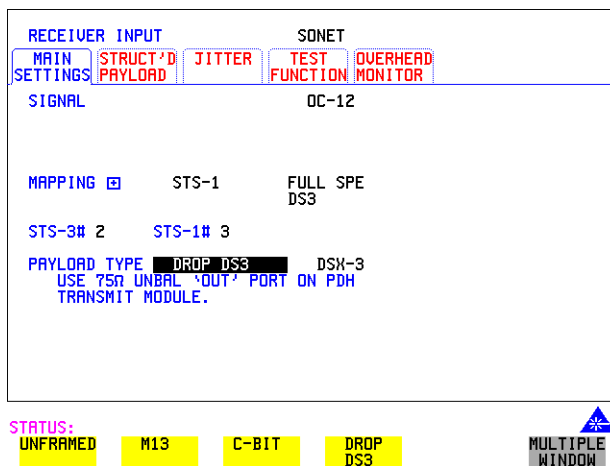

- 1 Connect the 75Ω OUT port of the DS_n Transmit module to the external equipment.
- 2 Set up the receive SONET interface, and choose **PAYLOAD**, **DROP 34 Mb/s**, **DROP DS3**, or **DROP 140 Mb/s** as required.
If **DROP DS3** is chosen, choose the DS3 output level.

Selecting Test Features

Dropping an External Payload/Test Signal

Drop 2 Mb/s /DS1 (Unstructured SONET Payload)

RECEIVER INPUT		SONET		
MAIN SETTINGS	STRUCT'D PAYLOAD	JITTER	TEST FUNCTION	OVERHEAD MONITOR
SIGNAL		OC-12		
MAPPING	STS-1	UT1.5 ASYNC DS1		
STS-3# 2	STS-1# 3	UTGRPH 1	UT# 1	
UT PAYLOAD	DROP DS1			
LINE CODE	B8ZS			
USE 'DEMUX' PORT ON PDH RX MODULE				

STATUS:

UNFRAMED	D4	ESF	SLC-96	DROP DS1	MULTIPLE WINDOW
----------	----	-----	--------	----------	-----------------

- 1 Connect the DEMUX port of the DS_n module to the external equipment.
- 2 Set up the required receive SONET interface, and choose VT-2 or VT-1.5 MAPPING and VT PAYLOAD **DROP 2 Mb/s** or **DROP DS1**.
- 3 Choose the required LINE CODE.

Drop 2 Mb/s/DS1 (Structured SONET Payload or Structured DS_n)

RECEIVER INPUT		SONET		
MAIN SETTINGS	STRUCT'D PAYLOAD	TEST FUNCTION	OVERHEAD MONITOR	
TEST SIGNAL	DS1		DROP DS1	
DS1 PAYLOAD	B8ZS			
LINE CODE	DS2 7	DS1 3		

STATUS:

UNFRAMED	D4	ESF	SLC-96	DROP DS1	MULTIPLE WINDOW
----------	----	-----	--------	----------	-----------------

- 1 Connect the DEMUX port of the Receive DS_n module to the external equipment.
If 2 Mb/s connect to 75Ω DEMUX port. If DS1 connect to 100Ω DEMUX port.

Selecting Test Features

Dropping an External Payload/Test Signal

Structured SONET Payload

- 2 Set up the required receive SONET interface. See "Setting SONET Receive Interface " page 47.
- 3 Set up the SONET structured payload. See "Setting Receive Structured Payload/ Test Signal " page 70.
- 4 Choose 2M PAYLOAD **DROP 2 Mb/s** or DS1 PAYLOAD **DROP DS1** .
- 5 Choose the LINE CODE.

Structured DSn

- 6 Set up, the required receive DSn interface, See "Setting PDH/DSn Receive Interface " page 45.
- 7 Set up the DSn Test Signal interface. See "Setting Receive Structured Payload/ Test Signal " page 70
- 8 Choose 2M PAYLOAD **DROP 2 Mb/s** or DS1 PAYLOAD **DROP DS1** .
- 9 Choose the LINE CODE.

Selecting Test Features

Adding Errors and Alarms at the SONET Interface

Adding Errors and Alarms at the SONET Interface

Description

Errors and alarms can be added to an SONET signal during testing.

TRANSMITTER OUTPUT		SONET	
MAIN SETTINGS	STRUCT'D PAYLOAD	TEST FUNCTION	OVERHEAD SETUP
TEST FUNCTION	SONET	ERR & ALARM	
ERROR ADD TYPE			CU-L (B2)
RATE	7680	ERRORS IN	MSP THRESHLD 1 s
ALARM TYPE			RDI-L

STATUS:

MULTIPLE WINDOW

HOW TO:

- 1 Set up the SONET transmit interface and payload required. See "Setting SONET Transmit Interface " page 29.
- 2 Select **TEST FUNCTION** , SONET, ERR & ALARM as shown above.
- 3 Choose the ERROR ADD TYPE and RATE required.
Errors can be added at preset rates and at USER programmable rate. With the exception of ENTIRE FRAME, A1A2 FRAME and BIT, errors can be added at ERROR ALL rate.
If CV-L errors are chosen errors can be added to trigger an APS THRESHOLD. This takes the form of N errors in T time period. N and T are both selectable.
- 4 Choose the ALARM TYPE
Errors and Alarms can be added at the same time.

Selecting Test Features

Adding Errors and Alarms to a DS_n Signal

Adding Errors and Alarms to a DS_n Signal

Description

Errors and alarms can be added to a DS_n signal during testing.

TRANSMITTER OUTPUT		SONET	
MAIN SETTINGS	STRUCT'D PAYLOAD	TEST FUNCTION	OVERHEAD SETUP
TEST FUNCTION	DS _n PAYLD	ERR & ALARM	
ERROR ADD TYPE		FRM + MFRM	
RATE		USER	
		1.0E-3	
		ON	
ALARM TYPE		DS ₃ RAI/XBIT	

STATUS: Remote / X-bit alarm at DS₃

DS ₃ RAI/ X-BIT	DS ₃ FEAC	MORE	MULTIPLE WINDOW
-------------------------------	-------------------------	---------------	--------------------

HOW TO:

- 1 If SONET interface is chosen, set up the SONET transmit interface and payload required. See “Setting SONET Transmit Interface” page 29.
If DS_n interface is chosen, set up the DS_n interface and payload required. See “Setting PDH/DS_n Transmit Interface (Option 012)” page 26.
- 2 Select **TEST FUNCTION**, DS_n PAYLD, ERR & ALARM as shown above.
- 3 Choose the ERROR ADD TYPE and RATE on the Transmitter **TEST FUNCTION** display.
The RATE can be selected from a fixed value or is user programmable. If you select USER PROGRAM you can select the error rate before enabling the errors. This feature is useful for error threshold testing.
- 4 Choose the ALARM TYPE.
Errors and Alarms can be added at the same time.

Selecting Test Features

Using FEAC Codes

Using FEAC Codes

Description

The third C-Bit in subframe 1 is used as a FEAC channel, where alarm or status information from the far-end terminal can be sent back to the near-end terminal. The channel is also used to initiate DS3 and DS1 line loopbacks at the far-end terminal from the near-end terminal.

The codes are six digits long and are embedded in a 16 bit code word; the format is 0XXXXXX01111111.

There are two types of code, Loopback and Alarm Status.

Loopback provides a choice of two DS1 messages and two DS3 Messages. The DS1 Messages can be sent in ALL DS1 channels or in a SINGLE channel. The message can be repeated up to 15 times.

Alarm Status provides 13 preset codes and a USER programmable code function. These codes can be transmitted continuously or in bursts.

The new code is transmitted by choosing **BURST** or **ON**.

TRANSMITTER OUTPUT		PDH/DSn
MAIN SETTINGS	STRUCT'D SETTINGS	TEST FUNCTION
TEST FUNCTION	DSn	ERR & ALARM
ERROR ADD TYPE		BIT (TEST)
RATE		OFF
ALARM TYPE		DS3 FEAC
FEAC CODE TYPE		LOOPBACK
MESSAGE	ACTIVATE DS1	2
REPEAT (TIMES)	15 LOOP	15 MESS.
TRANSMIT NEW CODE		OFF

STATUS:

OFF
 LOS
 DS3 AIS
 DS3 OOF
 MORE
 MULTIPLE WINDOW

HOW TO:

Transmit an FEAC code

- 1 Choose SIGNAL **DS3** and PAYLOAD TYPE **CBIT** on the **TRANSMIT MAIN SETTINGS** display.
- 2 Choose **TRANSMIT TEST FUNCTION**, DSn PAYLD and ALARM TYPE **DS3 FEAC**. When a FEAC code is not being transmitted, an all ones pattern is transmitted.

Selecting Test Features

Using FEAC Codes

- 3 Choose the FEAC CODE TYPE.
- 4 Choose the MESSAGE from the choices displayed.
If you chose a DS1 message an additional field to the right of the DS1 MESSAGE is displayed. Position the cursor on this field and choose **ALL** or **SINGLE CHANNEL**.
If you choose **SINGLE CHANNEL** use the EDIT keys to select a channel from 1 to 28. Press **END EDIT** when finished.
- 5 If **LOOPBACK** is chosen, choose the REPEAT (TIMES) LOOP and MESS, in the range 1 to 15.
- 6 If **ALARM/ STATUS** is chosen, choose the BURST LENGTH (TIMES).
- 7 Choose TRANSMIT NEW CODE **BURST** or **ON** to transmit the selected FEAC message.

TIP:

To View FEAC Messages

The received FEAC message can be viewed on the **RESULTS** display.

```
RESULTS  DSn          FEAC MESSAGE

CURRENT FEAC MESSAGE
  IDLE (All Ones)
LAST NON-IDLE FEAC MESSAGE
  000000
  DS3 Out of Frame

ELAPSED TIME          00d 00h 00m 03s
```

STATUS:
ERROR SUMMARY CUMUL-ATIVE SHORT TERM ERROR ANALYSIS MORE MULTIPLE WINDOW

Selecting Test Features

Setting DSn Spare Bits

Setting DSn Spare Bits

Description

Certain Spare Bits will cause the occurrence of a minor alarm when received as a logical "0".:

8 Mb/s & 34 Mb/s - FAS Bit 12

2 Mb/s - NFAS Timeslot (timeslot 0 of NFAS frame) Bit 0

TRANSMITTER OUTPUT		SONET	
MAIN SETTINGS	STRUCT'D PAYLOAD	TEST FUNCTION	OVERHEAD SETUP
TEST FUNCTION	DSn PAYLD	SPARE BITS	
2M: Si BIT (T/S-0 BIT 1)		1	
Sa BITS (NFAS T/S BITS 4-8)		11111	
CAS MFM T/S-16 BITS 5,7,8		111	

STATUS:  MULTIPLE WINDOW

HOW TO:

- 1 If SONET interface is chosen, set up the SONET transmit interface and payload required. See "Setting SONET Transmit Interface " page 29.
If DSn interface is chosen, set up the DSn transmit interface and payload required. See "Setting PDH/DSn Transmit Interface (Option 012) " page 26.
- 2 Set the value of the spare bits required for testing.
If a BIT SEQUENCE is required, choose SEND SEQUENCE **ON** to transmit the sequence.

Adding Pointer Adjustments

Introduction

Pointers perform a critical role in the error free transmission of payload data (subscriber data) through a SONET network. They also enable individual payload channels to be inserted or extracted from a high speed OC-n line signal (for example the functionality provided by ADMs).

Pointer adjustments are often necessary to compensate for asynchronous operation between different nodes within an SONET network. These adjustments however can result in jitter being added to a DS_n signal output from a SONET network element.

Jitter caused by Pointer Adjustments

Pointer adjustments are the mechanisms within SONET to compensate for frequency and phase differences between STS-n SPE channels and the outgoing SONET frames. These pointer adjustments are byte wide and since they can occur randomly, they may cause significant amounts of payload signal jitter. It is therefore necessary to control the jitter on payload signals that is due to pointer adjustments.

Pointer adjustment activity within a network can be randomly spaced individual pointer adjustments, pointer bursts or periodic pointer adjustments.

The Bellcore GR-253 and ANSI T1.105 standards defines a set of pointer sequences to be used when evaluating an NE's pointer adjustment jitter performance.

The OmniBER 718 generates a set of test sequences which can be used to simulate network pointer adjustment activity. This allows the amount of tributary jitter due to different types of pointer adjustment to be measured in the OmniBER 718.

Selecting Test Features

Adding Pointer Adjustments

Description

The transmitted SPE or VT pointer value can be adjusted for testing purposes.

TRANSMITTER OUTPUT		SONET	
MAIN SETTINGS	STRUCT'D PAYLOAD	TEST FUNCTION	OVERHEAD SETUP
TEST FUNCTION	SONET	ADJUST PTR	
POINTER TYPE		UT POINTER	
		T1.105 / GR-253	
ADJUSTMENT TYPE		A4	PERIODIC NORMAL
	PATTERN	26-1	
	POLARITY	NEGATIVE	
	INTERVAL	200 ms	
POINTER SEQUENCES		STOPPED	

STATUS:

MULTIPLE WINDOW

HOW TO:

- 1 Set up the SONET transmit interface and payload required. See "Setting SONET Transmit Interface " page 29.
- 2 Choose the POINTER TYPE.
- 3 Choose the ADJUSTMENT TYPE required.

BURST - You determine the size of the burst by the number of PLACES chosen. If, for example, you choose 5 PLACES the pointer value will be stepped 5 times in unit steps e.g. 0 (start value), 1, 2, 3, 4, 5 (final value). The interval between steps is as follows:

For STS-SPE the minimum spacing between adjustments is 4 frames (500 us).
 For VT, the minimum spacing between adjustments is 4 multiframe (2ms).
 Choose ADJUST POINTER [ON] to add the chosen burst.

NEW POINTER - You can choose any pointer value in the defined range (0 to 782 For an STS-1 pointer) with or without a New Data Flag, and transmit it. The current pointer value is displayed for information purposes. Choose ADJUST POINTER [ON] to transmit the new pointer value.

OFFSET - You can frequency offset the line rate or the SPE/VT rate, relative to each other, thus producing pointer movements. If you offset the SPE pointer, an 87:3 sequence of pointer movements is generated. The available configurations are listed in the following table.

If you are currently adding Frequency Offset to the SONET interface or payload, pointer OFFSET is not available.

Selecting Test Features
Adding Pointer Adjustments

Pointer Type	Line Rate	SPE Rate	VT Rate
SPE	Constant	Offset	Tracks STS Payload
SPE	Offset	Constant	Constant
VT	Constant	Constant	Offset
VT	Offset	Tracks Line Rate	Constant

T1.105/GR-253 - Provides pointer movements according to T1.105 and GR-253:

- 4 Choose the T1.105/GR-253 ADJUSTMENT TYPE.
- 5 Choose the POLARITY, INTERVAL and PATTERN (where applicable) for the selected sequence.
- 6 Choose POINTER SEQUENCES | **START INIT** to generate the selected sequence and **STOP INIT** to stop the pointer sequences.

T1.105/GR-253 Pointer Sequences Explained

In addition to the BURST, NEW POINTER and OFFSET pointer movements described, the OmniBER 718 can also generate pointer sequences (pointer movements) according to T1.105.03 and GR-253.

Before running a pointer sequence you can elect to run an initialization sequence, followed by a cool down period, and then run the chosen sequence. This is selected using the START INIT softkey shown in the display on the previous page. Initialized pointer sequences are made up of three periods: the *Initialization Period*, the *Cool Down Period*, and the *Sequence (Measurement) Period*, an example is given in the following figure:

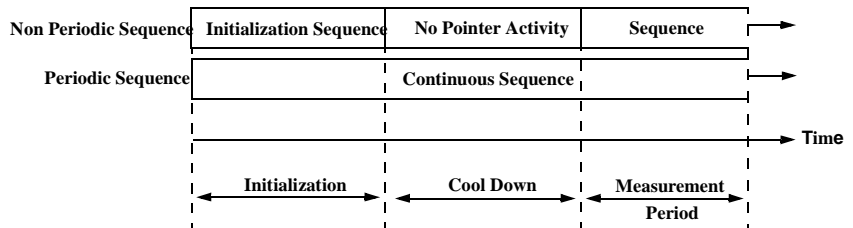

Note: SINGLE (A1), BURST (A2) and PHASE TRANSIENT(A3) are Non Periodic Sequences.

Selecting Test Features

Adding Pointer Adjustments

Initialization Period

For SINGLE A1, BURST A2 and PHASE TRANSIENT A3 sequences the initialization sequence consists of 60 seconds of pointer adjustments applied at a rate of 2 adjustments per second and in the same direction as the specified pointer sequence.

Cool Down Period

A period following the initialization period which for SINGLE e), BURST f) and PHASE TRANSIENT sequences is 30 seconds long when no pointer activity is present.

Sequence (Measurement) Period

The period following the Cool Down period where the specified pointer sequence runs continuously.

Periodic Test Sequences

For periodic test sequences (for example PERIODIC ADD) both the 60 second initialization and 30 second cool down periods consist of the same sequence as used for the subsequent measurement sequence. If the product of the period T and the selected Optional background pattern (87+3 or 26+1) exceeds 60 seconds then the longer period is used for the initialization. For example, if T is set for 10 seconds then the initialization period may be extended to 900 seconds.

The OmniBER 718 displays a message indicating which phase (initialization, cool down or measurement) the transmitter is currently generating.

NOTE

The following conditions apply for pointer sequence generation:
The sequences can only be applied to the SPE pointer when the SPE does not contain a VT structure, otherwise it is applied to the VT pointer. Pointer sequence generation is not available when a frequency offset is being applied to the Line Rate.

The following figure gives an example of a T1.105/GR-253, 87-3 Pointer Sequence.

Selecting Test Features
Adding Pointer Adjustments

T1.105 A4 and A5, 87-3 Pattern

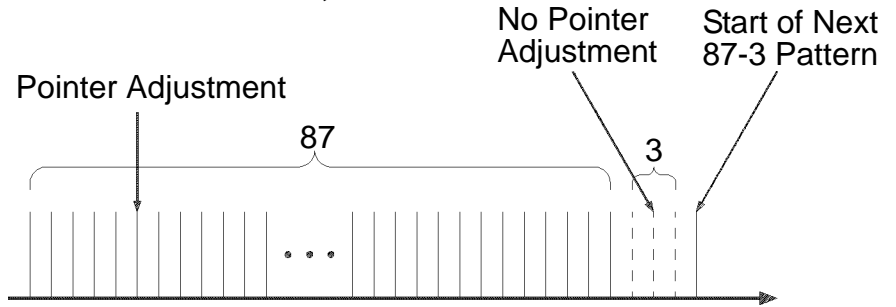

An Example of a Pointer Sequence

Pointer Sequence	Description
T1.105 A1 SINGLE GR-253 5-29	Periodic Single adjustments, all of the same polarity which is selectable. Separation between pointer adjustments is fixed at approximately 30 seconds.
T1.105 A2 BURST OF 3 GR-253 5-30	Periodic bursts of 3 adjustments, all of the same polarity which is selectable. The interval between bursts is fixed at approximately 30 seconds. The interval between adjustments within a burst is set to the minimum.
T1.105 A3 PHASE TRANSIENT GR-253 5031	Phase transient pointer adjustment burst test sequence. All adjustments are of the same polarity, which is selectable. The interval between bursts is fixed at 30 seconds. Each burst consists of 7 pointer movement. The first 3 in each burst are 0.25 s apart, and the interval between the 3 and 4 movement, and each remaining movement 0.5 seconds.
T1.105 A4 PERIODIC NORMAL (87-3 Pattern) GR-253 5-33(b)	An 87-3 pattern is selected. The sequence pattern is 87 pointer movements followed by 3 missing pointer movements. Pointer polarity is selectable and the time interval between pointer adjustments settable.
T1.105 A4 PERIODIC NORMAL (Continuous Pattern) GR-253 5-34(b)	Provides a continuous sequence of pointer adjustments. The polarity of the adjustments is selectable, and the time interval between adjustments can be set (see Note 1).

Selecting Test Features
Adding Pointer Adjustments

Pointer Sequence	Description
GR-253 5-32(b) PERIODIC NORMAL (26-1 Pattern)	This selection is only available if you have selected VT1.5 mapping. The sequence pattern is 26 pointer movements followed by 1 missing pointer movement. Pointer polarity is selectable and the time interval between pointer adjustments programmable to 200 ms, 500 ms, 1 s, 2 s, 5 s or 10 seconds.
T1.105 A5 PERIODIC ADD (87-3 Pattern) GR-253 5-33(c)	An 87-3 pattern is selected. The sequence pattern is 87 pointer movements followed by 3 missing pointer movements with an added pointer movement after the 43rd pointer. The spacing between the added adjustment and the previous adjustment is set to the minimum. Pointer polarity is selectable. The time interval between pointer adjustments can be set (see Note 1). Added adjustments occur every 30 seconds or every repeat of the 87-3 pattern, whichever is longer.
T1.105 A5 PERIODIC ADD (Continuous Pattern) GR-253 5-34(c)	Periodic Single adjustments, with selectable polarity and added adjustment (1 extra). The spacing between the added adjustment and the previous adjustment is set to the minimum, (see Note 2). The time interval between pointer adjustments can be set (see Note 1). Added adjustments occur every 30 seconds or every repeat of the 87-3 pattern, whichever is longer.
GR-253 5-32(c) PERIODIC ADD (26-1 Pattern)	This selection is only available if you have selected VT1.5 mapping. The sequence pattern is 26 pointer movements followed by 1 missing pointer movement. The added adjustment occurs 2 ms after the 13th pointer adjustment. Pointer polarity is selectable and the time interval between pointer adjustments programmable to 200 ms, 500 ms, 1 s, 2 s, 5 s or 10 s. Added adjustments occur every 30 seconds or every repeat of the 26-1 pattern, whichever is longer.
T1.105 A5 PERIODIC CANCEL (87-3 pattern) GR-253 5-33(d)	An 87-3 pattern is selected. The sequence pattern is 87 pointer movements followed by 3 missing pointer movements with a cancelled pointer movement at the 87th pointer. Pointer polarity is selectable, and the time interval between pointer adjustments can be set (see Note 1). Cancelled adjustments occur every 30 seconds or every repeat of the 87-3 pattern, whichever is longer.

Selecting Test Features
Adding Pointer Adjustments

Pointer Sequence	Description
T1.105 A5 PERIODIC CANCEL (Continuous Pattern) GR-253 5-34(d)	Periodic Single adjustments, with selectable polarity and cancelled adjustment (1 less). The time interval between pointer adjustments can be set (see Note 1). Cancelled adjustments occur every 30 seconds or every repeat of the 87-3 pattern, whichever is longer.
GR-253 5-32(d) PERIODIC CANCEL (26-1 pattern)	This selection is only available if you have selected VT1.5 mapping. The sequence pattern is 26 pointer movements followed by 1 missing pointer movement. The cancelled adjustment is the 26th pointer adjustment, that is the one before the regular gap of 1. Pointer polarity is selectable and the time interval between pointer adjustments programmable to 200 ms, 500 ms, 1 s, 2 s, 5 s or 10s. Cancelled adjustments occur every 30 seconds or every repeat of the 26-1 pattern, whichever is longer.

NOTE

For SPE pointers the sequence interval is selectable from 7.5 ms, 10, 20, 30, 34 ms; 40 to 100 ms in 10 ms steps, 100 to 1000 ms in 100 ms steps, 1, 2, 5, 10 seconds.
 For VT pointers the sequence interval is selectable from: 200 ms, 500 ms, 1, 2, 5 and 10 seconds.
 For SPE pointers the minimum spacing between adjustments is 500 us.
 For VT pointers the minimum spacing between adjustments is 2 ms.

Table 3 Pointer Sequences Available with Selected Mapping

POINTER SEQUENCE	MAPPING		
	SPE	VT6, VT2	VT1.5
A1 SINGLE	√	√	√
A2 BURST OF 3	√	√ 3	√
A3 PHASE TRANSIENT	√	√	√
A4 PERIODIC NORMAL(87-3)	√		
A4 PERIODIC NORMAL (Continuous)	√	√	√

Selecting Test Features
Adding Pointer Adjustments

Table 3 **Pointer Sequences Available with Selected Mapping**

POINTER SEQUENCE	MAPPING		
	SPE	VT6, VT2	VT1.5
PERIODIC NORMAL (26-1)			√
A5 PERIODIC ADD (87-3)	√		
A5 PERIODIC ADD (Continuous)	√	√	√
PERIODIC ADD (26-1)			√
A5 PERIODIC CANCEL (g) 87-3	√		
A5 PERIODIC CANCEL (Continuous)	√	√	√
PERIODIC CANCEL 26-1			√

Selecting Test Features

Using Pointer Graph Test Function

Using Pointer Graph Test Function

Pointer Graph shows the relative offset during the measurement period. This allows the time relationship of SPE or VT pointer movements to be observed. Up to 4 days of storage allows long term effects such as Wander to be observed. If an alarm occurs during the measurement period, a new graph starts at the centre of the display (offset zero) after recovery from the alarm.

TIP: The Pointer Graph display can be logged to the chosen logging device. See "Logging on Demand " page 241.

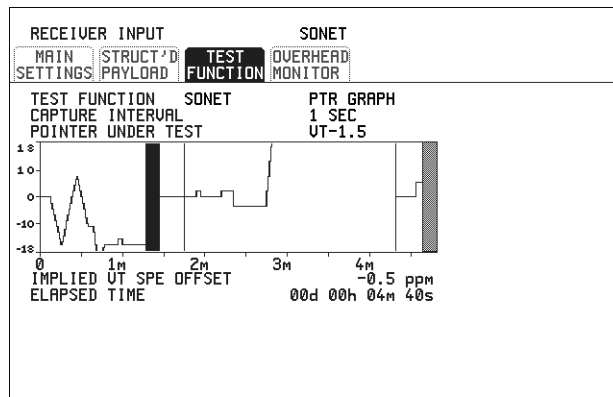

STATUS:

MULTIPLE WINDOW

TIP: The graph can also be viewed on the **RESULTS** **SONET RESULTS** display at the end of the measurement.

HOW TO:

- 1 Set up the receive SONENT interface and payload as required. See "Setting SONENT Receive Interface" page 47.
- 2 On the RECEIVE Test Function page, select **PTR GRAPH** then choose the CAPTURE INTERVAL required.
The capture interval determines the time between captures. Low values of capture interval should be chosen when a high degree of pointer movements is expected. High values of capture interval should be chosen when a low degree of pointer movements is expected, for example Wander over 1 day, use 5 MINS and Wander over 4 days, use 20 MINS.
If, during a long term measurement (4 days), an event occurs at a particular time each day, then the instrument can be set to log the results graph of that event.

Selecting Test Features

Using Pointer Graph Test Function

3 Choose the POINTER UNDER TEST type.

4 Press **RUN/STOP** to start the measurement.

TIP:

If the event occurs outside normal working hours, a Timed Start measurement can be made.

The values of capture interval available and the approximate total capture window is as follows:

1 SEC - display window of approximately 5 minutes.

5 SECS - display window of approximately 25 minutes.

20 SECS - display window of approximately 1 hour 40 minutes.

1 MIN - display window of approximately 5 hours.

5 MIN - display window of approximately 1 day.

20 MIN - display window of approximately 4 days.

Stressing Optical Clock Recovery Circuits

Description

This test is essentially designed for testing optical clock recovery circuits in the presence of long runs of zero's or one's (after scrambling). The test function page allows control of the test pattern and the block length. The maximum block length is 2 bytes less than the width of the SPE.

When the test is enabled, the instrument applies the selected pattern immediately after the first row of Section Overhead bytes **after scrambling**. The location of the start of the pattern is byte 4 at 52 Mb/s (i.e. after the first three bytes of overhead), byte 10 at 155 Mb/s, byte 37 at 622 Mb/s and byte 145 at 2488 Mb/s. The remainder of the SPE will contain the signal structure and pattern as defined on the TRANSMITTER, MAIN SETTINGS page.

The payload is overwritten in such a way that the transmitted B1 and B2 values are correct.

When using this feature to test network equipment clock recovery, long runs of zero's may be inserted at the input of the UUT (unit under test) and by monitoring B1 and B2 at the UUT output, error free transmission can be verified.

The stress test is available at all optical rates.

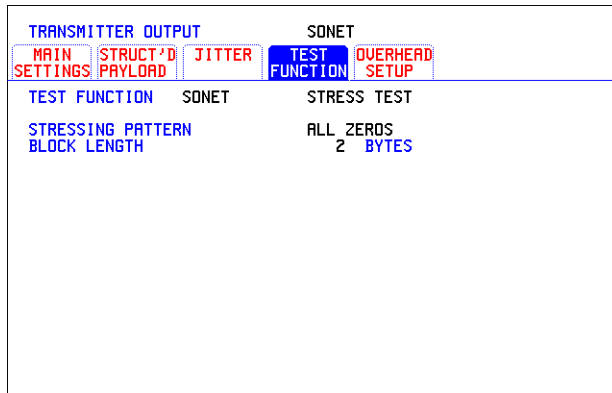

STATUS:



HOW TO:

- 1 Set up the SONET transmit interface and payload required. See "Setting SONET Transmit Interface " page 29.

Selecting Test Features

Stressing Optical Clock Recovery Circuits

Choose the required STRESSING PATTERN.

The G.958 test pattern consists of 7 consecutive blocks of data as follows: the first row of section overhead bytes, ALL ONES, a PRBS, the first row of section overhead bytes, ALL ZEROS, a PRBS and the first row of section overhead bytes.

- 2** If you choose ALL ONES or ALL ZEROS as the stressing pattern, choose the number of bytes in the BLOCK LENGTH.

Generating Automatic Protection Switch (APS) Messages

Description

You can program the K1 and K2 bytes to exercise the APS functions for both LINEAR (GR-253) and RING (GR-1230) topologies.

The APS Message types are:-

- PASSIVE
- ACTIVE

The following table shows the APS message type availability.

TX	RX	TOPOLOGY	APS Message Types
SONET	PDH/DSn	LINEAR	PASSIVE
SONET	PDH/DSn	RING	PASSIVE
SONET	SONET	LINEAR	PASSIVE or ACTIVE
SONET	SONET	RING	PASSIVE

**GENERAL
HOWTO:**

- 1** Set up the SONET transmit interface and payload required. See "Setting SONET Transmit Interface " page 29.
- 2** Choose the TOPOLOGY required.
- 3** Follow the appropriate HOWTO, listed in the following pages.

Selecting Test Features

Generating Automatic Protection Switch (APS) Messages

PASSIVE APS HOWTO:

The default APS message type is PASSIVE. The APS message is only transmitted when the **DOWNLOAD** key is pressed.

The screenshot shows a terminal window titled "TRANSMITTER OUTPUT" with a sub-header "SONET". The menu is divided into four sections: "MAIN SETTINGS", "STRUCT'D PAYLOAD", "TEST FUNCTION", and "OVERHEAD SETUP". The "TEST FUNCTION" section is active, showing the "SETUP" menu for "APS". The "NEW TX" menu is open, with "PASSIVE" selected under the "TOPOLOGY" field. Other fields include "K1 BITS 1->4" (0000: NO REQUEST), "BITS 5->8" (0000: NULL CHANNEL), "K2 BITS 1->4" (0000: BRIDGED CHANNEL NO.), "BIT 5" (0: 1+1 ARCHITECTURE), and "BITS 6->8" (000: RESERVED). Below this, "CURRENT TX" and "CURRENT RX" values for K1 and K2 are displayed. At the bottom, there are "TRANSMIT NEW K1/K2" and "SELECT" options. Below the terminal window, there are three status indicators: "STATUS:" followed by "PASSIVE" (highlighted in yellow) and "ACTIVE" (highlighted in yellow), and a "MULTIPLE WINDOW" indicator (highlighted in grey).

HOW TO:

- 1 Select PASSIVE APS message type.

NOTE

This step does not apply to RING TOPOLOGY.

- 2 Choose the message to be transmitted.
If LINEAR topology is chosen, choose the CHANNEL, the BRIDGED CHANNEL NO., the ARCHITECTURE and the RESERVED bits you require.
If RING topology is chosen, choose the DESTINATION NODE ID, the SOURCE NODE ID, the type of PATH and the status code (K2 Bits 6->8)
The current TX and RX, K1 and K2, values are displayed for reference only.
- 3 Choose **DOWNLOAD** to transmit the new K1/K2 values.

Selecting Test Features
Generating Automatic Protection Switch (APS) Messages

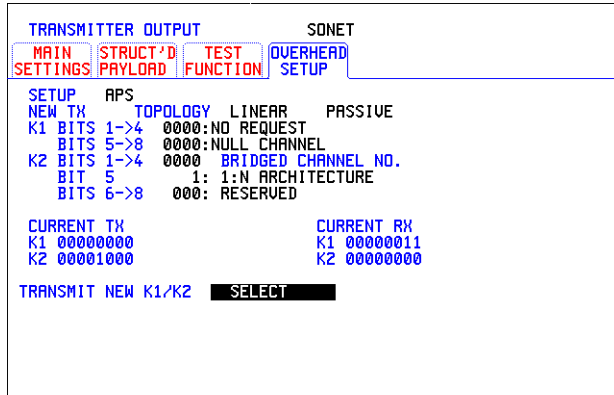

**ACTIVE APS
 Message Type**

This message type only applies to LINEAR topology.

The ACTIVE APS message type gives real-time response to provide switching keep-alive capability. The instrument will not initiate any changes, but will respond to change requests that appear on the input K1/K2 byte values.

The ACTIVE APS message type offers two modes:-

- UNIDIRECTIONAL
- BIDIRECTIONAL

The behavior for each mode is as shown in the following table.

APS MODE	RX K1 (b5-b8)*	TX K1 (b1-b4)*	TX K1 (b5-b8)*	TX K2 (b1-b4)*	TX K2 (b5)*	TX K2 (b6-b8)*
UNIDIRECTIONAL	xxxx	0000	0000	xxxx	user	100
BIDIRECTIONAL	0000	0000	0000	0000	user	101
BIDIRECTIONAL	yyyy	0010	yyyy	yyyy	user	101

* GR bit numbering convention

where:

xxxx = any 4-bit binary value.

user = user programmable bit, corresponding to APS ARCHITECTURE.

Selecting Test Features

Generating Automatic Protection Switch (APS) Messages

yyyy = any non-zero 4-bit binary value.

TRANSMITTER OUTPUT		SONET	
MAIN SETTINGS	STRUCT'D PAYLOAD	TEST FUNCTION	OVERHEAD SETUP
SETUP	APS		
NEW TX	TOPOLOGY	LINEAR	ACTIVE
			UNIDIRECTIONAL
K1 BITS 1->8	SET TO	00000000	
K2 BITS 1->4	SET IN RESPONSE TO RX VALUE		
K2 BIT 5	0: 1+1 ARCHITECTURE		
BITS 6->8	100: UNIDIRECTIONAL		
CURRENT TX		CURRENT RX	
K1 00000000		K1 00000011	
K2 00110100		K2 00000000	
TRANSMIT NEW K2		SELECT	

STATUS: PASSIVE ACTIVE MULTIPLE WINDOW

HOW TO:

- 1 Select ACTIVE APS message type.
- 2 Select ACTIVE APS message mode.

TRANSMITTER OUTPUT		SONET	
MAIN SETTINGS	STRUCT'D PAYLOAD	TEST FUNCTION	OVERHEAD SETUP
SETUP	APS		
NEW TX	TOPOLOGY	LINEAR	ACTIVE
			UNIDIRECTIONAL
K1 BITS 1->8	SET TO	00000000	
K2 BITS 1->4	SET IN RESPONSE TO RX VALUE		
K2 BIT 5	0: 1+1 ARCHITECTURE		
BITS 6->8	100: UNIDIRECTIONAL		
CURRENT TX		CURRENT RX	
K1 00000000		K1 00000011	
K2 00110100		K2 00000000	
TRANSMIT NEW K2		SELECT	

STATUS: UNI-DIRECT BI-DIRECT MULTIPLE WINDOW

Selecting Test Features

Generating Automatic Protection Switch (APS) Messages

- 3 Select the required APS ARCHITECTURE.
- 4 Choose **DOWNLOAD** to transmit the new K1/K2 values.

```
TRANSMITTER OUTPUT          SONE1
MAIN  STRUCT'D  TEST  OVERHEAD
SETTINGS PAYLOAD FUNCTION SETUP
-----
SETUP  APS
NEW TX  TOPOLOGY  LINEAR  ACTIVE
                UNIDIRECTIONAL
K1 BITS 1->8  SET TO 00000000
K2 BITS 1->4  SET IN RESPONSE TO RX VALUE
K2 BIT 5      1: 1:N ARCHITECTURE
                BITS 6->8  100: UNIDIRECTIONAL

CURRENT TX          CURRENT RX
K1 00000000        K1 00000011
K2 00111100        K2 00000000

TRANSMIT NEW K2      SELECT
```

STATUS:

SELECT

**DOWN
LOAD**

**MULTIPLE
WINDOW**

Inserting and Dropping the Data Communications Channel

Description

The Data Communications Channel (DCC) of the regenerator and multiplexer section overhead can be verified by protocol testing. The Insert and Drop capability provides access to the DCC via the RS-449 connector on the front panel of the Multirate Analyser module.

DCC INSERT is available on the **TRANSMIT**, **SONET**, **TEST FUNCTION** display.

DCC DROP is available on the **RECEIVE**, **SONET**, **TEST FUNCTION** display.

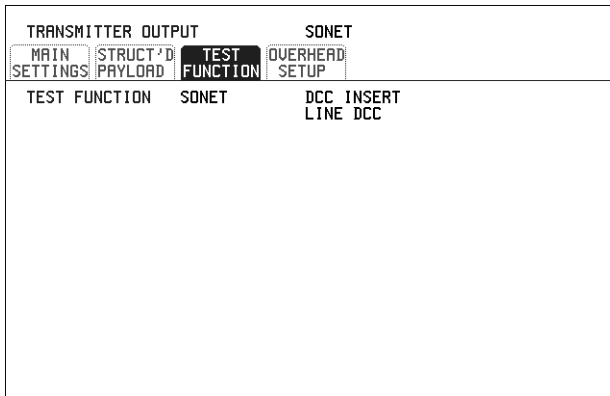

STATUS:

MULTIPLE WINDOW

HOW TO:

- 1 Connect the Protocol Analyzer to the DCC port on the Multirate Analyzer module.
- 2 Choose the required DCC.

Using DS1 LOOP Codes

Description

A loopback code causes the far end equipment to return a signal to the sender, so that the sender can verify signal integrity. Loop codes are used by carriers of the T1 signal and users of the transport medium as a maintenance tool to aid in fault location. Loopback commands are in-band (that is they use the payload space), and out-band (they use an ESF data link).

The OmniBER 718 provides both In-band and Out-band loop codes as follows:

Out-band Loop Codes

Out-band codes are transmitted in an ESF data link, in addition to transmitting the in-band signal in the payload. They are only available when ESF framing is selected on the Transmitter Output **MAIN SETTINGS** page.

Loop type	Activate	Deactivate
Line	11111111 01110000	1111111100011100
Payload	11111111 00101111	11111111 01001100
Network	11111111 01001000	n/a
Universal	n/a	11111111 00100100
User Code	111111110xxxxx0	

Note that when switching from an idle message to a loop-back message, the loop-back message will start following the idle message and not part way through it.

Note that the left most bit is transmitted first, and that when a loop code is not being sent, the idle data link sequence is sent. This is a continuous repetition of the pattern 01111110

In-band Loop Codes

With in-band codes, the transmitted signal comprises the entire payload of the signal, overwriting whatever signal was there before. The signal may be framed or unframed. When framed the framing bits overwrite the loopback code (see “In-Band DS1 Loopcode 156MTS Compatibility” on next page).

Note the user word can be set to any length, between 3 and 8 bits. The left most bit is transmitted first.

Selecting Test Features

Using DS1 LOOP Codes

The following in-band codes can be selected .

Loop type	Activate	Deactivate
Line	00001	001
Payload	1100	1110
Network	11111111 01001000	n/a
User Code	xxxxxxxx	xxxxxxxx

In-Band DS1 Loopcode 156MTS Compatibility

Normal operation is such that DS1 framing bit overwrites the DS1 Loopcode pattern. A selection on the **OTHER MISCELLANEOUS** page enables you to change operation such that DS1 Loopcode is gapped in order to prevent the DS1 framing bit overwriting the DS1 Loopcode pattern. See page 292 In-Band DS1 Loopcode 156MTS Compatibility.

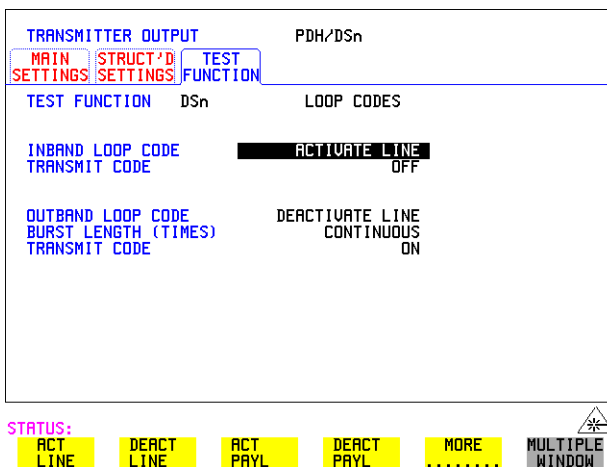

HOW TO:

Transmit an In-band loop code

- 1 Choose SIGNAL **DS1** and set LINE CODE and PAYLOAD TYPE as required on the **TRANSMIT MAIN SETTINGS** display.
- 2 Choose **TRANSMIT TEST FUNCTION** and set the TEST FUNCTION field to **DSn** and **LOOP CODES**.

Selecting Test Features

Using DS1 LOOP Codes

- Choose the INBAND LOOP CODE from the choices given.
- To transmit a code select the TRANSMIT CODE field on the **TRANSMIT TEST FUNCTION**, **DSn**, **LOOP CODES** display and select **BURST**. The code is sent for nominally eight seconds.

HOW TO:

Monitor/view received loop codes

- Choose SIGNAL **DS1** on the **RECEIVE MAIN SETTINGS** display. Also set the LINE CODE to match the setting on the Transmitter display.
- Choose **DSn RESULTS** and **LOOP CODES** on the **RESULTS** display.
- Set the INBAND LOOPUP and LOOPDOWN fields to the required codes. Note the instrument receiver only detects the codes you have chosen. It does not detect other codes in the background. If you wish to view other codes, then you must select them in the appropriate fields.
- View the results in the RESULTS window.

TRANSMITTER OUTPUT		PDH/DSn		RECEIVER INPUT		PDH/DSn	
MAIN SETTINGS		TEST FUNCTION		MAIN SETTINGS		TEST FUNCTION	
TEST FUNCTION	DSn	LOOP CODES		SIGNAL	DS1		
INBAND LOOP CODE		ACTIVATE NETWORK	BURST	TERMINATION LINE CODE	1000 BAL	AMI	TERMINATE
OUTBAND LOOP CODE		ACTIVATE LINE	CONTINUOUS ON	PAYLOAD TYPE	ESF	UNSTRUCTURED PATTERN	
BURST LENGTH (TIMES)							
TRANSMIT CODE							
RESULTS		DSn		FUNCTION		MISCELLANEOUS	
		LOOP CODES					
INBAND LOOPUP		ACTIVATE NETWORK	DETECTED	KEYBOARD LOCK	ON		
LOOPDOWN		DEACTIVATE LINE	BEEP ON RECEIVED ERROR	OFF		
LAST VALID CODE		11000	ACTIVATE NETWORK	INBAND DS1 LOOPCODE	OFF		
OUTBAND CURRENT CODE		111000	ACTIVATE LINE	156MTS COMPATIBILITY	OFF		
LAST VALID CODE		010100	ACTIVATE PAYLOAD	SUSPEND TEST ON SIGNAL LOSS	OFF		
ELAPSED TIME		00d 00h 00m 10s		HS-REI RESULT ENABLE	ON		
				GRAPH STORAGE RESOLUTION	COMPRESS		
				NOTE: storing graph results with full resolution will reduce storage capacity by 50%			
STATUS: Transmitting inband burst							
ACT LINE	ACT PRYL	ACT N/WORK	USER CODE	SINGLE WINDOW			

HOW TO:

Transmit an Out-band loop code

- Choose SIGNAL **DS1** and set LINE CODE as required, and PAYLOAD TYPE to **ESF** on the **TRANSMIT MAIN SETTINGS** display.
- Choose **TRANSMIT TEST FUNCTION** and set the TEST FUNCTION field to **DSn** and **LOOP CODES**.

Selecting Test Features

Using DS1 LOOP Codes

- 3 Choose the OUTBAND LOOP CODE from the choices given.
- 4 Set the BURST LENGTH to **CONTINUOUS** or **BURST**. The BURST length can be set from 1 to 15 times .
- 5 To transmit the code set the TRANSMIT CODE field on the **TRANSMIT TEST FUNCTION** field to **ON** or **BURST** as required.

HOW TO:

Monitor/view received loop codes

- 6 Choose SIGNAL **DS1** and PAYLOAD TYPE **ESF** on the **RECEIVE MAIN SETTINGS** display. Also set the LINE CODE to match the setting on the Transmitter display.
- 7 Choose **DSn RESULTS** and **LOOP CODES** on the **RESULTS** display.
- 8 View the CURRENT CODE and LAST CODE results in the RESULTS window.

“Using Overhead BER Test Function”	page 108
“Performing a Trouble Scan”	page 109
“Test Timing”	page 111
“Making SONET Analysis Measurements”	page 112
“Making DSn Analysis Measurements”	page 113
“Measuring Frequency”	page 114
“Measuring Optical Power”	page 115
“Measuring Round Trip Delay”	page 116
“Monitoring Signaling Bits”	page 118
“Measuring Service Disruption Time”	page 119
“Performing a SONET Tributary Scan”	page 122
“Performing a SONET Alarm Scan”	page 125
“Performing a DSn Alarm Scan”	page 126
“Measuring Jitter”	page 127
“Measuring Extended Jitter”	page 129
“Measuring Wander”	page 131
“Measuring Jitter Tolerance”	page 134
“Measuring Jitter Transfer”	page 138
“Measuring Pointer Adjustment (Tributary) Jitter”	page 144

Making Measurements

Making Measurements

Using Overhead BER Test Function

Using Overhead BER Test Function

Description

You can perform a Bit Error Rate test on chosen bytes of the section, line and path overhead bytes.

The OVERHEAD BER controls are located under **TEST FUNCTION** in the TRANSMITTER and RECEIVER windows.

RECEIVER INPUT		SONET	
MAIN SETTINGS	STRUCT'D PAYLOAD	TEST FUNCTION	OVERHEAD MONITOR
TEST FUNCTION	SONET	OVERHEAD BER	
MEASURE PRBS	FROM BYTE	SOH	20
	WITHIN STS-3#	3	STS-1# 3
ERROR COUNT			19
ERROR RATIO			6.071E-06
ERROR FREE SECONDS			42
%ERROR FREE SECONDS			87.500
PATTERN LOSS SECONDS			0
ELAPSED TIME			00d 00h 00m 48s

STATUS:

MULTIPLE WINDOW

HOW TO:

- 1 Set up the SONET transmit interface and payload required. See "Setting SONET Transmit Interface " page 29.
- 2 Set up the receive SONET interface and payload as required. See "Setting SONET Receive Interface " page 47.
- 3 Choose the overhead byte to be tested on the **RECEIVE SONET TEST FUNCTION** display.
- 4 Choose the overhead byte to be tested on the **TRANSMIT SONET TEST FUNCTION** display.
- 5 Press **RUN/STOP** to start the test.
- 6 The PRBS pattern can be errored by pressing **SINGLE**.

Performing a Trouble Scan

When first connecting to the network it can be useful to have an indication of any problems that exist before starting testing. In the OmniBER 718 this feature is provided by Trouble Scan.

All possible error sources and alarms are scanned simultaneously. If any error counts are not zero then these are displayed. Up to 4 non-zero error counts are displayed in priority order.

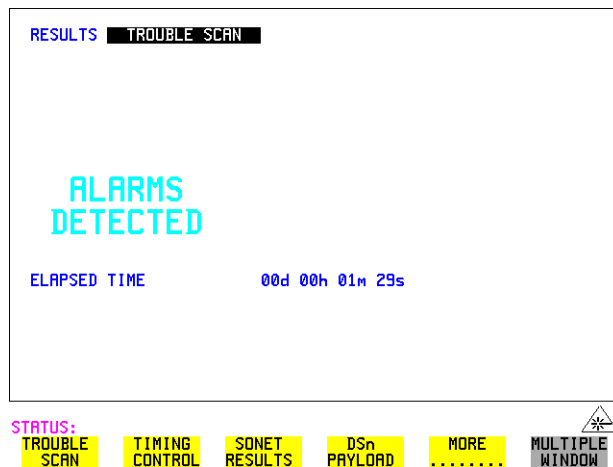

If all error counts are zero and any alarms are detected "ALARMS DETECTED" is displayed.

SHOW and the alarm led's can be used to determine which alarms were detected.

If no alarms are detected and all error counts are zero then "NO TROUBLE" is displayed.

Error Count Priority - see the Table on the following page for a list of error count priority.

Making Measurements
Performing a Trouble Scan

Error Count Priority

DSn	SONET	ATM	POS
CRC CODE DS3FR (DS1FR) P-BIT C-BIT FEBE BIT	CV-S CV-L CV-P CV-V FRAME CRC DS3FR (DS1FR, FAS2) REI-L REI-P REI-V P-BIT C-BIT REBE (FEBE) BIT	Corrected HEC Non corrected HEC Received Cells CLP0 Received Cells CLP1 Received Cells CLP0+1 Errored Cells Lost Cells Misinserted Cells Bit Error Non-conforming cells	FCS Errors IP Header Errors IP Payload Errors

Test Timing

Description

There are two aspects to test timing:

- Error results may be displayed as short term or cumulative over the measurement period. If short term error measurements are required, the short term period may be selected.
- The period of the test may be defined or controlled manually.

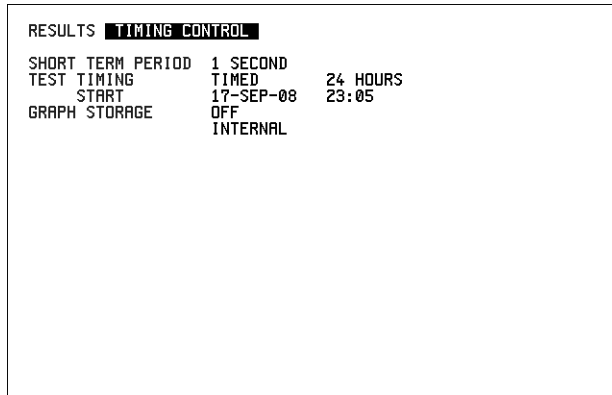

HOW TO:

- 1 Choose **TIMING CONTROL** on the **RESULTS** display.
- 2 Set the SHORT TERM PERIOD to the timing required for short term results.
- 3 Choose the type of TEST TIMING required:
For manual control with **RUN/STOP** choose **MANUAL**.
For a single timed measurement period started with **RUN/STOP**, choose **SINGLE** and choose the Test duration.
For a timed period starting at a specified time, choose **TIMED**, choose the Test duration and the test START date and time.

Making Measurements
Making SONET Analysis Measurements

Making SONET Analysis Measurements

Description

G.826, M.2101, M.2110 and M.2120 analysis results are provided for all relevant SONET error sources.

In addition the following results are provided:

- Cumulative error count and error ratio.
- Short Term error count and error ratio.
- Alarm Seconds.
- Frequency and optical power.
- Pointer Values and pointer adjustment counts.
- Pointer Graph.

RESULTS	SONET		ERROR ANALYSIS	
G.826	M.2101	M.2110	M.2120	
ERROR TYPE CU-L(B2)				
CU-L(B2) ANALYSIS (G.826)				
EB	426612	ES	0	
SES	0	URS	57	
PUAS	57	BBE	0	
ESR	0	SESR	0	
BBER	0			
ELAPSED TIME		00d 00h 03m 20s		

STATUS:

MULTIPLE WINDOW

HOW TO:

- 1 Set up the receive SONET interface and payload required. See "Setting SONET Receive Interface " page 47.
- 2 If required set up the SONET transmit interface and payload. See "Setting SONET Transmit Interface " page 29.
- 3 Press **RUN/STOP** to start the measurement.
- 4 You can view the analysis results on the **RESULTS** **SONET** **ANALYSIS** display.

TIP:

The measurement will not be affected if you switch between the different results provided.

Making DSn Analysis Measurements

Description

G.821, G.826, M.2100, M.2110 and M.2120 analysis results are provided for all relevant DSn and DSn Payload error sources.

In addition the following results are provided:

- Cumulative error count and error ratio
- Short Term error count and error ratio
- Alarm Seconds
- SIG/BIT Monitor. See "Monitoring Signaling Bits " page 118.

RESULTS	DSn	ERROR ANALYSIS		
G.821	G.826	M.2100	M.2110	M.2120
BIT				
EC	126	And	ES	2.32240%
ES	11			6.01093%
EFS	172			93.98907%
SES	0			0.00000%
UNAV	21			10.29412%
DEG MIN	1			25.00000%
BPV ES	5			
ELAPSED TIME		00d 00h 03m 24s		

STATUS:

MULTIPLE WINDOW

HOW TO:

- 1 If SONET is chosen as the interface, set up the Receive Interface and Payload required. See "Setting SONET Receive Interface " page 47. If required set up the Transmit Interface and Payload. See "Setting SONET Transmit Interface " page 29.
- 2 If DSn is chosen as the interface, set up the DSn receive interface. See "Setting PDH/DSn Receive Interface " page 45. If required set up the DSn transmit interface. See "Setting PDH/DSn Transmit Interface (Option 012) " page 26.
- 3 Press **RUN/STOP** to start the measurement.
- 4 If SONET is chosen as the interface, you can view the analysis results on the **RESULTS** | **DSn PAYLOAD** | **ERROR ANALYSIS** display
 If DSn is chosen as the interface, you can view the analysis results on the **RESULTS** | **DSn** | **ERROR ANALYSIS** display.

Measuring Frequency

Description

The signal frequency and the amount of offset from the standard rate can be measured to give an indication of probability of errors.

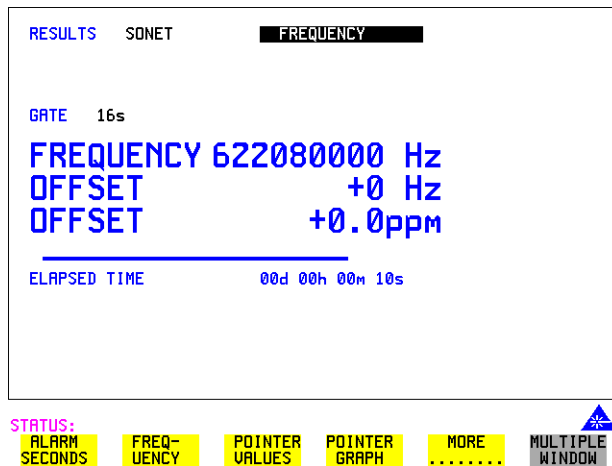

HOW TO:

- 1 Connect the signal to be measured to the IN port of the DSN Receive module or the IN port of the Multirate Analyzer module (SONET electrical) or the IN port of the Optical Interface module (SONET optical).
- 2 Choose the required SIGNAL rate and LEVEL on the **PDH/DSn** **RECEIVE** **MAIN SETTINGS** or **SONET** **RECEIVE** **MAIN SETTINGS** display.

NOTE

1. Frequency measurement is always available even if test timing is off.
2. The result is only valid if a complete sweep of the highlighted bar has occurred since the input was applied.

Test Period

Two counter gate periods, selected in the **GATE** field are provided simultaneously, 1s and 16s. For the 16s gate period a “Fuel Gauge” indicates progress towards the next update.

Measuring Optical Power

Description

Optical power measurement can be performed on the SONET signal connected to the Optical module IN port.

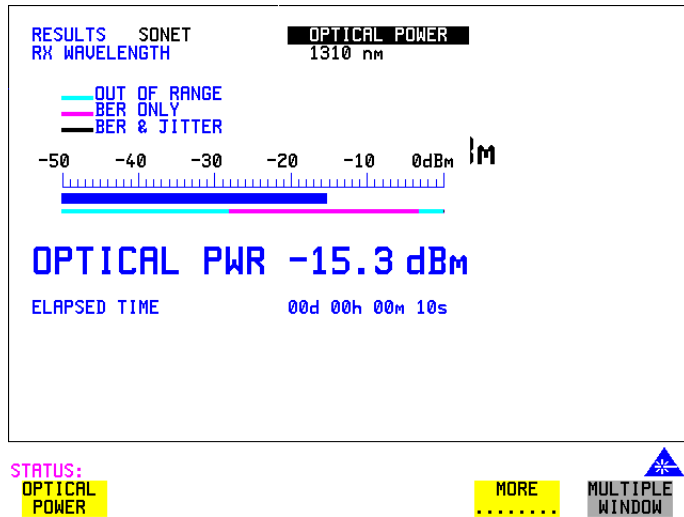

HOW TO:

- 1 Connect the SONET optical signal to the IN port of the Optical Interface module.
- 2 Choose the received input signal rate on the **RECEIVE** **SONET** display.
- 3 Select **RESULTS**, SONET, **OPTICAL POWER** as shown above.

NOTE

1. Optical power measurement is always available even if test timing is off.
 2. The white portion of the colored bar shows the power range for accurate jitter measurement (only displayed if a jitter option is fitted). The green portion of the colored bar shows the power range for accurate BER measurement.
-

Making Measurements

Measuring Round Trip Delay

Measuring Round Trip Delay

Description:

The time taken for voice traffic to pass through the network is very important. Excessive delay can make speech difficult to understand. The Round Trip Delay feature of the OmniBER 718 measures the delay in a 64 kb/s timeslot. A test pattern is transmitted in the 64 kb/s timeslot and a timer is set running. A loopback is applied to the network equipment to return the test signal. The received pattern stops the timer and the Round Trip Delay is calculated.

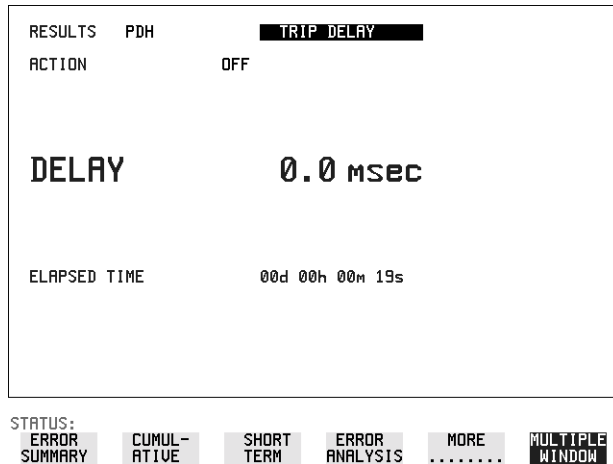

NOTE

You can only measure Round Trip Delay on a 64 kb/s test signal obtained from a 140 Mb/s, 34 Mb/s, 8Mb/s or 2 Mb/s DS_n interface or DS_n payload signal.

HOW TO:

- 1 If measuring on an SONET interface, set up the SONET transmit and receive interfaces and payloads required. See "Setting SONET Transmit Interface " page 29 and "Setting SONET Receive Interface" page 47.
- 2 If measuring on a DS_n interface, set up the DS_n transmit and receive interfaces and payloads required. See "Setting PDH/DS_n Transmit Interface (Option 012)" page 26 and "Setting PDH/DS_n Receive Interface" page 45.
- 3 Connect a loopback to the network equipment.
- 4 Choose ACTION **ON** to start the measurement.
If measuring on an SONET interface, the results are available on the **RESULTS**

Making Measurements

Measuring Round Trip Delay

DSn PAYLOAD display.

If measuring on a DSn interface, the results are available on the **RESULTS**

DSn display.

The Round Trip delay measurement range is up to 2 seconds. The resolution varies with the received interface signal rate:

2 Mb/s	1 microsecond
8,34, 140 Mb/s	110 microseconds
STS-1, STS-3	0.5 milliseconds
OC-12, OC-48	0.5 milliseconds

Monitoring Signaling Bits

Description

The OmniBER 718 receiver can be used to monitor the state of signaling bits in received 2 Mb/s signals with timeslot-16 CAS multiframing (PCM30 or PCM30CRC) and DS1 structured signals.

2.048 Mb/s Results

For 2 Mb/s signals with timeslot-16 CAS multiframing a table showing the values of A,B,C,D signaling bits in all 30 channels is given.

DS1 Results

D4 and SLC-96 payloads

A table simultaneously showing the state of the A and B signaling bits in the 6th and 12th frames of a superframe is given. Each frame contains 24 timeslots. In SLC-96 mode A and B choices are 0, 1 or alternating. If you set bit A or B to alternate, the displayed bit changes to an A, to indicate that the bit is alternating from 1 to 0. The same signaling is transmitted in all channels.

ESF Payloads

A table simultaneously showing the state of the A, B, C and D signaling bits in the 6th, 12th, 18th and 24th frames of a superframe is given. Each frame contains 24 timeslots.

RESULTS		DSn PAYLOAD		SIG/BIT MONITOR			
DS1 ESF ABCD BITS							
TS	ABCD	TS	ABCD	TS	ABCD	TS	ABCD
1	1100	7	1111	13	1111	19	1111
2	1111	8	1111	14	1111	20	1111
3	1111	9	1111	15	1111	21	1111
4	1111	10	1111	16	1111	22	1111
5	1111	11	1111	17	1111	23	1111
6	1111	12	1111	18	1111	24	1111

STATUS:
 ERROR SUMMARY CUMULATIVE SHORT TERM ERROR ANALYSIS MORE MULTIPLE WINDOW

Measuring Service Disruption Time

Description:

Protection switching ensures that data integrity is maintained and revenue protected when equipment failure occurs. The speed of operation of the protection switch can be measured.

The sequence of events involved in measuring the switching time is:

- Pattern Synchronization (no errors) is achieved.
- The protection switch is invoked - Pattern Synchronization is lost.
- The standby line is in place - Pattern Synchronization is regained.

The time interval between pattern sync loss and pattern sync gain is a measure of the disruption of service due to protection switching. For information on measuring service disruption on ATM refer to "ATM Service Disruption" page 169 and for POS operation refer to "POS Service Disruption" page 211.

RESULTS SRVC DISRUPT	
LONGEST	0.000MS
SHORTEST	0.000MS
LAST	0.000MS
ELAPSED TIME	00d 00h 00m 20s

STATUS:
PDH ALM SCAN SERVICE DISRUPT SONET ALM SCAN SONET TRIBSCAN MORE MULTIPLE WINDOW

Service Disruption is chosen on the **RESULTS** page except for the following configuration:

- If you choose a DS_n or SONET interface and an ANSI (DS1, DS3) framed, unstructured payload you must select Service Disruption on the Transmitter and Receiver **TEST FUNCTION** display.

Making Measurements

Measuring Service Disruption Time

RECEIVER INPUT		PDH/DSn
MAIN	STRUCT'D	TEST
SETTINGS	SETTINGS	FUNCTION
TEST FUNCTION		SERU DISR
DSn	SERVICE DISRUPTION MODE	ON

STATUS:

MULTIPLE
WINDOW

NOTE

At DS1 and DS3 Service Disruption results are only available for Unstructured payloads.

Error Burst Definition

Error bursts start and finish with an error. Bursts of less than 10 us are ignored. Bursts are assumed to have completed when >200ms elapses without any errors being received.

The longest burst detected is 2 seconds.

Accuracy: <= 50us for bulk filled PDH/T-Carrier tributary test signals.

NOTE

Note To measure Service Disruption your instrument must have a PDH/DSn module fitted as the measurement takes place within the PDH/DSn module.

HOW TO:

- 1 If interfacing at SONET set up the SONET transmit and receive interfaces and payloads required. See "Setting SONET Transmit Interface " page 29 and "Setting SONET Receive Interface " page 47.
- 2 If interfacing at DSn set up the DSn transmit and receive interfaces and payloads as required. See "Setting PDH/DSn Transmit Interface (Option 012) " page 26 and "Setting PDH/DSn Receive Interface " page 45.

Making Measurements

Measuring Service Disruption Time

- 3 If you choose a DS1 or DS3 framed unstructured payload, choose **SERVICE DISRUPT** on the **TRANSMIT** and **RECEIVE** **TEST FUNCTION** displays.
- 4 Press **RUN/STOP** to start the measurement.
- 5 Invoke the protection switch.
- 6 View the results on the **RESULTS** **SRVC DISRUPT** display.

Results Displayed

LONGEST - Longest burst of errors during measurement.

SHORTEST - Shortest burst of errors during measurement.

LAST - Length of last burst of errors detected during measurement.

Performing a SONET Tributary Scan

Description

Verifying an ADM Installation

The OmniBER 718's tributary scan feature allows you to quickly test the routing of VC-n/STS-1 paths through digital cross connects and ADMs (when the tributary interfaces are synchronous). It does this by automatically testing each path through the network element for bit errors or a pattern loss. The example given below is applicable for both SONET and SDH applications

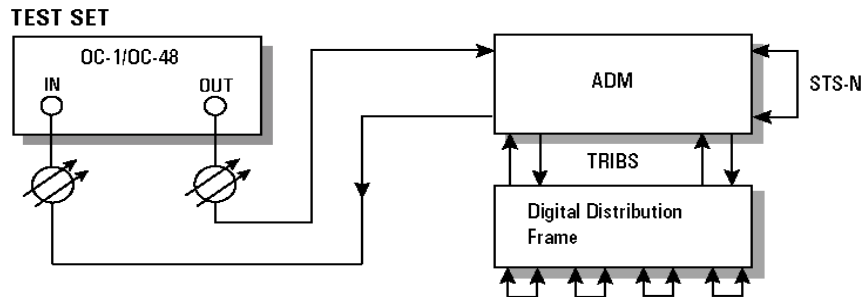

Tributary Scan tests each tributary for error free operation and no occurrence of Pattern Loss. A failure is indicated by highlighting the tributary in which the failure occurred. The **TRANSMIT** **SONET** **MAIN SETTINGS** , mapping setup determines the tributary structure. The OmniBER 718 will configure the Transmitter to the Receiver and the PATTERN is forced to the payload it will fill.

TIP:

The SONET Tributary Scan display can be logged to the chosen logging device. See "Logging on Demand " page 241.

Making Measurements

Performing a SONET Tributary Scan

TRANSMITTER OUTPUT		SONET	
MAIN SETTINGS	STRUCT'D PAYLOAD	TEST FUNCTION	OVERHEAD SETUP
TEST FUNCTION	TRIB SCAN		STOP
BIT ERROR THRESHOLD		>= 1E-6	
TEST TIMING	SINGLE	10 SECS	
SEE RESULTS PAGE FOR TRIBUTARY SCAN RESULTS			

STATUS:
STOP **START**

MULTIPLE WINDOW

HOW TO:

- 1 Set up the transmit and receive SONET interfaces and payload as required. See "Setting SONET Transmit Interface " page 29 and "Setting SONET Receive Interface " page 47.
- 2 Choose the required BIT ERROR THRESHOLD.
This determines the error rate above which a failure is declared.
- 3 Choose the required TEST TIMING.
The value you choose is the test time for each individual tributary and not the total test time.
For example, 28 VT-1.5 tributaries in an STS-1 SPE - the time taken to complete the Tributary Scan will be 28 X TEST TIMING choice.
- 4 The Tributary Scan results can be viewed on the **RESULTS** **SONET TRIBSCAN** display.
The Scan can be started on the **TRANSMIT** **SONET** **TEST FUNCTION** display or the **RESULTS** display by choosing START.
If the Scan is started on the **TRANSMIT** **SONET** **TEST FUNCTION** display, the OmniBER 718 changes to the **RESULTS** display.
If a full-bandwidth concatenated payload is selected (e.g. an STS-48c within an OC-48), then Tributary Scan is disabled.

NOTE

The keyboard is locked during tributary scan.

Making Measurements

Performing a SONET Tributary Scan

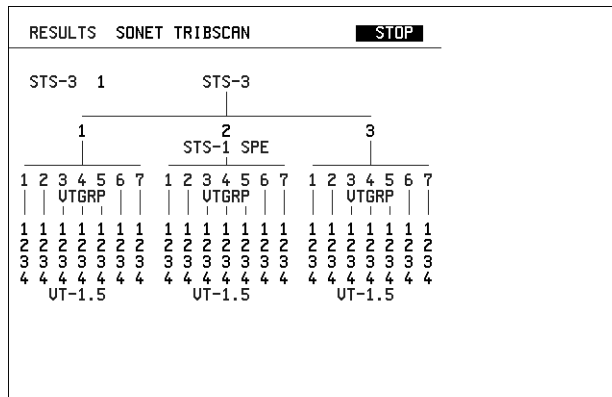

STATUS:
STOP

START

MULTIPLE
WINDOW

Making Measurements
Performing a SONET Alarm Scan

Performing a SONET Alarm Scan

Description

SONET Alarm Scan tests each channel for alarm free operation and identifies and indicates any Unequipped channels. You can configure the Scan to check for the occurrence of any Path layer CV errors above a chosen threshold. The channel in which an alarm occurred is highlighted if any of the following alarms occur:

- STS SPE:** LOP-P, RDI-P, AIS-P,
- VT-1.5:** LOP-P, AIS-P, RDI-P, H4 LOM, LOP-V, AIS-V, RDI-V

TIP:

The SONET Alarm Scan display can be logged to the chosen logging device. See "Logging on Demand " page 241.

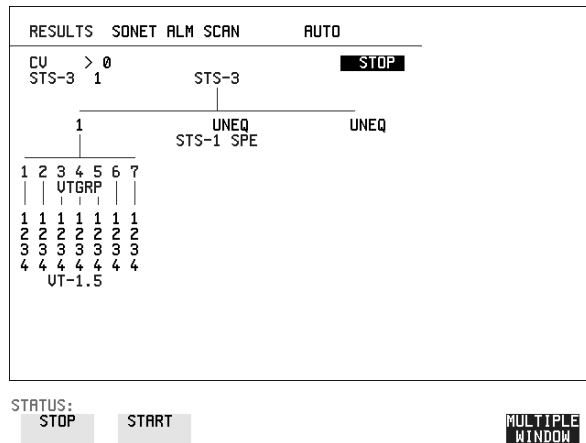

HOW TO:

- 1 Set up the receive SONET interface and payload as required. See "Setting SONET Receive Interface" page 47.
- 2 Choose **SONET ALM SCAN** on the **RESULTS** display.
- 3 Choose AUTO or RX SETTINGS.
 RX SETTINGS: The scan checks the structure set on the **RECEIVE SONET** display.
 AUTO: The scan checks the structure being received. This can be particularly useful when receiving mixed payloads.
- 4 Choose the CV error threshold.
- 5 Choose **START** to start the Alarm Scan.

Making Measurements

Performing a DS_n Alarm Scan

Performing a DS_n Alarm Scan

Description

DS_n Alarm Scan tests each channel for the following alarms:

- Frame Loss
- RAI
- AIS

The channel in which an alarm occurs is highlighted.

RESULTS	DS _n ALM SCAN							OFF
DS3	INTERFACE							
DS2	1	2	3	4	5	6	7	
DS1	1	2	3	1	2	1	1	
	2	3	4	2	3	2	2	
	3	4		3	4	3	3	
	4			4		4	4	

STATUS:
TROUBLE SCAN **TIMING CONTROL** **DS_n RESULTS** **DS_n ALM SCAN** **MORE** **MULTIPLE WINDOW**

HOW TO:

- 1 Set up the receive DS_n interface as required. See “Setting PDH/DS_n Receive Interface” page 45.
- 2 Choose **ON** to start the Alarm Scan.

Measuring Jitter

*Description:
Option 200 is
required for Jitter
operation.*

Jitter and error measurements are made simultaneously when a jitter option is fitted. Jitter measurements are also available when ATM or POS is selected as a payload.

Cumulative and Short Term results of Jitter Amplitude and Jitter Hits are provided on the **RESULTS** **JITTER** display.

Graph and Text results for Jitter Transfer and Jitter Tolerance are also provided.

LP, HP1 and HP2 filters to ITU-T O.171 and O.172 /Bellcore GR-499.

**Jitter
Measurement
Filters**

Bit Rate (kb/s)	HP1 (Hz)	HP2 (kHz)	LP (kHz)	HP rms (kHz)
1.544	10	8	40	12
2048	20	18	100	12
8448	20	80	400	12
34368	100	10	800	12
44736	10	30	400	12
51840	100	20	400	12
155520	500	65	1300	12
622080	1000	250	5000	12
2488320	5000	1000	20000	12

Please note that the instrument measurement bandwidth varies depending on the Receiver Range selected (i.e. the bandwidth is reduced when not on the 1.6 UI range). If you change the Receiver Range selection check the Filter Values displayed at the bottom right of the display meet your measurement requirements.

Rms jitter measurements settling time

If you select a PDH/DSn receiver interface and choose a O.172 /GR-499 Filter on the Receiver Input, Jitter page, please allow approximately 20 seconds settling time before performing a measurement.

Making Measurements

Measuring Jitter

NOTE

To obtain optimum performance while measuring jitter on optical signals ensure the signal optical power level is within the measurement window. See “Measuring Optical Power” page 115.

RESULTS	JITTER	CUMULATIVE
HITS	AMPLITUDE	
+VE PEAK		0.074UI
-VE PEAK		0.044UI
PEAK-PEAK		0.118UI
RMS		0.009UI
FILTERS		HP2
ELAPSED TIME		00d 00h 01m 14s

STATUS:

MULTIPLE WINDOW

HOW TO:

- 1 If measuring Jitter on a DS_n signal, set up the receive DS_n interface and the receive Jitter interface. See “Setting PDH/DS_n Receive Interface” page 45 and “Setting Jitter Receive Interface” page 48.
- 2 If measuring jitter on an SONET Optical signal, check on the **RESULTS** **SONET RESULTS** **OPTICAL POWER** display that the measured optical power level falls within the white portion of the colored bar. This ensures the accuracy of the Jitter results
- 3 If measuring Jitter on an SONET signal, set up the receive SONET interface and the receive Jitter interface. See “Setting SONET Receive Interface” page 47 and “Setting Jitter Receive Interface” page 48
- 4 If performing a Jitter Tolerance measurement, See “Measuring Jitter Tolerance” page 134. If performing a Jitter Transfer measurement, See “Measuring Jitter Transfer” page 138.
- 5 Press **RUN/STOP** to start the measurement.
- 6 You can view the Jitter hits and Amplitude results on the **RESULTS** **JITTER** display.

Measuring Extended Jitter

*Description:
Option 200 required
for Jitter
measurements.*

Extended Jitter measurements are made at the upper end of the standard wander frequency range and the lower end of the standard jitter frequency range.

When **EXTENDED** is chosen (on the Receiver Input Jitter page) Jitter results are provided. Cumulative and Short Term results of Jitter Amplitude and Jitter Hits are provided on the **RESULTS** **JITTER** display. The following Table gives the Extended range receiver measurement bandwidth.

Bit Rate (kb/s)	Range	Jitter measurement bandwidth*			
		F _L (Hz) lower 3dB point**	F _{MIN} (Hz)	F _{MAX} (kHz)	F _U (kHz) upper 3dB point
1544	256	0.15	1	0.2	0.25
2048	256	0.15	1	0.2	0.25
8448	256	0.15	1	0.2	0.625
34368	256	0.15	1	2	2.5
44736	256	0.15	1	5	6.25
51840	64	0.15	1	20	25
139264	256	0.15	1	5	6.25
155520	64	0.15	1	20	25
622080	256	0.15	1	20	25
2488320	1024	0.15	1	20	20

* The measurement accuracy is specified between F_{MIN} and F_{MAX} only.

** Nominal value.

Making Measurements

Measuring Extended Jitter

RESULTS	JITTER	CUMULATIVE
HITS	AMPLITUDE	
+VE PEAK		0.074UI
-VE PEAK		0.044UI
PEAK-PEAK		0.118UI
RMS		0.009UI
FILTERS		HP2
ELAPSED TIME		00d 00h 01m 14s

STATUS:

MULTIPLE
WINDOW

HOW TO:

- 1 If measuring Extended Jitter on a DS_n signal, set up the receive DS_n interface and the receive Jitter interface. See "Setting PDH/DS_n Receive Interface" page 45 and "Setting Extended Jitter Receive Interface " page 49.
- 2 If measuring Extended jitter on an SONET Optical signal, check on the **RESULTS** **SONET RESULTS** **OPTICAL POWER** display that the measured optical power level falls within the white portion of the colored bar. This ensures the accuracy of the Jitter results.
- 3 If measuring Extended Jitter on an SONET signal, set up the receive SONET interface and the receive Jitter interface. See "Setting SONET Receive Interface" page 47 and "Setting Extended Jitter Receive Interface " page 49.
- 4 Press **RUN/STOP** to start the measurement.

Measuring Wander

Description:

Wander is defined as the long-term variations of the significant instants of a digital signal from their ideal positions in time, where long-term implies phase oscillations of frequency less than or equal to a demarcation point that is specified for each interface rate. Refer to ANSI T1.102 for the demarcation frequencies for each digital signal.

Accurate Wander measurements require a Wander reference derived from a master timing external source. Connect your external timing source to the appropriate port on the instrument clock module. Wander results are displayed in UI or nanoseconds. Jitter Amplitude and Jitter Hits results are also available.

Problems may arise due to wrongly configured equipment running on internal clocks or at the junction of different operator's network equipment. Since the timing sources may operate at slightly different frequencies and exhibit long term frequency drift, phase difference (Wander) may occur between the incoming data and the network equipment. This causes "Bit Slips" in the network equipment buffers and results in frames being repeated or deleted thus reducing the efficiency of data transfer.

When wander is measured at DS1 or 2 Mb/s, Estimated Bit and Frame slips are calculated and a Bar Graph shows the cumulative Wander over the measurement period.

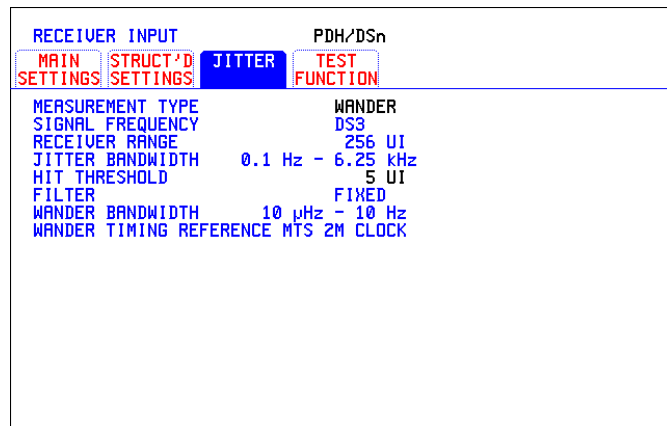

STATUS:



Making Measurements

Measuring Wander

HOW TO:

Make the Measurement

1 PDH/DSn Operation Wander Reference:

Select the **TRANSMIT** **PDH/DSn** **MAIN SETTINGS** display, and set the CLOCK field to **EXTERNAL**. Choose the CLOCK SOURCE required from the menu provided (i.e. MTS 2M CLOCK/DATA, MTS 64k CLOCK, BITS 1.5Mb/s and 10MHz REF). Connect your external timing source to the appropriate port on the instrument clock module. See “Setting PDH/DSn Transmit Interface (Option 012)” page 26.

2 SONET Operation Wander Reference

Select the **TRANSMIT** **SONET** **MAIN SETTINGS** display. and set the CLOCK field to **EXTERNAL**. Choose the CLOCK SOURCE required from the menu provided (i.e. MTS 2M CLOCK/DATA, MTS 64k CLOCK, BITS 1.5Mb/s and 10MHz REF). Connect your external timing source to the appropriate port on the instrument clock module. See, “Setting SONET Transmit Interface” page 29.

3 If measuring wander at a DS_n rate set up the DS_n receive interface. See, “Setting PDH/DS_n Receive Interface” page 45.

4 If measuring wander on an SONET Optical signal, check on the **RESULTS** **SONET RESULTS** **OPTICAL POWER** display that the measured optical power level falls within the white portion of the colored bar. This ensures the accuracy of the Wander results.

5 If measuring wander at a SONET rate set up the SONET receive interface. See, “Setting SONET Receive Interface” page 47.

6 Choose MEASUREMENT TYPE **WANDER**.

7 Choose the WANDER HIT THRESHOLD level - if the received wander exceeds the value chosen a wander hit is recorded.

8 Press **RUN/STOP** to start the measurement.

Making Measurements

Measuring Wander

HOW TO:

View the Results

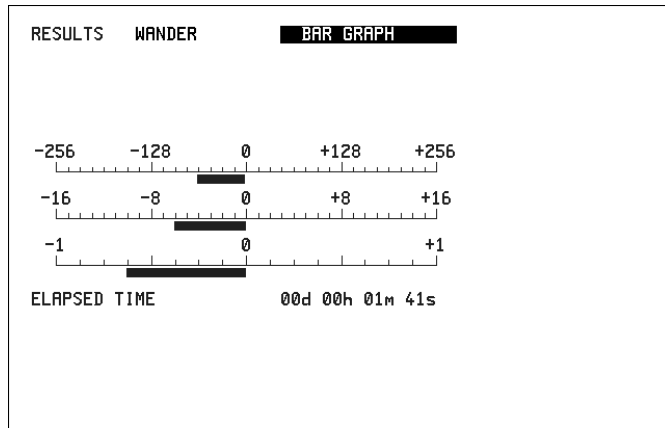

STATUS:

WANDER

BAR
GRAPH

MULTIPLE
WINDOW

- 1 Choose **WANDER** on the **RESULTS** display and choose the display units required:
 - TIME displays the wander results in nanoseconds.
 - UI displays the wander results in Unit Intervals
 - If you are measuring wander at 2 Mb/s Estimated Bit slips and Estimated Frame slip results are provided and a **GRAPH** choice is added to the menu.
 - If **GRAPH** is chosen the cumulative wander results are displayed in graphical form. The Graphs are additive and in the example shown above the Wander is -76.5 BITS. Graph is only available when a DS1 or 2Mb/s signal is selected.

NOTE

Estimated Bit Slips signify the slippage from the start of the measurement.
One Estimated Frame Slip corresponds to 256 Bit Slips.
Implied Frequency Offset is calculated from the Wander results.

Measuring Jitter Tolerance

Description:
Option 200 is required for Jitter measurement and 012 for PDH/DSn operation.

The jitter auto tolerance feature provides jitter tolerance measurements within the relevant DS1 and DS3 masks taken from Bellcore GR.499, Category 1 and Category 2 equipment and ITU-T G.824.

SONET masks are taken from BELLCORE GR-253 -CORE.

For SDH the masks provided are those specified in ITU-T G.958, type A or B, and in ITU-T G.825.

G.823 low and high Q systems are provided for PDH (2, 8, 34, 140 Mb/s).

The jitter auto tolerance feature is also available when ATM or POS is selected as a payload.

PDH/DSn User Selectable Masks

Line Rate	GR.499 CAT 1	GR.499 CAT 2	G.823	G.823 High Q	G.823 Low Q	G.824
2 Mb/s				√	√	
8 Mb/s				√	√	
34 Mb/s			√			
140 Mb/s			√			
DS1	√	√				√
DS3	√	√				√

SONET User Selectable Masks

Line Rate	GR.253	G.825	G.958 Type A	G.958 Type B
STS-1	√			
STS-3	√	√	√	√
STS-12	√	√	√	√
STS-48	√	√	√	√

Making Measurements

Measuring Jitter Tolerance

Jitter is generated at a range of frequencies within the mask and an error measurement is made. If no errors occur (PASS), the jitter amplitude at that frequency point is increased until errors occur (FAIL) or the maximum jitter amplitude is reached. The highest jitter amplitude at which PASS occurs is plotted on the graph as the Jitter Tolerance for that jitter frequency.

User-Programmable Masks

There are 5 user programmable masks provided allowing you to create, edit and title up to 5 jitter masks. Please refer to “To Generate a New Jitter Mask” on page 299 and “To change the parameters of a User Defined Jitter Mask” on page 301 for instructions on how to generate or edit a user programmable mask.

TIP:

The transmitter and receiver can be set to different rates to allow testing across multiplexers, for example transmitter set to STS-3 with embedded DS-3 and receiver set to DS-3.

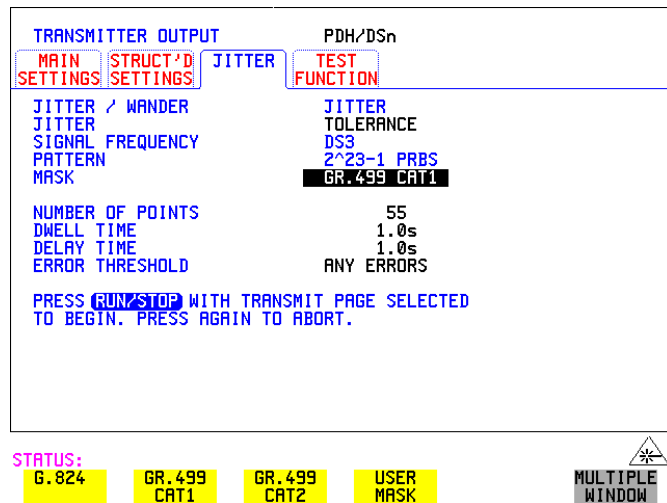

HOW TO:

Make the Measurement

PDH/DSn Interface

- 1 If you are performing jitter tolerance on the DS_n signal, set up the DS_n transmit and receive interfaces, including the test PATTERN. See “Setting PDH/DS_n Transmit Interface (Option 012)” page 26 and “Setting PDH/DS_n Receive Interface” page 45.
- 2 If you have chosen a PDH/DS_n interface now select the JITTER page and select

Making Measurements

Measuring Jitter Tolerance

AUTO TOLERANCE and a MASK (see display above). Proceed to step 6.

SONET Interface

- 3 If you are performing jitter tolerance on an SONET Optical signal, check on the **RESULTS** **SONET RESULTS** **OPTICAL POWER** display that the measured optical power level falls within the white portion of the colored bar. This ensures the accuracy of the Jitter results.
- 4 If you are performing jitter tolerance on the SONET signal, set up the SONET transmit and receive interfaces, including the required test PATTERN. See “Setting SONET Transmit Interface” page 29 and “Setting SONET Receive Interface” page 47.

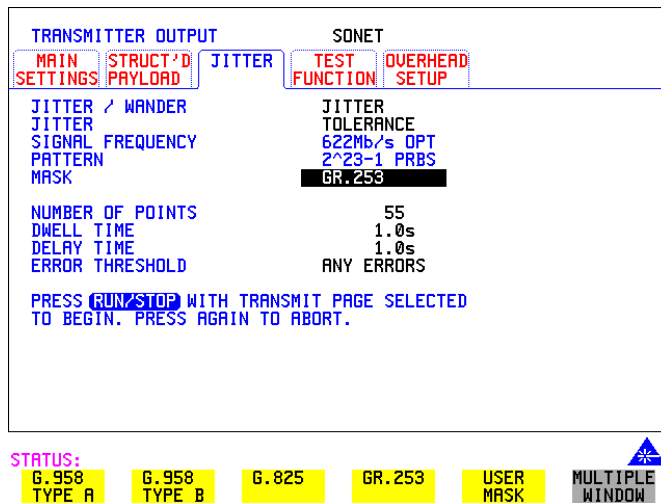

- 5 If you have chosen an SONET interface now select the JITTER page and select AUTO TOLERANCE and a MASK (see display above).

Steps common to PDH/DSn and SONET operation

- 6 Choose the NUMBER OF POINTS at which jitter is transmitted (3 to 55)
- 7 Choose the DWELL TIME - the time jitter is generated at each jitter frequency point (0.1 to 99.9 seconds).
- 8 Choose the DELAY TIME - the time delay between the jitter frequency/ amplitude being applied and the error measurement being made. This allows the network equipment to settle as jitter frequency is changed. (0.1 to 99.9 seconds).

Making Measurements

Measuring Jitter Tolerance

- Choose the ERROR THRESHOLD.
If ANY ERRORS is chosen, any BIP or BIT error will result in a FAIL.
If BIT ERRORS is chosen, choose a value between 1 and 1,000,000 to determine the bit error threshold for the jitter tolerance PASS/FAIL decision.
BER \geq shows the bit error ratio calculated from the bit error threshold choice and the dwell time choice.
- Press **RUN/STOP** to start the jitter auto tolerance measurement.
The measurements progress can be monitored on the **TRANSMIT** display. At the end of the test the results can be viewed on the **TRANSMIT** or **RESULTS** displays. The **TRANSMIT** display is cleared when **TRANSMIT** is pressed but the results remain on the **RESULTS** display until the next jitter tolerance measurement is made.

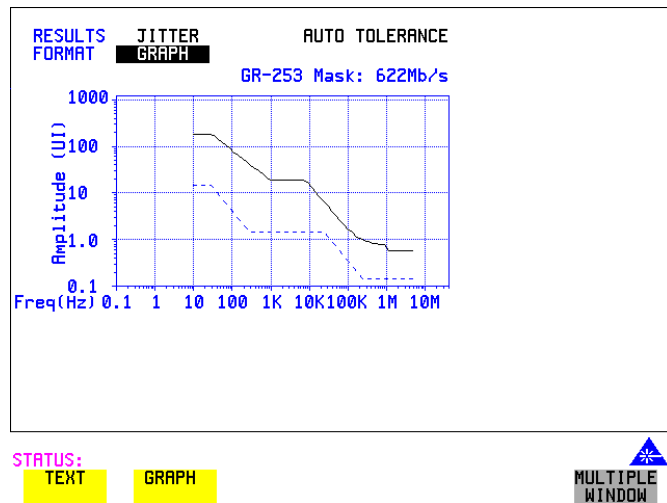

HOW TO:

View the Results

- Choose the results FORMAT.
If **GRAPH** is chosen, a plot of the jitter tolerance results against the ITU-T mask is displayed.
If **TEXT** is chosen, the results from which the graph is constructed are displayed, Point number, Frequency, Mask amplitude, Tolerance, Result.
If applicable, points 13 through 55 can be viewed on pages 2 through 5.

If you wish to log the jitter tolerance results to a printer, See “Logging Jitter Tolerance Results” page 245.

Measuring Jitter Transfer

Description:

Perform vital jitter transfer (gain) measurements using the OmniBER 718. With the OmniBER 718 you can perform Jitter transfer measurements at DS1, DS3 and each of the four PDH rates 2, 8, 34, 140 Mb/s, and also STS-1, STS-3, OC-1, OC-3, OC-12 and OC-48. Jitter Transfer measurements are also available when ATM or POS is selected as a payload.

Jitter transfer defines the ratio of output jitter amplitude to input jitter amplitude versus jitter frequency for a given bit rate. In network equipment some of the jitter present at the input port of a regenerator will be transmitted to the output port. On networks with cascaded equipment on long trunk routes it is important to limit jitter transfer.

The jitter generator provides the stimulus for the jitter transfer measurement. Automatic narrow band filtering is used in the jitter receiver this provides selection and measurement of the relevant jitter components to ensure accurate and repeatable results.

The jitter transfer results are presented in graphical and tabular form. Graphical results are plotted as Gain versus Frequency. The relevant Pass Mask for PDH/DSn or SONET is also displayed on the graph. Please refer to the OmniBER 718 Specifications book provided with your instrument for detailed information on Jitter Transfer input and pass masks.

NOTE

1. The Transmitter and Receiver must be set to the same interface rate.

HOW TO:

Achieve the required accuracy:

- 1 The OmniBER 718 must be connected back to back in order to perform a calibration cycle before making a Jitter Transfer measurement (see figure on next page). Use an optical attenuator to keep optical power at optimum level if you are performing tests on optical signals.

Making Measurements

Measuring Jitter Transfer

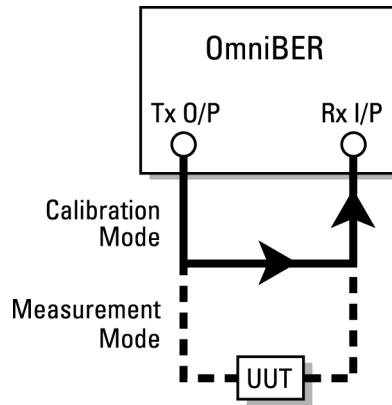

- 2 The OmniBER 718 must have been switched on for 1 hour before starting a calibration cycle.
- 3 The climatic conditions must remain stable from switch-on to end of measurement.
- 4 The Jitter Transfer measurement must be started within 10 minutes of completion of the Calibration.
- 5 If maximum Delay time, maximum Dwell time and maximum number of Points is selected, the accuracy specification cannot be guaranteed as the time from start of calibration to end of measurement (test period) will be approximately two hours. It is recommended that the maximum test period does not exceed 90 minutes.

Test Period = (Delay Time + Dwell Time + 5 Seconds) X Number of Points X 2 (Calibration + Measurement).

NOTE

For best results, a Dwell Time of 20 seconds and a Delay Time of 10 seconds, are recommended.

Making Measurements

Measuring Jitter Transfer

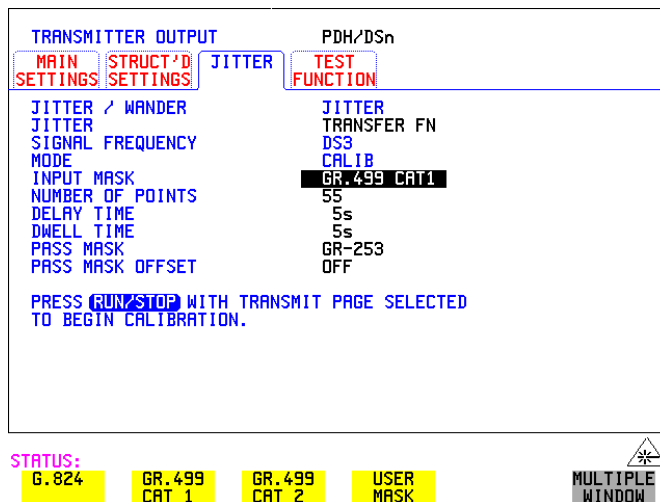

HOW TO:

Perform Jitter Transfer Calibration

NOTE

If a PDH/DSn interface is selected the CALIBRATION should always be carried out with LEVEL **TERMINATE** selected on the **RECEIVE MAIN SETTINGS** display.

- 1 If DS_n Jitter Transfer is required, set up the DS_n transmit and receive interfaces, the receive jitter interface and connect DS_n IN to DS_n OUT. See “Setting PDH/DS_n Transmit Interface (Option 012)” page 26, “Setting PDH/DS_n Receive Interface” page 45 and “Setting Jitter Receive Interface” page 48.
- 2 If you are performing jitter transfer on an SONET Optical signal, check on the **RESULTS SONET RESULTS OPTICAL POWER** display that the measured optical power level falls within the white portion of the colored bar. This ensures the accuracy of the Jitter results.
- 3 If OC-3, OC-12 or OC-48 Optical Jitter Transfer is required, set up the SONET transmit and receive interfaces, the receive jitter interface and connect the OUT port of the Optical module to the IN port of the Optical module. See “Setting SONET Transmit Interface” page 29, “Setting SONET Receive Interface” page 47 and “Setting Jitter Receive Interface” page 48.

CAUTION

If OC-3/12/48 SONET Jitter Transfer is required, a 15 dB attenuator must be connected between the IN and OUT ports of the Optical module.

Making Measurements

Measuring Jitter Transfer

4 If you wish to measure STS-1 or STS-3 electrical jitter transfer, set up the SONET transmit/ receive interfaces and the receive jitter interface and connect IN port to OUT port on the SDH module. See “Setting SONET Transmit Interface” page 29, “Setting SONET Receive Interface” page 47 and “Setting Jitter Receive Interface” page 48.

5 Choose JITTER **TRANSFER FUNCTION** on the **TRANSMIT** **JITTER** display.

6 Choose the INPUT MASK.

SONET operation

If measuring SONET jitter transfer, the Bellcore GR-253 mask can be High or Low. You can also select from 1 of 5 user programmable jitter masks see (**USER**) paragraph below.

GR-253 Low masks cover the lower frequency band.

GR-253 High masks cover the upper frequency band.

PDH/DSn operation

At DS1 and DS3 G.824 and GR.499 Cat1 and GR.499 Cat2 are provided. If measuring PDH jitter transfer at 2 Mb/s or 8 Mb/s a Q Factor choice is provided (G.823, High Q and G.823 Low Q). Your Q Factor choice should match the network equipment regenerator Q Factor.

At 34 and 140 Mb/s a G.823 jitter transfer input mask is offered.

If **USER** is chosen, choose the mask jitter frequencies, F1, F2, F3 and F4, and mask jitter amplitudes A1 and A2, see “To change the parameters of a User-defined jitter mask” page 301 for instructions on how to change the parameters of a user mask and “To Generate a New Jitter Mask” on page 299.

7 Choose the NUMBER OF POINTS at which jitter is transmitted (1 to 55)

8 Choose the DELAY TIME - the time delay between the jitter frequency/ amplitude being applied and the error measurement being made. This allows the network equipment to settle as jitter frequency is changed (5 to 30 seconds).

9 Choose the DWELL TIME - the Dwell Time is the test period spent at each amplitude/frequency point (5 to 30 seconds). The result recorded is the maximum peak-to-peak jitter detected during the Dwell Time test period.

10 Select a PASS MASK if a choice is given.

Pass Mask Offset

11 An offset in the range -2.00 dB to +2.00 dB in steps of 0.01 dB can be added to the selected Pass Mask. Select PASS MASK OFFSET and use the edit keys to select an offset. Select **END EDIT** when finished selecting an offset.

Making Measurements

Measuring Jitter Transfer

- 12 With MODE set to **CALIB** press **RUN/STOP** to start the calibration. The Jitter Transfer display is replaced by an information display for the duration of the Calibration. A bar graph showing the progress of the calibration will appear on the display. When the Calibration is complete, the display will revert to the **TRANSMIT** **JITTER** display.

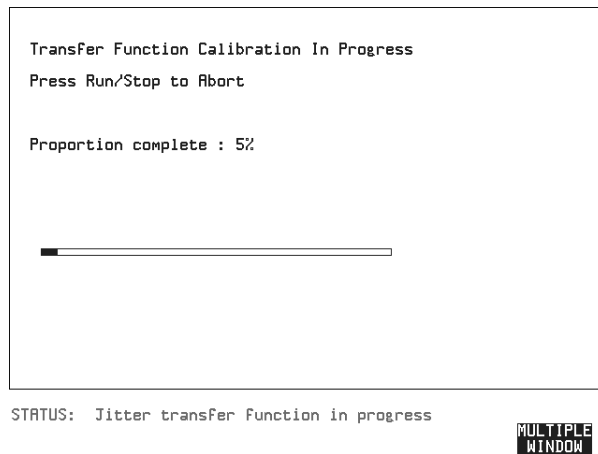

HOW TO:

Start the Jitter Transfer Measurement

NOTE

The Jitter Transfer measurement must be started within 10 minutes of the completion of calibration.

- 1 After the CALIBRATION is completed, remove the back to back connection from the DS_n or SONET or optical interfaces, and connect to the system under test. If the measurement is to be made at a network equipment monitor point, choose **MONITOR** on the DS_n or SONET **RECEIVE** **MAIN SETTINGS** display before making the jitter transfer measurement.
- 2 Choose MODE **MEASURE** on the **TRANSMIT** **JITTER** display and press **RUN/STOP**. The measurement's progress can be monitored on the **TRANSMIT** display.

HOW TO:

View the Results

- 1 Select **RESULTS**, **JITTER** and **TRANSFER FN**, then choose the results FORMAT.

Making Measurements

Measuring Jitter Transfer

If **GRAPH** is chosen, a plot of the jitter transfer results against the ITU-T mask is displayed.

If **TEXT** is chosen, the results from which the graph is constructed are displayed:
 Point number, Frequency, Mask amplitude (dB), Jitter Gain (dB), Result.
 If applicable, points 13 through 55 can be viewed on pages 2 through 5.

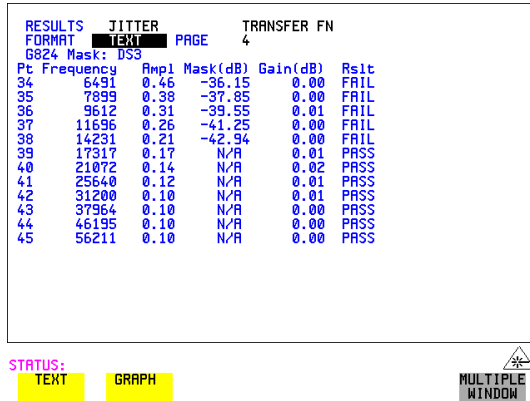

- If **GRAPH** is chosen, choose the SCALE required.
WIDE provides a vertical axis range of +5 to -60 dB and is recommended for viewing the high frequency portion of the graph. This allows a clearer view of the difference between the actual result and the ITU-T pass mask.
NARROW provides a vertical axis range of +3 to -3 dB and is recommended for viewing the low frequency portion of the graph. This allows a clearer view of the difference between the actual result and the ITU-T pass mask.

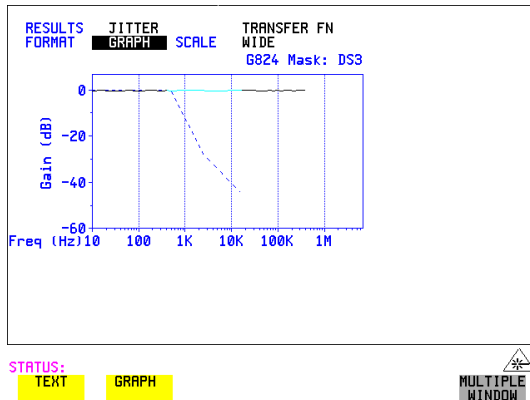

- If you wish to log the jitter tolerance results to a printer, See “Logging Jitter Transfer Results” page 247.

Measuring Pointer Adjustment (Tributary) Jitter

Introduction

During the transition from a PDH network to mixed PDH/SONET networks new sources of jitter emerge, caused by the mapping process and network synchronization problems. This new jitter may result in pointer adjustments which in turn cause tributary jitter at the PDH output ports of the network element.

Pointer Adjustment Jitter

Jitter resulting from pointer adjustments is transient in nature, relatively high in amplitude, and most of the energy is contained in low frequency components.

GR-253 CORE recommendations define a set of pointer sequences when evaluating NE's pointer adjustment jitter performance. These sequences are designed to emulate the pointer activity that results from incorrect synchronization within a network element.

The OmniBER Transmitter can generate the test sequences recommended by ANSI T1.105.03, Bellcore GR-253-CORE and ITU-T G.783. Use these sequences to stress the system under test for correct levels of tributary jitter.

Refer to "Adding Pointer Adjustments" on page 85 for instructions on how to add pointer adjustments and detailed explanations of the pointer sequences provided by the OmniBER.

Making Measurements

Measuring Pointer Adjustment (Tributary) Jitter

I Bellcore GR-253/T1.105.03 Jitter Specification

Payload	Pointer	Sequence	Measurement bandwidth	Max. Jitter (UI p-p)
1.5 Mb/s	VT 1.5	E, F	0.01 to 40 kHz*	1.5
2 Mb/s	VT 2	A, B, C A, B, C	0.02 to 100 kHz * 18 to 100 kHz **	0.4 0.075
34 Mb/s	STS-1 SPE	A, B, C D A, B, C, D	0.1 to 800 kHz * 0.1 to 800 kHz * 10 to 800 kHz **	0.4 0.75 0.075
45 Mb/s	STS-1 SPE	E, F, G, H	Note 1.	Note 1.
140 Mb/s	STS-3c SPE	A, B, C D, G A, B, C, D, G	0.02 to 3500 kHz * 0.02 to 3500 kHz* 10 to 3500 kHz **	0.4 0.75 0.075

*denotes LP + HP1 filters. ** Denotes LP + HP2 filters;
Note 1 These values are for further study by ITU-T.

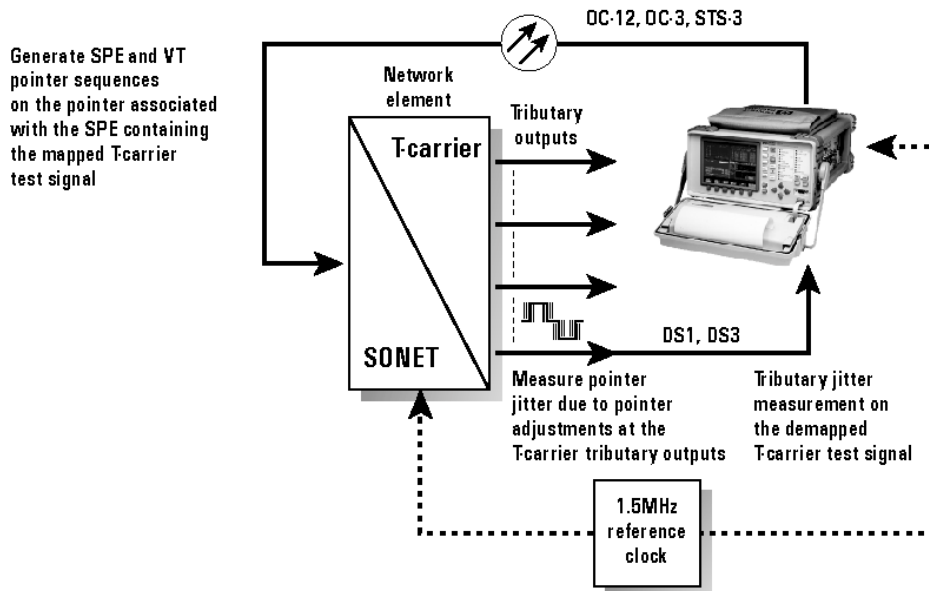

Typical tributary jitter test setup

Making Measurements

Measuring Pointer Adjustment (Tributary) Jitter

HOW TO:

- 1 Connect the OmniBER to the Network Element as shown in the previous Figure. Ensure the OmniBER and the NE are synchronized.
- 2 Select the **OTHER** **SETTINGS CONTROL** page and choose TRANSMITTER AND RECEIVER **INDEPENDENT**.
- 3 Select **RECEIVE**, **MAIN SETTINGS**, **PDH/DSn** and select a PDH/DSn SIGNAL rate (DS1, DS3, 140, 34, 8, 2 Mb/s).
- 4 On the same page set the required test pattern from the PATTERN field.
- 5 On the **TRANSMIT**, **SONET**, **MAIN SETTINGS** page select a SIGNAL rate (the rates available depend on the options fitted to your instrument). In this example we have selected OC-48.
- 6 On the same page, now set the Transmitter DSn payload offset (DS3 OFFSET field in figure below) to any in-range value.

TRANSMITTER OUTPUT		SONET		
MAIN SETTINGS	STRUCT'D PAYLOAD	JITTER	TEST FUNCTION	OVERHEAD SETUP
SIGNAL	OC-12	1310	ON	INTERNAL
CLOCK	INTERNAL			
FREQUENCY OFFSET	OFF			
MAPPING	<input checked="" type="checkbox"/> STS-1			FOREGROUND FULL SPE DS3
DS3 OFFSET				+12 ppm
STS-3#	1	STS-1#	1	
PAYLOAD TYPE	UNFRAMED			UNSTRUCTURED
PATTERN	Z ²³ -1 PRBS			INVERT

STATUS: DECREASE DIGIT INCREASE DIGIT ← → MULTIPLE WINDOW

- 7 Select **TRANSMIT**, **SONET**, **TEST FUNCTION**, then select **SONET ADJUST PTR**.
- 8 Setup and run pointer sequence A (see page 85 for information on the pointer sequences available). When the pointer sequence initialization and cool-down periods are finished and the display indicates "POINTER SEQUENCE - IN PROGRESS" proceed to step 9.

Making Measurements

Measuring Pointer Adjustment (Tributary) Jitter

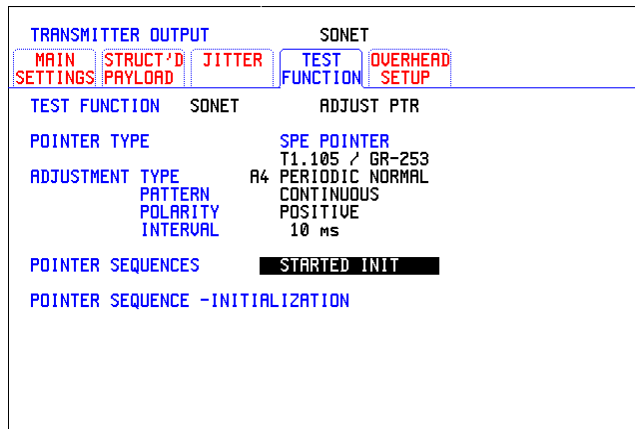

STATUS:
STOP



- 9 Select **RESULTS**, **TIMING CONTROL** and set TEST TIMING to **SINGLE** and a period of 20 seconds.
- 10 Set the jitter measurement range to 1.6 UI and measurement filter to LP+HP1, as shown below.
- 11 Press **RUN/STOP** to start the measurement.

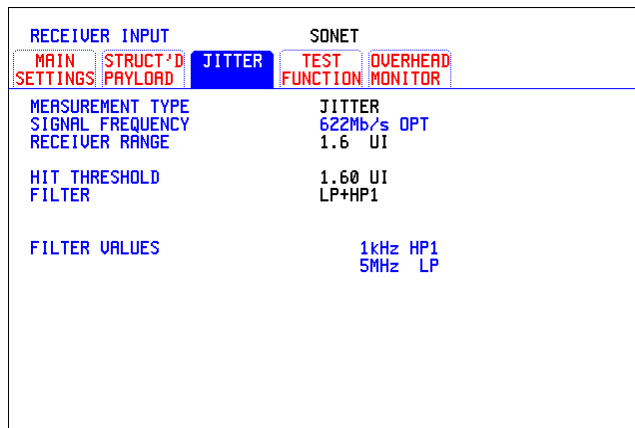

STATUS:



- 12 Verify that no alarms or errors are detected by the OmniBER receiver.

Making Measurements

Measuring Pointer Adjustment (Tributary) Jitter

- 13 Set the **RESULTS**, **JITTER** page to **CUMULATIVE** and AMPLITUDE.
- 14 Measure and record peak-to-peak jitter from ten consecutive measurement periods.
- 15 Change the filter setting to LP+HP2, and repeat step 13.
- 16 Repeat the above procedure for pointer sequences B, C, D, E, F and G as required.

"Setting up the Transmitter for ATM Payloads " page 150

"Setting up the Convergence Sublayer " page 153

"Setting Foreground Traffic " page 155

"Transmitting ATM Alarms " page 161

"Adding ATM Errors " page 163

"Viewing ATM Results " page 165

"Setting up the Receiver for ATM Payloads " page 166

"Setting up the Receiver ATM signal " page 168

"Policing ATM Traffic " page 170

"Measuring ATM Delay Performance " page 172

"Measuring ATM Alarms " page 175

"ATM Service Disruption " page 176

ATM Operation

For ATM operation you must have option 300 installed.
Option 300 offers ATM up to 2.5 Gb/s.

ATM Operation

Setting up the Transmitter for ATM Payloads

Setting up the Transmitter for ATM Payloads

Description

The transmitter rate and mapping can be set up to match the requirements of the ATM network under test. Select a SONET rate from STS-1 to OC-48 or a DS_n rate of DS-3 or DS-1.

TIP

To set the Transmitter and Receiver to the same interface settings choose **OTHER SETTINGS CONTROL COUPLED**.

NOTE

For ATM in PDH/DS_n you must select ATM in the Receiver before it can be selected in the Transmitter (unless the instrument is coupled).

Note ATM Mappings are performed using ITU-T Recommendation G.707 and G.804 and ATM Forum physical layer specifications.

The screenshot displays the configuration interface for the Transmitter and Receiver. The interface is divided into four main sections:

- TRANSMITTER OUTPUT (SONET):** Includes tabs for MAIN SETTINGS, STRUCT'D PAYLOAD, ATM SETTINGS, JITTER, and MORE. The SIGNAL is set to OC-48, CLOCK to INTERNAL, and FREQUENCY OFFSET to OFF. The MAPPING is set to STS-48C, and the foreground FULL SPE is set to ATM.
- RECEIVER INPUT (SONET):** Includes tabs for MAIN SETTINGS, STRUCT'D PAYLOAD, ATM SETTINGS, JITTER, and MORE. The SERVICE is set to CBR, and the PEAK CELL RATE is 800134 cells/s. The CDV TOLERANCE is 10 μs.
- RESULTS TROUBLE SCAN:** Shows NC CELLS as 7.905E+06 and ELAPSED TIME as 00d 00h 00m 01s.
- FUNCTION SETTINGS CONTROL:** Shows TRANSMITTER AND RECEIVER as COUPLED, RECEIVER COUPLED TO TRANSMITTER, and ATM HEADER VALUES NOT COUPLED.

Below the interface, there is a hint: "HINT: Press SET for popup application diagram". At the bottom, there are two status indicators: "BULK FILLED" and "ATM", and a "SINGLE WINDOW" button.

How to

- 1 On the **TRANSMIT** page select from **PDH/DS_n**, **SONET** or **SDH**.
- 2 Select the SIGNAL rate. (If you selected a PDH/DS_n interface and have not coupled the Transmitter and Receiver, have you selected ATM in the Receiver first?).
- 3 Select required MAPPING and then select **ATM**.

ATM Operation

Setting up the Transmitter for ATM Payloads

Use **SET** to bring up the popup application diagram (only applies to SDH/SONET mapping). This allows an alternative way of selecting the appropriate mapping.

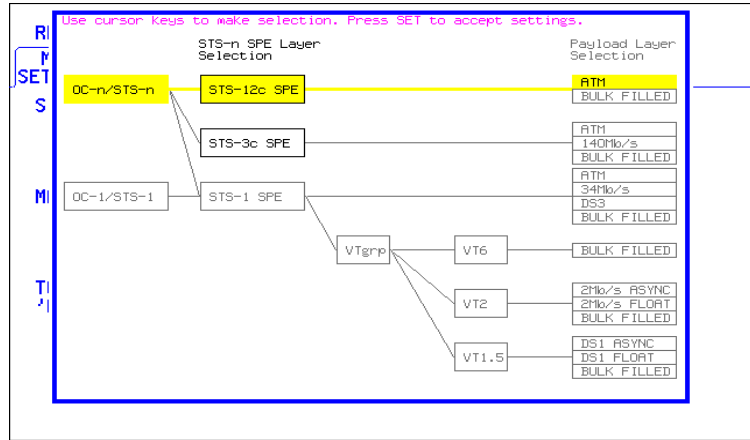

STATUS:



ATM Operation
Setting up the Transmitter for ATM Payloads

Table 4

ATM availability with PDH/DSn and SONET Signal Rates and Framing

Signal Rate	Framing Type	Is ATM available?
DS3	CBIT M13	yes no
DS1	ESF D4 SLC96	yes no no
2 Mb/s	PCM30 PCM30CRC PCM31 PCM31CRC	yes yes no no
8Mb/s	-----	no
34 Mb/s	G.832 Framed	yes no
SONET	ATM is available into all SPE mappings, but not into a VT structure.	

ATM Operation

Setting up the Convergence Sublayer

Setting up the Convergence Sublayer

Description

Setting up the Convergence Sublayer allows the test signal to be set to suit the ATM network under test.

How to

- 1 Set up the Transmitter for ATM in the MAIN SETTINGS folder (See "Setting up the Transmitter for ATM Payloads " page 150").
- 2 Select the **ATM SETTINGS** folder.

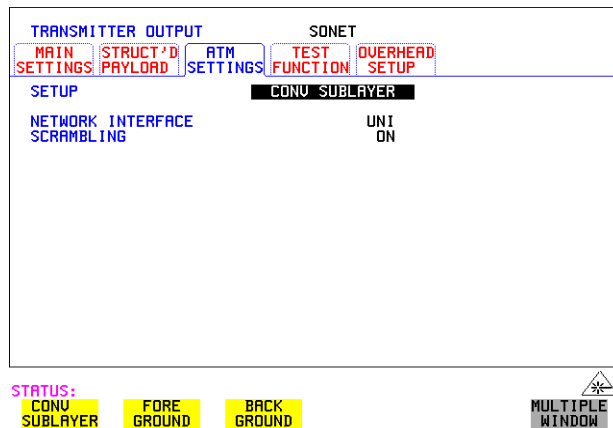

- 3 Select SETUP as required.
- 4 If **CONV SUBLAYER** is selected then the NETWORK INTERFACE can be selected as **UNI** or **NNI** and the SCRAMBLING can be turned on or off. For most applications ATM scrambling should be left on. If a DS3 interface and CBIT framing is selected an additional field CONVERGENCE SUBLAYER can be set to **DIRECT** or **PLCP**.

Network Interface

The cell header format used at the User Network Interface (UNI) and Network Node Interface (NNI) differs. The UNI has a Generic Flow Control field which can be used for Media Access Control (MAC) functions to transmit cells over shared media systems, while the NNI uses these four extra bits for extra path addressing.

ATM Operation
Setting up the Convergence Sublayer

Cell Header at UNI

Bits								
8	7	6	5	4	3	2	1	Bytes
GFC				VPI				1
VPI				VCI				2
VCI								3
VCI				PTI		CLP		4
HEC								5

Cell Header at NNI

Bits								
8	7	6	5	4	3	2	1	Bytes
VPI								1
VPI				VCI				2
VCI								3
VCI				PTI		CLP		4
HEC								5

GFC - Generic Flow Control

VPI - Virtual Path Identifier

VCI - Virtual Channel Identifier

PTI - Payload Type

CLP - Cell Loss Priority

HEC - Header Error Control

Setting Foreground Traffic

Description

There are one foreground and seven background ATM channels available for testing. The backgrounds are used to simulate real traffic which can be routed differently to the foreground channel. The foreground is the test channel you use to stress the system under test.

Refer to page 157 for a description of how to set up background traffic. The relative distribution of background and foreground is described on page 158.

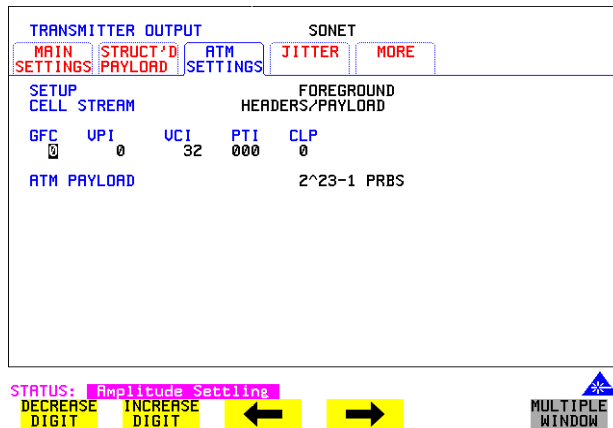

How To

Foreground Setup

- 1 Set up the Transmitter for ATM in the MAIN SETTINGS folder (See "Setting up the Transmitter for ATM Payloads " page 150").
- 2 Select **TRANSMIT** and the **ATM SETTINGS** folder as shown above, and set the SETUP field to **FOREGROUND**. Set the ATM header as required using the cursor keys.
- 3 Select an ATM Payload from the choices offered.
To make a range of error measurements on your connection, select **TEST CELL** as the payload in the transmitter and the receiver. This allows the measurement of cell errors, cell loss, cell misinsertion and cell delay simultaneously. For a simple BER measurement you can select **PRBS** or **USER** byte. When making a jitter tolerance measurement, select **PRBS**.

ATM Operation
Setting Foreground Traffic

**Test Cell
Explanation**

Simultaneous measurement of all ATM performance parameters can be made using a special-purpose test cell. The test cell is described in ITU 0.191. The cell payload consists of a 4-byte sequence number (SN) which is used to detect lost or misinserted cells, a 4-byte timestamp (TS) which is used for cell delay and CDV measurements, a 1 byte test cell payload type (TCPT) and a 2-byte CRC-16 which is used for error detection and protection of the sequence number and timestamp.

An example of the test cell is given below.

Test Cell

header 5 bytes	SN 4 bytes	TS 4 bytes	Unused 37 bytes	TCPT 1 byte	CRC-16 2 bytes
-------------------	---------------	---------------	--------------------	----------------	-------------------

ATM Operation

Setting Background Traffic

Setting Background Traffic

Description

You can select up to seven background channels which can be used to represent typical ATM traffic. The background channels are non-test channels and are used to fully load the element under test.

TRANSMITTER OUTPUT				SONET		
MAIN	STRUCT'D	ATM	TEST	OVERHEAD		
SETTINGS	PAYLOAD	SETTINGS	FUNCTION	SETUP		
SETUP				BACKGROUND		
CELL STREAM				HEADERS		
BG	GFC	UPI	UCI	PTI	CLP	
1	00	1	32	000	0	
2	00	2	32	000	0	
3	00	3	32	000	0	
4	00	4	32	000	0	
5	00	5	32	000	0	
6	00	6	32	000	0	
7	00	7	32	000	0	

STATUS:

CONU
SUBLAYER

FORE
GROUND

BACK
GROUND

MULTIPLE
WINDOW

How To

- 1 Set the SETUP field to **BACKGROUND**.
- 2 Set CELL STREAM to **HEADERS** and set up the Background Headers as required, using the cursor keys to navigate through the header fields.

Setting Foreground and Background Distributions

Description

The ATM Forum has defined the following Service Categories:

- Constant Bit Rate (CBR)
- Variable Bit rate (VBR)
- Unspecified Bit Rate (UBR)
- Available Bit Rate (ABR)

Data carried within each of these Service Categories will be policed within the network to ensure that the traffic does not exceed the bandwidth negotiated. This ensures that the quality of service can be met and that other traffic is not degraded.

In the OmniBER 718 the distribution of the ATM cells in the data stream can be set up to give CBR, VBR and single burst to simulate typical ATM traffic. Note that Background distributions are CBR. You can select the transmit cell rate in steps of 1 cell per second up to the maximum cell rate, giving you precise and accurate cell rates for performance tests and verifying ATM policing functions.

Because UBR is policed in a similar manner to CBR, a CBR signal can be used to represent UBR data. In ABR, dynamic control of the signal bandwidth is provided by resource management cells. However, a limited error performance test may be performed using a fixed bandwidth CBR signal.

The screenshot shows a configuration window for 'TRANSMITTER OUTPUT' with a 'SONET' section. The 'ATM SETTINGS' tab is selected, and the 'FOREGROUND DISTRIBUTION' sub-tab is active. The 'CELL STREAM SERVICE' is set to 'CBR'. The 'PEAK CELL RATE' is 114114 CELLS/S, which corresponds to 48384 KBITS/S. The 'CDU TOLERANCE' is set to 20 μs. At the bottom, there are status indicators for 'CONU SUBLAYER', 'FORE GROUND', and 'BACK GROUND', along with a 'MULTIPLE WINDOW' icon.

CELL STREAM SERVICE	CELLS/S	KBITS/S
CBR	114114	48384

CDU TOLERANCE: 20 μs

STATUS: CONU SUBLAYER FORE GROUND BACK GROUND MULTIPLE WINDOW

Setting Foreground and Background Distributions

Setting up foreground

How to

- 1 Set up the Transmitter for ATM (See "Setting up the Transmitter for ATM Payloads " page 150).
- 2 In the **ATM SETTINGS** folder select SETUP as **FOREGROUND**, CELL STREAM as **DISTRIBUTION** and then the traffic parameters for the Virtual Channel (VC) under test can be set up.
- 3 **Service Selections:**
For Constant Bit Rate (CBR) traffic, select the PEAK CELL RATE and CDV tolerance.
For Variable Bit Rate (VBR) traffic, select the SUSTAINABLE CELL RATE, PEAK CELL RATE, MAXIMUM BURST SIZE and CDV tolerance. The OmniBER then automatically generates worst case user traffic for the VC under test using the 0.191 enhanced traffic generator algorithm.
For error performance measurement, set the CDV tolerance value to its minimum value.
Select SINGLE BURST to transmit a burst of cells at the selected cell rate.

NOTE

The CDV tolerance value cannot be set to zero. The minimum value reflects the inherent CDV that is generated due to the segmentation and mapping of the ATM cell stream into the physical interface.

To fully stress the policing functions of the VC under test, the CDV tolerance can be set to the value used in the policing function.

Peak Cell Rate

For CBR, the peak cell rate is the average rate at which cells will be transmitted. Because the selected cell rate is implemented by a series of discrete cell events, for arithmetical reasons there will be some unavoidable deviation from ideal periodic timing. This effect is small.

Cell Delay Variation Tolerance (CDVT)

The transmitter will generate a signal which has a cell delay variation as set by the user in order to test a receiver's cell delay variation tolerance.

Sustainable Cell Rate

For VBR, this is the long term average cell rate being transmitted.

ATM Operation

Setting Foreground and Background Distributions

Burst Size

This is the number of cells transmitted at the peak cell rate a value which may vary from the selected value due to cell delay variation.

Setting up background

How To

- 1 Selecting the SETUP as **BACKGROUND** and CELL STREAM as **PAYLOAD/DISTRIBUTION** allows the 7 backgrounds to be set up. The payload can be set up as an 8-bit user-selectable pattern for each background. The number of cells per second on each background can also be set. This is limited by the bandwidth which is occupied by the foreground. Setting a unique value in the payload byte for each background can help you to trace and identify cell streams later.

TRANSMITTER OUTPUT		SONET		
MAIN SETTINGS	STRUCT'D PAYLOAD	ATM SETTINGS	TEST FUNCTION	OVERHEAD SETUP
SETUP		BACKGROUND		
CELL STREAM		PAYLOAD/DISTRIBUTION		
FOREGROUND		%BW	99.9	
BG	PAYLOAD	CELLS/S	KBITS/S	
1	00000001	0	0	
2	00000010	0	0	
3	00000011	0	0	
4	00000100	0	0	
5	00000101	0	0	
6	00000110	0	0	
7	00000111	0	0	
FILL	IDLE	%BW	0.1	

STATUS: HEADERS PAYLD/DISTR MULTIPLE WINDOW

Note

If there is any extra bandwidth left over after the foreground and background are filled with FILL CELLS, you can select between IDLE or UNASSIGNED Cells to fill the remaining cells.

Transmitting ATM Alarms

Description

You can generate VP and VC AIS and RDI alarms to verify the response of the ATM Network under test, and also generate VP and VC Continuity check cells to keep the circuit alive during bursty traffic conditions.

Types of alarms available are: VP-AIS, VP-RDI, VP-CC, VC-AIS, VC-RDI and VC-CC. The following tables show the expected responses of ATM VP and VC switches to input conditions.

Downstream Alarms

Stimulus	Response: VP switch	Response: VC switch
LOS, LOF, LOP	VP-AIS	VC-AIS
MS-AIS, Path AIS	VP-AIS	VC-AIS
LCD	VP-AIS	VC-AIS
VP-LOC	VP-AIS	VC-AIS
VP-AIS	VP-AIS	VC-AIS
VC-LOC	none	VC-AIS
VC-AIS	none	VC-AIS

Upstream Alarms

Stimulus	Response: VP switch	Response: VC switch	Response: VC end point
LOS, LOF, LOP	MS-RDI	MS-RDI	MS-RDI
MS-AIS, Path AIS	Path RDI	Path RDI	Path RDI
LCD	Path RDI	Path RDI	Path RDI
VP-LOC	none	VP-RDI	VP-RDI
VP-AIS	none	VP-RDI	VP-RDI
VC-LOC	none	none	VC-RDI
VC-AIS	none	none	VC-RDI

ATM Operation

Transmitting ATM Alarms

The following figure illustrates an example where the ability of a network element to recognize and respond to AIS and RDI alarms is tested.

AIS/RDI Alarm Testing

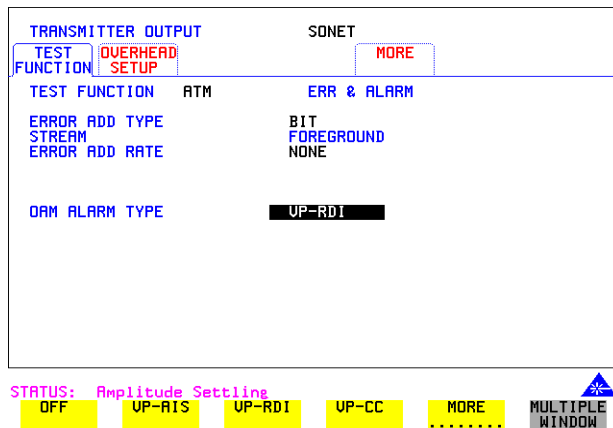
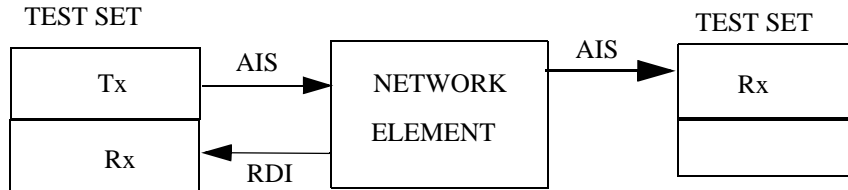

How to

- 1 Set up the Transmitter for ATM (See "Setting up the Transmitter for ATM Payloads " page 150).
- 2 Select the Transmitter **TEST FUNCTION** folder, and select TEST FUNCTION as **ATM** .
- 3 Move the down cursor to OAM ALARM TYPE and select the alarm you require to test your network element.

OAM cells are transmitted when the OAM ALARM TYPE has an alarm selected. For VP or VC AIS any channel with the same VP or VC is suspended and the OAM cell is transmitted once per second. For VP or VC RDI the OAM cell is interspersed with the foreground channel.

Adding ATM Errors

Description

Errors can be added to the ATM payload and to the cell headers. To stress ATM header alignment, you can add bursts of single or double header errors. To simulate ATM impairments, you can add bit errors, cell loss, cell misinsertion or cell errors.

Cell loss may be caused by transmission errors on the ATM header or more importantly may arise due to congestion in ATM switches. *Cell misinsertion* may also be caused by transmission errors on the ATM overhead. If errors cause the VP/VC to be changed to another valid value, this will cause a cell to be misinserted into another channel. Also, faults within the routing tables or management system of an ATM switch may cause cells to be routed to the wrong output port, appearing as misinserted cell. *Cell errors* caused by transmission impairments or faults within Network Equipment need to be measured in a different way from bit errors to ensure that lost or misinserted cells do not corrupt the measurement.

In order to make the necessary ATM measurements a different kind of test signal than that traditionally used to measure BER is required. This test signal is known as the *test cell* and has been designed and endorsed by the ATM Forum and standardized in the ITU-T in Recommendation 0.191. OmniBER uses the test cell to make simultaneous ATM error measurements.

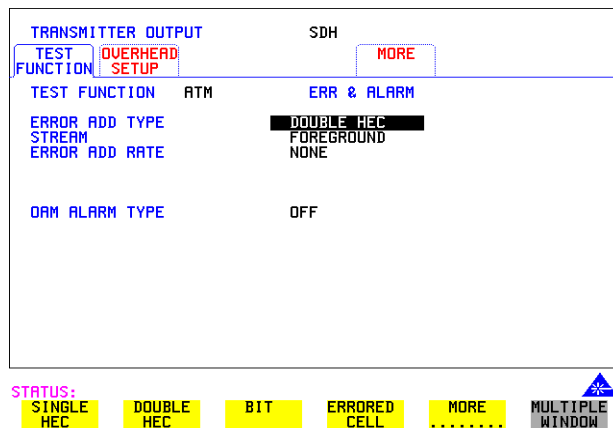

How to

- 1 Set up the **TRANSMIT** page for ATM (See "Setting up the Transmitter for ATM Payloads " page 150).
- 2 Move to the **TEST FUNCTION** folder and select TEST FUNCTION to be

ATM Operation

Adding ATM Errors

ATM.

- 3 Move the down cursor to ERROR ADD TYPE and select the Error Type you require.

Note

When you select **ALL** in the STREAM field an additional field appears which allows you to introduce a burst of errors.

To Verify HEC Function

- 1 Add SINGLE HEC errors and verify that the Network Element corrects these errors
- 2 Add DOUBLE HEC errors and verify that a lost cell is recorded for each Double HEC error. (To measure lost cells, select TESTCELL as the payload.
- 3 Add a burst of 2 SINGLE HEC errors and verify that one lost cell is recorded. The first error is corrected; the second is not.
- 4 Add a burst of 7 DOUBLE HEC errors and verify that LCD occurs in the Network Element.

Viewing ATM Results

Description

The ATM results can be viewed in a variety of ways on the RESULTS page.

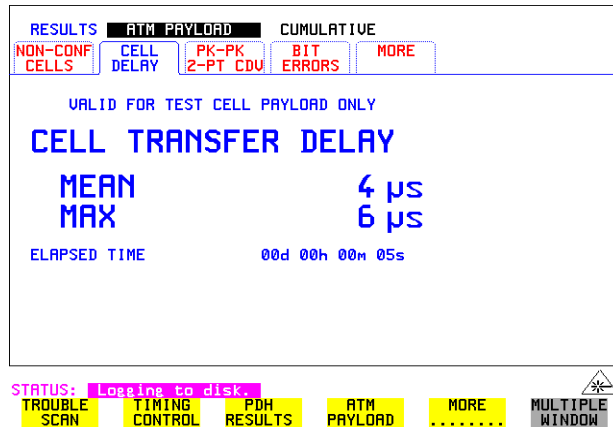

How to

- 1 Press the **RESULTS** key.
- 2 Select **ATM PAYLOAD** in the RESULTS field.
- 3 Move the right cursor to select the different types of errors and alarms.
- 4 **ERROR SUMMARY** gives a summary of all possible ATM errors and can be set up to be read as counts (total in measurement interval) or ratios/rates.
- 5 **CUMULATIVE** errors give the number of errors which have occurred in total since the last time **RUN/STOP** was pressed. **SHORT TERM** errors give the number of errors which have occurred in the last measurement interval. This measurement interval is set up on the results page when **TIMING CONTROL** has been selected in the RESULTS field.
- 6 **ALARM SECONDS** is used to look at ATM alarms.

Setting up the Receiver for ATM Payloads

Description

The receiver rate and mapping can be set up to match the requirements of the ATM network under test. Select a SONET rate from STS-1 to OC-48 or a DSn rate of DS-3 or DS-1.

TIP

To set the Transmitter and Receiver to the same interface settings choose **OTHER SETTINGS CONTROL** COUPLED.

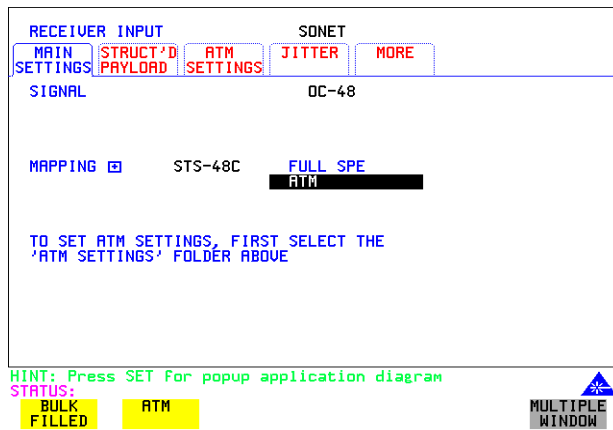

How to

- 1 Press **RECEIVE** and select from **PDH/DSn** , **SONET** or **SDH** .

ATM Operation

Setting up the Receiver for ATM Payloads

- 2 Select the SIGNAL rate.
- 3 Select required MAPPING with ATM as a payload.
Use **SET** to bring up the popup application diagram (only applies to SDH/SONET mapping). This allows an alternative way of selecting the appropriate mapping. Use the cursor keys to navigate through the popup application diagram.

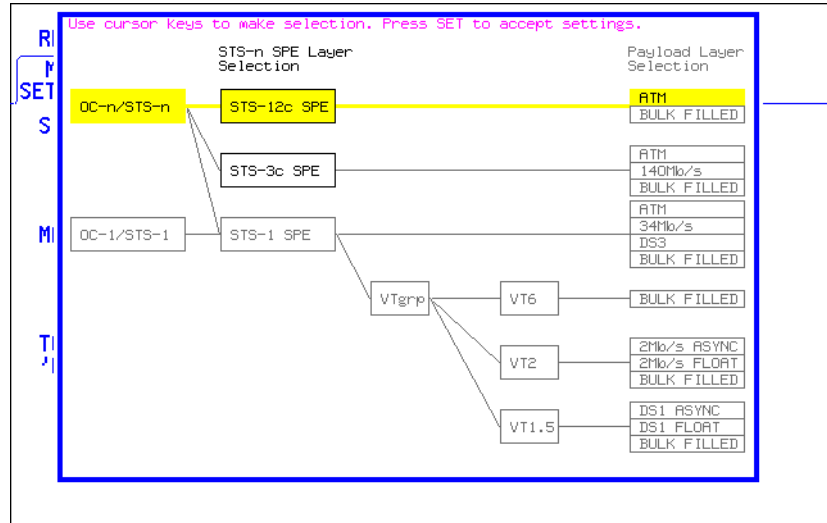

STATUS:



ATM Operation

Setting up the Receiver ATM signal

Setting up the Receiver ATM signal

Description

The setup of the ATM settings allow the user to tailor the test signal to suit the network under test.

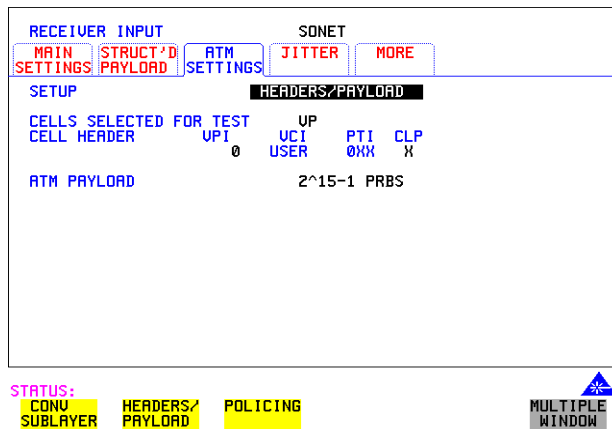

How to

- 1 Select the Receive rate and mapping. (See "Setting up the Receiver for ATM Payloads " page 166).
- 2 Select the **ATM SETTINGS** folder.
- 3 Select SETUP as **CONV SUBLAYER**, **HEADERS/PAYLOAD** or **POLICING** (See "Policing ATM Traffic " page 170).
- 4 If **CONV SUBLAYER** is selected then the network interface can be selected as UNI or NNI and the SCRAMBLING can be turned on or off. For most applications ATM scrambling should be left on. The HEC CORRECTION can be enabled/disabled at this point. Header error correction (HEC) allows the correction of a single header error. To simulate a typical ATM receiver it should be switched ON.
- 5 If **HEADERS/PAYLOAD** is selected the CELLS SELECTED FOR TEST can be set up. To test a Virtual Path, select **VP** and set the VPI value. To test a VC, select **VC** and set the VPI and VCI. For specialist applications, you can select **EXPERT** mode to give complete flexibility in setting up the receiver. **ALL USER** cells is used to give a quick indicator of the total cells bandwidth being used.

ATM Operation

Setting up the Receiver ATM signal

NOTE

Select VP or VC for most test applications. ATM alarms are only monitored if VP or VC is selected.

- 6 To measure error or delay performance of the ATM connection, select **TEST CELL** as the payload in the transmitter and the receiver. This allows the measurement of cell errors, cell loss, cell misinsertion and cell delay simultaneously. For a simple BER measurement you can select **PRBS** or **USER BYTE**. When making a jitter tolerance measurement, select **PRBS**.

Cell Header at UNI

Bits								
8	7	6	5	4	3	2	1	Bytes
GFC				VPI				1
VPI				VCI				2
VCI								3
VCI				PTI		CLP		4
HEC								5

Cell Header at NNI

Bits								
8	7	6	5	4	3	2	1	Bytes
VPI								1
VPI				VCI				2
VCI								3
VCI				PTI		CLP		4
HEC								5

GFC - Generic Flow Control, VPI - Virtual Path Identifier
VCI - Virtual Channel Identifier, PTI - Payload Type
CLP - Cell Loss Priority, HEC - Header Error Control

Policing ATM Traffic

Description

Policing ATM traffic allows the user to check whether the incoming ATM service complies with the traffic contract.

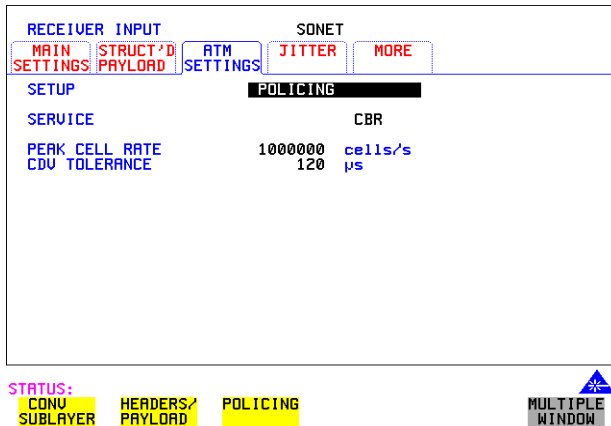

How to

- 1 Set up the Transmitter for ATM (See "Setting up the Transmitter for ATM Payloads " page 150).
- 2 Set up the Receiver for ATM (See "Setting up the Receiver ATM signal " page 168).
- 3 Select the **ATM SETTINGS** folder.
- 4 Select SETUP as **POLICING**.
- 5 To test a Continuous Bit Rate (CBR) service select the service **CBR**. Then set up the PEAK CELL RATE and CDVT. Any incoming signal which violates the peak cell rate or cell delay variation will result in NON-CONFORMING CELLS error. Because UBR traffic is policed in a similar manner to CBR, you can select CBR to police UBR traffic. In ABR dynamic control of the signal bandwidth is provided by resource management cells. However ABR is policed in a similar manner to CBR and so you can select CBR to police ABR traffic that is not changing.
- 6 To test a Variable Bit Rate (VBR) service select **VBR**. Then set up the SUSTAINABLE CELL RATE, the PEAK CELL RATE, the MAXIMUM BURST SIZE and the CDV TOLERANCE (See page 159 for definitions).
- 7 If the received cell stream does not conform to the policing parameters set up,

ATM Operation
Policing ATM Traffic

non-conforming cells are recorded. To view these cells, see "Viewing ATM Results " page 165.

Measuring ATM Delay Performance

Description

Cell delay can be a problem in any two-way communication system, for example in voice communications, conversation becomes increasingly difficult as path delays increase. In a similar manner, data communications throughput is decreased if significant delay (or latency) slows down the speed that messages can be acknowledged by the receiving terminal.

Cell delay variation (CDV) is caused by dynamic changes in the delay characteristic of an ATM connection. CDV causes problems in buffer underflow and overflow in play-out buffers used to recreate a CBR service. (This results in cell loss and the corresponding corruption of the data being carried. If the clock used to generate the CBR data is derived from the incoming data (adaptive clock method), excessive CDV may cause the PLL to lose lock). CDV may also be a problem for data carried on rt-VBR connections, like VBR video, where accurate timing recovery is critical to the observed quality of the decoded video signal (accumulation of CDV can increase the probability of cell loss due to switch congestion).

During design and verification, it may be necessary to test the delay and CDV of an ATM Network Element under load conditions to ensure that delay performance parameters can be guaranteed.

Measuring ATM Delay Performance

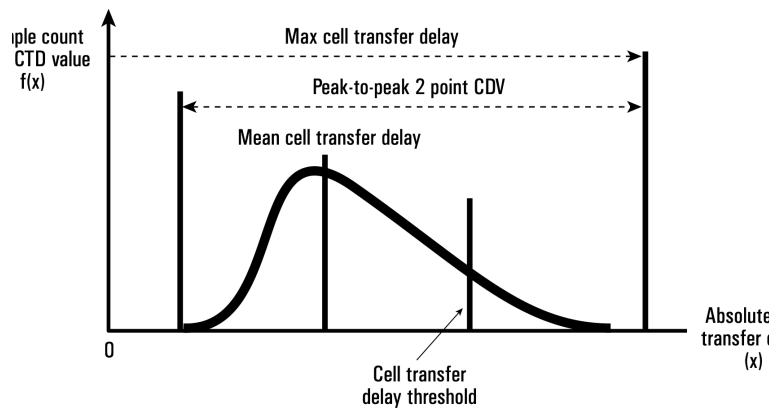

Cell Delay

ATM delay measurements

Each cell transmitted may experience a different delay through the ATM network. The delay calculated for each cell can be analyzed over a period of time to produce delay measurements. The following ATM cell delay measurements have been standardized by the ATM Forum and also in ITU-T Recommendation O.191.

- Mean cell transfer delay: the average of the delays calculated for each cell over the measurement time.
- Maximum cell transfer delay: the maximum value of delay calculated over the measurement time.
- Peak to peak two point CDV: the difference between the maximum delay and the minimum delay calculated over the measurement time.

These measurements are made using the timestamp field within the O.191 test cell.

ATM Operation

Measuring ATM Delay Performance

How to

- 1 Set up the **TRANSMIT** page for ATM see "Setting up the Transmitter for ATM Payloads " page 150.

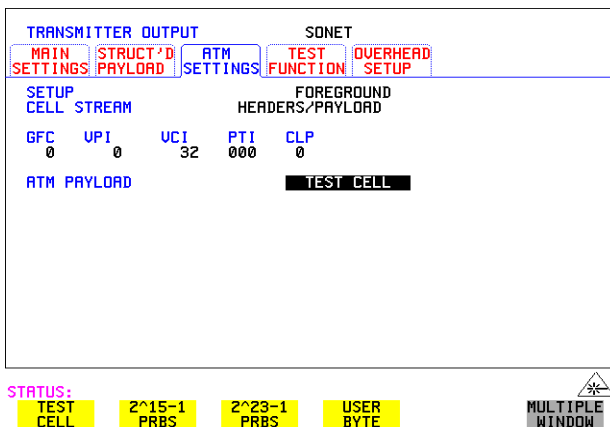

- 2 Select TEST CELL as the transmit and receive payload as shown above.
- 3 Select RESULTS and view the Delay and CDV results, an example is given below.

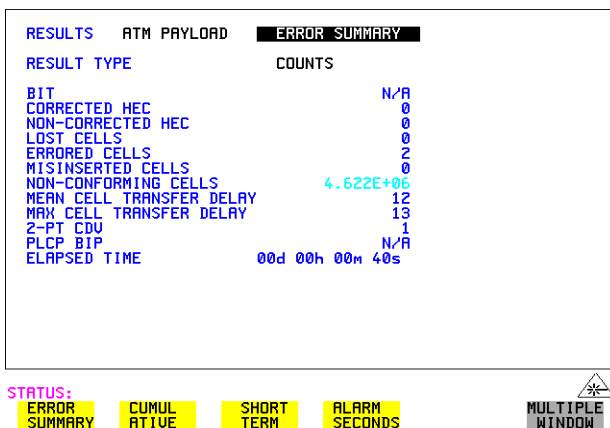

Note: Delay measurements such as mean cell transfer delay are only valid if you perform a round trip measurement, that is, when a transmitter and receiver are in the same instrument. You can perform a CDV measurement end to end, that is, using two separate instruments to transmit and receive.

Measuring ATM Alarms

Description

You can generate VP and VC AIS and RDI alarms to verify the response of the ATM Network under test, and also generate VP and VC Continuity check cells to keep the circuit alive during bursty traffic conditions. Set up the OmniBER 718 to generate AIS or RDI alarms and check the ability of your network element to recognize and respond to alarms.

The screenshot displays the OmniBER 718 interface for measuring ATM alarms. It is divided into several sections:

- TRANSMITTER OUTPUT (SONET):** Includes tabs for TEST FUNCTION, OVERHEAD SETUP, and MORE. The main display shows:

TEST FUNCTION	ATM	ERR & ALARM
ERROR ADD TYPE		BIT
STREAM		BACKGROUND
ERROR ADD RATE		NONE
OPM ALARM TYPE		VP-RDI
- RECEIVER INPUT (SONET):** Includes tabs for MAIN STRUCT'D, ATM SETTINGS, JITTER, and MORE. The main display shows:

CELLS SELECTED FOR TEST	VP	VC	PTI	CLP
CELL HEADER GFC	VP1	0		
USER	X		00X	X
- RESULTS (ATM PAYLOAD ALARM SECONDS):**

POWER LOSS	0	VP-AIS	0
LOSS OF CELL DEL.	0	VP-RDI	0
SEL. CELL NOT RX'D		VP-LDC	
CONGESTION ENP	0	VC-AIS	N/A
TEST-CELL SYNC LOS		VC-RDI	N/A
PATTERN LOSS	N/A	VC-LDC	N/A
FLCP DOP	N/A		
FLCP RAI	N/A		
ELAPSED TIME	00d 00h 00m 07s		
- FUNCTION SETTINGS CONTROL:** Shows TRANSMITTER AND RECEIVER COUPLED, RECEIVER COUPLED TO TRANSMITTER, and ATM HEADER VALUES NOT COUPLED.
- STATUS:** UP LOC alarm (indicated by a blue triangle icon).
- Buttons:** ALL USER, UP, UC, EXPERT MODE, SINGLE WINDOW.

How To

- 1 Set up the **TRANSMIT** page for ATM (see "Setting up the Transmitter for ATM Payloads " page 150).
- 2 Set up the Transmitter to generate ATM alarms (see "Transmitting ATM Alarms " page 161).

NOTE

VP ALARMS WILL ONLY BE DETECTED IF THE CELL SELECTED FOR TEST IS VP OR VC.
 VC ALARMS WILL ONLY BE DETECTED IF THE CELL SELECTED FOR TEST IS VC.

- 3 Check that the appropriate LED illuminates on the instrument front panel when alarms are generated.
- 4 On the **RESULTS** page select RESULTS as **ATM PAYLOAD**, **ALARM SECONDS**.

ATM Service Disruption

Description

The ATM service disruption test is a measurement of the time that cells are lost or errored while they pass through a network element. There are a number of reasons for such a disruption, from a break in the line which may activate a protection switch to an ESD discharge which causes a temporary interruption to the ATM service.

To make valid Quality of Service measurements the actual time that traffic is lost must be measured. To do this OmniBER uses the test cell as a payload. The test cell is a special cell, defined in ITU-T Recommendation 0.191, which allows the detection of lost, mis-inserted and errored cells, simultaneously. These key parameters are input to the ATM service disruption measurement. The measurement time starts at the last good cell before the disruption and finishes whenever the first good cell arrives, following a disruption. To ensure that the disruption has completely finished, 200ms of error free cells are required before the measurement is recorded. For maximum accuracy ensure the gap between cells does not exceed one second.

TRANSMITTER OUTPUT SONET MAIN STRUCT ID ATM JITTER MORE SETTINGS PAYLOAD SETTINGS SETUP FOREGROUND CELL STREAM HEADERS/PAYLOAD GFC VP1 VC1 PT1 CLP 0 0 32 000 0 ATM PAYLOAD TEST CELL	RECEIVER INPUT SONET MAIN STRUCT ID ATM JITTER MORE SETTINGS PAYLOAD SETTINGS SETUP HEADERS/PAYLOAD CELLS SELECTED FOR TEST CELL HEADER GFC VP1 VC1 PT1 CLP USER 0000 X ATM PAYLOAD TEST CELL
RESULTS SRVC DISRUPT LONGEST 0.037ms SHORTEST 0.009ms LAST 0.009ms ELAPSED TIME 00d 00h 00m 46s	FUNCTION SETTINGS CONTROL TRANSMITTER AND RECEIVER COUPLED RECEIVER COUPLED TO TRANSMITTER ATM HEADER VALUES NOT COUPLED

STATUS: **TROUBLE SCAN** **TIMING CONTROL** **SONET RESULTS** **ATM PAYLOAD** **MORE** **SINGLE WINDOW**

How To

To perform a service disruption measurement, set up the OmniBER as follows:

- 1 Set up the Transmitter for ATM, select the highest cell rate possible to ensure maximum accuracy (See "Setting up the Transmitter for ATM Payloads " page 150).
- 2 In the ATM SETTINGS folder set up the required service and traffic distributions. (See "Setting Foreground Traffic " page 155, "Setting

ATM Operation

ATM Service Disruption

Background Traffic " page 157 & "Setting Foreground and Background Distributions " page 158).

- 3 Set up the Receiver for ATM. (See "Setting up the Receiver for ATM Payloads " page 166).
- 4 In the Receiver ATM SETTINGS folder set up the service and filter required.
- 5 Verify that no errors/alarms are received (no red LEDs and the RESULTS page is clear of errors).
- 6 In the system under test, activate the protection switch or generate some kind of temporary system failure.
- 7 Go to the RESULTS page. In the first RESULTS field select **SRVC DISRUPT** and note the duration of the service disruption. Available measurements are LONGEST burst, SHORTEST burst and LAST burst.

ATM Operation
ATM Service Disruption

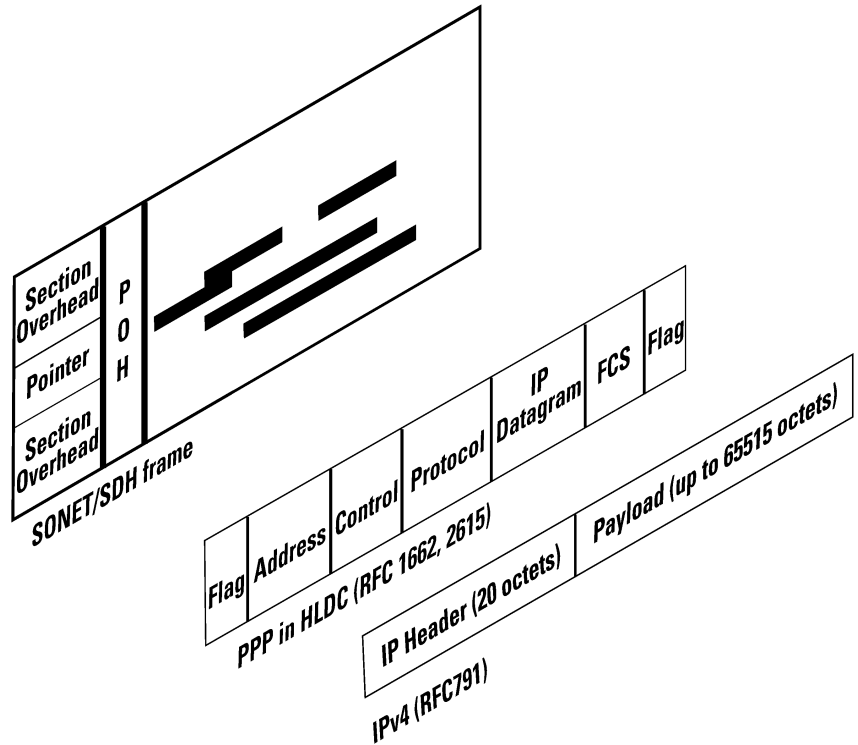

Packet over SONET (POS)

For POS operation you must have option 310 installed. Option 310 offers POS up to 2.5 Gb/s with a 37718A Mainframe, up to 622 Mb/s with a 37718B mainframe and up to 155 Mb/s with a 37718C mainframe.

Further information on POS technology/applications is supplied on the CD-ROM shipped with your instrument.

POS Protocol Stack

POS Protocol Stack

POS technology can be found in the line cards of high speed routers. It is a layer 2 protocol that maps IP packets into the SONET/SDH frame. Data is first of all segmented into an IP datagram that includes the 20-byte header. This datagram is encapsulated via PPP packets and framing information is added with HDLC-like framing. Gaps between frames are filled with flags (7E). The resulting data is scrambled, and mapped octet synchronously into the SONET/SDH frame.

POS is described by the Internet Engineering Task Force (IETF) in the following 'Request for Comment' (RFC) documents:

RFC-1661 (Point- to- Point Protocol), RFC-1662 (PPP in HDLC-like framing) and RFC-2615 (PPP over SONET/SDH).

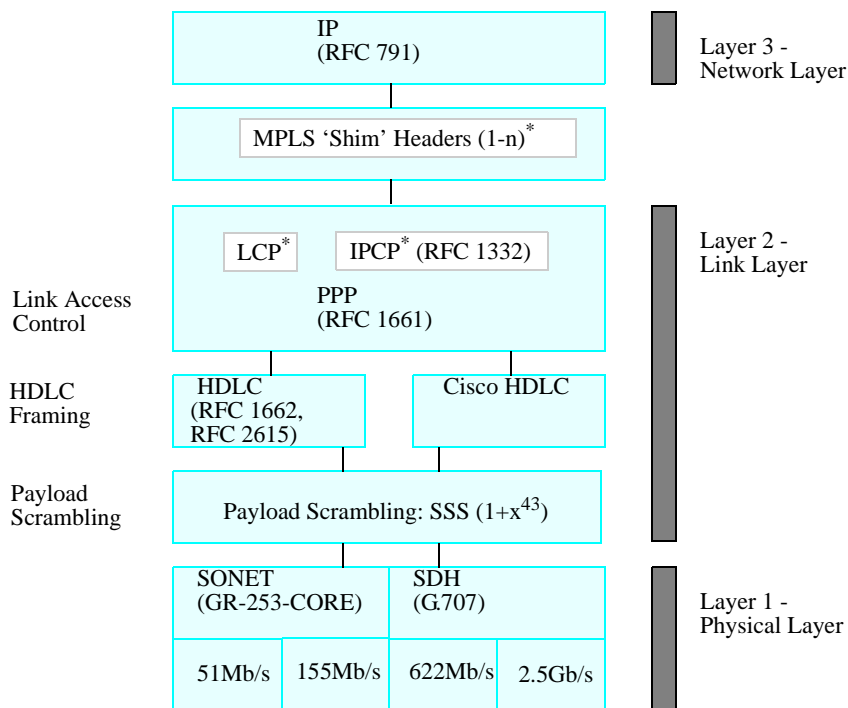

*MPLS supported on Rx but not on Tx

*LCP, IPCP not supported

Packet over SONET (POS) Setting up the Transmitter for POS Payloads

Setting up the Transmitter for POS Payloads

Description

The transmitter rate and mapping can be set up to match the requirements of the equipment under test. At SONET, select a rate from OC-1 to OC-48.

CAUTION

Laser On/Off selection. Always switch off the laser before connecting or disconnecting optical cables.

TIP

To set the Transmitter and Receiver to the same interface settings choose **OTHER SETTINGS CONTROL COUPLED**. This causes the receiver to be configured to the same settings as the transmitter.

The screenshot displays the SONET configuration interface, divided into four main sections:

- TRANSMITTER OUTPUT (SONET):** Shows settings for SIGNAL (OC-48), CLOCK (INTERNAL), FREQUENCY OFFSET (OFF), and MAPPING (STS-48C). A note indicates: "TO SET POS SETTINGS, FIRST SELECT THE 'POS SETTINGS' FOLDER ABOVE".
- RECEIVER INPUT (SONET):** Shows settings for SIGNAL (OC-48) and MAPPING (STS-48C). A note indicates: "TO SET POS SETTINGS, FIRST SELECT THE 'POS SETTINGS' FOLDER ABOVE".
- RESULTS (POS PAYLOAD):** A table showing counts for HDLC FRAMES, HDLC PCS ERRORS, IP DATAGRAMS, IP HEADER ERRORS, and BIT ERRORS. The BIT ERRORS count is 1,432E+06. ELAPSED TIME is 00d 00h 00m 15s.
- FUNCTION (SETTINGS CONTROL):** Shows the status "TRANSMITTER AND RECEIVER COUPLED" and "RECEIVER COUPLED TO TRANSMITTER".

Below the interface, there is a HINT: "Press SET for popup application diagram" and a STATUS bar with buttons for BULK FILLED, ATM, POS, and SINGLE WINDOW.

How to

- 1 Press the **TRANSMIT** key and select **SONET**.
- 2 Select the SIGNAL rate.
- 3 If Option 106, Dual Wavelength optical module, is fitted and an optical rate is chosen, choose the required wavelength (1550 or 1310).
If STS-1 is chosen, choose the required interface level (CROSS-CONNECT, HIGH or LOW).
Choose **INTERNAL** unless **THRU MODE** is required. If **THRU MODE** is chosen, see "Setting SONET THRU Mode " page 37.

Packet over SONET (POS)

Setting up the Transmitter for POS Payloads

- 4 Make your choice of CLOCK synchronization source. The clock can be internally sourced from the instrument, recovered from the signal at the optical RECEIVE port or externally sourced from the CLOCK REF IN ports (MTS 64 kb/s, BITS 1.5 Mb/s or 10 MHz REF).
- 5 If required choose the FREQUENCY OFFSET value. See “Adding Frequency Offset to SONET Signal” page 62.

Payload Mappings

The payload mappings available for POS in SONET are: STS-48c SPE, STS-12c SPE, STS-3c SPE and STS-1 SPE.

- 6 Select required MAPPING and then select **POS**.
Alternatively, use **SET** to bring up the popup application diagram:

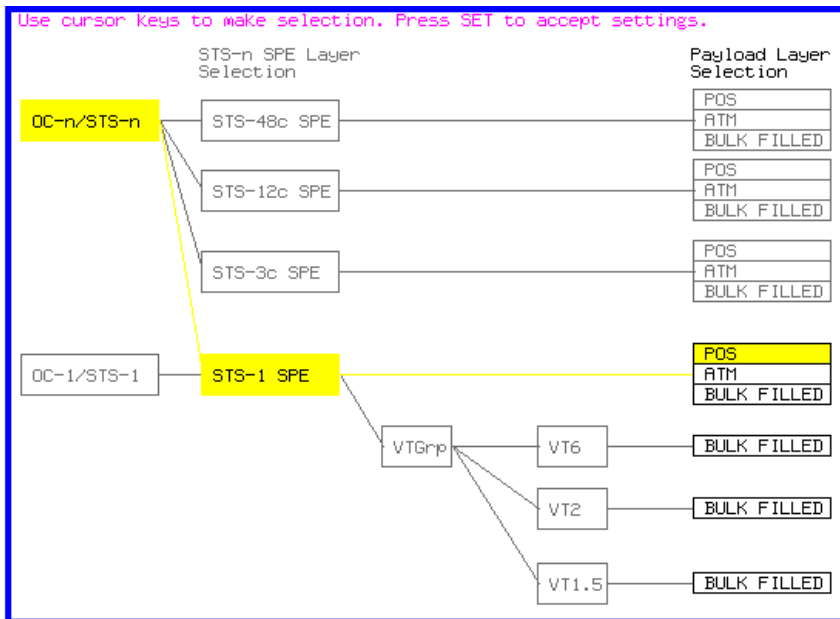

Use **→** and **←** to move between STS Layer Selection and Payload Layer Selection. Use **↑** and **↓** to set the mapping and **SET** to set your selection.

- 7 Select the STS-n channel under test.
- 8 Select the **POS SETTINGS** page and set up as described in the following pages:

Setting HDLC Framing, Scrambling and HDLC Frame Check Sequence

Description

PPP in HDLC-like framing

PPP encapsulated packets are mapped into frames. HDLC-like framing is used to delineate the packet boundaries so that the receiver can extract them from the SONET/SDH frame. Gaps between packets are filled with standard HDLC flags of 7E.

Two framing formats are provided.

- PPP in HDLC framing - as per RFC 1662.
- CISCO HDLC - Cisco's proprietary frame structure.

The HDLC-like frame includes address, control, and protocol fields followed by the IP datagram.

The frame structure is common to both formats, with values shown below.

Table 5 Frame Structure for PPP in HDLC and Cisco HDLC

Flag	Address	Control	Protocol	IP datagram	FCS	Flag
8 bits	8 bits	8 bits	16 bits	variable	16/32 bits	8 bits

PPP in HDLC	0x7E	0xFF	0x03	0x0021			0x7E
Cisco HDLC	0x7E	0x0F	0x00	0x0800			0x7E

Packet over SONET (POS)

Setting HDLC Framing, Scrambling and HDLC Frame Check Sequence

Scrambling

The purpose of POS scrambling is to ensure that malicious users cannot bring down a network by transmitting patterns which disrupt/confuse SONET/SDH synchronization or framing. See Packet over SONET/SDH white paper (on your OmniBER CD-ROM) for more details.

The addition of payload scrambling occurs when inserting the HDLC-like framed PPP packets into the SONET/SDH frame

Frame Check Sequence

The FCS (Frame Check Sequence) is a CRC checksum and is used to protect the entire frame and give an indication of traffic integrity.

The FCS value is calculated over all bits of the address, control, protocol, datagram and padding fields. It does not include the flag fields or the FCS field itself.

How To

- 1 This procedure assumes you have already selected a POS payload on the MAIN SETTING page, see “Setting up the Transmitter for POS Payloads” page 181.
- 2 Select the **POS SETTINGS** folder as shown below:

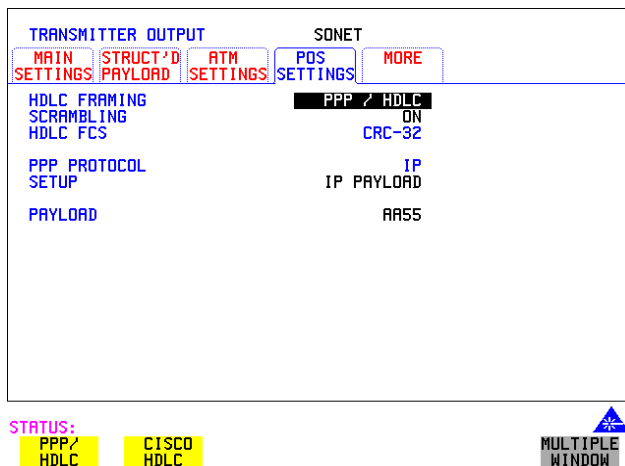

- 3 Set the HDLC FRAMING field to **PPP/HDLC** or **CISCO HDLC** as required.

Packet over SONET (POS)

Setting HDLC Framing, Scrambling and HDLC Frame Check Sequence

- 4 Set SCRAMBLING to **ON** or **OFF** as required.
If you select **ON** then scrambling is performed during insertion into the SONET using an $x^{43} + 1$ polynomial.
Note that the Scrambling OFF/ON selection affects the value of the C2 Overhead Byte as follows:
 - Path Signal Label C2 set to 0x16 to indicate PPP when Scrambling set ON.
 - Path Signal Label C2 set to 0xCF to indicate PPP when Scrambling set OFF.
- 5 Set the HDLC FCS (Frame Check Sequence) field to **CRC-16** or **CRC-32** as required. Note that **CRC-16** is not available for STS-48c at 2.5Gb/s. CRC-32 is usually the recommended selection.

Setting IP Packet (Datagram) Length and Inter-Packet Gap

Description

Both the IP datagram length and the Inter-packet gap are settable

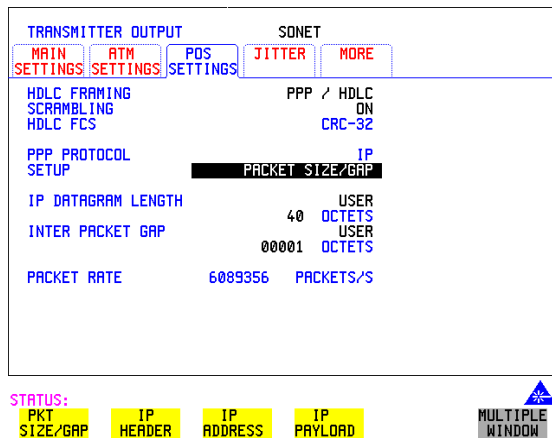

How To

- 1 This procedure assumes you have already selected a POS payload on the MAIN SETTING page, see “Setting up the Transmitter for POS Payloads” page 181.
- 2 Select the **POS SETTINGS** folder as shown above.
- 3 Set the SETUP field to **PACKET SIZE/GAP** .

Setting IP Datagram Length

- 4 Select the IP DATAGRAM LENGTH field.
- 5 Choose the IP DATAGRAM LENGTH. There is a choice of: **USER** , **RANDOM** or **7:4:1** .

Note: The IP datagram length is the value placed in the IP header ‘Total Length’ field. No padding is implemented: the datagram is immediately followed by the end of the HDLC frame (FCS and closing flag).

User Length:

Settable between 20 and 65535 octets. Step size 1 octet. This is the size of the entire datagram, including the 20 octet header, before any HDLC octet stuffing. When the size is set to 20 only a header is transmitted.

Packet over SONET (POS)

Setting IP Packet (Datagram) Length and Inter-Packet Gap

Random Lengths: The IP datagram size is varied randomly between minimum & maximum limits.

The minimum datagram size is settable between 20 and 63 octets.

The maximum datagram size can be set to one of the following values:

- 127
- 511
- 1023
- 8191
- 65535

7,4,1 Lengths: Emulates real traffic patterns by sending a repeating sequence of 12 packets in which 7 have size 40 octets, 4 have size 552 octets, and 1 has size 1500 octets.

Setting Inter-Packet Gap

6 Choose the INTER PACKET GAP required, you can select either **USER** or **RANDOM**.

USER: Settable between 1 to $2^{30} - 1$ octets. Step size: 1 octet.

RANDOM: The Inter-packet gap is varied randomly between minimum & maximum limits.

The minimum Inter-packet gap size is fixed at 1.

The maximum Inter-packet gap size can be set to one of the following values:

- 4
- 32
- 1024
- 2^{20}
- $2^{30} - 1$

Packet Rate

The PACKET RATE displayed at the bottom of the display is the number of packets per second and is determined by the following:

- Channel Bandwidth (OC-1/OC-3/OC-12/OC-48).
- Packet (datagram) size.
- HDLC byte stuffing.
- Inter - packet gap

Please refer to “What determines the packet rate?” page 205 for a detailed description on how Packet Rate is calculated.

Setting IP Header

Setting IP Header

Description

Note that the IP Header is sent in every packet.

How To

- 1 This procedure assumes you have already selected a POS payload on the MAIN SETTING page, see “Setting up the Transmitter for POS Payloads” page 181.
- 2 Select the **POS SETTINGS** folder as shown below:
- 3 Set the SETUP field to **IP HEADER**.

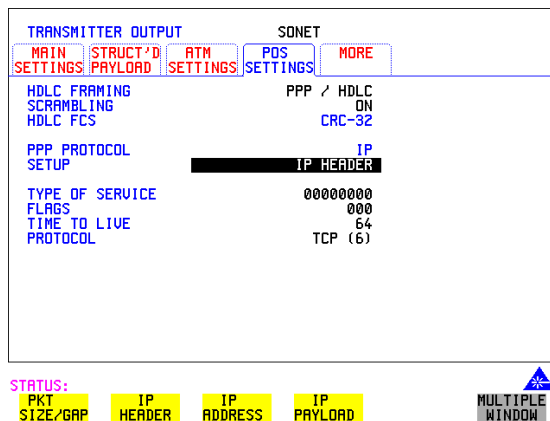

- 4 Select the TYPE OF SERVICE (TOS) field and set up the 8 bits as required. This field is used to specify the service precedence of datagrams during their transmission through the internet system.
- 5 Select the FLAGS field to control fragmentation of packets and using the edit keys set each flag to 0 or 1.
- 6 Select the TIME TO LIVE (TTL) field and select a value from 0 to 255 (instrument default value is 64). Each Router will decrement the TTL value as it passes through. When it reaches zero the packet is destroyed.
- 7 Select the PROTOCOL field and choose from the following preset values: ICMP (1), IP (4), TCP (6), UDP (17), ICMP or program the USER PROGRAM value (0 to 255). The instrument default choice is TCP. This field indicates the next level protocol used in the data portion of the internet datagram (the value in brackets indicates the value of the byte in decimal (i.e. (6) indicates binary 00000110).

Setting IP Addresses

Setting IP Addresses

How To

- 1 This procedure assumes you have already selected a POS payload on the MAIN SETTING page, see “Setting up the Transmitter for POS Payloads” page 181.
- 2 Select the **POS SETTINGS** folder as shown below:

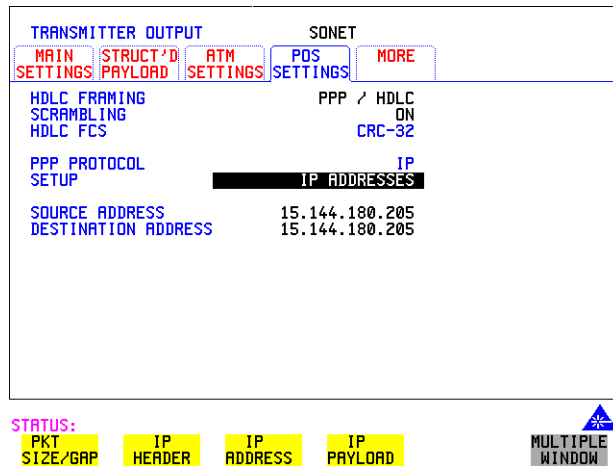

- 3 Set the SETUP field to **IP ADDRESS** and set up the Source and Destination Addresses.

Setting IP Payload

Setting IP Payload

How To

- 1 This procedure assumes you have already selected a POS payload on the MAIN SETTING page, see “Setting up the Transmitter for POS Payloads” page 181.
- 2 Select the **POS SETTINGS** folder as shown below.

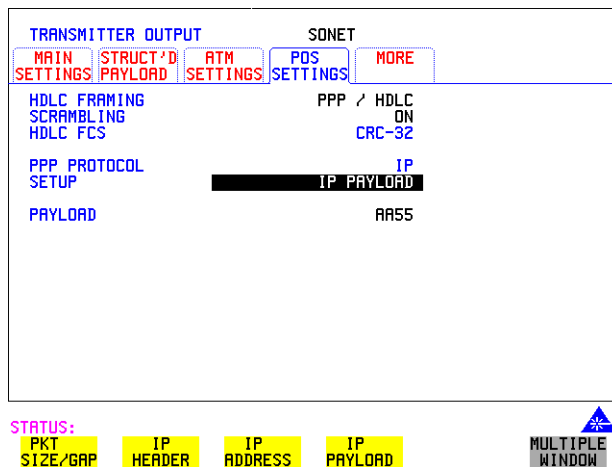

- 3 Set the SETUP field to **IP PAYLOAD**.

The IP Payload selections offered are:

- $2^{23}-1$ PRBS. (The PRBS can be non-inverted or inverted.)
 - All Ones.
 - All Zeros.
 - 0xAA55 pattern
 - 16-bit or 32 bit (BIN or HEX) user selectable word.
- 4 Set the PAYLOAD FIELD as required. Note that your choice of payload can affect the stability of the Packet Rate value (due to HDLC stuffing). To eliminate any uncertainty due to stuffing you should choose carefully the IP header and payload so that no stuffing takes place. Selecting a fixed word instead of a PRBS is recommended.

Adding POS Alarms

Adding POS Alarms

Description

In the OmniBER receiver the front panel HDLC LOSS LED illuminates whenever there are no valid HDLC frames and no HDLC flags. The HDLC LINK LOSS alarm provided here allows you to simulate the condition when no valid HDLC frames/flags are present.

How To

- 1 This procedure assumes you have already selected a POS payload on the MAIN SETTING page, see “Setting up the Transmitter for POS Payloads” page 181.
- 2 Press the **TRANSMIT** key and select **SONET**.
- 3 Select the **TEST FUNCTION** folder as shown.
- 4 Set the TEST FUNCTION field to POS.
- 5 Set the ALARM TYPE field to **OFF** or **LINK LOSS**.
Selecting **LINK LOSS** logically inverts the 7E hex flag by transmitting the value 0x81 in all octets.

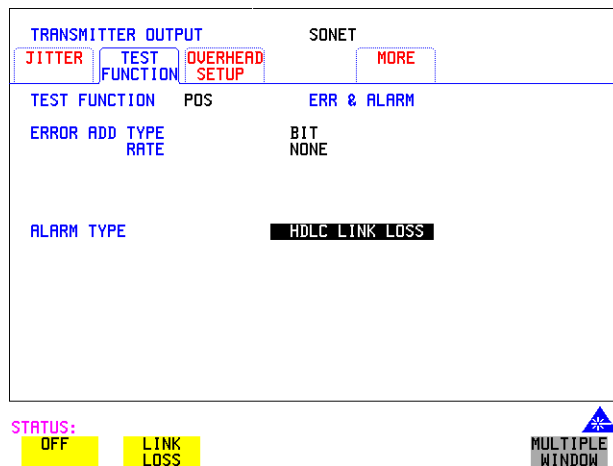

Adding POS Errors

Adding POS Errors

How To

- 1 This procedure assumes you have already selected a POS payload on the MAIN SETTING page, see “Setting up the Transmitter for POS Payloads” page 181.
- 2 Press the **TRANSMIT** key and select **SONET**.
- 3 Select the **TEST FUNCTION** folder as shown:
- 4 Set the TEST FUNCTION field to **POS**.

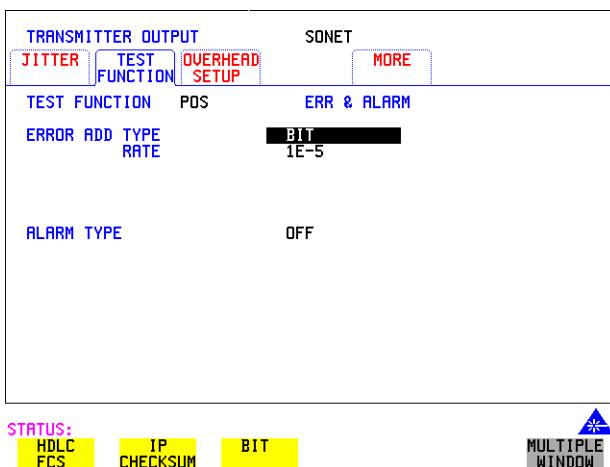

- 5 Select the ERROR ADD TYPE field and choose an Error Type, also select the Error Rate. The Error Add Types and Rates available are as follows:
 - HDLC FCS (CRC-16/CRC-32) errors.
Mode: Single (via front panel SINGLE key) or Rate (1E-3).
 - IP Header CHECKSUM Errors.
Mode: Single or Rate (1E-3).
 - BIT (IP Data) Errors
Mode:- Single or Rate
Rate = 1E-n where n= 3 to 9
Note: BIT is disabled when IP datagram length is set to 20 octets (Header only).

Packet over SONET (POS) Setting up the Receiver for POS Operation

Setting up the Receiver for POS Operation

Description

The receiver rate and mapping can be set up to match the requirements of the equipment under test. For SONET, select a rate from STS-1/OC-1 to OC-48 Optical.

TIP

To set the Transmitter and Receiver to the same interface settings choose **OTHER SETTINGS CONTROL COUPLED**. This causes the receiver to be configured to the same settings as the transmitter.

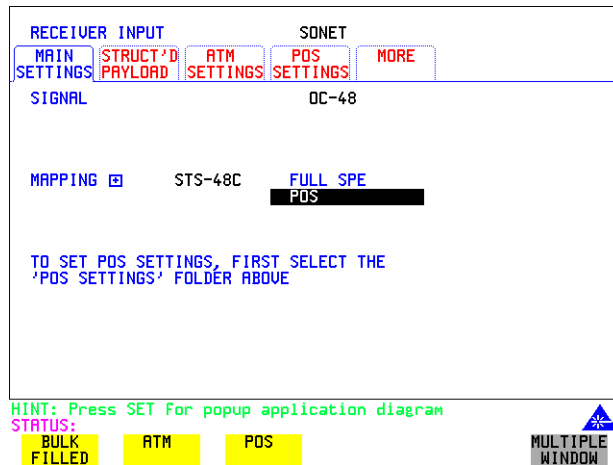

How To

- 1 Press **RECEIVE** and select **SONET**.
- 2 Select the **MAIN SETTINGS** folder.
- 3 Select the SIGNAL rate.
- 4 Select required MAPPING with POS as a payload.
As an alternative, use **SET** to bring up the popup application diagram. Use the cursor keys to navigate through the popup application diagram (see next page).

Packet over SONET (POS)

Setting up the Receiver for POS Operation

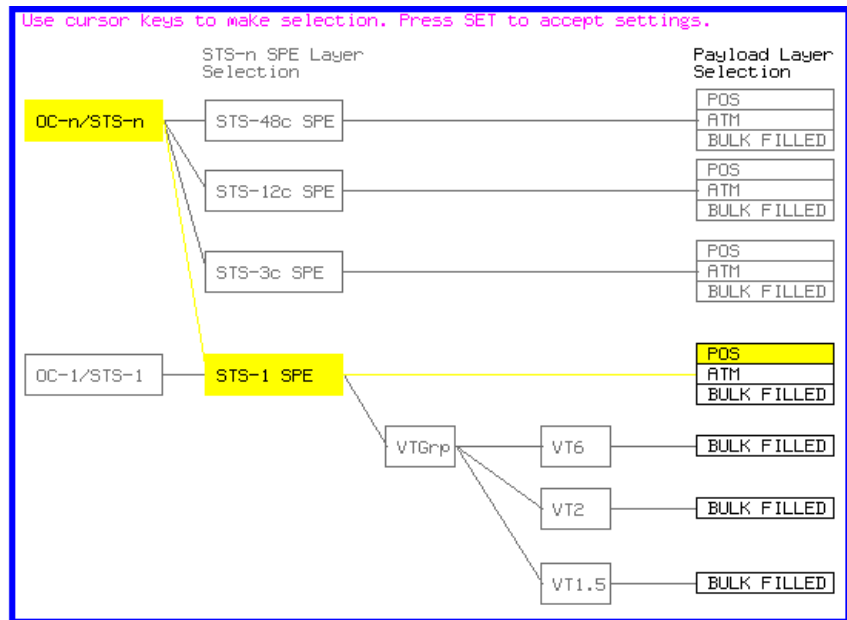

- 5 Continue to the next task "Setting up the Receiver POS signal" page 195 for advice on setting up the receiver POS signal.

Packet over SONET (POS) Setting up the Receiver POS signal

Setting up the Receiver POS signal

Description

You can set up the POS receiver signal to suit the equipment under test.

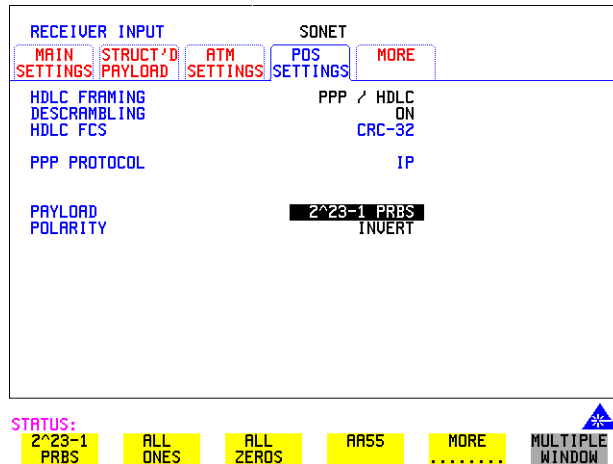

How To

- 1 Select the Receive rate and mapping, see "Setting up the Receiver for POS Operation " page 193.
- 2 Select the **POS SETTINGS** folder.
- 3 Set HDLC FRAMING to **PPP/HDLC** or **CISCO HDLC** as required.
- 4 Set DESCRAMBLING to **ON** or **OFF**.
- 5 Set HDLC FCS field to **CRC-16** or **CRC-32**.
- 6 Set the PAYLOAD field to one of the following:
 - **2^23-1 PRBS**
 - **ALL ONES**
 - **ALL ZEROS**
 - **AA55**
 - **USER WORD**
 - **LIVE TRAFFIC**

Viewing POS Results

Description

The POS results can be viewed in a variety of ways on the RESULTS page.

RESULTS	POS PAYLOAD	RESULT SUMMARY
RESULT TYPE		COUNTS
HDLC FRAMES		7.551E+07
HDLC FCS ERRORS		0
IP DATAGRAMS		7.551E+07
IP HEADER ERRORS		0
BIT ERRORS		120813
ELAPSED TIME		00d 00h 00m 12s

STATUS: TROUBLE SCAN TIMING CONTROL SONET RESULTS POS PAYLOAD MORE MULTIPLE WINDOW

How To

- 1 Press the **RESULTS** key.
- 2 Select **POS PAYLOAD** in the RESULTS field.
- 3 **RESULT SUMMARY** gives a summary of all possible POS measurements and errors/counts and can be set up to be read as counts (total in measurement interval) or ratios/rates.
- 4 **CUMULATIVE** gives the number of errors and counts which have occurred in total since the last time **RUN/STOP** was pressed.
- 5 **SHORT TERM** give the number of errors and counts which have occurred in the last measurement interval. This measurement interval is set up on the results page when **TIMING CONTROL** has been selected in the RESULTS field.
- 6 **ALARM SECONDS** is used to look at POS and Power Loss alarms.

Packet over SONET (POS)

POS Applications

POS Applications

The following pages give typical test applications.

Channelized Testing

Channelized Testing

Description

Channelized testing is the ability to perform tests on individual channels within SONET.

Many L1/L2 chipsets and line cards support SONET channelization. Typical configurations are:

- 3 STS-1 channels in an OC-3
- 4 STS-3c channels in an OC-12
- 4 STS-12c channels in an OC-48
- 16 STS-3c channels in an OC-48.

An important feature of the OmniBER is the ability to perform channelized testing using a POS payload.

With the OmniBER you can perform tests either in a single channel (with the other channels filled with a background payload) or over the full SDH bandwidth (concatenated mode).

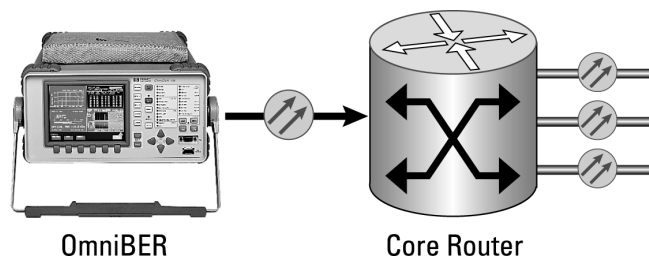

How to

- 1 Set the Transmitter and Receiver to the same interface settings by choosing **OTHER** **SETTINGS CONTROL** **COUPLED**. This causes the receiver to be configured to the same settings as the transmitter.
- 2 Press the **TRANSMIT** key and select **SONET**.
- 3 Select the **MAIN SETTINGS** folder.
- 4 Select the SIGNAL rate, CLOCK and FREQUENCY OFFSET as required.

Packet over SONET (POS)

Channelized Testing

- 5 Select required MAPPING with POS as a payload.
Use **SET** to bring up the popup application diagram. This allows an alternative way of selecting the appropriate mapping. Use the cursor keys to navigate through the popup application diagram.
- 6 Select the channel under test.
The figure below gives an example where the channel under test is STS-12c (2) in an OC-48 signal.

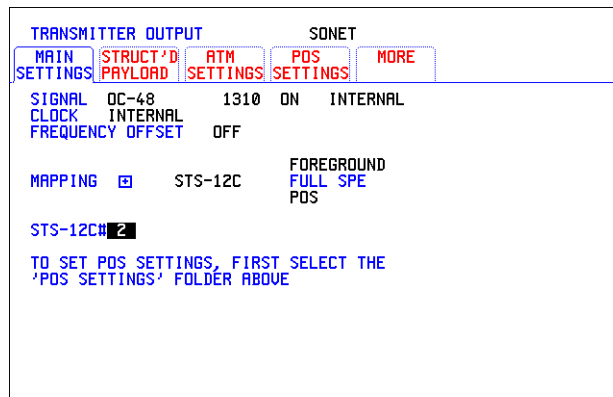

STATUS:

1

2

3

4



Fully Exercising POS Hardware Architecture

Description

POS hardware operating at high speeds uses wide bus architectures (that is, internal buses which are several bytes wide). To ensure correct operation the hardware needs to be fully exercised (stressed) so that all 'corner cases' are caught. This is done by generating traffic with varying packet and gap sizes, sending the smallest packets at highest speed, longest packets, scrambling and exercise of the octet stuffing and destuffing. It may also include sending packet sizes rarely encountered in live networks (such as packet sizes which are not rounded to 4-byte boundaries).

With the OmniBER 718 you generate traffic profiles to successfully exercise POS hardware using the methods described. The following figure illustrates the traffic profiles offered in the OmniBER 718.

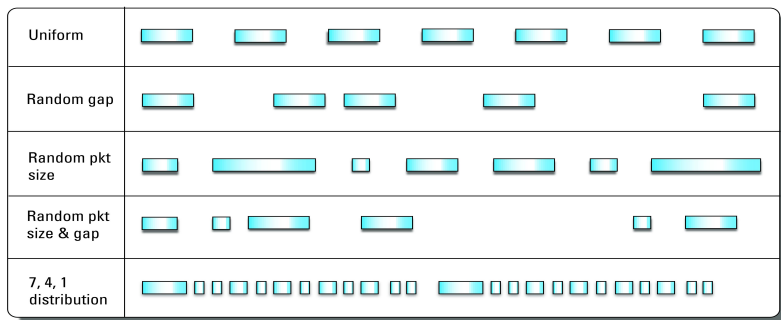

Fixed packet size and gap

If you select a fixed packet and gap you can check different phases of the wide-bus architecture. For example selecting gap sizes of 1, 2, 3 and 4 will test all 4 byte phases of a 4-byte architecture.

Random packet size

With random packet sizes, the maximum and minimum size can be set.

Packet over SONET (POS)

Fully Exercising POS Hardware Architecture

Minimum sizes are particularly important for stress testing hardware. This minimum size can be set equal to the minimum allowed by the hardware.

The probability of a packet with a particular size (between max and min.) is roughly equal for all packet sizes (see following figure).

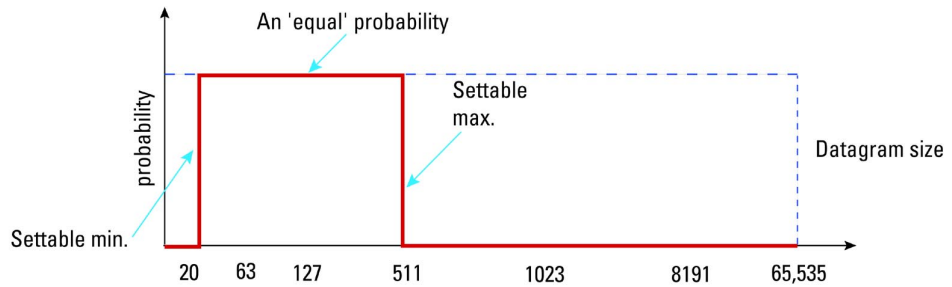

Random packet gap

Random packet gaps can be generated with roughly equal probability between 1 octet and maximum. Setting a lower maximum value will increase the average packet rate.

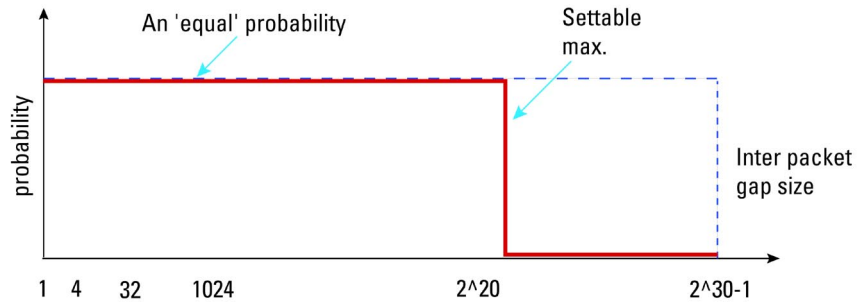

Packet over SONET (POS) Fully Exercising POS Hardware Architecture

Transmit an IP packet that generates maximum stress on the circuit under test.

An ideal way to generate the maximum stress on circuits under test is to transmit an IP packet which has both a random packet size and gap. You can do this with the OmniBER, and an example is given below.

How To

- 1 This procedure assumes you have already selected a POS payload on the MAIN SETTING page, see “Setting up the Transmitter for POS Payloads” page 181.
- 2 Select the **POS SETTINGS** folder.
- 3 Set up the POS SETTINGS page, an example is given below.

TRANSMITTER OUTPUT		SONET		
MAIN SETTINGS	STRUCT'D PAYLOAD	ATM SETTINGS	POS SETTINGS	MORE
HDLC FRAMING		PPP / HDLC		
SCRAMBLING		ON		
HDLC FCS		CRC-32		
PPP PROTOCOL		IP		
SETUP		PACKET SIZE/GAP		
IP DATAGRAM LENGTH		RANDOM		
RANGE FROM	40	TO	8191	OCTETS
INTER PACKET GAP				RANDOM
RANGE FROM	1	TO	4	OCTETS
PACKET RATE		72405		PACKETS/S

STATUS:
USER LENGTH RANDOM LENGTHS 7:4:1 LENGTHS

 MULTIPLE WINDOW

Packet over SONET (POS)
Fully Exercising POS Hardware Architecture

Transmit IP data that more closely resembles real traffic (7:4:1 distribution)

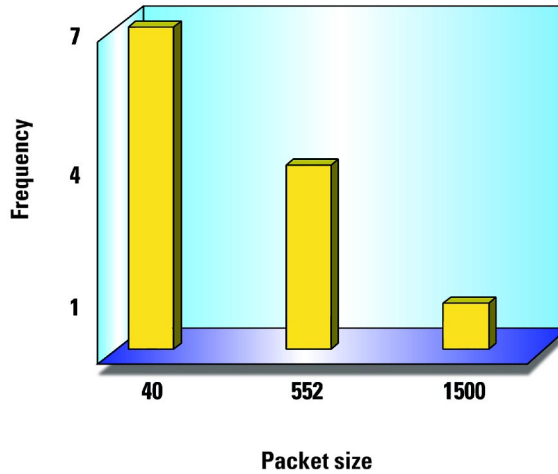

With internet traffic any of the definable packet sizes (and gaps) may be transmitted. In practise it is more common to see fewer variations in the packet size the more packets there are transmitted. The OmniBER 718 provides a packet stream that closely approximates to this type of distribution, there are three packet sizes; they are 1500, 552 and 40 octets (see Figure above). The distribution is 7 small packets (40), 4 medium sized packets (552) and 1 big packet (1500) in every group of 12.

TRANSMITTER OUTPUT		SONET	
MAIN SETTINGS	STRUCT'D PAYLOAD	ATM SETTINGS	POS SETTINGS
HDLC FRAMING SCRAMBLING HDLC FCS		PPP / HDLC ON CRC-32	
PPP PROTOCOL SETUP		IP PACKET SIZE/GAP	
IP DATAGRAM LENGTH		7:4:1	
INTER PACKET GAP RANGE FROM 1 TO 4		RANDOM OCTETS	
PACKET RATE		867409 PACKETS/S	

STATUS:
 USER LENGTH RANDOM LENGTHS 7:4:1 LENGTHS



Throughput Testing

Throughput Testing

Description

Packet over SONET chipsets and line cards will have performance limits imposed by the hardware architecture and by the size and management of buffers. To test these components it will be necessary to check that IP packets can be passed at the following:

- Minimum packet size and/or
- Maximum packet rate.

Using the OmniBER you can generate a continuous stream of packets of any size, and with any inter-packet gap.

In the following example the OmniBER is set up to generate a packet stream of 75-byte IP packets with a 17-byte gap between packets. The instrument displays (at the bottom of the screen) the actual transmitted packet rate in packets/s (2995200). To obtain the desired packet rate it is necessary to understand the factors determining packet rate, this is explained in the following text.

The screenshot shows the 'TRANSMITTER OUTPUT' screen for 'SONET'. At the top, there are navigation buttons: 'MAIN SETTINGS', 'STRUCT'D PAYLOAD', 'ATM SETTINGS', 'POS SETTINGS', and 'MORE'. The main display area contains the following settings:

HDLC FRAMING	PPP / HDLC
SCRAMBLING	ON
HDLC FCS	CRC-32
PPP PROTOCOL SETUP	IP
IP DATAGRAM LENGTH	75 OCTETS
INTER PACKET GAP	17 OCTETS
PACKET RATE	2995200 PACKETS/S

At the bottom of the screen, there is a 'STATUS:' section with four yellow boxes: 'PKT SIZE/GAP', 'IP HEADER', 'IP ADDRESS', and 'IP PAYLOAD'. To the right of these boxes is a 'MULTIPLE WINDOW' icon with a blue triangle pointing upwards.

Packet over SONET (POS)

Throughput Testing

What determines the packet rate?

- Channel bandwidth (STS-1 SPE, STS-3c SPE, STS-12c SPE or STS-48c SPE).
- Packet size.
- HDLC byte stuffing.
- Inter packet gap.

Available bandwidth

The available bandwidth (in bytes/second) for packet transmission for each channel is as follows:

- STS-1 SPE 6048000
- STS-3c SPE 18720000
- STS-12c 74880000
- STS-48c SPE 299520000

Packet Size

For IP, the packet size is specified in terms of the IP datagram size including the 20 byte IP header. The actual packet size transmitted includes 4 bytes of PPP/HDLC overhead plus the FCS (HDLC Frame Check Sum) which is 2 bytes for FCS16 or 4 bytes for FCS32. Hence, for a 75 byte IP datagram with FCS32 the actual packet size is $75 + 4 + 4 = 83$ bytes.

The packet size may be further modified by HDLC stuffing. This will add one extra byte every time the flag (7E) or escape (7D) octet appears in the packet.

The actual transmitted packet rate (in packets/second) will then be:

channel bandwidth \div (packet size (including overhead and stuffing) + gap size).

For our example (see display on previous page), ignoring the effect of HDLC byte stuffing, we would expect a packet rate of $299520000 \div (83 + 17) = 2995200$ pkts/sec. However, due to the effects of HDLC stuffing, this figure may be slightly reduced. To eliminate the uncertainty due to stuffing, it is possible to choose carefully the IP header and payload so that no stuffing takes place. The procedure given on the next page shows how this can be done:

Packet over SONET (POS)

Throughput Testing

To Transmit a packet rate of 2995200 packets/second

The following procedure shows how to set up the OmniBER to generate a packet stream of 75-byte IP packets with a 17-byte gap between packets and with a packet rate of 2995200 packets/s.

How To

- 1 Press the **TRANSMIT** key and select **SONET**.
- 2 Select the **MAIN SETTINGS** folder and set up the page as shown below, with a POS payload selected.

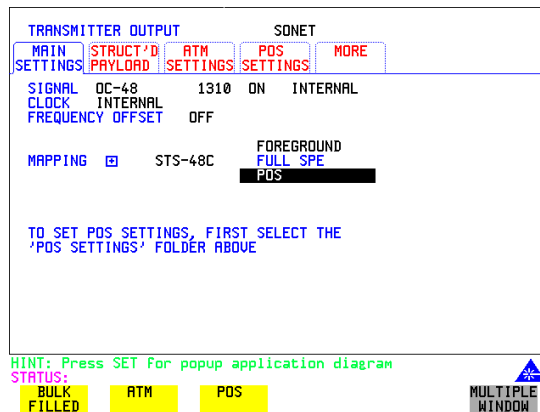

- 3 Select the **POS SETTINGS** folder.
- 4 Set the SETUP field to **IP PAYLOAD**.
- 5 Select a fixed word pattern as the payload (AA55 for this example).

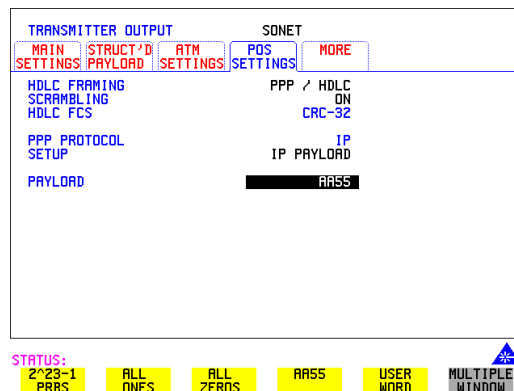

Packet over SONET (POS)

Throughput Testing

- 6 Set the SETUP field to **PACKET SIZE/GAP**.
- 7 Set the IP datagram length and inter packet gap as shown below.

TRANSMITTER OUTPUT		SONET	
MAIN SETTINGS	STRUCT'D PAYLOAD	ATM SETTINGS	POS SETTINGS
HDLC FRAMING		PPP / HDLC	
SCRAMBLING		ON	
HDLC FCS		CRC-32	
PPP PROTOCOL		IP	
SETUP	PACKET SIZE/GAP		
IP DATAGRAM LENGTH	75	USER	OCTETS
INTER PACKET GAP	17	USER	OCTETS
PACKET RATE	2995200	PACKETS/S	

STATUS:

PKT
SIZE/GAP

IP
HEADER

IP
ADDRESS

IP
PAYLOAD

MULTIPLE
WINDOW

Note the PACKETS/S rate displayed is what we expected (2995200).

If however you are setting up the transmitter to transmit a different packet rate and the value displayed is not what you expect, you may need to vary the word pattern (IP payload) and/or the IP datagram header bytes until the expected packet rate is displayed.

Continuity Test

Continuity Test

Description

A continuity check is a simple and effective way of checking for missing packets or corrupted packets that are dropped. The method used is to transmit a PRBS in the POS payload part of all the IP packets and check that the PRBS arrives at the receiving port error free. A lost or corrupted packet will result in a burst of errors at the OmniBER receiver.

The figure below illustrates a packet stream with a bit pattern running through the packets and shows that when a packet is lost pattern sync loss occurs. Pattern sync loss will result in errors which can be measured in the OmniBER.

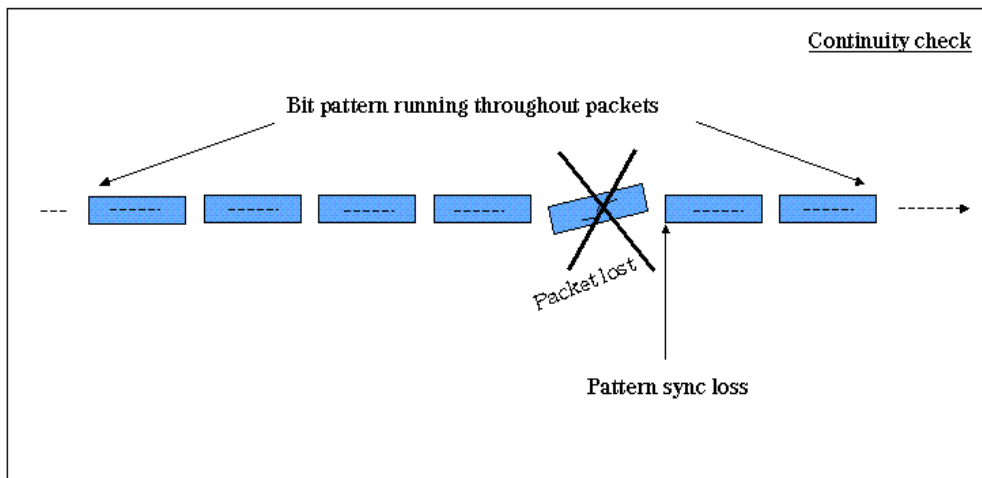

Setting up the OmniBER to perform a Continuity Test

How To

- 1 Set the Transmitter and Receiver to the same interface settings by choosing **OTHER**, **SETTINGS CONTROL**, **COUPLED**.
- 2 Press the **TRANSMIT** key and select **SONET**.
- 3 Select a POS payload on the **MAIN SETTINGS** page, see "Setting up the Transmitter for POS Payloads" page 181

Packet over SONET (POS)

Continuity Test

- 4 Select the **POS SETTINGS** folder.
- 5 Set the SETUP field to **IP PAYLOAD** and select a suitable payload, for this example we have chosen a $2^{23}-1$ PRBS as shown below.

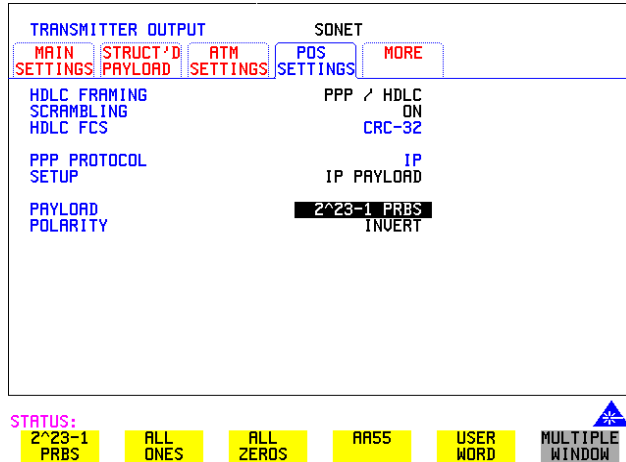

Check continuity by adding POS errors and verifying that the correct alarms and errors are received by the OmniBER.

- 6 Select the **TEST FUNCTION** folder and set up as shown below.

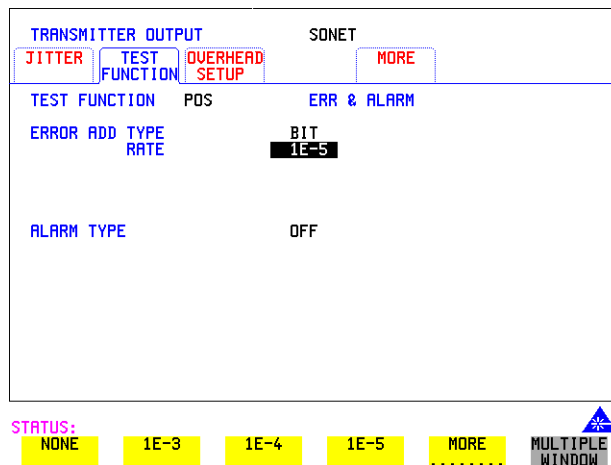

Packet over SONET (POS)

Continuity Test

- 7 Press **RUN/STOP** to start the measurement.
- 8 View the results on the **RESULTS**, **POS PAYLOAD** page. An example is given below.

The screenshot displays a multi-panel interface for a network testing device. The top-left panel, titled 'TRANSMITTER OUTPUT SONET', shows test function settings: TEST FUNCTION (POS), OVERHEAD SETUP, ERR & ALARM (BIT 1E-5), and ALARM TYPE (OFF). The top-right panel, 'RECEIVER INPUT SONET', shows signal settings: SIGNAL (OC-48), HAPPING (checked), STS-48C, and FULL SPE POS. The bottom-left panel, 'RESULTS POS PAYLOAD SHORT TERM', shows HDLC FRAMES, HDLC FCS, IP D/GRAM, IP HEADER, and BIT (selected). The 'BIT ERRORS' section displays a COUNT of 13118 and a RATIO of 1.000E-05. The ELAPSED TIME is 00d 00h 00m 30s. The bottom-right panel, 'FUNCTION SETTINGS CONTROL', shows TRANSMITTER AND RECEIVER COUPLED and RECEIVER COUPLED TO TRANSMITTER. A 'STATUS:' label is located below the results panel, and a 'SINGLE WINDOW' button is at the bottom right.

TRANSMITTER OUTPUT SONET		RECEIVER INPUT SONET	
JITTER	TEST FUNCTION	MAIN SETTINGS	STRUCT'D PAYLOAD
OVERHEAD SETUP	POS	ATM SETTINGS	POS SETTINGS
MORE	ERR & ALARM	MORE	SIGNAL
ERROR ADD TYPE	BIT	HAPPING <input checked="" type="checkbox"/>	STS-48C
RATE	1E-5	FULL SPE	POS
ALARM TYPE	OFF	TO SET POS SETTINGS, FIRST SELECT THE 'POS SETTINGS' FOLDER ABOVE	

RESULTS POS PAYLOAD SHORT TERM		FUNCTION SETTINGS CONTROL	
HDLC FRAMES	HDLC FCS	TRANSMITTER AND RECEIVER	COUPLED
IP D/GRAM	IP HEADER	RECEIVER COUPLED TO TRANSMITTER	
BIT			
BIT ERRORS			
COUNT	13118		
RATIO	1.000E-05		
ELAPSED TIME	00d 00h 00m 30s		

In our example we introduced POS bit errors at 1E-5, this is reflected in the Results page shown in the display above.

POS Service Disruption

Description

A common feature of modern secure networks is the ability to switch the user traffic to a backup path when the main path fails, or under administrative control. This can happen at the SONET layer, or at higher protocol layers (for example MPLS). The switching will usually only disrupt the traffic briefly, and the OmniBER can measure this disruption using the method described below.

Service disruption can be measured on a POS signal on the disrupted path or virtual path.

Measurement method

The measurement is made by sending and receiving a PRBS pattern at the IP layer. The detection of a service disruption is based on the detection of bit errors on the received PRBS. The disruption period is the time from the end of a received error-free packet to the occurrence of the next error-free word (32-bits) after any bit errors have been detected. The measurement is recorded only if 200ms of no bit errors occur after the disruption period.

POS Service Disruption measurement is only available when PRBS is chosen as the payload.

Measurement accuracy

Measurement accuracy is proportional to the packet rate. The packet rate in turn is dependent on 4 factors: packet size, inter-packet gap, stuffing ratio and bandwidth (see “What determines the packet rate?” page 205).

To maximize the accuracy of this measurement, the inter-packet gap should be kept to a minimum and the packets should be kept small. However, the resulting packet rate should not exceed the specification of the system under test. The measurement accuracy is typically $\pm 2 \times (1 \div \text{packet rate})$. For example a packet rate of 10,000 packets/s gives an accuracy of typically ± 0.2 milliseconds, which is accurate enough to measure typical disruptions of many milliseconds

Hence it is only practical to approximate the accuracy. For best results, the smallest possible inter-packet gap should be chosen along with the smallest possible packet size.

The figure on the next page illustrates the measurement technique and also shows how the packet size and rate affects the measurement accuracy.

Packet over SONET (POS) POS Service Disruption

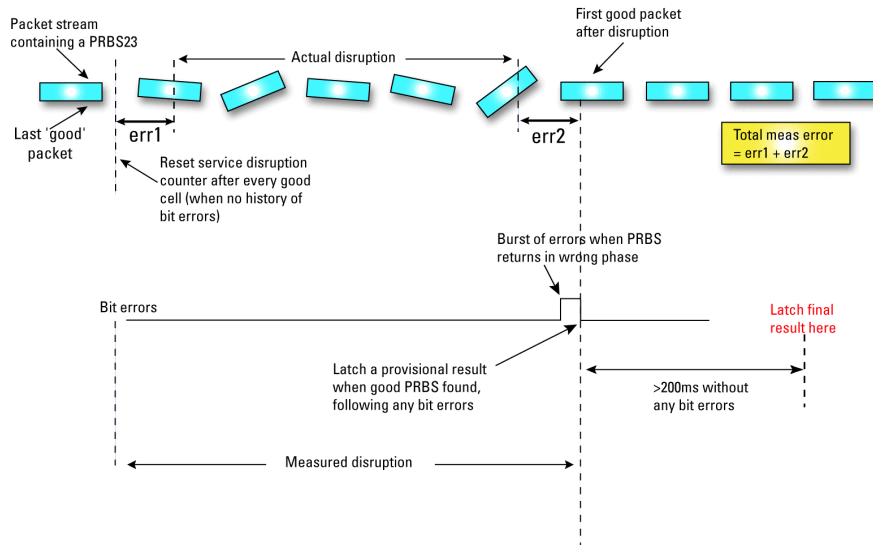

Set up the OmniBer to measure service disruption

How To

- 1 Set the Transmitter and Receiver to the same interface settings by choosing **OTHER SETTINGS CONTROL COUPLED**.
- 2 Set up the OmniBER to transmit a POS payload (see “Setting up the Transmitter for POS Payloads” page 181).
- 3 Select the **POS SETTINGS** folder.
- 4 Set the SETUP field to **IP PAYLOAD** and select **2²³-1 PRBS**.
- 5 Set the SETUP field to **PACKET SIZE/GAP** and set the IP datagram length and inter packet gap to suit your equipment under test. In the following example (on next page) we have set the datagram length and inter packet gap to give a packet rate of approximately 10,000 packets per second.

Packet over SONET (POS)

POS Service Disruption

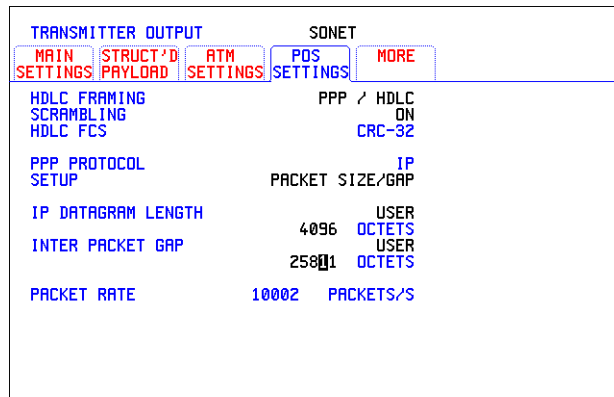

- 6 Press **RUN/STOP** to start the measurement.
- 7 Invoke the protection switch.
- 8 View the results on the **RESULTS**, **SERVICE DISRUPT** display.

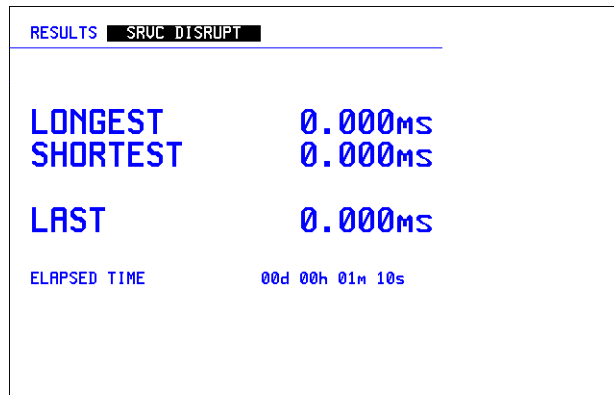

HDLC Frame Stuffing

Description

Each HDLC-like frame begins and ends with a flag sequence, which is the binary sequence 011111110 (hexadecimal 7E).

The IP data is examined on an octet by octet basis for the value 7E. If it occurs an escape sequence is used to replace any 7E octet with 7D-5E.

The 7D character is considered to be the 'escape' character so it needs to be replaced. 7D is converted to 7D-5D. The entire process is reversed at the receiver

Checking HDLC byte stuffing

To fully exercise the HDLC byte stuffing, patterns can be generated which deliberately contain a lot of stuff bytes. The IP payload can be set to a repeating 16-bit or 32-bit word pattern. Any byte of this word can be set to 7E (to emulate the flag sequence) or 7D (to emulate the escape sequence). OmniBer will 'escape' these bytes wherever they occur. For example, setting the user word pattern to 7E FF 7D FF will result in two extra escape bytes being stuffed into every 4-byte sequence during the payload.

A pattern such as 7E 7D 7D 7E will exercise the worst case stuffing rate.

Setting up the OmniBER to exercise HDLC byte stuffing

In the following example we set the PACKET SIZE/GAP to the instrument default settings (with 40 octet datagram length and 1 octet gap) and then select a User Word to create maximum stuffing, and note the change in Packet Rate due to stuffing.

How To

- 1 Set the Transmitter and Receiver to the same interface settings by choosing **OTHER SETTINGS CONTROL COUPLED**.
- 2 Set up the OmniBER to transmit a POS payload (see "Setting up the Transmitter for POS Payloads" page 181).
- 3 Select the **POS SETTINGS** folder.
- 4 Set the SETUP field to **IP PAYLOAD** and select **2^23-1 PRBS**.

Packet over SONET (POS)

HDLC Frame Stuffing

- 5 Set the SETUP field to **PACKET SIZE/GAP** and set the IP datagram length and inter packet gap to suit your equipment under test. In the following example we have set the datagram length and inter packet gap to the instrument default settings (see figure below).

TRANSMITTER OUTPUT		SONET	
MAIN SETTINGS	ATM SETTINGS	POS SETTINGS	JITTER MORE
HDLC FRAMING		PPP / HDLC	
SCRAMBLING		ON	
HDLC FCS		CRC-32	
PPP PROTOCOL		IP	
SETUP		PACKET SIZE/GAP	
IP DATAGRAM LENGTH		40	USER OCTETS
INTER PACKET GAP		1	USER OCTETS
PACKET RATE		6089352	PACKETS/S

STATUS:

PKT
SIZE/GAP

IP
HEADER

IP
ADDRESS

IP
PAYLOAD

MULTIPLE
WINDOW

- 6 Set the SETUP field to **IP PAYLOAD** and select **USER WORD**. Set the User Word to 32 BIT (HEX) 7E7D7D7E as shown below.

TRANSMITTER OUTPUT		SONET	
MAIN SETTINGS	ATM SETTINGS	POS SETTINGS	JITTER MORE
HDLC FRAMING		PPP / HDLC	
SCRAMBLING		ON	
HDLC FCS		CRC-32	
PPP PROTOCOL		IP	
SETUP		IP PAYLOAD	
PAYLOAD		USER WORD	
USER WORD LAYOUT		32 BIT (HEX)	
		7E7D7D7E	

STATUS:

DECREASE
DIGIT

INCREASE
DIGIT



MULTIPLE
WINDOW

Packet over SONET (POS)

HDLC Frame Stuffing

- 7 Set the SETUP field to **PACKET SIZE/GAP** and note that the PACKET/S rate has dropped due to stuffing caused by the selection of the User Word 7E7D7E7D.

TRANSMITTER OUTPUT		SONET		
MAIN SETTINGS	ATM SETTINGS	POS SETTINGS	JITTER	MORE
HDLC FRAMING		PPP / HDLC		
SCRAMBLING		ON		
HDLC FCS		CRC-32		
PPP PROTOCOL		IP		
SETUP		PACKET SIZE/GAP		
IP DATAGRAM LENGTH		40	USER	OCTETS
INTER PACKET GAP		1	USER	OCTETS
PACKET RATE		4340870		PACKETS/S

STATUS:

PKT
SIZE/GAP

IP
HEADER

IP
ADDRESS

IP
PAYLOAD

MULTIPLE
WINDOW

Jitter Tolerance Testing of POS Equipment

Jitter is present to a certain extent in all telecommunication networks, and can be defined simply as the movement in time of parts of a clock or data stream relative to where we expect to find them. Bit errors or data loss will occur in a digital signal if jitter at the input port of a network element exceeds a threshold value. It is important therefore that the network element be designed to tolerate a sufficient level of jitter, that is, does not introduce errors when certain values of jitter are present. The

ITU-T specifies the lower limit of maximum tolerable input jitter (MTIJ) in the form of an ITU-T jitter tolerance mask. The OmniBER provides a number of ITU-T masks for Jitter Tolerance testing, see “Measuring Jitter Tolerance” page 134.

Use the Jitter generation and measurement features of the OmniBER to verify the jitter tolerance of POS line cards.

Jitter/Wander Generation and Jitter Tolerance and Jitter Transfer tests are available at all SONET rates when a POS payload is selected.

Automatic Jitter Tolerance measurement is only available with a POS payload when the payload selected is 2²³-1PRBS.

Only a Jitter Tolerance example is given here, for information on Jitter Transfer and Wander measurements refer to “Measuring Jitter Transfer” page 138 and “Measuring Wander” page 131.

Jitter Tolerance method

Jitter is generated at a range of frequencies within the mask and an error measurement is made. If no errors occur (PASS), the jitter amplitude at that frequency point is increased until errors occur (FAIL) or the maximum jitter amplitude is reached. The highest jitter amplitude at which PASS occurs is plotted on the graph as the Jitter Tolerance for that jitter frequency.

User-Programmable Masks

There are 5 user programmable masks provided allowing you to create, edit and title up to 5 jitter masks. Please refer to “To Generate a New Jitter Mask” on page 299 and “To change the parameters of a User Defined Jitter Mask” on page 301 for instructions on how to generate or edit a user programmable mask.

Packet over SONET (POS) Jitter Tolerance Testing of POS Equipment

How To

Perform a Jitter Tolerance Measurement

- 1 Set up the transmitter and select a POS payload with a fixed $2^{23}-1$ PRBS (see "Setting up the Transmitter for POS Payloads " page 181) and "Setting IP Payload" page 190.
- 2 Select the **POS SETTINGS** folder as shown below.

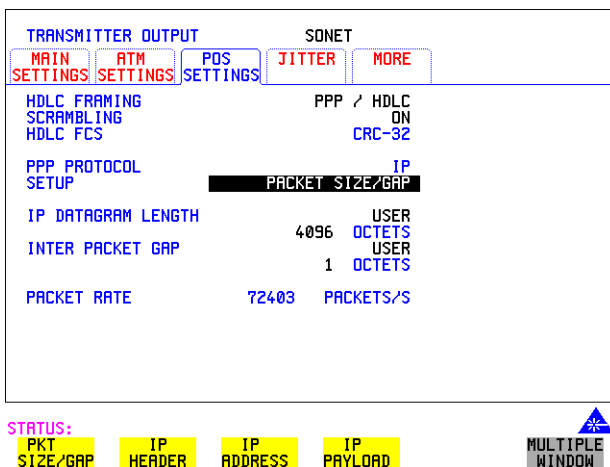

- 3 Set the SETUP field to **PACKET SIZE/GAP** and select a size as large as practical for the system under test (this gives better coverage for error detection). For this example we selected a length of 4096 and a gap of 1.
- 4 Select the IP DATAGRAM LENGTH field as required.
- 5 Set the INTER PACKET GAP as required (the smaller the better for increased coverage).
- 6 If you are performing jitter tolerance on a SONET Optical signal, check on the **RESULTS** **SONET RESULTS** **OPTICAL POWER** display that the measured optical power level falls within the white portion of the coloured bar. This ensures the accuracy of the Jitter results.
- 7 Set up the receiver for POS operation, see "Setting up the Receiver for POS Operation" page 193 and "Setting up the Receiver POS signal" page 195. Set the receiver payload to $2^{23}-1$ PRBS

Packet over SONET (POS) Jitter Tolerance Testing of POS Equipment

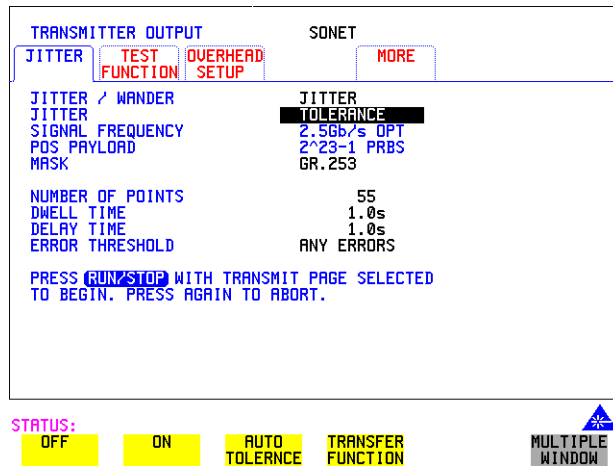

- 8 Select the **JITTER** folder and select AUTO TOLERANCE and a MASK (see display above).
- 9 Choose the NUMBER OF POINTS at which jitter is transmitted (3 to 55)
- 10 Choose the DWELL TIME - the time jitter is generated at each jitter frequency point (0.1 to 99.9 seconds).
- 11 Choose the DELAY TIME - the time delay between the jitter frequency/amplitude being applied and the error measurement being made. This allows the network equipment to settle as jitter frequency is changed. (0.1 to 99.9 seconds).
- 12 Set the ERROR THRESHOLD field to ANY ERRORS. Any BIT, BIP, FCS or header errors will result in a FAIL.
- 13 Press **RUN/STOP** to start the jitter auto tolerance measurement. The measurements progress can be monitored on the **TRANSMIT** display. At the end of the test the results can be viewed on the **TRANSMIT** or **RESULTS** displays. The **TRANSMIT** display is cleared when **TRANSMIT** is pressed but the results remain on the **RESULTS** display until the next jitter tolerance measurement is made.

Packet over SONET (POS)

Jitter Tolerance Testing of POS Equipment

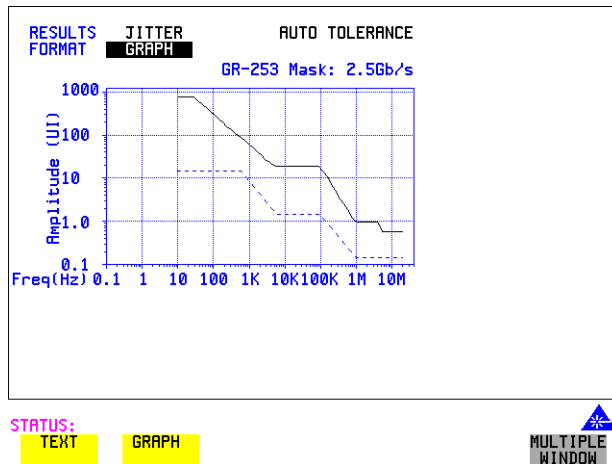

View the Results

14 Choose the results FORMAT.

If **GRAPH** is chosen, a plot of the jitter tolerance results against the ITU-T mask is displayed.

If **TEXT** is chosen, the results from which the graph is constructed are displayed, Point number, Frequency, Mask amplitude, Tolerance, Result.

If applicable, points 13 through 55 can be viewed on pages 2 through 5.

If you wish to log the jitter tolerance results to a printer, See “Logging Jitter Tolerance Results” page 245.

- “Saving Graphics Results to Instrument Store” page 222
- “Recalling Stored Graph Results” page 223
- “Viewing the Bar Graph Display” page 225
- “Viewing the Graphics Error and Alarm Summaries” page 227
- “Logging Graph Displays” page 229
- “Logging Results” page 231
- “Logging on Demand” page 241
- “Logging Jitter Tolerance Results” page 245
- “Logging Jitter Transfer Results” page 247
- “Logging Results to Parallel (Centronics) Printer” page 249
- “Logging Results to GP-IB Printer” page 250
- “Logging Results to Internal Printer” page 251
- “Logging Results to RS-232-C Printer” page 252
- “Printing Results from Disk” page 253
- “Connecting a Printer to a Parallel Port” page 254
- “Changing Internal Printer Paper” page 255
- “Cleaning Internal Printer Print Head” page 258

Storing, Logging and Printing

Saving Graphics Results to Instrument Store

Description

Graphical representation of measurement results is very useful particularly during a long measurement period. It provides an overview of the results and can be printed for record keeping.

Graphics results can be stored in instrument graph storage or on floppy disk.

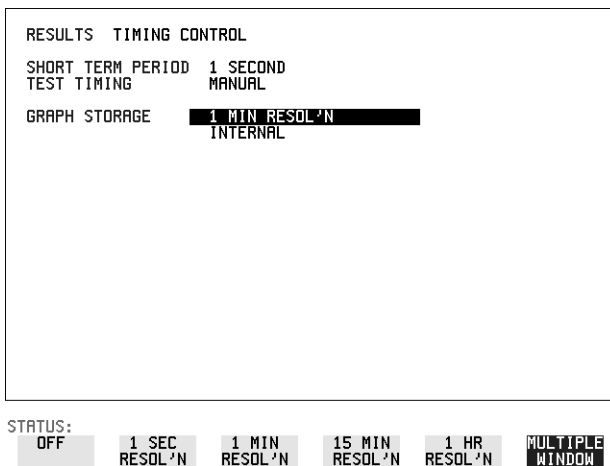

HOW TO:

- 1 Before starting your measurement, choose the GRAPH STORAGE resolution and location.
The resolution chosen affects the ZOOM capability when viewing the bar graphs. If 1 MIN is selected, 1 MIN/BAR, 15 MINS/BAR and 60 MINS/BAR are available. If 15 MINS is selected, 15 MINS/BAR and 60 MINS/BAR are available. If 1 HOUR is selected, 60 MINS/BAR is available.
The graphics results can be stored in the instrument - INTERNAL or stored on DISK. Storage to disk will use a default file name unless a file name is specified on the **OTHER FLOPPY DISK** display. See "Saving Graphical Results to Disk" page 274.
- 2 Press **RUN/STOP** to start the measurement. Graphical results will be stored in the chosen location.

Recalling Stored Graph Results

Description

Results stored from a previous measurement can be recalled to the graphics displays for viewing and printing.

STORE	START	START	TEST	STORE
	DATE	TIME	DURATION	USE
DISK				
-9				
-8				
-7				
-6				
-5				
-4				
-3				
-2	10-JUL-1997	15:20	16h 28m 34s	2%
-1	11-JUL-1997	07:50	00h 01m 04s	<1%
LAST	12-JUL-1997	07:51	00h 01m 19s	N11
STORAGE 1 SEC			TOTAL USED	2%
RESOL'N COMPRESSED			RAM FREE	98%
FREE STORE 19626 EVENTS				

STATUS:
GRAPH RESULTS **TEXT RESULTS** **DELETE STORE** **DELETE ALL** **MULTIPLE WINDOW**



HOW TO:

- 1 Press **GRAPH** to view the bar graph display.
- 2 If currently viewing the bar graph display, select **TEXT RESULTS** then **STORE STATUS**. If currently viewing the error or alarm summary, select **STORE STATUS**.
- 3 Using **↑** and **↓**, move the highlighted cursor to the store location which contains the required results.
If the required results are stored on Disk, move the highlighted cursor to DISK and choose RECALL GRAPHICS on the FLOPPY DISK display. See "Recalling Graphics Results from Disk" page 279.
- 4 Choose **GRAPH RESULTS** if you wish to view the bar graphs.
The display will change to the bar graph display of the highlighted results.
- 5 Choose **TEXT RESULTS** if you wish to view the error and alarm Summaries.
The display will change to the text results display of the highlighted results.
DELETE STORE deletes the results in the highlighted store.
If **DELETE ALL** is chosen, a **CONFIRM DELETE**; **ABORT DELETE** choice prevents accidental deletion of all the stored results.

Storing, Logging and Printing

Recalling Stored Graph Results

The top row of the display comprises five fields:

Store	Memory location in which the displayed bar graph data is stored. Move the highlighted cursor, to the STORE location desired, using  and  .
Start Date	The start date of the test, which produced the stored results.
Start Time	The start time of the test, which produced the stored results.
Test Duration	The duration of the test, which produced the stored results.
Store Use	The percentage (%) of the overall storage capacity occupied by each set of stored results. The TOTAL percentage used and the percentage still FREE is provided at the bottom of the STORE USE column.

Viewing the Bar Graph Display

Description

All the graphic results obtained during the measurement are available for viewing. Identify a period of interest and zoom in for more detailed examination.

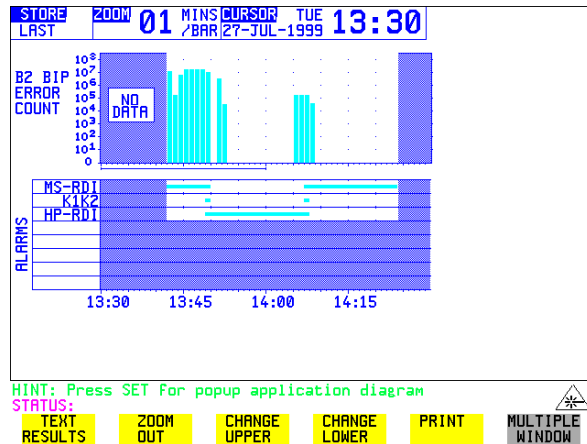

HOW TO:

- 1 To view the current bar graphs, press **GRAPH** and use **CHANGE UPPER** and **CHANGE LOWER** to obtain the bar graphs required.
- 2 To view previously stored graphs, see "Recalling Stored Graph Results " page 223.
- 3 For more detailed inspection of the bar graph, position the cursor centrally within the area of interest using **→**, **←** and select **ZOOM IN** to reduce the time axis to 15 MINS/BAR. This is only possible if the graphics results were stored with a STORAGE resolution of 1 SEC,1 MINS or 15 MINS.
For further reduction of the time axis to 01 MINS/BAR or 01 SECS/BAR, position the cursor centrally within the area of interest and select **ZOOM IN** until the required time axis is obtained.

The top row of the display comprises three fields:

Store



Memory location in which the displayed bar graph data is stored. Store can only be changed when the status of stored results is displayed. See "Recalling Stored Graph Results " page 223.

Zoom

The width, in minutes, of each "bar" in the bar graph, controlled by **ZOOM IN** / **ZOOM OUT** .

Storing, Logging and Printing
Viewing the Bar Graph Display

Cursor

The cursor position in terms of time and date, controlled by  and . The cursor position changes in steps of 1 second, 1 minute, 15 minutes or 60 minutes dependent upon the ZOOM setting. The cursor is physically located between the two graphs.

Viewing the Graphics Error and Alarm Summaries

Description

The error and alarm summaries of the measurement chosen are displayed on the **TEXT RESULTS** display. The error summary or alarm summary can be viewed at any time.

STORE	START	14:28	STOP	14:48
-1	TUE 8-SEP-1998		TUE 8-SEP-1998	
DSn ERROR SUMMARY				
	COUNT		RATIO	
BIT	261865		1.423E-04	
BPU	202187		3.715E-06	
DS3 FRAME	838		2.369E-06	
DS1 FRAME	12		1.877E-06	
P-BIT	224151		4.197E-06	
C-BIT	50271		9.424E-07	
FEBE	16981		3.202E-07	
CRC	N/A		N/A	

STATUS:

STORE STATUS	GRAPH RESULTS	PRINT	NEXT SUMMARY	ALARM SUMMARY	MULTIPLE WINDOW
--------------	---------------	-------	--------------	---------------	-----------------

HOW TO:

- 1 To view the error or alarm summary associated with the current bar graphs, press **GRAPH** then **TEXT RESULTS**.
- 2 To view the error or alarm summary associated with previously stored bar graphs, see "Recalling Stored Graph Results " page 223.
- 3 To view the Alarms which have occurred during the measurement, select **ALARM SUMMARY**. Use **NEXT SUMMARY** to view the PDH/DSn; and SDH Alarm Summaries in turn if applicable.
- 4 To view the Errors which have occurred during the measurement select **ERROR SUMMARY**. Use **NEXT SUMMARY** to view the PDH/DSn; and SDH Error Summaries in turn if applicable.

The top row of the display comprises three fields:

Store Memory location in which the bar graphs, error summary and alarm summary are stored.
Store can only be changed when the status of stored results is displayed. See "Recalling Stored Graph Results " page 223.

Storing, Logging and Printing

Viewing the Graphics Error and Alarm Summaries

Start	The start time and date of the test, that produced the displayed results.
Stop	The stop time and date of the test, that produced the displayed results.

Logging Graph Displays

Description

The bar graphs and error and alarm summaries can be logged to the disk for printing at a later date or logged to an internal printer if Option 602 is fitted.

If Option 601, Remote Control, is fitted, the bar graphs and error and alarm summary can be logged to an external Printer at the end of the test period. If a Printer is not immediately available, the graphics results remain in memory and can be logged at a later time when a Printer becomes available. Suitable HP Printers are the HP 660, HP 690C, HP 500 or HP 400.

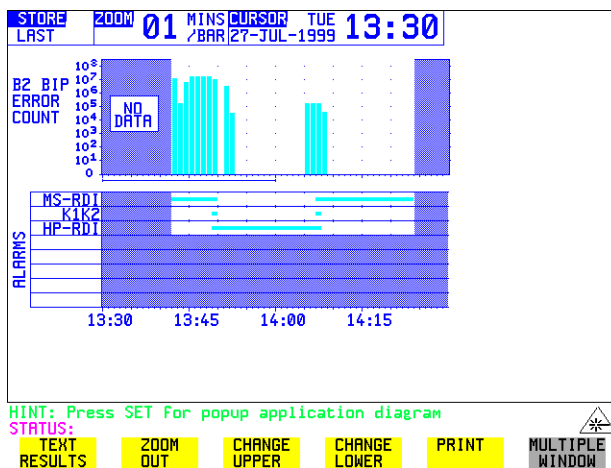

HOW TO:

Log to a Printer

- 1 Choose the logging DEVICE.

The logging device can be selected on the **OTHER LOGGING** display when SETUP is set to **LOGGING DEVICE**. For more details on the choice of devices and how to setup the instrument to interface with them please refer to the following sections:

- RS232: “Logging Results to RS-232-C Printer” page 252.
- GPIB: “Logging Results to GP-IB Printer” page 250
- PARALLEL: “Logging Results to Parallel (Centronics) Printer” page 249.
- INTERNAL (only if Option 602, Internal Printer, is fitted): “Logging Results to Internal Printer” page 251.

Storing, Logging and Printing

Logging Graph Displays

- 2 Press **GRAPH** to view the bar graph display. To log the Error and Alarm summaries, the displayed Bar graphs and the Alarm graph to the printer, choose **PRINT** on the bar graph display.
- 3 Choose to confirm or abort the print.
To confirm the print and only print the portion of the graph displayed and the summaries choose **THIS SCREEN**.
To confirm the print and print the graph for the whole measurement period and the summaries choose **CURSOR TO END**.
To abort the print choose **ABORT**.
- 4 To log the selected Error and Alarm summaries to the printer, choose **PRINT** on the Text Results display.

HOW TO:

Log to the Internal Disk Drive

- 1 Insert a floppy disk in the disk drive.
- 2 Choose LOGGING PORT **DISK** on the **OTHER LOGGING** display.
Enter a filename on the **OTHER FLOPPY DISK** display. See "Saving Data Logging to Disk " page 276.
- 3 Press **GRAPH** to view the bar graph display. To log the Error and Alarm summaries, the displayed Bar graphs and the Alarm graph to the disk, choose **PRINT** on the bar graph display.
- 4 Choose to confirm or abort the print.
To confirm the print and only print the portion of the graph displayed and the summaries choose **THIS SCREEN**.
To confirm the print and print the graph for the whole measurement period and the summaries choose **CURSOR TO END**.
To abort the print choose **ABORT**.
- 5 To log the selected Error and Alarm summaries to the disk, choose **PRINT** on the Text Results display.

Logging Results

Description

Test Period Logging

If degradations in system performance can be observed at an early stage, then the appropriate remedial action can be taken to maximize circuit availability and avoid system crashes.

Test period logging allows you to monitor the error performance of your circuit over a user defined test period. If required, results can be logged at regular intervals during this test period but, regardless of whether or not Periodic Logging is selected, the results will be logged at the end of the test period. An instant summary of the results can also be demanded by pressing **PRINT NOW**. This will not affect any test period in progress.

The user can choose to log all available results or else a subset of the available results (e.g. Errors, Jitter, G.826, M.2100 etc.). This means the logging output can be tailored to contain only the results that are of particular interest.

Error Event Logging

Manual tracing of intermittent faults is time consuming. Error event logging allows you to carry out unattended long term monitoring of the circuit. Each occurrence of an error event is logged.

Any Alarm occurrence results in a timed and dated message being logged.

Logging Output

The results can be logged to the following devices:

- Optional Internal printer fitted into the instrument front cover (Option 602)
- External GP-IB printer (option 601)
- External RS-232-C printer (option 601)
- External Parallel Port printer (option 601)
- Internal Disk Drive

HOW TO:

Selecting Logging Device

The logging device can be selected on the **OTHER LOGGING** display when SETUP is set to **LOGGING DEVICE**. For more details on the choice of devices

Storing, Logging and Printing

Logging Results

and how to setup the instrument to interface with them please refer to the following sections:

- RS232: “Logging Results to RS-232-C Printer” page 252.
- GPIB: “Logging Results to GP-IB Printer” page 250
- PARALLEL: “Logging Results to Parallel (Centronics) Printer” page 249.
- DISK: “Saving Data Logging to Disk” page 276.
- INTERNAL (only if Option 602, Internal Printer, is fitted): “Logging Results to Internal Printer” page 251.

Enabling Test Period Logging

To enable Test Period Logging first select the **OTHER LOGGING** display and then set TEST PERIOD LOGGING to be **ON**. For more information on setting up the actual Test Period (i.e. Gating Period) please refer to the “Test Timing” page 111 Section.

FUNCTION	LOGGING
TEST PERIOD LOGGING	ON
SETUP	CONTENT
LOG ERROR RESULTS	ON
LOG JITTER RESULTS	ON
LOG G.821 RESULTS	ON
LOG G.826 RESULTS	ON
LOG M.2100 RESULTS	ON
LOG M.2101 RESULTS	ON
LOG M.2110 RESULTS	ON
LOG M.2120 RESULTS	ON
LOG ERROR SECONDS	OFF

STATUS:

LOGGING DEVICE	LOGGING CONTENT	LOGGING PERIOD	LOG ON DEMAND	MULTIPLE WINDOW
----------------	-----------------	----------------	---------------	-----------------

Selecting Logging Content

The SETUP **LOGGING CONTENT** selection on the **OTHER LOGGING** display allows the user to choose which type of results they wish to log. For example if they only wished to log the G.821 and G.826 Analysis Results then they would simply set LOG G.821 RESULTS and LOG G.826 RESULTS to be **ON** while setting all the other selections to be **OFF**. There is no restriction as to what

Storing, Logging and Printing

Logging Results

result selection is made but please note that the selections all default to be **ON** so that all results are logged by default.

When TEST PERIOD LOGGING is set to **ON** then there is a LOG ERROR SECONDS selection on the SETUP **LOGGING CONTENT** display. Setting LOG ERROR SECONDS to be **ON** means that, if errors are detected during the Test Period, then a timed and dated message is logged each time an error second occurs. The message will contain the type of error detected and the number of errors of that type which were received in the error second. Note that if there are excessive occurrences of error seconds during a Test Period then having this selection switched **ON** will result in heavy use of printer paper.

Selecting Logging Period

FUNCTION	LOGGING
TEST PERIOD LOGGING	ON
SETUP	PERIOD
LOGGING PERIOD	OFF

STATUS: OFF 10 MINS 1 HOUR 24 HOURS USER PROGRAM MULTIPLE WINDOW

As well as logging results at the end of the Test Period, the user can also select a logging period. The logging period is setup via SETUP **LOGGING PERIOD** on the **OTHER LOGGING** display. At the end of each of these logging periods results will be logged. Note that this selection is only offered when TEST PERIOD LOGGING is set to **ON**.

The length of the logging period is setup using the LOGGING PERIOD selection. This offers a number of preset intervals along with a USER PROGRAM choice which provides a choice of 10 minutes to 99 hours. The actual logging period chosen by the user should be of a shorter duration than the test period in order that results can be logged periodically within the test period.

Storing, Logging and Printing

Logging Results

When a logging period is selected, then the user can choose whether **ALL** results are to be logged at the end of each period or a **SELECTED** subset. Note that this selection is in addition to that already made on the SETUP **LOGGING CONTENT** page.

The WHEN selection allows the user to have results logged **ALWAYS** at the end of each logging period or only when the error count for the logging period is greater than 0 i.e. **PERIOD EC>0** . If the error count is 0 then the message NO BIT ERRORS is displayed.

The TYPE selection allows the user to choose whether the results logged at the end of each period are the Cumulative Results, Period Results or both. The definitions for these two result types are as follows:

Period Results: The Results obtained over a set period of time during the test i.e. the logging period.

Cumulative Results: The results obtained over the elapsed time since the start of the test period.

Logging Results Examples

There are four phases of results logging:

- Start of measurement - Header is logged
- During the measurement - Alarm events and if enabled error events
- End of logging period - Complete set of period and cumulative results
- End of measurement - Complete set of cumulative results.

Logging Header

When the measurement is started the logging header provides a record of the instrument configuration that produced the results (see following pages).

Storing, Logging and Printing

Logging Results

```

=====
|
|                               OmniBER 37718
|                               Instrument Configuration
|-----
|
| Receive Signal   : OC-48                STS-3 under test   : 1
| Mapping         : STS-1   VT2          ASYNC 2Mb/s
| Selected STS-1  : STS-1[1]
| Selected VT     : VTGRP[1] VT[1]
| Payload (Struct): PCM30CRC
| Test Signal     : 64kb/s
| Tributaries     :                               64kb [ 1]
| Pattern         : 2^11-1                Polarity         : NORMAL
| Range           : 64 UI                  Filter           : HPI
| Hit Threshold   : 1.0 UI
|
| MEASUREMENT STARTED 07 Sep 00 10:01:17      Print Period OFF
|-----

```

Logging During Measurement

During the measurement a timed and dated message is logged each time an alarm occurs, and if LOG ERROR SECONDS [ON] is chosen a timed and dated message is logged each time an error second occurs (excessive occurrences of error seconds during the logging period will result in heavy use of printer paper).

```

| 10:03:35 CV-S (B1)           500
| 10:03:36 CV-S (B1)           900
| 10:03:38 CV-L (B2)           300
| 10:03:39 CV-L (B2)           600
| 10:03:41 CV-P (B3)           900
| 10:03:42 CV-P (B3)          1000
| 10:03:44 CV-P (B3)           300
| 10:03:45 A1A2 FRAME          700
| 10:03:46 A1A2 FRAME          100
| 10:03:48 REI-L               100
| 10:03:50 REI-L              1000
| 10:03:51 REI-L              1000
| 10:03:53 REI-P               300
| 10:03:54 REI-P              1000
| 10:03:56 REI-P               700
| 10:04:00 CV-V               1000

```

Storing, Logging and Printing Logging Results

```

| 10:04:01 CV-V          1000          |
| 10:04:03 CV-V          200          |
| 10:04:07 RDI-V         SET          |
| 10:04:09 RDI-P         SET          |
| 10:04:10 Pattern Loss  SET          |
| 10:04:11 SEF           SET          |
| 10:04:17 RDI-V         CLEAR        |
| 10:04:19 RDI-P         CLEAR        |
| 10:04:21 Pattern Loss  CLEAR        |
| 10:04:22 SEF           CLEAR        |
| 10:04:22              ALL ALARMS CLEAR |

```

Logging at the End of Measurement

At the end of the measurement a complete set of cumulative results are logged. At the end of each LOGGING PERIOD a complete set of Period results and a full set of cumulative results are logged.

```

|=====|
| MEASUREMENT COMPLETE 07 Sep 00 10:05:57      Elapsed Time 00d 00h 00m 01s |
|=====|
|
|                          Cumulative Results
|
| Error Results :
|
|          A1A2 FRAME  CV-S (B1)  CV-L (B2)      REI-L  CV-P (B3) |
| Error Count          0          0          0          0          0 |
| Error Ratio          0          0          0          0          0 |
|
|          REI-P      CV-V      REI-V
| Error Count          0          0          0
| Error Ratio          0          0          0
|
|
|          FAS 140M  FAS 34M  FAS 8M  FAS 2M |
| Error Count          N/A      N/A      N/A      0 |
| Error Ratio          N/A      N/A      N/A      0 |
|
|          BIT      CODE      CRC      REBE |
| Error Count          0      N/A      0      0 |
| Error Ratio          0      N/A      0      0 |
|

```

Storing, Logging and Printing Logging Results

JITTER				
Hit Count				0
Hit Seconds				0
Hit Free Seconds				1
Positive Peak				0.010
Negative Peak				0.010
Peak-to-Peak				0.020
RMS				0.006
Analysis Results :				
G.826 ANALYSIS				
	CV-S (B1)	CV-L (B2)	REI-L	CV-P (B3)
Errored Blocks	0	0	0	0
Errored Seconds	0	0	0	0
Severely Errored Seconds	0	0	0	0
Unavailable Seconds	0	0	0	0
Path Unavailable Seconds	N/A	0	0	0
Background Block Errors	0	0	0	0
Errored Second Ratio	0	0	0	0
Severely Errored Sec Ratio	0	0	0	0
Background Block Err Ratio	0	0	0	0
	REI-P	CV-V	REI-V	
Errored Blocks	0	0	0	
Errored Seconds	0	0	0	
Severely Errored Seconds	0	0	0	
Unavailable Seconds	0	0	0	
Path Unavailable Seconds	0	0	0	
Background Block Errors	0	0	0	
Errored Second Ratio	0	0	0	
Severely Errored Sec Ratio	0	0	0	
Background Block Err Ratio	0	0	0	

Storing, Logging and Printing Logging Results

M.2101 ANALYSIS					
	Section		High Order Path		
	Rx	Tx	Rx	Tx	
Errored Seconds	0	0	0	0	
Severely Errored Seconds	0	0	0	0	
Unavailable Seconds	0	0	0	0	
	Low Order Path		Rx	Tx	
Errored Seconds	0	0			
Severely Errored Seconds	0	0			
Unavailable Seconds	0	0			
G.821 ANALYSIS					
	BIT	FAS 140M	FAS 34M	FAS 8M	FAS 2M
Errored Sec	0	N/A	N/A	N/A	0
%Errored Sec	0.00000	N/A	N/A	N/A	0.00000
%ES (Annex D)	0.00000	N/A	N/A	N/A	N/A
Error Free Sec	1	N/A	N/A	N/A	1
%Error Free Sec	100	N/A	N/A	N/A	100
Severely Err Sec	0	N/A	N/A	N/A	0
%Severely Err Sec	0.00000	N/A	N/A	N/A	0.00000
Degraded Minutes	0	N/A	N/A	N/A	0
%Degraded Minutes	0.00000	N/A	N/A	N/A	0.00000
Unavailable Sec	0	N/A	N/A	N/A	0
%Unavailable Sec	0.00000	N/A	N/A	N/A	0.00000
			CODE	CRC4	REBE
Errored Sec			N/A	0	0
%Errored Sec			N/A	0.00000	0.00000
Error Free Sec			N/A	1	1
%Error Free Sec			N/A	100	100
Severely Err Sec			N/A	0	0
%Severely Err Sec			N/A	0.00000	0.00000
Degraded Minutes			N/A	0	0
%Degraded Minutes			N/A	0.00000	0.00000
Unavailable Sec			N/A	0	0
%Unavailable Sec			N/A	0.00000	0.00000

Storing, Logging and Printing

Logging Results

G.826 ANALYSIS						
	Near	8Mb/s	Far	Near	2Mb/s	Far
Errored Blocks	N/A		N/A	0		0
Errored Seconds	N/A		N/A	0		0
Severely Errored Seconds	N/A		N/A	0		0
Unavailable Seconds	N/A		N/A	0		0
Path Unavailable Seconds	N/A		N/A	0		0
Background Block Errors	N/A		N/A	0		0
Errored Second Ratio	N/A		N/A	0		0
Severely Errored Sec Ratio	N/A		N/A	0		0
Background Block Err Ratio	N/A		N/A	0		0
BIT Errors						
Errored Blocks		0				
Errored Seconds		0				
Severely Errored Seconds		0				
Unavailable Seconds		0				
Background Block Errors		0				
Errored Second Ratio		0				
Severely Errored Sec Ratio		0				
Background Block Err Ratio		0				
M.2100 ANALYSIS						
	Rx	8Mb/s	Tx	Rx	2Mb/s	Tx
Errored Seconds	N/A		N/A	0		0
Severely Errored Seconds	N/A		N/A	0		0
Unavailable Seconds	N/A		N/A	0		0
64k Rx						
Errored Seconds		0				
Severely Errored Seconds		0				
Unavailable Seconds		0				
M.2110 ANALYSIS						
	15-min	1-hr	2-hr	24-hr	7-day	
BIS Results	WAIT	WAIT	WAIT	WAIT	WAIT	

Storing, Logging and Printing

Logging Results

```
|
| Frequency :      0.0 kHz      Offset :      O/R kHz      Offset :      O/Rppm |
| Power Level :  -13.9 dBm     STM-16o OPTICAL |
|
| Pointer Results :           SPE POINTER           VT POINTER |
|                               Count      Seconds      Count      Seconds |
| NDF                               0                               0 |
| Missing NDF                       0                               0 |
| +ve Pointer Adjustments           0           0           0           0 |
| -ve Pointer Adjustments           0           0           0           0 |
| Implied VC Offset                 0.0                   0.0 |
| Pointer Value                      0                   664 |
|=====|
```

Logging on Demand

Description

When **PRINT NOW** is pressed the chosen results are logged to the chosen logging device. The choice of results for logging is:

- RESULTS SNAPSHOT - last recorded measurement results
- OVERHEAD SNAPSHOT - last recorded overhead values of the chosen STM-N
- OVERHEAD CAPTURE - Overhead Capture display
- POINTER GRAPH - Pointer Graph display
- SONET TRIBUTARY SCAN - SONET Tributary Scan display
- SONET ALARM SCAN - SONET Alarm Scan display
- SCREEN DUMP - allows logging of the chosen display

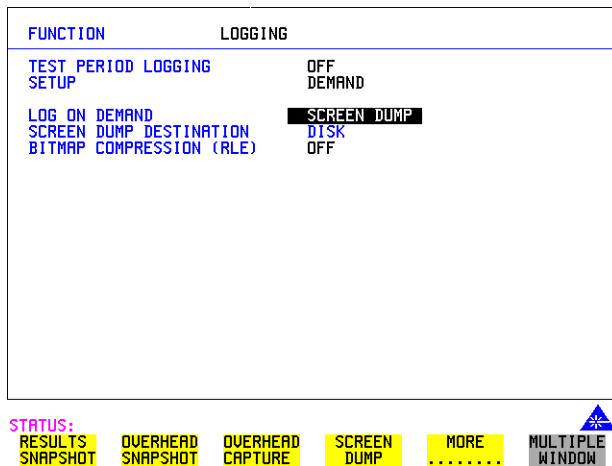

HOW TO:

- 1 Choose LOG ON DEMAND to determine results to be logged when **PRINT NOW** is pressed.
SCREEN DUMP allows you to log the selected display when **PRINT NOW** is pressed. (Logging or Disk displays cannot be logged using this feature).
- 2 Choose the logging DEVICE.
The logging device can be selected on the **OTHER LOGGING** display when SETUP is set to **LOGGING DEVICE**. For more details on the choice of devices and how to setup the instrument to interface with them please refer to the following sections:
 - RS232: “Logging Results to RS-232-C Printer” page 252.

Storing, Logging and Printing

Logging on Demand

- GPIB: “Logging Results to GP-IB Printer” page 250.
- PARALLEL: “Logging Results to Parallel (Centronics) Printer” page 249.
- DISK: “Saving Data Logging to Disk” page 276. If SCREEN DUMP is chosen then please refer to “Saving a Screen Dump to Disk” page 272.
- INTERNAL (only if Option 602, Internal Printer, is fitted): “Logging Results to Internal Printer” page 251.

Log on Demand Examples

Overhead Capture, Pointer Graph, SONET Tributary Scan and SONET Alarm Scan logging are copies of the relevant display. Screen Dump logs a copy of the selected display (not Logging or Disk displays).

Overhead Snapshot

Overhead Snapshot provides the value of each byte of overhead in the STS-3 chosen for test.

```
=====|
| 10:07:29 PRINT DEMANDED- O/H SNAPSHOT          Elapsed Time  00d 00h 00m 01s|
|=====|
|           | Setup : OC-48                       |
|-----|
|      SOH (STS-3 #1 )                          |
|-----+-----+-----+-----+-----+-----+-----+-----+-----+|
| A1 | 41 00 00 | A2 | 40 00 00 | J0 | 00 00 00 | J0 Path Trace:          |
| B1 | 00 00 00 | E1 | 00 00 00 | F1 | 00 00 00 | " "                               |
| D1 | 00 00 00 | D2 | 00 00 00 | D3 | 00 00 00 | E.164 CRC NOT FOUND            |
| H1 | 00 00 00 | H2 | 00 00 00 | H3 | 00 00 00 | S1 Sync Status:                |
| B2 | 00 00 00 | K1 | 00 00 00 | K2 | 00 00 00 | SYNCHRONIZED TRACE UNKN|
| D4 | 00 00 00 | D5 | 00 00 00 | D6 | 00 00 00 |
| D7 | 00 00 00 | D8 | 00 00 00 | D9 | 00 00 00 |
| D10| 00 00 00 | D11| 00 00 00 | D12| 00 00 00 |
| S1 | 00 00 00 | Z2 | 00 00 00 | E2 | 00 00 00 |
|-----+-----+-----+-----+-----+-----+-----+-----+|
| STS POH          TYPE SPE          | VT POH          TYPE VTSPE          |
| WITHIN STS-3 #1          |          |          |          |          |
|-----+-----+-----+-----+-----+-----+-----+-----+|
|          | STS Path Label (C2):          |          | VT Path Label (V5):          | | |
| J1 | 00 "UNEQUIPPED          | " | V5 | 00 "000 UNEQUIPPED          |
| B3 | 00          |          | J2 | 00          |          |
```

Storing, Logging and Printing

Logging on Demand

```

| C2 | 00 | J1 Path Trace:          | Z6 | 00 | J2 Path Trace:          |
| G1 | 00 | "~~~~~"                | Z7 | 00 | "~~~~~"                |
| F2 | 00 | "          "           |    |    | E.164 CRC NOT FOUND    |
| H4 | 00 | "          U          " |    |    |                          |
| Z3 | 00 | "          "           |    |    |                          |
| Z4 | 00 |                          |    |    |                          |
| N1 | 00 |                          |    |    |                          |

```

Results Snapshot

Results Snapshot provides a Header listing the instrument settings that produced the results and the last recorded, complete set of cumulative measurement results.

```

=====
| 10:08:20 PRINT DEMANDED- RESULTS SNAPSHOT      Elapsed Time  00d 00h 00m 01s|
=====
|
|                          Cumulative Results                          |
|
| Error Results :                                                    |
|
|          A1A2 FRAME  CV-S (B1)  CV-L (B2)      REI-L  CV-P (B3) |
| Error Count          0          0          0          0          0 |
| Error Ratio          0          0          0          0          0 |
|
|          REI-P        CV-V        REI-V          |
| Error Count          0          0          0          |
| Error Ratio          0          0          0          |
|
|          FAS 140M    FAS 34M    FAS 8M    FAS 2M |
| Error Count          N/A        N/A        N/A        0 |
| Error Ratio          N/A        N/A        N/A        0 |
|
|          BIT        CODE        CRC        REBE |
| Error Count          0        N/A        0        0 |
| Error Ratio          0        N/A        0        0 |
|
| Frequency :          0.0 kHz      Offset :    O/R kHz      Offset :    O/Rppm |
| Power Level :      -13.9 dBm      STM-16o OPTICAL          |
|

```

Storing, Logging and Printing Logging on Demand

Pointer Results :	SPE POINTER		VT POINTER		
	Count	Seconds	Count	Seconds	
NDF		0		0	
Missing NDF		0		0	
+ve Pointer Adjustments	0	0	0	0	
-ve Pointer Adjustments	0	0	0	0	
Implied VC Offset	0.0		0.0		
Pointer Value	0		664		
=====					

Logging Jitter Tolerance Results

Description

The jitter auto tolerance feature provides jitter tolerance measurements within the relevant mask, BELLCORE GR-253 and GR-499 for SONET.

You can log the jitter auto tolerance results to a printer for record keeping purposes. The **GRAPH** version and the **TEXT** version of the jitter tolerance results can be logged to a printer.

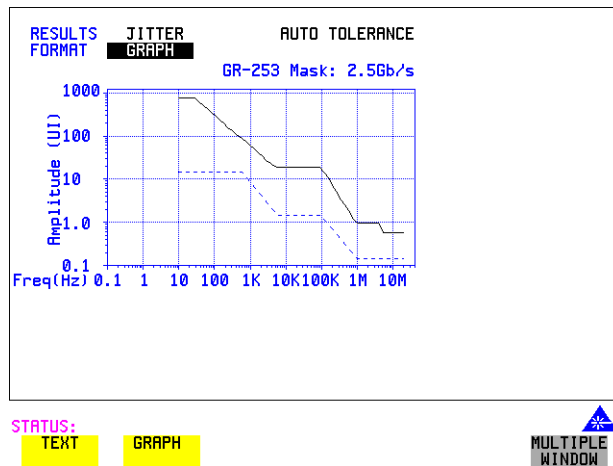

HOW TO:

- 1 Choose the logging DEVICE.
The logging device can be selected on the **OTHER LOGGING** display when SETUP is set to **LOGGING DEVICE**. For more details on the choice of devices and how to setup the instrument to interface with them please refer to the following sections:
 - RS232: “Logging Results to RS-232-C Printer” page 252.
 - GPIB: “Logging Results to GP-IB Printer” page 250
 - PARALLEL: “Logging Results to Parallel (Centronics) Printer” page 249.
 - INTERNAL (only if Option 602, Internal Printer, is fitted): “Logging Results to Internal Printer” page 251.

Storing, Logging and Printing

Logging Jitter Tolerance Results

- 2 Choose **GRAPH** on the **RESULTS** **AUTO TOLER** display or choose **TEXT** on the **RESULTS** **AUTO TOLER** display, if you wish to log the graph and text results to the printer.
- 3 Press **PRINT NOW** to log the chosen results to the printer.

Logging Jitter Transfer Results

Description

The jitter transfer feature provides jitter transfer measurements within the relevant mask, GR-499/G.824 for DS_n and GR.253 for SONET.

You can log the jitter transfer results to a printer for record keeping purposes. The **GRAPH** version and the **TEXT** version of the jitter transfer results can be logged to a printer.

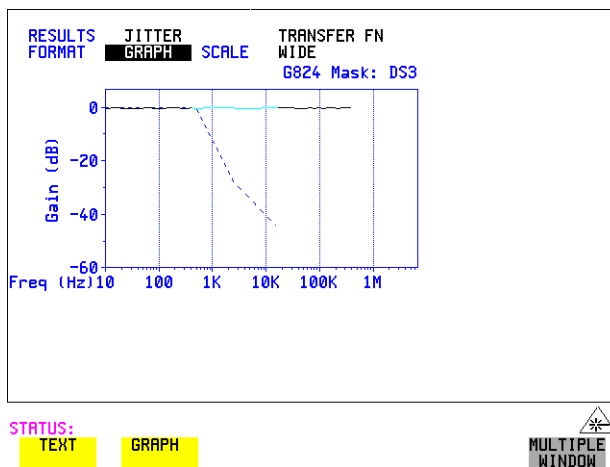

HOW TO:

- 1 Choose the logging DEVICE.
The logging device can be selected on the **OTHER LOGGING** display when SETUP is set to **LOGGING DEVICE**. For more details on the choice of devices and how to setup the instrument to interface with them please refer to the following sections:
 - RS232: “Logging Results to RS-232-C Printer” page 252.
 - GPIB: “Logging Results to GP-IB Printer” page 250
 - PARALLEL: “Logging Results to Parallel (Centronics) Printer” page 249.
 - INTERNAL (only if Option 602, Internal Printer, is fitted): “Logging Results to Internal Printer” page 251.
- 2 Choose **GRAPH** on the **RESULTS JITTER TN FUNCTION** display or choose TEXT on the **RESULTS JITTER TN FUNCTION** display if you wish to log the graph and text results to the printer.

Storing, Logging and Printing
Logging Jitter Transfer Results

- 3 Press **PRINT NOW** to log the chosen results to the printer.

Logging Results to Parallel (Centronics) Printer

Description

If Option 601, Remote Control Interface, is fitted, you can log the results and alarms to an external Parallel printer connected to the PARALLEL port. The Parallel port provides a standard IEEE 1284-A compatible interface.

FUNCTION	LOGGING
TEST PERIOD LOGGING SETUP	OFF DEVICE
LOGGING PORT	PARALLEL
REMOTE CONTROL PORT	GPIB
PRINTER TYPE	HP PRINTER

STATUS: RS232 GPIB DISK PARALLEL

MULTIPLE WINDOW

CAUTION

Damage to the instrument may result if a serial connection is made to this port.

HOW TO:

- 1 Connect the Parallel printer to the PARALLEL port. See "Connecting a Printer to a Parallel Port " page 254.
- 2 If a non HP printer is connected then set PRINTER TYPE to be **ALT. PRINTER** . Set MODE to be **NORMAL** (80 character column width) or **COMPRESS** (40 character column width) according to the capabilities of your printer.
- 3 See "Logging Results " page 231 or "Logging on Demand " page 241 for more details on selecting the type of Results you wish to log.

Storing, Logging and Printing Logging Results to GP-IB Printer

Logging Results to GP-IB Printer

Description

If Option 601, Remote Control Interface, is fitted, you can log the results and alarms to an external GP-IB printer connected to the GP-IB port.

FUNCTION	LOGGING
TEST PERIOD LOGGING SETUP	OFF DEVICE
LOGGING PORT	GP-IB
REMOTE CONTROL PORT	RS232

STATUS: RS232 GP-IB DISK PARALLEL MULTIPLE WINDOW

HOW TO:

- 1 Connect an GP-IB printer to the GPIB port.

NOTE

Choosing GP-IB external printer for logging prevents the use of GP-IB remote control.

- 2 See "Logging Results " page 225 or "Logging on Demand " page 233 for more details on selecting the type of Results you wish to log.

Storing, Logging and Printing Logging Results to Internal Printer

Logging Results to Internal Printer

Description

If Option 602, Internal Printer is fitted, you can log the results and alarms to the in-lid printer.

FUNCTION	LOGGING
TEST PERIOD LOGGING SETUP	ON DEVICE
LOGGING PORT REMOTE CONTROL PORT	INTERNAL GP1B

STATUS:

INTERNAL **RS232** **GP1B** **DISK** **PARALLEL** **MULTIPLE WINDOW**

HOW TO:

- 1 See "Logging Results " page 225 or "Logging on Demand " page 233 for more details on selecting the type of Results you wish to log.

Storing, Logging and Printing

Logging Results to RS-232-C Printer

Logging Results to RS-232-C Printer

Description

If Option 601, Remote Control Interface, is fitted, you can log the results and alarms to an external RS-232-C printer connected to the RS-232-C port.

FUNCTION	LOGGING
TEST PERIOD LOGGING SETUP	OFF DEVICE
LOGGING PORT	RS232
REMOTE CONTROL PORT	LAN
PRINTER TYPE	HP PRINTER
SPEED	9600 BAUD
PROTOCOL	XON/XOFF

STATUS:

RS232

GP1B

DISK

PARALLEL



HOW TO:

- 1 Connect an RS-232-C printer to the RS-232-C port.

NOTE

Choosing RS232 external printer for logging prevents the use of RS-232-C remote control.

- 2 If a non HP printer is connected then set PRINTER TYPE to be **ALT. PRINTER**. Set MODE to be **NORMAL** (80 character column width) or **COMPRESS** (40 character column width) according to the capabilities of your printer.
- 3 Set SPEED to match the Baud Rate chosen on your printer.
- 4 Set PROTOCOL to match that required by your printer.
- 5 See "Logging Results " page 225 or "Logging on Demand " page 233 for more details on selecting the type of Results you wish to log.

Printing Results from Disk

Description

If you have inserted a disk into the internal disk drive and saved data to disk, you can print the contents of the disk using a PC and Printer as follows:

Remove the Disk from the OmniBER 718 and insert it into a personal computer (PC).

PC Instructions

HOW TO:

Print from DOS Prompt

copy/b a:\<filename> <printer name>

HOW TO:

Print from Windows

- 1** Choose the required file from Filemanager.
- 2** Choose FILE - COPY FILE TO
<printer name>

Connecting a Printer to a Parallel Port

Description

If Remote Control Option, 601, is fitted, the OmniBER 718 has the capability of interfacing with a Printer, via the PARALLEL port.

CAUTION

Do not connect a serial printer e.g. RS-232-C or GPIB to the HP 37718A Parallel port as this will damage the interface.

HOW TO:

- 1 Connect the OmniBER 718 Parallel port to your Printer Parallel port using printer cable HP 24542D.

Changing Internal Printer Paper

*Description Option
602 is required*

The printer accepts rolls of thermal paper with the following dimensions: :

Width: 216 mm (8.5 in) or 210 mm (8.27 in) (A4)
tolerance +2.0 mm - 1.0 mm

Maximum Outside Diameter: 40 mm

Inside Core Diameter: Between 12.5 mm and 13.2 mm

Suitable rolls of paper are available from Hewlett Packard, Part Number 9270-1360.

WARNING

The paper tear-off edge is **SHARP**. This edge is exposed when the printer cover is raised. Note the  **CAUTION SHARP EDGE** label on the cover.

HOW TO:

- 1 Raise the two locking tabs on the sides of the printer cover and then raise the cover.
- 2 Raise the printer mechanism front cover. This releases the paper drive. Remove any remaining paper from the front (in the normal direction of operation).

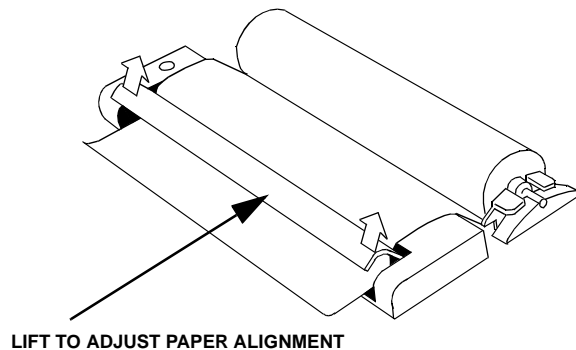

- 3 Lift out the spindle. Adjust the paper width adaptor to the width of the paper being used.

Storing, Logging and Printing

Changing Internal Printer Paper

- Put the paper roll on the spindle such that the sensitive side (slightly shiny) will be on the underside of the print mechanism. Ensure that the relocation of the spindle locks the blue width adaptor in position.

NOTE

The paper must be installed such that when it is in the print mechanism, the sensitive side (slightly shiny) is the underside.

The illustrations here show the correct fitting for HP 9270-1360 paper which has the sensitive side on the outside of the roll.

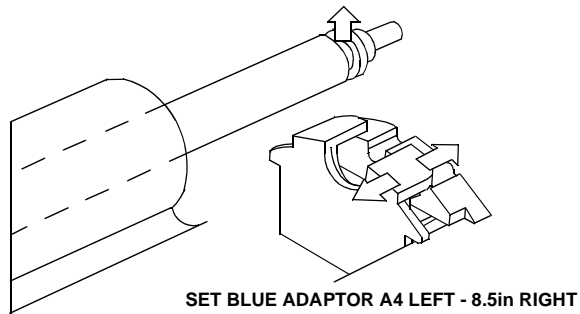

- Feed the paper into the upper entry of the print mechanism. When the front cover of the print mechanism is closed, the printer should automatically feed the paper through until there is approximately 2.5 cm (1 in) clear at the front of the print mechanism.

Align paper with the leftmost edge of the printer mechanism slot

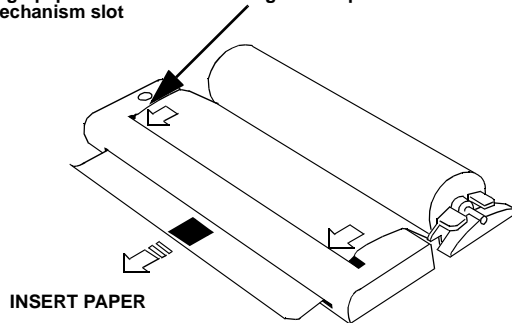

CAUTION

Do not close the outer cover until the automatic paper feed is complete.

Storing, Logging and Printing

Changing Internal Printer Paper

- 6 If the printer paper is incorrectly aligned, raise the printer mechanism front cover to releases the paper drive and realign the paper.

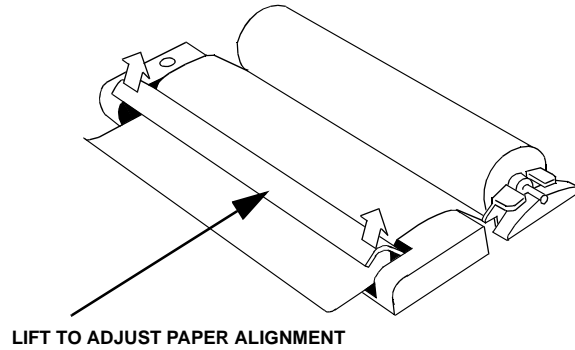

Cleaning Internal Printer Print Head

Description

The print head should be cleaned when broken or light characters occur in a vertical line on the page. To maintain a high quality print, clean the print head after 200 to 300 prints.

The print head is cleaned with a special cleaning paper which is supplied with the instrument.

WARNING

The paper tear-off edge is SHARP. This edge is exposed when the printer cover is raised. Note the  CAUTION SHARP EDGE label on the cover.

HOW TO:

- 1** Open the printer as for changing the paper see "Changing Internal Printer Paper" page 255.
If printer paper is fitted, remove it from the printer.
- 2** Feed the cleaning paper into the top entry of the print mechanism with the rough black side, which contains the cleaning material, towards the rear of the printer.
- 3** When the automatic feed is complete and the paper stops moving use the instrument front panel key **PAPER FEED** to move the cleaning paper through the print mechanism.
- 4** Remove the cleaning paper and replace the normal printer paper. See "Changing Internal Printer Paper " page 255.

NOTE

Retain the cleaning paper. It is designed to last for the life of the printer.

- “Storing Configurations in Instrument Store” page 260
- “Titling Configuration in Instrument Store” page 261
- “Recalling Configurations from Instrument Store” page 262
- “Formatting a Disk” page 263
- “Labeling a Disk” page 264
- “Managing Files and Directories on Disk” page 265
- “Saving a Screen Dump to Disk” page 272
- “Saving Graphical Results to Disk” page 274
- “Saving Data Logging to Disk” page 276
- “Saving Configurations to Disk” page 277
- “Recalling Configuration from Disk” page 278
- “Recalling Graphics Results from Disk” page 279
- “Copying Configuration from Instrument Store to Disk” page 280
- “Copying Configuration from Disk to Instrument Store” page 282
- “Copying Graphics Results from Instrument Store to Disk” page 284

Using Instrument and Disk Storage

Storing Configurations in Instrument Store

Description

You can store measurement settings which are used regularly and recall them with a single operation.

One preset store is provided which cannot be overwritten, STORED SETTING NUMBER [0]. This store is used to set the instrument to a known state, the FACTORY DEFAULT SETTINGS.

FUNCTION		STORED SETTINGS	
STORED SETTING NUMBER	1		
LOCK	OFF		
ACTION	OFF		
SETTING			
0	FACTORY DEFAULT SETTINGS		
1		
2		
3		
4		

STATUS: OFF RECALL SAVE MULTIPLE WINDOW

HOW TO:

- 1 Set the OmniBER 718 to the configuration you wish to store.
- 2 Choose the STORED SETTING NUMBER to receive the configuration.
- 3 Choose LOCK **OFF**.
- 4 Choose ACTION **SAVE** to store the configuration in the chosen store.
- 5 To add a descriptive title see "Titrating Configuration in Instrument Store" page 261.

Titling Configuration in Instrument Store

Description

When storing configurations, you can give them an easily remembered title for identification at a later date.

FUNCTION		STORED SETTINGS	
STORED SETTING	NUMBER	2	
	LOCK	OFF	
	ACTION	OFF	
SETTING			
0	FACTORY DEFAULT SETTINGS		
1	SONET ROUTING.....		
2	DS3 CARRIER.█.....		
3		
4		

STATUS:
JUMP **PREVIOUS CHAR** **NEXT CHAR** **←** **→** **MULTIPLE WINDOW**

HOW TO:

- 1 Choose the STORED SETTING NUMBER which contains the stored configuration.
- 2 Choose LOCK **OFF**.
- 3 Use **JUMP**; **NEXT CHAR**; **PREVIOUS CHAR**; **→** and **←** to title the settings.

Recalling Configurations from Instrument Store

Description

Having stored a configuration for future use, you must be able to recall that configuration in the future.

FUNCTION		STORED SETTINGS	
STORED SETTING NUMBER		2	
LOCK		OFF	
ACTION		OFF	
SETTING			
0	FACTORY DEFAULT SETTINGS		
1	SONET ROUTING.....		
2	DS3 CARRIER.....		
3		
4		

STATUS:
OFF RECALL SAVE **MULTIPLE WINDOW**

HOW TO:

- 1 Choose the STORED SETTING NUMBER which contains the stored configuration.
- 2 Choose ACTION **RECALL** to recall the stored configuration.
The recall operation can be verified by checking the relevant display settings.

Formatting a Disk

Description

Only 1.44M, MS-DOS compatible disks can be used in the OmniBER 718. Any other format or capacity will result in a disk access error being displayed.

FUNCTION	FLOPPY DISK
DISK OPERATION	DISK FORMAT
Insert Disk Select OK to perform operation <input type="checkbox"/> OFF	
A:\ LABEL: no label	FREE: unknown Bytes

STATUS:
 OFF OK

MULTIPLE WINDOW

NOTE

Disks can be formatted in an IBM compatible PC but it is recommended that the disk is formatted in the OmniBER 718 as this will ensure full compatibility with the Floppy Disk power fail recovery included in the OmniBER 718.

HOW TO:

- 1 Choose DISK OPERATION **DISK FORMAT**.
- 2 Insert the Disk into the Disk drive.
- 3 Choose **OK** to Format the disk.

A warning that this operation will erase all data is displayed and asks “do you wish to continue”.

If YES is selected, all the data on the Disk will be erased and the disk will be formatted.

If NO is selected, the operation is aborted. This allows you to view the data on the Disk and verify that it is no longer needed.

Labeling a Disk

Description

You can label your disks for ease of identification.

FUNCTION	FLOPPY DISK
DISK OPERATION LABEL	DISK LABEL MY DISK
Select OK to perform operation <input type="checkbox"/> OFF	
A:\ LABEL: MY DISK	FREE: Bytes

STATUS:

OFF

OK

MULTIPLE WINDOW

HOW TO:

- 1 Choose DISK OPERATION **DISK LABEL**.
- 2 Label the Disk using **PREVIOUS CHAR** **NEXT CHAR** **→** **←** or press **SET** and use the pop-up keypad.
- 3 Choose **OK** to confirm the label is correct.
The label is displayed at the bottom of the display to confirm the operation has taken place.

Managing Files and Directories on Disk

Description

File and Directory structures can be important in speeding up the transfer of data between the instrument and the disk drive.

It is recommended that you create a directory structure as an aid to efficient file management particularly when the disk is moved to a PC.

Creating a Directory on Disk

FUNCTION	FLOPPY DISK
DISK OPERATION	FILE CREATE DIRECTORY
NAME	SONET
Select OK to perform operation	OFF
A:\ LABEL:	FREE: Bytes

STATUS:

OFF

OK

MULTIPLE
WINDOW

HOW TO:

- 1 Choose DISK OPERATION **FILE CREATE DIRECTORY** on the **OTHER FLOPPY DISK** display.
- 2 Enter the directory name using **PREVIOUS CHAR** **NEXT CHAR** **→** **←** or press **SET** and use the pop-up keypad.
The directory name can contain up to 8 alphanumeric characters.
- 3 To create the directory choose **OK**.
This will create a sub directory of the directory displayed at the bottom of the display. In this example A:\SONET will be created.

Using Instrument and Disk Storage

Managing Files and Directories on Disk

Accessing Directories and Files

- 1 Choose DISK OPERATION **SAVE**.
- 2 Choose FILE TYPE you wish to view.
This acts as a filter on the filename extension:
CONFIGURATION - .CNF filter, **GRAPHICS** - .SMG filter,
DATA LOGGING - .PRN filter, **SCREEN DUMP** - .BMP filter.
- 3 Move the highlighted cursor to the NAME field and press **SET**.

NOTE

- . <DIR> - Current Directory.
 - .. <DIR> - Parent directory. Move highlighted cursor to this line and press **SET** to move to parent directory.
- 4 Move the highlighted cursor to
.. <DIR> and press **SET** to move to parent directory.
 - 5 Move the highlighted cursor to the directory required and press **SET** to move to that directory. (The directory name will appear on the display).
Only the files with the file extension chosen in FILE TYPE will be displayed.

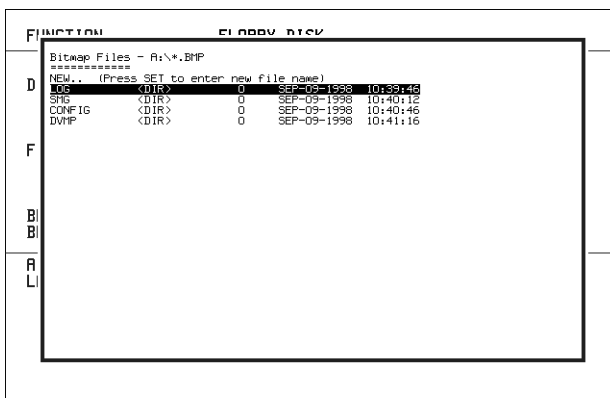

STATUS:

**MULTIPLE
WINDOW**

- 6 Move the highlighted cursor up and down the display using **↑** and **↓**.

Using Instrument and Disk Storage

Managing Files and Directories on Disk

NOTE

Title Bar - File types displayed and current directory. (cannot be highlighted).

. <**DIR**> - Current Directory.

.. <**DIR**> - Parent directory. Move highlighted cursor to this line and press **SET** to move to parent directory.

SONET1.PRN - File (with named extension) in current directory. Move highlighted cursor to this line and press **SET** to select the file. The display will return to the **SAVE** display and the selected file name will appear in the FILE NAME field.

NEXT - Move highlighted cursor to this line and press **SET** to access the next page of file names.

PREV - Move highlighted cursor to this line and press **SET** to access the previous page of file names.

FUNCTION	FILE	DIR	DISK
Data Logging Files - A:\LOG*.PRN			

NEW.. (Press SET to enter new file name)			
D	.	<DIR>	0 SEP-09-1998 10:39:46
	.	<DIR>	0 SEP-09-1998 10:39:46
	SDH1.PRN	8452	SEP-09-1998 11:05:16
	DS3.PRN	8616	SEP-09-1998 10:45:22
	SDH4.PRN	11158	SEP-09-1998 11:11:20
	SHG1.PRN	16888	SEP-09-1998 13:12:10
F	34HB.PRN	10584	SEP-09-1998 12:34:54
	LINK1.PRN	5156	SEP-09-1998 12:52:14
	LINK3.PRN	7878	SEP-09-1998 12:55:36
	SDH2.PRN	8862	SEP-09-1998 12:59:18
	SDH3.PRN	11076	SEP-09-1998 13:01:50
L	DS1.PRN	5254	SEP-09-1998 13:04:18
L	PDH1.PRN	5254	SEP-09-1998 13:09:12
L	PDH2.PRN	7632	SEP-09-1998 13:10:28
L	LINK2.PRN	2135	SEP-09-1998 13:18:34
	LINK4.PRN	8090	SEP-09-1998 13:19:54
	LINK4.PRN	2135	SEP-09-1998 13:20:36
A	LOCAL.PRN	8101	SEP-09-1998 13:21:48
L	LONG1.PRN	2135	SEP-09-1998 13:22:22
	SDH7.PRN	8101	SEP-09-1998 13:24:26
	SDH8.PRN	2135	SEP-09-1998 13:24:48
	SDH9.PRN	6871	SEP-09-1998 13:25:32
	PDH3.PRN	2135	SEP-09-1998 13:26:10
	PDH4.PRN	6871	SEP-09-1998 13:26:32
	NEXT PAGE ->		

STATUS:

MULTIPLE WINDOW

7 **NEW**. - Allows entry of new file name using pop-up keypad. Press **SET** to obtain the pop-up keypad display. Enter the new filename, Choose **END** and press **SET** to return to the file manager display.

8 Press **CANCEL** to return to the **SAVE** display.
The filename entered via the keypad appears on the **SAVE** display.
The file extension is added automatically.
The Directory name and the disk Label appear at the bottom of the display.

Using Instrument and Disk Storage

Managing Files and Directories on Disk

Renaming a File on Disk

Description

Files can be renamed as an aid to efficient file management.

FUNCTION	FLOPPY DISK
DISK OPERATION	FILE RENAME
FROM: NAME	FILENAME.CNF
TO: DIRECTORY NAME	A:\ FILENAME.CNF
Select OK to perform operation	<input type="checkbox"/> OFF
A:\ LABEL:	FREE: Bytes

STATUS:

OFF

OK

MULTIPLE
WINDOW

HOW TO:

- 1 Choose DISK OPERATION **FILE RENAME**.
- 2 Enter the FROM filename using **PREVIOUS CHAR** **NEXT CHAR** **→** **←** or Choose the directory which contains the file to be renamed. See "Accessing Directories and Files " page 266. Move the highlighted cursor to the file to be renamed and press **SET** to return to the **FILE RENAME** display. The filename, with extension, can contain up to 12 alphanumeric characters.
- 3 Choose the directory in which to locate the renamed file (it will appear on the display). See "Accessing Directories and Files " page 266.
- 4 Enter the TO filename using **PREVIOUS CHAR** **NEXT CHAR** **→** **←** or press **SET** twice and use the pop-up keypad. The filename can contain up to 8 alphanumeric characters. The file extension is fixed to the FROM filename extension.
- 5 To rename the file choose **OK**.
If you have entered a filename which already exists, a warning "File exists - are you sure" you wish to continue is displayed.
If YES is selected, the data in the file will be overwritten. If NO is selected, the operation is aborted.
This allows you the opportunity to verify before renaming.

Using Instrument and Disk Storage

Managing Files and Directories on Disk

Deleting a File on Disk

Description

Obsolete files can be deleted as an aid to efficient file management.

FUNCTION	FLOPPY DISK
DISK OPERATION	FILE DELETE DELETE FILE
NAME	FILENAME.EXT
Select OK to perform operation	<input type="checkbox"/> OFF
A:\ LABEL:	FREE: Bytes

STATUS:

OFF

OK

MULTIPLE
WINDOW

HOW TO:

- 1 Choose DISK OPERATION **FILE** **DELETE** **DELETE FILE**.
- 2 Choose the directory containing the file to be deleted. See "Accessing Directories and Files " page 266.
- 3 Enter the filename to be deleted using **PREVIOUS CHAR** **NEXT CHAR** **→** **←** or press **SET**, highlight the file to be deleted on the file manager display, and press **SET**.
The file name can contain up to 12 alphanumeric characters, including the filename extension.
- 4 To delete the file choose **OK**.
A warning "Are you sure you wish to continue" is displayed.
If YES is selected, the file is deleted.
If NO is selected, the operation is aborted.
This prevents accidental deletion of a wanted file.

Using Instrument and Disk Storage

Managing Files and Directories on Disk

Deleting a Directory on Disk

Description

Obsolete Directories should be deleted as an aid to efficient file management.

FUNCTION	FLOPPY DISK	
DISK OPERATION	FILE DELETE	DELETE DIRECTORY
Select OK to perform operation	<input type="checkbox"/> OFF	
A:\ LABEL:	FREE:	Bytes

STATUS:
 OFF OK

MULTIPLE WINDOW

NOTE

A directory cannot be deleted until all the files within the directory have been deleted. See "Deleting a File on Disk " page 269.

HOW TO:

- 1 Choose the directory you wish to delete (it will appear on the display). See "Accessing Directories and Files " page 266.
- 2 Choose DISK OPERATION FILE DELETE DELETE DIRECTORY.
- 3 To delete the directory choose OK.
A warning "Are you sure you wish to continue" is displayed.
If YES is selected, the directory is deleted.
If NO is selected, the operation is aborted.
This prevents accidental deletion of a wanted directory.
If the directory is not empty the messages "delete directory failed" "directory is not empty" are displayed.
- 4 If files need to be deleted to prepare the directory for deletion. See "Deleting a File on Disk " page 269.

Using Instrument and Disk Storage

Managing Files and Directories on Disk

Adding Descriptors to Disk Files

Description

When storing configurations or graphics on disk, you can give them an easily remembered descriptor for identification at a later date.

Descriptors can be added to .CNF and .SMG files.

FUNCTION	FLOPPY DISK
DISK OPERATION	FILE PROPERTIES
DISPLAY OPTION	FILE DESCRIPTOR
FILE NAME DESCRIPTOR	FILENAME.CNF
Press SET to select filename popup	
Select OK to perform operation	OFF
A:\ LABEL:	FREE: Bytes

STATUS:

TIME & DATE

FILE DESC

MULTIPLE WINDOW

HOW TO:

- 1 Choose the directory containing the file you wish to add the descriptor to. See "Accessing Directories and Files " page 266.
- 2 Choose DISK OPERATION **FILE PROPERTIES** and DISPLAY OPTION **FILE DESCRIPTOR**.
- 3 Move the highlighted cursor to the FILE NAME DESCRIPTOR field. Enter the file descriptor using **PREVIOUS CHAR** **NEXT CHAR** **→** **←** or press **SET**, highlight the file required on the file manager display, and press **SET**.
- 4 Move the highlighted cursor to Select OK to perform operation and choose OK. The File List will show the descriptor instead of the TIME and DATE information as long as FILE DESCRIPTOR is selected.

NOTE

This slows down the updating of the display.

Using Instrument and Disk Storage

Saving a Screen Dump to Disk

Saving a Screen Dump to Disk

Description

The chosen display may be stored on disk in bitmap format using the Screen Dump feature of the OmniBER. Logging and Floppy Disk must be set up for screen dump. The current display is stored on disk when **PRINT NOW** is pressed.

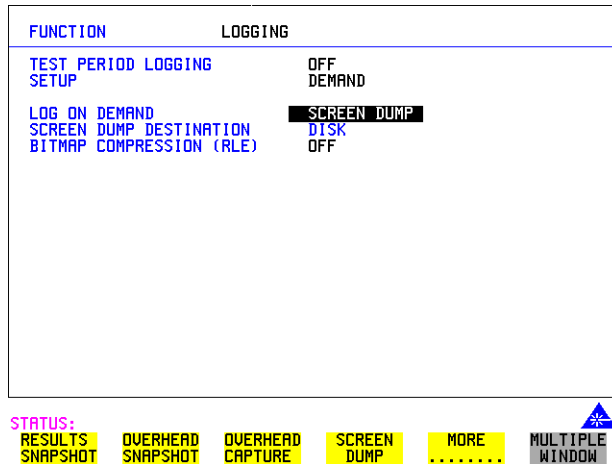

HOW TO:

- 1 Select the **OTHER** **LOGGING** display, and choose SETUP **LOGGING DEVICE** and LOGGING PORT **DISK**.
- 2 Now set SETUP to **LOG ON DEMAND** and LOG ON DEMAND to **SCREEN DUMP**.
- 3 If compression is required to save disk space, select BITMAP COMPRESSION (RLE) **ON**.

Using Instrument and Disk Storage

Saving a Screen Dump to Disk

4

FUNCTION	FLOPPY DISK
DISK OPERATION	SAVE
FILE TYPE NAME	SCREEN DUMP FILENAME.BMP
BMP DIR : A:\ BMP FILE: SDUMP029.BMP	
A:\ LABEL:no label	FREE: unknown Bytes

STATUS:
STORED SETTINGS **SETTINGS CONTROL** **FLOPPY DISK** **LOGGING** **MORE** **MULTIPLE WINDOW**

- 5 Choose the directory in which to save the Screen Dump. See "Accessing Directories and Files " page 266.
- 6 If you wish to enter your own choice of filename, choose DISK OPERATION **SAVE** FILE TYPE **SCREEN DUMP**.

NOTE

You have the option of an auto generated filename or entering your chosen filename. The file name can have a maximum of 8 characters. The file extension is fixed as .BMP. The file name must satisfy DOS requirements, that is, there must be no spaces or other illegal characters.

- 7 Move the highlighted cursor to NAME and enter the filename using **PREVIOUS CHAR** **NEXT CHAR** **→** **←** or press **SET** twice and use the pop-up keypad.
- 8 Choose the display you want to store on disk and press **PRINT NOW**. After a few second the message "SAVING SCREEN DUMP . . . (XX% COMPLETE)" is displayed.

Saving Graphical Results to Disk

Description

Graphical results can be saved to a file on disk. Two methods of naming the file, which is created when the measurement is started, are available:

- Automatic** A filename in the form meas001 is created automatically without any action from you.
- Your Choice** You can input a filename of your choice which will override the automatically generated filename. This must be entered before the measurement is started. If the filename you enter already exists, graphics results will be saved to the automatically generated filename. This prevents existing files from being overwritten each time the measurement is started.

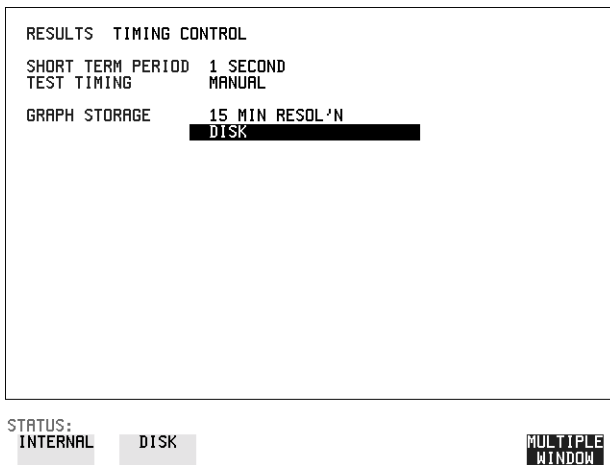

HOW TO:

- 1 Choose GRAPH STORAGE **DISK** and the Graph Storage resolution required on the **RESULTS** display. See “Saving Graphics Results to Instrument Store” page 222.
If you wish to use the automatically generated filename no further action is required and the graphics results will be saved on Disk when the measurement is completed.

Using Instrument and Disk Storage

Saving Graphical Results to Disk

FUNCTION	FLOPPY DISK	
DISK OPERATION	SAVE	
FILE TYPE NAME	GRAPHICS FILENAME.SMG	
A:\ LABEL:	FREE:	Bytes

STATUS:

CONFIG-
URATION

GRAPHICS

DATA
LOGGING

MULTIPLE
WINDOW

- 2 Choose the directory in which to save the graphics results. See "Accessing Directories and Files " page 266.
- 3 If you wish to enter your own choice of filename, choose DISK OPERATION **SAVE** FILE TYPE **GRAPHICS**.
- 4 Move the highlighted cursor to NAME and enter the filename using **PREVIOUS CHAR** **NEXT CHAR** **→** **←** or press **SET** twice and use the pop-up keypad.
The filename can contain up to 8 alphanumeric characters.
The filename extension is fixed as .SMG.
The graphics results will be saved on Disk at the end of the measurement.

Saving Data Logging to Disk

Description

Data Logging can be saved to a file on disk. The disk can be transferred to a personal computer (PC) and the logging investigated at a later date.

FUNCTION	FLOPPY DISK
DISK OPERATION	SAVE
FILE TYPE NAME	DATA LOGGING FILENAME.PRN APPEND TO FILE
A:\ LABEL:	FREE: Bytes

STATUS:

OVER-
WRITE

APPEND
TO FILE

MULTIPLE
WINDOW

HOW TO:

- 1 Choose the directory in which to save the logging results. See "Accessing Directories and Files " page 266.
- 2 Choose DISK OPERATION **SAVE** FILE TYPE **DATA LOGGING** and enter your choice of filename using **PREVIOUS CHAR** **NEXT CHAR** **→** **←** or press **SET** twice and use the pop-up keypad.
The filename can contain up to 8 alphanumeric characters.
The filename extension is fixed as .PRN.
- 3 If you wish to add the data logging to a file which already exists, choose **APPEND TO FILE**. The data logging is added to the named file on Disk in the available free space.
If you wish to overwrite the contents of the named file with the data logging, choose **OVERWRITE**.
- 4 Set up the **OTHER LOGGING** display. See "Logging Results" page 231.
When the named file is opened, data logging is saved on the disk:
As each logging output occurs during the measurement or when **PRINT NOW** is pressed.

Using Instrument and Disk Storage

Saving Configurations to Disk

Saving Configurations to Disk

Description

You can store a large number of measurement settings which are used regularly and recall them when required.

Configurations can be stored to a file on the floppy disk. The floppy disk can be used in other instruments which have the same option structure.

FUNCTION	FLOPPY DISK
DISK OPERATION	SAVE
FILE TYPE NAME	CONFIGURATION SDHARNAI .CNF
Select OK to perform operation	OFF
A:\ LABEL:no label	FREE: 1148928 Bytes

STATUS: CONFIG-URATION GRAPHICS DATA LOGGING SCREEN DUMP MULTIPLE WINDOW

HOW TO:

- 1 Set the OmniBER 718 to the configuration you wish to store.
- 2 Choose the directory in which you wish to save the OmniBER 718 configuration. See "Accessing Directories and Files " page 266.
- 3 Choose DISK OPERATION **SAVE**, FILE TYPE **CONFIGURATION** and enter the filename using **PREVIOUS CHAR** **NEXT CHAR** **→** **←** or press **SET** twice and use the pop-up keypad.
The filename extension is fixed as .CNF.
The filename can contain up to 8 alphanumeric characters.
- 4 Choose **OK** to save the current configuration to disk.
If you have entered a filename which already exists, a warning "File exists - are you sure you wish to continue" is displayed.
If YES is selected, the configuration will be saved.
To cancel, change OK to OFF and enter new filename. See "Accessing Directories and Files " page 266.

Recalling Configuration from Disk

Description

If a configuration has been stored on disk, you will need to recall it at some time in the future to configure the instrument.

FUNCTION	FLOPPY DISK	
DISK OPERATION	RECALL	
FILE TYPE NAME	CONFIGURATION FILENAME.CNF	
Select OK to perform operation	OFF	
A:\ LABEL:	FREE:	Bytes

STATUS:
CONFIG-
URATION

GRAPHICS

MULTIPLE
WINDOW

HOW TO:

- 1 Choose the directory that contains the configuration file to be recalled. See "Accessing Directories and Files " page 266.
- 2 Choose DISK OPERATION **RECALL** FILE TYPE **CONFIGURATION** and enter your choice of filename using **PREVIOUS CHAR** **NEXT CHAR** **→** **←**.
The filename can contain up to 8 alphanumeric characters.
The filename extension is fixed as .CNF.
- 3 To recall the configuration from disk to instrument, choose **OK**.
The recall operation can be verified by checking the relevant display settings.

Using Instrument and Disk Storage

Recalling Graphics Results from Disk

Recalling Graphics Results from Disk

Description

If graphic results have been stored on disk, you will need to recall them in able to view the results on the **(GRAPH)** display.

FUNCTION	FLOPPY DISK	
DISK OPERATION	RECALL	
FILE TYPE NAME	GRAPHICS FILENAME.SMG	
Select OK to perform operation	<input type="checkbox"/> OFF	
A:\ LABEL:	FREE:	Bytes

STATUS:
 OFF OK

MULTIPLE WINDOW

HOW TO:

- 1 Choose the directory that contains the graphics file to be recalled. See "Accessing Directories and Files " page 266.
- 2 Choose DISK OPERATION **RECALL** FILE TYPE **GRAPHICS** and enter your choice of filename using **PREVIOUS CHAR** **NEXT CHAR** **→** **←**. The filename can contain up to 8 alphanumeric characters. The filename extension is fixed as .SMG.
- 3 To recall the graphics results from disk to instrument, choose **OK**.
- 4 To view the graphics results, see "Recalling Stored Graph Results" page 223.

Copying Configuration from Instrument Store to Disk

Description

If you have a configuration stored in the instrument store that you wish to use on another instrument, you can copy it to disk. The configuration can then be downloaded from the disk in to another OmniBER 718 with the same options as the original instrument.

FUNCTION	FLOPPY DISK
DISK OPERATION	FILE COPY CONFIGURATION
FROM: 1 ATM27.....	
TO: NAME	FILENAME.CNF
Select OK to perform operation	<input type="checkbox"/> OFF
A:\ LABEL:	FREE: Bytes

STATUS:

OFF

OK

MULTIPLE WINDOW

HOW TO:

- 1 Choose the directory to receive the configuration file. See "Accessing Directories and Files " page 266.
- 2 Choose DISK OPERATION **FILE COPY CONFIGURATION** and enter the Instrument Store number using **DECREASE DIGIT** and **INCREASE DIGIT** or press **SET** and use the pop-up keypad.
The Stored Settings description appears alongside the store number.
If required the description can be modified using **JUMP NEXT CHAR** **PREVIOUS CHAR** **←** **→** or press **SET** and use the pop-up keypad.
The description can contain up to 24 alphanumeric characters.
- 3 Enter the chosen filename using **PREVIOUS CHAR** **NEXT CHAR** **→** **←** or press **SET** twice and use the pop-up keypad.
The file name can contain up to 8 alphanumeric characters.
The filename extension is fixed as .CNF.

Using Instrument and Disk Storage

Copying Configuration from Instrument Store to Disk

- 4 To copy the configuration from instrument to Disk choose **OK**.
If you have entered a filename which already exists, a warning "File exists - are you sure you wish to continue" is displayed.
If YES is selected, the data on the Disk will be overwritten.
If NO is selected, the operation is aborted.

Copying Configuration from Disk to Instrument Store

Description

If you have a configuration stored in the instrument store that you wish to use on another instrument, you can copy it to Disk. The configuration can then be downloaded from the disk in another OmniBER 718 with the same options as the original instrument.

FUNCTION	FLOPPY DISK
DISK OPERATION	FILE COPY CONFIGURATION
TO:	4 ATMTST.....
FROM:	NAME FILENAME.CNF
Select OK to perform operation <input type="checkbox"/> OFF	
A:\ LABEL:	FREE: Bytes

STATUS:
 OFF OK MULTIPLE WINDOW

HOW TO:

- 1 Choose the directory containing the configuration file. See "Accessing Directories and Files " page 266.
- 2 Choose DISK OPERATION **FILE COPY CONFIGURATION** and enter the Instrument Store number using **DECREASE DIGIT** and **INCREASE DIGIT** or press **SET** and use the pop-up keypad.
Enter a description of the configuration using **PREVIOUS CHAR** **NEXT CHAR** **→** **←** or press **SET** and use the pop-up keypad.
The description can contain up to 24 alphanumeric characters.
- 3 Enter the filename the configuration is to be copied from using **PREVIOUS CHAR** **NEXT CHAR** **→** **←** or press **SET**, highlight the file to be copied on the file manager display and press **SET**.
The file name can contain up to 8 alphanumeric characters.
The filename extension is fixed as .CNF.

Using Instrument and Disk Storage

Copying Configuration from Disk to Instrument Store

- 4 To copy the configuration from Disk to instrument, choose **OK**.
If you have entered a instrument store number which already contains a configuration, a warning "Are you sure you wish to continue" is displayed.
If YES is selected, the data in the instrument store will be overwritten.
If NO is selected, the operation is aborted.

Copying Graphics Results from Instrument Store to Disk

Description

You can copy Graphics Results from the instrument store to the Disk. This is useful under the following conditions:

- If you have graphics results stored in the instrument that you wish to prevent from being overwritten by a future measurement (only 10 store locations in the instrument)
- If you wish to retrieve the graphics results for viewing via a spreadsheet.

FUNCTION	FLOPPY DISK	
DISK OPERATION	FILE	
FROM: STORE	COPY	
TO: NAME	GRAPHICS	
FORMAT	-9	
	FILENAME.SMG	
	NORMAL	
Select OK to perform operation		<input type="checkbox"/> OFF
A:\ LABEL:	FREE:	Bytes

STATUS:

 OFF OK MULTIPLE WINDOW

HOW TO:

- 1 Choose the directory to receive the graphics file. See "Accessing Directories and Files" page 266.
- 2 Choose DISK OPERATION **FILE COPY GRAPHICS** and enter the Instrument Store number using **DECREASE DIGIT** and **INCREASE DIGIT** or press **SET** and use the pop-up keypad.
- 3 Enter the filename the graphic results are to be copied to using **PREVIOUS CHAR** **NEXT CHAR** **→** **←** or press **SET** twice and use the pop-up keypad.
The file name can contain up to 8 alphanumeric characters.
The filename extension is fixed as .SMG.

Using Instrument and Disk Storage

Copying Graphics Results from Instrument Store to Disk

- 4** If you wish to view the graphic results at a later date via a spreadsheet, choose FORMAT **CSV**. CSV is Comma Separated Variable.
If you wish to view the graphic results at a later date on an OmniBER 718, choose FORMAT **NORMAL**.
- 5** To copy the configuration from instrument to Disk, choose **OK**.
If you have entered a filename which already exists, a warning "File exists - are you sure you wish to continue" is displayed.
If YES is selected, the data on the Disk will be overwritten.
If NO is selected, the operation is aborted.
This allows you the opportunity to view the data on the Disk and verify that it is no longer needed.

Using Instrument and Disk Storage

Copying Graphics Results from Instrument Store to Disk

- “Coupling Transmit and Receive Settings” page 288
- “Setting Time & Date” page 289
- “Enabling Keyboard Lock” page 290
- “Enabling Beep on Received Error” page 291
- “In-Band DS1 Loopcode 156MTS Compatibility” page 292
- “Suspending Test on Signal Loss” page 293
- “REI-L Result/Enable” page 294
- “Graph Storage Resolution” page 296
- “Setting Error Threshold Indication” page 297
- “Setting Screen Brightness and Color” page 298
- “To Generate a New Jitter Mask” page 299
- “To change the parameters of a User-defined jitter mask” page 301
- “Running Self Test” page 303

Selecting and Using "Other" Features

Selecting and Using "Other" Features

Coupling Transmit and Receive Settings

Coupling Transmit and Receive Settings

Description

When generating and measuring at the same interface level, you can have the transmit and receive settings coupled together. Any settings change made on the transmit display will automatically occur on the receive display. Any settings change made on the receive display will automatically occur on the transmit display.

This function is available on the **OTHER SETTINGS CONTROL** display.

FUNCTION	SETTINGS CONTROL
TRANSMITTER AND RECEIVER	COUPLED
RECEIVER COUPLED TO TRANSMITTER	

STATUS:
INDEP-
ENDENT

COUPLED

MULTIPLE
WINDOW

HOW TO:

- 1 Choose TRANSMITTER AND RECEIVER **COUPLED**.

Setting Time & Date

Setting Time & Date

Description

When making Bit error measurements and recording results you can have certain events timed chronologically, for example, Alarms; Error Seconds.

The capability to set the Time and Date is provided on the **OTHER** **TIME & DATE** display.

FUNCTION	TIME & DATE
CLOCK MODE	SETUP
TIME	05:22:59
DATE	29-JUL-89

STATUS:
 DECREASE DIGIT INCREASE DIGIT ← → MULTIPLE WINDOW

HOW TO:

- 1 Choose CLOCK MODE **SETUP** and set the Time and Date using **↑**; **↓**; **←**; **→**; **INCREASE DIGIT** and **DECREASE DIGIT**.
- 2 Choose CLOCK MODE **RUN** to complete the setting of Time and Date.

Selecting and Using "Other" Features

Enabling Keyboard Lock





Enabling Keyboard Lock

Description

You can protect the measurement settings from interference during a test.

This function is provided in the OmniBER 718 on the **OTHER** **MISCELLANEOUS** display.

The following keys are not affected by Keyboard Lock:

- Display keys **TRANSMIT**; **RECEIVE**; **RESULTS**; **GRAPH**; **OTHER**
- cursor keys    and 
- **SHOW** **PAPER FEED** **LOCAL** **SMART TEST**

The following display functions are not affected by Keyboard Lock:

- RESULTS type on the **RESULTS** display
- KEYBOARD LOCK on the **OTHER** display

FUNCTION	MISCELLANEOUS
KEYBOARD LOCK	ON
BEEP ON RECEIVED ERROR	OFF
INBAND DS1 LOOPCODE	
156MTS COMPATIBILITY	OFF
SUSPEND TEST ON SIGNAL LOSS	OFF
REI-L RESULT ENABLE	ON
AIS-L RESULT ENABLE	ON
GRAPH STORAGE RESOLUTION	COMPRESS
NOTE: storing graph results with full resolution will reduce storage capacity by 50%	

STATUS:

OFF

ON



HOW TO:

- 1 Choose KEYBOARD LOCK **ON**.

Selecting and Using "Other" Features

Enabling Beep on Received Error

Enabling Beep on Received Error

Description

You can have an audible indication of an error which is particularly useful when the display on the test set is hidden from view.

This function is provided in the OmniBER 718 on the **OTHER** **MISCELLANEOUS** display.

FUNCTION	MISCELLANEOUS
KEYBOARD LOCK	ON
BEEP ON RECEIVED ERROR	OFF
INBAND DS1 LOOPCODE	
156MTS COMPATIBILITY	OFF
SUSPEND TEST ON SIGNAL LOSS	OFF
REI-L RESULT ENABLE	ON
AIS-L RESULT ENABLE	ON
GRAPH STORAGE RESOLUTION	COMPRESS
NOTE: storing graph results with full resolution will reduce storage capacity by 50%	

STATUS:

OFF

ON



HOW TO:

- 1 Choose BEEP ON RECEIVED ERROR **ON**.

Selecting and Using "Other" Features
In-Band DS1 Loopcode 156MTS Compatibility

In-Band DS1 Loopcode 156MTS Compatibility

Description

The instrument default state is with the INBAND DS1 LOOPCODE 156MTS COMPATIBILITY field set to **OFF**. In this mode the instrument operates as per the T1.403.CORE standard which states that the DS1 framing bit should overwrite the DS1 Loopcode pattern. When **ON** is selected the instrument operation changes such that DS1 Loopcode is gapped in order to prevent the DS1 framing bit overwriting the DS1 Loopcode pattern. This is compatible with HP's 156MTS T-Carrier and SONET tester.

FUNCTION	MISCELLANEOUS
KEYBOARD LOCK	ON
BEEP ON RECEIVED ERROR	OFF
INBAND DS1 LOOPCODE 156MTS COMPATIBILITY	OFF
SUSPEND TEST ON SIGNAL LOSS	OFF
REI-L RESULT ENABLE	ON
RIS-L RESULT ENABLE	ON
GRAPH STORAGE RESOLUTION	COMPRESS
NOTE: storing graph results with full resolution will reduce storage capacity by 50%	

STATUS:

OFF

ON



Selecting and Using "Other" Features

Suspending Test on Signal Loss

Suspending Test on Signal Loss

When running a test, you can choose to suspend the test during periods of signal loss.

This function is available on the **OTHER** **MISCELLANEOUS** display.

FUNCTION	MISCELLANEOUS
KEYBOARD LOCK	ON
BEEP ON RECEIVED ERROR	OFF
INBAND DS1 LOOPCODE	
156MTS COMPATIBILITY	OFF
SUSPEND TEST ON SIGNAL LOSS	OFF
REI-L RESULT ENABLE	ON
AIS-L RESULT ENABLE	ON
GRAPH STORAGE RESOLUTION	COMPRESS
NOTE: storing graph results with full resolution will reduce storage capacity by 50%	

STATUS:

OFF

ON



HOW TO:

- 1 Choose SUSPEND TEST ON SIGNAL LOSS **ON**.

Selecting and Using "Other" Features

REI-L Result/Enable

REI-L Result/Enable

Description

Before running a test, you can choose to enable or disable the SONET measurement of REI-L.

This function is available on the **OTHER** **MISCELLANEOUS** display.

FUNCTION	MISCELLANEOUS
KEYBOARD LOCK	ON
BEEP ON RECEIVED ERROR	OFF
INBAND DS1 LOOPCODE 156MTS COMPATIBILITY	OFF
SUSPEND TEST ON SIGNAL LOSS	OFF
REI-L RESULT ENABLE	ON
AIS-L RESULT ENABLE	ON
GRAPH STORAGE RESOLUTION	COMPRESS
NOTE: storing graph results with full resolution will reduce storage capacity by 50%	

STATUS: OFF ON

MULTIPLE WINDOW

HOW TO:

- 1 Choose REI-L ENABLE **ON** or **OFF** as required.

When set to **OFF**, the REI-L measurement is suppressed. Cumulative, Short Term and Analysis measurements are affected alike.

AIS-L Result/Enable

AIS-L Result/Enable

Description

Before running a test, you can choose to enable or disable the SONET measurement of AIS-L.

This function is available on the **OTHER** **MISCELLANEOUS** display.

FUNCTION	MISCELLANEOUS
KEYBOARD LOCK	ON
BEEP ON RECEIVED ERROR	OFF
INBAND DS1 LOOPCODE 156MTS COMPATIBILITY	OFF
SUSPEND TEST ON SIGNAL LOSS	OFF
REI-L RESULT ENABLE	OFF
AIS-L RESULT ENABLE	OFF
GRAPH STORAGE RESOLUTION	COMPRESS
NOTE: storing graph results with full resolution will reduce storage capacity by 50%	

STATUS: **OFF** **ON**

 MULTIPLE WINDOW

HOW TO:

- 1 Choose AIS-L ENABLE **ON** or **OFF** as required.

When set to **OFF**, the AIS-L measurement is suppressed. Cumulative, Short Term and Analysis measurements are affected alike.

Selecting and Using "Other" Features

Graph Storage Resolution

Graph Storage Resolution

Description

The total graphics store capacity is normally 20,000 events. If GRAPH STORAGE RESOLUTION **FULL** is selected the capacity reduces to 10,000 events.

FUNCTION	MISCELLANEOUS
KEYBOARD LOCK	ON
BEEP ON RECEIVED ERROR	OFF
INBAND DS1 LOOPCODE	
156MTS COMPATIBILITY	OFF
SUSPEND TEST ON SIGNAL LOSS	OFF
REI-L RESULT ENABLE	OFF
AIS-L RESULT ENABLE	OFF
GRAPH STORAGE RESOLUTION	COMPRESS
NOTE: storing graph results with Full resolution will reduce storage capacity by 50%	

STATUS:

COMPRESS

FULL

MULTIPLE
WINDOW

Selecting and Using "Other" Features

Setting Error Threshold Indication

Setting Error Threshold Indication

Description

When making error measurements, you can have an indication of when an error count or error ratio threshold has been exceeded. You can set the OmniBER 718 to indicate this by a color change, from yellow to red, of the bar on the **GRAPH** display and the result on the **RESULTS** display. You can choose the thresholds at which the color change occurs.

The Count and Ratio selections are independent.

This function is available on the **OTHER COLOR CONTROL** display.

FUNCTION	COLOR CONTROL
COLOR ENHANCE RESULTS	ON
COUNT THRESHOLD	10000
RATIO THRESHOLD	10 ⁻³
COLOR PALETTE	TWO
DISPLAY BRIGHTNESS	FULL

STATUS:
10⁻³ 10⁻⁶ 10⁻⁷ 10⁻⁸ 10⁻⁹ MULTIPLE WINDOW

HOW TO:

- 1 Choose COLOR ENHANCE RESULTS **ON**.
- 2 Choose the COUNT THRESHOLD and RATIO THRESHOLD.

Selecting and Using "Other" Features

Setting Screen Brightness and Color

Setting Screen Brightness and Color

Description

The OmniBER 718 screen can be set to single or two color using the COLOR PALETTE selection on the **OTHER**, **COLOR CONTROL** display.

The screen brightness can be set to full or half brightness.

The half brightness setting is used when the room brightness is such that half brightness is desirable and will also prolong the life of the screen.

If the brightness is set to FULL and there have been no key presses in the last hour, then the screen automatically dims to the half brightness level and the status message "Display set to half brightness" is shown. Any key press will return the screen to full brightness.

This function is available on the **OTHER**, **COLOR CONTROL** display.

FUNCTION	COLOR CONTROL
COLOR ENHANCE RESULTS	ON
COUNT THRESHOLD	10000
RATIO THRESHOLD	10 ⁻³
COLOR PALETTE	TWO
DISPLAY BRIGHTNESS	FULL

STATUS:

HALF

FULL

**MULTIPLE
WINDOW**

HOW TO:

- 1 Choose the DISPLAY BRIGHTNESS to suit the operating environment.

Selecting and Using "Other" Features To Generate a New Jitter Mask

To Generate a New Jitter Mask



This feature enables the user to quickly generate a new mask, without having to set each point in the mask. The procedure is as follows:

- 1 Select **OTHER**, **JITTER MASKS**, you will have to select **MORE** to access the JITTER MASKS key.
- 2 Check the mask LOCK is set to **OFF**, then select a USER MASK NUMBER (from 1 to 5). Note that it is not possible to edit a User Mask when there is a User Mask currently in use (i.e. when running a measurement). When this occurs the LOCK field displays "ON (IN USE)".

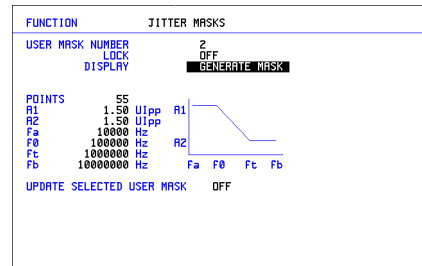
- 3 Position the cursor on DISPLAY and select **GENERATE MASK**.
- 4 Position the cursor on POINTS and set the required number of points in the mask.



STATUS: MASK TITLE MASK POINTS GENERATE MASK MULTIPLE WINDOW

- 5 Using the ,  and edit keys setup the amplitude and frequency of the user-selectable points given on the display (i.e. A1, A2 fa, f0, ft, fb).
- 6 Position the cursor on the UPDATE SELECTED USER MASK field and select **GENERATE**.

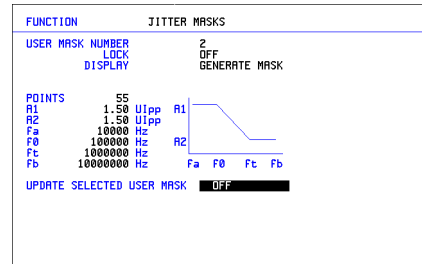

STATUS: GENERATE MULTIPLE WINDOW

NOTE

A status message "Illegal mask parameters" will occur if the specified frequency and amplitude points are invalid. Check that the frequency points are in ascending order and that the A1 and A2 amplitudes are valid for the specified frequencies.

Selecting and Using "Other" Features

To Generate a New Jitter Mask

- 7 Select DISPLAY **MASK POINTS**.

Note that the GENERATE action has resulted in a new mask being calculated and placed into the frequency and amplitude fields. Further editing can now take place as required, using the edit keys.

For example, selecting NUMBER OF POINTS will allow you to change the number of points in the mask, while selecting PAGE enables you to select pages 1 to 5 and edit the frequency and amplitude of each point on the mask.

FUNCTION		JITTER MASKS			
USER MASK NUMBER		1			
LOCK		OFF			
DISPLAY		MASK POINTS			
NUMBER OF POINTS		50			
PAGE		1			
	FREQ(Hz)	AMP(UI)		FREQ(Hz)	AMP(UI)
01	9989	1.30	07	23277	1.30
02	11502	1.30	08	25802	1.30
03	13243	1.30	09	30860	1.30
04	15248	1.30	10	35533	1.30
05	17557	1.30	11	40913	1.30
06	20216	1.30	12	47108	1.30

STATUS: MASK TITLE MASK POINTS GENERATE MASK

MULTIPLE WINDOW

- 8 The new edits are automatically saved into the mask selected, there is no need to generate a new mask.

Locking the Mask

To prevent accidental changes to the masks when finished set the LOCK to **ON**.

To change the parameters of a User-defined jitter mask

To change the parameters of a User-defined jitter mask

- 1 Select **OTHER**, and set FUNCTION to **JITTER MASKS**; you will have to select **MORE** to access the JITTER MASKS key.

To Edit a User Mask Title

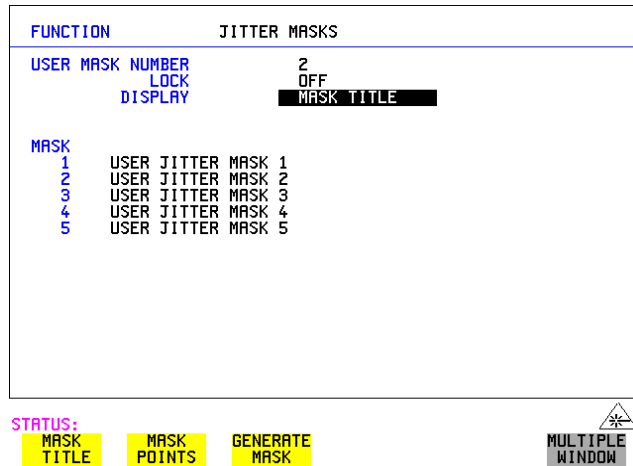

- 2 Check the mask LOCK is set to **OFF**, then select USER MASK NUMBER, and select the appropriate user mask (1 to 5).
- 3 Position the cursor on DISPLAY, then select **MASK TITLE**.
- 4 Position the cursor on the MASK (1 to 5) to be edited, and enter a new title using the edit keys.



Selecting and Using "Other" Features

To change the parameters of a User-defined jitter mask

To Edit Mask Points

- 1 Position the cursor on DISPLAY and select **MASK POINTS**.
- 2 Select NUMBER OF POINTS and using the ,  keys, and edit keys (INCREASE/DECREASE DIGIT) select the number of points in the mask (maximum 55) and the frequency and amplitude at each point. Use the PAGE field to switch between pages to access all 55 points in the mask.

FUNCTION		JITTER MASKS									
USER MASK NUMBER						2					
LOCK						OFF					
DISPLAY						MASK POINTS					
NUMBER OF POINTS						55					
PAGE						1					
	FREQ(Hz)	AMP(UI)		FREQ(Hz)	AMP(UI)						
01	200	1.50	07	592	1.27						
02	240	1.50	08	710	1.06						
03	287	1.50	09	850	0.89						
04	344	1.50	10	1019	0.75						
05	412	1.50	11	1221	0.63						
06	494	1.50	12	1463	0.52						

STATUS: **MASK TITLE** **MASK POINTS** **GENERATE MASK**  MULTIPLE WINDOW

- 3 Note that it is not possible to edit a user mask when a user mask is currently in use (i.e. a measurement is running). When this occurs the LOCK field displays "ON (IN USE)".
- 4 The new edits are automatically saved into the mask selected, there is no need to generate a new mask.

Selecting and Using "Other" Features

Running Self Test

Running Self Test

Description

Before using the OmniBER 718 to make measurements, you can run Self Test ALL TESTS to ascertain the integrity of the OmniBER 718. These tests take between at least 1 hour to complete depending on the options fitted. Alternatively you can run Confidence Tests which only takes 2 to 3 minutes to complete. This is not a full verification but performs BER measurements with internal and external loopbacks fitted.

FUNCTION	SELF TEST
TEST TYPE	ALL TESTS
TEST NUMBER	0
SUBTEST NUMBER	---
TEST STATUS	READY
PRESS THE (RUN/STOP) KEY TO START TESTING.	
CABLING INFO	ALL

STATUS:
ALL TESTS CPU TESTS CONF. TESTS PDH TESTS MORE MULTIPLE WINDOW

HOW TO:

Run ALL TESTS

- 1 Choose TEST TYPE **ALL TESTS** on the **(OTHER) SELF TEST** display.
- 2 Insert a formatted disk into the instrument disk drive.
- 3 Make the loopback connections listed below:
Connect Transmit module 75Ω OUT to Receive module 75Ω IN
Connect Transmit module 100/120Ω OUT to Receive module 100/120Ω IN
Connect Transmit module 75Ω MUX to Receive module 75Ω DEMUX
Connect Transmit module 100/120Ω MUX to Receive module 100/120Ω DEMUX
Connect Multirate Analyzer IN to OUT
Connect Optical OUT to Optical IN via a 15 dB attenuator.

NOTE

If any or all of these connections are not made the OmniBER 718 will FAIL Self Test.

Selecting and Using "Other" Features

Running Self Test

- 4 Press **RUN/STOP** to activate the Self Test. TEST STATUS RUNNING will be displayed.

The information pertaining to TEST TYPE, TEST NUMBER and SUBTEST NUMBER will change as the Self Test progresses.

If the OmniBER 718 is functioning correctly, after a time of at least 1 hour, TEST STATUS PASSED is displayed.

If TEST STATUS [FAIL nnn] is displayed, the OmniBER 718 should be returned to a service office for repair.

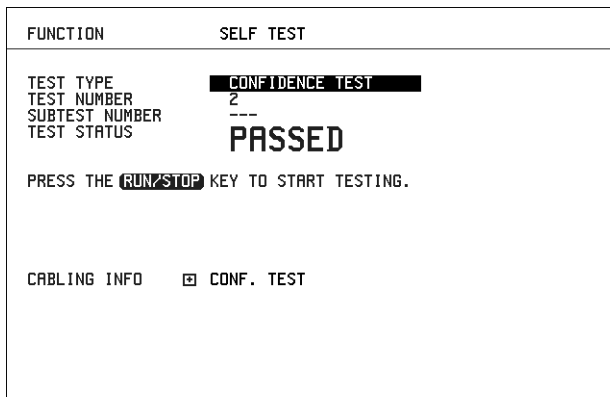

HOW TO:

Run Confidence TESTS

- 1 Choose TEST TYPE **CONF. TESTS** on the **OTHER SELF TEST** display.
- 2 Insert a formatted disk into the instrument disk drive.
- 3 Make the loopback connections listed below:
 - Connect Transmit module 75Ω OUT to Receive module 75Ω IN
 - Connect Transmit module 100/120Ω OUT to Receive module 100/120Ω IN
 - Connect Transmit module 75Ω MUX to Receive module 75Ω DEMUX
 - Connect Transmit module 100/120Ω MUX to Receive module 100/120Ω DEMUX
 - Connect Multirate Analyzer IN to OUT
 - Connect Optical OUT to Optical IN via a 15 dB attenuator.
- 4 Press **RUN/STOP** to activate the Self Test. TEST STATUS RUNNING will be displayed.

The information pertaining to TEST TYPE, TEST NUMBER and SUBTEST NUMBER will change as the Self Test progresses.

Selecting and Using "Other" Features

Running Self Test

If the OmniBER 718 is functioning correctly, after a time of 2 to 3minutes, TEST STATUS PASSED is displayed.

If TEST STATUS [FAIL nnn] is displayed, the OmniBER 718 should be returned to a service office for repair.

NOTE

Each individual self test requires unique loopback connections. To obtain a list of the connections required move the highlighted cursor to CABLING INFO and press **SET**. The Loopbacks list will appear on the display.

FUNCTION	SELF TEST
TEST TYPE	PDH TESTS
TEST NUMBER	3
SUBTEST NUMBER	---
TEST STATUS	READY

PDH SELFTEST - CABLING INFORMATION

PAYLOAD MODULE CONNECTIONS :
CONNECT PDH OUT TO PDH IN (UNBALANCED DS3, 21k/s, 341k/s)
CONNECT PDH OUT TO PDH IN (BALANCED 21k/s)
CONNECT MUX TO DEMUX (BALANCED DS1)
CONNECT MUX TO DEMUX (UNBALANCED 21k/s)

STATUS:

**MULTIPLE
WINDOW**

Trigger Output

Trigger Output

Description

Use the pulse output from the TRIG OUT port on the OmniBER Multirate Analyzer module to trigger external equipment. A pulse is output whenever the condition selected in the TRIGGER SOURCE field occurs.

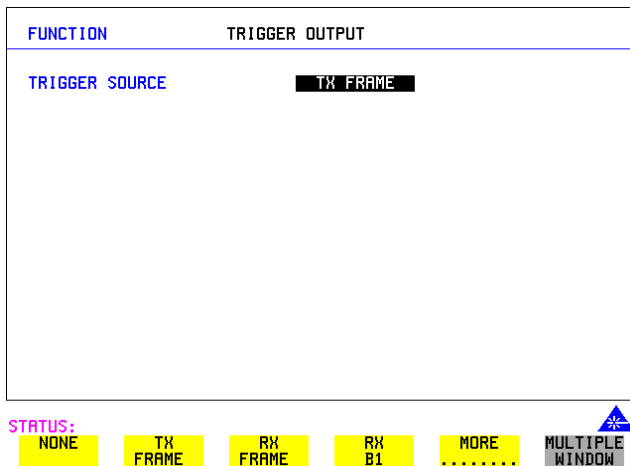

How To

- 1 Select **OTHER**, and set FUNCTION to **TRIGGER OUTPUT**.
- 2 Set the TRIGGER SOURCE field as required from the following:

NONE
 TX FRAME
 RX FRAME
 RX B1
 RX B2 and
 RX B3

Pulse Format

TTL Levels. Termination can be 75 ohm or 10 k ilohms.

RZ with active high pulse of 60usec (Nominal). Note that a single pulse is generated if a frame contains one or more errors giving a maximum frequency of 8kHz.

Connector

BNC.

Appendix A

STS-1 SPE Background Patterns

The following tables list the background patterns available when selecting specific foregrounds.

STS-1 SPE Background Patterns

Table 6 STS-1 SPE Background Patterns

Foreground	Background choice in Foreground TUG-3	Background choice in other AU-3
STS-1 SPE	-----	VT-1.5, VT-2 Mapping or SPE Word (8 bit user programmable word).
VT-6	Pattern in other VT-6s is numbered. They contain the word 11NNNNNx, where NNNNN is the binary number of the TU.	VT-1.5, VT-2 Mapping or SPE Word (8 bit user programmable word).
VT-2 (2 Mb/s) Unframed	VT-2 structure, unframed with 2E15-1, 2E9-1 PRBS or 1100 word pattern in all information bits.	VT-2, VT-1.5 Mapping or SPE Word (8 bit user programmable word).
VT-2 (2 Mb/s) Framed	VT-2 structure, framed with 2E15-1, 2E9-1 PRBS, NUMBERED or 1100 word pattern. In Numbered mode, each timeslot contains the pattern 0NNNNNNX where NNNNNN is the binary number of the TU. The least significant digit (X) is alternated between 0 and 1 in successive frames.	VT-2, VT-1.5 Mapping or SPE Word (8 bit user programmable word).
VT-1.5 (DS1) Unframed	VT-1.5 structure, D4 framed with 2E15-1, 2E9-1 PRBS or 1100 Word pattern in other TU-11s.	VT-2, VT-1.5 Mapping or SPE Word (8 bit user programmable word).

Table 6 **STS-1 SPE Background Patterns, continued**

Foreground	Background choice in Foreground TUG-3	Background choice in other AU-3
VT-1.5 (DS1) Framed	VT-1.5 structure, DS1, D4 framed with 2E15-1, 2E9-1 PRBS, NUMBERED or 1100 word pattern in other TU-11s. In Numbered mode, each timeslot contains the pattern 1NNNNNN1 where NNNNNN is the binary number of the TU. Framing type will be the same as the foreground except when SLC96 is selected. In this case, D4 framing is inserted in the background	VT-2, VT-1.5 Mapping or SPE Word (8 bit user programmable word).

STS-1 SPE Background Patterns

Appendix B

ETSI/ANSI Terminology

A table of ETSI terms with their ANSI equivalents.

ETSI/ANSI Conversion and Equivalent Terms

Introduction

The terminology used on the instrument display can be ETSI (SDH) or ANSI (SONET) terminology. Refer to the table given in this appendix for an explanation of equivalent SDH/SONET terms.

ETSI: European Telecommunications Standards Institute.

ANSI: American National Standards Institute.

Table 7 **ETSI / ANSI Terminology**

ETSI Term	ANSI Term
AU-3	STS-1 SPE + H1, H2, H3
AU-4	STS-3c SPE + H1, H2, H3
BIP (Bit Interleaved parity)	CV (Code Violation)
High Order Path (HP / HO)	STS Path
I-n Intra Office, (n=STM-n level)	Intermediate Reach (IR)
L-n.1 or L-n.2 long haul	LR long reach
Low Order Path (LP / LO)	VT Path
LP-REI	REI-V
M.S.P	A.P.S
Multiplexer Section (MS)	Line
Multiplexer Section Protection	Automatic Protection Switching
MS-AIS	Line AIS / AIS-L
MS-BIP	Line CV / CV-L
MS-DCC	Line DCC / DCC-L
MS-REI	Line FEBE / REI-L

ETSI/ANSI Terminology
ETSI/ANSI Conversion and Equivalent Terms

Table 7 **ETSI / ANSI Terminology , continued**

ETSI Term	ANSI Term
MS-RDI	Line FERF / RDI-L
Multiplexer Section Overhead	Line Overhead
Network Node Interface	Line Interface
OOF	SEF (severely errored frame defect)
Path AIS / AU-AIS	AIS-P
Path REI / HP REI	REI-P
Path FERF / HP RDI	RDI-P
Path IEC / AU-IEC	IEC-P
Path Overhead	Path Overhead
Regenerator	Repeater
Regenerator Section (RS)	Section
Regenerator Section Overhead	Section Overhead
Remote Alarm Indicator	RAI
RS-DCC	Section DCC (DCC-S)
Section Overhead (SOH)	Transport Overhead (TOH)
S-n.1 or S-n.2 short haul	Short Reach (SR)
SOH	TOH
STM-m	OC-n / STS-n (where $m = n \div 3$ for $m \geq 1$)
STM-0	STS-1
STM-1	OC3c / STS-3c
STM-4	OC-12 / STS-12
STM-16	OC-48 / STS-48
Tributary Unit (TU)	Virtual Tributary (VT)

ETSI/ANSI Terminology
ETSI/ANSI Conversion and Equivalent Terms

Table 7 **ETSI / ANSI Terminology , continued**

ETSI Term	ANSI Term
TU	VT
TU-11	VT 1.5
TU-12	VT 2
TU-2	VT 6
TU-3	NONE
TU BIP	VT BIP (CV-V)
TU RDI / LP-RDI	RDI-V
TUG	VT Group
TUG2	VT Group (12 columns)
TUG3	VT Group (86 columns)
TU multiframe	VT superframe
TU PATH AIS	VT AIS (AIS-V)
VC	SPE
VC4	STS3C SPE
Virtual Container (VC)	Synchronous Payload Envelope (SPE)

NOTE: VC is an ETSI abbreviation for Virtual Container and an ETSI / ANSI abbreviation for (ATM) Virtual Channel. The context of VC must therefore be taken into account when converting between standards.

Appendix C

Glossary of Terms

A brief explanation of terms and abbreviations used in the OmniBER 718.

Glossary

A		BPV	Bipolar Violation
AAL	ATM Adaptation Layer	C	
ABR	Available Bit Rate	CAS	Channel Associated Signaling
ADDF	Automatic Digital Distribution Frame	CBR	Constant Bit Rate
ADM	Add Drop Multiplexer	CCITT	Consultative Committee on International Telegraphy and Telephony
ADPCM	Adaptive Differential Pulse Coded Modulation	CCS	Common Channel Signaling
AIM	ATM Inverse Multiplexer	CDT	Cell Delay Tolerance
AIS	Alarm Indication Signal	CDV	Cell Delay Variation
AMI	Alternate Mark Inversion	CEPT	Committee of European PTTs
ANSI	American National Standards Institute	CMI	Coded Mark Inversion
APS	Automatic Protection Switching	CO	Central Office
ASCII	American Standard Code for Information Interchange	CPE	Customer Premises Equipment
ATM	Asynchronous Transfer Mode	CRC	Cyclic Redundancy Check
AU	Administrative Unit	CSES	Consecutive Severely Errored Seconds
AU-AIS	AU Pointer Justification Event	D	
AU-LOP	Loss of AU Pointer	D/I	Drop and Insert
AU-NDP	AU Pointer New Data Flag	DACS	Digital Access and Cross-connect Switches
B		dB	Decibel
BBER	Background Block Error Ratio	DCC	Data Communications Channel
BC	Background Channel	DCS	Digital Cross-connect Switches
BCD	Binary Coded Decimal	DDF	Digital Distribution Frame
BER	Bit Error Rate	DDN	Digital Data Network
BERT	Bit Error Rate Testing	DTMF	Dual Tone Multi frequency Signaling
BIP	Bit Interleaved Parity		
BPS	Bits Per Second		

Glossary of Terms

DWDM	Dense Wave Division Multiplexing	HO PTE	High Order Path Terminating Equipment
DXC	Digital Cross Connect	HO	High Order
E			
EB	Error Block	HP-IB	Hewlett-Packard Interface Bus (IEEE 488)
EOW	Engineering Orderwire	HP-PLM	High Path Payload Label Mismatch
ES	Error Seconds	HP-RDI	High Path Remote Defect Indication
ESF	Extended Superframe Format	HP-REI	High Path Remote Error Indication
ESR	Errored Second Ratio	HP-TIM	High Path Trace Identifier Mismatch
ETSI	European Telecommunications Standards Institute	HP-UNEQ	High Path Unequipped
F			
FAS	Frame Alignment Signal	Hz	Hertz (cycles per second)
FC	Foreground Channel	I	
FCS	Frame Check Sequence	IP	Internet Protocol (layer 3)
FDDI	Fiber Distributed Data Interface	ISDN	Integrated Services Digital Network
FEAC	Far End Alarm Channel	ISO	International Standards Organization
FEBE	Far End Block Error	ITU	International Telecommunications Union
FEC	Forward Error Connection	L	
FERF	Far End Receive Failure	LAN	Local Area Network
G			
GUI	Graphical User Interface	LCP	Link Control Protocol
H			
HDB3	High Density Bipolar 3	LO	Low Order
HDLC	High-level Data Link Control (layer 2)	LOF	Loss of Frame
HEC	Header Error Control	LOP	Loss of Path
HO Path RAI	High Order Path Remote Alarm Indication	LOS	Loss of Signal
		LP-PLM	Low Path Payload Label Mismatch
		LP-RDI	Low Path Remote Defect Indication
		LP-REI	Low Path Remote Error Indication

Glossary of Terms

LP-RFI	Low Path Remote Failure Indication	OS	Operations System
LP-TIM	Low Path Trace Identifier Mismatch	P	
LP-UNEQ	Low Path Unequipped	P/AR	Peak-to-Average Ratio
LSB	Least Significant Bit	PBX	Private Branch Exchange
LTE	Line Terminal Equipment	PC	Personal Computer
LTM	Line Terminal Multiplexer	PCM	Pulse Code Modulation
		PCN	Personal Communications Network
M		PCR	Peak Cell Rate
MS	Multiplex Section	PDH	Plesiochronous Digital Hierarchy
MS-AIS	Multiplex Section AIS	PES	Percentage Error Second
MSOH	Multiplex Section Overhead	POH	Path Overhead
MS-RDI	Multiplex Section Remote Defect Indication	POS	Packet Over SONET/SDH
MS-REI	Multiplex Section Remote Error Indication	POTS	Plain Old Telephone Service
MTBF	Mean Time Between Failures	PPP	Point-to-Point Protocol (for transmission of multiprotocol datagrams over point-to-point links)
MTIJ	Maximum Tolerance Input Jitter	PRBS	Pseudo Random Binary Sequence
MUX	Multiplexer	PSN	Packet Switched Network
N		PSTN	Public Switched Telephone Network
NDF	New Data Flag	PT	Payload Type
NE	Network Element	PTT	Public Telephone and Telegraph
NFAS	Non Frame Alignment Signal	PTE	Path Terminating Equipment
O		PU	Physical Unit
OAM	Operations, Administration and Maintenance	Q	
OC	Optical Carrier	QoS	Quality of Service
OH	Overhead		
OLTU	Optical Line Terminal Unit		
OOF	Out of Frame		

Glossary of Terms

R

RAI	Remote Alarm Indication
RDI	Remote Defect Indication
REBE	Remote End Block Error
REI	Remote Error Indication
RF	Radio Frequency
RS	Regenerator Section
RSOH	Regenerator Section Overhead
RSTE	Regenerator Section Terminating Equipment
RS-TIM	Regenerator Section Trace Identifier Mismatch
RX	Receiver

S

S/N	Signal to Noise Ratio
SCPI	Standard Commands for Programmable Instrumentation
SDH	Synchronous Digital Hierarchy
SDXC	Synchronous Digital Cross Connect
SEF	Severely Errored Frame
SES	Severely Errored Second
SESR	Severely Errored Seconds Ratio
SF	Super Frame
SOH	Section Overhead
SONET	Synchronous Optical Network
SPE	Synchronous Payload Envelope

STE	Section Terminating Equipment
STM	Synchronous Transport Module
STS	Synchronous Transport Signal
SUT	System Under Test

T

TDM	Time Division Multiplexing
TDMA	Time Division Multiple Access
TE	Terminal Equipment
TMN	Telecommunications Management Network
TOH	Transport Overhead
TU	Tributary Unit
TU-AIS	TU Alarm Indication Signal
TUG	Tributary Unit Group
TU-LOM	TU Loss of Multiframe
TU-LOP	Loss of TU Pointer
TU-NDF	TU Pointer New Data Flag
TX	Transmitter

U

UI	Unit Interval
----	---------------

V

VBR	Variable Bit Rate
VC	Virtual Channel
VC-n	Virtual Container
VP	Virtual Path
VT	Virtual Tributary
VXI	VMEbus Extensions for Instrumentation

Glossary of Terms

W

WAN	Wide Area Network
WDM	Wave Division Multi- plexing

Index

Numerics

- 156MTS compatibility, 292
- 7,4,1 Lengths
 - IP datagram, 187

A

- A1A2 Boundary Function, 59
- Accessories, 20
 - Connection, 20
- Alarm scan
 - DSn, 126
 - SONET, 125
- Alarms
 - ATM measuring, 175
 - POS, 191
- Alarms & errors
 - DSn add, 81
 - DSn payload add, 81
 - SONET add, 80
- Analysis measurement
 - DSn, 113
 - DSn payload, 113
 - SONET, 112
- APS messages
 - generation, 97
 - monitoring, 55
 - test function, 97
- ATM Alarms, 161, 175
- ATM Delay Performance, 172
- ATM Errors, 163
- ATM Operation, 149
- ATM Payloads
 - Receiver, 166
- ATM payloads
 - transmitter, 150
- ATM Results, 165
- ATM Service Disruption, 176
- ATM signal
 - Receiver, 168
- Automatic protection switch
 - message generation, 97
- Autotolerance, 134

B

- B/G mapping selection SDH, 31
- B/G mapping selection SONET, 31
- Background Distributions
 - ATM, 158

- Background mapping selection SDH, 31
- Background mapping selection SONET, 31
- Background Patterns, 308
- Background Traffic
 - ATM, 157
- Beep on received error, 291

C

- Capture overhead, 60
- Centronics printer, 249
- Channelized Testing, 198
- Cleaning Optical Connectors
 - Optical Connector cleaning, 19
- Cold Start
 - Front Panel Soft Recovery, 21
- Color control for error threshold indication, 297
- Confidence tests, 304
- Configuration
 - copy from disk to instrument, 282
 - copy from instrument to disk, 280
 - recall from disk, 278
 - recall from instrument, 262
 - store in instrument, 260
 - store on disk, 277
- Connecting
 - Accessories, 20
 - ESD Precautions Necessary, 16
 - To the Network, 16
- Connectors
 - Optical Interface, 17
- Continuity Test, 208
- Conventions, 15
- Convergence Sublayer, 153
- Copy configuration
 - from disk to instrument, 282
 - from instrument to disk, 280
- Coupling, 288
- Create directory, 265

D

- Datagram Length, 186
- Date & time, 289
- DCC
 - drop, 102
 - insert, 102
- DCC Insert test function, 102

- Delay Measurement
 - ATM, 173
- Delay Performance
 - ATM, 172
- Delay time, jitter tolerance, 136, 219
- Delete
 - directory, 270
 - file, 269
- Directory
 - create, 265
 - delete, 270
 - management, 265
- Disk
 - accessing a directory, 266
 - accessing files, 266
 - adding descriptors to files, 271
 - copy configuration from instrument, 280
 - copy configuration to instrument, 282
 - copy graphics results from instrument, 284
 - create directory, 265
 - delete directory, 270
 - delete file, 269
 - format a disk, 263
 - label a disk, 264
 - managing directories, 265
 - managing files, 265
 - recall configuration, 278
 - recall graphics results, 279
 - rename a file, 268
 - save data logging, 276
 - save graphics results, 274
- Drop
 - DCC, 102
 - external payload/test signal, 77
- DS1 Loop Codes, 103
- DSn
 - alarm scan, 126
 - analysis measurement, 113
 - errors & alarms, 81
 - external test signal drop, 77
 - external test signal insert, 74
 - frequency measurement, 114
 - frequency offset, 64
 - N X 64 kb/s payload transmit, 71
 - N X 64 kb/s test signal receive, 73
 - N X 64 kb/s test signal transmit, 71
 - payload, receive, 45

Index

- payload, transmit, 27
- receive interface, 45
- spare bits, 84
- structured test signal receive, 70
- structured test signal transmit, 68
- transmit interface, 26
- Dumping display to disk, 272
- Dwell time, jitter tolerance, 136, 219
- E**
- Error Burst Definition
 - Service Disruption, 120
- Error Indication
 - Audio setting, 291
- Error threshold indication
 - setting, 297
- Error threshold, jitter tolerance, 137, 219
- Errors
 - ATM, 163
- Errors & alarms
 - DSn add, 81
 - DSn payload add, 81
 - SONET add, 80
- Errors and alarms DSn test function, 81
- Errors and alarms SONET test function, 80
- ESD Precautions
 - For the Service Engineer, 16
- Exercising POS Hardware, 200
- Extended jitter
 - measurement, 129
 - receive interface, 49
- External
 - payload/test signal drop, 77
 - payload/test signal insert, 74
- External printer
 - connecting to parallel port, 254
- F**
- F/G mapping selection SDH, 31
- F/G mapping selection SONET, 31
- File
 - accessing, 266
 - delete, 269
 - descriptors, 271
 - management, 265
 - rename, 268
- Foreground Distributions
 - ATM, 158
 - Foreground mapping selection SDH, 31
 - Foreground mapping selection SONET, 31
 - Foreground Traffic
 - ATM, 155
 - Format a disk, 263
 - Frame Check Sequence, 183
 - Frequency measurement, 114
 - Frequency offset
 - DSn, 64
 - SONET, 62
 - SONET line rate, 62
 - SONET tributary, 63
 - Functional Tests (Smart Test), 40
- G**
- G.821 analysis measurement, 113
- G.826 analysis measurement, 113
- Glossary of Terms, 315
- Glossary of terms, 315
- graph storage, 296
- Graph storage resolution, 296
- Graphics
 - copy results from instrument to disk, 284
 - logging displays, 229
 - recall results from disk, 279
 - recall stored results, 223
 - saving results to disk, 274
 - saving to instrument, 222
 - storage resolution, 222
 - viewing error & alarm summaries, 227
 - viewing the bar graphs, 225
- H**
- H4 byte
 - sequence setting, 53
- HANDSET Connector, 20
- HDLC Frame Stuffing, 214
- HDLC Framing, 183
- Header
 - IP, 188
- HP path label monitoring, 55
- HP-IB printer, 250
- I**
- In-band DS1 Loopcode, 292
- In-band DS1 loopcode, 292
- In-band Loop codes, 103
- Insert
 - DCC, 102
 - external payload/test signal, 74
- Inserting Modules, 16
- Internal printer
 - change paper, 255
 - logging, 251
 - print head cleaning, 258
- IP addresses, 189
- IP Header, 188
- IP Packet Length, 186
- IP Payload, 190
- J**
- J1, J2 bytes
 - setting, 53
- Jitter, 144
 - measurement, 127, 129
 - receive interface, 48, 49
 - transmit interface, 33
- Jitter mask, 299, 301
- Jitter Tests (Smart Test), 40
- Jitter tolerance
 - delay time, 136, 219
 - dwell time, 136, 219
 - error threshold, 137, 219
 - graph result, 137, 220
 - logging results, 245
 - measurement, 134
 - number of points, 136, 219
 - text result, 137, 220
- Jitter transfer
 - accuracy, 138
 - calibration, 140
 - delay time, 141
 - dwell time, 141
 - graph results, 143
 - input mask, 141
 - logging results, 247
 - measurement, 138
 - number of points, 141
 - Q factor, 141
- K**
- Keyboard lock, 290
- L**
- Labeling a disk, 264
- Labels, overhead monitoring, 55

Index

- Laser apertures
 - Location, 18
 - Laser warning, 17
 - LID Connector, 20
 - Line overhead
 - insertion, 58
 - Location of Laser Apertures, 18
 - Lock keyboard, 290
 - Locking the Mask
 - Jitter, 300
 - Logging
 - device, 229, 241, 245, 247
 - error event, 231
 - graph displays, 229
 - jitter tolerance results, 245
 - jitter transfer results, 247
 - on Demand, 241
 - Overhead Capture, 241
 - overhead snapshot, 241
 - Pointer Graph, 241
 - results, 231
 - results snapshot, 241
 - SONET Tributary Scan, 241
 - test period, 231
 - to Centronics printer, 249
 - to disk, 276
 - to HP-IB printer, 250
 - to internal printer, 251
 - to RS-232-C printer, 252
 - LOH
 - insertion, 58
 - Loop Codes, 103
 - M**
 - M2100 analysis measurement, 113
 - M2110 analysis measurement, 113
 - M2120 analysis measurement, 113
 - Managing
 - disk directories, 265
 - disk files, 265
 - Measuring
 - DSn analysis, 113
 - extended jitter, 129
 - frequency, 114
 - jitter, 127
 - jitter tolerance, 134
 - jitter transfer, 138
 - optical power, 115
 - overhead BER, 108
 - round trip delay, 116
 - service disruption, 119
 - SONET analysis, 112
 - wander, 131
 - Monitor
 - equalizer, 45
 - indicator, 45
 - receive overhead, 54
 - MSP messages
 - generation, 97
 - monitoring, 55
 - test function, 97
 - O**
 - Optical
 - clock stress, 95
 - power measurement, 115
 - OPTICAL IN Connector, 18
 - Optical In port, 18
 - Optical Interface Connectors, 17
 - OPTICAL OUT Connector, 18
 - Optical Out port, 18
 - Out-of Band Loop Code, 103
 - Overhead
 - all labels, 53
 - APS messages monitoring, 55
 - BER test, 108
 - capture, 60
 - default transmit, 52
 - H4 byte sequences, 53
 - Labels monitoring, 55
 - monitor receive, 54
 - path monitor, 55
 - path transmit, 53
 - sequence generation, 58
 - TOH transmit, 52
 - trace messages, 56
 - transmit, 52
 - Overhead capture
 - trigger, 60
 - Overhead capture test function, 60
 - Overhead sequence
 - repeat run, 58
 - single run, 58
 - P**
 - Packet Rate, 187
 - Packet Size, 205
 - Paper change
 - internal printer, 255
 - Parallel port
 - connecting Centronics printer, 254
 - Path overhead
 - capture and display, 60
 - insertion, 58
 - Payload
 - analysis measurement, 113
 - DSn receive, 45
 - DSn transmit, 27
 - errors & alarms, 81
 - framing SONET transmit, 32
 - framing, SONET receive, 47
 - insert external, 74
 - N X 64 kb/s receive, 73
 - N X 64 kb/s transmit, 71
 - SONET receive, 47, 70
 - SONET transmit, 32, 68
 - spare bits, 84
 - Payload PoS, 181
 - Payloads ATM
 - transmitter, 150
 - POH
 - capture and display, 60
 - insertion, 58
 - monitor, 55
 - setting, 53
 - Pointer adjustments
 - burst, 86
 - new pointer, 86
 - offset, 86
 - Pointer adjustments test function, 85
 - Pointer graph, 93
 - Pointer graph test function, 93
 - Policing ATM Traffic, 170
 - POS Alarms, 191
 - POS Errors, 192
 - PoS Operation, 179
 - POS Payload Mappings, 182
 - POS Payloads, 181
 - receiver, 193
 - POS Smart Test, 44
 - PPP in HDLC-like framing, 183
 - Precautions
 - ESD when connecting, 16
 - Print head cleaning, 258
-

Index

- Printer
 - Centronics, 249
 - Centronics, connecting to parallel port, 254
 - Centronics, logging to, 249
 - HP-IB, logging to, 250
 - internal, changing paper, 255
 - internal, cleaning print head, 258
 - internal, logging to, 251
 - RS-232-C, logging to, 252
- Printer HP-IB, RS232, PARALLEL ONLY Connector, 20
- Printing results from disk, 253
- Protocol Stack, 180

- R**
- Random Lengths
 - IP datagram, 187
- Random packet gap, 201
- Recall
 - configuration from disk, 278
 - configuration from instrument, 262
 - graphics results from disk, 279
 - stored graph results, 223
- Receive interface
 - DSn, 45
 - extended jitter, 49
 - jitter, 48, 49
 - SONET, 47
 - wander, 50
- Receive settings
 - Coupled to transmit, 288
- Receiver ATM Payloads, 166
- Receiver ATM signal setup, 168
- REI-L enable/disable, 294, 295
- REI-L result enable, 294, 295
- Remote Control HP-IB, RS232, 10 BASE -T Connector, 20
- Removing Modules, 16
- Rename a file, 268
- Resolution, 296
- Result, 294, 295
- Results
 - ATM, 165
 - POS, 196
- Results Definitions
 - Trouble Scan, 109
- Round trip delay, 116

- RS-232-C
 - logging to printer, 252
- S**
- S1 sync status monitoring, 55
- Save
 - configuration to disk, 277
 - data logging to disk, 276
 - graphics results to disk, 274
 - graphics results to instrument, 222
- Scrambling, 183, 184
- Screen dump to disk, 272
- SDH
 - APS messages, 97
 - Mapping selection, 31
 - MSP messages, 97
- Self Test
 - confidence tests, 304
- Self test, 303
- Sequence generation test function, 58
- Sequences
 - Overhead generation, 58
- Service Disruption, 211
 - ATM, 176
- service disruption
 - DS1 and DS3, 120
- Service disruption measurement, 119
- Setting DSn THRU Mode, 28
- Setting Foreground and Background Distributions, 158
- Setting up Signaling Bits, 65
- Settings (Smart Test), 40
- Short term period selection, 111
- Signal, 42
- Signal Loss
 - suspending test on, 293
- Signal Quality (Smart Test), 40, 42, 44
- Signaling Bits
 - D4 and SLC-96 payloads, 118
 - ESF Payload, 118
 - Monitoring, 118
- Signaling bits
 - setting up, 65
- Smart Setup, 40
- Smart Test, 40
- SONET
 - alarm scan, 125
 - analysis measurement, 112
 - DCC insert, 102
 - errors & alarms add, 80
 - external payload drop, 77
 - frequency measurement, 114
 - frequency offset, 62
 - line rate offset, 62
 - Mapping selection, 31
 - N X 64 kb/s payload receive, 73
 - optical clock stress, 95
 - optical power measurement, 115
 - overhead BER test, 108
 - overhead capture, 60
 - overhead monitor, 54
 - overhead sequences, 58
 - overhead trace messages, 56
 - overhead transmit, 52
 - payload, receive, 47
 - payload, transmit, 32
 - pointer adjustments, 85
 - pointer graph, 93
 - receive interface, 47
 - service disruption measurement, 119
 - structured payload receive, 70
 - structured payload transmit, 68
 - thru mode, 37
 - transmit interface, 29
 - tributary rate offset, 63
 - tributary scan, 122
- Spare bits, 84
- Spare bits test function, 84
- Store
 - configuration in instrument, 260
 - configuration on disk, 277
- Stress test test function, 95
- STS-1 SPE Background Patterns, 308
- Suspending Test on Signal Loss, 293
- Suspending test on signal loss, 293
- Synchronization source
 - SDH, 182
 - SONET, 30

- T**
- Test Cell Explanation, 156
- Test function
 - APS messages, 97
 - DCC insert, 102
 - errors & alarms DSn, 81
 - errors & alarms SONET, 80

Index

- MSP messages, 97
- overhead BER test, 108
- overhead capture, 60
- pointer adjustments, 85
- pointer graph, 93
- sequence generation, 58
- spare bits, 84
- stress test, 95
- tributary scan, 122
- Test period selection, 111
- Test signal
 - drop external, 77
 - insert external, 74
 - N X 64kb/s receive, 73
 - N X 64kb/s transmit, 71
- Test Timing, 111
- Threshold indication setting, 297
- Throughput Testing, 204
- THRU mode DS_n, 28
- Thru mode SONET, 37
- Time & date, 289
- TOH
 - Setting, 52
- Trace messages, 56
- Traffic Policing, 170
- Transmit ATM Alarms, 161
- Transmit interface
 - DS_n, 26
 - jitter, 33
 - SONET, 29
 - wander, 35
- Transmit settings
 - Coupled to Receive, 288
- Tributary, 144
- Tributary Jitter, 144
- Tributary scan, 122
- Trigger Output, 306
- Trouble Scan, 109

- U**
- User defined, 301
- User Length
 - IP datagram, 186

- V**
- VGA Connector, 20
- Viewing
 - bar graphs, 225
 - graphics error & alarm summaries, 227
- Voice channel
 - round trip delay, 116

- W**
- Wander
 - bar graph, 133
 - measurement, 131
 - receive interface, 50
 - transmit interface, 35
- Wander reference
 - SDH, 182
- warning symbols, 18

Index

About This Edition

This edition of the OmniBER 718 SONET User Guide documents the product as of September 2000.

© Copyright Agilent Technologies. All rights reserved. Reproduction, adaption, or translation without prior written permission is prohibited, except as allowed under the copyright laws.

Sales and Service Offices

An up-to-date list of Agilent Offices is available through the Agilent Website at URL:
<http://www.agilent.com>

Product Notes/White Papers on ATM/POS operation

Refer to the Agilent Website at URL.
<http://www.agilent.com/tmo/Notes/English/index.htm>.
for access to the following Product Notes.

- ATM error performance testing, 5968-9885E.
- Verifying the policing functions in the ATM network, 5968-9884E.
- Physical layer jitter testing in an ATM environment, 5968-9883E.
- Measuring service disruption times in high speed ATM networks, 5968-9137E.
- Packet Over SONET/SDH (White Paper), 5980-2027E.
- Packet Over SONET/SDH Functional Testing, 5980-2376E.

In This Book

This book tells you how to select and use the various instrument functions available.

Printed in U.K.09/00
37718-90218

