

Notice

Hewlett-Packard to Agilent Technologies Transition

This manual may contain references to HP or Hewlett-Packard. Please note that Hewlett-Packard's former test and measurement, semiconductor products and chemical analysis businesses are now part of Agilent Technologies. To reduce potential confusion, the only change to product numbers and names has been in the company name prefix: where a product name/number was HP XXXX the current name/number is now Agilent XXXX. For example, model number HP 8648 is now model number Agilent 8648.

Contacting Agilent Sales and Service Offices

The sales and service contact information in this manual may be out of date. The latest service and contact information for your location can be found on the Web at:

<http://www.agilent.com/find/assist>

If you do not have access to the Internet, contact your field engineer. In any correspondence or telephone conversation, refer to your instrument by its model number and full serial number.



User's Guide
HP ESG Series Signal Generators

Serial Number Prefixes:

HP ESG-1000A, US3704 through US3723

HP ESG-2000A, US3704 through US3723

HP ESG-3000A, US3704 through US3723

HP ESG-4000A, US3704 through US3723



HP Part No. E4400-90076

Printed in USA

Print Date: December 1997 Supersedes: June 1997

©Copyright Hewlett-Packard Company 1997. All Rights Reserved. Reproduction, adaptation, or translation without prior written permission is prohibited, except as allowed under the copyright laws.

1400 Fountaingrove Parkway, Santa Rosa, CA 95403-1799, USA

Contents

1 Preparing for Use

Installing the Signal Generator 1-2

Checking the Shipment 1-2

Installing Front Handles and Rack Mount Flanges 1-4

Meeting Electrical and Environmental Requirements 1-5

Adjusting the Display Contrast 1-6

Selecting Inverse Video 1-6

Adjusting the Screen Saver 1-6

Selecting the Signal Generator's HP-IB Address 1-7

Selecting the Signal Generator's Programming Language 1-8

Verifying Signal Generator Operation 1-9

Operator's Check 1-9

2 Using Functions

Setting Frequency and Power Levels 2-2

To Set the RF Frequency 2-2

To Set a Frequency Reference and a Frequency Offset 2-3

To Set the RF Output Power Level 2-4

To Set an Amplitude Reference and an Amplitude Offset 2-4

Setting Up Internally-Generated Amplitude Modulation 2-6

Setting the Carrier Frequency 2-6

Setting the Power Level 2-6

Setting the AM Depth 2-6

Setting the AM Rate 2-7

Turning On Amplitude Modulation 2-7

Setting Up Internally-Generated Frequency Modulation 2-8

Setting the Carrier Frequency 2-8

Setting the Power Level 2-8

Setting the FM Deviation 2-8

Setting the FM Rate 2-9

Turning On Frequency Modulation 2-9

Contents

Creating a Step Sweep and a List Sweep 2-10

Configuring a Step Sweep 2-10

Turning On Continuous Step Sweep 2-11

Configuring a List Sweep Using Step Sweep Data 2-11

Editing List Sweep Points 2-11

Turning On List Sweep for a Single Sweep 2-12

Saving and Recalling an Instrument State 2-13

3 Troubleshooting

If You Encounter a Problem 3-2

- No RF Output? 3-2
- RF Output Power too Low? 3-2
- No Modulation at the RF Output? 3-2
- Can't Turn Off Sweep Mode? 3-3
- Recalled a Register and Sweep List is Missing? 3-3
- All of the Registers Where You Previously Stored Instrument States are Empty? 3-3
- Saved an Instrument State in a Register but the Register is Empty or Contains the Wrong State? 3-3
- The Power Supply has Shut Down 3-3
- Incorrect List Sweep Dwell Time? 3-4
- Can't Turn Off Help Mode? 3-4
- LF OUTPUT Signal is a Sinewave but the RF OUTPUT Signal is a Pulse Squarewave? 3-4

Error Messages 3-5

The Front Panel Error Queue 3-5

The SCPI Remote Interface Error Queue 3-5

Querying the Error Queue 3-7

Error Numbers 3-8

No Error 3-9

Contents

SCPI Standard Error Messages 3-10

Error Message Description 3-10

Command Error 3-11

Command Error Message Descriptions 3-11

Execution Error 3-17

Execution Error Message Descriptions 3-17

Device-Specific Error 3-25

Device-Specific Error Message Descriptions 3-25

Query Error 3-28

Query Error Message Descriptions 3-28

ESG Series Signal Generator Instrument-Specific Error Messages 3-30

Returning Your Signal Generator to HP 3-50

HP Sales and Service Offices 3-51

4 Front and Rear Panel

Front Panel Overview 4-2

Display Annotation 4-7

Rear Panel Overview 4-11

5 Hardkey and Softkey Reference

AM 5-3

AM Depth 5-3

AM Depth Couple Off On 5-4

Contents

AM Dual-Sine Ampl Ratio	5-4
AM Off On	5-5
AM Path 1 2	5-5
AM Rate	5-6
AM Source	5-7
AM Start Rate	5-8
AM Stop Rate	5-9
AM Sweep Time	5-9
AM Sweep Trigger	5-10
AM Tone 1 Rate	5-10
AM Tone 2 Rate	5-11
AM Waveform	5-11
Bus	5-12
Dual-Sine	5-12
Ext	5-12
Ext 1 AC-Coupled	5-13
Ext 1 DC-Coupled	5-14
Ext 2 AC-Coupled	5-15
Ext 2 DC-Coupled	5-15
Immediate	5-16
Internal	5-16
Noise	5-17
Ramp	5-17
Sine	5-17
Square	5-18
Swept-Sine	5-18
Triangle	5-18
Trigger In Polarity Neg Pos	5-19
Trigger Key	5-19
Trigger Out Polarity Neg Pos	5-20
Ampl	5-21
ALC Off On	5-21
Ampl Offset	5-22
Ampl Ref Set	5-22
Ampl Ref Off On	5-23
Atten Hold Off On	5-24
Do Power Search	5-24

Contents

Power Search Manual Auto 5-25

Amplitude 5-27

Arrow Keys 5-29

Display Contrast Keys 5-31

FM 5-33

Bus 5-33

DCFM/DC Φ M Cal 5-34

Dual-Sine 5-34

Ext 5-34

Ext 1 AC-Coupled 5-35

Ext 1 DC-Coupled 5-35

Ext 2 AC-Coupled 5-36

Ext 2 DC-Coupled 5-36

FM/ Φ M 5-37

FM Dev 5-37

FM Dev Couple Off On 5-38

FM Dual-Sine Ampl Ratio 5-38

FM Off On 5-39

FM Path 1 2 5-40

FM Rate 5-41

FM Source 5-42

FM Start Rate 5-43

FM Stop Rate 5-44

FM Sweep Time 5-44

FM Sweep Trigger 5-45

FM Tone 1 Rate 5-45

FM Tone 2 Rate 5-46

FM Waveform 5-46

Immediate 5-47

Internal 5-47

Noise 5-48

Ramp 5-48

Sine 5-48

Square 5-49

Contents

Swept-Sine	5-49
Triangle	5-49
Trigger In Polarity Neg Pos	5-50
Trigger Key	5-51
Trigger Out Polarity Neg Pos	5-51
Freq	5-53
Adjust Phase	5-53
Freq Multiplier	5-54
Freq Offset	5-55
Freq Ref Off On	5-56
Freq Ref Set	5-56
Mode 1 Optimize <10kHz Offset	5-57
Mode 2 Optimize >10kHz Offset	5-57
Optimize Φ Noise	5-58
Phase Ref Set	5-58
Frequency	5-59
Help	5-61
Hold	5-63
Incr Set	5-65
LF Out	5-67
Bus	5-67
DC	5-68
Dual-Sine	5-68
Ext	5-69
Function Generator	5-69
Immediate	5-70
Internal	5-70
LF Out Amplitude	5-71
LF Out Freq	5-71
LF Out Off On	5-72
LF Out Period	5-72
LF Out Source	5-73

Contents

LF Out Start Freq	5-74
LF Out Stop Freq	5-75
LF Out Sweep Time	5-76
LF Out Sweep Trigger	5-76
LF Out Tone 1 Freq	5-77
LF Out Tone 2 Ampl % Of Peak	5-78
LF Out Tone 2 Freq	5-79
LF Out Waveform	5-79
LF Out Width	5-80
Noise	5-80
Pulse	5-81
Ramp	5-81
Sine	5-82
Square	5-82
Swept-Sine	5-83
Triangle	5-83
Trigger In Polarity Neg Pos	5-84
Trigger Key	5-85
Trigger Out Polarity Neg Pos	5-85
Local	5-87
Mod On/Off	5-89
Mode	5-91
Numeric Keypad	5-93
Phase Modulation	5-95
ΦM Dev	5-95
ΦM Dev Couple Off On	5-97
ΦM Dual-Sine Ampl Ratio	5-97
ΦM Off On	5-98
ΦM Path 1 2	5-99
ΦM Rate	5-100
ΦM Source	5-101
ΦM Start Rate	5-102
ΦM Stop Rate	5-103
ΦM Sweep Time	5-103

Contents

ΦM Sweep Trigger	5-104
ΦM Tone 1 Rate	5-104
ΦM Tone 2 Rate	5-105
ΦM Waveform	5-105
Bus	5-106
DCFM/DCΦM Cal	5-106
Dual-Sine	5-106
Ext	5-107
Ext 1 AC-Coupled	5-107
Ext 1 DC-Coupled	5-108
Ext 2 AC-Coupled	5-108
Ext 2 DC-Coupled	5-109
FM/ΦM Normal High BW	5-109
Immediate	5-110
Internal	5-110
Noise	5-111
Ramp	5-111
Sine	5-111
Square	5-112
Swept-Sine	5-112
Triangle	5-112
Trigger In Polarity Neg Pos	5-113
Trigger Key	5-114
Trigger Out Polarity Neg Pos	5-114
Power Switch	5-115
Preset	5-117
Pulse	5-127
Ext2 DC-Coupled	5-127
Internal Pulse	5-128
Internal Square	5-128
Pulse Off On	5-129
Pulse Period	5-129
Pulse Rate	5-130
Pulse Width	5-130
Pulse Source	5-131

Contents

Recall 5-133

Delete All Regs in Seq [n] 5-133

Delete All Sequences 5-133

Delete Seq[n] Reg[nn] 5-134

Recall Reg 5-134

Select Seq 5-135

Return 5-137

RF On/Off 5-139

Save 5-141

Add Comment To Seq[n] Reg[nn] 5-141

Clear Text 5-142

Delete All Regs in Seq [n] 5-142

Delete All Sequences 5-143

Delete Seq[n] Reg[nn] 5-143

Editing Keys 5-143

Editing Mode Insert Replace 5-144

Save Seq[n] Reg[nn] 5-144

Select Reg 5-145

Select Seq 5-145

Sweep/List 5-147

Points 5-147

Ampl 5-148

Ampl Start 5-148

Ampl Stop 5-149

Bus 5-149

Configure List Sweep 5-150

Configure Step Sweep 5-150

Delete File 5-151

Delete Item 5-151

Delete Row 5-151

Dwell Type List Step 5-151

Edit Item 5-152

Ext 5-152

Freq 5-153

Contents

Freq&Ampl	5-153
Freq Start	5-154
Freq Stop	5-154
Goto Bottom Row	5-154
Goto Middle Row	5-155
Goto Row	5-155
Goto Top Row	5-155
Immediate	5-156
Insert Item	5-156
Insert Row	5-156
Load From Selected File	5-157
Load List From Step Sweep	5-157
Load/Store	5-157
Manual Mode Off On	5-158
Manual Point	5-158
Off	5-159
Page Down	5-159
Page Up	5-159
Point Trigger	5-160
Preset List	5-160
Single Sweep	5-160
Step Dwell	5-161
Store to File	5-161
Sweep	5-162
Sweep Direction Down Up	5-162
Sweep Repeat Single Cont	5-163
Sweep Trigger	5-163
Sweep Type List Step	5-163
Trigger In Polarity Neg Pos	5-164
Trigger Key	5-164
Trigger Out Polarity Neg Pos	5-165
Trigger	5-167
Utility	5-169
All	5-169
Binary	5-170
Black Pixels Screen Test	5-170

Contents

Brightness	5-170
Catalog Type	5-171
Clear Error Queue(s)	5-171
Clear Text	5-171
Copy File	5-172
Delete All Binary Files	5-172
Delete All Files	5-173
Delete All List Files	5-173
Delete All State Files	5-173
Delete File	5-174
Diagnostic Info	5-174
Display	5-174
Editing Keys	5-175
Editing Mode Insert Replace	5-175
Error Info	5-175
Help Mode Single Cont	5-176
HP8648A/B/C/D	5-176
HP-IB Address	5-177
HP-IB/RS-232	5-177
Instrument Adjustments	5-177
Instrument Info/Help Mode	5-178
Inverse Video Off On	5-178
List	5-178
Memory Catalog	5-179
Mod Status Info Off On	5-179
Off	5-179
Page Down	5-179
Page Up	5-180
Power On Last Preset	5-180
Power On/Preset	5-180
Preset Language	5-181
Preset Normal User	5-181
Recall Ref Osc Setting	5-182
Receive Pace None Xon	5-182
Reference Oscillator Adjustment	5-182
Ref Osc Coarse	5-183
Ref Osc Fine	5-183
Remote Language	5-183

Contents

Reset RS-232	5-183
Reverse Power Protection Normal HP8648	5-184
RS-232 Baud Rate	5-185
RS-232 Echo Off On	5-185
RS-232 Pace	5-185
RTS/CTS	5-186
RTS/CTS Pacing	5-186
RTS On	5-187
Save User Preset	5-187
SCPI	5-188
Screen Saver Delay	5-188
Screen Saver Mode	5-189
Screen Saver Off On	5-189
State	5-190
Step/Knob Ratio	5-190
Store Ref Osc Setting	5-190
Transmit Pace None Xon	5-191
View Next Error Message	5-191
View Previous Error Message	5-192
White Pixels Screen Test	5-192

6 Options and Accessories

Signal Generator Options	6-2
Front Handles (Option 1CN)	6-2
Rack Mount Flanges without Handles (Option 1CM)	6-2
Rack Mount Flanges with Handles (Option 1CP)	6-2
Three Year Warranty (Option W30)	6-2
Move All Front Panel Connectors to Rear Panel (Option 1EM)	6-3
High Stability Timebase (Option 1E5)	6-3
Delete Standard Manual Set (Option 0B0)	6-3
Extra Manual Set (Option 0B1)	6-4
Assembly-Level Service Guide (Option 0BW)	6-4
Component-Level Information Package (Option 0BV)	6-5
Assembly-Level Service Guide and Component-Level Information Package (Option 0BX)	6-5
User's Guide - Traditional Chinese for Taiwan (Option AB0)	6-5

Contents

User's Guide - Korean (Option AB1)	6-6
User's Guide - Chinese (Option AB2)	6-6
User's Guide - German (Option ABD)	6-6
User's Guide - Spanish (Option ABE)	6-6
User's Guide - Japanese (Option ABJ)	6-7

Signal Generator Accessories 6-8

Transit Case (HP Part Number 9211-1296)	6-8
Remote Interface (HP 83300A)	6-8
RS-232 Cable Kit	6-8

Upgrade and Retrofit Kits 6-9

Firmware Upgrade Kit	6-9
Firmware Upgrade Kit with Documentation	6-9
Analog to Digital Retrofit Kit	6-9

7 Operation

8 Safety and Regulatory

Safety Notes	8-2
Instrument Markings	8-3
General Safety Considerations	8-4
Statement of Compliance	8-5
Warranty	8-6
Assistance	8-7
Certification	8-8
Declaration of Conformity	8-9

Contents

Compliance with German Noise Requirements 8-10

9 Specifications

HP ESG Series Signal Generators Specifications 9-2

Frequency 9-2

Sweep Modes 9-3

Internal Reference Oscillator 9-4

Output 9-4

Spectral Purity 9-7

Frequency Modulation 9-8

Phase Modulation 9-10

Amplitude Modulation at $f_c > 500$ kHz 9-11

Pulse Modulation 9-12

Internal Modulation Source 9-13

LF Out (Internal Modulation Source) 9-14

External Modulation Inputs 9-14

Simultaneous Modulation 9-15

Remote Programming 9-15

ISO Compliant 9-15

General 9-16

Accessories 9-16

Options 9-17

Index

1 Preparing for Use

This chapter contains procedures that show you how to install your signal generator, and how to perform a functional check to verify signal generator operation.

Installing the Signal Generator

This section contains procedures for properly installing your signal generator:

- checking the shipment
- installing front handles and rack flange kits
- meeting electrical and environmental requirements
- adjusting the display
- selecting the signal generator's HP-IB address
- selecting the programming language

Checking the Shipment

1. Inspect the shipping container for damage.

Look for signs of damage such as a dented or torn shipping container or cushioning material that shows signs of unusual stress or compacting.

2. Carefully remove the contents from the shipping container and verify that your order is complete. Refer to Table 1-1 for a list of items that are shipped standard with the signal generator and for a list of options that you may also have ordered.

Table 1-1. Shipment Verification List

Part Number	Item Description	Option
Unique to Country	AC Power Cable	Standard
5063-9227	Front Handle Kit	1CN
5063-9214	Rack Flange Kit (without handles)	1CM
5063-9221	Rack Flange Kit (with handles)	1CP
E4400-90076	User's Guide (part of manual set E4400-90075)	Standard
E4400-90077	Programming Guide (part of manual set E4400-90075)	Standard
E4400-90078	Quick Reference Guide (part of manual set E4400-90075)	Standard
E4400-90079	Calibration Guide (part of manual set E4400-90075)	Standard
E4400-90075	Additional Manual Set	OB1
E4400-90008	Service Guide	0BW, 0BX
E4400-90015	Component Level Information Guide	0BV, 0BX
E4400-90024	User's Guide, Chinese for Taiwan	AB0
E4400-90023	User's Guide, Korean	AB1
E4400-90022	User's Guide, Chinese	AB2
E4400-90027	User's Guide, German	ABD
E4400-90026	User's Guide, Spanish	ABE
E4400-90025	User's Guide, Japanese	ABJ

Installing Front Handles and Rack Mount Flanges

You can attach handles to the front of the signal generator to facilitate transportation of the instrument. Handles are available in a kit which can be ordered when the signal generator is purchased (Option 1CN), or at any time afterward. Assembly instructions are included with the kit. The kit part number is listed in Table 1-2.

You can also rack mount the signal generator. Hardware is available in kits to install rack mount flanges on the signal generator without or with handles. These kits can be ordered when the signal generator is purchased (Options 1CM and 1CP), or at any time afterward. Assembly instructions are included with the kits. The kit part numbers are listed in Table 1-2.

Table 1-2. Front Handle and Rack Mount Flange Kits

Option	Description	HP Part Number
Option 1CN	Front Handle Kit	5063-9227
Option 1CM	Rack Mount Kit without Handles	5063-9214
Option 1CP	Rack Mount Kit with Handles	5063-9221

Providing Adequate Ventilation

CAUTION

Ventilation Requirements: When installing the product in a cabinet, the convection into and out of the product must not be restricted. The ambient temperature (outside the cabinet) must be less than the maximum operating temperature of the product by 4° C for every 100 watts dissipated in the cabinet. If the total power dissipated in the cabinet is greater than 800 watts, then forced convection must be used.

Cooling holes are located on the sides and bottom of the instrument cover and the rear panel of the instrument. Do not allow these holes to be obstructed as they allow air flow through the signal generator.

Meeting Electrical and Environmental Requirements

Line Settings

CAUTION: This product has an autoranging line voltage input. Be sure that the supply voltage is within the specified range.

The available AC power source must meet the following requirements:

Voltage:

- 100/115 volts nominal (90-132 volt range)
- 230/240 volts nominal (198-254 volt range)

Frequency:

- for 100/115 volts: 50/60/400 Hz nominal
- for 230/240 volts: 50/60 Hz nominal

Power:

- 200 watts maximum

Verify that the power cable is not damaged and that the power source socket outlet provides a protective earth contact.

WARNING

This is a Safety Class 1 Product (provided with a protective earthing ground incorporated in the power cord). The mains plug shall only be inserted in a socket outlet provided with a protective earth contact. Any interruption of the protective conductor inside or outside of the product is likely to make the product dangerous. Intentional interruption is prohibited.

CAUTION

Always use the three-prong AC power cord supplied with this product. Failure to ensure adequate earth grounding by not using this cord may cause product damage.

Environment

This product is designed for use in the following environmental conditions:

- indoor use
- < 15,000 feet (4,572 meters) altitude
- 0° to 55° C temperature, unless specified differently
- maximum relative humidity 80% for temperatures up to 31° C, decreasing linearly to 50% relative humidity at 40° C



CAUTION: This product is designed for use in INSTALLATION CATEGORY II and POLLUTION DEGREE 2, per IEC 1010 and 664 respectively.

WARNING **If this product is not used as specified, the protection provided by the equipment could be impaired. This product must be used in a normal condition only (in which all means for protection are intact).**

Cleaning the Signal Generator

Clean the instrument cabinet using a damp cloth only.

Adjusting the Display Contrast

You can adjust the contrast of the display by pressing the decrease contrast key  or the increase contrast key . These keys are located on the front panel below the display.

Pressing the decrease contrast key and holding it down causes the display background to gradually darken in comparison to the text on the display. The minimum contrast setting is not a completely black display. Some contrast between the background and the text will still be visible.

Pressing the increase contrast key and holding it down causes the display background to gradually brighten in comparison to the text on the display. If the background does not appear to change, it is probably set to the maximum contrast.

Selecting Inverse Video

The normal display mode for the signal generator is dark text on a light background. To change to inverse video (light text on a dark background), press **Utility, Display** and set **Inverse Video Off On** to **On**. Inverse video is a persistent state; it is not affected by an instrument preset or by a power cycle.

Adjusting the Screen Saver

You can increase the life expectancy of the signal generator's display light by turning on the screen saver. Leaving the display lit for long periods of time or turning the display on and off frequently decreases the life of the bulb. With the screen saver on, the display light is turned off after a defined period of time with no input to the front panel. The display light turns on again when any front panel key is pressed or when a remote command is sent.

The screen saver is set to off at the factory. You can turn it on by pressing **Utility, Display, Screen Saver Off On**. Each time you press **Screen Saver Off On** the selection toggles between **Off** and **On**.

You can adjust the screen saver mode to turn the light on and off or to turn both the light and text on and off. Press **Utility, Display, Screen Saver Mode**. You can toggle between **Light Only** and **Light&Text**. Setting the mode to **Light Only** turns the display light off but leaves the text visible at a low intensity. To prevent the text from burning the display if you are leaving the display unchanged for long periods of time, set the mode to **Light&Text**. This mode turns off the display light and the text.

The screen saver delay is set to 1 hour at the factory. You can view and change the delay by pressing **Screen Saver Delay** in the same menu. The current screen saver delay is displayed in the softkey label and also in the active entry area. To change the delay, enter a new value using the numeric keypad and then press **Enter**, or rotate the front panel knob. The acceptable range of delay values is 1 through 12 hours in 1 hour increments.

The screen saver settings do not change when **Preset** is pressed, nor when power to the instrument is cycled.

Selecting the Signal Generator's HP-IB Address

The signal generator's HP-IB address is set to 19 at the factory. You can view and change the address by pressing **Utility, HP-IB/RS-232, HP-IB Address**. The current HP-IB address is displayed in the softkey label and also in the active entry area. To change the address, enter a new value using the numeric keypad and then press **Enter**, or rotate the front panel knob. The acceptable range of addresses is 0 through 30.

The HP-IB address is a persistent state; it is not affected by an instrument preset or by a power cycle.

Selecting the Signal Generator's Programming Language

The default programming language for the signal generator is Standard Commands for Programmable Instruments (SCPI). You can change this language selection by pressing **Utility, HP-IB/RS-232, Remote Language**. The Remote Language menu allows you to select between HP 8656/57-compatible language, HP 8648-compatible language, and SCPI language. Press the softkey for the selection that you desire.

You can also change the language selection by sending the appropriate command over HP-IB. Refer to the programming guide for instructions for changing the language over HP-IB.

You can set the signal generator to default to a selected language as a persistent state (remains unchanged after an instrument preset or power cycle). Press **Utility, Power On/Preset, Preset Language**. The Preset Language menu allow you to select between SCPI, the HP 8656/57-compatible programming language, and HP 8648-compatible language. Press the softkey for the selection that you desire.

Verifying Signal Generator Operation

The operator's check is appropriate as a daily functional check by users, or whenever the integrity of the signal generator is in question. Use the operator's check to verify proper operation of the signal generator. The operator's check does not ensure performance to specifications. To verify specifications, refer to the calibration guide.

Operator's Check

Perform the following tasks in order:

1. Power On the Signal Generator and Check for Error Messages

This procedure verifies that the signal generator powers up and that the internal instrument check identifies no errors.

1. Turn power on to the signal generator by pressing the power switch. The green LED will light. Let the instrument warm up for one hour.
2. Cycle the power to the signal generator. The green LED should again be lit and the instrument will perform a check.
3. When the display is lit, check to see if the **ERR** annunciator is turned on.
4. If the **ERR** annunciator is turned on, review the error messages in the queue by pressing **Utility, Error Info**. The first error message in the queue will be shown in the text area of the display. Refer to Chapter 3, "Troubleshooting," for information about the error message.

If there is more than one error message (each message will be designated as 1 of *n*), press the **View Next Error Message** softkey until you have seen all of the messages.

5. When you have resolved all of the error messages, press **Clear Error Queue(s)** to delete the messages. Then restart this procedure at step two.

Note: For instruments with Option 1E5, **ERROR 514, Reference Oven Cold** will occur whenever the signal generator is first connected to AC line power. The **OVEN COLD** annunciator and the **ERR** annunciator will both turn on. The **OVEN COLD** annunciator will automatically clear after approximately 5 minutes. The error queue *cannot* be cleared, however, until the **OVEN COLD** annunciator has turned off.

Preparing for Use
Verifying Signal Generator Operation

2. Verify Maximum Specified Power is Available at the Maximum Frequency

This procedure verifies that there are no unlevelled power indications or error messages at the maximum specified frequency and power level.

1. Calibrate the power meter with the power sensor. (Refer to the power meter's manual for assistance.)
2. Connect the power sensor to the signal generator's RF OUTPUT connector as shown in Figure 1-1.

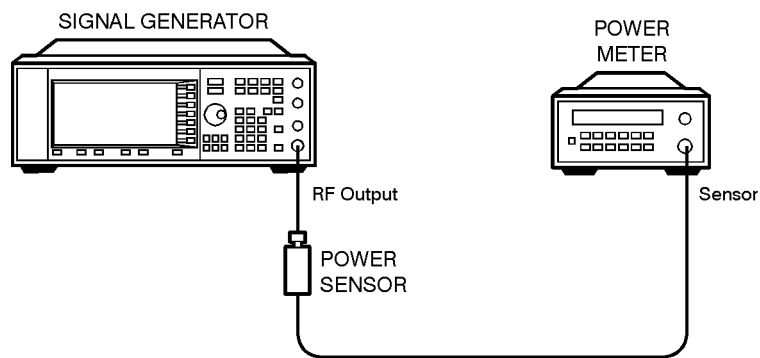

pk717a

Figure 1-1.

Operator's Check Equipment Setup

3. Preset the signal generator to the factory-defined conditions:
 - a. Press **Utility, Power On/Preset** and toggle **Preset** until **Normal** is highlighted.
 - b. Press the front panel **Preset** key.
4. Set the signal generator to its maximum specified frequency:
 - a. Press **Frequency**.
 - b. Use the numeric keypad to enter the signal generator's maximum specified frequency as shown in Table 1-3.
 - c. Terminate your entry by pressing the **GHz** softkey.
5. Set the signal generator to its maximum specified power level:
 - a. Press **Amplitude**.
 - b. Use the numeric keypad to enter the signal generator's maximum specified power level as shown in Table 1-3.
 - c. Terminate your entry by pressing the **dBm** softkey.

6. Toggle the front panel **RF On/Off** key to turn on RF power to the RF OUTPUT connector. The display **RF ON** annunciator will turn on.
7. Verify that the power meter reads the maximum specified output power including the power level accuracy limits.
8. Check to see if the **UNLEVEL** or **ERR** display annunciators have turned on. If these annunciators are on, refer to the service guide for troubleshooting information.

Table 1-3.

Frequency and Power Level Limits

Instrument Model	Maximum Specified Frequency	Maximum Specified Power	Power Level Accuracy Limits¹
HP ESG-1000A	1 GHz	+13 dBm	±0.7 dB
HP ESG-2000A	2 GHz	+10 dBm	±0.7 dB
HP ESG-3000A	3 GHz	+10 dBm	±1.0 dB
HP ESG-4000A	4 GHz	+7 dBm	±1.0 dB

1. The values provided are confidence levels only; they are not specifications.

Preparing for Use
Verifying Signal Generator Operation

2 Using Functions

This chapter contains procedures that show you how to use some of the major functions of your signal generator including setting frequency and power levels, setting up modulations, creating step and list sweeps, and saving and recalling instrument states.

Setting Frequency and Power Levels

Using these procedures, you will learn how to:

- set the RF frequency
- set a frequency reference and a frequency offset
- set the RF output power level
- set an amplitude reference and an amplitude offset

To Set the RF Frequency

1. Turn power on to the signal generator: press the power switch, , so that the green LED is on. The signal generator will perform an internal check.
2. Press the green **Preset** key. The signal generator will return to a set of factory-defined conditions.

NOTE:

You can change the preset conditions to a user-defined instrument state. However, for the purpose of these examples, use the factory-defined preset state (the **Preset Normal User** softkey in the **Utility** menu must be set to **Normal**).

3. Observe the frequency area of the display (in the upper left-hand corner). It should display the maximum specified frequency of your signal generator.
4. The signal generator is set to output an RF signal, however the **RF On/Off** key must be set to **On** before the RF signal is available at the RF OUTPUT connector. Press **RF On/Off**. Notice that the display annunciator changes from **RF OFF** to **RF ON**. The maximum specified frequency is now being output at the RF OUTPUT connector.
5. Change the frequency to 700 MHz by pressing **Frequency**. The current RF frequency is now displayed in the active entry area of the display. Using the numeric keypad, enter **700** and then press the **MHz** terminator softkey. The new 700 MHz RF frequency is now displayed in the frequency area of the display and also in the active entry area.
6. Frequency is still the active function until you press another front panel function key. Change the frequency again by pressing the up arrow key once. Each press of the up arrow key increases the frequency by the value set for the **Incr Set** key. The increment value is displayed in the active entry area.

The down arrow works like the up arrow. Practice stepping the frequency up and down in 1 MHz increments. Use the **Incr Set** key to change the increment value to 1 MHz, if necessary.

7. You can also adjust the RF frequency using the front panel knob. As long as frequency is the active function (the frequency is displayed in the active entry area), the front panel knob will increase and decrease the RF frequency. Use the front panel knob to adjust the frequency back to 700 MHz.

To Set a Frequency Reference and a Frequency Offset

The following procedure sets the RF output frequency as a reference frequency to which all other frequency parameters are relative. The frequency initially shown on the display will be 0 Hz (the frequency output by the hardware minus the reference frequency.) Although the display changes, the frequency output does not change. Any subsequent frequency changes are shown as incremental or decremental to 0 Hz.

1. Press **Preset** to return the signal generator to the factory-defined instrument state.
2. Set the RF frequency to 700 MHz.
3. Turn on frequency reference mode and set the current output frequency (700 MHz) as the reference value. Press **Freq, Freq Ref Set**. The frequency displayed is 0 Hz (the frequency output by the hardware, 700 MHz, minus the reference value, 700 MHz). Notice that the **REF** indicator is turned on and the **Freq Ref** softkey has toggled to **On**.
4. Set the **RF On/Off** key to **On**. Notice that the display annunciator has changed from **RF OFF** to **RF ON**. The RF frequency at the RF OUTPUT connector is 700 MHz.
5. Increment the output frequency by 1 MHz. Press the up arrow key. The frequency display changes to show 1 MHz (the frequency output by the hardware, 700 MHz + 1 MHz, minus the reference frequency, 700 MHz) and the output frequency changes to 701 MHz.
6. Enter a 1 MHz offset. Press the **Freq Offset** softkey and enter 1 MHz using the numeric keypad and pressing the **MHz** terminator softkey. The frequency display shows 2 MHz (the frequency output by the hardware, 701 MHz, minus the reference frequency, 700 MHz, plus the offset, 1 MHz.) Notice that the **OFFSET** indicator is turned on. The frequency at the RF OUTPUT connector is still 701 MHz.

To Set the RF Output Power Level

1. Press **Preset** to return the signal generator to the factory-defined instrument state.
2. Observe the amplitude area of the display (in the upper middle of the display). It should display -135 dBm. This is the normal preset RF output power level.
3. The signal generator is set to output an RF signal, however the **RF On/Off** key must be set to **On** before the RF signal is available at the RF OUTPUT connector. Press **RF On/Off**. Notice that the display annunciator changes from **RF OFF** to **RF ON**. The RF signal is now being output at a -135 dBm level at the RF OUTPUT connector.
4. Change the power level to -20 dBm. Press **Amplitude**. The current power level is now displayed in the active entry area of the display. Using the numeric keypad and the  key, enter -20 and then press the **dBm** softkey. The new -20 dBm RF output power is now displayed in the amplitude area of the display and also in the active entry area.
5. Amplitude is still the active function until you press another front panel function key. You can also change the amplitude using the up and down arrow keys and the front panel knob. Practice changing the amplitude using these methods also.

To Set an Amplitude Reference and an Amplitude Offset

The following procedure sets the RF output power as an amplitude reference to which all other amplitude parameters are relative. The amplitude initially shown on the display will be 0 dB (the power output by the hardware minus the reference power). Although the display changes, the output power does not change. Any subsequent power changes are shown as incremental or decremental to 0 dB.

1. Press **Preset** to return the signal generator to the factory-defined instrument state.
2. Set the RF output power to -20 dBm.
3. Turn on amplitude reference mode and set the current output power (-20 dBm) as the reference value. Press **Ampl, More (1 of 2), Ampl Ref Set**. The amplitude displayed is 0 dB (the power output by the hardware, -20 dBm, minus the reference value, -20 dBm.) Notice that the **REF** indicator is turned on and the **Ampl Ref** softkey has toggled to **On**.
4. Set the **RF On/Off** key to **On**. Notice that the display annunciator has changed from **RF OFF** to **RF ON**. The power at the RF OUTPUT connector is -20 dBm.
5. Use the up arrow key to increase the output power by 10 dB. The amplitude display changes to show 10 dB (the power output by the hardware, -20 dBm + 10 dBm, minus the reference power, -20 dBm) and the output power changes to -10 dBm.

6. Enter a 10 dB offset. Press the **Ampl Offset** softkey and enter 10 dB using the numeric keypad. The amplitude display shows 20 dB (the power output by the hardware, -10 dBm, minus the reference power, -20 dBm, plus the offset, 10 dB). Notice that the **OFFS** indicator is turned on. The power at the RF OUTPUT connector is still -10 dBm.

Setting Up Internally-Generated Amplitude Modulation

Using this procedure, you will learn how to generate an amplitude-modulated signal with the following characteristics:

- carrier frequency set to 1340 kHz
- power level set to 0 dBm
- AM depth set to 90%
- AM rate set to 10 kHz

Setting the Carrier Frequency

1. Press **Preset** to return the signal generator to the factory-defined instrument state.
2. Press the front panel **Frequency** key. Frequency becomes the active function and the normal preset value for frequency is displayed in the active entry area.
3. Enter 1340 kHz using the numeric keypad and pressing the **kHz** terminator softkey. The new carrier frequency is shown in the frequency area of the display. You should see **1.340 000 00 MHz**.

Setting the Power Level

1. Press the front panel **Amplitude** key. Amplitude becomes the active function and the normal preset value for amplitude is displayed in the active entry area.
2. Enter 0 dBm using the numeric keypad and pressing the **dBm** terminator softkey. The new power level is shown in the amplitude area of the display. You should see **0.00 dBm**.

Setting the AM Depth

1. Press the front panel **AM** key. The first level menu of softkeys is displayed.
2. Press the **AM Depth** softkey. AM depth becomes the active function and the normal preset value for AM depth is displayed in the active entry area.
3. Enter 90% using the numeric keypad and pressing the **%** terminator softkey. The new AM depth is displayed below the **AM Depth** softkey. You should see **90.0 %** in the second line of the softkey.

Setting the AM Rate

1. In the same AM menu, press the **AM Rate** softkey. AM rate becomes the active function and the normal preset value for AM rate is displayed in the active entry area.
2. Enter 10 kHz using the numeric keypad and pressing the **kHz** terminator softkey. The new AM rate is displayed below the **AM Rate** softkey. You should see **10.0000 kHz** in the second line of the softkey.

Turning On Amplitude Modulation

The signal generator is now configured to output a 0 dBm, amplitude-modulated carrier at 1340 kHz with the AM depth set to 90% and the AM rate set to 10 kHz. The shape of the waveform is a sinewave (notice that sine is the default for the **AM Waveform** softkey). Follow these remaining steps to output the amplitude-modulated signal.

1. In the same AM menu, press the **AM Off On** softkey. AM toggles from **Off** to **On**. Notice, also, that the **AM** display annunciator is turned on indicating that you have enabled amplitude modulation.
2. Press the front panel **RF On/Off** key to toggle RF on. Notice that the display annunciator changes from **RF OFF** to **RF ON**. The modulated signal is now available at the RF OUTPUT connector.

Setting Up Internally-Generated Frequency Modulation

Using this procedure you will configure the signal generator to output a frequency-modulated signal with the following characteristics:

- carrier frequency set to 104.9 MHz
- power level set to 0 dBm
- FM deviation set to 75 kHz
- FM rate set to 10 kHz

Setting the Carrier Frequency

1. Preset the signal generator to normal preset conditions.
2. Press the front panel **Frequency** key. Frequency becomes the active function and the normal preset value for frequency is displayed in the active entry area.
3. Enter 104.9 MHz using the numeric keypad and pressing the **MHz** terminator softkey. The new carrier frequency is shown in the frequency area of the display. You should see **104.900 000 00 MHz**.

Setting the Power Level

1. Press the front panel **Amplitude** key. Amplitude becomes the active function and the normal preset value for amplitude is displayed in the active entry area.
2. Enter 0 dBm using the numeric keypad and pressing the **dBm** terminator softkey. The new power level is shown in the amplitude area of the display. You should see **0.00 dBm**.

Setting the FM Deviation

1. Press the front panel **FM/ΦM** key. The first level menu of FM softkeys is displayed.
2. Press the **FM Dev** softkey. FM deviation becomes the active function and the normal preset value for FM deviation is displayed in the active entry area.
3. Enter 75 kHz using the numeric keypad and pressing the **kHz** terminator softkey. The new FM deviation is displayed below the **FM Dev** softkey. You should see **75.0000 kHz** in the second line of the softkey.

Setting the FM Rate

1. In the same FM menu, press the **FM Rate** softkey. FM rate becomes the active function and the normal preset value for FM rate is displayed in the active entry area.
2. Enter 10 kHz using the numeric keypad and pressing the **kHz** terminator softkey. The new FM rate is displayed below the **FM Rate** softkey. You should see **10.0000 kHz** in the second line of the softkey.

Turning On Frequency Modulation

The signal generator is now configured to output a 0 dBm, frequency-modulated carrier at 104.9 MHz with the FM deviation set to 75 kHz and the FM rate set to 10 kHz. The shape of the waveform is a sinewave (notice that sine is the default for the **FM Waveform** softkey - press **More (1 of 2)** to see the softkey). Follow these remaining steps to output the frequency-modulated signal.

1. In the same FM menu, press the **FM Off On** softkey. FM toggles from **Off** to **On**. Notice, also, that the **FM** display annunciator is turned on indicating that you have enabled frequency modulation.
2. Press the front panel **RF On/Off** key to toggle RF on. Notice that the display annunciator changes from **RF OFF** to **RF ON**. The modulated signal is now available at the RF OUTPUT connector.

Creating a Step Sweep and a List Sweep

Using this procedure, you will learn two ways to set up the signal generator to sweep a defined set of points. You will create a step sweep and then you will use these points as the basis for a new list sweep.

In the first procedure, you will create a step sweep with the following ten equally spaced points:

- frequency range from 525 MHz to 600 MHz
- power level from –20 dBm to 0 dBm
- dwell time 500 ms at each point

In the second procedure, you will take the step sweep points and edit several points to change the sweep information.

Configuring a Step Sweep

1. Press **Preset** to return the signal generator to the factory-defined instrument state.
2. Press the front panel **Sweep/List** key. The first level of sweep softkeys is displayed. Toggle the **Sweep Type List Step** softkey to **Step**.
3. Press the **Configure Step Sweep** softkey. Another menu is displayed with softkeys that you will use to create the sweep points.
4. Change the start frequency of the step sweep. Press the **Freq Start** softkey. Enter 525 MHz using the numeric keypad and pressing the **MHz** terminator softkey.
5. Change the stop frequency of the step sweep. Press the **Freq Stop** softkey. Enter 600 MHz using the numeric keypad and pressing the **MHz** terminator softkey.
6. Set the power level for the start of the step sweep. Press the **Ampl Start** softkey. Enter –20 dBm using the numeric keypad and pressing the **dBm** terminator softkey.
7. Set the power level for the end of the step sweep. Press the **Ampl Stop** softkey. Enter 0 dBm using the numeric keypad and pressing the **dBm** terminator softkey.
8. Set the number of sweep points. Press the **# Points** softkey. Enter 10 by rotating the front panel knob until the number 10 is displayed.
9. Set the dwell time at each point. Press the **Step Dwell** softkey. Enter 500 ms using the numeric keypad and pressing the **msec** terminator softkey.

Turning On Continuous Step Sweep

1. Press **Return** to move up one menu level.
2. Press the **Sweep** softkey. Another menu is displayed showing you choices for sweeping either the frequency, amplitude, or frequency and amplitude data. Press the **Freq&Ampl** softkey. Selecting this softkey returns you to the previous menu and turns the sweep function on.
3. Press the **Sweep Repeat Single Cont** softkey to toggle from **Single** to **Cont**. Notice that the **SWEEP** display annunciator is turned on indicating that the signal generator is sweeping.
4. Press the front panel **RF On/Off** key to toggle RF on. Notice that the display annunciator changes from **RF OFF** to **RF ON**. The swept RF signal is now available at the RF OUTPUT connector.

Configuring a List Sweep Using Step Sweep Data

1. Press the **Sweep Type List Step** softkey to toggle from **Step** to **List**.
2. Press the **Configure List Sweep** softkey. Another menu is displayed with softkeys that you will use to create the sweep points. Notice that the display shows the current list data (when no list has been previously created, the default is one point, set to the signal generator's maximum frequency, -135 dBm, with a dwell time of 2 ms).
3. Press **More (1 of 2)**, **Load List From Step Sweep**, **Confirm Load From Step Sweep**. The points you defined in the step sweep are automatically loaded into the list.

Editing List Sweep Points

1. Change the dwell time for point 1 to 100 ms. Press the right arrow key twice until the dwell time is highlighted. Press **More (2 of 2)**, **Edit Item**. The dwell time for point 1 becomes the active function. Enter 100 ms using the numeric keypad and pressing the **msec** terminator softkey. Notice that the next item in the table (in this case the frequency value for point 2) becomes highlighted after pressing the terminator softkey.
2. Change the frequency for point 4 to 560 MHz. Press the down arrow key two times until the frequency is highlighted. Press the **Edit Item** softkey. The frequency for point 4 becomes the active function. Enter 560 MHz using the numeric keypad and pressing the **MHz** terminator softkey.
3. Add a new point between points 7 and 8. Press the down arrow until any column in the point 8 row is highlighted. Press the **Insert Row** softkey. A copy of point 8 has been placed between points 7 and 8, creating a new point 8, and renumbering the successive points.

Using Functions

Creating a Step Sweep and a List Sweep

4. Create a new point between points 10 and 11. Use the arrow keys to highlight the frequency for point 11. Press the **Insert Item** softkey. Notice that a new frequency item is placed at point 11 and the frequency item previously occupying that position has shifted down to point 12. The power and dwell time items do not shift down. Press the **Edit Item** softkey. Enter 700 MHz using the numeric keypad and pressing the **MHz** terminator softkey.

NOTE:

An informational **ERR** annunciator is turned on at this time indicating that the frequency and power lists are of unequal size. You will correct that problem in the following steps. The annunciator will not turn off until you clear the error queue in the **Utility** menu.

The power for point 11 should now be highlighted. Press the **Insert Item** softkey, then press the **Edit Item** softkey and enter 1 dBm using the numeric keypad and pressing the **dBm** terminator softkey. A new power item is placed at point 11 and the power item previously occupying that position has shifted down to point 12.

The dwell time for point 11 should now be highlighted. Press the **Insert Item** softkey. The dwell time from the previous point 11 has been copied into the new point 11. A new dwell time item is placed at point 11 and the dwell time item previously occupying that position has shifted down to point 12.

Turning On List Sweep for a Single Sweep

1. Press **Return** to move up one menu level.
2. Notice that the **Sweep** softkey is still set to sweep both frequency and amplitude data. You do not need to change it.
3. Press the **Sweep Repeat Single Cont** softkey to toggle from **Cont** to **Single**. Notice that the **SWEEP** display annunciator is turned off. The sweep will not occur until it is triggered.
4. Press **Single Sweep**. The signal generator will sweep the points in your list once. Notice that the **SWEEP** display annunciator is turned on during the sweep.
5. Change the sweep trigger to occur when you press the front panel **Trigger** key. Press **More (1 of 2), Sweep Trigger**. Another menu is displayed showing you choices for triggering a sweep. Press the **Trigger Key** softkey.
6. Press **More (2 of 2), Single Sweep** to arm the sweep. Notice that the **ARMED** display annunciator has turned on.
7. Press the front panel **Trigger** key. The signal generator will sweep the points in your list once and the **SWEEP** display annunciator is turned on during the sweep.

Saving and Recalling an Instrument State

Using this procedure, you will learn how to save instrument settings to a memory register and to recall the settings.

1. Press **Preset** to return the signal generator to the factory-defined instrument state.
2. Set up the signal generator with the following changes:
 - a. Set the frequency to 800 MHz.
 - b. Set the amplitude to 0 dBm.
 - c. Enable amplitude modulation (**AM** display annunciator is on).
3. Save this instrument state in the signal generator memory in sequence 1, memory register 01. Press the front panel **Save** key and then press the **Select Seq** softkey. The sequence number becomes the active function. The signal generator will display the last sequence that you have used. Set the sequence to 1 using the arrow keys.

Press the **Select Reg** softkey. The register number in sequence 1 becomes the active function. The signal generator will either display the last register used [accompanied by the text: **(in use)**] or, if no registers are in use, will display register 00 [accompanied by the text: **(available)**]. Use the arrow keys to select register 01.

4. Press the **Save Seq[1] Reg[01]** softkey. The current instrument settings including the frequency, amplitude, and modulation changes you made have been stored in signal generator memory.
5. Press **Preset** to return the signal generator to the factory-defined instrument state.
6. Recall your instrument state. Press the front panel **Recall** key. Notice that the **Select Seq** softkey shows sequence 1. (This is the last sequence that you have used.) You do not need to change the sequence. Press **RECALL Reg**. The register to be recalled in sequence 1 becomes the active function. Press the up arrow key once to select register 1. Notice that your stored instrument settings have been immediately recalled.

Using Functions
Saving and Recalling an Instrument State

3 Troubleshooting

This chapter contains instructions for troubleshooting problems you may encounter during operation of the signal generator, it explains error messages you might see, and it explains how to return your signal generator to HP for service.

If You Encounter a Problem

If the signal generator is not operating as you expected, look for help in the following list of symptoms and possible solutions. If you do not find a solution here, refer to the service guide.

• No RF Output?

The front panel **RF On/Off** key must be set to **On** before the RF signal is available at the RF OUTPUT connector. Check the annunciator on the display. If it reads **RF OFF**, press the **RF On/Off** key once to toggle the RF output on.

• RF Output Power too Low?

If the RF output power seems too low, look for an **OFFSET** or **REF** indicator in the amplitude area of the display.

OFFSET tells you that an amplitude offset has been set. An amplitude offset changes the value shown in the amplitude area of the display but does not affect the output power. The amplitude displayed is equal to the current power output by the signal generator hardware plus the value for the offset. To eliminate the offset, press **Ampl**, **Ampl Offset**. Enter **0** using the numeric keypad and press the **dB** terminator softkey.

REF tells you that the amplitude reference mode is turned on. When this mode is on, the displayed amplitude value is *not* the output power level; rather, it is the current power output by the signal generator hardware minus the reference value set by the **Ampl Ref Set** softkey. To exit the reference mode, press **Ampl** and toggle the **Ampl Ref** softkey to **Off**. You can then reset the output power to the desired level.

• No Modulation at the RF Output?

Although you can set up and enable various modulations, the RF carrier is modulated by the enabled modulation only when you have also set **Mod On/Off** to **On**. Check the annunciator on the display. If it reads **MOD OFF**, press the **Mod On/Off** key once to toggle the modulation on.

- **Can't Turn Off Sweep Mode?**

In the sweep mode menu you can choose to set the sweep to various sweep types or to turn sweep off. Press **Sweep/List**, **Sweep** and choose **Off** from the sweep mode selections.

- **Recalled a Register and Sweep List is Missing?**

Sweep information is not stored as part of the instrument state in a storage register. Only the current step and list sweep is available to the signal generator and it cannot be stored nor will it survive a factory preset.

- **All of the Registers Where You Previously Stored Instrument States are Empty?**

The save/recall registers are backed-up by a battery when AC power to the signal generator is not connected. The battery may need to be replaced. To verify that the battery has failed, turn power off line power to the signal generator and unplug it. Then plug in the instrument and cycle power on. If either error message -311 or -700 is stored in the error message queue, your battery has failed. Refer to the service guide for battery replacement instructions.

- **Saved an Instrument State in a Register but the Register is Empty or Contains the Wrong State?**

If you have intentionally, or unintentionally, selected a register number that is greater than 99, the signal generator will automatically select register 99 to save your instrument state. If the register number you intended to use is empty or contains the wrong instrument state, recall register 99 as the instrument state may be saved there.

- **The Power Supply has Shut Down**

If the power supply is not working, it requires repair or replacement. There is no user-replaceable power supply fuse. Refer to the service guide for instructions.

• **Incorrect List Sweep Dwell Time?**

If the signal generator does not dwell for the correct period of time at each sweep list point, first check the sweep list dwell values for accuracy. Press **Sweep/List**, **Configure List Sweep** and the sweep list values will be displayed. Edit the dwell values if they are incorrect.

If the list dwell values are correct, check to see if the **Dwell Type List Step** softkey is set to **Step**. When **Step** is selected, the signal generator will sweep the list points using the dwell time set for step sweep rather than the sweep list dwell values. To view the step sweep dwell time, press **Configure Step Sweep** and observe the value set for the **Step Dwell** softkey.

• **Can't Turn Off Help Mode?**

There are two help modes (single and continuous) available on the signal generator. In single mode (the factory preset condition) when you press the **Help** key, help text is provided for your next key press. Now press any key and you will exit the help function and the function of the key you pressed is also executed. When you are in continuous help mode, when you press the **Help** key, help text is provided for your next key press and that key's function is also executed (except for the **Preset** key). You will stay in this help mode until you press the **Help** key again. To change from continuous to single mode, press **Utility**, **Instrument Info/Help Mode** and toggle the **Help Mode Single Cont** softkey to **Single**.

• **LF OUTPUT Signal is a Sinewave but the RF OUTPUT Signal is a Pulse Squarewave?**

The LF OUTPUT connector will output a signal where the frequency and shape is set by the internal source as it is being used by a modulation. However, if you are generating a pulse squarewave, the LF OUTPUT signal is correctly output as a sinewave. That sinewave is later squared by the modulator to generate the pulse modulation.

Error Messages

If an error condition occurs in the signal generator, it will always be reported to both the front panel display error queue and the SCPI (remote interface) error queue. These two queues are viewed and managed separately.

The Front Panel Error Queue

This queue is designed in a circular (rotating) fashion. It can hold up to 30 error messages. If the queue is full, and additional error messages arrive, the oldest errors are lost. The previously read messages are not cleared from the queue; they remain in the queue until they are overwritten by a new error message.

The front panel error queue information can be accessed by pressing **Utility, Error Info**. From the Error Info menu, you may choose from **View Previous Error Message, View Next Error Message, or Clear Error Queue(s)**. You can also use the RPG and the arrow keys to review the messages/

If there are any unviewed messages in the front panel error queue, the **ERR** annunciator will be activated on the signal generator's display. you can optionally rotate the RPG or use the arrow keys to view the error messages. To empty the queue, press **Utility, Error Info, Clear Error Queue(s)**.

There are some special error types called permanent errors. These include **unlock, ovencold, hi/lo**, etc. Permanent errors remain in the error queues until the error condition is cleared. Pressing **Utility, Error Info, Clear Error Queue(s)** will empty the front panel error queue, but the permanent errors will be re-reported if the error condition(s) still exist.

The SCPI Remote Interface Error Queue

This queue is constructed in a linear first-in/first-out fashion. It can hold up to 30 error messages. As errors and events are detected, they are placed in the queue. Unlike the front panel error queue, errors in this queue are not overwritten by the latest incoming error messages. If the queue overflows, the last error in the queue is replaced with the error:

-350,Queue overflow

When the queue overflows, the least recent errors remain in the queue, and the most recent error is discarded. Reading an error from the head of the queue removes that error from the queue, and opens a position in the tail of the queue for a new error, if one is subsequently detected.

When all the errors have been read from the queue, further error queries will return:

0,No error

The SCPI query **SYSTem:ERRor?** is used to view messages in the SCPI error queue. The error queue will be cleared when any of the following occur (IEEE 488.2, section 11.4.3.4):

- upon power up
- upon receipt of a ***CLS** command
- upon reading the last item from the queue

In the SCPI error queue, the permanent errors are re-reported after the message **0 , No error** is read using the **SYSTem:ERRor?** query and after the ***CLS** command is executed.

Querying the Error Queue

The queue query message is a request for the next entry from the instrument's error queue. This queue contains an integer that can range from -32768 to 32767. Negative error numbers are reserved by the SCPI standard and are defined in this section. Positive error numbers are instrument-dependent. An error value of zero indicates that no error or event has occurred.

The signal generator responds to the **SYSTEM:ERROR?** (or **STATUS:QUEUE?**) query using the following form:

<error number>, <error description>

The <error number> is a unique error descriptor. Certain standard error numbers are described in this section. The <error description> is a short description of the error, (optionally) followed by additional information regarding the error. Short descriptions of the standard error numbers are described in this section. The information that follows the error message may contain corrective actions that should be followed to correct the error condition.

The <device-dependent info> section of the response may contain information which will allow you to determine the exact error and context. For example:

```
-131, Invalid suffix;FREQUENCY:CENT 2.0E+5 dBmV
```

The maximum string length of <error description> plus <device-dependent info> is 255 characters. The <error description> will be sent exactly as indicated in this document, including case.

If there has been no error, that is, if the queue is empty, the signal generator will respond with:

```
0, No error
```

If there has been more than one error, the instrument will respond with the first one in its queue. Subsequent responses to **SYSTEM:ERROR?** will continue with the queue until it is empty.

Error Numbers

The system-defined error numbers are chosen on an enumerated (“1 of N”) basis. The SCPI-defined error numbers and the <error_description> portions of the error query response are listed here. The first error described in each class (for example, -100, -200, -300, -400) is a “generic” error. In selecting the proper error number to report, more specific error codes are preferred.

No Error

This message indicates that the error queue contains no errors.

Error Number Error Description [description/explanation/examples]

0 **No error**

The queue is empty. Every error in the queue has been read or the queue was purposely cleared by power-on or *CLS.

SCPI Standard Error Messages

Error Message Description

The list of error messages in this chapter describes all of the SCPI error messages associated with signal generator operation. A sample error message description is provided below to help you understand how information will be presented in this section.

-222 **Data out of range;value clipped to lower limit.**

Indicates that the user has entered a deviation, depth or internal source frequency that is beyond the specified limits.

The following list explains each element of the sample error message listing shown above.

- SCPI Error Number - The standard SCPI error number (-222 in this example). Standard SCPI error numbers are always negative, with the exception of **0, No error**.
- SCPI Error Message - The SCPI error message is **Data out of range;** in this example.
- Detailed Description - The information that appears after the semicolon (**;**) provides more detail as to the exact nature of the error. In this example, **value clipped to lower limit** tells you that you have entered a value outside the allowable range and the signal generator has changed the value so that it falls within the allowable limits. If no detailed description exists, it will be omitted from the error message.
- Explanation/Action Required - The text that appears below each error message listing contains an explanation of the error message and, in some cases, corrective actions that should be followed in order to correct the error condition. Though this information is not shown on the signal generator's display, it can be found in the following section.

Command Error

An error number in the range [-199 to -100] indicates that an IEEE 488.2 syntax error has been detected by the instrument's parser. The occurrence of any error in this class will cause the command error bit (bit 5) in the event status register (IEEE 488.2, section 11.5.1) to be set. If this bit is set, one of the following events has occurred:

- An IEEE 488.2 syntax error has been detected by the parser. That is, a control-to-device message was received which is in violation of the IEEE 488.2 standard. Possible violations include a data element which violates device listening formats or whose type is unacceptable to the device.
- An unrecognized header was received. Unrecognized headers include incorrect device-specific headers and incorrect or unimplemented IEEE 488.2 common commands.

Events that generate command errors will not generate execution errors, device-specific errors, or query errors; see the error definitions in this chapter.

Command Error Message Descriptions

This section lists the signal generator's command error messages and their associated descriptions.

Error Number	Error Description [description/explanation/examples]
-100	<p>Command error</p> <p>This is a generic syntax error for devices that cannot detect more specific errors. The code indicates only that a command error as defined in IEE 488.2, 11.5.1.1.4 has occurred.</p>
-101	<p>Invalid character</p> <p>A syntactic command contains a character which is invalid for that type. For example, a header containing an ampersand, SETUP&. This error might be used in place of error numbers -114, -121, -141 and some others.</p>
-102	<p>Syntax error</p> <p>An unrecognized command or data type was encountered. For example, a string was received when the device does not accept strings.</p>

- 103** **Invalid separator**
- The parser was expecting a separator and encountered an illegal character. For example, the semicolon was omitted after a program message unit.
- 104** **Data type error**
- The parser recognized a data element that is not allowed. For example, numeric or string data was expected, but block data was encountered.
- 105** **GET not allowed**
- A Group Execute Trigger was received within a program message (see IEEE 488.2, 7.7). Correct the HP-IB controller program so that the **GET** does not occur within a line of HP-IB program code.
- 108** **Parameter not allowed**
- More parameters were received than expected for the header. For example, the ***ESE** common command only accepts one parameter, so receiving ***ESE 0,1** is not allowed.
- 109** **Missing parameter**
- Fewer parameters were received than required for the header. For example, the ***ESE** common command requires one parameter, so receiving ***ESE** is not allowed.
- 110** **Command header error**
- An error was detected in the header. This message is used when the device cannot detect the more specific errors described for errors -111 through -119.
- 111** **Header separator error**
- A character which is not a legal header separator was encountered while parsing the header.
- 112** **Program mnemonic too long**
- The header contains more than twelve characters (see IEEE 488.2, 7.6.1.4.1).

- 113** **Undefined header**
- The header is syntactically correct, but it is undefined for this specific device. For example, *XYZ is not defined for any device.
- 114** **Header suffix out of range**
- The value of a header suffix attached to a program mnemonic makes the header invalid.
- 120** **Numeric data error**
- This error, as well as errors -121 through -129, are generated when parsing a data element which appears to be numeric, including non-decimal numeric types. This particular error message is used if the device cannot detect a more specific error.
- 121** **Invalid character in number**
- An invalid character for the data type being parsed was encountered. For example, an alpha in a decimal numeric or a “9” in octal data.
- 123** **Exponent too large**
- The magnitude of an exponent was greater than 32000 (see IEEE 488.2, 7.7.2.4.1).
- 124** **Too many digits**
- The mantissa of a decimal-numeric data element contained more than 255 digits excluding leading zeros (see IEEE 488.2, 7.7.2.4.1).
- 128** **Numeric data not allowed**
- A legal numeric data element was received, but the device does not accept one in this position for the header.
- 130** **Suffix error**
- This error, as well as errors -131 through -139, are generated when parsing a suffix. This particular error message is used if the device cannot detect a more specific error.

- 131** **Invalid suffix**
The suffix does not follow the syntax described in IEEE 488.2, 7.7.3.2, or the suffix is inappropriate for this device.
- 134** **Suffix too long**
The suffix contained more than twelve characters (see IEEE 488.2, 7.7.3.4).
- 138** **Suffix not allowed**
A suffix was encountered after a numeric element which does not allow suffixes.
- 140** **Character data error**
This error, as well as errors -141 through -149, are generated when parsing a character data element. This particular error message is used if the device cannot detect a more specific error.
- 141** **Invalid character data**
Either the character data element contains an invalid character or the particular element received is not valid for the header.
- 144** **Character data too long**
The character data element contains more than twelve characters (see IEEE 488.2, 7.7.1.4).
- 148** **Character data not allowed**
A legal character data element was encountered where prohibited by the device.
- 150** **String data error**
This error, as well as errors -151 through -159, are generated when parsing a string data element. This particular error message is used if the device cannot detect a more specific error.
- 151** **Invalid string data**
A string data element was expected, but was invalid (see IEEE 488.2, 7.7.5.2). For example, an **END** message was received before the terminal quote character.

- 158** **String data not allowed**
- A string data element was encountered, but not allowed by the device at this point in the parsing.
- 160** **Block data error**
- This error, as well as errors -161 through -169, are generated when parsing a block data element. This particular error message is used if the device cannot detect a more specific error.
- 161** **Invalid block data**
- A block data element was expected, but was invalid (see IEEE 488.2, 7.7.6.2). For example, an **END** message was received before the end length was satisfied.
- 168** **Block data not allowed**
- A legal block data element was encountered, but not allowed by the device at this point in the parsing.
- 170** **Expression data error**
- This error, as well as errors -171 through -179, are generated when parsing an expression data element. This particular error message is used if the device cannot detect a more specific error.
- 171** **Invalid expression**
- The expression data element was invalid (see IEEE 488.2, 7.7.7.2). For example, unmatched parentheses or an illegal character.
- 178** **Expression data not allowed**
- A legal expression data was encountered, but was not allowed by the device at this point in parsing.
- 180** **Macro error**
- This error, as well as errors -181 through -189, are generated when defining a macro or executing a macro. This particular error message is used if the device cannot detect a more specific error.

- 181** **Invalid outside macro definition**
Indicates that a macro parameter placeholder (**\$<number>**) was encountered outside of a macro definition.
- 183** **Invalid inside macro definition**
Indicates that the program message unit sequence, sent with a ***DDT** or a ***DMC** command, is syntactically invalid (see IEEE 488.2, 10.7.6.3).
- 184** **Macro parameter error**
Indicates that a command inside the macro definition had the wrong number or type of parameters.

Execution Error

An error number in the range [-299 to -200] indicates that an error has been detected by the instrument's execution control block. The occurrence of any error in this class will cause the execution error bit (bit 4) in the event status register (IEEE 488.2, section 11.5.1) to be set. If this bit is set, one of the following events has occurred:

- A <PROGRAM DATA> element following a header was evaluated by the device as outside of its legal input range or is otherwise inconsistent with the device's capabilities.
- A valid program message could not be properly executed due to some device condition.

Execution errors will be reported by the device after rounding and expression evaluation operations have been completed. Rounding a numeric data element, for example, will not be reported as an execution error. Events that generate execution errors will not generate command errors, device-specific errors, or query errors; see the error definitions in this chapter.

Execution Error Message Descriptions

This section lists the signal generator's execution error messages and their associated descriptions.

Error Number Error Description [description/explanation/examples]

-200

Execution Error

This is a generic syntax error for devices that cannot detect more specific errors. The code indicates only that an execution error as defined in IEEE 488.2, 11.5.1.1.5 has occurred.

-201

Invalid while in local

Indicates that a command is not executable while the device is in local mode due to a hard local control (see IEEE 488.2, 5.6.1.5). For example, a device with a rotary switch receives a message which would change the switch's state, but the device is in local so the message cannot be executed.

- 202** **Settings lost due to rtl**
- Indicates that a setting associated with a hard local control (see IEEE 488.2, 5.6.15) was lost when the device changed to LOCS from REMS or to LWLS from RWLS.
- 210** **Trigger error**
- Indicates that a **GET**, ***TRG**, or a triggering signal could not be executed due to an error.
- 211** **Trigger ignored**
- Indicates that a **GET**, ***TRG**, or triggering signal was received and recognized by the device, but was ignored because of device timing considerations. For example, the device was not ready to respond.
- 212** **Arm ignored**
- Indicates that an arming signal was received and recognized by the device but was ignored.
- 213** **Init ignored**
- Indicates that a request for a measurement initiation was ignored as another measurement was already in progress.
- 214** **Trigger deadlock**
- Indicates that a trigger source for the initiation of a measurement is set to **GET** and a subsequent measurement query is received. The measurement cannot begin until a **GET** is received, but the **GET** would cause an INTERRUPTED error.
- 215** **Arm deadlock**
- Indicates that the arm source for the initiation of a measurement is set to **GET** and a subsequent measurement query is received. The measurement cannot begin until a **GET** is received, but the **GET** would cause an INTERRUPTED error.
- 220** **Parameter error**
- Indicates that a program data element related error has occurred. This particular error message is used if the device cannot detect a more specific errors described for errors -221 through -229.

- 221** **Settings conflict**
Indicates that a legal program data element was parsed but could not be executed due to the current device state (see IEEE 488.2 11.5.1.1.5).
- 222** **Data out of range**
Indicates that a legal program data element was parsed but could not be executed because the interpreted value was outside the legal range defined by the device (see IEEE 488.2 11.5.1.1.5).
- 223** **Too much data**
Indicates that a legal program data element of block, expression or string type was received that contained more data than the device could handle due to memory or related device-specific requirements.
- 224** **Illegal parameter value**
Used where exact value, from a list of possibilities, was expected.
- 225** **Out of memory**
The device has insufficient memory to perform the requested operation.
- 226** **Lists not same length**
Attempted to use LIST structure having individual LISTS of unequal length.
- 230** **Data corrupt or stale**
Possibly invalid data. A new reading was started but not completed since last access.
- 231** **Data questionable**
Indicates that the measurement accuracy is questionable.

- 232** **Invalid format**
- Indicates that a legal program data element was parsed but could not be executed because the data format or structure is inappropriate. For example, when loading memory tables or when sending a **SYSTEM:SET** parameter for an unknown instrument.
- 233** **Invalid version**
- Indicates that a legal program data element was parsed but could not be executed because the version of the data is incorrect to the device. This particular error is used when file or block data elements are recognized by the instrument, but cannot be executed for reasons of version incompatibility. For example, a non- supported file version or a non- supported instrument version.
- 240** **Hardware error**
- Indicates that a legal program command or query could not be executed because of a hardware problem in the device. The definition of what constitutes a hardware problem is completely device-specific. This error is used when the device cannot detect the more specific errors described for errors -241 through -249.
- 241** **Hardware missing**
- Indicates that a legal program command or query could not be executed because of missing device hardware. For example, an option was not installed.
- 250** **Mass storage error**
- Indicates that a mass storage error has occurred. This message is used when a device cannot detect the more specific errors described for errors -251 through -259.
- 252** **Missing media**
- Indicates that a legal program command or query could not be executed because of missing media, for instance no disk in the disk drive. The definition of what constitutes missing media is device-specific.

- 253** **Corrupt media**
- Indicates that a legal program command or query could not be executed because of corrupt media, for instance a bad disk or incorrect disk format. The definition of what constitutes corrupt media is device-specific.
- 254** **Media full**
- Indicates that a legal program command or query could not be executed because the media was full. For example, there is was no space left on the disk. The definition of what constitutes full media is device-specific.
- 255** **Directory full**
- Indicates that a legal program command or query could not be executed because the media directory was full. The definition of what constitutes a full media directory is device-specific.
- 256** **File name not found**
- Indicates that a legal program command or query could not be executed because the file name on the device media could not be found. For example, an attempt was made to read or copy a nonexistent file. The definition of what constitutes a file not being found is device-specific.
- 257** **File name error**
- Indicates that a legal program command or query could not be executed because a file name on the device media was in error. For example, an attempt was made to copy to a duplicate filename. The definition of what constitutes a file name error is device-specific.
- 258** **Media protected**
- Indicates that the device or user has attempted to write to a read-only memory subsystem (msus). The definition of a protected media is device-specific.
- 260** **Expression error**
- Indicates that an expression data element-related error occurred. This error message is used when the device cannot detect the more specific errors described for errors -261 through -269.

- 261** **Math error in expression**
- Indicates that a syntactically legal expression program data element could not be executed due to a math error. For example, a divide-by-zero was attempted. The definition of a math error is device-specific.
- 270** **Macro error**
- Indicates that a macro-related execution error occurred. This error message is used when the device cannot detect the more specific errors described for errors -271 through -279.
- 271** **Macro syntax error**
- Indicates that a syntactically legal macro program data sequence, written in accordance with IEEE 488.2, 10.7.2, could not be executed due to a syntax error within the macro definition (see IEEE 488.2, 10.7.6.3).
- 272** **Macro execution error**
- Indicates that a syntactically legal macro program data sequence could not be executed due to an error within the macro definition (see IEEE 488.2, 10.7.6.3).
- 273** **Illegal macro label**
- Indicates that the macro label defined in the ***DMC** command was a legal string syntax, but could not be accepted by the device (see IEEE 488.2, 10.7.3 and 10.7.6.2). For example, the label was too long, the same as a common command header, or contained invalid header syntax.
- 274** **Macro parameter error**
- Indicates that the macro definition improperly used a macro parameter placeholder (see IEEE 488.2, 10.7.3).
- 275** **Macro definition too long**
- Indicates that a syntactically legal macro program data sequence could not be executed because the string or block contents were too long for the device to handle (see IEEE 488.2, 10.7.6.1).

- 276 Macro recursion error**
Indicates that a syntactically legal macro program data sequence could not be executed because the device found it to be recursive (see IEEE 488.2, 10.7.6.4).
- 277 Macro redefinition not allowed**
Indicates that the macro label defined in the ***DMC** command could not be executed because the macro label was already defined (see IEEE 488.2, 10.7.6.4).
- 278 Macro header not found**
Indicates that a syntactically legal macro label in the ***GMC?** query could not be executed because the header was not previously defined.
- 280 Program error**
Indicates that a downloaded program-related execution error occurred. This error message is used when the device cannot detect the more specific errors described for errors -281 through -289. The syntax used in a program and the mechanism for downloading a program is device-specific.
- 281 Cannot create program**
Indicates that an attempt to create a program was unsuccessful. This may be due to insufficient memory.
- 282 Illegal program name**
Indicates that the name used to reference a program was invalid. For example, redefining an existing program, deleting a nonexistent program, or in general, referencing a nonexistent program.
- 283 Illegal variable name**
Indicates that an attempt was made to reference a nonexistent variable.
- 284 Program currently running**
Indicates that certain operation related to programs may be illegal while the program is running. For example, deleting a running program may be illegal.

- 285** **Program syntax error**
- Indicates that a syntax error appears within a downloaded program. The syntax used when parsing a downloaded program is device-specific.
- 286** **Program runtime error**
- Indicates that a runtime error was detected in a downloaded program.
- 290** **Memory use error**
- Indicates that a user request has directly or indirectly caused an error related to memory or <data_handles>. This is not the same as “bad” memory.
- 291** **Out of memory**
- A downloaded program required more memory than was available in the instrument.
- 292** **Referenced name does not exist**
- A downloaded program attempted to access an undefined element (a variable, constant, filename, etc.).
- 293** **Referenced name already exists**
- A downloaded program attempted to define an element (a variable, constant, filename, etc.) that had already been defined.
- 294** **Incompatible type**
- Indicates that the type or structure of a memory item is inadequate.

Device-Specific Error

An error number in the range [-399 to -300] or [1 to 32767] indicates that the instrument has detected an error which is not a command error, a query error, or an execution error; some device operations did not properly complete, possibly due to an abnormal hardware or firmware condition. These codes are also used for self-test response errors. The occurrence of any error in this class will cause the device-specific error bit (bit 3) in the event status register (IEEE 488.2, section 11.5.1) to be set.

NOTE:

For positive error number descriptions see the section titled “ESG Series Signal Generator Instrument-Specific Error Messages.”

The meaning of positive error codes is device-dependent and may be enumerated or bit mapped. The <error_message> string for positive error codes is not defined by SCPI. The occurrence of any error in this class will cause the device-specific error bit (bit 3) in the event status register (IEEE 488.2, section 11.5.1) to be set. Events that generate device-specific errors will not generate command errors, or query errors; see the other error definitions in this section.

Device-Specific Error Message Descriptions

This section lists the signal generator’s device-specific error messages and their associated descriptions.

Error Number	Error Description [description/explanation/examples]
-300	Device-specific error This is a generic device-dependent error for devices that cannot detect more specific errors. The code indicates only that a device-dependent error as defined in IEEE 488.2, 11.5.1.1.6 has occurred.
-310	System error Indicates that an error, termed “system error” by the device, has occurred.
-311	Memory error Indicates that an error was detected in the device’s memory.

- 312** **PUD memory lost**
Indicates that the protected user data saved by the ***PUD** command has been lost.
- 313** **Calibration memory lost**
Indicates that non-volatile calibration data has been lost.
- 314** **Save/recall memory loss**
Indicates that the non-volatile data saved by the ***SAV?** command has been lost.
- 315** **Configuration memory lost**
Indicates that non-volatile configuration data saved by the device has been lost. The meaning of this error is device-dependent.
- 320** **Storage fault**
Indicates that the firmware detected a fault when using data storage. This error is not an indication of physical damage or failure of any mass storage element.
- 321** **Out of memory**
Indicates that an internal operation needed more memory than was available.
- 330** **Self-test failed**
Indicates that the device has detected a failure during its self-test procedure.
- 340** **Calibration failed**
Indicates that the device has detected a failure during its calibration procedure.
- 350** **Queue overflow**
This is a specific code entered into the queue in lieu of the code that caused the error. This message indicates that there is no more room in the queue and an error occurred but was not recorded.

-360

Communication error

This is the generic communication error for devices that cannot detect the more specific errors described for errors -361 through -363.

-361

Parity error in program message

Indicates that the parity bit was not correct when data was received (for example, an incorrect parity bit on a serial port).

-362

Framing error in program message

Indicates that a stop bit was not detected when data was received (for example, a baud rate mismatch).

Query Error

An error number in the range [-499 to -400] indicates that the output queue control of the instrument has detected a problem with the message exchange protocol described in IEEE 488.2, chapter 6. The occurrence of any error in this class will cause the query error bit (bit 2) to be set in the event status register (IEEE 488.2, section 11.5.1). These errors correspond to message exchange protocol errors described in IEEE 488.2, 6.5. If a query error occurs one of the following is true:

- An attempt is being made to read data from the output queue when no output is either present or pending.
- Data in the output queue has been lost.

Events that generate query errors will not generate command errors, execution errors, or device-specific errors; see the other error definitions in this section.

Query Error Message Descriptions

This section lists the signal generator's query error messages and their associated descriptions.

Error Number	Error Description [description/explanation/examples]
-400	Query Error This is a generic query error for devices that cannot detect more specific errors. The code indicates only that a query error as defined in IEE 488.2, 11.5.1.1.7 and 6.3 has occurred.
-410	Query INTERRUPTED Indicates that a condition causing an INTERRUPTED query error occurred (see IEEE 488.2, 6.3.2.7). For example, a query was followed by DAB or GET before a response was completely sent.
-420	Query UNTERMINATED Indicates that a condition causing an UNTERMINATED query error occurred (see IEEE 488.2, 6.3.2.2). For example, the device was addressed to talk and an incomplete program message was received.
-430	Query DEADLOCKED

Indicates that a condition causing a DEADLOCKED query error occurred (see IEEE 488.2, 6.3.1.7). For example, both the input buffer and the output buffer are full and the device cannot continue.

-440

Query UNTERMINATED after indefinite response

Indicates that a query was received in the same program message after a query requesting an indefinite response was executed (see IEEE 488.2, 6.3.7.5).

ESG Series Signal Generator Instrument-Specific Error Messages

Some instrument-specific error messages incorporate the negative or “generic” SCPI error number with the addition of device-dependent/instrument-specific (ESG Series signal generator-specific) information following the semicolon in the error message.

A positive error number indicates that the instrument has detected an error within the HP-IB system, within the instrument’s firmware or hardware, during the transfer of block data, or during calibration.

Error Number Error Description [description/explanation/examples]

-100

Command error;R0:No standby mode allowed.

Indicates that, in HP 8656/57 compatibility mode, **R0** was received via HP-IB. This command is not supported by the compatibility mode.

Command error;Remote active function DN/UP not available.

Indicates that, in HP 8656/57 compatibility mode, either **DN** or **UP** was received via HP-IB. These commands are not supported by the compatibility mode.

Command error;LO: No low bandwidth ALC mode allowed.

Indicates that, in HP 8656/57 compatibility mode, **LO** was received via HP-IB. This command is not supported by the compatibility mode.

-102

Syntax error;Bad HP compatibility language character <character>.

Indicates that, in HP 8656/57 compatibility mode, illegal language input was received.

Syntax error;Bad HP compatibility language token <token>.

Indicates that, in HP 8656/57 compatibility mode, a known command or termination specifier was received when it was not expected. For example, a termination specifier was received with no currently active function.

-213

Init ignored;Unable to sweep due to sweep being in an error state. The sweep error should be fixed.

Indicates that the number of list, power, and/or dwell points are in conflict, or a serious system error has occurred in list/sweep. A previous error report should have described the error that is stalling list/sweep.

Init ignored;Cannot initiate sweep in manual mode.

Indicates that the manual mode is on and therefore the instrument cannot sweep.

Init ignored;Sweep is already initiated.

Indicates that the list/sweep is currently initiated and sweeping, therefore the command is not legal according to SCPI.

Init ignored;Sweep is already continuously initiated.

Indicates that the list/sweep is continuously initiated and sweeping, therefore the command is not legal according to SCPI.

-221

Settings conflict;Frequency list and dwell list are of unequal size. Set one list equal to size one, or make their sizes equal.

Indicates that the frequency list has more than one element and the dwell list has more than one element, and they are not of equal size. If any of the frequency, power, or dwell lists have more than one element, they must all have the same number of elements. A list of a single element is the same as a list of equal size with the single element repeated the necessary number of times.

Settings conflict;Frequency list and power list are of unequal size. Turn one list off, set one to size one, or make their sizes equal.

Indicates that the frequency list has more than one element and the power list has more than one element, and they are not of equal size. If any of the frequency, power, or dwell lists have more than one element, they must all have the same number of elements. A list of a single element is the same as a list of equal size with the single element repeated the necessary number of times.

Settings conflict;Power list and dwell list are of unequal size. Set one to size one, or make their sizes equal.

Indicates that the dwell list has more than one element and the power list has more than one element, and they are not of equal size. If any of the frequency, power, or dwell lists have more than one element, they must all have the same number of elements. A list of a single element is the same as a list of equal size with the single element repeated the necessary number of times.

Settings conflict;The selected external trigger setting conflicts with the previous setting.

Indicates that the external trigger has been set to positive edge for one trigger source and negative edge for another trigger source.

Settings conflict;FM2/PM2 value set greater than FM1/PM1 value. FM1/PM1 changed to match FM2/PM2 value.

The deviation of FM2/PM2 must always be less than or equal to the deviation settings for FM1/PM1. This error will be reported to the queue when FM1/PM1 is enabled and FM2/PM2 is also enabled and an adjustment to either FM2/PM2 deviation causes the FM2 or PM2 deviation to be greater than the FM1 or PM1 deviation. It will also be reported when FM2/PM2 is being turned on, and the last FM1/PM1 deviation setting is less than the current FM2/PM2 deviation setting. In both cases the FM1/PM1 deviation will be adjusted to match the FM2/PM2 deviation.

Settings conflict;FM1/PM1 value set less than FM2/PM2 value. FM2/PM2 changed to match FM1/PM1 value.

The deviation of FM2/PM2 must always be less than or equal to the deviation settings for FM1/PM1. This error will be reported to the queue when FM2/PM2 is enabled and FM1/PM1 is also enabled and an adjustment to either FM1/PM1 deviation causes the FM1 or PM1 deviation to be less than the FM2 or PM2 deviation. It will also be reported when FM1/PM1 is being turned on, and the last FM2/PM2 deviation setting is greater than the current FM1/PM1 deviation setting. In both cases the FM2/PM2 deviation will be adjusted to match the FM1/PM1 deviation.

Settings conflict;Enabled mod source conflicts with previously enabled mod source. Previous mod disabled.

The signal generator has three sources: INT, EXT1, and EXT2 that are shared by the FM1/PM1, AM1/AM2, FM2/PM2, pulse (INT and EXT2), and burst envelope (EXT1 only). Each source can only be used by one of the modulations at a time. If a source is being used by an active modulation, and a request for the source is made by another modulation, the first modulation will be turned off, the second modulation will be turned on.

Settings conflict;FM & PM not allowed.

Indicates that there is a hardware conflict between FM and PM. The most recently requested modulation will be turned on, the previous modulation will be turned off.

Settings conflict;Pattern repeat is changed to continuous because data source is external.

Indicates that, while in non-bursted data generation, Pattern Repeat was in Single mode and data source was selected to be External. For non-bursted data generation using an external data source, Pattern Repeat must be in Continuous mode. To continue data transmission, Pattern repeat has been changed to Continuous mode.

-222

Data out of range;value clipped to lower limit.

Indicates that an input value is below the minimum value allowed. Examples are: frequency setting, reference, or offset; output power; power reference and offset; modulation depth, deviation, or modulation source frequency; number of points and start/stop values for list mode; sequence or register values (save/recall); dwell time.

Data out of range;value clipped to upper limit.

Indicates that an input value is above the maximum value allowed. Examples are: frequency setting, reference, or offset; output power; power reference and offset; modulation depth, deviation, or modulation source frequency; number of points and start/stop values for list mode; sequence or register values (save/recall); dwell time.

Data out of range;Synthesizer: Frequency out of bounds.

Indicates that the instrument received an internal request for a frequency outside of its supported frequency range. Report the circumstances to the factory.

Data out of range;Manual point exceeds list sizes. Limiting to maximum point.

Indicates that the sweep/list manual point has been reassigned to a smaller number value due to the longest list decreasing in size or being turned off. Its new value is the length of the longest enabled list (frequency or power).

Data out of range;Manual point exceeds frequency list size. Limiting to maximum point.

Indicates that the sweep/list manual point has been reassigned to a smaller number value due to the longest list decreasing in size or being turned off. Its new value is the length of the frequency list which is the longest enabled list.

Data out of range;Manual point exceeds power list size. Limiting to maximum point.

Indicates that the sweep/list manual point has been reassigned to a smaller number value due to the longest list shrinking, or being turned off. Its new value is the length of the power list, which is the longest enabled list.

-223 Too Much Data;The number of list points exceeds the maximum allowed.

Indicates that a SCPI list has been entered that is longer than the maximum allowed length, which is also the maximum number of step points; too many points were given for a frequency, amplitude, or dwell time list. This error can also be caused by attempting to copy items in the list editor when the list is already at its maximum length.

-230 Data corrupt or stale;RAM copy of <filename>.

The non-volatile RAM copy of a file is either corrupt or is out of date with the EEPROM master copy (if one exists). The system automatically re-initializes the file from EEPROM (if appropriate) or from a default algorithm. A potential cause is a failing backup battery.

**Data corrupt or stale;EEPROM copy of
<filename>.**

The EEPROM copy of a file is either corrupt or otherwise unusable. The system automatically updates the non-volatile RAM copy of the EEPROM copy using a default initialization. The actual EEPROM file is left as it is. Report this problem to the factory.

-231

Data questionable;RAM copy of <filename>.

Indicates that the non-volatile RAM copy of a file has a correctable error. The system automatically performs the correction. A potential cause is a failing backup battery.

Data questionable;EEPROM copy of <filename>.

Indicates that the EEPROM copy of a file has a correctable error. The system automatically performs the correction. A potential cause is a failing EEPROM. Report this problem to the factory.

-241

Hardware missing; <card_name>

Indicates that a test communication to a hardware card failed. The instrument is most likely not functional. Contact the nearest HP Sales and Service office.

Hardware missing; Installed option boards do not match configuration information.

Indicates that a set of option boards have been installed that do not match the information that was given to the instrument as part of the installation. If this is the result of a customer installed option, the wrong option was specified during installation. If this is seen at any other time, the likely cause is an EEPROM failure on the option card.

- 250** **Mass storage error; EEPROM write timeout on <filename>.**
- Indicates that the system was not able to program new data to an EEPROM. The system is still functional, but files written to EEPROM (such as updated calibration data) may be lost when the instrument's line power is cycled. Contact the nearest HP Sales and Service office.
- 253** **Corrupt media;User File System**
- Indicates that the main memory area used for storing instrument states and sequences as well as other data files is corrupt. The system will automatically clear and reconfigure this memory area. A potential cause is a failing backup battery. Another potential cause could be the loss of line power to the instrument in the middle of a write operation.
- Corrupt media;<media_name>**
- Indicates that a source media (possibly EEPROM) for a data file is corrupt. This error is usually seen in conjunction with errors concerning a certain file.
- 254** **Media full; Unable to delete saved state from non-volatile memory. No instrument state change.**
- Indicates that the state memory subsystem **STATE:** was unable to delete a register. You must free some memory by deleting a file or register using Catalog. Afterwards, try again.
- Media full; Save a state register ignored.**
- Indicates that the state memory subsystem **STATE:** did not have enough room to save a register. You must free some memory by deleting a file or register using Catalog. Afterwards, try again.
- Media full; Save a state register failed. State marked available.**
- Indicates that the state memory subsystem **STATE:** did not have enough room to save a register, so the register was lost and is now marked available. You must free some memory by deleting a file or register using Catalog. Afterwards, try again.

- 256** **File name not found;The internal list file was not found. There is no list data to return**
- Indicates that the **DWEL_FILE**, **FREQ_FILE**, or **POW_FILE** has been lost, so a new one will have to be created. These files are the persistent information for list/sweep mode. They contain the dwell list, the frequency list, or the power list. Invoking the list editor will recreate the missing file to a length of one element.
- 257** **File name error;Delete empty sequence <sequence_name>. Delete sequence ignored.**
- Indicates that the user has attempted to delete a sequence which is empty (all registers unused). This is informational only. Typically this error is reported (several times) when the “Delete All Sequences” command is executed.
- File name error;Delete a non-saved state register. Delete register ignored.**
- Indicates that the user has attempted to delete a state which is empty (unused). This is informational only.
- File name error;Directory does not support extenders.**
- Indicates that an extender, which is specified by an @ sign followed by a memory subsystem name, has been specified for an explicit memory subsystem which does not allow the @ notation. Only the default (:) memory subsystem allows extenders.
- File name error;Empty filename**
- Indicates that a filename of “ ” was specified. This is not a legal filename.
- File name error;Illegal extender**
- Indicates that an illegal memory subsystem name was used after the @. Supported values are **@STATE** and **@LIST**.
- File name error;Illegal filename character**
- Indicates that an illegal character was used within a filename. \, :, @ and all non-printable ASCII characters are illegal in filenames.

File name error;Only one ":" is allowed.

Indicates that only one colon is allowed in any filename specification. The text before the colon is a user memory subsystem. The valid user choices are :, **DEFAULT:**, **STATE:**, and **LIST:**.

File name error;Only one "@" is allowed.

Indicates that only one @ is allowed in any filename specification. It specifies the memory subsystem that a user file actually resides in.

-286

Program runtime error;Floating-Point Exception

Indicates that a floating-point math error (such as a divide by zero) has been detected. The system will attempt to recover automatically. Report the circumstances to the nearest HP Sales and Service office.

-310

System error;RS232 buffer overflow: character lost.

Indicates that the RS232 buffer has been exceeded. The most recent character has been dropped.

System error;Cannot change manual point until list mode error condition cleared.

An error is keeping the sweep/list from being able to set the frequency and/or power. Until the problem is addressed, the manual point cannot be changed.

System error;Unable to determine which attenuator is installed.

Indicates that an invalid attenuator identification code has been detected. Possible causes include a loose attenuator control cable. The instrument will likely not produce the proper output power levels. Report this error to the factory.

-311

Memory error;Unable to configure Save Recall registers from non-volatile memory. Save Recall registers re-initialized.

Indicates that saved states are no longer usable. Delete explicitly using Catalog.

-315 Configuration memory lost;Persistent state preset. Using factory defaults.

Indicates that the persistent state has been forced to return to factory preset values.

Configuration memory lost;Persistent state version is bad. Using factory defaults.

Indicates that the persistent state version is not recognized as valid and is assumed to be corrupt. The persistent state is reinitialized with the factory preset values.

Configuration memory lost;Persistent state checksum is bad. Using factory defaults.

Indicates that the persistent state is corrupt and had to be reinitialized with the factory preset values.

-321 Out of memory;Unable to verify instrument state file.

Indicates that an instrument state file could not be accessed and verified because of insufficient memory. Reduce the size of any sweep lists and try again.

Out of memory;Memory catalog failed.

Indicates that there is not enough memory to complete a catalog listing. Reduce the size of any sweep lists and try again.

Out of memory;Unable to display timeslot window.

Indicates that the instrument was unable to create part of the graphical user interface due to an inability to allocate memory (possibly due to fragmentation). Please report the circumstances to the factory. The instrument is still functional.

Out of memory;Unable to display protocol window.

Indicates that the instrument was unable to create part of the graphical user interface due to an inability to allocate memory (possibly due to fragmentation). Please report the circumstances to the factory. The instrument is still functional.

Out of memory;Unable to display format window.

Indicates that the instrument was unable to create part of the graphical user interface due to an inability to allocate memory (possibly due to fragmentation). Please report the circumstances to the factory. The instrument is still functional.

Out of memory;Cannot uncompress file.

Indicates that a **STATE:** file cannot be uncompressed because there is not enough memory to run the decompression algorithm. Recall will fail and there will be no instrument state change. Reduce the size of any sweep lists and try again.

Out of memory;Cannot precalculate frequencies. Try fewer frequencies.

Indicates that memory was exhausted during frequency precalculation (used to speed the process of sweep/list mode). List mode cannot run until either fewer frequencies have been supplied or more memory becomes available and the same set of frequencies are sent again, **FREQ:MODE CW** is executed, or **:FREQ:MODE LIST** is executed.

Out of memory;Object Memory Area

Indicates that memory was exhausted during instrument power-on. Report the circumstances to the factory.

Out of memory;List formation

The device was unable to allocate space for a lookup table, such as for list mode precalculation. List mode cannot run until either fewer frequencies have been supplied or more memory becomes available and the same set of frequencies are sent again, **FREQ:MODE CW** is executed, or **:FREQ:MODE LIST** is executed.

Out of memory;Display system out of memory. An abnormal display may result. Memory consumption should be reduced.

There was not enough memory in the system to properly update the display. Some inconsistencies may be seen. The size of any list/sweep should be reduced, and the source should be preset to clear up any inconsistencies. Report the circumstances to the nearest HP Sales and Service office.

Out of memory;Unable to check Data Generator memory.

There was not enough memory in the system to properly complete the data generator memory test. This does NOT imply a data generator memory failure. Check all other error messages to identify possible causes, discontinue list/sweep mode to free some memory, and repeat the test.

-330

Self-test failed;Power supply self-test failure

Indicates that the self-test for a particular power supply voltage has failed. The instrument is likely not functional. Contact the nearest HP Sales and Service office.

Self-test failed;EEPROM header checksum error <card_name>.

Indicates that the card identification header for a hardware card is incorrect. If the card is not properly identified, the instrument is likely to be non-functional. Contact the nearest HP Sales and Service office.

Self-test failed;Data Generator Memory Test @ 0x_____

Indicates that the data generator memory failed. Modulation data produced by the data generator may not be correct. However, if an **Unable to check Data Generator Memory** error was also seen, this result is not conclusive. The address of the first location that failed is reported. Contact the nearest HP Sales and Service office.

Self-test failed;Burst Generator Memory Test @ 0x_____

Indicates that the burst generator memory failed. Modulation data produced by the burst generator may not be correct. However, if an **Unable to check Burst Generator Memory** error was also seen, this result is not conclusive. The address of the first location that failed is reported. Contact the nearest HP Sales and Service office.

Self-test failed;Bad address position @ 0x_____

Indicates that the data generator memory failed. Modulation data produced by the data generator may not be correct. An address that appeared to have a failed address line was reported. Contact the nearest HP Sales and Service office.

Self-test failed;Chips ____, ____, aliased @ 0x_____

Indicates that the data generator memory failed. Modulation data produced by the data generator may not be correct. An address that appeared to be aliased across multiple memory chips has been reported. Contact the nearest HP Sales and Service office.

-430

Query DEADLOCKED

Indicates that a SCPI output queue has filled preventing further SCPI command execution, and there is no more room left in the corresponding SCPI input queue to accept a query to read from the output queue. The system automatically discards output to correct the deadlock.

201

Bad file number;Unable to check Data Generator memory.

Indicates that the instrument was not able to generate the pattern necessary to perform the data generator memory test. This does NOT imply a data generator memory failure. Report the problem to the factory.

208

I/O error;Unable to delete saved state from non-volatile memory. No instrument state change.

Indicates that a **STATe:** file could not be deleted due to the file not being found, file corruption, or another file-related problem. If the file is displayed by a memory catalog, delete it explicitly.

I/O error;Save a state register ignored.

Indicates that a **STATe:** file could not be saved due to insufficient space, file corruption, or another related problem.

**I/O error;Delete empty sequence
<sequence_name>. Delete sequence ignored.**

Indicates that the user has attempted to delete a sequence that is empty. This error message is informational only. Typically, this error is reported several times when the “Delete All Sequences” command is executed. If the file is displayed by Catalog, delete explicitly.

**I/O error;Delete a non-saved state register.
Delete register ignored.**

Indicates that the user has attempted to delete an unused (empty) state. This error message is informational only.

**I/O error;Trailing zero found in <filename>.
Fixing...**

Indicates that a compressed state file has a zero at its end. This is a sign of file corruption. The device fixes the problem by concealing the zero such that it no longer triggers an error message. The file may be corrupt or unusable.

**I/O error;Unable to recall from non-volatile
memory. No instrument state change.**

Indicates that the state file is not readable and the recall was aborted.

**214 Not owner;Unable to delete saved state from
non-volatile memory. No instrument state
change.**

Indicates that the user has attempted to write to a read-only memory subsystem.

**501 Attenuator hold setting over range;Frequency
change forced attenuator adjust.**

Indicates that the firmware has changed the attenuator setting because, while in attenuator hold mode, a change in frequency setting has forced the ALC beyond its range.

Attenuator hold setting over range;Power set to lower limit.

Indicates that the firmware has changed the power setting to a value other than the requested value due to the fact that, while in attenuator hold mode, the user has requested a power setting that is below the ALC range for the attenuator setting. The power has been set to the lower limit.

Attenuator hold setting over range;Power set to upper limit.

Indicates that the firmware has changed the power setting to a value other than the requested value due to the fact that, while in attenuator hold mode, the user has requested a power setting that is above the ALC range for the attenuator setting.

508 Synthesizer unlocked

Indicates that the synthesizer is unlocked. Service may be needed.

509 Output Section input overdrive

Internal error: report to factory.

511 Output unlevelled

Indicates that the instrument's output is unlevelled.

512 Reference unlocked

Indicates that the instrument's reference is unlocked. If an external reference is connected, check the frequency and power. It is possible for this to occur during a poor connection/disconnection of an external reference. If this error reoccurs when no external reference is connected, the instrument may require service.

513 Het VCO unlocked

Indicates that the VCO used to generate output frequencies below 250 MHz is unlocked. The instrument may require service.

- 514** **Reference Oven cold**
- Indicates that the reference oven is not at the required operating temperature. This is normal if the instrument has been powered down for a while. If the error persists, the instrument may require service.
- 515** **Reference board: 10 Mhz reference signal bad or missing**
- Indicates that the instrument's reference is unlocked. If an external reference is connected, check the frequency and power. It is possible for this to occur during a poor connection/disconnection of an external reference. If this error reoccurs when no external reference is connected, the instrument may require service.
- 517** **Calibration failure;DCFM DC overrange**
- Indicates that the instrument was unable to perform a DCFM or DCΦM calibration due to the input signal being outside of the offset range that can be calibrated for.
- Calibration failure;Upgrade calibration failed. Data not stored.**
- Indicates that the calibration stage of the instrument upgrade was not executed successfully. The calibration data has not been stored. The upgrade is not functional. Contact the nearest HP Sales and Service office.
- 600** **RPP has tripped.**
- Indicates that the reverse power protection circuit has been triggered. Repeated tripping of this circuit can cause damage to the instrument.
- 601** **Power search failed.**
- Indicates that, while executing power search, the level meter circuit failed to return a meaningful value. This event indicates that the power is in a range that the leveling loop cannot properly level. The power will be set to the last properly leveled power.

- 605** **DSP FW download failed.**
- Indicates that the instrument's firmware was unable to successfully initialize the internal DSP. Report the circumstances to the nearest HP Sales and Service office.
- 606** **DSP times out.**
- Indicates that the DSP failed to respond within the appropriate amount of time. Report the circumstances to the nearest HP Sales and Service office.
- 607** **DSP returns error.**
- Indicates that the DSP is in an indeterminate state. Report the circumstances to the nearest HP Sales and Service office.
- 608** **DSP in use by other process.**
- Indicates that the DSP is in an indeterminate state. Report the circumstances to the nearest HP Sales and Service office.
- 615** **New wave shape changes limit for internal frequency;frequency changed to new limit.**
- When using the internal modulation source, the upper limit varies for the different waveforms. If the user changes the waveform when the internal source frequency is higher than that allowed for the new waveform, the frequency for the source will be changed, and the user informed of that change with this message.
- 617** **Configuration error; Data Generator Memory configuration does not match installed board.**
- This indicates that the memory configuration for an option board does not match the known memory limits of the board. If this error has occurred as the result of a customer-installed option, uninstall all options and then reinstall the correct options. If the error persists, contact the factory.
- Configuration error; Installed option boards do not match configuration information.**
- This indicates that the option boards have not been properly installed in the instrument. Verify that the correct option boards have been installed in the correct slots. Reinstall the correct option. If the error persists, contact the factory.

Configuration error; Invalid Data Generator memory configuration.

This indicates that the memory configuration for an option board does not match the known memory limits of any supported option board. If this error has occurred as the result of a customer-installed option, uninstall all options and then reinstall the correct options. If the error persists, contact the factory.

Configuration error; Invalid option board configuration.

This indicates that an invalid combination of option boards has been configured. If this error has occurred as the result of a customer-installed option, uninstall all options and then reinstall the correct options. If the error persists, contact the factory.

700

State Save Recall Error; Recall aborted. Unable to recall the state from non-volatile memory.

This indicates that the state file was not readable, so the recall was aborted. If state file exists, delete explicitly using the memory catalog.

State Save Recall Error; Recalled state has a bad checksum. No instrument state change.

This indicates that the state file was corrupt or out-of-date, so the recall was ignored. If state file exists, delete explicitly using the memory catalog.

State Save Recall Error; Recall data different from FW revision. No instrument state change.

Indicates that an attempt was made to recall a state that was saved with an incompatible version of the instrument firmware. This typically occurs when a state file is copied from an instrument with a newer version of firmware to an instrument with an older version of firmware. Newer versions of instrument firmware can read older state files.

State Save Recall Error;Recall non-saved state register. Recall ignored.

Indicates that a recall was attempted for a state register that is unused. If state file exists, delete explicitly using catalog.

State Save Recall Error;Delete sequence <sequence_name> ignored.

Indicates that a **STATE:** file in a sequence that is being deleted could not be deleted due to the file not being found, data corruption, etc. If state file exists, delete explicitly using the memory catalog.

State Save Recall Error;The state file is from a different firmware revision that does not support comments.

Indicates that an attempt was made to write a comment to a state file revision that does not support comments. Comments in saved state files are not supported by the A.01.00 and A.01.01 releases of the instrument firmware.

Returning Your Signal Generator to HP

If you are returning your signal generator to HP for servicing, fill out and attach a blue repair tag to the instrument. Repair tags are located at the end of this chapter.

Include as much information as possible about the problem: record any error messages that appeared on the display, and include performance test results or any other specific data on the performance of the signal generator.

Ship the instrument in the original factory packaging materials, if they are available. If not, use similar packaging to properly protect the instrument.

Return the instrument to the nearest HP sales and service office. A list of sales and service offices follows on the next page.

HP Sales and Service Offices

US FIELD OPERATIONS			
<p>Headquarters Hewlett-Packard Company 19320 Pruneridge Avenue Cupertino, CA 95014, USA (800) 752-0900</p>	<p>California, Northern Hewlett-Packard Co. 301 E. Evelyn Mountain View, CA 94041 (415) 694-2000</p>	<p>California, Southern Hewlett-Packard Co. 1421 South Manhattan Ave. Fullerton, CA 92631 (714) 999-6700</p>	<p>Colorado Hewlett-Packard Co. 24 Inverness Place, East Englewood, CO 80112 (303) 649-5512</p>
<p>Atlanta Annex Hewlett-Packard Co. 2124 Barrett Park Drive Kennesaw, GA 30144 (404) 648-0000</p>	<p>Illinois Hewlett-Packard Co. 545 E. Algonquin Rd. Arlington Heights, IL 60005 (847) 342-2000</p>	<p>New Jersey Hewlett-Packard Co. 150 Green Pond Road Rockaway, NJ 07866 (201) 586-5400</p>	<p>Texas Hewlett-Packard Co. 930 E. Campbell Rd. Richardson, TX 75081 (214) 231-6101</p>
EUROPEAN FIELD OPERATIONS			
<p>Headquarters Hewlett-Packard S.A. 150, Route du Nant-d'Avril 1217 Meyrin 2/Geneva Switzerland (41 22) 780.8111</p>	<p>France Hewlett-Packard France 1 Avenue Du Canada Zone D'Activite De Courtaboeuf F-91947 Les Ulis Cedex France (33 1) 69 82 60 60</p>	<p>Germany Hewlett-Packard GmbH Hewlett-Packard Strasse 61352 Bad Homburg v.d.H Germany (49 6172) 16-0</p>	<p>Great Britain Hewlett-Packard Ltd. Eskdale Road, Winnersh Triangle Wokingham, Berkshire RG41 5DZ England (44 734) 696622</p>
INTERCON FIELD OPERATIONS			
<p>Headquarters Hewlett-Packard Company 3495 Deer Creek Rd. Palo Alto, CA 94304-1316 (415) 857-5027</p>	<p>Australia Hewlett-Packard Australia Ltd. 31-41 Joseph Street Blackburn, Victoria 3130 (61 3) 895-2895</p>	<p>Canada Hewlett-Packard (Canada) Ltd. 17500 South Service Road Trans-Canada Highway Kirkland, Quebec H9J 2X8 Canada (514) 697-4232</p>	<p>China China Hewlett-Packard Co. 38 Bei San Huan X1 Road Shuang Yu Shu Hai Dian District Beijing, China (86 1) 256-6888</p>
<p>Japan Hewlett-Packard Japan, Ltd. 9-1 Takakura-Cho, Hachioji Tokyo 192, Japan (81 426) 60-2111</p>	<p>Singapore Hewlett-Packard Singapore (Pte.) Ltd. 150 Beach Road #29-00 Gateway West Singapore 0718 (65) 291-9088</p>	<p>Taiwan Hewlett-Packard Taiwan 8th Floor, H-P Building 337 Fu Hsing North Road Taipei, Taiwan (886 2) 712-0404</p>	

4 Front and Rear Panel

This chapter contains descriptions of the keys and connectors and other hardware on the front and rear panels. It also describes which information is displayed in the various parts of the display.

Front Panel Overview

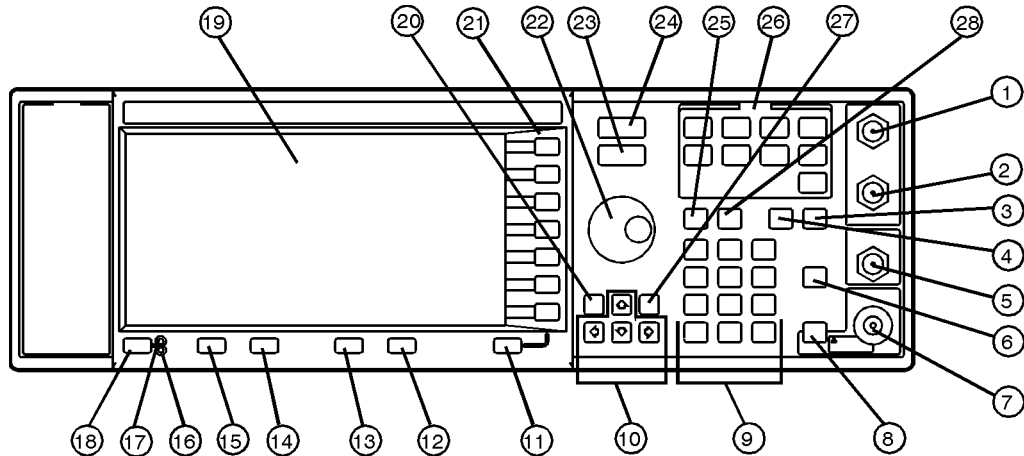

pk724a

1. EXT 1 INPUT Connector

This female BNC input connector accepts a 1 V_{peak} signal for FM, Φ M, and AM. For all these modulations, ± 1 V_{pk} produces the indicated deviation or depth. When AC-coupled inputs are selected for FM, Φ M, or AM, HI/LO annunciators will light if the peak input voltage differs from 1.0 V by more than 3%. The input impedance is 50 Ω . The damage levels are 5 V_{rms} and 10 V_{pk}. If you configure your signal generator with Option 1EM, this input is relocated to a rear panel, female BNC connector.

2. EXT 2 INPUT Connector

This female BNC input connector accepts a 1 V_{peak} signal for FM, Φ M, AM, and pulse modulation. With FM, Φ M, or AM, ± 1 V_{pk} produces the indicated deviation or depth. With pulse modulation, +1 V is on and 0 V is off. When AC-coupled inputs are selected for FM, Φ M, or AM, HI/LO annunciators will light if the peak input voltage differs from 1.0 V by more than 3%. The input impedance is 50 Ω . The damage levels are 5 V_{rms} and 10 V_{pk}. If you configure your signal generator with Option 1EM, this input is relocated to a rear panel, female BNC connector.

3. Help Key

Press this hardkey for a short textual description of the function of the front panel hardkeys and softkeys. Press any other key and you will be returned to normal instrument operation.

4. Trigger Key

Press this hardkey to trigger a step or list sweep.

5. LF OUTPUT Connector

This female BNC connector is the output connector for modulation signals generated by the LF source function generator. You can also output signals where the frequency and shape are set by the internal source as it is being used by a modulation. For pulse modulation, however, the internal source is a sinewave which is later squared by the modulator to generate the pulse squarewave. This output is capable of driving 3.5 Vpk into a 50 Ω load. If you configure your signal generator with Option 1EM, this input is relocated to a rear panel, female BNC connector.

6. Mod On/Off Key

This hardkey toggles all modulation signals on and off. Although you can set up and enable various modulation states, the RF carrier is not modulated until **Mod On/Off** is set to **On**. An annunciator is always turned on in the display to indicate whether modulation is turned on or off.

7. RF OUTPUT Connector

This female Type-N connector is the output connector for RF signals. The source impedance is 50 Ω . The damage levels are 50 Vdc, 50 W at ≤ 2 GHz, and 25 W at > 2 GHz maximum. The reverse power protection circuit will trip, however, at nominally 1 watt. If you configure your signal generator with Option 1EM, this output is relocated to a rear panel female Type-N connector.

8. RF On/Off Key

This hardkey toggles the RF signal on and off at the RF OUTPUT connector. An annunciator is always turned on in the display to indicate whether RF is turned on or off.

9. Numeric Keypad

The numeric keypad consists of the digit keys (0 through 9), a decimal point key, and a backspace key, . The backspace key has dual functions for both backspacing and for changing the sign of a value to positive or negative. Use these keys at any time when the active function requires a value input.

10. Arrow Keys

The up and down arrow keys increase or decrease a numeric value. You can also use these keys to scroll through displayed lists to select items. The left and right arrow keys choose the highlighted digit in the active function display, which is modified by the up and down arrow keys. You can also use these keys in a list to select items in a row.

11. Return Key

The **Return** key moves you from your current softkey menu to the softkey menu that precedes it. It will back up through the menus of the current hardkey until you reach the first menu of that key.

12. Display Contrast Decrease Key

Pressing the decrease contrast key and holding it down causes the display background to gradually darken in comparison to the text on the display.

13. Display Contrast Increase Key

Pressing the increase contrast key and holding it down causes the display background to gradually brighten in comparison to the text on the display.

14. Local Key

Press this key to return the signal generator to local (front panel) control from remote operation.

15. Preset Key

Press this key to set the signal generator to a known state (either the factory-defined state or a user-defined state).

16. Standby LED

This yellow LED lights when the instrument is in standby condition. In standby, the power switch is off but the instrument is still connected to the mains circuit by way of the power cord.

17. Line Power LED

This green LED lights when power is cycled on to the signal generator.

18. Power Switch

Pressing this hardkey turns power to the signal generator either on (green LED on) or to standby (yellow LED on).

19. Display

The LCD display provides information on the current instrument state such as modulation status, frequency and amplitude settings, status indicators, and error messages. Softkey labels corresponding to their adjacent keys are located on the right-hand side of the display.

20. Hold Key

Press this hardkey to de-activate the current active function and blank the softkey menu. Once **Hold** is pressed, the front panel knob, the arrow keys, and the numeric keypad have no effect. To return to normal operation, press any front panel hardkey.

21. Softkeys

Press a softkey to activate the function indicated by the label on the display directly to the left of the softkey.

22. Knob

The knob increases or decreases a numeric value. Any of the values that can be set through the numeric keypad or the step keys can also be set using the knob.

23. Amplitude Key

Press this hardkey to activate the power level amplitude function so that you can change the amplitude of the RF output.

24. Frequency Key

Press this hardkey to activate the frequency function so that you can change the frequency of the RF output.

25. Save Key

This hardkey lets you save up to 100 different instrument states in a combination of 100 memory registers and 10 register sequences.

26. Menu Keys

These hardkeys provide access to the signal generator's primary functionality. Press these keys for access to softkey menus where you can configure modulations, step and list sweeps, and various frequency and power capabilities.

27. Incr Set Key

Press this hardkey to cancel the highlighted digit in the active function display which allows you to enter an arbitrary increment size.

28. Recall Key

This hardkey lets you restore any instrument state that you previously saved in a memory register. You can save up to 100 different instrument states in a combination of 100 memory registers and 10 register sequences.

Display Annotation

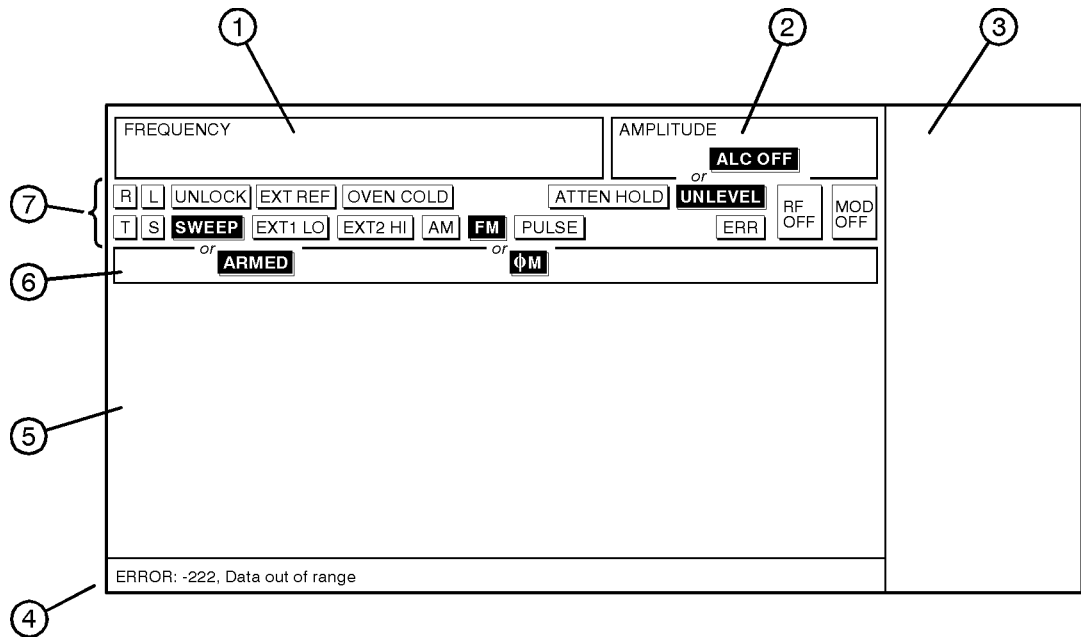

pk764a

1. Frequency Area

The current CW frequency setting is shown in this portion of the display. Indicators are also displayed in this area when a frequency offset or multiplier is set or if frequency reference mode is turned on.

2. Amplitude Area

The current output power level setting is shown in this portion of the display. Indicators are also displayed in this area when an amplitude offset is set or if amplitude reference mode is turned on.

3. Softkey Labels

These labels define the function of the corresponding softkeys immediately to the right of the label.

4. Error Messages Area

Error messages are reported in this space. When multiple error messages occur, only the most recent message remains displayed. All of the reported error messages can be viewed by pressing **Utility, Error Info, View Next Error Message**.

5. Text Area

This area is used to display status information about the signal generator such as the modulation status, to enter information such as creating sweep lists, and to manage information such as displaying the catalog of files and deleting unwanted files.

6. Active Entry Area

The current active function is shown in this area. For example, if frequency is the active function, the current setting will be displayed in the active entry area and that setting will change as you enter a new value. If the active function has an increment value associated with it, that value is displayed here also.

7. Annunciators

The display annunciators show the status of some of the signal generator functions and indicate error conditions of the instrument. The following annunciators are available:

ΦM	This annunciator is turned on when phase modulation is turned on. A second annunciator, FM , will appear in the same position if frequency modulation is turned on. Frequency modulation and phase modulation cannot be turned on at the same time so the two annunciators will never conflict.
ALC OFF	This annunciator is turned on when the automatic leveling control circuit is disabled. A second annunciator, UNLEVEL , will appear in the same position if the signal generator's automatic level control is unable to maintain the output level. When the ALC is disabled, the unlevelled annunciator has no meaning so these annunciators will never conflict.
AM	This annunciator is turned on when amplitude modulation is turned on.

ARMED	This annunciator is turned on when a sweep has been initiated and the signal generator is waiting for the sweep trigger event.
ATTEN HOLD	This annunciator is turned on when the attenuator hold function is turned on. When this function is on, the attenuator is frozen at its current setting.
ERR	This annunciator is turned on when an error message is placed in the error queue. This annunciator will not turn off until you clear the error queue of all error messages. You can view and delete error messages using the Utility menu.
EXT1 LO/HI	This annunciator toggles between EXT1 LO and EXT1 HI . This annunciator is turned on if the AC-coupled signal to the EXT 1 input is less than 0.97 Vpk or greater than 1.03 Vpk.
EXT2 LO/HI	This annunciator toggles between EXT2 LO and EXT2 HI . This annunciator is turned on if the AC-coupled signal to the EXT 2 input is less than 0.97 Vpk or greater than 1.03 Vpk.
EXT REF	This annunciator is turned on when an external 1, 2, 5, or 10 MHz frequency reference is in use.
FM	This annunciator is turned on when frequency modulation is turned on. A second annunciator, PM , will appear in the same position if phase modulation is turned on. Frequency modulation and phase modulation cannot be turned on at the same time so the two annunciators will never conflict.
L	The L annunciator is turned on when the signal generator is in the listen mode and receiving information or commands over the HP-IB.
MOD OFF	This annunciator toggles between MOD OFF and MOD ON and is always visible in the display. This annunciator indicates whether the modulations which you have enabled are modulating the RF carrier.
OVEN COLD	This annunciator is turned on when the temperature of the internal ovenized reference oscillator (Option 1E5) has dropped below an acceptable level. When this annunciator is turned on, frequency accuracy will be degraded. This condition should only occur if the signal generator is disconnected from line power. The annunciator is timed and automatically turns off after a specified period of time.

Front and Rear Panel Display Annotation

PULSE	This annunciator is turned on when pulse modulation is turned on.
R	The R annunciator is turned on when the signal generator is in remote HP-IB operation.
RF OFF	This annunciator toggles between RF OFF and RF ON and is always visible in the display. This annunciator indicates whether the RF signal is present at the RF OUTPUT connector.
S	The S annunciator is turned on when the signal generator has generated a service request (SRQ) over the HP-IB.
SWEEP	This annunciator is turned on when the signal generator is sweeping in list or step mode.
T	The T annunciator is turned on when the signal generator is in the talk mode and is transmitting information over the HP-IB.
UNLEVEL	This annunciator is turned on when the signal generator is unable to maintain the correct output level. The UNLEVEL annunciator is not necessarily an indication of instrument failure. Unleveled conditions can occur during normal operation. A second annunciator, ALC OFF , will appear in the same position when the automatic leveling control circuit is disabled. When the ALC is disabled, the UNLEVEL annunciator has no meaning so these annunciators will never conflict.
UNLOCK	This annunciator is turned on when any of the signal generator's phase locked loops are unable to maintain phase lock. You can determine which loop is unlocked by interrogating the error messages.

Rear Panel Overview

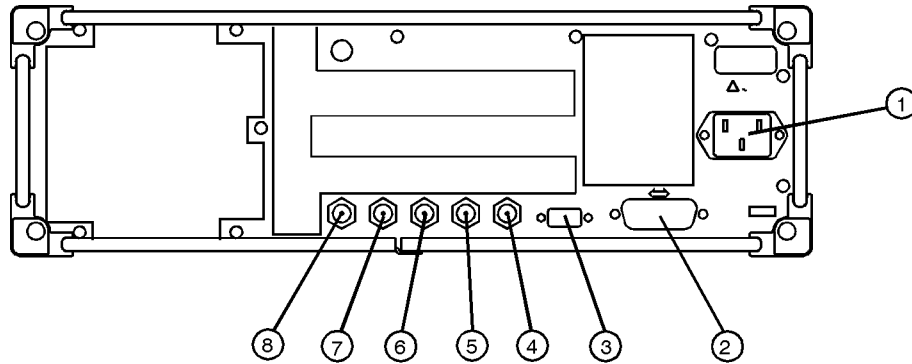

pk704a

1. AC Power Receptacle

The power cord receptacle accepts a three-pronged cable that is shipped with the instrument. The line voltage is connected here.

2. HP-IB Connector

The HP-IB connector allows communications with compatible devices such as power meters and external controllers.

3. AUXILIARY INTERFACE Connector

This male DB-9 connector is an RS-232 serial port which can be used for remotely controlling the signal generator. The following table shows the description of the pinouts.

Pin Number	Signal Description	Signal Name
1	No Connection	
2	Receive Data	RECV
3	Transmit Data	XMIT
4	+5 V	
5	Ground, 0 V	
6	No Connection	
7	Request to Send	RTS
8	Clear to Send	CTS
9	No Connection	

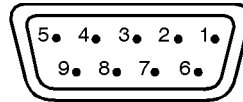

View looking into
rear panel connector

pk763a

4. SWEEP OUT Connector

This female BNC connector provides a voltage range of 0 to +10 V. When the signal generator is sweeping, the SWEEP OUT signal ranges from 0 V at the beginning of the sweep to +10 V at the end of the sweep regardless of the sweep width. In CW mode this connector has no output. The output impedance is less than 1 Ω and can drive 2 k Ω .

5. TRIGGER OUT Connector

This female BNC connector outputs a TTL signal that is asserted high at the start of a dwell sequence, or at the start of waiting for the point trigger in manual sweep mode, and low when the dwell is over, or when the point trigger is received. The logic can be reversed.

6. TRIGGER IN Connector

This female BNC connector accepts a TTL signal for triggering point-to-point in manual sweep mode. Triggering can occur on either the positive or negative edge. The damage level is $\geq +10$ V or ≤ -4 V.

7. 10 MHz IN Connector

This female BNC connector accepts a -3.5 to $+20$ dBm signal from an external timebase reference which is within ± 10 ppm (standard timebase) or ± 1 ppm (high stability timebase). The nominal input impedance is 50Ω . The signal generator detects when a valid reference signal is present at this connector and automatically switches from internal to external reference operation.

8. 10 MHz OUT Connector

This female BNC connector provides a nominal signal level of $+7$ dBm ± 2 dB, and output impedance of 50Ω . The accuracy is determined by the timebase used.

Front and Rear Panel
Rear Panel Overview

5 Hardkey and Softkey Reference

This chapter describes each front panel hardkey and each softkey associated with the hardkey. The SCPI programming commands are listed in addition to normal preset and power-on conditions. The chapter is organized alphabetically by front panel hardkey.

AM

Pressing the front panel **AM** key reveals a menu of softkeys. These softkeys are described in this section in alphabetical order.

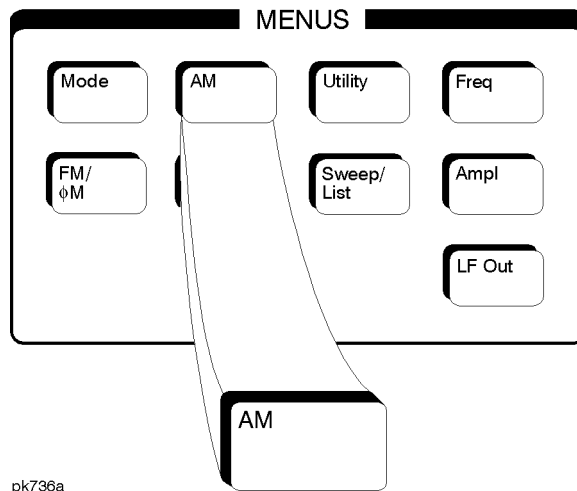

AM Depth

This softkey sets the amplitude modulation depth, in percent, for the **AM Path 1** and **AM Path 2** configurations. To change the value of the AM depth, press the softkey once. The current value for AM depth is displayed in the active entry area. To enter a new value, rotate the front panel knob until the desired value is displayed, use the up and down arrow keys, or enter the value using the numeric keypad and press the % terminator softkey. The range of values allowed is 0.1 to 100%. The minimum increment allowed is 0.1%. Notice that the new value of AM depth applies only to whichever AM path configuration (**AM Path 1** or **AM Path 2**) you have currently selected.

Softkey Location: Press **AM, AM Depth**
 or press **AM, AM Waveform, Dual-Sine, AM Depth**

Status after Normal Preset: 0.1%

SCPI Commands:

```
[[:SOURce]:AM[1]|2[:DEPTh] <val><unit>
```

```
[[:SOURce]:AM[1]|2[:DEPTh]?
```

AM Depth Couple Off On

This softkey toggles the AM depth coupling on and off. AM depth coupling links the AM depth values of **AM Path 1** and **AM Path 2**. When the values are coupled, any change you make to one AM depth value is applied to both AM depth values.

Softkey Location: Press **AM**, **AM Depth Couple Off On**

Status after Normal Preset: Off

SCPI Commands:

```
[[:SOURce]:AM[1]|2[:DEPTH]:TRACk ON|OFF|1|0
```

```
[:SOURce]:AM[1]|2[:DEPTH]:TRACk?
```

AM Dual-Sine Ampl Ratio

Press this softkey to set the ratio of the depth of AM tone 2 to the depth of AM tone 1 as a percent. The range of values allowed is 0 to 100%. The minimum increment allowed is 0.1%. The sum of the two AM depths results in the total AM depth (set by the **AM Depth** softkey in the initial AM Menu).

For example, if the total AM depth is 30% and you set **AM Dual-Sine Ampl Ratio** to 50%, then the depth of AM tone 1 will be 20% and the depth of AM tone 2 will be 10% (50% of 20%) so that the depth of the two tones adds up to 30% (20% plus 10%).

Softkey Location: Press **AM**, **AM Waveform**, **Dual-Sine**, **AM Dual-Sine Ampl Ratio**

SCPI Commands:

```
[[:SOURce]:AM[1]|2:INTernal[1]:FREQUency:ALTernate:AMPLitude:PERCent  
<val><unit>
```

```
[[:SOURce]:AM[1]|2:INTernal[1]:FREQUency:ALTernate:AMPLitude:PERCent?
```

AM Off On

This softkey enables the amplitude modulation for whichever AM path configuration (**AM Path 1** or **AM Path 2**) you have selected. Notice, however, that although you can enable amplitude modulation with this softkey, the RF carrier is modulated by the enabled modulation only when you have also set **Mod On/Off** to **On**. Whenever amplitude modulation is enabled, the **AM** annunciator is turned on in the display.

There are two paths for AM modulation which can be simultaneously enabled as long as they use different sources (Int, Ext1, or Ext2). The modulation signals from both paths are summed internally for composite modulation.

Softkey Location: Press **AM**, **AM Off On**

Status after Normal Preset: Off

SCPI Commands:

```
[[:SOURce]:AM[1]|2:STATe ON|OFF|1|0
```

```
[[:SOURce]:AM[1]|2:STATe?
```

AM Path 1 2

Use **AM Path 1** and **AM Path 2** to define two unique amplitude modulation configurations. For example, select **AM Path 1**. (**AM Path 1** is the default after a normal preset. If **AM Path 1** is not highlighted, press the **AM Path 1 2** softkey until the selection toggles to **AM Path 1**.) Configure the modulation characteristics (such as depth, source, rate, and waveform) using the remaining softkeys in the AM menu. Then enable AM by setting **AM Off On** to **On**.

To configure a second amplitude modulation configuration, toggle to **AM Path 2**. Define the modulation characteristics for this second configuration and enable AM by setting **AM Off On** to **On**.

The RF carrier is available at the RF OUTPUT connector when you set **RF On/Off** to **On**. Set **Mod On/Off** to **On** to modulate the RF carrier with the modulations that you have enabled.

AM Path 1 and **AM Path 2** are summed internally for composite modulation. Either path can be switched to any one of the modulation sources: Int, Ext1, or Ext2. All modulation types can be simultaneously enabled, except FM with Φ M. AM, FM, and Φ M can sum simultaneous inputs from any two sources (Int, Ext1, and Ext2). Any given source (Int, Ext1, or Ext2) can only be routed to one activated modulation type.

Softkey Location: Press **AM**, **AM Path 1 2**

Status after Normal Preset: AM Path 1

SCPI Commands:

```
[[:SOURce]:AM:WIDeband:STATe ON|OFF|1|0
```

```
[[:SOURce]:AM:WIDeband:STATe?
```

AM Rate

Use this softkey to change the internal modulation frequency for the **AM Path 1** and **AM Path 2** configurations. To change the value, press the softkey once. The current value for AM rate is displayed in the active entry area. To enter a new value, rotate the front panel knob until the desired value is displayed, use the up and down arrow keys, or enter the value using the numeric keypad and press the **Hz** or **kHz** terminator softkey. The range of values allowed is 0.1 Hz to 10 kHz. (0.1 Hz to 50 kHz is the range allowed if sinewave is selected as the internal waveform.) The minimum increment allowed is 0.1 Hz. Notice that the new value of AM rate applies only to whichever AM configuration (**AM Path 1** or **AM Path 2**) you have currently selected.

Softkey Location: Press **AM**, **AM Rate**

Status after Normal Preset: 400 Hz

SCPI Commands:

```
[[:SOURce]:AM[1]|2:INTernal[1]:FREQuency <val><unit>
```

```
[[:SOURce]:AM[1]|2:INTernal[1]:FREQuency?
```

AM Source

Pressing this softkey reveals a menu of choices for amplitude modulation sources. You can choose internally-generated amplitude modulation or select an externally-applied signal from either the EXT 1 INPUT or EXT 2 INPUT connectors. The internal modulation is always AC-coupled. For the externally-applied signals, you can choose between AC- and DC-coupled modulation. A 1.0 Vpk input is required for calibrated AM depth settings. The **EXT 1 LO/HI** and **EXT 2 LO/HI** display annunciators will turn on if the peak input voltage differs from 1.0 Vpk by more than 3%. (The LO/HI annunciators only function for AC-coupled external inputs.)

The internal and external 1 and 2 sources have multiple uses. You can use them for amplitude, frequency, and phase modulation. For pulse modulation you must use the external 2 source. However, any given source can only be routed to one enabled modulation at a time. If, for example, you were using the external 1 source in a frequency modulation configuration for **FM Path 1**, and then you configured **AM Path 2** to also use the external 1 source, the signal generator would turn off **FM Path 1** and assign the external 1 source to your **AM Path 2** configuration. Notice that for these purposes the external 1 AC-coupled source is the same as the external 1 DC-coupled source and the external 2 AC-coupled source is the same as the external 2 DC-coupled source.

Softkey Location: Press **AM**, **AM Source**

Status after Normal Preset: INT

SCPI Commands:

```
[[:SOURce]:AM[1]|2:SOURce?
```

AM Start Rate

Use this softkey to change the starting internal modulation frequency for swept-sine amplitude modulation. To change the value, press the softkey once. The current value for the AM start rate is displayed in the active entry area. To enter a new value, rotate the front panel knob until the desired value is displayed, use the up and down arrow keys, or enter the value using the numeric keypad and press the **Hz** or **kHz** terminator softkey. The range of values allowed is 0.1 Hz to 50 kHz. The minimum increment allowed is 0.1 Hz.

This softkey is coupled to the **AM Rate** softkey in the initial AM Menu and the **AM Tone 1 Rate** softkey in the AM Dual-Sine Menu. Any value set for **AM Start Rate** is reflected in the **AM Rate** and **AM Tone 1 Rate** softkeys. Conversely, if you change the value for either the **AM Rate** softkey or the **AM Tone 1 Rate** softkey, the value for **AM Start Rate** is changed to match.

Softkey Location: Press **AM**, **AM Waveform**, **Swept-Sine**, **AM Start Rate**

Status after Normal Preset: 400.0 Hz

SCPI Commands:

```
[[:SOURce]:AM[1]]2:INTernal[1]:FREQuency <val><unit>
```

```
[[:SOURce]:AM[1]]2:INTernal[1]:FREQuency?
```

AM Stop Rate

Use this softkey to change the ending internal modulation frequency for swept-sine amplitude modulation. To change the value, press the softkey once. The current value for the AM stop rate is displayed in the active entry area. To enter a new value, rotate the front panel knob until the desired value is displayed, use the up and down arrow keys, or enter the value using the numeric keypad and press the **Hz** or **kHz** terminator softkey. The range of values allowed is 0.1 Hz to 50 kHz. The minimum increment allowed is 0.1 Hz.

This softkey is coupled to the **AM Tone 2 Rate** softkey in the AM Dual-Sine Menu. Any value set for **AM Stop Rate** is reflected in the **AM Tone 2 Rate** softkey. Conversely, if you change the value for the **AM Tone 2 Rate** softkey, the value for **AM Stop Rate** is changed to match.

Softkey Location: Press **AM**, **AM Waveform**, **Swept-Sine**, **AM Stop Rate**

Status after Normal Preset: 400.0 Hz

SCPI Commands:

```
[[:SOURce]:AM[1]|2:INTernal[1]:FREQuency:ALTernate <val><unit>
```

```
[[:SOURce]:AM[1]|2:INTernal[1]:FREQuency:ALTernate?
```

AM Sweep Time

Press this softkey to set the sweep time for swept-sine amplitude modulation. The signal generator will vary the AM rate from the specified start rate to the stop rate in the time set with this softkey. Enter the desired sweep time using the up and down arrow keys, the front panel knob, or enter a value using the numeric keypad and press the **sec** or **msec** terminator softkey. The range of values allowed is 1 ms through 65.535 s. The minimum increment allowed is 1 ms.

Softkey Location: Press **AM**, **AM Waveform**, **Swept-Sine**, **AM Sweep Time**

Status after Normal Preset: 100.0 msec

SCPI Commands:

```
[[:SOURce]:AM[1]|2:INTernal[1]:SWEep:TIME <val><unit>
```

```
[[:SOURce]:AM[1]|2:INTernal[1]:SWEep:TIME?
```

AM Sweep Trigger

Pressing this softkey reveals a menu of choices for triggering swept-sine amplitude modulation. You can choose triggering that occurs immediately, triggering that is supplied by the HP-IB, triggering on either the positive or negative edge of a signal supplied to the TRIGGER IN connector, or triggering by the front panel **Trigger** key.

Softkey Location: Press **AM**, **AM Waveform**, **Swept-Sine**, **AM Sweep Trigger**

Status after Normal Preset: Immediate

SCPI Commands:

:TRIGger[:SEQuence]:SOURce?

AM Tone 1 Rate

Press this softkey to set the internal modulation frequency for the AM tone 1. Enter the desired rate using the up and down arrow keys, the front panel knob, or enter a value using the numeric keypad and press the **kHz** or **Hz** terminator softkey. The range of values allowed is 0.1 Hz through 50 kHz. The minimum increment allowed is 0.1 Hz.

This softkey is coupled to the **AM Rate** softkey in the initial AM Menu and the **AM Start Rate** softkey in the AM Swept-Sine Menu. Any value set for **AM Tone 1 Rate** is reflected in the **AM Rate** and **AM Start Rate** softkeys. Conversely, if you change the value for either the **AM Rate** softkey or the **AM Start Rate** softkey, the value for **AM Tone 1 Rate** is changed to match.

Softkey Location: Press **AM**, **AM Waveform**, **Dual-Sine**, **AM Tone 1 Rate**

Status after Normal Preset: 400.0 Hz

SCPI Commands:

[:SOURce]:AM[1]2:INTernal[1]:FREQuency <val><unit>

[:SOURce]:AM[1]2:INTernal[1]:FREQuency?

AM Tone 2 Rate

Press this softkey to set the internal modulation frequency for the AM tone 2. Enter the desired rate using the up and down arrow keys, the front panel knob, or enter a value using the numeric keypad and press the **kHz** or **Hz** terminator softkey. The range of values allowed is 0.1 Hz through 50 kHz. The minimum increment allowed is 0.1 Hz.

This softkey is coupled to the **AM Rate** softkey in the initial AM Menu and the **AM Stop Rate** softkey in the AM Swept-Sine Menu. Any value set for **AM Tone 2 Rate** is reflected in the **AM Rate** and **AM Stop Rate** softkeys. Conversely, if you change the value for either the **AM Rate** softkey or the **AM Stop Rate** softkey, the value for **AM Tone 2 Rate** is changed to match.

Softkey Location: Press **AM**, **AM Waveform**, **Dual-Sine**, **AM Tone 2 Rate**

Status after Normal Preset: 400.0 Hz

SCPI Commands:

```
[[:SOURce]:AM[1]]2:INTernal[1]:FREQuency:ALTernate <val><unit>
```

```
[[:SOURce]:AM[1]]2:INTernal[1]:FREQuency:ALTernate?
```

AM Waveform

Pressing this softkey reveals a menu of AM waveform choices for your **AM Path 1** and **AM Path 2** configurations. Select from sine, triangle, square, ramp, noise, dual-sine, and swept-sine waveforms. Notice that your waveform selection applies only to whichever AM path configuration you have currently selected.

Softkey Location: Press **AM**, **AM Waveform**

Status after Normal Preset: Sine

SCPI Commands:

```
[[:SOURce]:AM[1]]2:INTernal[1]:FUNCTion:SHAPE?
```

Bus

This softkey is one of the choices in the AM Sweep Trigger menu. With **Bus** selected, you use the HP-IB to trigger single sweeps of swept-sine amplitude modulation.

Softkey Location: Press **AM, AM Waveform, Swept-Sine, AM Sweep Trigger, Bus**

Status after Normal Preset: AM sweep trigger is set to Immediate

SCPI Commands:

```
[[:SOURce]:AM[1]]2:INTernal[1]:SWEep:TRIGger BUS
```

```
[[:SOURce]:AM[1]]2:INTernal[1]:SWEep:TRIGger?
```

Dual-Sine

Pressing this softkey reveals a menu of choices for setting the dual-sine amplitude modulation parameters. In this menu you can set the AM rates for two separate tones. In addition, you can set the AM depth for **AM Path 1** and **AM Path 2** and also set a ratio of the tone 2 AM depth to the tone 1 AM depth.

Softkey Location: Press **AM, AM Waveform, Dual-Sine**

SCPI Commands:

```
[[:SOURce]:AM[1]]2:INTernal[1]:FUNCTion:SHAPE DUALsine
```

```
[[:SOURce]:AM[1]]2:INTernal[1]:FUNCTion:SHAPE?
```

Ext

This softkey is one of the choices in the AM Sweep Trigger menu. Choosing **Ext** allows you to trigger swept-sine amplitude modulation using the signal applied to the TRIGGER IN rear panel connector. Set the polarity of the trigger signal using the **Trigger In Polarity Neg Pos** softkey.

Softkey Location: Press **AM, AM Waveform, Swept-Sine, AM Sweep Trigger, Ext**

Status after Normal Preset: AM sweep trigger is set to Immediate

SCPI Commands:

```
[[:SOURce]:AM[1]]2:INTernal[1]:SWEep:TRIGger EXTernal
```

```
[[:SOURce]:AM[1]]2:INTernal[1]:SWEep:TRIGger?
```

Ext 1 AC-Coupled

This softkey lets you input an external, AC-coupled, amplitude modulation signal to the EXT 1 INPUT connector. The modulation signal is tested for voltage and a display annunciator will report a high or low condition if the voltage is $> \pm 3\%$ of 1 V_{pk}.

The external 1 input has multiple uses but can be used for only one modulation at a time. If, for example, you were using the external 1 input in a frequency modulation configuration for **FM Path 1**, and then you configured **AM Path 2** to also use the external 1 input, the signal generator would turn off **FM Path 1** and assign the external 1 input to your **AM Path 2** configuration. (For the purpose of this discussion, the external 1 AC-coupled input is the same as the external 1 DC-coupled input.)

Softkey Location: Press **AM**, **AM Source**, **Ext 1 AC-Coupled**

Status after Normal Preset: AM Source is set to Internal

SCPI Commands:

```
[[:SOURce]:AM[1]|2:SOURce EXTernal1
```

```
[[:SOURce]:AM[1]|2:EXTernal[1]:COUPling AC
```

```
[[:SOURce]:AM[1]|2:EXTernal[1]:COUPling?
```

Ext 1 DC-Coupled

This softkey lets you input an external, DC-coupled, amplitude modulation signal to the EXT 1 INPUT connector.

The external 1 input has multiple uses but can be used for only one modulation at a time. If, for example, you were using the external 1 input in a frequency modulation configuration for **FM Path 1**, and then you configured **AM Path 2** to also use the external 1 input, the signal generator would turn off **FM Path 1** and assign the external 1 input to your **AM Path 2** configuration. (For the purpose of this discussion, the external 1 AC-coupled input is the same as the external 1 DC-coupled input.)

Softkey Location: Press **AM**, **AM Source**, **Ext 1 DC-Coupled**

Status after Normal Preset: AM Source is set to Internal

SCPI Commands:

```
[[:SOURce]:AM[1]]2:SOURce EXTernal1
```

```
[[:SOURce]:AM[1]]2:EXTernal[1]:COUPling DC
```

```
[[:SOURce]:AM[1]]2:EXTernal[1]:COUPling?
```

Ext 2 AC-Coupled

This softkey lets you input an external, AC-coupled, amplitude modulation signal to the EXT 2 INPUT connector. The modulation signal is tested for voltage and a display annunciator will report a high or low condition if the voltage is $> \pm 3\%$ of 1 V_{pk}.

The external 2 input has multiple uses but can be used for only one modulation at a time. If, for example, you were using the external 2 input in a frequency modulation configuration for **FM Path 1**, and then you configured **AM Path 2** to also use the external 2 input, the signal generator would turn off **FM Path 1** and assign the external 2 input to your **AM Path 2** configuration. (For the purpose of this discussion, the external 2 AC-coupled input is the same as the external 2 DC-coupled input.)

Softkey Location: Press **AM**, **AM Source**, **Ext 2 AC-Coupled**

Status after Normal Preset: AM Source is set to Internal

SCPI Commands:

```
[[:SOURce]:AM[1]]2:SOURce EXTernal2
```

```
[[:SOURce]:AM[1]]2:EXTernal2:COUPling AC
```

```
[[:SOURce]:AM[1]]2:EXTernal2:COUPling?
```

Ext 2 DC-Coupled

This softkey lets you input an external, DC-coupled, amplitude modulation signal to the EXT 2 INPUT connector.

The external 2 input has multiple uses but can be used for only one modulation at a time. If, for example, you were using the external 2 input in a frequency modulation configuration for **FM Path 1**, and then you configured **AM Path 2** to also use the external 2 input, the signal generator would turn off **FM Path 1** and assign the external 2 input to your **AM Path 2** configuration. (For the purpose of this discussion, the external 2 AC-coupled input is the same as the external 2 DC-coupled input.)

Softkey Location: Press **AM**, **AM Source**, **Ext 2 DC-Coupled**

Status after Normal Preset: AM Source is set to Internal

SCPI Commands:

```
[[:SOURce]:AM[1]]2:SOURce EXTernal2  
[[:SOURce]:AM[1]]2:EXTernal2:COUPling DC  
[[:SOURce]:AM[1]]2:EXTernal2:COUPling?
```

Immediate

This softkey is one of the choices in the AM Sweep Trigger menu. Choosing **Immediate** immediately triggers swept-sine amplitude modulation in a continuous mode. To stop the sweep, choose a different trigger such as **Ext**, or set the waveform to something other than **Swept-Sine**.

Softkey Location: Press **AM**, **AM Waveform**, **Swept-Sine**, **AM Sweep Trigger**, **Immediate**

Status after Normal Preset: AM sweep trigger is set to Immediate

SCPI Commands:

```
[[:SOURce]:AM[1]]2:INTernal[1]:SWEep:TRIGger IMMEDIATE  
[[:SOURce]:AM[1]]2:INTernal[1]:SWEep:TRIGger?
```

Internal

This softkey lets you connect an internally-generated, calibrated signal to the AM modulator. The default state of the internal waveform generator is a 400 Hz sine wave with 0.1% depth.

The internal source has multiple uses but can be used for only one modulation at a time. If, for example, you were using the internal source in a frequency modulation configuration for **FM Path 1**, and then you configured **AM Path 2** to also use the internal source, the signal generator would turn off **FM Path 1** and assign the internal source to your **AM Path 2** configuration.

Softkey Location: Press **AM**, **AM Source**, **Internal**

SCPI Commands:

```
[[:SOURce]:AM[1]]2:SOURce INT[1]  
[[:SOURce]:AM[1]]2:SOURce?
```

Noise

This softkey lets you specify noise as the amplitude modulation waveform for the **AM Path 1** and **AM Path 2** configurations. Notice that the selected waveform applies only to whichever AM path configuration you have currently selected.

Softkey Location: Press **AM, AM Waveform, Noise**

SCPI Commands:

```
[[:SOURce]:AM[1]]2:INTernal[1]:FUNction:SHAPE NOISE  
[:SOURce]:AM[1]]2:INTernal[1]:FUNction:SHAPE?
```

Ramp

This softkey lets you specify ramp as the amplitude modulation waveform for the **AM Path 1** and **AM Path 2** configurations. Notice that the selected waveform applies only to whichever AM path configuration you have currently selected.

Softkey Location: Press **AM, AM Waveform, Ramp**

SCPI Commands:

```
[[:SOURce]:AM[1]]2:INTernal[1]:FUNction:SHAPE RAMP  
[:SOURce]:AM[1]]2:INTernal[1]:FUNction:SHAPE?
```

Sine

This softkey lets you specify sine as the amplitude modulation waveform for the **AM Path 1** and **AM Path 2** configurations. Notice that the selected waveform applies only to whichever AM path configuration you have currently selected.

Softkey Location: Press **AM, AM Waveform, Sine**

SCPI Commands:

```
[[:SOURce]:AM[1]]2:INTernal[1]:FUNction:SHAPE SINE  
[:SOURce]:AM[1]]2:INTernal[1]:FUNction:SHAPE?
```

Square

This softkey lets you specify square as the amplitude modulation waveform for the **AM Path 1** and **AM Path 2** configurations. Notice that the selected waveform applies only to whichever AM path configuration you have currently selected.

Softkey Location: Press **AM, AM Waveform, Square**

SCPI Commands:

```
[[:SOURce]:AM[1]|2:INTernal[1]:FUNction:SHAPE SQUARE  
[:SOURce]:AM[1]|2:INTernal[1]:FUNction:SHAPE?
```

Swept-Sine

Pressing this softkey reveals a menu of choices for setting the swept-sine amplitude modulation parameters. In this menu you can set the start and stop AM rate and the sweep time. You can set the signal generator to a single, externally-triggered sweep on either a negative or positive TTL level or you can choose continuous sweep, triggered immediately. In this menu you can also select either a positive or negative polarity for the TRIGGER OUT signal.

Softkey Location: Press **AM, AM Waveform, Swept-Sine**

SCPI Commands:

```
[[:SOURce]:AM[1]|2:INTernal[1]:FUNction:SHAPE SWEPTSINE  
[:SOURce]:AM[1]|2:INTernal[1]:FUNction:SHAPE?
```

Triangle

This softkey lets you specify triangle as the amplitude modulation waveform for the **AM Path 1** and **AM Path 2** configurations. Notice that the selected waveform applies only to whichever AM path configuration you have currently selected.

Softkey Location: Press **AM, AM Waveform, Triangle**

SCPI Commands:

```
[[:SOURce]:AM[1]|2:INTernal[1]:FUNction:SHAPE TRIANGLE  
[:SOURce]:AM[1]|2:INTernal[1]:FUNction:SHAPE?
```

Trigger In Polarity Neg Pos

Press this softkey to toggle between a negative TTL level trigger (0 V) and a positive TTL level trigger (+5 V) for externally triggering swept-sine amplitude modulation.

This softkey is coupled to the **Trigger In Polarity Neg Pos** softkey for swept-sine FM, Φ M, and LF Out, and to the **Ext Neg** and **Ext Pos** sweep trigger selections in the Sweep/List Menu. If you set the **Trigger In Polarity Neg Pos** softkey in the AM Swept-Sine Menu to **Neg**, the **Trigger In Polarity Neg Pos** softkey is also set to **Neg** for swept-sine FM, Φ M, and LF Out. In addition, if the step or list sweep is set to externally trigger, the selection will automatically be set to **Ext Neg**. The same softkeys will toggle to **Pos** or to **Ext Pos** if you select **Pos** in the Swept-Sine AM Menu.

Conversely, if the **Trigger In Slope Neg Pos** softkey is toggled in the swept-sine FM, Φ M, or LF Out menus, it will cause the swept-sine AM softkey to toggle also. This is also true for the **Ext Neg** and **Ext Pos** step or list sweep trigger selections.

Softkey Location: Press **AM**, **AM Waveform**, **Swept-Sine**, **Trigger In Polarity Neg Pos**

Status after Normal Preset: Pos

SCPI Commands:

```
:TRIGger[:SEQuence]:SLOPe POSitive|NEGative
:TRIGger[:SEQuence]:SLOPe?
```

Trigger Key

This softkey is one of the choices in the AM Sweep Trigger menu. With **Trigger Key** selected, when you press the **Trigger** front panel key you immediately trigger a single sweep of swept-sine amplitude modulation.

The **Trigger** key has autorepeat capability. Hold it down and you will repeatedly trigger sweeps until you release the key.

Softkey Location: Press **AM**, **AM Waveform**, **Swept-Sine**, **AM Sweep Trigger**, **Trigger Key**

Status after Normal Preset: AM sweep trigger is set to Immediate

SCPI Commands:

```
[:SOURce]:AM[1]|2:INTernal[1]:SWEep:TRIGger KEY
[:SOURce]:AM[1]|2:INTernal[1]:SWEep:TRIGger?
```

Trigger Out Polarity Neg Pos

This softkey toggles the polarity of the TTL signal that is output at the rear panel TRIGGER OUT connector. When **Trigger Out Polarity Neg Pos** is set to **Pos**, the output signal is asserted high (+5 V) at the start of the swept-sine amplitude modulation sweep and low (0 V) when the sweep is concluded. Setting **Trigger Out Polarity Neg Pos** to **Neg** reverses the polarity, where a high is 0 V and a low is +5 V.

This softkey is coupled to the **Trigger Out Polarity Neg Pos** softkey in the swept-sine FM, Φ M, and LF Out menus and the sweep/list menu. When the polarity is toggled for this softkey in any one of these menus, it affects all locations of the softkey.

Softkey Location: Press **AM**, **AM Waveform**, **Swept-Sine**,
Trigger Out Polarity Neg Pos

Status after Normal Preset: Pos

SCPI Commands:

:TRIGger:OUTPut:POLarity POSitive|NEGative

:TRIGger:OUTPut:POLarity?

Ampl

Pressing the front panel **Ampl** key reveals a menu of softkeys. These softkeys are described in this section in alphabetical order.

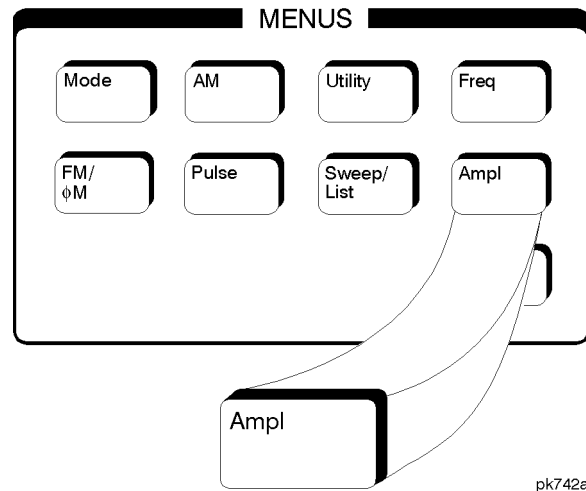

ALC Off On

This softkey toggles the automatic leveling control (ALC) circuit off and on.

The ALC is normally on. The RF output power of the signal generator is constantly monitored and controlled by the ALC circuit. Its purpose is to hold output power at its desired level in spite of drift due to temperature and time.

There are some modulation conditions which the ALC circuit cannot handle properly which lead to output level errors. In these conditions, better power level accuracy can be obtained by turning the ALC off and using power search. (Refer to the **Power Search Manual Auto** softkey documented in this section for more information about power search.) ALC Off is useful with pulse modulation with a pulse width narrower than 2 μ s and with certain external I/Q modulation.

Pulse modulation is accomplished using a modulator which precedes the ALC detector. The ALC must, therefore, measure a pulsed signal, and it is able to do this if the pulse width exceeds 2 μ s.

When ALC is off, the **ALC OFF** display annunciator will turn on.

NOTE:

An alternative to setting the ALC off is to set the ALC bandwidth to narrow. See the **ALC BW Normal Narrow** softkey in the this section.

Softkey Location: Press **Ampl, ALC Off On**

Status after Normal Preset: On

SCPI Commands:

`[[:SOURce]:POWer:ALC[:STATe] ON|OFF]1|0`

`[[:SOURce]:POWer:ALC[:STATe]]?`

Ampl Offset

Press this softkey to set a value for amplitude offset. An amplitude offset changes the value shown in the amplitude area of the display but does not affect the output power. For example, if the current output power is 0 dBm and you enter an amplitude offset of -3 dBm, the output power will remain at 0 dBm but the display will show an amplitude of -3 dBm. This feature lets you simulate the power level at a test point beyond the RF OUTPUT connector.

An amplitude offset can be entered at any time during normal operation and also when you are operating in amplitude reference mode. To enter an offset, press **Ampl Offset** and enter the desired offset value using the up and down arrow keys, the front panel knob, or enter a value using the numeric keypad and press the **dB** terminator softkey. When a non-zero offset has been entered, the **OFFSET** indicator is turned on in the amplitude area of the display.

Softkey Location: Press **Ampl, More 1 of 2, Ampl Offset**

Status after Normal Preset: 0.00 dB

SCPI Commands:

`[[:SOURce]:POWer[:LEVel][:IMMediate]:OFFSet <val><unit>`

`[[:SOURce]:POWer[:LEVel][:IMMediate]:OFFSet?`

Ampl Ref Set

This softkey sets the current output power as an amplitude reference value. It also causes the **Ampl Ref Off On** softkey to toggle to the **On** position, turning on amplitude reference mode. All amplitude parameters are then set as relative to the reference value.

Softkey Location: **Ampl, More 1 of 2, Ampl Ref Set**

Status after Normal Preset: 0.0 dBm

SCPI Commands:

```
[[:SOURce]:]POWer:REFerence <val><unit>
```

```
[[:SOURce]:]POWer:REFerence?
```

Ampl Ref Off On

This softkey toggles the amplitude reference mode on and off. When amplitude reference mode is turned on, the amplitude value displayed is equal to the current hardware output power minus the reference value set by the **Ampl Ref Set** softkey. (The **Ampl Ref Set** softkey sets the reference value equal to the current output power. If you have not yet set the reference value, the normal preset value for amplitude reference is 0 dBm.) The **REF** indicator is turned on in the amplitude area of the display. All amplitude parameters will now be set as relative to the reference value.

Amplitude offsets can be used with amplitude reference mode. In this situation, the display will show the amplitude calculated as the current hardware output power minus the reference value plus the amplitude offset.

Amplitude reference mode only changes the display; it does not change the RF output power. For example, if you set your RF output power to -20 dBm, set your reference value, and then turn amplitude reference mode on, your display shows your amplitude as 0 dB but your output power remains at -20 dBm.

Softkey Location: Press **Ampl**, **More 1 of 2**, **Ampl Ref Off On**

Status after Normal Preset: Off

SCPI Commands:

```
[[:SOURce]:]POWer:REFerence:STATe ON|OFF|1|0
```

```
[[:SOURce]:]POWer:REFerence:STATe?
```

Atten Hold Off On

This softkey toggles the attenuator hold function on and off. Turn attenuator hold on to freeze the attenuator at its current setting. The **ATTN HOLD** display annunciator will turn on. Use this function at any time you want to guarantee that there will be no power discontinuity normally associated with the attenuator switching during power adjustments. (When the attenuator is held, only a frequency change will change the attenuator setting. There will be no attenuator switching during power adjustments.) With attenuator hold on, the maximum power adjustment range will vary. However, you will have at least +4 dB and at least -13 dB range.

Softkey Location: Press **Ampl, Atten Hold Off On**

Status after Normal Preset: Off

SCPI Commands:

```
[[:SOURCE]:POWER:ATTenuation:AUTO ON|OFF|1|0
```

```
[[:SOURCE]:POWER:ATTenuation:AUTO?
```

Do Power Search

Press this softkey to execute the power search routine one time. Power search is an internal calibration routine used to achieve calibrated output power when the ALC is off. You can execute a power search at any time by pressing this softkey. You do not need to disconnect modulation inputs, however modulation is disabled during power search. If you are using external I/Q modulation, the power search routine assumes that the I/Q input level is $\sqrt{I^2+Q^2} = 0.5 V_{\text{rms}}$. Actual output amplitude will scale directly with $\sqrt{I^2+Q^2}$.

The following conditions must be met in order to execute the power search routine:

- **ALC Off On** is set to **Off**
- **RF On/Off** is set to **On**

Softkey Location: Press **Ampl**, toggle **ALC Off On** softkey to **Off**, press **Do Power Search**

SCPI Commands:

```
[[:SOURCE]:POWER:ALC:SEARCh ONCE
```

Power Search Manual Auto

This softkey toggles between the auto and manual modes of power search mode. Power search is an internal calibration routine used to achieve calibrated output power when the ALC is off. When you set **Power Search Manual Auto** to **Auto**, power search will execute automatically with each change to the AM or pulse modulation state. You do not need to disconnect modulation inputs, however modulation is disabled during power search.

When you set **Power Search Manual Auto** to **Manual**, the power search routine is not run until the **Do Power Search** softkey is pressed. As with auto mode, you do not need to disconnect modulation inputs during power search, however modulation is disabled during the power search.

The following conditions must be met in order to engage either power search mode:

- **ALC Off On** is set to **Off**
- **RF On/Off** is set to **On**

Softkey Location: Press **Ampl**, toggle **ALC Off On** softkey to **Off**, press **Power Search Manual Auto**

Status after Normal Preset: Manual

SCPI Commands:

```
[[:SOURce]:]POWer:ALC:SEARch ON|OFF|1|0|ONCE
```

```
[[:SOURce]:]POWer:ALC:SEARch?
```

Hardkey and Softkey Reference
Ampl

Amplitude

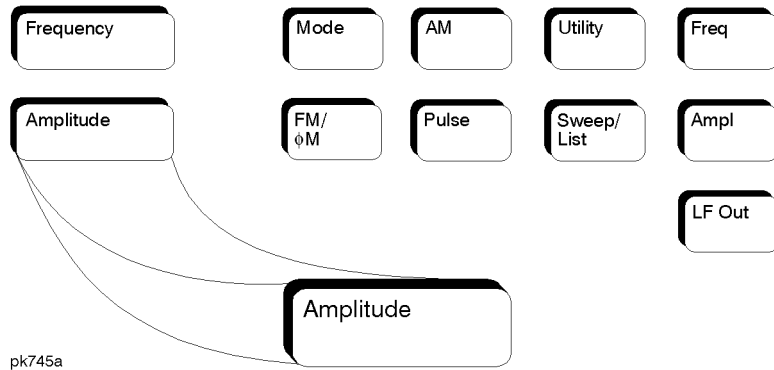

Press this front panel hardkey to change the RF output power. Amplitude becomes the active function and the current value is shown in the active entry area of the display. To enter a new value for amplitude, rotate the front panel knob until the desired value is displayed, use the up and down arrow keys, or enter the value using the numeric keypad and press the **dBm**, **dBuV**, **dBuVemf**, **mV**, **uV**, **mVemf**, or **uVemf** terminator softkey. The output power range allowed depends on your instrument model. Refer to Chapter 9, “Specifications.”

The current RF output power level is always shown in the amplitude area of the display except under the following conditions:

- Amplitude reference mode is turned on
- An offset is applied
- A step or list amplitude sweep is in process
- The RF Off On front panel key is off

The amplitude area of the display is blanked whenever an amplitude sweep is selected.

Status after Normal Preset: -135 dBm

SCPI Commands:

```
[[:SOURce]:POWer[:LEVel][:IMMediate][:AMPLitude] <val><unit>
[:SOURce]:POWer[:LEVel][:IMMediate][:AMPLitude]?]
```

Hardkey and Softkey Reference
Amplitude

Arrow Keys

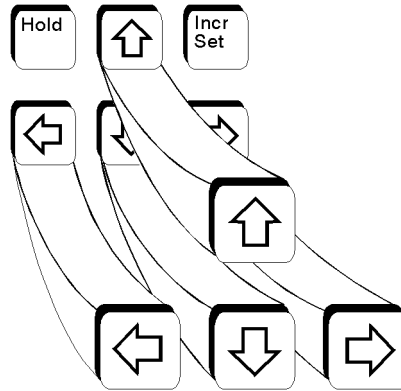

pk750a

Use the up and down arrow keys to increase and decrease the value of a numeric parameter by the increment value. For example, when frequency is the active function, if the current frequency setting is 1 MHz and the increment value set is 1 kHz, pressing the up and down arrow keys will increase and decrease the 1 MHz frequency in 1 kHz steps.

In addition, you can use the up and down arrow keys to scroll through displayed lists to select items.

The left and right arrow keys choose the highlighted digit in the active entry area, which is modified by the up and down arrow keys. When a digit is highlighted it overrides the increment value used with the up and down arrow keys. This override remains in effect until the **Incr Set** key is pressed, an instrument preset occurs, or power is cycled. For example, if frequency is the active parameter and you press the right arrow key until the 1 kHz position is highlighted, the up and down arrow keys will increase and decrease the frequency in 1 kHz increments no matter where the **Incr Set** key has been set.



The arrow keys have autorepeat capability. Hold a key down and its function is continuously executed until you release it.

Hardkey and Softkey Reference
Arrow Keys

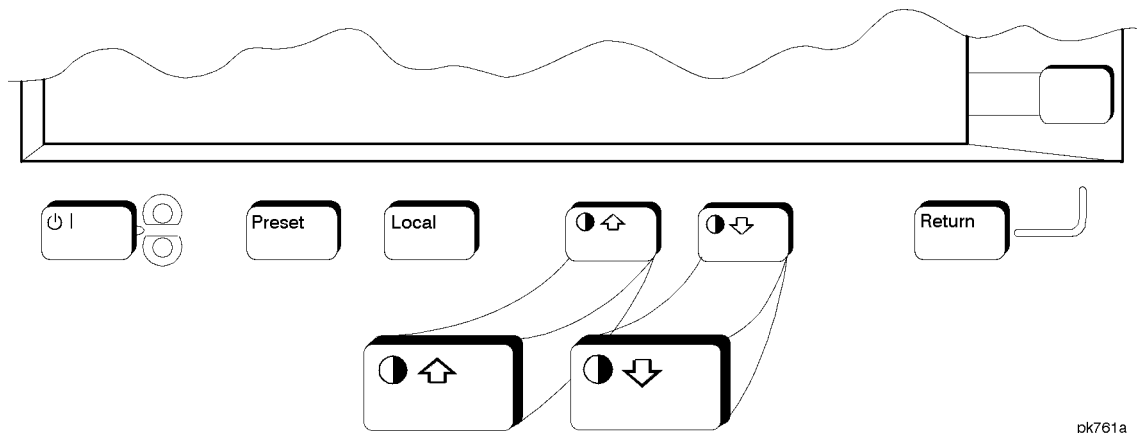
Display Contrast Keys



pk761a

You can adjust the contrast of the display by pressing the decrease contrast key  or the increase contrast key .

Pressing the decrease contrast key and holding it down causes the display background to gradually darken in comparison to the text on the display. The minimum contrast setting is not a completely black display. Some contrast between the background and the text will still be visible.

Pressing the increase contrast key and holding it down causes the display background to gradually brighten in comparison to the text on the display. If the background does not appear to change, it is probably set to the maximum contrast.

Display contrast is a persistent state; it is not affected by an instrument preset or by a power cycle.

SCPI Commands:

:DISPlay:CONTRast <value>

:DISPlay:CONTRast?

Hardkey and Softkey Reference
Display Contrast Keys

FM

Pressing the front panel **FM/ΦM** key reveals a menu of softkeys. The softkeys for FM are described in this section in alphabetical order. For a description of the ΦM softkeys, refer to the “Phase Modulation” section in this chapter.

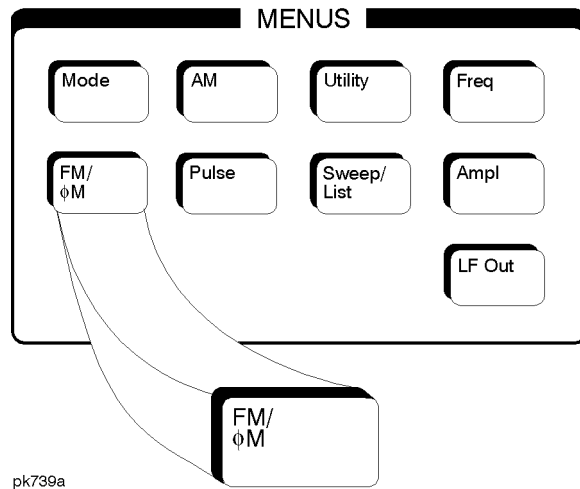

Bus

This softkey is one of the choices in the FM Sweep Trigger menu. With **Bus** selected, you use the HP-IB to trigger single sweeps of swept-sine frequency modulation.

Softkey Location: Press **FM/ΦM**, **More (1 of 2)**, **FM Waveform**, **Swept-Sine**, **FM Sweep Trigger**, **Bus**

Status after Normal Preset: FM sweep trigger is set to Immediate

SCPI Commands:

```
[[:SOURce]:FM[1]]2:INTernal[1]:SWEep:TRIGger BUS
```

```
[[:SOURce]:FM[1]]2:INTernal[1]:SWEep:TRIGger?
```

DCFM/DC Φ M Cal

Pressing this softkey initiates a DCFM calibration. This calibration eliminates the offset in DC FM so that the carrier frequency remains the same with no modulation applied. External, DC-coupled FM must be active when this calibration is executed.

Softkey Location: Press **FM/ Φ M, More (1 of 2), DCFM/DC Φ M Cal**

SCPI Commands:

:CALibration:DCFM

Dual-Sine

Pressing this softkey reveals a menu of choices for setting the dual-sine frequency modulation parameters. In this menu you can set the FM rates for two separate tones. In addition, you can set the FM deviation for **FM Path 1** and **FM Path 2** and also set a ratio of the tone 2 FM deviation to the tone 1 FM deviation.

Softkey Location: Press **FM/ Φ M, More 1 of 2, FM Waveform, Dual-Sine**

SCPI Commands:

[[:SOURce]:FM[1]|2]:INTernal[1]:FUNctIon:SHAPE DUALsine

[[:SOURce]:FM[1]|2]:INTernal[1]:FUNctIon:SHAPE?

Ext

This softkey is one of the choices in the FM Sweep Trigger menu. Choosing **Ext** allows you to trigger swept-sine frequency modulation using a signal applied to the TRIGGER IN rear panel connector. Set the polarity of the trigger signal using the **Trigger In Polarity Neg Pos** softkey.

Softkey Location: Press **FM/ Φ M, More (1 of 2), FM Waveform, Swept-Sine, FM Sweep Trigger, Ext**

Status after Normal Preset: FM sweep trigger is set to Immediate

SCPI Commands:

[[:SOURce]:FM[1]|2]:INTernal[1]:SWEep:TRIGger EXTernal

[[:SOURce]:FM[1]|2]:INTernal[1]:SWEep:TRIGger?

Ext 1 AC-Coupled

This softkey lets you input an external, AC-coupled, frequency modulation signal to the EXT 1 INPUT connector. The modulation signal is tested for voltage and a display annunciator will report a high or low condition if the voltage is $> \pm 3\%$ of 1 V_{pk}.

The external 1 input has multiple uses but can be used for only one modulation at a time. If, for example, you were using the external 1 input in an amplitude modulation configuration for **AM Path 1**, and then you configured **FM Path 2** to also use the external 1 input, the signal generator would turn off **AM Path 1** and assign the external 1 input to your **FM Path 2** configuration. For the purposes of this discussion, the external 1 AC-coupled input is the same as the external 1 DC-coupled source.

Softkey Location: Press **FM/ΦM**, **FM Source**, **Ext 1 AC-Coupled**

SCPI Commands:

```
[[:SOURce]:FM[1]]2:SOURce EXTernal1  
[[:SOURce]:FM[1]]2:EXTernal[1]:COUPling AC  
[[:SOURce]:FM[1]]2:EXTernal[1]:COUPling?
```

Ext 1 DC-Coupled

This softkey lets you input an external, DC-coupled, frequency modulation signal to the EXT 1 INPUT connector.

The external 1 input has multiple uses but can be used for only one modulation at a time. If, for example, you were using the external 1 input in an amplitude modulation configuration for **AM Path 1**, and then you configured **FM Path 2** to also use the external 1 input, the signal generator would turn off **AM Path 1** and assign the external 1 input to your **FM Path 2** configuration. For the purposes of this discussion, the external 1 AC-coupled input is the same as the external 1 DC-coupled source.

Softkey Location: Press **FM/ΦM**, **FM Source**, **Ext 1 DC-Coupled**

SCPI Commands:

```
[[:SOURce]:FM[1]]2:SOURce EXTernal1  
[[:SOURce]:FM[1]]2:EXTernal[1]:COUPling DC  
[[:SOURce]:FM[1]]2:EXTernal[1]:COUPling?
```

Ext 2 AC-Coupled

This softkey lets you input an external, AC-coupled, frequency modulation signal to the EXT 2 INPUT connector. The modulation signal is tested for voltage and a display annunciator will report a high or low condition if the voltage is $> \pm 3\%$ of 1 Vpk.

The external 2 input has multiple uses but can be used for only one modulation at a time. If, for example, you were using the external 2 input in an amplitude modulation configuration for **AM Path 1**, and then you configured **FM Path 2** to also use the external 2 input, the signal generator would turn off **AM Path 1** and assign the external 2 input to your **FM Path 2** configuration. For the purposes of this discussion, the external 2 AC-coupled input is the same as the external 2 DC-coupled source.

Softkey Location: Press **FM/ΦM**, **FM Source**, **Ext 2 AC-Coupled**

SCPI Commands:

```
[[:SOURce]:FM[1]|2]:SOURce EXTernal2  
[[:SOURce]:FM[1]|2]:EXTernal[2]:COUPling AC  
[[:SOURce]:FM[1]|2]:EXTernal[2]:COUPling?
```

Ext 2 DC-Coupled

This softkey lets you input an external, DC-coupled, frequency modulation signal to the EXT 2 INPUT connector.

The external 2 input has multiple uses but can be used for only one modulation at a time. If, for example, you were using the external 2 input in an amplitude modulation configuration for **AM Path 1**, and then you configured **FM Path 2** to also use the external 2 input, the signal generator would turn off **AM Path 1** and assign the external 2 input to your **FM Path 2** configuration. For the purposes of this discussion, the external 2 AC-coupled input is the same as the external 2C-coupled source.

Softkey Location: Press **FM/ΦM**, **FM Source**, **Ext 2 DC-Coupled**

SCPI Commands:

```
[[:SOURce]:FM[1]|2]:SOURce EXTernal2  
[[:SOURce]:FM[1]|2]:EXTernal[2]:COUPling DC  
[[:SOURce]:FM[1]|2]:EXTernal[2]:COUPling?
```

FM/ΦM

This softkey toggles between the menus for FM, normal ΦM, and wideband ΦM. Refer to the “Phase Modulation” section for a discussion of the differences between normal ΦM, and wideband ΦM.

Softkey Location: Press the **FM/ΦM** hardkey, then press the **FM/ΦM** softkey.

Status after Normal Preset: FM

FM Dev

Use this softkey to set the frequency modulation deviation for the **FM Path 1** and **FM Path 2** configurations. To change the value of the FM deviation, press the softkey once. The current value for FM deviation is displayed in the active entry area. To enter a new value, rotate the front panel knob until the desired value is displayed, use the up and down arrow keys, or enter the value using the numeric keypad and press the **Hz**, **kHz**, **MHz**, or **GHz** terminator softkey. The range of values allowed depends on the carrier frequency. The maximum peak deviation for a frequency is calculated by multiplying N times 10 MHz. (The following table lists the values for N and the resulting maximum peak deviations.)

Carrier Frequency	N	Maximum Peak Deviation
250 kHz to ≤ 249.999 MHz	1	10 MHz
> 249.999 MHz to ≤ 500 MHz	0.5	5 MHz
> 500 MHz to ≤ 1 GHz	1	10 MHz
> 1 GHz to ≤ 2 GHz	2	20 MHz
> 2 GHz to 4 GHz	4	40 MHz

For example, if you choose a carrier frequency of 400 MHz, multiply 0.5 times 10 MHz resulting in a 5 MHz maximum peak deviation.

Notice that the new value of FM deviation applies only to whichever FM path configuration you have currently selected. Also, whenever **FM Path 1** is used with **FM Path 2**, the deviation for **FM Path 1** must be greater than or equal to the deviation for **FM Path 2**.

Softkey Location: Press **FM/ΦM**, **FM Dev**
or press **FM/ΦM**, **More 1 of 2**, **FM Waveform**, **Dual-Sine**, **FM Dev**

Status after Normal Preset: 1 kHz

SCPI Commands:

```
[[:SOURce]:FM[1]|2]:[DEViation] <val><unit>
```

```
[[:SOURce]:FM[1]|2]:[DEViation]?
```

FM Dev Couple Off On

This softkey toggles the FM deviation coupling on and off. Turning on FM deviation coupling links the FM deviation values of **FM Path 1** and **FM Path 2**. When the values are coupled, any change you make to one FM deviation value is applied to both FM deviation values.

Softkey Location: Press **FM/ΦM, More (1 of 2) FM Dev Couple Off On**

Status after Normal Preset: Off

SCPI Commands:

```
[[:SOURce]:FM[1]|2]:[DEViation]:TRACk ON|OFF|1|0
```

```
[[:SOURce]:FM[1]|2]:[DEViation]:TRACk?
```

FM Dual-Sine Ampl Ratio

Press this softkey to set the ratio of the deviation of FM tone 2 to the deviation of FM tone 1 as a percent. The range of values allowed is 0 to 100%. The minimum increment allowed is 0.1%. The sum of the two FM deviations results in the total FM deviation (set by the **FM Dev** softkey in the initial FM Menu).

For example, if the total FM deviation is 3.0 kHz and you set **FM Dual-Sine Ampl Ratio** to 50%, then the deviation of FM tone 1 will be 2.0 kHz and the deviation of FM tone 2 will be 1.0 kHz (50% of 2.0 kHz) so that the deviation of the two tones adds up to 3.0 kHz (2.0 kHz plus 1.0 kHz).

Softkey Location: Press **FM, More (1 of 2), FM Waveform, Dual-Sine, FM Dual-Sine Ampl Ratio**

SCPI Commands:

```
[[:SOURce]:FM[1]|2]:INTernal[1]:FREQUency:ALTErnate:AMPLitude:PERCent <val><unit>
```

```
[[:SOURce]:FM[1]|2]:INTernal[1]:FREQUency:ALTErnate:AMPLitude:PERCent?
```

FM Off On

This softkey toggles the frequency modulation on or off for whichever FM path configuration (**FM Path 1** or **FM Path 2**) you have selected. Notice, however that although you can turn on frequency modulation with this softkey, the RF carrier is modulated by the enabled modulation only when you have also set **Mod On/Off** to **On**. Whenever frequency modulation is enabled, the **FM** annunciator is turned on in the display.

There are two paths for FM modulation which can be simultaneously enabled as long as they use different sources (Int, Ext1, or Ext2). **FM Path 2** is limited to a maximum rate of 1 MHz. **FM Path 2** must be set to a deviation less than or equal to **FM Path 1**. The modulation signals from both paths are summed internally for composite modulation.

Softkey Location: Press **FM/ΦM**, **FM Off On**

Status after Normal Preset: Off

SCPI Commands:

```
[[:SOURce]:FM[1]|2]:STATe ON|OFF|1|0
```

```
[[:SOURce]:FM[1]|2]:STATe?
```

FM Path 1 2

Use **FM Path 1** and **FM Path 2** to define two unique frequency modulation configurations. For example, select **FM Path 1**. (**FM Path 1** is the default after a normal preset. If **FM Path 1** is not highlighted, press the softkey until the selection toggles to **FM Path 1**.) Configure the modulation characteristics (such as deviation, source, rate, and waveform) using the remaining softkeys in the FM menu. Then enable FM by setting **FM Off On** to **On**.

To configure a second frequency modulation configuration, toggle to **FM Path 2**. Define the modulation characteristics for this second configuration and enable FM by setting **FM Off On** to **On**.

The RF carrier is available at the RF OUTPUT connector when you set **RF On/Off** to **On**. Set **Mod On/Off** to **On** to modulate the RF carrier with the modulations that you have enabled.

FM Path 1 and **FM Path 2** are summed internally for composite modulation. Either path can be switched to any one of the modulation sources: Int, Ext1, or Ext2. All modulation types can be simultaneously enabled, except FM with Φ M. AM, FM, and Φ M can sum simultaneous inputs from any two sources (Int, Ext1, and Ext2). Any given source (Int, Ext1, or Ext2) can only be routed to one activated modulation type.

Softkey Location: Press **FM/ Φ M**, **FM Path 1 2**

Status after Normal Preset: FM Path 1

FM Rate

Use this softkey to change the internal modulation frequency for the **FM Path 1** and **FM Path 2** configurations. To change the value, press the softkey once. The current value for FM rate is displayed in the active entry area. To enter a new value, rotate the front panel knob until the desired value is displayed, use the up and down arrow keys, or enter the value using the numeric keypad and press the **Hz** or **kHz** terminator softkey. The range of values allowed is 0.1 Hz to 10 kHz. (0.1 Hz to 50 kHz is the range allowed if sinewave is selected as the internal waveform.) The minimum increment allowed is 0.1 Hz. Notice that the new value of FM rate applies only to whichever FM path configuration you have currently selected.

Softkey Location: Press **FM/ΦM**, **FM Rate**

Status after Normal Preset: 400 Hz

SCPI Commands:

```
[[:SOURce]:FM[1]2:INTernal[1]:FREQuency <val><unit>
```

```
[[:SOURce]:FM[1]2:INTernal[1]:FREQuency?
```

FM Source

Pressing this softkey reveals a menu of choices for frequency modulation sources. You can choose internally-generated frequency modulation or select an externally-applied signal from either the EXT 1 INPUT or EXT 2 INPUT connectors. The internal modulation is always AC-coupled. For the externally-applied signals, you can choose between AC- and DC-coupled modulation. A 1.0 Vpk input is required for calibrated FM deviation settings. The **EXT 1 LO/HI** and **EXT 2 LO/HI** display annunciators will turn on if the peak input voltage differs from 1.0 Vpk by more than 3%. (The LO/HI annunciators only function for AC-coupled external inputs.)

The internal and external 1 and 2 sources have multiple uses. You can use them for amplitude, frequency, and phase modulation. For pulse modulation you must use the external 2 source. However, any given source can only be routed to one enabled modulation at a time. If, for example, you were using the external 1 source in a frequency modulation configuration for **FM Path 1**, and then you configured **AM Path 2** to also use the external 1 source, the signal generator would turn off **FM Path 1** and assign the external 1 source to your **AM Path 2** configuration. Notice that for these purposes the external 1 AC-coupled source is the same as the external 1 DC-coupled source and the external 2 AC-coupled source is the same as the external 2 DC-coupled source.

Softkey Location: Press **FM/ΦM**, **FM Source**

Status after Normal Preset: Internal

SCPI Commands:

[[:SOURce]:FM[1]|2]:SOURce?

FM Start Rate

Use this softkey to change the starting internal modulation frequency for swept-sine frequency modulation. To change the value, press the softkey once. The current value for the FM start rate is displayed in the active entry area. To enter a new value, rotate the front panel knob until the desired value is displayed, use the up and down arrow keys, or enter the value using the numeric keypad and press the **Hz** or **kHz** terminator softkey. The range of values allowed is 0.1 Hz to 50 kHz. The minimum increment allowed is 0.1 Hz.

This softkey is coupled to the **FM Rate** softkey in the initial FM Menu and the **FM Tone 1 Rate** softkey in the FM Dual-Sine Menu. Any value set for **FM Start Rate** is reflected in the **FM Rate** and **FM Tone 1 Rate** softkeys. Conversely, if you change the value for either the **FM Rate** softkey or the **FM Tone 1 Rate** softkey, the value for **FM Start Rate** is changed to match.

Softkey Location: Press **FM/ΦM**, **More (1 of 2)**, **FM Waveform**, **Swept-Sine**, **FM Start Rate**

Status after Normal Preset: 400.0 Hz

SCPI Commands:

```
[[:SOURce]:FM[1]|2:INTernal[1]:FREQuency <val><unit>
```

```
[[:SOURce]:FM[1]|2:INTernal[1]:FREQuency?
```

FM Stop Rate

Use this softkey to change the ending internal modulation frequency for swept-sine frequency modulation. To change the value, press the softkey once. The current value for the FM stop rate is displayed in the active entry area. To enter a new value, rotate the front panel knob until the desired value is displayed, use the up and down arrow keys, or enter the value using the numeric keypad and press the **Hz** or **kHz** terminator softkey. The range of values allowed is 0.1 Hz to 50 kHz. The minimum increment allowed is 0.1 Hz.

This softkey is coupled to the **FM Tone 2 Rate** softkey in the FM Dual-Sine Menu. Any value set for **FM Stop Rate** is reflected in the **FM Tone 2 Rate** softkey. Conversely, if you change the value for the **FM Tone 2 Rate** softkey, the value for **FM Stop Rate** is changed to match.

Softkey Location: Press **FM/ΦM**, **More (1 of 2)**, **FM Waveform**, **Swept-Sine**, **FM Stop Rate**

Status after Normal Preset: 400.0 Hz

SCPI Commands:

```
[[:SOURCE]:FM[1]|2:INTERNAL[1]:FREQUENCY:ALTERNATE <val><unit>
```

```
[[:SOURCE]:FM[1]|2:INTERNAL[1]:FREQUENCY:ALTERNATE?
```

FM Sweep Time

Press this softkey to set the sweep time for swept-sine frequency modulation. The signal generator will vary the FM rate from the specified start rate to the stop rate in the time set with this softkey. Enter the desired sweep time using the up and down arrow keys, the front panel knob, or enter a value using the numeric keypad and press the **sec** or **msec** terminator softkey. The range of values allowed is 1 ms through 65.535 s. The minimum increment allowed is 1 ms.

Softkey Location: Press **FM/ΦM**, **More (1 of 2)**, **FM Waveform**, **Swept-Sine**, **FM Sweep Time**

Status after Normal Preset: 100.0 msec

SCPI Commands:

```
[[:SOURCE]:FM[1]|2:INTERNAL[1]:SWEEP:TIME <val><unit>
```

```
[[:SOURCE]:FM[1]|2:INTERNAL[1]:SWEEP:TIME?
```

FM Sweep Trigger

Pressing this softkey reveals a menu of choices for triggering swept-sine frequency modulation. You can choose triggering that occurs immediately, triggering that is supplied by the HP-IB, triggering on either the positive or negative edge of a signal supplied to the TRIGGER IN connector, or triggering by the front panel **Trigger** key.

Softkey Location: Press **FM/ΦM, More (1 of 2), FM Waveform, Swept-Sine, FM Sweep Trigger**

Status after Normal Preset: Immediate

SCPI Commands:

```
:TRIGger[:SEquence]:SOURce?
```

FM Tone 1 Rate

Press this softkey to set the internal modulation frequency for the FM tone 1. Enter the desired rate using the up and down arrow keys, the front panel knob, or enter a value using the numeric keypad and press the **kHz** or **Hz** terminator softkey. The range of values allowed is 0.1 Hz through 50 kHz. The minimum increment allowed is 0.1 Hz.

This softkey is coupled to the **FM Rate** softkey in the initial FM Menu and the **FM Start Rate** softkey in the FM Swept-Sine Menu. Any value set for **FM Tone 1 Rate** is reflected in the **FM Rate** and **FM Start Rate** softkeys. Conversely, if you change the value for either the **FM Rate** softkey or the **FM Start Rate** softkey, the value for **FM Tone 1 Rate** is changed to match.

Softkey Location: Press **FM/ΦM, More (1 of 2), FM Waveform, Dual-Sine, FM Tone 1 Rate**

Status after Normal Preset: 400.0 Hz

SCPI Commands:

```
[:SOURce]:FM[1]|2:INTernal[1]:FREQuency <val><unit>
```

```
[:SOURce]:FM[1]|2:INTernal[1]:FREQuency?
```

FM Tone 2 Rate

Press this softkey to set the internal modulation frequency for the FM tone 2. Enter the desired rate using the up and down arrow keys, the front panel knob, or enter a value using the numeric keypad and press the **kHz** or **Hz** terminator softkey. The range of values allowed is 0.1 Hz through 50 kHz. The minimum increment allowed is 0.1 Hz.

This softkey is coupled to the **FM Stop Rate** softkey in the FM Swept-Sine Menu. Any value set for **FM Tone 2 Rate** is reflected in the **FM Stop Rate** softkey. Conversely, if you change the value for the **FM Stop Rate** softkey, the value for **FM Tone 2 Rate** is changed to match.

Softkey Location: Press **FM/ΦM**, **More (1 of 2)**, **FM Waveform**, **Dual-Sine**, **FM Tone 2 Rate**

Status after Normal Preset: 400.0 Hz

SCPI Commands:

```
[[:SOURce]:FM[1]]2:INTernal[1]:FREQuency:ALTernate <val><unit>
```

```
[[:SOURce]:FM[1]]2:INTernal[1]:FREQuency:ALTernate?
```

FM Waveform

Pressing this softkey reveals a menu of FM waveform choices for your **FM Path 1** and **FM Path 2** configurations. Select from sine, triangle, square, ramp, noise, dual-sine, and swept-sine waveforms. Notice that your waveform selection applies only to which ever FM path configuration you have currently selected.

Softkey Location: Press **FM/ΦM**, **More (1 of 2)**, **FM Waveform**

Status after Normal Preset: Sine

SCPI Commands:

```
[[:SOURce]:FM[1]]2:INTernal[1]:FUNctIon:SHAPE?
```

Immediate

This softkey is one of the choices in the FM Sweep Trigger menu. Choosing **Immediate** immediately triggers swept-sine frequency modulation in a continuous mode. To stop the sweep, choose a different trigger such as **Ext**, or set the waveform to something other than **Swept-Sine**.

Softkey Location: Press **FM/ΦM**, **More (1 of 2)**, **FM Waveform**, **Swept-Sine**, **FM Sweep Trigger**, **Immediate**

Status after Normal Preset: FM sweep trigger is set to Immediate

SCPI Commands:

```
[[:SOURce]:FM[1]2:INTernal[1]:SWEep:TRIGger IMMEDIATE
```

```
[[:SOURce]:FM[1]2:INTernal[1]:SWEep:TRIGger?
```

Internal

This softkey lets you internally generate an AC-coupled, frequency modulation signal.

The internal source has multiple uses but can be used for only one modulation at a time. If, for example you were using the internal source in an amplitude modulation configuration for **AM Path 1**, and then you configured **FM Path 2** to also use the internal source, the signal generator would turn off **AM Path 1** and assign the internal source to your **FM Path 2** configuration.

Softkey Location: Press **FM/ΦM**, **FM Source**, **Internal**

SCPI Commands:

```
[[:SOURce]:FM[1]2:SOURce INT[1]
```

```
[[:SOURce]:FM[1]2:SOURce?
```

Noise

This softkey lets you specify noise as the frequency modulation waveform for the **FM Path 1** and **FM Path 2** configurations. Notice that the selected waveform applies only to whichever FM path configuration you have currently selected.

Softkey Location: Press **FM/ΦM, More (1 of 2), FM Waveform, Noise**

SCPI Commands:

```
[[:SOURCE]:FM[1]|2:INTERNAL[1]:FUNCTION:SHAPE NOISE
```

```
[[:SOURCE]:FM[1]|2:INTERNAL[1]:FUNCTION:SHAPE?
```

Ramp

This softkey lets you specify ramp as the frequency modulation waveform for the **FM Path 1** and **FM Path 2** configurations. Notice that the selected waveform applies only to whichever FM path configuration you have currently selected.

Softkey Location: Press **FM/ΦM, More (1 of 2), FM Waveform, Ramp**

SCPI Commands:

```
[[:SOURCE]:FM[1]|2:INTERNAL[1]:FUNCTION:SHAPE RAMP
```

```
[[:SOURCE]:FM[1]|2:INTERNAL[1]:FUNCTION:SHAPE?
```

Sine

This softkey lets you specify sine as the frequency modulation waveform for the **FM Path 1** and **FM Path 2** configurations. Notice that the selected waveform applies only to whichever FM path configuration you have currently selected.

Softkey Location: Press **FM/ΦM, More (1 of 2), FM Waveform, Sine**

SCPI Commands:

```
[[:SOURCE]:FM[1]|2:INTERNAL[1]:FUNCTION:SHAPE SINE
```

```
[[:SOURCE]:FM[1]|2:INTERNAL[1]:FUNCTION:SHAPE?
```

Square

This softkey lets you specify square as the frequency modulation waveform for the **FM Path 1** and **FM Path 2** configurations. Notice that the selected waveform applies only to whichever FM path configuration you have currently selected.

Softkey Location: Press **FM/ΦM, More (1 of 2), FM Waveform, Square**

SCPI Commands:

```
[[:SOURce]:FM[1]|2:INTernal[1]:FUNction:SHAPE SQUARE
```

```
[[:SOURce]:FM[1]|2:INTernal[1]:FUNction:SHAPE?
```

Swept-Sine

Pressing this softkey reveals a menu of choices for setting the swept-sine frequency modulation parameters. In this menu you can set the start and stop FM rate and the sweep time. You can set the signal generator to a single, externally-triggered sweep on either a negative or positive TTL level or you can choose continuous sweep, triggered immediately. In this menu you can also select either a positive or negative polarity for the TRIGGER OUT signal.

Softkey Location: Press **FM/ΦM, More (1 of 2), FM Waveform, Swept-Sine**

SCPI Commands:

```
[[:SOURce]:FM[1]|2:INTernal[1]:FUNction:SHAPE SWEPTSine
```

```
[[:SOURce]:FM[1]|2:INTernal[1]:FUNction:SHAPE?
```

Triangle

This softkey lets you specify triangle as the frequency modulation waveform for the **FM Path 1** and **FM Path 2** configurations. Notice that the selected waveform applies only to whichever FM path configuration you have currently selected.

Softkey Location: Press **FM/ΦM, More (1 of 2), FM Waveform, Triangle**

SCPI Commands:

```
[[:SOURce]:FM[1]|2:INTernal[1]:FUNction:SHAPE TRIangle
```

```
[[:SOURce]:FM[1]|2:INTernal[1]:FUNction:SHAPE?
```

Trigger In Polarity Neg Pos

Press this softkey to toggle between a negative TTL level trigger (0 V) and a positive TTL level trigger (+5 V) for externally triggering swept-sine frequency modulation.

This softkey is coupled to the **Trigger In Polarity Neg Pos** softkey for swept-sine AM, Φ M, and LF Out, and to the **Ext Neg** and **Ext Pos** sweep trigger selections in the Sweep/List Menu. If you set the **Trigger In Polarity Neg Pos** softkey in the FM Swept-Sine Menu to **Neg**, the **Trigger In Polarity Neg Pos** softkey is also set to **Neg** for swept-sine AM, Φ M, and LF Out. And, in addition, if the step or list sweep trigger is set to **Ext Pos**, the trigger selection will automatically be changed to **Ext Pos**. The same softkeys will toggle to **Pos** or to **Ext Pos** if you select **Pos** in the Swept-Sine FM Menu.

Conversely, if the **Trigger In Slope Neg Pos** softkey is toggled in the swept-sine AM, Φ M, or LF Out menus, it will cause the swept-sine FM softkey to toggle also. This is also true for the **Ext Neg** and **Ext Pos** step or list sweep trigger selections.

Softkey Location: Press **FM/ Φ M, More (1 of 2), FM Waveform, Swept-Sine, Trigger In Polarity Neg Pos**

Status after Normal Preset: Pos

SCPI Commands:

:TRIGger[:SEQuence]:SLOPe POSitive|NEGative

:TRIGger[:SEQuence]:SLOPe?

Trigger Key

This softkey is one of the choices in the FM Sweep Trigger menu. With **Trigger Key** selected, when you press the **Trigger** front panel key you immediately trigger a single sweep of swept-sine frequency modulation.

The **Trigger** key has autorepeat capability. Hold it down and you will repeatedly trigger sweeps until you release the key.

Softkey Location: Press **FM/ΦM**, **More (1 of 2)**, **FM Waveform**, **Swept-Sine**, **FM Sweep Trigger**, **Trigger Key**

Status after Normal Preset: FM sweep trigger is set to Immediate

SCPI Commands:

```
[[:SOURce]:FM[1]]2:INTernal[1]:SWEep:TRIGger KEY
```

```
[[:SOURce]:FM[1]]2:INTernal[1]:SWEep:TRIGger?
```

Trigger Out Polarity Neg Pos

This softkey toggles the polarity of the TTL signal that is output at the rear panel TRIGGER OUT connector. When **Trigger Out Polarity Neg Pos** is set to **Pos**, the output signal is asserted high (+5 V) at the start of the swept-sine frequency modulation sweep and low (0 V) when the sweep is concluded. Setting **Trigger Out Polarity Neg Pos** to **Neg** reverses the polarity, where a high is 0 V and a low is +5 V.

This softkey is coupled to the **Trigger Out Polarity Neg Pos** softkey in the swept-sine AM, ΦM, and LF Out menus and the sweep/list menu. When the polarity is toggled for this softkey in any one of these menus, it affects all locations of the softkey.

Softkey Location: Press **FM/ΦM**, **More (1 of 2)**, **FM Waveform**, **Swept-Sine**, **Trigger Out Polarity Neg Pos**

Status after Normal Preset: Pos

SCPI Commands:

```
:TRIGger:OUTPut:POLarity POSitive|NEGative
```

```
:TRIGger:OUTPut:POLarity?
```

Freq

Pressing the front panel **Freq** key reveals a menu of softkeys. These softkeys are described in this section in alphabetical order.

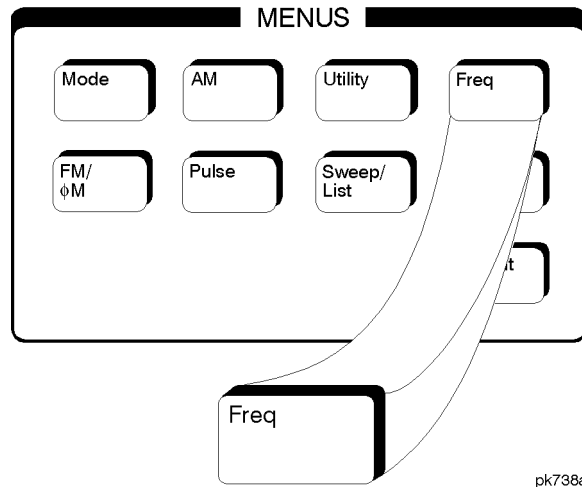

Adjust Phase

Use this softkey to change the phase of the RF OUTPUT signal. You can change the phase relative to whatever phase the signal generator locked to the last time it changed frequency. For this reason, the phase adjustment does not survive changes in frequency and must be readjusted. If you first press **Phase Ref Set**, the current output phase is set as a zero reference and any subsequent phase adjustment is displayed as relative to the zero reference. Phase adjustment cannot be used with frequency or phase modulation.

To change the phase, press the softkey once. Phase adjustment becomes the active function. To enter a new value, rotate the front panel knob until the desired value is displayed, use the up and down arrow keys, or enter the value using the numeric keypad and press the **rad** or **deg** terminator softkey. The range of values allowed is ± 3.141 radians or ± 180 degrees.

Softkey Location: Press **Freq, Adjust Phase**

Status after Normal Preset: 0 radians

SCPI Commands:

```
[[:SOURce]:PHASe:[ADJust] <val><unit>
```

```
[[:SOURce]:PHASe:[ADJust]?
```

Freq Multiplier

You can multiply the frequency shown on the display without changing the frequency output at the RF OUTPUT connector (simulating the frequency at the output of a harmonic multiplier). Press this softkey and enter a value from 1 through 50. Use the up and down arrow keys, the front panel knob, or enter a value using the numeric keypad and press the **Enter** terminator softkey. For example, set the output frequency to 1 MHz. Then press **Freq, Freq Multiplier, 3, Enter**. The display will now show an output frequency of 3 MHz but the actual output frequency will remain at 1 MHz. For any multiplier greater than 1, the **MULT** indicator is shown in the frequency area of the display.

Softkey Location: Press **Freq, Freq Multiplier**

Status after Normal Preset: 1

SCPI Commands:

```
[[:SOURce]:FREQuency:MULTiplier <val>
```

```
[[:SOURce]:FREQuency:MULTiplier?
```

Freq Offset

Press this softkey to set a value for frequency offset. A frequency offset changes the value shown in the frequency area of the display but does not affect the output frequency. For example, if the current output frequency is 1 MHz and you enter a frequency offset of 3 MHz, the output frequency will remain at 1 MHz but the display will show a frequency of 4 MHz. This feature lets you simulate the frequency at the output of a frequency translating device.

A frequency offset can be entered at any time during normal operation and also when you are operating in frequency reference mode. To enter an offset, press **Freq Offset** and enter the desired frequency value using the up and down arrow keys, the front panel knob, or enter a value using the numeric keypad and press the **Hz**, **kHz**, **MHz**, or **GHz** terminator softkey. When an offset has been entered, the **OFFSET** indicator is turned on in the frequency area of the display.

Softkey Location: Press **Freq**, **Freq Offset**

Status after Normal Preset: 0 Hz

SCPI Commands:

```
[[:SOURce]:FREQuency:OFFSet <val><unit>
```

```
[[:SOURce]:FREQuency:OFFSet?
```

Freq Ref Off On

This softkey toggles the frequency reference mode on and off. When frequency reference mode is turned on, the frequency value displayed is equal to the current hardware output frequency minus the reference value set by the **Freq Ref Set** softkey. (The **Freq Ref Set** softkey sets the reference value equal to the current output frequency. If you have not yet set the reference value, the preset value for frequency reference is 0 Hz.) The **REF** indicator is turned on in the frequency area of the display. All frequency parameters will now be set as relative to the reference value.

Frequency offsets can be used with frequency reference mode. In this situation, the display will show the frequency calculated as the current hardware output frequency minus the reference value plus the frequency offset.

Frequency reference mode only changes the display; it does not change the RF output frequency. For example, if you set your RF output frequency to 700 MHz, set your reference value, and then turn frequency relative mode on, your display shows your frequency as 0 Hz but your output frequency remains at 700 MHz.

Softkey Location: Press **Freq**, **Freq Ref Off On**

Status after Normal Preset: Off

SCPI Commands:

```
[[:SOURce]:FREQuency:REFerence:STATe ON|OFF|1|0
```

```
[[:SOURce]:FREQuency:REFerence:STATe?
```

Freq Ref Set

This softkey sets the current output frequency as a frequency reference value. It also causes the **Freq Ref Off On** softkey to toggle to the **On** position, turning on frequency reference mode. All frequency parameters are then set as relative to the reference value.

Softkey Location: Press **Freq**, **Freq Ref Set**

Status after Normal Preset: Off

SCPI Commands:

```
[[:SOURce]:FREQuency:REFerence <val><unit>
```

```
[[:SOURce]:FREQuency:REFerence?
```

Mode 1 Optimize <10kHz Offset

Press this softkey to set the signal generator to mode 1 which optimizes phase noise at offsets below 10 kHz.

Softkey Location: Press **Freq, Optimize Φ Noise, Mode 1 Optimize <10kHz Offset**

SCPI Commands:

`[:SOURce]:FREQuency:SYNThesis 1`

`[:SOURce]:FREQuency:SYNThesis?`

Mode 2 Optimize >10kHz Offset

Press this softkey to set the signal generator to mode 2 which optimizes phase noise at offsets above 10 kHz.

Softkey Location: Press **Freq, Optimize Φ Noise, Mode 2 Optimize >10kHz Offset**

SCPI Commands:

`[:SOURce]:FREQuency:SYNThesis 2`

`[:SOURce]:FREQuency:SYNThesis?`

Optimize Φ Noise

Press this softkey for two choices in optimizing phase noise. You can choose to set the phase-lock loop bandwidth to optimize phase noise for offsets below or above 10 kHz offsets as shown in Figure 5-1.

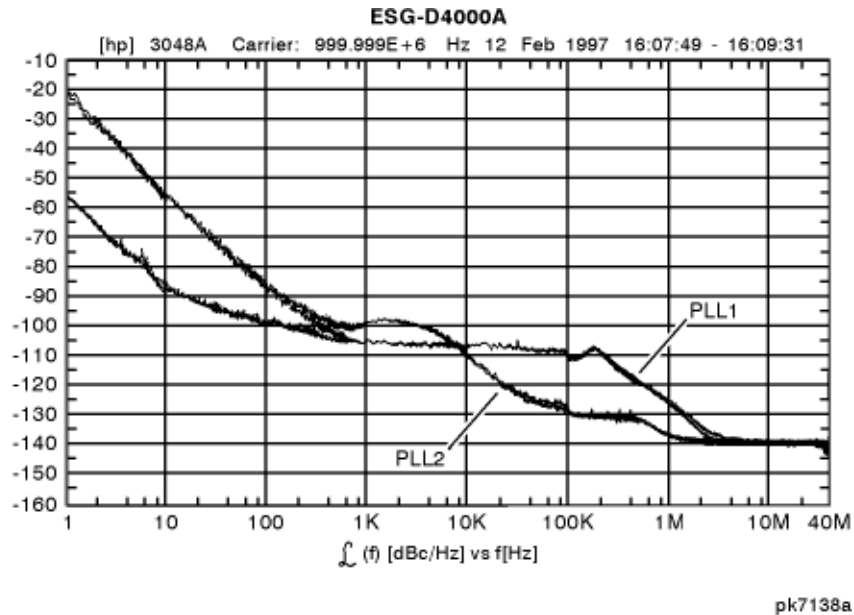

Figure 5-1. Phase Noise Performance Mode 1 Versus Mode 2

Softkey Location: Press **Freq**, **Optimize Φ Noise**

Status after Normal Preset: Mode 2

Phase Ref Set

This softkey sets the current output phase as a zero reference. All phase parameters are then set as relative to the zero reference.

Softkey Location: Press **Freq**, **Phase Ref Set**

SCPI Commands:

[[:SOURce]:]PHASe:REFerence

Frequency

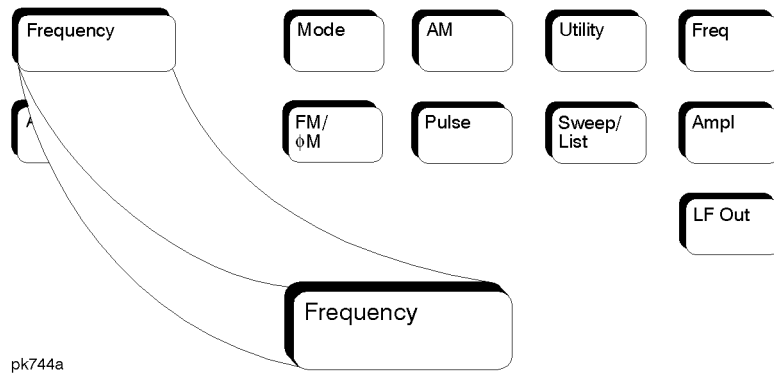

pk744a

Press this front panel hardkey to change the RF output frequency. Frequency becomes the active function and the current value is also shown in the active entry area of the display. To enter a new value for frequency, rotate the front panel knob until the desired value is displayed, use the up and down arrow keys, or enter the value using the numeric keypad and press the **GHz**, **MHz**, **kHz**, or **Hz** terminator softkey. The output frequency range allowed depends on your instrument model. Refer to Chapter 9, “Specifications.”

The current RF output frequency is always shown in the frequency area of the display (unless you have altered the display by turning on frequency reference mode or entering an offset or a multiplier). The frequency area of the display is blanked whenever a frequency sweep is selected.

Status after Normal Preset: Maximum specified output frequency

SCPI Commands:

```
[ :SOURce]:FREQuency[:CW] <val><unit>
[:SOURce]:FREQuency[:CW]?
[:SOURce]:FREQuency:FIXed <val><unit>
[:SOURce]:FREQuency:FIXed?
[:SOURce]:FREQuency:MODE CW|FIXed
[:SOURce]:FREQuency:MODE?
```

Hardkey and Softkey Reference
Frequency

Help

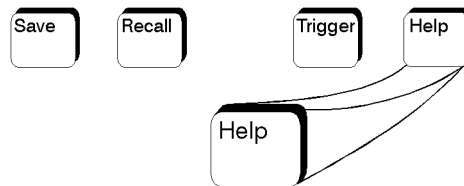

pk754a

Press this hardkey for a short description of the function of any front panel hardkey or softkey. When you press the **Help** key, the following message is displayed:

Press a key for help on that key.

Press a front panel hardkey or a softkey and a short description of that key's function will be displayed. Press another key and you will be returned to normal instrument operation.

The **Help** key can be set to either single or continuous mode. In single mode, when you press the **Help** key, help text is provided only for the next key that you press and then you are returned to normal operation. In continuous mode, when you press the **Help** key, help text is provided for the next key that you press and that key's function is also executed (except for the **Preset** key). This help mode remains active until you press the **Help** key again.

Refer to the description of the **Help Mode** softkey in the **Utility** section for instructions on changing the help mode from single to continuous.

Hold

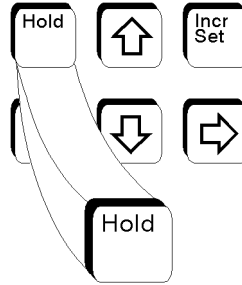

pk748a

Press this front panel hardkey to de-activate the current active function and blank the softkey menu. Once **Hold** is pressed, the front panel knob, the arrow keys, and the numeric keypad have no effect.

To return to normal operation, press any front panel hardkey.

Hardkey and Softkey Reference
Hold

Incr Set

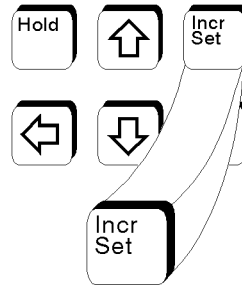

pk749a

Press this front panel hardkey to change the incremental value of the up and down arrow keys for the current active function. For example, press **Frequency** to make it the active function. The current frequency is shown in the active entry area. The incremental value for frequency is set to 1 MHz at the factory. Press **Incr Set** and the incremental value of the up and down arrow keys for frequency becomes the active function. You can change the value by using three different methods:

- Use the up and down arrow keys.
The arrow keys will change the incremental value in steps equal to the current incremental value (in this example, these are 1 MHz steps.)
- Use the front panel knob.
- Use the numeric keypad and complete your entry with a terminator softkey.

Press **Incr Set** again and the active function toggles, making frequency the active function again.

Incremental values are persistent states; they are not affected by an instrument preset or by a power cycle.

Hardkey and Softkey Reference
Incr Set

LF Out

Pressing the front panel **LF Out** key reveals a menu of softkeys for configuring the internal low frequency generator. These softkeys are described in this section in alphabetical order.

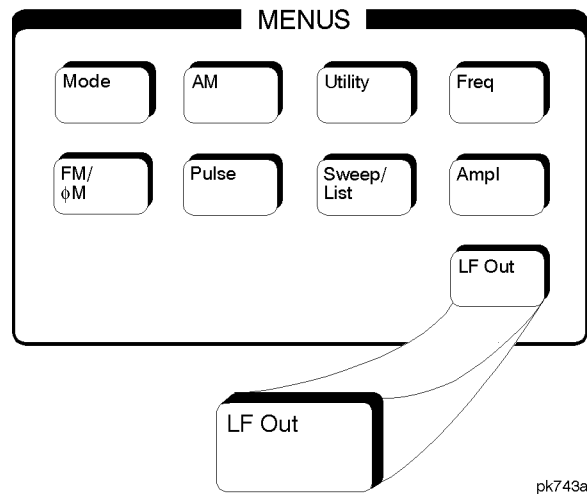

Bus

This softkey is one of the choices in the LF Out Sweep Trigger menu. With **Bus** selected, you use the HP-IB to trigger single sweeps of swept-sine low frequency output.

Softkey Location: Press **LF Out**, **LF Out Source**, **Function Generator**, **LF Out Waveform**, **Swept-Sine**, **LF Out Sweep Trigger**, **Bus**

Status after Normal Preset: LF out sweep trigger is set to Immediate

SCPI Commands:

```
[[:SOURce]:LFOutput:FUNCTion:SWEEp:TRIGger BUS
```

```
[[:SOURce]:LFOutput:FUNCTion:SWEEp:TRIGger?
```

DC

This softkey lets you specify DC as the waveform for the LF output signal.

This softkey is only active when you have selected the internal source to operate as a function generator.

Softkey Location: Press **LF Out**, **LF Out Source**, **Function Generator**, **LF Out Waveform**, **More 1 of 2**, **DC**

Status after Normal Preset: LF Out Waveform is set to DC

SCPI Commands:

```
[[:SOURce]:LFOutput:FUNCtion:SHAPE DC
```

```
[[:SOURce]:LFOutput:FUNCtion:SHAPE?
```

Dual-Sine

Pressing this softkey reveals a menu of choices for setting the dual-sine low frequency output parameters. In this menu you can set the frequencies for two separate tones. In addition you can set a ratio of the tone 2 LF amplitude to the tone 1 LF amplitude.

Softkey Location: Press **LF Out**, **LF Out Source**, **Function Generator**, **LF Out Waveform**, **Dual-Sine**

SCPI Commands:

```
[[:SOURce]:LFOutput:FUNCtion:SHAPE DUALsine
```

```
[[:SOURce]:LFOutput:FUNCtion:SHAPE?
```

Ext

This softkey is one of the choices in the LF Output Sweep Trigger menu. Choosing **Ext** allows you to trigger swept-sine low frequency output using the signal applied to the TRIGGER IN rear panel connector. Set the polarity of the trigger signal using the **Trigger In Polarity Neg Pos** softkey.

Softkey Location: Press **LF Out**, **LF Out Source**, **Function Generator**, **LF Out Waveform**, **Swept-Sine**, **LF Out Sweep Trigger**, **Ext**

Status after Normal Preset: LF output sweep trigger is set to Immediate

SCPI Commands:

```
[[:SOURce]:LFOutput:FUNCTION:SWEEP:TRIGGER EXTernal
```

```
[[:SOURce]:LFOutput:FUNCTION:SWEEP:TRIGGER?
```

Function Generator

This softkey lets you set the **LF Out Source** to be a function generator. You can select a frequency and shape in addition to selecting the amplitude for a signal that is output at the LF OUTPUT front panel connector. When you use the internal source in this capacity, any modulation with the internal source selected is turned off.

Softkey Location: Press **LF Out**, **LF Out Source**, **Function Generator**

Status after Normal Preset: LF Out Source is set to Internal Modulation

SCPI Commands:

```
[[:SOURce]:LFOutput:SOURce FUNCTION
```

```
[[:SOURce]:LFOutput:SOURce?
```

Immediate

This softkey is one of the choices in the LF Output Sweep Trigger menu. Choosing **Immediate** immediately triggers swept-sine low frequency output in a continuous mode. To stop the sweep, choose a different trigger such as **Ext**, or set the waveform to something other than **Swept-Sine**.

Softkey Location: Press **LF Out**, **LF Out Source**, **Function Generator**, **LF Out Waveform**, **Swept-Sine**, **LF Output Sweep Trigger**, **Immediate**

Status after Normal Preset: LF output sweep trigger is set to Immediate

SCPI Commands:

```
[[:SOURce]:LFOutput:FUNCTION:SWEEP:TRIGGER IMMEDIATE
```

```
[[:SOURce]:LFOutput:FUNCTION:SWEEP:TRIGGER?
```

Internal

This softkey lets you output a signal at the LF OUTPUT connector where the frequency and shape of the signal is set by the internal source as it is being used by a modulation. For example, if the internal source is currently assigned to an AM path configuration and AM is turned on, the signal output at the LF OUTPUT connector will have the frequency and shape of the amplitude modulating signal. You can scale the amplitude of the output signal using the **LF Out Amplitude** softkey.

For internal square pulse modulation, the internal source is a sinewave which is later squared by the modulator to generate the pulse squarewave. The LF OUTPUT signal for this internal source, therefore, is a sinewave. For internal pulse modulation, a true variable-width pulse will be seen on the LF OUTPUT.

Softkey Location: Press **LF Out**, **LF Out Source**, **Internal Modulation**

Status after Normal Preset: LF Out Source is set to Internal Modulation

SCPI Commands:

```
[[:SOURce]:LFOutput:SOURce INT[1]
```

```
[[:SOURce]:LFOutput:SOURce?
```

LF Out Amplitude

Use this softkey to scale the output of the signal at the LF OUTPUT connector. To change the value, press the softkey once. The current value for LF output amplitude is displayed in the active entry area. To enter a new value, rotate the front panel knob until the desired value is displayed, use the up and down arrow keys, or enter the value using the numeric keypad and press the **V**, or **mV** terminator softkey. The range of values allowed is 0 to 5 Vpk in increments from 1 mV to 5 V.

Softkey Location: Press **LF Out**, **LF Out Amplitude**

Status after Normal Preset: 0V

SCPI Commands:

```
[[:SOURce]:LFOutput:AMPLitude <val><unit>
```

```
[[:SOURce]:LFOutput:AMPLitude?
```

LF Out Freq

Use this softkey to set the modulating frequency for the LF output signal when you have selected the internal source as a function generator. To change the frequency, press the softkey once. The current modulating frequency is displayed in the active entry area. To enter a new frequency, rotate the front panel knob until the desired value is displayed, use the up and down arrow keys, or enter the value using the numeric keypad and press the **Hz** or **kHz** terminator softkey. The range of frequencies allowed is 0.1 Hz to 10 kHz. (0.1 Hz to 50 kHz is the range allowed if sinewave is selected as the internal waveform.)

This softkey is only active when you have selected the internal source to operate as a function generator.

Softkey Location: Press **LF Out**, **LF Out Source**, **Function Generator**, **LF Out Freq**

Status after Normal Preset: 400 Hz

SCPI Commands:

```
[[:SOURce]:LFOutput:FUNCTION:FREQuency <val><unit>
```

```
[[:SOURce]:LFOutput:FUNCTION:FREQuency?
```

LF Out Off On

This softkey toggles on and off the output of the selected source at the LF OUTPUT front panel connector. You can choose either the modulation signal generated by the internal source or you can use the low frequency source as a function generator and select that signal to output at the LF OUTPUT connector. Refer to the description of the **LF Out Source** softkey in this section for more information on choosing the source.

Once you have toggled this state on, the signal is immediately available at the LF OUTPUT connector. The **Mod On/Off** and **RF On/Off** keys do not apply to this state.

Softkey Location: Press **LF Out**, **LF Out Off On**

Status after Normal Preset: Off

SCPI Commands:

```
[[:SOURce]:LFOOutput:STATe ON|OFF]1|0
```

```
[[:SOURce]:LFOOutput:STATe?
```

LF Out Period

Use this softkey to change the pulse period for the pulsed low frequency waveform. To change the period, press the softkey once. The current value for pulse period is displayed in the active entry area. To enter a new value, rotate the front panel knob until the desired value is displayed, use the up and down arrow keys, or enter the value using the numeric keypad and press the **μsec** or **msec** terminator softkey. The range of values allowed is from 16 μs to 30 s. If you set the pulse period to a smaller value than the pulse width, an error message will be generated and the pulse width will be reduced to the value of the pulse period.

This softkey is only active when you have selected the internal source to operate as a function generator and when the LF Out waveform is specified as pulse.

Softkey Location: Press **LF Out**, **LF Out Source**, **Function Generator**, **LF Out Waveform**, **More 1 of 2**, **Pulse**, **LF Out Period**

Status after Normal Preset: 80 μs

SCPI Commands:

```
[[:SOURce]:LFOOutput:FUNCTion:PERiod <val><unit>
```

```
[[:SOURce]:LFOOutput:FUNCTion:PERiod?
```

LF Out Source

Pressing this softkey reveals a menu of choices for LF output sources. You can choose to output the signal from the internal source as it is being used by a modulation or you can use the internal source as a function generator and select that signal to output at the LF OUTPUT connector.

If you choose the internal source, the frequency and shape of the signal at the LF OUTPUT connector is set by the internal source as it is being used by a modulation. For example, if the internal source is currently assigned to an AM path configuration and AM is turned on, the signal output at the LF OUTPUT connector will have the frequency and shape of the amplitude modulating signal. You can scale the amplitude of the output signal using the **LF Out Amplitude** softkey.

If you choose to set the internal source as a function generator, you can select a frequency and shape in addition to selecting the amplitude for the LF output signal. When you use the internal source in this capacity, any modulation with the internal source selected is turned off.

Softkey Location: Press **LF Out**, **LF Out Source**

Status after Normal Preset: Internal Modulation

SCPI Commands:

`[:SOURce]:LFOutput:SOURce?`

LF Out Start Freq

Use this softkey to change the starting frequency for swept-sine low frequency output. To change the value, press the softkey once. The current value for the LF Out start frequency is displayed in the active entry area. To enter a new value, rotate the front panel knob until the desired value is displayed, use the up and down arrow keys, or enter the value using the numeric keypad and press the **Hz** or **kHz** terminator softkey. The range of values allowed is 0.1 Hz to 50 kHz. The minimum increment allowed is 0.1 Hz.

This softkey is coupled to the **LF Out Freq** softkey in the initial LF Out Menu and the **LF Out Tone 1 Freq** softkey in the LF Out Dual-Sine Menu. Any value set for **LF Out Start Freq** is reflected in the **LF Out Freq** and **LF Out Tone 1 Freq** softkeys. Conversely, if you change the value for either the **LF Out Freq** softkey or the **LF Out Tone 1 Freq** softkey, the value for **LF Out Start Freq** is changed to match.

This softkey is only active when you have selected the internal source to operate as a function generator.

Softkey Location: Press **LF Out**, **LF Out Source**, **Function Generator**, **LF Out Waveform**, **Swept-Sine**, **LF Out Start Freq**

Status after Normal Preset: 400.0 Hz

SCPI Commands:

```
[[:SOURce]:LFOutput:FUNCtion:FREQuency <val><unit>  
[:SOURce]:LFOutput:FUNCtion:FREQuency?
```

LF Out Stop Freq

Use this softkey to change the ending frequency for swept-sine low frequency output. To change the value, press the softkey once. The current value for the LF Out stop frequency is displayed in the active entry area. To enter a new value, rotate the front panel knob until the desired value is displayed, use the up and down arrow keys, or enter the value using the numeric keypad and press the **Hz** or **kHz** terminator softkey. The range of values allowed is 0.1 Hz to 50 kHz. The minimum increment allowed is 0.1 Hz.

This softkey is coupled to the **LF Out Tone 2 Freq** softkey in the LF Out Dual-Sine Menu. Any value set for **LF Out Stop Freq** is reflected in the **LF Out Tone 2 Freq** softkey. Conversely, if you change the value for the **LF Out Tone 2 Freq** softkey, the value for **LF Out Stop Freq** is changed to match.

This softkey is only active when you have selected the internal source to operate as a function generator.

Softkey Location: Press **LF Out**, **LF Out Source**, **Function Generator**, **LF Out Waveform**, **Swept-Sine**, **LF Out Stop Freq**

Status after Normal Preset: 400.0 Hz

SCPI Commands:

```
[[:SOURce]:LFOutput:FUNCtion:FREQuency:ALTerNate <val><unit>
```

```
[[:SOURce]:LFOutput:FUNCtion:FREQuency:ALTerNate?
```

LF Out Sweep Time

Press this softkey to set the sweep time for low frequency swept-sine output. The signal generator will sweep from the specified start frequency to the stop frequency in the time set with this softkey. Enter the desired sweep time using the up and down arrow keys, the front panel knob, or enter a value using the numeric keypad and press the **sec** or **msec** terminator softkey. The range of values allowed is 1 ms through 65.535 s. The minimum increment allowed is 1 ms.

This softkey is only active when you have selected the internal source to operate as a function generator.

Softkey Location: Press **LF Out**, **LF Out Source**, **Function Generator**, **LF Out Waveform**, **Swept-Sine**, **LF Out Sweep Time**

Status after Normal Preset: 100.0 msec

SCPI Commands:

```
[[:SOURce]:LFOutput:FUNCTion:SWEEp:TIME <val><unit>
```

```
[[:SOURce]:LFOutput:FUNCTion:SWEEp:TIME?
```

LF Out Sweep Trigger

Pressing this softkey reveals a menu of choices for triggering swept-sine low frequency output. You can choose triggering that occurs immediately, triggering that is supplied by the HP-IB, triggering on either a positive or negative level of a signal supplied to the TRIGGER IN connector, or triggering by the front panel **Trigger** key.

Softkey Location: Press **LF Out**, **LF Out Source**, **Function Generator**, **LF Out Waveform**, **Swept-Sine**, **LF Out Sweep Trigger**

Status after Normal Preset: Immediate

SCPI Commands:

```
[[:SOURce]:LFOutput:FUNCTion:SWEEp:TRIGger IMMEDIATE|BUS|EXTERNAL|KEY
```

```
[[:SOURce]:LFOutput:FUNCTion:SWEEp:TRIGger?
```

LF Out Tone 1 Freq

Press this softkey to set the frequency for the LF Out tone 1. Enter the desired frequency using the up and down arrow keys, the front panel knob, or enter a value using the numeric keypad and press the **kHz** or **Hz** terminator softkey. The range of values allowed is 0.1 Hz through 50 kHz. The minimum increment allowed is 0.1 Hz.

This softkey is coupled to the **LF Out Freq** softkey in the initial LF Out Menu and the **LF Out Start Freq** softkey in the LF Out Swept-Sine Menu. Any value set for **LF Out Tone 1 Freq** is reflected in the **LF Out Freq** and **LF Out Start Freq** softkeys. Conversely, if you change the value for either the **LF Out Freq** softkey or the **LF Out Start Freq** softkey, the value for **LF Out Tone 1 Freq** is changed to match.

This softkey is only active when you have selected the internal source to operate as a function generator.

Softkey Location: Press **LF Out**, **LF Out Source**, **Function Generator**, **LF Out Waveform**, **Dual-Sine**, **LF Out Tone 1 Freq**

Status after Normal Preset: 400.0 Hz

SCPI Commands:

```
[[:SOURce]:LFOutput:FUNCtion:FREQuency <val><unit>
```

```
[[:SOURce]:LFOutput:FUNCtion:FREQuency?
```

LF Out Tone 2 Ampl % Of Peak

Press this softkey to set the ratio of the peak amplitude of LF Out tone 2 to the peak amplitude of LF Out as a percent. The range of values allowed is 0 to 100%. The minimum increment allowed is 0.1%. The sum of the two LF Out amplitudes results in the total LF Out amplitude (set by the **LF Out Amplitude** softkey in the initial LF Out Menu).

For example, if the total LF Out amplitude is 300 mVp and you set **LF Out Tone 2 Ampl % Of Peak** to 33%, then the amplitude of LF Out tone 1 will be 200 mVp and the amplitude of LF Out tone 2 will be 100 mVp (33% of 300 mVp) so that the amplitude of the two tones adds up to 300 mVp (200 mVp plus 100 mVp).

This softkey is only active when you have selected the internal source to operate as a function generator.

Softkey Location: Press **LF Out**, **LF Out Source**, **Function Generator**, **LF Out Waveform**, **Dual-Sine**, **LF Out Tone 2 Ampl % Of Peak**

SCPI Commands:

```
[[:SOURce]:LFOutput:FUNcTION:FREQuency:ALTErnate:AMPLitude:PERCent  
<val><unit>
```

```
[[:SOURce]:LFOutput:FUNcTION:FREQuency:ALTErnate:AMPLitude:PERCent?
```

LF Out Tone 2 Freq

Press this softkey to set the frequency for the LF Out tone 2. Enter the desired frequency using the up and down arrow keys, the front panel knob, or enter a value using the numeric keypad and press the **kHz** or **Hz** terminator softkey. The range of values allowed is 0.1 Hz through 50 kHz. The minimum increment allowed is 0.1 Hz.

This softkey is coupled to the **LF Out Freq** softkey in the initial LF Out Menu and the **LF Out Stop Freq** softkey in the LF Out Swept-Sine Menu. Any value set for **LF Out Tone 2 Freq** is reflected in the **LF Out Freq** and **LF Out Stop Freq** softkeys. Conversely, if you change the value for either the **LF Out Freq** softkey or the **LF Out Stop Freq** softkey, the value for **LF Out Tone 2 Freq** is changed to match.

This softkey is only active when you have selected the internal source to operate as a function generator.

Softkey Location: Press **LF Out**, **LF Out Source**, **Function Generator**, **LF Out Waveform**, **Dual-Sine**, **LF Out Tone 2 Freq**

Status after Normal Preset: 400.0 Hz

SCPI Commands:

```
[[:SOURce]:LFOutput:FUNCTion:FREQuency:ALTErnate <val><unit>
```

```
[[:SOURce]:LFOutput:FUNCTion:FREQuency:ALTErnate?
```

LF Out Waveform

Pressing this softkey reveals a menu of LF output waveform choices for your LF function generator. Select from sine, dual-sine, swept-sine, triangle, ramp, square, pulse, noise, and DC waveforms.

This softkey is only active when you have selected the internal source to operate as a function generator.

Softkey Location: Press **LF Out**, **LF Out Source**, **Function Generator**, **LF Out Waveform**

Status after Normal Preset: Sine

SCPI Commands:

```
[[:SOURce]:LFOutput:FUNCTion:SHAPE?
```

LF Out Width

Use this softkey to change the pulse width for the pulsed low frequency waveform. To change the width, press the softkey once. The current value for pulse width is displayed in the active entry area. To enter a new value, rotate the front panel knob until the desired value is displayed, use the up and down arrow keys, or enter the value using the numeric keypad and press the μsec or msec terminator softkey. The range of values allowed is from 8 μs to a maximum of the value for the pulse period.

This softkey is only active when you have selected the internal source to operate as a function generator and when the LF Out waveform is specified as pulse.

Softkey Location: Press **LF Out**, **LF Out Source**, **Function Generator**, **LF Out Waveform**, **More 1 of 2**, **Pulse**, **LF Out Width**

Status after Normal Preset: 40 μs

SCPI Commands:

```
[[:SOURce]:LFOutput:FUNCTion:PWIDth <val><unit>
```

```
[[:SOURce]:LFOutput:FUNCTion:PWIDth?
```

Noise

This softkey lets you specify noise as the waveform for the LF output signal.

This softkey is only active when you have selected the internal source to operate as a function generator.

Softkey Location: Press **LF Out**, **LF Out Source**, **Function Generator**, **LF Out Waveform**, **More 1 of 2**, **Noise**

Status after Normal Preset: LF Out Waveform is set to Sine

SCPI Commands:

```
[[:SOURce]:LFOutput:FUNCTion:SHAPE NOISE
```

```
[[:SOURce]:LFOutput:FUNCTion:SHAPE?
```

Pulse

This softkey lets you specify pulse as the waveform for the LF output signal. The signal shape can only be specified when you have selected the internal source to operate as a function generator. Use the **LF Out Period** and **LF Out Width** softkeys to define the pulse shape.

This softkey is only active when you have selected the internal source to operate as a function generator.

Softkey Location: Press **LF Out**, **LF Out Source**, **Function Generator**, **LF Out Waveform**, **More 1 of 2**, **Pulse**

Status after Normal Preset: LF Out Waveform is set to Sine

SCPI Commands:

```
[[:SOURce]:LFOutput:FUNCTion:SHAPe PULSe
```

```
[[:SOURce]:LFOutput:FUNCTion:SHAPe?
```

Ramp

This softkey lets you specify ramp as the waveform for the LF output signal.

This softkey is only active when you have selected the internal source to operate as a function generator.

Softkey Location: Press **LF Out**, **LF Out Source**, **Function Generator**, **LF Out Waveform**, **Ramp**

Status after Normal Preset: LF Out Waveform is set to Sine

SCPI Commands:

```
[[:SOURce]:LFOutput:FUNCTion:SHAPe RAMP
```

```
[[:SOURce]:LFOutput:FUNCTion:SHAPe?
```

Sine

This softkey lets you specify sine as the waveform for the LF output signal.

This softkey is only active when you have selected the internal source to operate as a function generator.

Softkey Location: Press **LF Out**, **LF Out Source**, **Function Generator**, **LF Out Waveform**, **Sine**

Status after Normal Preset: LF Out Waveform is set to Sine

SCPI Commands:

```
[[:SOURce]:LFOutput:FUNCTion:SHAPE SINE
```

```
[[:SOURce]:LFOutput:FUNCTion:SHAPE?
```

Square

This softkey lets you specify square as the waveform for the LF output signal.

This softkey is only active when you have selected the internal source to operate as a function generator.

Softkey Location: Press **LF Out**, **LF Out Source**, **Function Generator**, **LF Out Waveform**, **More 1 of 2**, **Square**

Status after Normal Preset: LF Out Waveform is set to Sine

SCPI Commands:

```
[[:SOURce]:LFOutput:FUNCTion:SHAPE SQUARE
```

```
[[:SOURce]:LFOutput:FUNCTion:SHAPE?
```

Swept-Sine

Pressing this softkey reveals a menu of choices for setting the swept-sine low frequency output. In this menu you can set the LF start and stop frequency and the sweep time. You can also set the trigger for the swept-sine output, and the polarity of the TRIGGER IN and TRIGGER OUT signals.

Softkey Location: Press **LF Out**, **LF Out Source**, **Function Generator**, **LF Out Waveform**, **Swept-Sine**

SCPI Commands:

```
[[:SOURce]:LFOutput:FUNCTion:SHAPE SWEPTsine
```

```
[[:SOURce]:LFOutput:FUNCTion:SHAPE?
```

Triangle

This softkey lets you specify triangle as the waveform for the LF output signal.

This softkey is only active when you have selected the internal source to operate as a function generator.

Softkey Location: Press **LF Out**, **LF Out Source**, **Function Generator**, **LF Out Waveform**, **Triangle**

Status after Normal Preset: LF Out Waveform is set to Sine

SCPI Commands:

```
[[:SOURce]:LFOutput:FUNCTion:SHAPE TRIangle
```

```
[[:SOURce]:LFOutput:FUNCTion:SHAPE?
```

Trigger In Polarity Neg Pos

Press this softkey to toggle between a negative TTL level trigger (0 V) and a positive TTL level trigger (+5 V) for externally triggering swept-sine low frequency output.

This softkey is coupled to the **Trigger In Polarity Neg Pos** softkey for swept-sine AM, FM, and Φ M, and to the **Ext Neg** and **Ext Pos** sweep trigger selections in the Sweep/List Menu. If you set the **Trigger In Polarity Neg Pos** softkey in the LF Out Swept-Sine Menu to **Neg**, the **Trigger In Polarity Neg Pos** softkey is also set to **Neg** for swept-sine AM, FM, and Φ M. In addition, if the step or list sweep is set to externally trigger, the selection will automatically be set to **Ext Neg**. The same softkeys will toggle to **Pos** or to **Ext Pos** if you select **Pos** in the Swept-Sine LF Out Menu.

Conversely, if the **Trigger In Slope Neg Pos** softkey is toggled in the swept-sine AM, FM, or Φ M menus, it will cause the swept-sine LF Out softkey to toggle also. This is also true for the **Ext Neg** and **Ext Pos** step or list sweep trigger selections.

This softkey is only active when you have selected the internal source to operate as a function generator.

Softkey Location: Press **LF Out**, **LF Out Source**, **Function Generator**, **LF Out Waveform**, **Swept-Sine**, **Trigger In Polarity Neg Pos**

Status after Normal Preset: Pos

SCPI Commands:

:TRIGger[:SEQuence]:SLOPe POSitive|NEGative

:TRIGger[:SEQuence]:SLOPe?

Trigger Key

This softkey is one of the choices in the LF Output Sweep Trigger menu. With **Trigger Key** selected, when you press the **Trigger** front panel key you immediately trigger a single sweep of swept-sine low frequency output.

The **Trigger** key has autorepeat capability. Hold it down and you will repeatedly trigger sweeps until you release the key.

Softkey Location: Press **LF Out**, **LF Out Source**, **Function Generator**, **LF Out Waveform**, **Swept-Sine**, **LF Output Sweep Trigger**, **Trigger Key**

Status after Normal Preset: LF output sweep trigger is set to Immediate

SCPI Commands:

```
[[:SOURce]:LFOutput:FUNcTION:SWEEp:TRIGger KEY
```

```
[[:SOURce]:LFOutput:FUNcTION:SWEEp:TRIGger?
```

Trigger Out Polarity Neg Pos

This softkey toggles the polarity of the TTL signal that is output at the rear panel TRIGGER OUT connector. When **Trigger Out Polarity Neg Pos** is set to **Pos**, the output signal is asserted high (+5 V) at the start of the swept-sine low frequency sweep and low (0 V) when the sweep is concluded. Setting **Trigger Out Polarity Neg Pos** to **Neg** reverses the polarity, where a high is 0 V and a low is +5 V.

This softkey is coupled to the **Trigger Out Polarity Neg Pos** softkey in the swept-sine AM, FM, and Φ M menus and the sweep/list menu. When the polarity is toggled for this softkey in any one of these menus, it affects all locations of the softkey.

This softkey is only active when you have selected the internal source to operate as a function generator.

Softkey Location: Press **LF Out**, **LF Out Source**, **Function Generator**, **LF Out Waveform**, **Swept-Sine**, **Trigger Out Polarity Neg Pos**

Status after Normal Preset: Pos

SCPI Commands:

```
:TRIGger:OUTPut:POLarity POSitive|NEGative
```

```
:TRIGger:OUTPut:POLarity?
```

Hardkey and Softkey Reference
LF Out

Local

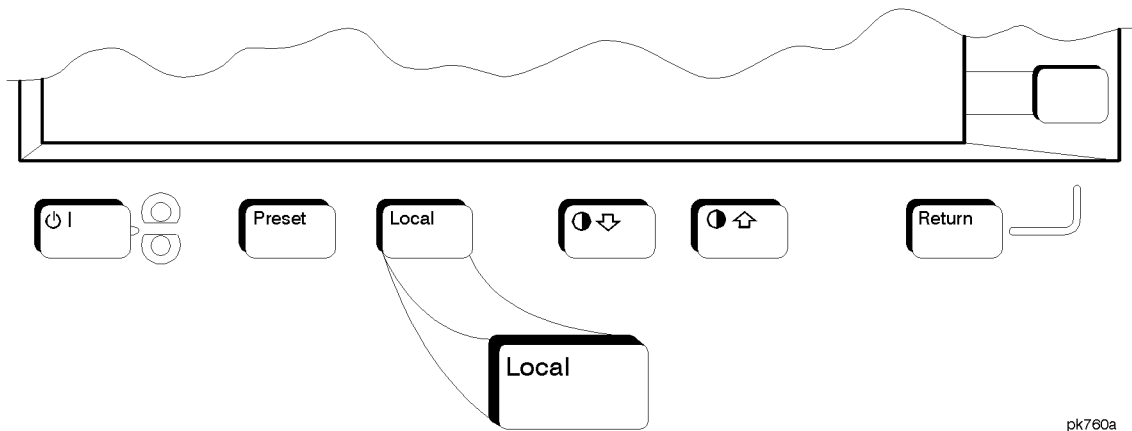

pk760a

Press this key to return the signal generator to local (front panel) control from remote operation or to restore the front panel menu and status area display after RS-232 control. You can also press this key to restore the display once the screen saver has started.

This key has autorepeat capability. Hold it down and its function is continuously executed until you release it.

Status after Normal Preset: Local (unless a LOCAL LOCKOUT command has been sent).

Hardkey and Softkey Reference
Local

Mod On/Off

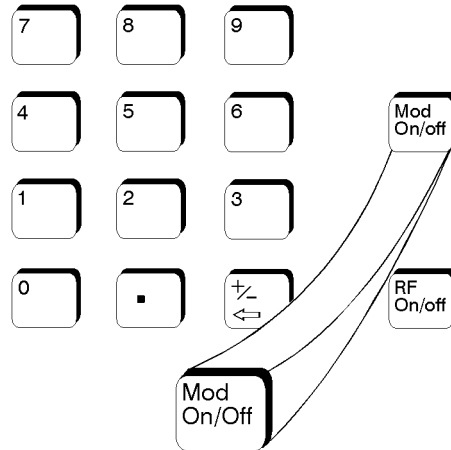

pk756a

Set this front panel hardkey to **On** to modulate the RF carrier with the modulations that you have enabled. All modulation types can be simultaneously enabled except FM with Φ M. An annunciator is always turned on in the display to indicate whether modulation is turned on or off.

Status after Normal Preset: Mod Off

SCPI Commands:

:OUTPut:MODulation[:STATe] ON|OFF|1|0

:OUTPut:MODulation[:STATe]?

Hardkey and Softkey Reference
Mod On/Off

Mode

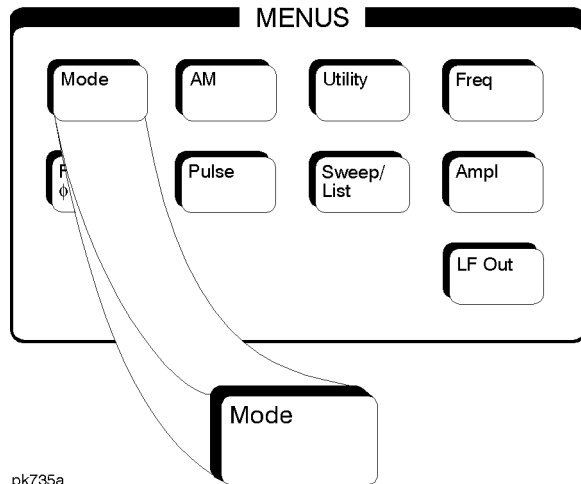

pk735a

This front panel key is reserved for future use.

Hardkey and Softkey Reference
Mode

Numeric Keypad

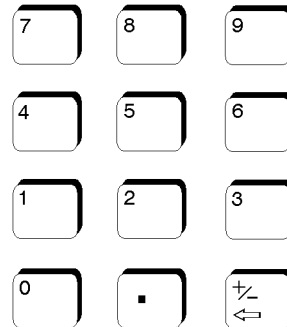

pk755a

The numeric keypad consists of the digit keys (0 through 9), a decimal point key, and a backspace key, . The backspace key has dual functions for both backspacing and for changing the sign of a value to positive or negative. Use these keys at any time when the active function requires a value input. The backspace key function changes with the situation.

If you are modifying a previously entered value:

- If the value is negative, pressing the backspace key deletes the entire value and leaves the negative sign. Subsequent key presses change the sign between positive and negative states.
- If the value is positive, pressing the backspace key deletes the entire value and also changes the sign to a negative state. Subsequent key presses change the sign between positive and negative states.

If you are entering a new value:

- If the cursor is to the right of the digits, pressing the backspace key deletes the digit immediately to the left. When no digits remain, subsequent key presses change the sign between positive and negative states.
- If the cursor is on a digit, pressing the backspace key deletes the digit immediately to the left. When a single digit remains, pressing the backspace key changes the negative sign (if present) to positive and then subsequent key presses have no effect.

These keys have autorepeat capability (except for the decimal point key). Hold a key down and its function is continuously executed until you release it.

Hardkey and Softkey Reference
Numeric Keypad

Phase Modulation

Pressing the front panel phase modulation key (ΦM) reveals a menu of softkeys. These softkeys are described in this section in alphabetical order.

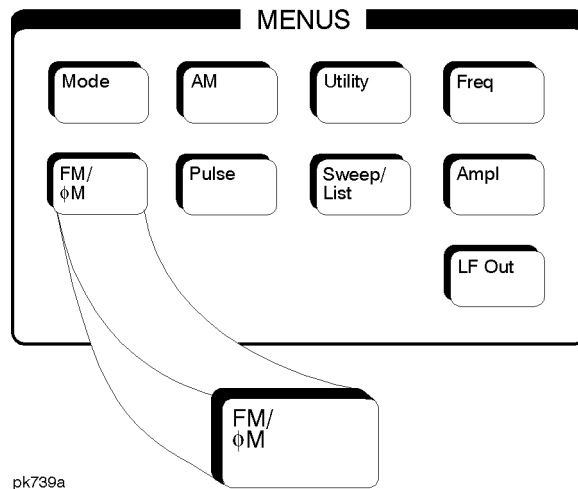

ΦM Dev

Use this softkey to set the phase modulation deviation for the ΦM Path 1 and ΦM Path 2 configurations. To change the value of the ΦM deviation, press the softkey once. The current value for ΦM deviation is displayed in the active entry area. To enter a new value, rotate the front panel knob until the desired value is displayed, use the up and down arrow keys, or enter the value using the numeric keypad and press the **pi rad**, **rad**, or **deg** terminator softkey. The range of values allowed depends on the carrier frequency and the rate selected. Refer to Table 5-1.

Table 5-1. Maximum Deviation Values for Phase Modulation

Mode	Maximum Deviation	Maximum Rates (3 dB BW)	
		Φ M Path 1	Φ M Path 2
Normal	$N^1 \times 90$ radians	100 kHz	100 kHz
High Bandwidth	$N \times 2\pi$ radians	1.5 MHz (typical)	1 MHz (typical)
	$N \times \pi/2$ radians	6 MHz (typical)	1 MHz (typical)

1. For the value of N, refer to Table 5-2.

Table 5-2. Carrier Frequency Bands versus Value of N

Carrier Frequency	N
250 kHz to \leq 249.999 MHz	1
> 249.999 MHz to \leq 500 MHz	0.5
> 500 MHz to \leq 1 GHz	1
> 1 GHz to \leq 2 GHz	2
> 2 GHz to 4 GHz	4

For example, if you set up Φ M Path 1 for normal phase modulation with a carrier frequency of 400 MHz, and a rate of 100 kHz, the maximum peak deviation that you can set is 0.5 (value of N) times 90 radians resulting in a maximum peak deviation of 45 radians.

Notice that the new value of Φ M deviation applies only to whichever Φ M path configuration you have currently selected. Also, Φ M Path 2 is limited to a maximum rate of 1 MHz. Also, whenever Φ M Path 1 is used with Φ M Path 2, the deviation for Φ M Path 1 must be greater than or equal to the deviation for Φ M Path 2.

Softkey Location: Press **FM/ Φ M** hardkey, toggle **FM/ Φ M** softkey to Φ M, press **Φ M Path 1 2**

Status after Normal Preset: 0 radians

SCPI Commands:

```
[[:SOURCE]:PM[1]]2[:DEVIation] <val><unit>
[:SOURCE]:PM[1]]2[:DEVIation]?
```

Φ M Dev Couple Off On

This softkey toggles the Φ M deviation coupling on and off. Turning on Φ M deviation coupling links the Φ M deviation values of Φ M Path 1 and Φ M Path 2. When the values are coupled, any change you make to one Φ M deviation value is applied to both Φ M deviation values.

Softkey Location: Press **FM/ Φ M** hardkey, toggle **FM/ Φ M** softkey to Φ M, press **More (1 of 2)**, **Φ M Dev Couple Off On**

Status after Normal Preset: Off

SCPI Commands:

```
[[:SOURce]:PM[1]2:[DEViation]:TRACk ON|OFF|1|0
```

```
[[:SOURce]:PM[1]2:[DEViation]:TRACk?
```

Φ M Dual-Sine Ampl Ratio

Press this softkey to set the ratio of the deviation of Φ M tone 2 to the deviation of Φ M tone 1 as a percent. The range of values allowed is 0 to 100%. The minimum increment allowed is 0.1%. The sum of the two Φ M deviations results in the total Φ M deviation (set by the **Φ M Dev** softkey in the initial Φ M Menu).

For example, if the total Φ M deviation is 300 radians and you set **Φ M Dual-Sine Ampl Ratio** to 50%, then the deviation of Φ M tone 1 will be 200 radians and the deviation of Φ M tone 2 will be 100 radians (50% of 200 radians) so that the deviation of the two tones adds up to 300 radians (200 radians plus 100 radians).

Softkey Location: Press **FM/ Φ M** hardkey, toggle **FM/ Φ M** softkey to Φ M, press **More (1 of 2)**, **Φ M Waveform, Dual-Sine, Φ M Dual-Sine Ampl Ratio**

Status after Normal Preset: 100.0%

SCPI Commands:

```
[[:SOURce]:PM[1]2:INTernal[1]:FREQUency:ALTernate:AMPLitude:PERCent  
<val><unit>
```

```
[[:SOURce]:PM[1]2:INTernal[1]:FREQUency:ALTernate:AMPLitude:PERCent?
```

ΦM Off On

This softkey toggles the phase modulation on or off for whichever **ΦM** configuration (**ΦM Path 1** or **ΦM Path 2**) you have selected. Notice, however that although you can turn on phase modulation with this softkey, the RF carrier is modulated by the enabled modulation only when you have also set **Mod On/Off** to **On**. Whenever phase modulation is enabled, the **ΦM** annunciator is turned on in the display.

There are two paths for **ΦM** modulation which can be simultaneously enabled as long as they use different sources (Int, Ext1, or Ext2). **ΦM Path 2** is limited to a maximum rate of 1 MHz. **ΦM Path 2** must be set to a deviation less than or equal to **ΦM Path 1**. The modulation signals from both paths are summed internally for composite modulation.

Softkey Location: Press **FM/ΦM** hardkey, toggle **FM/ΦM** softkey to **ΦM**, press **ΦM Off On**

Status after Normal Preset: Off

SCPI Commands:

```
[[:SOURce]:PM[1]|2]:STATe ON|OFF|1|0
```

```
[[:SOURce]:PM[1]|2]:STATe?
```

Φ M Path 1 2

Use Φ M Path 1 and Φ M Path 2 to define two unique phase modulation configurations. For example, select Φ M Path 1 (Φ M Path 1 is the default after a normal preset. If Φ M Path 1 is not highlighted, press the softkey once and the selection will toggle from Φ M Path 2 to Φ M Path 1.) Configure the modulation characteristics (such as deviation, source, rate, and waveform) using the remaining softkeys in the Φ M menu. Then enable Φ M by setting Φ M Off On to On.

To configure a second phase modulation configuration, toggle to Φ M Path 2. Define the modulation characteristics for this second configuration and enable Φ M by setting Φ M Off On to On.

The RF carrier is available at the RF OUTPUT connector when you set RF On/Off to On. Set Mod On/Off to On to modulate the RF carrier with the modulations that you have enabled.

Φ M Path 1 and Φ M Path 2 are summed internally for composite modulation. Either path can be switched to any one of the modulation sources: Int, Ext1, or Ext2. All modulation types can be simultaneously enabled, except FM with Φ M. AM, FM, and Φ M can sum simultaneous inputs from any two sources (Int, Ext1, and Ext2). Any given source (Int, Ext1, or Ext2) can only be routed to one activated modulation type.

Softkey Location: Press FM/ Φ M hardkey, toggle FM/ Φ M softkey to Φ M, press Φ M Path 1 2

Status after Normal Preset: Φ M Path 1

Φ M Rate

Use this softkey to change the internal modulation frequency for the Φ M Path 1 and Φ M Path 2 configurations. To change the value, press the softkey once. The current value for Φ M rate is displayed in the active entry area. To enter a new value, rotate the front panel knob until the desired value is displayed, use the up and down arrow keys, or enter the value using the numeric keypad and press the **Hz** or **kHz** terminator softkey. The range of values allowed is 0.1 Hz to 10 kHz. (0.1 Hz to 50 kHz is the range allowed if sinewave is selected as the internal waveform.) The minimum increment allowed is 0.1 Hz. Notice that the new value of Φ M rate applies only to whichever Φ M path configuration you have currently selected.

Softkey Location: Press **FM/ Φ M** hardkey, toggle **FM/ Φ M** softkey to Φ M, press **Φ M Rate**

Status after Normal Preset: 400 Hz

SCPI Commands:

```
[[:SOURce]:PM[1]|2:INTernal[1]:FREQuency <val><unit>
```

```
[[:SOURce]:PM[1]|2:INTernal[1]:FREQuency?
```

Φ M Source

Pressing this softkey reveals a menu of choices for phase modulation sources. You can choose internally-generated phase modulation or select an externally-applied signal from either the EXT 1 INPUT or EXT 2 INPUT connectors. The internal modulation is always AC-coupled. For the externally-applied signals, you can choose between AC- and DC-coupled modulation. A 1.0 Vpk input is required for calibrated Φ M deviation settings. The **EXT 1 LO/HI** and **EXT 2 LO/HI** display annunciators will turn on if the peak input voltage differs from 1.0 Vpk by more than 3%. (The LO/HI annunciators only function for AC-coupled external inputs.)

The internal and external 1 and 2 sources have multiple uses. You can use them for amplitude, frequency, and phase modulation. For pulse modulation you must use the external 2 source. However, any given source can only be routed to one enabled modulation at a time. If, for example, you were using the external 1 source in a frequency modulation configuration for **FM Path 1**, and then you configured **AM Path 2** to also use the external 1 source, the signal generator would turn off **FM Path 1** and assign the external 1 source to your **AM Path 2** configuration. Notice that for these purposes the external 1 AC-coupled source is the same as the external 1 DC-coupled source and the external 2 AC-coupled source is the same as the external 2 DC-coupled source.

Softkey Location: Press **FM/ Φ M** hardkey, toggle **FM/ Φ M** softkey to **Φ M**, press **Φ M Source**

SCPI Commands:

```
[[:SOURce]:PM[1]|2:SOURce?
```

Φ M Start Rate

Use this softkey to change the starting internal modulation frequency for swept-sine phase modulation. To change the value, press the softkey once. The current value for the Φ M start rate is displayed in the active entry area. To enter a new value, rotate the front panel knob until the desired value is displayed, use the up and down arrow keys, or enter the value using the numeric keypad and press the **Hz** or **kHz** terminator softkey. The range of values allowed is 0.1 Hz to 50 kHz. The minimum increment allowed is 0.1 Hz.

This softkey is coupled to the **Φ M Rate** softkey in the initial Φ M Menu and the **Φ M Tone 1 Rate** softkey in the Φ M Dual-Sine Menu. Any value set for **Φ M Start Rate** is reflected in the **Φ M Rate** and **Φ M Tone 1 Rate** softkeys. Conversely, if you change the value for either the **Φ M Rate** softkey or the **Φ M Tone 1 Rate** softkey, the value for **Φ M Start Rate** is changed to match.

Softkey Location: Press **FM/ Φ M** hardkey, toggle **FM/ Φ M** softkey to **Φ M**, press **More (1 of 2)**, **Φ M Waveform**, **Swept-Sine**, **Φ M Start Rate**

Status after Normal Preset: 400.0 Hz

SCPI Commands:

```
[[:SOURce]:PM[1]]2:INTernal[1]:FREQuency <val><unit>
```

```
[[:SOURce]:PM[1]]2:INTernal[1]:FREQuency?
```

Φ M Stop Rate

Use this softkey to change the ending internal modulation frequency for swept-sine phase modulation. To change the value, press the softkey once. The current value for the Φ M stop rate is displayed in the active entry area. To enter a new value, rotate the front panel knob until the desired value is displayed, use the up and down arrow keys, or enter the value using the numeric keypad and press the **Hz** or **kHz** terminator softkey. The range of values allowed is 0.1 Hz to 50 kHz. The minimum increment allowed is 0.1 Hz.

This softkey is coupled to the **Φ M Tone 2 Rate** softkey in the Φ M Dual-Sine Menu. Any value set for **Φ M Stop Rate** is reflected in the **Φ M Tone 2 Rate** softkey. Conversely, if you change the value for the **Φ M Tone 2 Rate** softkey, the value for **Φ M Stop Rate** is changed to match.

Softkey Location: Press **FM/ Φ M** hardkey, toggle **FM/ Φ M** softkey to **Φ M**, press **More (1 of 2)**, **Φ M Waveform**, **Swept-Sine**, **Φ M Stop Rate**

Status after Normal Preset: 400.0 Hz

SCPI Commands:

```
[[:SOURCE]:PM[1]]2:INTERNAL[1]:FREQUENCY:ALTERNATE <val><unit>  
[:SOURCE]:PM[1]]2:INTERNAL[1]:FREQUENCY:ALTERNATE?
```

Φ M Sweep Time

Press this softkey to set the sweep time for swept-sine phase modulation. The signal generator will vary the Φ M rate from the specified start rate to the stop rate in the time set with this softkey. Enter the desired sweep time using the up and down arrow keys, the front panel knob, or enter a value using the numeric keypad and press the **sec** or **msec** terminator softkey. The range of values allowed is 1 ms through 65.535 s. The minimum increment allowed is 1 ms.

Softkey Location: Press **FM/ Φ M** hardkey, toggle **FM/ Φ M** softkey to **Φ M**, press **More (1 of 2)**, **Φ M Waveform**, **Swept-Sine**, **Φ M Sweep Time**

Status after Normal Preset: 100.0 msec

SCPI Commands:

```
[[:SOURCE]:PM[1]]2:INTERNAL[1]:SWEEP:TIME <val><unit>  
[:SOURCE]:PM[1]]2:INTERNAL[1]:SWEEP:TIME?
```

Φ M Sweep Trigger

Pressing this softkey reveals a menu of choices for triggering swept-sine phase modulation. You can choose triggering that occurs immediately, triggering that is supplied by the HP-IB, triggering on either the positive or negative edge of a signal supplied to the TRIGGER IN connector, or triggering by the front panel **Trigger** key.

Softkey Location: Press **FM/ Φ M** hardkey, toggle **FM/ Φ M** softkey to Φ M, press **More (1 of 2)**, **Φ M Waveform**, **Swept-Sine**, **Φ M Sweep Trigger**

Status after Normal Preset: Immediate

SCPI Commands:

:TRIGger[:SEquence]:SOURce?

Φ M Tone 1 Rate

Press this softkey to set the internal modulation frequency for the Φ M tone 1. Enter the desired rate using the up and down arrow keys, the front panel knob, or enter a value using the numeric keypad and press the **kHz** or **Hz** terminator softkey. The range of values allowed is 0.1 Hz through 50 kHz. The minimum increment allowed is 0.1 Hz.

This softkey is coupled to the **Φ M Rate** softkey in the initial Φ M Menu and the **Φ M Start Rate** softkey in the Φ M Swept-Sine Menu. Any value set for **Φ M Tone 1 Rate** is reflected in the **Φ M Rate** and **Φ M Start Rate** softkeys. Conversely, if you change the value for either the **Φ M Rate** softkey or the **Φ M Start Rate** softkey, the value for **Φ M Tone 1 Rate** is changed to match.

Softkey Location: Press **FM/ Φ M** hardkey, toggle **FM/ Φ M** softkey to Φ M, press **More (1 of 2)**, **Φ M Waveform**, **Dual-Sine**, **Φ M Tone 1 Rate**

Status after Normal Preset: 400.0 Hz

SCPI Commands:

[:SOURce]:PM[1]|2:INTernal[1]:FREQuency <val><unit>

[:SOURce]:PM[1]|2:INTernal[1]:FREQuency?

Φ M Tone 2 Rate

Press this softkey to set the internal modulation frequency for the Φ M tone 2. Enter the desired rate using the up and down arrow keys, the front panel knob, or enter a value using the numeric keypad and press the **kHz** or **Hz** terminator softkey. The range of values allowed is 0.1 Hz through 50 kHz. The minimum increment allowed is 0.1 Hz.

This softkey is coupled to the **Φ M Stop Rate** softkey in the Φ M Swept-Sine Menu. Any value set for **Φ M Tone 2 Rate** is reflected in the **Φ M Stop Rate** softkey. Conversely, if you change the value for the **Φ M Stop Rate** softkey, the value for **Φ M Tone 2 Rate** is changed to match.

Softkey Location: Press **FM/ Φ M** hardkey, toggle **FM/ Φ M** softkey to **Φ M**, press **More (1 of 2)**, **Φ M Waveform**, **Dual-Sine**, **Φ M Tone 2 Rate**

Status after Normal Preset: 400.0 Hz

SCPI Commands:

```
[[:SOURce]:PM[1]2:INTernal[1]:FREQuency:ALTernate <val><unit>
```

```
[[:SOURce]:PM[1]2:INTernal[1]:FREQuency:ALTernate?
```

Φ M Waveform

Pressing this softkey reveals a menu of Φ M waveform choices for your **Φ M Path 1** and **Φ M Path 2** configurations. Select from sine, triangle, square, ramp, noise, dual-sine, and swept-sine waveforms. Notice that your waveform selection applies only to which ever Φ M path configuration you have currently selected.

Softkey Location: Press **FM/ Φ M** hardkey, toggle **FM/ Φ M** softkey to **Φ M**, press **More (1 of 2)**, **Φ M Waveform**

Status after Normal Preset: Sine

SCPI Commands:

```
[[:SOURce]:PM[1]2:INTernal[1]:FUNCTion:SHAPE?
```

Bus

This softkey is one of the choices in the Φ M Sweep Trigger menu. With **Bus** selected, you use the HP-IB to trigger single sweeps of swept-sine phase modulation.

Softkey Location: Press **FM/ Φ M** hardkey, toggle **FM/ Φ M** softkey to **Φ M**, press **More (1 of 2)**, **Φ M Waveform**, **Swept-Sine**, **Φ M Sweep Trigger**, **Bus**

Status after Normal Preset: Φ M sweep trigger is set to Immediate

SCPI Commands:

```
[[:SOURce]:PM[1]2:INTernal[1]:SWEep:TRIGger BUS
```

```
[[:SOURce]:PM[1]2:INTernal[1]:SWEep:TRIGger?
```

DCFM/DC Φ M Cal

Pressing this softkey initiates a DC Φ M calibration. This calibration eliminates the offset in DC phase modulation so that the carrier phase remains the same with no modulation applied. External, DC-coupled Φ M must be active when this command is executed.

Softkey Location: Press **FM/ Φ M** hardkey, toggle **FM/ Φ M** softkey to **Φ M**, press **More (1 of 2)**, **DCFM/DC Φ M Cal**

SCPI Commands:

```
:CALibration:DCFM
```

Dual-Sine

Pressing this softkey reveals a menu of choices for setting the dual-sine phase modulation parameters. In this menu you can set the Φ M rates for two separate tones. In addition you can set a ratio of the tone 2 Φ M deviation to the tone 1 Φ M deviation.

Softkey Location: Press **FM/ Φ M** hardkey, toggle **FM/ Φ M** softkey to **Φ M**, press **More (1 of 2)**, **Φ M Waveform**, **Dual-Sine**

SCPI Commands:

```
[[:SOURce]:PM[1]2:INTernal[1]:FUNCTion:SHAPE DUALsine
```

```
[[:SOURce]:PM[1]2:INTernal[1]:FUNCTion:SHAPE?
```

Ext

This softkey is one of the choices in the Φ M Sweep Trigger menu. Choosing **Ext** allows you to trigger swept-sine phase modulation using a signal applied to the TRIGGER IN rear panel connector. Set the polarity of the trigger signal using the **Trigger In Polarity Neg Pos** softkey.

Softkey Location: Press **FM/ Φ M** hardkey, toggle **FM/ Φ M** softkey to Φ M, press **More (1 of 2)**, **Φ M Waveform, Swept-Sine, Φ M Sweep Trigger, Ext**

Status after Normal Preset: Φ M sweep trigger is set to Immediate

SCPI Commands:

```
[[:SOURce]:PM[1]2:INTernal[1]:SWEep:TRIGger EXTernal
```

```
[[:SOURce]:PM[1]2:INTernal[1]:SWEep:TRIGger?
```

Ext 1 AC-Coupled

This softkey lets you input an external, AC-coupled, phase modulation signal to the EXT 1 INPUT connector. The modulation signal is tested for voltage and a display annunciator will report a high or low condition if the voltage is $> \pm 3\%$ of 1 Vpk.

The external 1 input has multiple uses but can be used for only one modulation at a time. If, for example, you were using the external 1 input in an amplitude modulation configuration for **AM Path 1**, and then you configured **Φ M Path 2** to also use the external 1 input, the signal generator would turn off **AM Path 1** and assign the external 1 input to your **Φ M Path 2** configuration. For the purposes of this discussion, the external 1 AC-coupled input is the same as the external 1 DC-coupled source.

Softkey Location: Press **FM/ Φ M** hardkey, toggle **FM/ Φ M** softkey to Φ M, press **Φ M Source, Ext 1 AC-Coupled**

SCPI Commands:

```
[[:SOURce]:PM[1]2:SOURce EXTernal1
```

```
[[:SOURce]:PM[1]2:EXTernal[1]:COUPling AC
```

```
[[:SOURce]:PM[1]2:EXTernal[1]:COUPling?
```

Ext 1 DC-Coupled

This softkey lets you input an external, DC-coupled, phase modulation signal to the EXT 1 INPUT connector.

The external 1 input has multiple uses but can be used for only one modulation at a time. If, for example, you were using the external 1 input in an amplitude modulation configuration for **AM Path 1**, and then you configured **ΦM Path 2** to also use the external 1 input, the signal generator would turn off **AM Path 1** and assign the external 1 input to your **ΦM Path 2** configuration. For the purposes of this discussion, the external 1 AC-coupled input is the same as the external 1 DC-coupled source.

Softkey Location: Press **FM/ΦM** hardkey, toggle **FM/ΦM** softkey to **ΦM**, press **ΦM Source, Ext 1 DC-Coupled**

SCPI Commands:

```
[[:SOURCE]:PM[1]|2:SOURce EXTernal1  
[:SOURCE]:PM[1]|2:EXTernal[1]:COUPling DC  
[:SOURCE]:PM[1]|2:EXTernal[1]:COUPling?
```

Ext 2 AC-Coupled

This softkey lets you input an external, AC-coupled, phase modulation signal to the EXT 2 INPUT connector. The modulation signal is tested for voltage and a display annunciator will report a high or low condition if the voltage is $> \pm 3\%$ of 1 Vpk.

The external 2 input has multiple uses but can be used for only one modulation at a time. If, for example, you were using the external 2 input in an amplitude modulation configuration for **AM Path 1**, and then you configured **ΦM Path 2** to also use the external 2 input, the signal generator would turn off **AM Path 1** and assign the external 2 input to your **ΦM Path 2** configuration. For the purposes of this discussion, the external 2 AC-coupled input is the same as the external 2 DC-coupled source.

Softkey Location: Press **FM/ΦM** hardkey, toggle **FM/ΦM** softkey to **ΦM**, press **ΦM Source, Ext 2 AC-Coupled**

SCPI Commands:

```
[[:SOURCE]:PM[1]|2:SOURce EXTernal2  
[:SOURCE]:PM[1]|2:EXTernal2:COUPling AC  
[:SOURCE]:PM[1]|2:EXTernal2:COUPling?
```

Ext 2 DC-Coupled

This softkey lets you input an external, DC-coupled, phase modulation signal to the EXT 2 INPUT connector.

The external 2 input has multiple uses but can be used for only one modulation at a time. If, for example, you were using the external 2 input in an amplitude modulation configuration for **AM Path 1**, and then you configured **ΦM Path 2** to also use the external 2 input, the signal generator would turn off **AM Path 1** and assign the external 2 input to your **ΦM Path 2** configuration. For the purposes of this discussion, the external 2 AC-coupled input is the same as the external 2 DC-coupled source.

Softkey Location: Press **FM/ΦM** hardkey, toggle **FM/ΦM** softkey to **ΦM**, press **ΦM Source, Ext 2 DC-Coupled**

SCPI Commands:

```
[[:SOURce]:PM[1]]2:SOURce EXTernal2  
[:SOURce]:PM[1]]2:EXTernal2:COUPling DC  
[:SOURce]:PM[1]]2:EXTernal2:COUPling?
```

FM/ΦM Normal High BW

This softkey toggles between the menus for FM, normal ΦM, and wideband ΦM. Normal ΦM lets you set the phase deviation as high as $N \times 90$ radians with a 3 dB bandwidth of 100 kHz. Wideband ΦM provides increased bandwidth while restricting the maximum deviation to deviation settings up to $\pi/2$ radians (90°). The modulation bandwidth is typically 6 MHz. For deviation settings between $\pi/2$ and 2π radians (360°), the modulation bandwidth is typically 1.5 MHz. (These increased bandwidths are only available using **ΦM Path 1**. **ΦM Path 2** is limited to 1 MHz.)

Softkey Location: Press **FM/ΦM** hardkey, press **FM/ΦM** softkey once for normal bandwidth or twice for high bandwidth

Status after Normal Preset: FM

SCPI Commands:

```
[[:SOURce]:PM[1]]2:BANDwidth|BWIDth NORMalHIGH  
[:SOURce]:PM[1]]2:BANDwidth|BWIDth?
```

Immediate

This softkey is one of the choices in the Φ M Sweep Trigger menu. Choosing **Immediate** immediately triggers swept-sine phase modulation in a continuous mode. To stop the sweep, choose a different trigger such as **Ext**, or set the waveform to something other than **Swept-Sine**.

Softkey Location: Press **FM/ Φ M** hardkey, toggle **FM/ Φ M** softkey to Φ M, press **More (1 of 2)**, **Φ M Waveform**, **Swept-Sine**, **Φ M Sweep Trigger**, **Immediate**

Status after Normal Preset: Φ M sweep trigger is set to Immediate

SCPI Commands:

```
[[:SOURce]:PM[1]|2:INTernal[1]:SWEep:TRIGger IMMEDIATE
```

```
[[:SOURce]:PM[1]|2:INTernal[1]:SWEep:TRIGger?
```

Internal

This softkey lets you internally generate an AC-coupled, phase modulation signal.

The internal source has multiple uses but can be used for only one modulation at a time. If, for example, you were using the internal source in an amplitude modulation configuration for **AM Path 1**, and then you configured **Φ M Path 2** to also use the internal source, the signal generator would turn off **AM Path 1** and assign the internal source to your **Φ M Path 2** configuration.

Softkey Location: Press **FM/ Φ M** hardkey, toggle **FM/ Φ M** softkey to Φ M, press **More (1 of 2)**, **Φ M Source**, **Internal**

Status after Normal Preset: Internal

SCPI Commands:

```
[[:SOURce]:PM[1]|2:SOURce INT[1]
```

```
[[:SOURce]:PM[1]|2:SOURce?
```

Noise

This softkey lets you specify noise as the phase modulation waveform for the **ΦM Path 1** and **ΦM Path 2** configurations. Notice that the selected waveform applies only to whichever ΦM path configuration you have currently selected.

Softkey Location: Press **FM/ΦM** hardkey, toggle **FM/ΦM** softkey to **ΦM**, press **More (1 of 2)**, **ΦM Waveform**, **Noise**

SCPI Commands:

```
[[:SOURce]:PM[1]|2]:INTernal[1]:FUNction:SHApe NOISe
```

```
[[:SOURce]:PM[1]|2]:INTernal[1]:FUNction:SHApe?
```

Ramp

This softkey lets you specify ramp as the phase modulation waveform for the **ΦM Path 1** and **ΦM Path 2** configurations. Notice that the selected waveform applies only to whichever ΦM path configuration you have currently selected.

Softkey Location: Press **FM/ΦM** hardkey, toggle **FM/ΦM** softkey to **ΦM**, press **More (1 of 2)**, **ΦM Waveform**, **Ramp**

SCPI Commands:

```
[[:SOURce]:PM[1]|2]:INTernal[1]:FUNction:SHApe RAMP
```

```
[[:SOURce]:PM[1]|2]:INTernal[1]:FUNction:SHApe?
```

Sine

This softkey lets you specify sine as the phase modulation waveform for the **ΦM Path 1** and **ΦM Path 2** configurations. Notice that the selected waveform applies only to whichever ΦM path configuration you have currently selected.

Softkey Location: Press **FM/ΦM** hardkey, toggle **FM/ΦM** softkey to **ΦM**, press **More (1 of 2)**, **ΦM Waveform**, **Sine**

SCPI Commands:

```
[[:SOURce]:PM[1]|2]:INTernal[1]:FUNction:SHApe SINE
```

```
[[:SOURce]:PM[1]|2]:INTernal[1]:FUNction:SHApe?
```

Square

This softkey lets you to specify square as the phase modulation waveform for the **ΦM Path 1** and **ΦM Path 2** configurations. Notice that the selected waveform applies only to whichever **ΦM** path configuration you have currently selected.

Softkey Location: Press **FM/ΦM** hardkey, toggle **FM/ΦM** softkey to **ΦM**, press **More (1 of 2)**, **ΦM Waveform**, **Square**

SCPI Commands:

```
[[:SOURCE]:PM[1]|2]:INTERNAL[1]:FUNCTION:SHAPE SQUARE
```

```
[[:SOURCE]:PM[1]|2]:INTERNAL[1]:FUNCTION:SHAPE?
```

Swept-Sine

Pressing this softkey reveals a menu of choices for setting the swept-sine phase modulation parameters. In this menu you can set the start and stop **ΦM** rate and the sweep time. You can set the signal generator to a single, externally-triggered sweep on either a negative or positive TTL level or you can choose continuous sweep, triggered immediately. In this menu you can also select either a positive or negative polarity for the TRIGGER OUT signal.

Softkey Location: Press **FM/ΦM** hardkey, toggle **FM/ΦM** softkey to **ΦM**, press **More (1 of 2)**, **ΦM Waveform**, **Swept-Sine**

SCPI Commands:

```
[[:SOURCE]:PM[1]|2]:INTERNAL[1]:FUNCTION:SHAPE SWEPTSINE
```

```
[[:SOURCE]:PM[1]|2]:INTERNAL[1]:FUNCTION:SHAPE?
```

Triangle

This softkey lets you to specify triangle as the frequency modulation waveform for the **ΦM Path 1** and **ΦM Path 2** configurations. Notice that the selected waveform applies only to whichever **ΦM** path configuration you have currently selected.

Softkey Location: Press **FM/ΦM** hardkey, toggle **FM/ΦM** softkey to **ΦM**, press **More (1 of 2)**, **ΦM Waveform**, **Triangle**

SCPI Commands:

```
[[:SOURCE]:PM[1]|2]:INTERNAL[1]:FUNCTION:SHAPE TRIANGLE
```

```
[[:SOURCE]:PM[1]|2]:INTERNAL[1]:FUNCTION:SHAPE?
```

Trigger In Polarity Neg Pos

Press this softkey to toggle between a negative TTL level trigger (0 V) and a positive TTL level trigger (+5 V) for externally triggering swept-sine phase modulation.

This softkey is coupled to the **Trigger In Polarity Neg Pos** softkey for swept-sine AM, FM, and LF Out, and to the **Ext Neg** and **Ext Pos** sweep trigger selections in the Sweep/List Menu. If you set the **Trigger In Polarity Neg Pos** softkey in the Φ M Swept-Sine Menu to **Neg**, the **Trigger In Polarity Neg Pos** softkey is also set to **Neg** for swept-sine AM, FM, and LF Out. And, in addition, if the step or list sweep trigger is set to **Ext Pos**, the trigger selection will automatically be changed to **Ext Neg**. The same softkeys will toggle to **Pos** or to **Ext Pos** if you select **Pos** in the Swept-Sine Φ M Menu.

Conversely, if the **Trigger In Slope Neg Pos** softkey is toggled in the swept-sine AM, FM, or LF Out menus, it will cause the swept-sine Φ M softkey to toggle also. This is also true for the **Ext Neg** and **Ext Pos** step or list sweep trigger selections.

Softkey Location: Press **FM/ Φ M** hardkey, toggle **FM/ Φ M** softkey to Φ M, press **More (1 of 2)**, **Φ M Waveform**, **Swept-Sine**, **Trigger In Polarity Neg Pos**

Status after Normal Preset: Pos

SCPI Commands:

:TRIGger[:SEQuence]:SLOPe POSitive|NEGative

:TRIGger[:SEQuence]:SLOPe?

Trigger Key

This softkey is one of the choices in the Φ M Sweep Trigger menu. With **Trigger Key** selected, when you press the **Trigger** front panel key you immediately trigger a single sweep of swept-sine phase modulation.

The **Trigger** key has autorepeat capability. Hold it down and you will repeatedly trigger sweeps until you release the key.

Softkey Location: Press **FM/ Φ M** hardkey, toggle **FM/ Φ M** softkey to Φ M, press **More (1 of 2)**, **Φ M Waveform**, **Swept-Sine**, **Φ M Sweep Trigger**, **Trigger Key**

Status after Normal Preset: Φ M sweep trigger is set to Immediate

SCPI Commands:

```
[[:SOURCE]:PM[1]]2:INTERNAL[1]:SWEep:TRIGger KEY
```

```
[[:SOURCE]:PM[1]]2:INTERNAL[1]:SWEep:TRIGger?
```

Trigger Out Polarity Neg Pos

This softkey toggles the polarity of the TTL signal that is output at the rear panel TRIGGER OUT connector. When **Trigger Out Polarity Neg Pos** is set to **Pos**, the output signal is asserted high (+5 V) at the start of the swept-sine phase modulation sweep and low (0 V) when the sweep is concluded. Setting **Trigger Out Polarity Neg Pos** to **Neg** reverses the polarity, where a high is 0 V and a low is +5 V.

This softkey is coupled to the **Trigger Out Polarity Neg Pos** softkey in the swept-sine AM, FM, and LF Out menus and the sweep/list menu. When the polarity is toggled for this softkey in any one of these menus, it affects all locations of the softkey.

Softkey Location: Press **FM/ Φ M** hardkey, toggle **FM/ Φ M** softkey to Φ M, press **More (1 of 2)**, **Φ M Waveform**, **Swept-Sine**, **Trigger Out Polarity Neg Pos**

Status after Normal Preset: Pos

SCPI Commands:

```
:TRIGger:OUTPut:POLarity POSitive|NEGative
```

```
:TRIGger:OUTPut:POLarity?
```

Power Switch

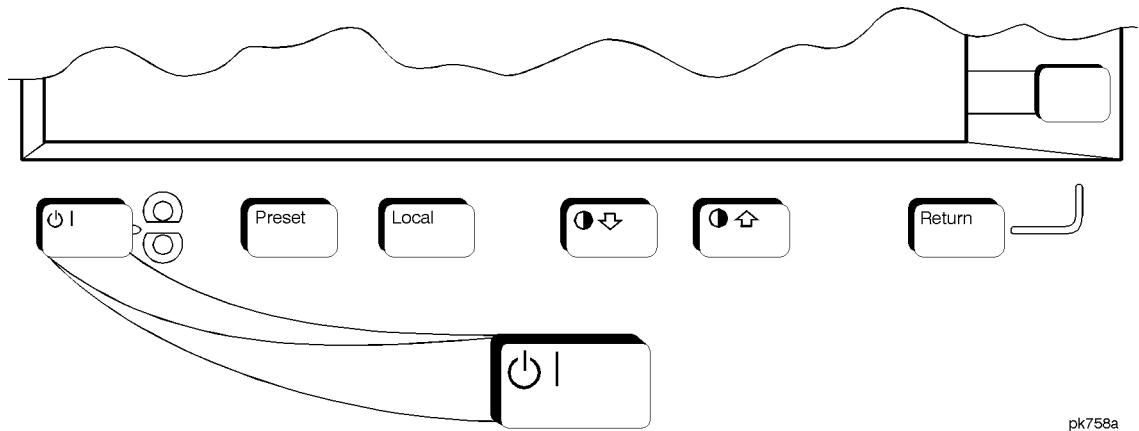

Pressing this front panel key toggles power to the signal generator either on (green LED on) or to standby (yellow LED on). In standby mode, the power switch is off but the instrument is still connected to the mains circuit by way of the power cord. The detachable power cord is the instrument disconnecting device. The front panel power switch, therefore, is not, and should not be used as, a line switch.

CAUTION:

Avoid turning off power to the signal generator unless it is quiescent (not currently changing state as a result of front panel operation or remote control).

Hardkey and Softkey Reference
Power Switch

Preset

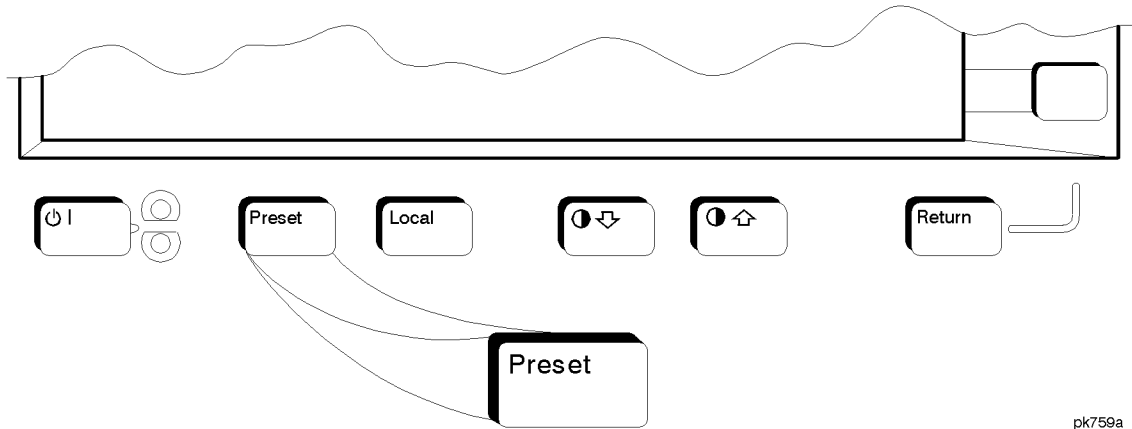

This key sets the signal generator to a known state (either the factory-defined state or a user-defined state). The factory-defined preset conditions are shown in the following table. To set your signal generator to default to these conditions, set the **Preset Normal User** softkey to **Normal**. Or you can define your own preset conditions and set your signal generator to preset to that unique state. Refer to the **Preset Normal User** softkey description which is part of the **Utility** key section.

SCPI Commands:

:SYSTem:PRESet

Table 5-3. Factory-Defined Preset Conditions

Amplitude			
Parameter	Condition	Parameter	Condition
Amplitude	-135 dBm	Amplitude Increment	Persistent State
Amplitude Offset	0.0 dB	Amplitude Offset Increment	Persistent State
Amplitude Reference	Off	Attenuator Hold	Off
ALC	On	Power Search	Manual
ALC BW	Normal		
Amplitude Modulation			
Parameter	Condition	Parameter	Condition
AM Path	1	AM	Off
AM Depth	0.1%	AM Depth Increment	Persistent State
AM Rate	400 Hz	AM Rate Increment	1.0 kHz
AM Source	Internal	AM Waveform	Sine
AM Depth Coupling	Off		
Display			
Parameter	Condition	Parameter	Condition
Brightness	Persistent State	Inverse Video	Off
Screen Saver (Off/On)	Persistent State	Screen Saver Mode	Persistent State
Screen Saver Delay	Persistent State		
Frequency			
Parameter	Condition	Parameter	Condition
Frequency	Max. Specified	Frequency Increment	Persistent State
Frequency Offset	0.0 Hz	Frequency Offset Increment	Persistent State
Frequency Reference	Off	Frequency Multiplier	1
Phase Adjustment	0.0 Radians	Phase Adjustment Increment	Persistent State
Phase Noise Optimization	Mode 2		

Table 5-3. Factory-Defined Preset Conditions

Frequency Modulation			
Parameter	Condition	Parameter	Condition
FM Path	1	FM	Off
FM Deviation	1.0 kHz	FM Deviation Increment	Persistent State
FM Rate	400 Hz	FM Rate Increment	Persistent State
FM Source	Internal	FM Waveform	Sine
FM Deviation Coupling	Off		
Help Mode			
Parameter	Condition	Parameter	Condition
Help Mode (Single/Continuous)	Persistent State		
HP-IB/RS-232			
Parameter	Condition	Parameter	Condition
HP-IB Address	Persistent State	Remote Language	SCPI
RS-232 Baud Rate	Persistent State	RS-232 Echo	Persistent State
Transmit Pace	Persistent State	Receive Pace	Persistent State
RTS	Persistent State		
Instrument Adjustments			
Parameter	Condition	Parameter	Condition
Step/Knob Ratio	Persistent State		
Instrument Information			
Parameter	Condition	Parameter	Condition
Modulation Status Information	On		
LF Output			
Parameter	Condition	Parameter	Condition
LF Out	On	LF Out Source	Internal
LF Out Amplitude	0.0 V	LF Out Amplitude Increment	Persistent State
LF Out Modulation Frequency	400 Hz	LF Out Modulation Freq. Incr.	Persistent State
LF Out Period	80 μ s	LF Out Period Increment	Persistent State

Table 5-3. Factory-Defined Preset Conditions

LF Out Width	40 μ s	LF Out Width Increment	Persistent State
LF Out Waveform	Sine		
Memory Catalog			
Parameter	Condition	Parameter	Condition
Catalog Type	Persistent State		
Phase Modulation			
Parameter	Condition	Parameter	Condition
Φ M Path	1	Φ M	Off
Φ M Deviation	0.0 Radians	Φ M Deviation Increment	Persistent State
Φ M Bandwidth	Normal	Φ M Source	Internal
Φ M Rate	400 Hz	Φ M Rate Increment	1 kHz
Φ M Waveform	Sine	Φ M Deviation Coupling	Off
Power On/Preset			
Parameter	Condition	Parameter	Condition
Power On (Last/Preset)	Persistent State	Preset Language	Persistent State
Preset (Normal/User)	Persistent State	Reverse Power Protection (Normal/HP8648)	Persistent State
PN9 Mode Preset	Normal		
Pulse Modulation			
Parameter	Condition	Parameter	Condition
Pulse Modulation	Off	Pulse Source	Internal Pulse
Pulse Period	80 μ s	Pulse Period Increment	Persistent State
Pulse Width	40 μ s	Pulse Width Increment	Persistent State
Sweep List			
Parameter	Condition	Parameter	Condition
Sweep	Off	Sweep Type	List
Step Sweep Start Frequency	525 MHz	Step Sweep Stop Frequency	525 MHz
Step Sweep Frequency Increment	Persistent State	Sweep Repeat	Single

Table 5-3.

Factory-Defined Preset Conditions

Step Sweep Start Amplitude	-135 dBm	Step Sweep Stop Amplitude	-135 dBm
Step Sweep Amplitude Increment	Persistent State	Step Sweep Number of Points	2
Step Sweep Dwell Time	2.0 ms	Step Sweep Dwell Time Incr.	Persistent State
Sweep Trigger	Immediate	Point Trigger	Immediate
List Sweep Dwell Type	List	Manual Mode	Off
Sweep Direction	Up	Trigger Out Polarity	Pos

Table 5-4. Factory-Defined Preset Conditions

Amplitude			
Parameter	Condition	Parameter	Condition
Amplitude	-135 dBm	Amplitude Increment	Persistent State
Amplitude Offset	0.00 dB	Amplitude Offset Increment	Persistent State
Amplitude Reference State	Off	Amplitude Reference	0.00 dBm
Attenuator Hold	Off	ALC	On
Power Search	Manual	ALC BW	Normal
Amplitude Modulation			
Parameter	Condition	Parameter	Condition
AM Path	1	AM	Off
AM Depth	0.1%	AM Depth Increment	Persistent State
AM Rate	400 Hz	AM Rate Increment	Persistent State
AM Source	Internal	AM Waveform	Sine
AM Depth Coupling	Off		
Display			
Parameter	Condition	Parameter	Condition
Brightness	Persistent State	Inverse Video	Persistent State
Screen Saver (Off/On)	Persistent State	Screen Saver Mode	Persistent State
Screen Saver Delay	Persistent State	Contrast	Persistent State
Frequency			
Parameter	Condition	Parameter	Condition
Frequency	Max. Specified	Frequency Increment	Persistent State
Frequency Offset	0.00 Hz	Frequency Offset Increment	Persistent State
Frequency Reference State	Off	Frequency Reference	0 Hz
Frequency Multiplier	1	Phase Adjustment	0.000 Radians
Phase Adjustment Increment	Persistent State	Phase Noise Optimization	Mode 2

Table 5-4. Factory-Defined Preset Conditions

Frequency Modulation			
Parameter	Condition	Parameter	Condition
FM Path	1	FM	Off
FM Deviation	1.0 kHz	FM Deviation Increment	Persistent State
FM Rate	400 Hz	FM Rate Increment	Persistent State
FM Source	Internal	FM Waveform	Sine
FM Deviation Coupling	Off		
HP-IB/RS-232			
Parameter	Condition	Parameter	Condition
HP-IB Address	Persistent State	Remote Language	SCPI
RS-232 Baud Rate	Persistent State	RS-232 Echo	Persistent State
Transmit Pace	Persistent State	Receive Pace	Persistent State
HP-IB/RS-232			
Parameter	Condition	Parameter	Condition
RTS	Persistent State		
Instrument Adjustments			
Parameter	Condition	Parameter	Condition
Step/Knob Ratio	Persistent State	Ref Osc Fine	Persistent State
Ref Osc Coarse	Persistent State		
Instrument Info/Help Mode			
Parameter	Condition	Parameter	Condition
Help Mode (Single/Continuous)	Persistent State	Modulation Status Information	On
LF Output			
Parameter	Condition	Parameter	Condition
LF Out	Off	LF Out Source	IntMod
LF Out Amplitude	0.000 V	LF Out Amplitude Increment	Persistent State
LF Out Modulation Frequency	400 Hz	LF Out Modulation Freq. Incr.	Persistent State
LF Out Period	80 μ s	LF Out Period Increment	Persistent State

Table 5-4. Factory-Defined Preset Conditions

LF Output Continued			
Parameter	Condition	Parameter	Condition
LF Out Width	40 μ s	LF Out Width Increment	Persistent State
LF Out Waveform	Sine		
Memory Catalog			
Parameter	Condition	Parameter	Condition
Catalog Type	Persistent State		
Phase Modulation			
Parameter	Condition	Parameter	Condition
Φ M Path	1	Φ M	Off
Φ M Deviation	0.000 Radians	Φ M Deviation Increment	Persistent State
Φ M Bandwidth	Normal	Φ M Source	Internal
Φ M Rate	400 Hz	Φ M Rate Increment	Persistent State
Φ M Waveform	Sine	Φ M Deviation Coupling	Off
UW (Uplink TCH)	E149	UW (Downlink SYNC)	050EF2993
Power On/Preset			
Parameter	Condition	Parameter	Condition
Power On (Last/Preset)	Persistent State	Preset Language	Persistent State
Preset (Normal/User)	Persistent State	Reverse Power Protection (Normal/HP8648)	Persistent State
Pulse Modulation			
Parameter	Condition	Parameter	Condition
Pulse Modulation	Off	Pulse Source	Internal Pulse
Pulse Period	80 μ s	Pulse Period Increment	Persistent State
Pulse Width	40 μ s	Pulse Width Increment	Persistent State
Pulse Rate	400.0 Hz	Pulse Rate Increment	Persistent State

Table 5-4. Factory-Defined Preset Conditions

Sweep List			
Parameter	Condition	Parameter	Condition
Sweep	Off	Sweep Type	List
Step Sweep Start Frequency	Maximum Specified	Step Sweep Stop Frequency	Maximum Specified
Step Sweep Frequency Increment	Persistent State	Sweep Repeat	Single
Step Sweep Start Amplitude	-135 dBm	Step Sweep Stop Amplitude	-135 dBm
Step Sweep Amplitude Increment	Persistent State	Step Sweep Number of Points	2
Step Sweep Dwell Time	2.0 ms	Step Sweep Dwell Time Incr.	Persistent State
Sweep Trigger	Immediate	Point Trigger	Immediate
List Sweep Dwell Type	List	Manual Mode	Off
Sweep Direction	Up	Trigger Out Polarity	Pos

Hardkey and Softkey Reference
Preset

Pulse

Pressing the front panel **Pulse** key reveals a menu of softkeys. These softkeys are described in this section in alphabetical order.

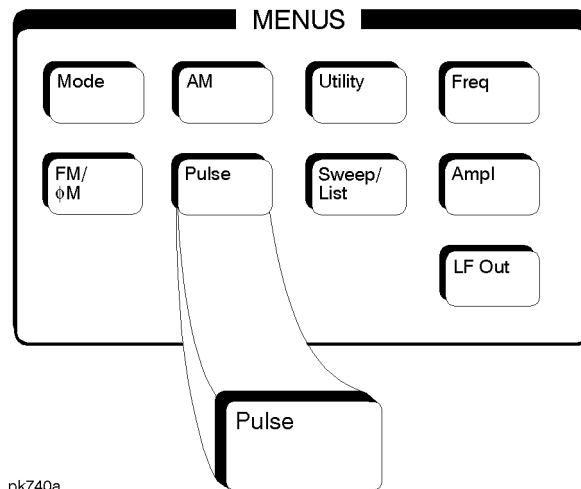

Ext2 DC-Coupled

This softkey lets you input an external, DC-coupled, pulse modulation signal to the EXT 2 INPUT connector.

The external 2 input has multiple uses but can be used for only one modulation at a time. If, for example you were using the external 2 input in a frequency modulation configuration for **FM Path 1**, and then you configured the pulse modulation source to also use the external 2 input, the signal generator would turn off **FM Path 1** and assign the external 2 input to your pulse configuration.

Softkey Location: Press **Pulse**, **Pulse Source**, **Ext2 DC-Coupled**

Status after Normal Preset: Pulse Source is set to Internal Square

SCPI Commands:

```
[[:SOURce]:PULM:SOURce EXTernal2
```

```
[[:SOURce]:PULM:SOURce?
```

Internal Pulse

This softkey lets you internally generate rectangular pulse modulation. Configure the pulse modulation using the **Pulse Period** and **Pulse Width** softkeys. For additional specifications, refer to Chapter 9, “Specifications.”

The internal source has multiple uses but can be used for only one modulation at a time. If, for example you were using the internal source in a frequency modulation configuration for **FM Path 1**, and then you configured the pulse modulation source to also use the internal source, the signal generator would turn off **FM Path 1** and assign the internal source to your pulse configuration.

Softkey Location: Press **Pulse**, **Pulse Source**, **Internal Pulse**

Status after Normal Preset: Pulse Source is set to Internal Square

SCPI Commands:

```
[[:SOURce]:PULM:SOURce INT
```

```
[[:SOURce]:PULM:SOURce?
```

```
[[:SOURce]:PULM:INTernal[1]:FUNction:SHApe <PULSe>
```

```
[[:SOURce]:PULM:INTernal[1]:FUNction:SHApe?
```

Internal Square

This softkey lets you internally generate squarewave pulse modulation. The duty cycle is set at 50% and you can set the pulse rate from 0.1 Hz to 50 kHz. For additional specifications, refer to Chapter 9, “Specifications.”

The internal source has multiple uses but can be used for only one modulation at a time. If, for example you were using the internal source in a frequency modulation configuration for **FM Path 1**, and then you configured the pulse modulation source to also use the internal source, the signal generator would turn off **FM Path 1** and assign the internal source to your pulse configuration.

Softkey Location: Press **Pulse**, **Pulse Source**, **Internal Square**

Status after Normal Preset: Pulse Source is set to Internal Square

SCPI Commands:

```
[[:SOURce]:PULM:SOURce INT
```

```
[[:SOURce]:PULM:SOURce?
```

```
[[:SOURce]:PULM:INTernal[1]:FUNction:SHApe <SQUare>
```

```
[[:SOURce]:PULM:INTernal[1]:FUNction:SHApe?
```

Pulse Off On

This softkey enables the pulse modulation for whichever pulse source you have selected. Notice, however, that although you can enable the pulse modulation state with this softkey, the RF carrier is modulated by the enabled modulation only when you have also set **Mod On/Off** to **On**. Whenever pulse modulation is enabled, the **PULSE** annunciator is turned on in the display.

Softkey Location: Press **Pulse**, **Pulse Off On**

Status after Normal Preset: Off

SCPI Commands:

```
[[:SOURce]:PULM:STATe ON|OFF|1|0
```

```
[[:SOURce]:PULM:STATe?
```

Pulse Period

Use this softkey to change the pulse period for internal pulse modulation. To change the period, press the softkey once. The current value for pulse period is displayed in the active entry area. To enter a new value, rotate the front panel knob until the desired value is displayed, use the up and down arrow keys, or enter the value using the numeric keypad and press the **msec** or **µsec** terminator softkey. The range of values allowed is 16 µs to 30 s. If the value for pulse period is less than the value for pulse width, pulse width is changed to the same value as pulse period. Notice that pulse period applies only to internal pulse modulation; when external pulse modulation or internal square pulse modulation is selected, this softkey is disabled.

Softkey Location: Press **Pulse**, **Pulse Period**

Status after Normal Preset: 80 µs

SCPI Commands:

```
[[:SOURce]:PULM:INTernal[1]:PERiod <val><unit>
```

```
[[:SOURce]:PULM:INTernal[1]:PERiod?
```

Pulse Rate

Use this softkey to change the pulse rate for internal square pulse modulation. To change the rate, press the softkey once. The current value for pulse rate is displayed in the active entry area. To enter a new value, rotate the front panel knob until the desired value is displayed, use the up and down arrow keys, or enter the value using the numeric keypad and press the **Hz** or **kHz** terminator softkey. The range of values allowed is 0.1 Hz to 50 kHz. Notice that the new value of pulse rate applies only to internal square pulse modulation; when external pulse modulation or internal pulse modulation is selected, this softkey is disabled.

Softkey Location: Press **Pulse**, **Pulse Rate**

Status after Normal Preset: 400 Hz

SCPI Commands:

```
[[:SOURce]:PULM:INTernal[1]:FREQuency <val><unit>
```

```
[[:SOURce]:PULM:INTernal[1]:FREQuency?
```

Pulse Width

Use this softkey to change the pulse width for internal pulse modulation. To change the pulse width, press the softkey once. The current value for pulse width is displayed in the active entry area. To enter a new value, rotate the front panel knob until the desired value is displayed, use the up and down arrow keys, or enter the value using the numeric keypad and press the **μsec** or **msec** terminator softkey. The range of values allowed is 8 μs to 30 s. Notice that the new value of pulse width applies only to internal pulse modulation; when external pulse modulation or internal square pulse modulation is selected, this softkey is disabled.

Softkey Location: Press **Pulse**, **Pulse Width**

Status after Normal Preset: 40 μs

SCPI Commands:

```
[[:SOURce]:PULM:INTernal[1]:PWIDth <val><unit>
```

```
[[:SOURce]:PULM:INTernal[1]:PWIDth?
```

Pulse Source

Pressing this softkey reveals a menu of choices for pulse modulation sources. You can choose internally-generated pulse modulation, internally-generated square pulse modulation, or select an externally-applied, DC-coupled signal from the EXT 2 INPUT connector.

The internal and external 2 sources have multiple uses. However, you can use each source for only one modulation type at a time. If, for example, you were using the external 2 source in a frequency modulation configuration for **FM Path 1**, and then you configured the pulse modulation source to also use the external 2 source, the signal generator would turn off **FM Path 1** and assign the external 2 source to your pulse configuration.

Softkey Location: Press **Pulse**, **Pulse Source**

Status after Normal Preset: Internal Pulse

Hardkey and Softkey Reference
Pulse

Recall

Pressing the front panel **Recall** key reveals a menu of softkeys. These softkeys are described in this section in alphabetical order.

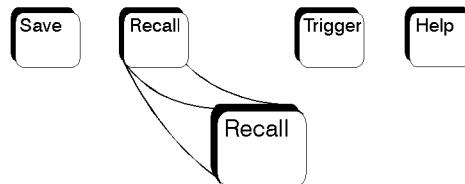

pk752a

Delete All Regs in Seq [n]

Press this softkey to delete the data saved in all of the registers of the selected sequence. Do not press this softkey until you have selected the correct sequence using the **Select Seq** softkey. For example, if you want to delete the data in all of the registers that are saved in sequence 4, press **Select Seq**. The currently selected sequence is displayed in the active entry area. Change the number to 4 using the up and down arrow keys, the front panel knob, or enter a 4 using the numeric keypad and press the **Enter** terminator softkey. Sequence 4 is now displayed in all softkeys which specify a sequence in this menu. Now press **Delete All Regs in Seq [4]** and the data in all of the registers stored in sequence 4 will be deleted. Be certain that you want to delete this data; you cannot recover it once deleted.

NOTE: This softkey has exactly the same function as the softkey with the identical name in the front panel **Save** key menu.

Softkey Location: Press **Recall**, **Delete All Regs in Seq [n]**

Delete All Sequences

Press this softkey to delete all of the data in all saved registers of all sequences. Be certain that you want to delete the data; you cannot recover it once deleted.

NOTE: This softkey has exactly the same function as the softkey with the identical name in the front panel **Save** key menu.

Softkey Location: Press **Recall**, **Delete All Sequences**

Delete Seq[n] Reg[nn]

Press this softkey to delete the contents of a specified register in a specified sequence. Do not press this softkey until you have selected the correct sequence and register using the **Select Seq** and **Recall Reg** softkeys. For example, if you want to delete the contents of register 5 in sequence 4, press **Select Seq**. The currently selected sequence is displayed in the active entry area. Change the number to 4 using the up and down arrow keys, the front panel knob, or enter a 4 using the numeric keypad and press the **Enter** terminator softkey. Sequence 4 is now displayed in all softkeys which specify a sequence in this menu. Now select register 5. (Remember, you must first have saved an instrument state to this register in sequence 4.) Press **Recall Reg**. The recall register number becomes the active function. Enter the number 5 using the numeric keypad and press the **Enter** terminator softkey. The instrument state is restored from this register and register 5 is now displayed in all softkeys which specify a register number in this menu. Now press **Delete Seq [4] Reg[05]** and register 5, stored in sequence 4, will be deleted. The instrument state that you had recalled from this register remains, however, until you change it. If you deleted this register in error, you can immediately resave it using the **Save Seq[n] Reg[n]** softkey in the **Save** menu.

NOTE: This softkey has exactly the same function as the softkey with the identical name in the front panel **Save** key menu.

Softkey Location: Press **Recall, Delete Seq[n] Reg[nn]**

Recall Reg

Press this softkey to recall an instrument state from a saved register. Recalling a register also selects that register number for all softkeys which specify a register number in this menu. For example, if you want to select register 5, press **Recall Reg**. (Remember, you must first have saved an instrument state to this register in the current sequence identified by the **Select Seq** softkey. If there is nothing saved, you cannot recall it.) The recall register number becomes the active function. Enter the number 5 using the numeric keypad and press the **Enter** terminator softkey. The instrument state is restored from this register and register 5 is now displayed in all softkeys which specify a register in this menu. You can also use the front panel knob and the up and down arrow keys to scroll through all saved registers for the selected sequence, recalling each instrument state.

Softkey Location: Press **Recall, Recall Reg**

IEEE 488.2 Common Commands:

*RCL <reg>[, <seq>]

Select Seq

Press this softkey to choose a sequence for all softkeys which specify a sequence in this menu. For example, if you want to select sequence 4, press **Select Seq**. The currently selected sequence is displayed in the active entry area. Change the number to 4 using the up and down arrow keys, the front panel knob, or enter a 4 using the numeric keypad and press the **Enter** terminator softkey. Sequence 4 is now displayed in all softkeys which specify a sequence in this menu. There are 100 registers available (0 through 99) in each of 10 (0 through 9) sequences. You can use these registers in any combination so long as the total number of registers used does not exceed 50.

NOTE:

The actual number of states that can be saved may be less if the user file system has non-instrument state files stored such as sweep/list sequences.

Softkey Location: Press **Recall, Select Seq**

Hardkey and Softkey Reference
Recall

Return

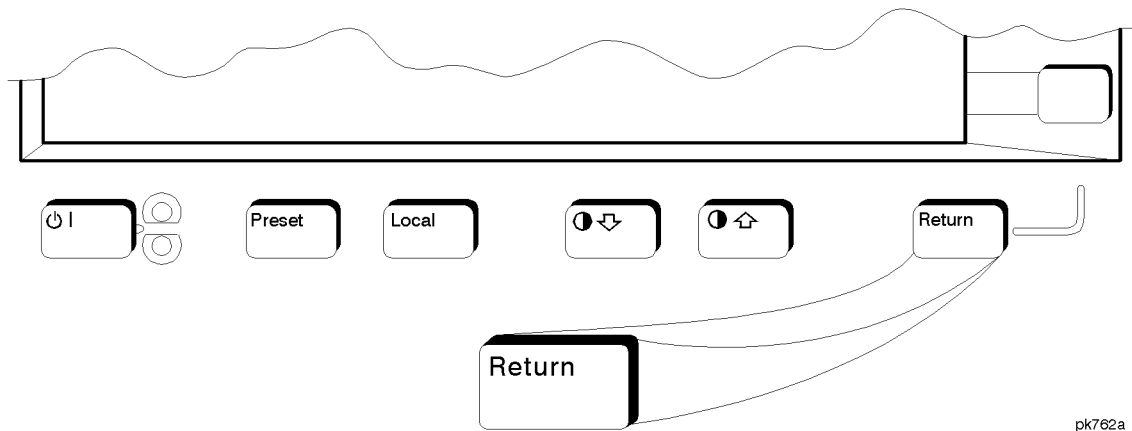

This front panel hardkey moves you from your current softkey menu to the softkey menu that precedes it. For example, press the **LF Out** front panel hardkey. The LF Out menu is displayed. Now press the **LF Out Source** softkey. (The arrow indicates that pressing this softkey will display another menu.) You should now see the LF Out Source menu. Press **Return**, and you are moved back to the LF Out menu.

When you are at the top level of the menus the **Return** key has no function.

The **Return** key has autorepeat capability. Hold it down and you are moved repeatedly back through the menus until you either release the key or you reach the top level of the menus.

While you are entering data with the numeric keypad, pressing the **Return** key cancels the data input and leaves the original value unchanged.

Hardkey and Softkey Reference
Return

RF On/Off

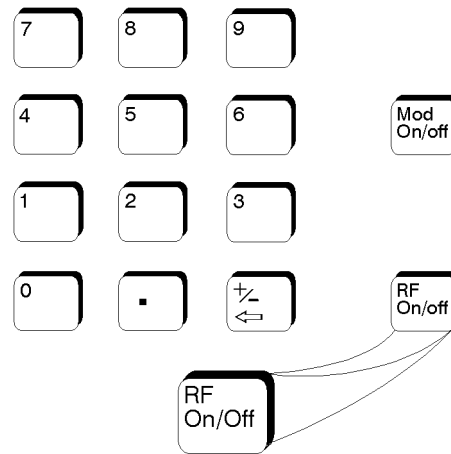

pk757a

This front panel hardkey toggles the RF signal on and off at the RF OUTPUT connector. Although you can configure and engage various modulations, no signal is available at the RF OUTPUT connector until **RF On/Off** is set to **On**. An annunciator is always turned on in the display to indicate whether RF is turned on or off.

Status after Normal Preset: RF Off

SCPI Commands:

:OUTPut[:STATe] ON|OFF|1|0

:OUTPut[:STATe]?

Hardkey and Softkey Reference
RF On/Off

Save

Pressing the front panel **Save** key reveals a menu of softkeys. These softkeys are described in this section in alphabetical order.

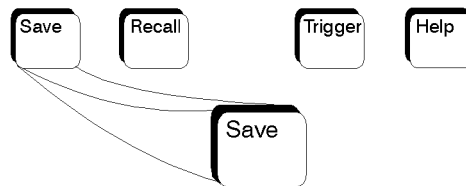

pk751a

When you press the **Save** key, the text area of the display shows the registers in use and any comments associated with the registers for the last sequence accessed. The display is updated whenever you make any changes to the registers or to the comments.

Add Comment To Seq[n] Reg[nn]

Press this softkey to add a comment that is associated with a register in use. The register number is listed in the text area of the display and the comment is shown immediately following the register. You can use the comment line, for example, to identify the instrument state saved in a register.

The comment line can consist of up to 55 alpha-numeric characters and special characters. To add or change a comment, the following editing capabilities are provided:

- The **Editing Mode Insert Replace** softkey in the Editing Keys menu toggles the editing mode from inserting text to replacing text. Insertion mode causes text to be entered in the position directly to the right of the cursor. Replacement mode causes the text to be entered in the position held by the cursor (replacing any existing text in that position).
- The **Clear Text** softkey in the Editing Keys menu deletes all of the existing text in the active entry area.
- Use the left and right arrow keys to position the cursor. Use the front panel knob, up and down arrow keys, or the direct editing softkeys, to enter an alphabetic character, numeral, or special character.

When you have entered the comment text, press the **Enter** terminator softkey. If you have changed your mind, press the **Return** hardkey. Once you press **Enter**, the new comment is saved to your selected register and displayed immediately.

Softkey Location: Press **Save, Add Comment To Seq[n] Reg[nn]**

SCPI Commands:

:MEMory:STATe:COMMeNt <reg_num>,<seq_num>,<comment>

:MEMory:STATe:COMMeNt? <reg_num>,<seq_num>

Clear Text

Press this softkey to delete the comment text in the active entry area. If you want to change the comment text saved with a register, use this softkey to quickly delete the existing text, then use the remaining editing features to enter a new comment.

Softkey Location: Press **Save, Add Comment To Seq[n] Reg[nn], Editing Keys, Clear Text**

Delete All Regs in Seq [n]

Press this softkey to delete the data saved in all of the registers of the selected sequence. Do not press this softkey until you have selected the correct sequence using the **Select Seq** softkey. For example, if you want to delete all of the registers that are saved in sequence 4, press **Select Seq**. The currently selected sequence is displayed in the active entry area. Change the number to 4 using the up and down arrow keys, the front panel knob, or enter a 4 using the numeric keypad and press the **Enter** terminator softkey. Sequence 4 is now displayed in all softkeys which specify a sequence in this menu. Now press **Delete All Regs in Seq [4]** and the data in all of the registers stored in sequence 4 will be deleted. Be certain that you want to delete the data; you cannot recover it once deleted.

NOTE: This softkey has exactly the same function as the softkey with the identical name in the front panel **Recall** key menu.

Softkey Location: Press **Save, Delete All Regs in Seq [n]**

Delete All Sequences

Press this softkey to delete all of the data in all saved registers of all sequences. Be certain that you want to delete the data; you cannot recover it once deleted.

NOTE: This softkey has exactly the same function as the softkey with the identical name in the front panel **Recall** key menu.

Softkey Location: Press **Save, Delete All Sequences**

Delete Seq[n] Reg[nn]

Press this softkey to delete the contents of a specified register in a specified sequence. Do not press this softkey until you have selected the correct sequence and register using the **Select Seq** and **Select Reg** softkeys. For example, if you want to delete register 5 in sequence 4, press **Select Seq**. The currently selected sequence is displayed in the active entry area. Change the number to 4 using the up and down arrow keys, the front panel knob, or enter a 4 using the numeric keypad and press the **Enter** terminator softkey. Sequence 4 is now displayed in all softkeys which specify a sequence number in this menu. Now select register 5, press **Select Reg**. The currently selected register is displayed in the active entry area. Change the number to 5 in the same way that you changed the sequence number. Register 5 is now displayed in all softkeys which specify a register number in this menu. Now press **Delete Seq [4] Reg[05]** and register 5, stored in sequence 4, will be deleted. Be certain that you want to delete the data; you cannot recover the data once deleted.

NOTE: This softkey has exactly the same function as the softkey with the identical name in the front panel **Recall** key menu.

Softkey Location: Press **Save, Delete Seq[n] Reg[nn]**

Editing Keys

Pressing this softkey reveals a menu of choices for creating and editing the comment text for the selected register. In this menu you can delete the existing text in the active entry area (either the existing comment, or comment text that you have subsequently entered), and you can toggle the editing mode from inserting text to replacing text.

Softkey Location: Press **Save, Add Comment To Seq[n] Reg[nn], Editing Keys**

Editing Mode Insert Replace

Press this softkey to toggle the editing mode from inserting text to replacing text. Insertion mode causes text to be entered in the position directly to the right of the cursor. Replacement mode causes the text to be entered in the position held by the cursor (replacing any existing text in that position).

Softkey Location: Press **Save, Add Comment To Seq[n] Reg[nn], Editing Keys, Editing Mode Insert Replace**

Save Seq[n] Reg[nn]

Press this softkey to save the current instrument state in the specified register and sequence. The instrument state includes all of your setup selections except list and step sweep data and functions which are identified in this manual as persistent states.

Do not press this softkey until you have specified the correct sequence and register using the **Select Seq** and **Select Reg** softkeys. For example, if you want to save to register 5 in sequence 4, press **Select Seq**. The currently selected sequence is displayed in the active entry area. Change the number to 4 using the up and down arrow keys, the front panel knob, or enter a 4 using the numeric keypad and press the **Enter** terminator softkey. Sequence 4 is now displayed in all softkeys which specify a sequence in this menu. Now select register 5, press **Select Reg**. The currently selected register is displayed in the active entry area. Change the number to 5 in the same way that you changed the sequence number. Register 5 is now displayed in all softkeys which specify a register in this menu. Now press **Save Seq [4] Reg[05]** and the current instrument state will be stored in register 5 of sequence 4.

There are 100 registers available (0 through 99) in each of 10 (0 through 9) sequences. You can use these registers in any combination so long as the total number of registers used does not exceed 100.

Softkey Location: Press **Save, Save Seq[n] Reg[nn]**

IEEE 488.2 Common Commands:

*SAV <reg>[, <seq>]

Select Reg

Press this softkey to choose a register for all softkeys which specify a register in this menu. For example, if you want to select register 5, press **Select Reg**. The currently selected register is displayed in the active entry area. Change the number to 5 using the up and down arrow keys, the front panel knob, or enter a 5 using the numeric keypad and press the **Select Reg** terminator softkey. Register 5 is now displayed in all softkeys which specify a register in this menu.

You can also use this softkey to select a register and save the current instrument state to that register. For example, if you want to select and save to register 6, press **Select Reg**. The currently selected register is displayed in the active entry area. Change the number to 6 using the numeric keypad and press the **Save Reg** terminator softkey. Register 6 is now displayed in all softkeys which specify a register in this menu and the current instrument state has been saved to register 6.

There are 100 registers available (0 through 99) in each of 10 (0 through 9) sequences. You can use these registers in any combination so long as the total number of registers used does not exceed 100.

Softkey Location: Press **Save, Select Reg**

Select Seq

Press this softkey to choose a sequence for all softkeys which specify a sequence in this menu. For example, if you want to select sequence 4, press **Select Seq**. The currently selected sequence is displayed in the active entry area. Change the number to 4 using the up and down arrow keys, the front panel knob, or enter a 4 using the numeric keypad and press the **Enter** terminator softkey. Sequence 4 is now displayed in all softkeys which specify a sequence in this menu.

There are 100 registers available (0 through 99) in each of 10 (0 through 9) sequences. You can use these registers in any combination so long as the total number of registers used does not exceed 100.

NOTE:

The actual number of states that can be saved may be less if the user file system has non-instrument state files stored such as sweep/list sequences.

Softkey Location: Press **Save, Select Seq**

Hardkey and Softkey Reference
Save

Sweep/List

Pressing the front panel **Sweep/List** key reveals a menu of softkeys. Using these softkeys you can define a series of points containing frequency, amplitude and dwell time information for the signal generator to sweep. The softkeys are described in this section in alphabetical order.

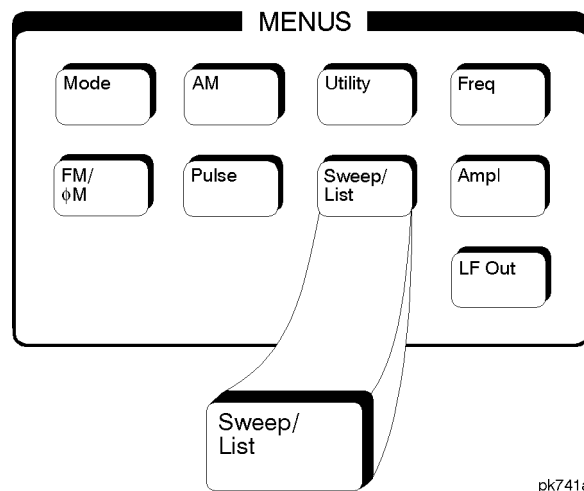

pk741a

Points

Press this softkey to define the number of points in a step sweep. To enter the number of points in the sweep, press **# Points**. The number of step sweep points becomes the active function and the current value is shown in the active entry area. To enter a new value, rotate the front panel knob until the desired value is displayed, use the up and down arrow keys, or enter the value using the numeric keypad and press the **Enter** terminator softkey. A step sweep must always have a minimum of 2 points and can be configured to have as many as 401 points.

Softkey Location: Press **Sweep/List, Configure Step Sweep, # Points**

Status after Normal Preset: 2

SCPI Commands:

```
[[:SOURce]:SWEep:POINts <val>
```

```
[[:SOURce]:SWEep:POINts?
```

Ampl

Press this softkey to set the signal generator to sweep amplitude data only. The frequency is set at a constant value determined by the **Frequency** front panel key. You can define a sweep containing both amplitude and frequency information and still choose to sweep amplitude only.

Softkey Location: Press **Sweep/List**, **Sweep**, **Ampl**

Status after Normal Preset: Sweep is set to Off

SCPI Commands:

```
[[:SOURce]:]POWer:MODE LIST
```

```
[[:SOURce]:]POWer:MODE?
```

Ampl Start

Press this softkey to set the amplitude of the first point in the sweep. You can set the value anywhere in the range of the signal generator's specified output power. Press **Ampl Start** and amplitude becomes the active function for the first point in the sweep. To enter the value, rotate the front panel knob until the desired value is displayed, use the up and down arrow keys, or enter the value using the numeric keypad and press the **dBm**, **dBuV**, **dBuVemf**, **mV**, **uV**, **mVemf**, or **uVemf** terminator softkey.

Softkey Location: Press **Sweep/List**, **Configure Step Sweep**, **Ampl Start**

Status after Normal Preset: -135 dBm

SCPI Commands:

```
[[:SOURce]:]POWer:STARt <val><unit>
```

```
[[:SOURce]:]POWer:STARt?
```

Ampl Stop

Press this softkey to set the amplitude of the last point in the sweep. You can set the value anywhere in the range of the signal generator's specified output power. Press **Ampl Stop** and amplitude becomes the active function for the last point in the sweep. To enter the value, rotate the front panel knob until the desired value is displayed, use the up and down arrow keys, or enter the value using the numeric keypad and press the **dBm**, **dBuV**, **dBuVemf**, **mV**, **uV**, **mVemf**, or **uVemf** terminator softkey.

Softkey Location: Press **Sweep/List**, **Configure Step Sweep**, **Ampl Stop**

Status after Normal Preset: -135 dBm

SCPI Commands:

```
[[:SOURce]:]POWER:STOP <val><unit>
```

```
[[:SOURce]:]POWER:STOP?
```

Bus

This softkey is one of the choices in both the Sweep Trigger menu and the Point Trigger menu. Press either the **Sweep Trigger** softkey or the **Point Trigger** softkey to view these menus. Choosing **Bus** in the Sweep Trigger menu allows you to trigger a list or step sweep using the HP-IB. Choosing **Bus** in the Point Trigger menu allows you to trigger a sweep point-by-point using the HP-IB via *TRG or the GET line (Group Execute Trigger).

Softkey Location: Press **Sweep/List**, **More (1 of 2)**, **Sweep Trigger**, **Bus** or press **Sweep/List**, **More (1 of 2)**, **Point Trigger**, **Bus**

Status after Normal Preset: Sweep and point trigger are set to Immediate

SCPI Commands:

```
[[:SOURce]:]LIST:TRIGger:SOURce BUS
```

```
[[:SOURce]:]LIST:TRIGger:SOURce?
```

Configure List Sweep

Pressing this softkey reveals a menu of softkeys for defining a list sweep. In this menu you can insert and delete points in a sweep. Each point can contain frequency, amplitude, and dwell time information. The list point information is stored in three binary files: `FREQ_FILE`, `POW_FILE`, and `DWEL_FILE`. These files will survive a preset but not a power cycle. If they are deleted, the signal generator will recreate these files as needed. In this menu you can also edit existing points in the sweep.

Softkey Location: Press **Sweep/List, Configure List Sweep**

SCPI Commands:

```
[[:SOURce]:LIST:DWELl <val>{, <val>}  
[:SOURce]:LIST:DWELl?  
[:SOURce]:LIST:DWELl:POINts?  
[:SOURce]:LIST:FREQuency <val>{, <val>}  
[:SOURce]:LIST:FREQuency?  
[:SOURce]:LIST:FREQuency:POINts?  
[:SOURce]:LIST:POWer <val>{, <val>}  
[:SOURce]:LIST:POWer?  
[:SOURce]:LIST:POWer:POINts?
```

Configure Step Sweep

Pressing this softkey reveals a menu of softkeys for defining a step sweep. In this menu you can set the start and stop frequencies for a sweep, set the start and stop power levels, and you can set the number of points in the sweep with the dwell time at each point.

Softkey Location: Press **Sweep/List, Configure Step Sweep**

Delete File

Press this softkey to delete a file in the catalog listing. Use the up and down arrow keys until the file you wish to delete is highlighted. Press **Delete File** and then press the **Confirm Delete** softkey. Be certain that you want to delete the file; you cannot recover this sweep data once you press **Confirm Delete**. If you do not want to delete the file, press **Return** instead of **Confirm Delete**.

Softkey Location: Press **Sweep/List, Configure List Sweep, More (1 of 2), Load/Store, Delete File**

Delete Item

Press this softkey to delete an item in the displayed list of sweep points. Use the arrow keys until the desired item is highlighted. Then press **Delete Item** to eliminate this item from the sweep list. Be certain that you want to delete this item; you cannot recover it once you have deleted it. If the last item in a list is deleted, it is replaced by the default value.

Softkey Location: Press **Sweep/List, Configure List Sweep, Delete Item**

Delete Row

Press this softkey to delete a selected row in the sweep list. Use the up and down arrow keys until any item is selected in the row you wish to delete. Press **Delete Row** and the entire row is deleted. Be certain that you want to delete the row; you cannot recover this sweep data once you press **Delete Row**. If the last row in a list is deleted, it is replaced by the default value.

Softkey Location: Press **Sweep/List, Configure List Sweep, Delete Row**

Dwell Type List Step

Press this softkey to toggle the dwell time for the list sweep points between the values defined in the list sweep and the value set for step sweep. Choose **List** to sweep with dwell times that you have defined in the list sweep. Choose **Step** and you will sweep each point in the list with a dwell time set by the **Step Dwell** softkey in the Configure Step Sweep menu. When you are sweeping using the step sweep dwell time, the list sweep dwell time values are grayed out to indicate that they are not being used.

Status after Normal Preset: List

Softkey Location: Press **Sweep/List, Configure List Sweep, More (1 of 2), Dwell Type List Step**

SCPI Commands:

```
[[:SOURce]:]LIST:DWELL:TYPE <val>{, <val>}
```

```
[[:SOURce]:]LIST:DWELL:TYPE LIST|STEP
```

```
[[:SOURce]:]LIST:DWELL:TYPE?
```

Edit Item

Press this softkey to change an item in the displayed list of sweep points. Use the arrow keys or the front panel knob until the correct item is highlighted. Press **Edit Item** and the item is displayed in the active entry area. Change the value using the up and down arrow keys, or the front panel knob and press the **Enter** terminator softkey. Or enter a new value using the numeric keypad and then press a units terminator softkey.

A short cut for editing, Auto Edit, is also available. Highlight the item you want to edit. Enter a new value *using the numeric keys*; editing immediately starts for the highlighted item. Press the **Enter** terminator softkey. The new value is stored and the next item is highlighted.

Softkey Location: Press **Sweep/List, Configure List Sweep, Edit Item**

Ext

This softkey is one of the choices in both the Sweep Trigger menu and the Point Trigger menu. Press either the **Sweep Trigger** softkey or the **Point Trigger** softkey to view this key. Choosing **Ext** allows you to trigger a sweep point-by-point on either the negative or positive edge of a signal applied to the TRIGGER IN rear panel connector. Set the polarity of the trigger signal using the **Trigger In Polarity Neg Pos** softkey.

Softkey Location: Press **Sweep/List, More (1 of 2), Sweep Trigger, Ext** or press **Sweep/List, More (1 of 2), Point Trigger, Ext**

Status after Normal Preset: Immediate

SCPI Commands:

```
[[:SOURce]:LIST:TRIGger:SOURce EXTernal  
[:SOURce]:LIST:TRIGger:SOURce?  
:TRIGger[:SEQuence]:SOURce EXTernal  
:TRIGger[:SEQuence]:SOURce?  
:TRIGger[:SEQuence]:SLOPe?
```

Freq

Press this softkey to set the signal generator to sweep frequency data only. The amplitude is set at a constant level determined by the **Amplitude** front panel key. You can define a sweep containing both amplitude and frequency information and still choose to sweep frequency only.

Softkey Location: Press **Sweep/List, Sweep, Freq**

Status after Normal Preset: Sweep is set to Off

SCPI Commands:

```
[[:SOURce]:FREQuency:MODE LIST  
[:SOURce]:FREQuency:MODE?
```

Freq&Ampl

Press this softkey to set the signal generator to sweep both frequency and amplitude data. Both the frequency and the amplitude lists must have the same number of points or they must have only one point. If a list has only one point, then that point is used for each of the other list's points.

Softkey Location: Press **Sweep/List, Sweep, Freq&Ampl**

Status after Normal Preset: Sweep is set to Off

SCPI Commands:

```
[[:SOURce]:POWer:MODE LIST  
[:SOURce]:POWer:MODE?  
[:SOURce]:FREQuency:MODE LIST  
[:SOURce]:FREQuency:MODE?
```

Freq Start

Press this softkey to set the frequency of the first point in the sweep. You can set the value anywhere in the range of the signal generator's specified output frequency. Press **Freq Start** and frequency becomes the active function for the first point in the sweep. To enter the value, rotate the front panel knob until the desired value is displayed, use the up and down arrow keys, or enter the value using the numeric keypad and press the **GHz**, **MHz**, **kHz**, or **Hz** terminator softkey.

Softkey Location: Press **Sweep/List**, **Configure Step Sweep**, **Freq Start**

Status after Normal Preset: Maximum specified frequency

SCPI Commands:

```
[[:SOURce]:]FREQuency:START <val><unit>
```

```
[[:SOURce]:]FREQuency:START?
```

Freq Stop

Press this softkey to set the frequency of the last point in the sweep. You can set the value anywhere in the range of the signal generator's specified output frequency. Press **Freq Stop** and frequency becomes the active function for the last point in the sweep. To enter the value, rotate the front panel knob until the desired value is displayed, use the up and down arrow keys, or enter the value using the numeric keypad and press the **GHz**, **MHz**, **kHz**, or **Hz** terminator softkey.

Softkey Location: Press **Sweep/List**, **Configure Step Sweep**, **Freq Stop**

Status after Normal Preset: Maximum specified frequency

SCPI Commands:

```
[[:SOURce]:]FREQuency:STOP <val><unit>
```

```
[[:SOURce]:]FREQuency:STOP?
```

Goto Bottom Row

Press this softkey to move the selection bar to the bottom row of list sweep points in the Goto Row menu that is accessed from the Configure List Sweep menu. If you are in the Goto Row menu that is accessed from the Load/Store menu, the selection bar moves to the bottom row of the catalog of list files.

Softkey Location: Press **Sweep/List**, **Configure List Sweep**, **Goto Row**, **Goto Bottom Row** or press **Sweep/List**, **Configure List Sweep**, **More (1 of 2)**, **Load/Store**, **Goto Row**, **Goto Bottom Row**

Goto Middle Row

Press this softkey to move the selection bar to the middle row of list sweep points in the Goto Row menu that is accessed from the Configure List Sweep menu. If you are in the Goto Row menu that is accessed from the Load/Store menu, the selection bar moves to the middle row of the catalog of list files.

Softkey Location: Press **Sweep/List, Configure List Sweep, Goto Row, Goto Middle Row** or press **Sweep/List, Configure List Sweep, More (1 of 2), Load/Store, Goto Row, Goto Middle Row**

Goto Row

Pressing this softkey reveals a menu of softkeys that help you move the selection bar through the rows of list sweep points when you are in the Configure List Sweep menu. If you are in the Load/Store menu, the softkey helps you move the selection bar through the catalog of list files. You can also go to a specific row by rotating the front panel knob, using the up and down arrow keys, or entering the row number with the numeric keypad. Once the desired row number is displayed, press the **Enter** terminator softkey.

Softkey Location: Press **Sweep/List, Configure List Sweep, Goto Row** or press **Sweep/List, Configure List Sweep, More (1 of 2), Load/Store, Goto Row**

Goto Top Row

Press this softkey to move the selection bar to the top row of list sweep points in the Goto Row menu that is accessed from the Configure List Sweep menu. If you are in the Goto Row menu that is accessed from the Load/Store menu, the selection bar moves to the top row of the catalog of list files.

Softkey Location: Press **Sweep/List, Configure List Sweep, Goto Row, Goto Top Row** or press **Sweep/List, Configure List Sweep, More (1 of 2), Load/Store, Goto Row, Goto Top Row**

Immediate

This softkey is one of the choices in both the Sweep Trigger menu and the Point Trigger menu. Press either the **Sweep Trigger** softkey or the **Point Trigger** softkey to view these menus. Choosing **Immediate** in the Sweep Trigger menu immediately triggers the current sweep when you press the **Single Sweep** softkey. When sweep repeat is continuous and **Immediate** is chosen for the sweep trigger, then sweeps are triggered consecutively (a new sweep is triggered as soon as the current sweep ends). Choosing **Immediate** in the Point Trigger menu causes the sweep to pause for the dwell time at each point after the hardware has been set up for that point's frequency and amplitude.

Softkey Location: Press **Sweep/List, More (1 of 2), Sweep Trigger, Immediate** or press **Sweep/List, More (1 of 2), Point Trigger, Immediate**

Status after Normal Preset: Sweep and point trigger are set to Immediate

SCPI Commands:

```
[[:SOURce]:LIST:TRIGger:SOURce IMMEDIATE
```

```
[[:SOURce]:LIST:TRIGger:SOURce?
```

Insert Item

Press this softkey to place a copy of the selected item directly below that item in the sweep list. First use the up and down arrow keys until the item you wish to copy is selected. Press **Insert Item** and an identical copy of the selected item is placed below it.

Softkey Location: Press **Sweep/List, Configure List Sweep, Insert Item**

Insert Row

Press this softkey to place a copy of the selected row directly below that row in the sweep list. First use the up and down arrow keys until any item is selected in the row you wish to copy. Press **Insert Row** and an identical copy of the selected row is placed below it.

Softkey Location: Press **Sweep/List, Configure List Sweep, Insert Row**

Load From Selected File

Press this softkey to load the list sweep data from a file into the current sweep list. Use the arrow keys to highlight the desired sweep list file. Press **Load List From Selected File** and the list sweep data from the selected file is loaded into the current list sweep. You can only have one list sweep at a time so the existing list sweep data will be lost unless it is first stored to a file. This softkey is inactive unless at least one list sweep data file has been stored to memory.

Softkey Location: Press **Sweep/List, Configure List Sweep, More (1 of 2), Load/Store, Load From Selected File**

SCPI Commands:

:MEMory:LOAD:LIST <filename>

:MMEMory:LOAD:LIST <filename>

Load List From Step Sweep

Press this softkey to eliminate the existing sweep list data and replace it with the step sweep data points. You can only have one sweep list at a time so be certain that you wish to delete the existing list. You cannot recover the sweep list data once you press **Load List From Step Sweep**.

Softkey Location: Press **Sweep/List, Configure List Sweep, More (1 of 2), Load List From Step Sweep**

Load/Store

Pressing this softkey reveals a menu of choices for storing list sweep data to a file or loading list sweep data from a file into the current sweep list. In this menu you can also delete existing list sweep files.

Softkey Location: Press **Sweep/List, Configure List Sweep, More (1 of 2), Load/Store**

Manual Mode Off On

This softkey toggles manual selection of the current sweep point on and off. When **Manual Mode** is **On**, the selected sweep/list point controls the frequency and amplitude according to the sweep type. The current point in the sweep is displayed in the active entry area and also below the **Manual Point** softkey. This softkey is disabled when **Sweep** is set to **Off**.

Softkey Location: Press **Sweep/List, More (1 of 2), Manual Mode Off On**

Status after Normal Preset: Off

SCPI Commands:

```
[[:SOURce]:]LIST:MODE AUTO|MANual
```

```
[[:SOURce]:]LIST:MODE?
```

Manual Point

Press this softkey to choose a point in the sweep list. When **Manual Mode** is **On**, the selected sweep/list point controls the frequency and amplitude according to the sweep type. The current point number is shown in the active entry area when you press **Manual Point**. The frequency of the point is shown in the frequency area of the display. The amplitude of the point is shown in the amplitude area of the display. You can choose which point to sweep using the up and down arrow keys, the front panel knob, or by entering the point number desired using the numeric keypad and pressing the **Enter** terminator softkey. This softkey is disabled when **Manual Mode Off On** is set to **Off**.

Softkey Location: Press **Sweep/List, More (1 of 2), Manual Point**

Status after Normal Preset: 1

SCPI Commands:

```
[[:SOURce]:]LIST:MANual <val>
```

```
[[:SOURce]:]LIST:MANual?
```

Off

This softkey turns off all sweep functions. The output signal is then set according to the current frequency and amplitude settings defined by the front panel **Frequency** and **Amplitude** keys.

Softkey Location: Press **Sweep/List, Sweep, Off**

SCPI Commands:

[[:SOURce]:FREQuency:MODE CW|FIXED

[[:SOURce]:FREQuency:MODE?

[[:SOURce]:POWer:MODE FIXED

[[:SOURce]:POWer:MODE?

Page Down

Press this softkey to view the next page of list sweep points when you are in the Configure List Sweep menu or to view the next page of the catalog listing when you are in the Load/Store List menu.

Softkey Location: Press **Sweep/List, Configure List Sweep, Goto Row, Page Down** or press **Sweep/List, Configure List Sweep, More (1 of 2), Load/Store, Page Down** or press **Sweep/List, Configure List Sweep, More (1 of 2), Load/Store, Goto Row, Page Down**

Page Up

Press this softkey to view the previous page of list sweep points when you are in the Configure List Sweep menu or to view the previous page of the catalog listing when you are in the Load/Store List menu.

Softkey Location: Press **Sweep/List, Configure List Sweep, Goto Row, Page Up** or press **Sweep/List, Configure List Sweep, More (1 of 2), Load/Store, Page Up** or press **Sweep/List, Configure List Sweep, More (1 of 2), Load/Store, Goto Row, Page Up**

Point Trigger

Pressing this softkey reveals a menu of choices for triggering a sweep point-by-point. You can choose triggering that occurs after the dwell time for the previous point has passed, triggering that is supplied by the HP-IB, triggering on either the positive or negative edge of a signal supplied to the TRIGGER IN connector, or triggering by the front panel **Trigger** key.

Softkey Location: Press **Sweep/List, More (1 of 2), Point Trigger**

Status after Normal Preset: Immediate

SCPI Commands:

```
[[:SOURce]:LIST:TRIGger:SOURce BUS|IMMediate|EXTernal|KEY
```

```
[[:SOURce]:LIST:TRIGger:SOURce?
```

Preset List

Press this softkey to eliminate the current sweep list and replace it with a new list consisting of the following: one point at the maximum specified frequency, with an amplitude of -135 dBm, and a dwell time of 2 ms. Be certain that you want to delete the current sweep list; you cannot recover the information once you press **Preset List**.

Softkey Location: Press **Sweep/List, Configure List Sweep, More (1 of 2), Preset List**

Single Sweep

Press this softkey to arm the sweep. The **ARMED** annunciator will turn on in the display. The signal generator will begin the sweep as soon as the sweep trigger is received. If you have set the sweep trigger to **Immediate**, a sweep is initiated as soon as you arm the sweep. The sweep sets the power and the frequency to the first point of the sweep while it is not initiated or is waiting for the sweep trigger. This softkey is disabled when **Sweep** is set to **Off**.

Softkey Location: Press **Sweep/List, Single Sweep**

SCPI Commands:

```
:INITiate:CONTInuous[:ALL] ON|OFF|1|0
```

```
:INITiate[:IMMediate][:ALL]
```

```
:INITiate[:IMMediate][:ALL]?
```

Step Dwell

Press this softkey to set the dwell time for each point of a step sweep. To set the dwell time, press **Step Dwell**. The current dwell time is displayed in the active entry area. Enter the desired dwell time using the up and down arrow keys, the front panel knob, or enter a value using the numeric keypad and press the **sec** or **msec** terminator softkey. The range of values allowed is 1 ms through 60 s in 1 ms increments. Dwell time is used when the point trigger is **Immediate**. The dwell time is the amount of time the sweep is guaranteed to pause after setting the frequency and power for the current sweep/list point.

Softkey Location: Press **Sweep/List, Configure Step Sweep, Step Dwell**

SCPI Commands:

```
[:SOURce]:SWEep:DWELl <val>
```

```
[:SOURce]:SWEep:DWELl?
```

Store to File

Press this softkey to store the current list sweep data to a file in internal non-volatile memory. Press **Store To File** and you will automatically enter the editing mode to create a file name.

The file name can consist of up to 23 alpha-numeric and special characters. The following steps show you how to create the following example file name, **FREQ 1453 TO 1465 MHZ**:

NOTE:

The following example uses softkeys to enter the file name. You can also use a combination of the front panel knob and the arrow keys to accomplish the same function.

1. Press the softkey labeled **ABCDEFGF**. A menu is revealed containing a softkey for each alphabetic character from A through G.
 2. Press the softkey labeled **F**. An F is entered as the first character in your file name. Notice that the active entry area now shows **Store to: F**.
 3. Enter an R in the file name by pressing the **OPQRSTU** softkey and then pressing the **R** softkey. Enter an E and a Q.
 4. Next enter a space by pressing the **& # + -** softkey and then pressing **█**.
 5. Enter the value 1453 using the numeric keypad.
 6. Enter another space and the letters TO.
 7. Enter another space and the value 1465.
 8. Enter another space and the letters MHZ.
-

9. Now press the **Enter** terminator softkey and the list sweep data is saved with the file name, **FREQ 1453 to 1465 MHZ**. The characters **@LIST** are automatically appended to the file name as file type identification.

Softkey Location: Press **Sweep/List, Configure List Sweep, More (1 of 2), Load/Store, Store To File**

SCPI Commands:

```
:MEMory:STORe:LIST <filename>  
:MMEMory:STORe:LIST <filename>
```

Sweep

Pressing this softkey reveals a menu of choices for determining the sweep parameters. In this menu you can choose to sweep frequency only, amplitude only, or both frequency and amplitude. You can also choose to turn off all sweep functions.

Softkey Location: Press **Sweep/List, Sweep**

Status after Normal Preset: Off

SCPI Commands:

```
[:SOURce]:FREQuency:MODE CW|FIXed|LIST  
[:SOURce]:FREQuency:MODE?  
[:SOURce]:POWer:MODE FIXed|LIST  
[:SOURce]:POWer:MODE?
```

Sweep Direction Down Up

This softkey changes the direction of the sweep. Choose **Up** to sweep from the first point in the list to the last point, or from the step sweep start frequency and amplitude to the stop frequency and amplitude. Choose **Down** to reverse the direction of the sweep.

Softkey Location: Press **Sweep/List, More (1 of 2), Sweep Direction Down Up**

Status after Normal Preset: Up

SCPI Commands:

```
[:SOURce]:LIST:DIRection UP|DOWN  
[:SOURce]:LIST:DIRection?
```

Sweep Repeat Single Cont

This softkey toggles the sweep repetition between single sweep or continuous sweep types. The sweep and point triggers will then trigger the sweep.

Softkey Location: Press **Sweep/List, Sweep Repeat Single Cont**

Status after Normal Preset: Single

SCPI Commands:

```
:INITiate:CONTinuous[:ALL] ON|OFF|1|0  
:INITiate:CONTinuous[:ALL]?
```

Sweep Trigger

Pressing this softkey reveals a menu of choices for triggering a full sweep. You can choose triggering that occurs immediately once a sweep is armed, triggering that is supplied by the HP-IB, triggering on either the positive or negative edge of a signal supplied to the TRIGGER IN connector, or triggering by the front panel **Trigger** key.

Softkey Location: Press **Sweep/List, More (1 of 2), Sweep Trigger**

Status after Normal Preset: Immediate

SCPI Commands:

```
:TRIGger[:SEQuence]:SOURce |BUS|IMMediate|EXTernal|KEY  
:TRIGger[:SEQuence]:SOURce?
```

Sweep Type List Step

This softkey toggles the sweep type from list sweep to step sweep. You create a list sweep by supplying the frequency, amplitude, and dwell time for each point in the sweep. You create a step sweep by supplying the start and stop frequency and amplitude, the number of points, and a dwell time. The signal generator then calculates the points between the first and last point in a linear manner.

Softkey Location: Press **Sweep/List, Sweep Type List Step**

Status after Normal Preset: List

SCPI Commands:

```
[:SOURce]:LIST:TYPE LIST|STEP  
[:SOURce]:LIST:TYPE?
```

Trigger In Polarity Neg Pos

Press this softkey to toggle between a negative TTL level trigger (0 V) and a positive TTL level trigger (+5 V) for externally triggering step or list sweeps.

The **Pos** (and **Neg**) selections for the Trigger In Polarity softkey in the Sweep Trigger and Point Trigger menus are coupled; you cannot choose **Neg** for one and **Pos** for the other. The first selection will follow the second. For example, if you choose **Neg** for the sweep trigger and then choose **Pos** for the point trigger, the sweep trigger selection will automatically change to **Pos**.

If either the sweep trigger or the point trigger is external, the polarity is coupled to the **Trigger In Polarity Neg Pos** softkey for swept-sine AM, FM, Φ M, and LF Out. For example, if you set the sweep trigger to **Pos**, the **Trigger In Polarity Neg Pos** softkey will toggle to **Pos** for swept-sine AM, FM, Φ M, and LF Out. Conversely, if the **Trigger In Slope Neg Pos** softkey is toggled in the swept-sine AM, FM, Φ M, or LF Out menus, it will cause the sweep or point trigger softkeys to toggle also.

Softkey Location: Press **Sweep/List, More (1 of 2), Sweep Trigger, Ext, Trigger In Polarity Neg Pos** or press **Sweep/List, More (1 of 2), Point Trigger, Ext, Trigger In Polarity Neg Pos**

Status after Normal Preset: Pos

SCPI Commands:

```
:TRIGger[:SEQuence]:SLOPe POSitive|NEGative  
:TRIGger[:SEQuence]:SLOPe?
```

Trigger Key

This softkey is one of the choices in both the Sweep Trigger menu and the Point Trigger menu. Press either the **Sweep Trigger** softkey or the **Point Trigger** softkey to view these menus. Choosing **Trigger Key** in the Sweep Trigger menu immediately triggers an armed sweep when you press the **Trigger** front panel key. Choosing **Trigger Key** in the Point Trigger menu immediately triggers the next point in a running sweep.

Softkey Location: Press **Sweep/List, More (1 of 2), Sweep Trigger, Trigger Key** or press **Sweep/List, More (1 of 2), Point Trigger, Trigger Key**

Status after Normal Preset: Sweep and point trigger are set to Immediate

SCPI Commands:

`[:SOURce]:LIST:TRIGger:SOURce KEY`

`[:SOURce]:LIST:TRIGger:SOURce?`

Trigger Out Polarity Neg Pos

This softkey toggles the polarity of the TTL signal that is output at the rear panel TRIGGER OUT connector. When **Trigger Out Polarity Neg Pos** is set to **Pos** the output signal is asserted high (+5 V) at the start of a dwell sequence, or at the start of waiting for the point trigger, and low (0 V) when the dwell is over, or when the point trigger is received. Setting **Trigger Out Polarity Neg Pos** to **Neg** reverses the polarity where a high is 0 V and a low is +5 V.

This softkey is coupled to the **Trigger Out Polarity Neg Pos** softkey in the swept-sine AM, FM, Φ M, and LF Out menus. When the polarity is toggled for this softkey in any one of these menus, it affects all locations of the softkey.

Softkey Location: Press **Sweep/List, More (1 of 2), Trigger Out Polarity Neg Pos**

Status after Normal Preset: Pos

SCPI Commands:

`:TRIGger:OUTPut:POLarity POSitive|NEGative`

`:TRIGger:OUTPut:POLarity?`

Hardkey and Softkey Reference
Sweep/List

Trigger

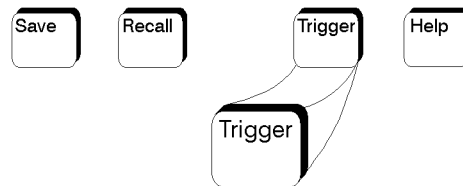

pk753a

Press this front panel hardkey to trigger a specified event or series of events.

- The **Trigger** key can start a step or list sweep under the following conditions:
 - Sweep mode is configured and turned on
 - In single sweep mode, the sweep is armed
 - The **Sweep Trigger** softkey, in the Sweep/List menu, is set to **Trigger Key**
- The **Trigger** key can cause the sweep to step point by point in a step or list sweep under the following conditions:
 - Sweep mode is configured and turned on
 - In single sweep mode, the sweep is armed
 - The **Point Trigger** softkey, in the Sweep/List menu, is set to **Trigger Key**
 - The sweep must be triggered if **Sweep Trigger** is not set to **Immediate**

Also, under these conditions the **Trigger** key has autorepeat capability. Hold it down and it will repeatedly trigger the consecutive points in the sweep.

- The **Trigger** key can start a single sweep of swept-sine amplitude, frequency, or phase modulation under the following conditions:
 - **Trigger Key** is selected in the AM, FM, or Φ M Sweep Trigger menu
 - Swept-sine AM, FM, or Φ M is enabled

Also, under these conditions the **Trigger** key has autorepeat capability. Hold it down and it will repeatedly trigger the sweep. This has the effect of stopping the current sweep, before it finishes, when the key repeat is detected.

- The **Trigger Key** can start an LF swept-sine output under the following conditions:
 - **Function Generator** is selected as the **LF Out Source**.
 - The **LF Out Sweep Trigger** is set to **Trigger Key**.
 - Swept-sine LF out is selected.

Hardkey and Softkey Reference

Trigger

Also, under these conditions the **Trigger** key has autorepeat capability. Hold it down and it will repeatedly trigger the sweep. This has the effect of stopping the current sweep, before it finishes, when the key repeat is detected.

SCPI Commands:

:TRIGger[:SEQuence][:IMMediate]

Utility

Pressing the front panel **Utility** key reveals a menu of softkeys. These softkeys are described in this section in alphabetical order.

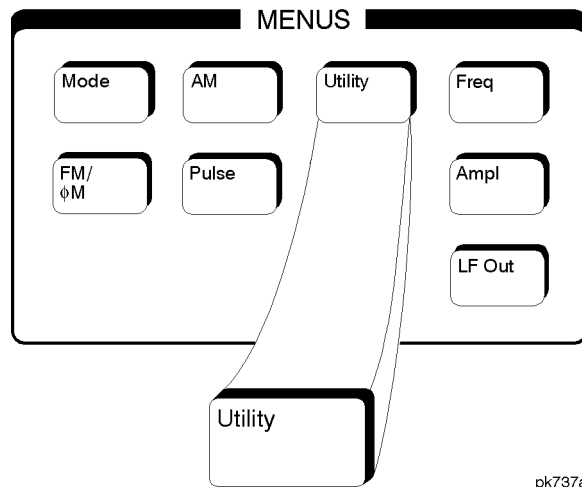

All

This softkey lets you specify that all types of files (including instrument state files, binary user data, and the current sweep list) are to be listed on the display when **Memory Catalog** is selected.

Catalog type is a persistent state; it is not changed by an instrument preset or by a power cycle.

Softkey Location: Press **Utility**, **Memory Catalog**, **Catalog Type**, **All**

SCPI Commands:

:MEMory:CATalog[:ALL]?

Binary

This softkey lets you specify that only binary files are to be listed on the display when **Memory Catalog** is selected.

Catalog type is a persistent state; it is not changed by an instrument preset or by a power cycle.

Softkey Location: Press **Utility, Memory Catalog, Catalog Type, Binary**

SCPI Commands:

:MEMory:CATalog:BINary?

Black Pixels Screen Test

This softkey is provided for factory use in testing the display. Pressing this softkey sets all the pixels on the display to black. Pressing the **Local** front panel key returns the display to normal signal generator operation.

Softkey Location: Press **Utility, Display, Black Pixels Screen Test**

Brightness

Use this softkey to adjust the display brightness (intensity). The display is set to maximum brightness at the factory. To change the brightness, press **Utility, Display, Brightness**. The current value shown in the active entry area is a relative value for brightness. Increasing the number increases the brightness; decreasing the number decreases the brightness. You can adjust the brightness value to any number from 1 through 50. (To adjust the brightness via remote operation, set the value from 0.0 to 1.0.) Use the front panel knob, the up and down arrow keys, or enter a value using the numeric keypad and press the **Enter** terminator softkey.

Brightness is a persistent state; it is not affected by an instrument preset or by a power cycle.

Softkey Location: Press **Utility, Display, Brightness**

SCPI Commands:

:DISPlay:BRIGhtness <value>

:DISPlay:BRIGhtness?

Catalog Type

Pressing this softkey reveals a menu of choices for displaying files. You can choose to display all files (including instrument state files, binary user data, and the current sweep list), binary files only, list files only, or instrument state files only. When you have made your selection, the display is updated and your choice displayed below the **Catalog Type** softkey.

Catalog type is a persistent state; it is not changed by an instrument preset or by a power cycle.

Softkey Location: Press **Utility, Memory Catalog, Catalog Type**

Clear Error Queue(s)

Press this softkey to delete any messages that are stored in the error message queues. (There are separate error queues for front panel operation and for SCPI. Pressing this softkey clears both.) You cannot recover from this action; once the messages are deleted, they are permanently gone. When the error message queue is empty, the **ERR** annunciator is turned off.

Softkey Location: Press **Utility, Error Info, Clear Error Queue(s)**

IEEE 488.2 Common Commands:

*CLS

Clear Text

Press this softkey to delete the existing file name in the active entry area. When you copy from one file to another, the same file name is given to the new file unless you change it. Press **Clear Text** to delete the existing file name and then enter in a new file name using the editing keys provided.

Softkey Location: Press **Utility, Memory Catalog, Copy File, Editing Keys, Clear Text**

Copy File

Press this softkey to copy and rename a file in the displayed catalog of files. To copy a file, first select the file from the displayed list by scrolling through the list using the front panel knob or the up and down arrow keys. When the desired file is highlighted, press **Copy File**. The message **Copy to: <filename>** is displayed in the active entry area where <filename> is the name of the currently selected file. Your copied file will have the same name as the original file so you must rename it. To rename the copied file, the following editing capabilities are provided:

- The **Editing Mode Insert Replace** softkey in the Editing Keys menu toggles the editing mode from inserting text to replacing text. Insertion mode causes text to be entered in the position directly to the right of the cursor. Replacement mode causes the text to be entered in the position held by the cursor (replacing any existing text in that position).
- The **Clear Text** softkey in the Editing Keys menu deletes all of the existing text in the active entry area.
- Use the left and right arrow keys to position the cursor. Use the front panel knob, or the direct editing softkeys, to enter an alphabetic character, numeral, or special character.

When you have entered the new file name, press the **Enter** terminator softkey. If you have changed your mind, press the **Return** hardkey. Once you press **Enter**, the new file is stored and displayed immediately in the catalog list.

Softkey Location: Press **Utility, Memory Catalog, Copy File**

Delete All Binary Files

Press this softkey to delete all of the binary files in the displayed catalog of files. You will then confirm that you want to delete all of the binary files in memory. Press the **Confirm Delete Of Binary Files** terminator softkey and all of the files are deleted. You cannot recover the files after this step. If you have changed your mind and do not wish to delete the files, press the **Return** front panel hardkey instead.

Softkey Location: Press **Utility, Memory Catalog, Catalog Type, Binary, More (1 of 2), Delete All Binary Files**

SCPI Commands:

:MEMory:DELEte:BINary

Delete All Files

Press this softkey to delete all of the files in the displayed catalog of files. You will then confirm that you want to delete all of the files (binary, instrument state, and list files) in memory. Press the **Confirm Delete Of All Files** terminator softkey and all of the files are deleted. You cannot recover the files after this step. If you have changed your mind and do not wish to delete the files, press the **Return** front panel hardkey instead. This softkey does not affect the persistent state or calibration information. If power on mode is set to last, a new last state file will be created when the instrument idles.

Softkey Location: Press **Utility, Memory Catalog, Catalog Type, All, More (1 of 2), Delete All Files**

SCPI Commands:

:MEMory:DELeTe:ALL

Delete All List Files

Press this softkey to delete all of the list files in the displayed catalog of files. You will then confirm that you want to delete all of the list files in memory. Press the **Confirm Delete Of List Files** terminator softkey and all of the list files are deleted. You cannot recover the files after this step. If you have changed your mind and do not wish to delete the file, press the **Return** front panel hardkey instead.

Softkey Location: Press **Utility, Memory Catalog, Catalog Type, List, More (1 of 2), Delete All List Files**

SCPI Commands:

:MEMory:DELeTe:LIST

Delete All State Files

Press this softkey to delete all of the instrument state files in the displayed catalog of files. You will then confirm that you want to delete all of the instrument state files in memory. Press the **Confirm Delete Of State Files** terminator softkey and all of the files are deleted. You cannot recover the files after this step. If you have changed your mind and do not wish to delete the files, press the **Return** front panel hardkey instead.

Softkey Location: Press **Utility, Memory Catalog, Catalog Type, State, More (1 of 2), Delete All State Files**

SCPI Commands:

:MEMory:DELEte:STATe

Delete File

Press this softkey to delete a file in the displayed catalog of files. To delete a file, first select the file from the displayed list by scrolling through the list using the front panel knob or up and down arrow keys. When the desired file is highlighted, press **Delete File**. Then press the **Confirm Delete** terminator softkey and the file is deleted. You cannot recover the file after this step. If you have changed your mind and do not wish to delete the file, press the **Return** front panel hardkey instead.

Softkey Location: Press **Utility, Memory Catalog, Delete File**

SCPI Commands:

:MEMory:DELEte[:NAME] <filename>

Diagnostic Info

Press this softkey for a display of diagnostic information about the signal generator. This information included in the display is:

- Instrument model
- Instrument options
- Instrument serial number
- Current firmware revision
- Current firmware date
- Number of hours the signal generator has been powered on
- Number of hours the display has been lit
- Number of power cycles
- Number of attenuator cycles
- Number of reverse power protection trips

Softkey Location: Press **Utility, Instrument Info/Help Mode, Diagnostic Info**

Display

Pressing this softkey reveals a menu of choices for adjusting and testing the display. In this menu you are able to set up the screen saver, change the display brightness, and perform black and white pixel screen tests.

Softkey Location: Press **Utility, Display**

Editing Keys

Pressing this softkey reveals a menu of choices for editing the name of a file you have just copied. When you copy a file, its name is copied also. As you cannot have two identical file names, use this menu to edit the file name of the copied file. In this menu you can delete the existing text in the active entry area (either the copied file name, or a file name that you have subsequently entered), and you can toggle the editing mode from inserting text to replacing text.

Softkey Location: Press **Utility, Memory Catalog, Copy File, Editing Keys**

Editing Mode Insert Replace

Press this softkey to toggle the editing mode from inserting text to replacing text. Insertion mode causes text to be entered in the position directly to the right of the cursor. Replacement mode causes the text to be entered in the position held by the cursor (replacing any existing text in that position).

Softkey Location: Press **Utility, Memory Catalog, Copy File, Editing Keys, Editing Mode Insert Replace**

Error Info

Pressing this softkey reveals a menu of choices for viewing error messages. In this menu you can view any of the error messages in the queue, and you can clear all of the error messages in the queue.

Softkey Location: Press **Utility, Error Info**

Help Mode Single Cont

This softkey toggles the help mode between single and continuous. In single mode, when you press the **Help** key, help text is provided for the next front panel hardkey or softkey that you press. Your next key press returns you to normal operation. In continuous mode, when you press the **Help** key, help text is provided for the next front panel hardkey or softkey that you press and that key's function is also executed. You will stay in this help mode until you press the **Help** key again.

Help mode is a persistent state; it is not affected by an instrument preset or by a power cycle.

Softkey Location: Press **Utility, Instrument Info/Help Mode, Help Mode Single Cont**

SCPI Commands:

```
:SYSTem:HELP:MODE SINGLE|CONTInuous
```

```
:SYSTem:HELP:MODE?
```

HP8648A/B/C/D

This softkey is one of the choices in both the Preset Language menu and the Remote Language menu. The **HP8648A/B/C/D** softkey is a language choice for the signal generator that is compatible with the remote language commands used by the HP 8648A/B/C/D. Choosing **HP8648A/B/C/D** in the Preset Language menu allows you to select this remote language as the default after a normal preset. Choosing **HP8648A/B/C/D** in the Remote Language menu allows you to immediately change the signal generator to use this remote language.

Softkey Location: Press **Utility, Power On/Preset, Preset Language, HP8648A/B/C/D** or press **Utility, HP-IB/RS-232, Remote Language, HP8648A/B/C/D**

SCPI Commands:

```
:SYSTem:LANGUage "HP8648"
```

```
:SYSTem:LANGUage?
```

```
:SYSTem:PRESet:LANGUage "HP8648"
```

```
:SYSTem:PRESet:LANGUage?
```

HP-IB Address

Press this softkey to change the signal generator's HP-IB address. The HP-IB address is set to 19 at the factory. You can change the address to any number between 0 and 30. To enter a new value, press **Utility, HP-IB/RS-232, HP-IB Address** and rotate the front panel knob, use the up and down arrow keys, or enter the value using the numeric keypad and press the **Enter** terminator softkey.

The HP-IB address setting is a persistent state; it is not affected by an instrument preset or by a power cycle.

Softkey Location: Press **Utility, HP-IB/RS-232, HP-IB Address**

SCPI Commands:

```
:SYSTem:COMMunicate:GPIB:ADDRess <number>
```

```
:SYSTem:COMMunicate:GPIB:ADDRess?
```

HP-IB/RS-232

Pressing this softkey reveals a menu of choices for HP-IB and RS-232 configuration. In this menu, you have the following options:

- Change the HP-IB address of the signal generator.
- Change the remote language of the signal generator.
- Set the baud rate for the RS-232 serial port (AUXILIARY INTERFACE connector).
- Reset the RS-232 serial I/O.
- Turn the RS-232 echo on or off.
- Set the RS-232 handshake protocol.
- Control RS-232 RTS and CTS behavior.

Softkey Location: Press **Utility, HP-IB/RS-232**

Instrument Adjustments

Pressing this softkey reveals a menu of front panel adjustments for the signal generator. The softkeys in this menu provide the following capabilities:

- Adjust the ratio between the front panel knob and the step size for the arrow keys
- Adjust the internal reference oscillator (for use by service personnel only)

Softkey Location: Press **Utility, Instrument Adjustments**

Instrument Info/Help Mode

Pressing this softkey reveals a menu of softkeys for the following functions:

- Display diagnostic information about your signal generator
- Turn on and off the display of information about the status of the modulation modes
- Toggle the help mode between single and continuous

Softkey Location: Press **Utility, Instrument Info/Help Mode**

Inverse Video Off On

The normal display mode for the signal generator is dark text on a light background. Press this softkey to toggle inverse video on (light text on a dark background).

Inverse video is a persistent state; it is not affected by an instrument preset or by a power cycle.

Softkey Location: Press **Utility, Display, Inverse Video Off On**

SCPI Commands:

```
:DISPlay:INVerse ON|OFF|1|0>
```

```
:DISPlay:INVerse?
```

List

This softkey lets you specify that only sweep list files are to be listed on the display when **Memory Catalog** is selected. The sweep list files are stored to memory using the **Store List To File** softkey in the Sweep/List menu.

Catalog type is a persistent state; it is not changed by an instrument preset or by a power cycle.

Softkey Location: Press **Utility, Memory Catalog, Catalog Type, List**

SCPI Commands:

```
:MEMory:CATalog:LIST?
```

Memory Catalog

Pressing this softkey displays the catalog of user files. In addition, it reveals a menu for choosing the type of files that are displayed and for file management. In this menu you can choose to display files by type (all files, instrument state files only, or binary files only), and you can copy and delete files.

Softkey Location: Press **Utility, Memory Catalog**

Mod Status Info Off On

Press this softkey to toggle on and off the modulation status display. When the modulation status is set to on, information about the status of all of the modulations available is shown at any time that you have accessed one of the modulation menus. When the modulation status is set to off, the information about the status of all the modulations is never displayed.

Softkey Location: Press **Utility, Instrument Info/Help Mode, Mod Status Info Off On**

Status after Normal Preset: On

Off

Press this softkey to turn the RTS line off. In this mode, the instrument will ignore the state of the CTS line (3-wire connection). This setting is not compatible with the HP 83300A Remote Interface.

RTS is a persistent state; it is not affected by an instrument preset or by a power cycle.

Softkey Location: Press **Utility, HP-IB/RS-232, RS-232 Pace, RTS/CTS, Off**

SCPI Commands:

:SYSTem:COMMunicate:SERial:CONTRol:RTS OFF

:SYSTem:COMMunicate:SERial:CONTRol:RTS?

Page Down

Press this softkey to move down one page at a time in the displayed catalog of files.

Softkey Location: **Utility, Memory Catalog, Page Down** or press **Utility, Memory Catalog, Goto Row, Page Down**

Page Up

Press this softkey to move up one page at a time in the displayed catalog of files.

Softkey Location: **Utility, Memory Catalog, Page Up** or press **Utility, Memory Catalog, Goto Row, Page Up**

Power On Last Preset

This softkey toggles the power-on state of the signal generator between **Last** and **Preset**.

- If you choose **Last**, each time you cycle power to the signal generator it will turn on in the same condition as when you turned power off. The signal generator must not receive commands for a second before the power is turned off to guarantee that the most recent state is saved.
- If you choose **Preset**, each time you cycle power to the signal generator it will turn on in either the factory-defined preset condition or in a user-defined preset condition. You make the choice between factory- and user-defined preset with the **Preset Normal User** softkey.

The power-on state is a persistent state; it is not affected by an instrument preset or by a power cycle.

Softkey Location: Press **Utility, Power On/Preset, Power On Last Preset**

SCPI Commands:

```
:SYSTem:PON:TYPE PRESet|LAST
```

```
:SYSTem:PON:TYPE?
```

Power On/Preset

Pressing this softkey reveals a menu of choices for preset conditions. In this menu, you have the following options:

- Set the signal generator to power on in the same state as it was when you powered off, or to power on in the instrument preset state. (Refer to the **Power On Last Preset** softkey description, in this section.)
- Set the signal generator to preset to a factory-defined state or to a user-defined state. (Refer to the **Preset Normal User** softkey description, in this section.)
- Set up your own user-defined preset state. (Refer to the **Save Use Preset** softkey description, in this section.)
- Set the signal generator to preset to the SCPI programming language or to an HP 8648

or HP 8656/57-compatible language. (Refer to the **Preset Language** softkey description, in this section.)

- Set the signal generator's reverse power protection to the factory-defined state or to an HP 8648-equivalent state. (Refer to the **Reverse Power Protection Normal HP8648** softkey description.)

Softkey Location: Press **Utility, Power On/Preset**

Preset Language

Pressing this softkey reveals a menu of choices for selecting the programming language that is implemented after the **Preset** key is pressed. You can choose between SCPI, which is the language chosen for the signal generator for remote implementation of all features, HP 8648-compatible, and four versions of HP 8656/57-compatible languages. The HP 8648- and 8656/67-compatible languages are provided for remote implementation of some features so that this signal generator can be compatible with systems that use those instruments. Refer to the programming guide for specifics on which commands are implemented.

The preset language is a persistent state; it is not affected by an instrument preset or by a power cycle.

Softkey Location: Press **Utility, Power On/Preset, Preset Language**

SCPI Commands:

```
:SYSTem:PRESet:LANGUage?
```

Preset Normal User

This softkey toggles the preset state between the factory-defined and the user-defined states. The instrument state conditions for the factory-defined preset state are described in the **Preset** section. You choose the instrument state conditions for the user-defined preset state. Refer to the **Save User Preset** softkey description in this section.

The preset state is a persistent state; it is not changed by an instrument preset or by a power cycle.

Softkey Location: Press **Utility, Power On/Preset, Preset Normal User**

SCPI Commands:

```
:SYSTem:PRESet:TYPE NORMAl|USER
```

```
:SYSTem:PRESet:TYPE?
```

Recall Ref Osc Setting

This softkey is provided for adjusting the internal reference oscillator. This adjustment is for use by service personnel only. Refer to the calibration guide for more information.

Softkey Location: Press **Utility, Instrument Adjustments, Reference Oscillator Adjustment, Recall Ref Osc Setting**

Receive Pace None Xon

This softkey in the RS-232 Pace menu determines whether any pacing is acknowledged by the RS-232 receive channel. If Xon pacing is used, the system will send an Xoff character to suspend the transmitting of data when its buffer is nearly full. When the system is ready to receive further input, an Xon character is sent to the transmitting device. Xon pacing is not recommended if binary data will be queried from the signal generator via RS-232. Toggle **Receive Pace None Xon** to **None** to turn off Xon pacing.

Pace is a persistent state; it is not affected by an instrument preset or by a power cycle.

Softkey Location: Press **Utility, HP-IB/RS-232, RS-232 Pace, Receive Pace None Xon**

SCPI Commands:

```
:SYSTem:COMMunicate:SERial:RECeive:PACE XON|NONE
```

```
:SYSTem:COMMunicate:SERial:RECeive:PACE?
```

Reference Oscillator Adjustment

Pressing this softkey reveals a menu of softkeys for adjusting the internal reference oscillator. This adjustment is for use by service personnel only.

Softkey Location: Press **Utility, Instrument Adjustments, Reference Oscillator Adjustment**

Ref Osc Coarse

This softkey is provided for adjusting the internal reference oscillator. This adjustment is for use by service personnel only. Refer to the calibration guide for more information.

Softkey Location: Press **Utility, Instrument Adjustments, Reference Oscillator Adjustment, Ref Osc Coarse**

Ref Osc Fine

This softkey is provided for adjusting the internal reference oscillator. This adjustment is for use by service personnel only. Refer to the calibration guide for more information.

Softkey Location: Press **Utility, Instrument Adjustments, Reference Oscillator Adjustment, Ref Osc Fine**

Remote Language

Pressing this softkey reveals a menu of choices for immediately changing the signal generator's remote language. You can choose between SCPI, which is the language chosen for the signal generator for remote implementation of all features, HP 8648-compatible, and four versions of HP 8656/57-compatible languages. The HP 8648- and 8656/67-compatible languages are provided for remote implementation of some features so that this signal generator can be compatible with systems that use those instruments. Refer to the programming guide for specifics on which commands are implemented.

Softkey Location: Press **Utility, HP-IB/RS-232, Remote Language**

Status after Normal Preset: SCPI

SCPI Commands:

:SYSTem:LANGuage?

Reset RS-232

Press this softkey to perform a clean-up on the RS-232 buffer which will discard any unprocessed SCPI input received over RS-232 and places the RS-232 connection in a mode which can detect the optional remote interface. All other RS-232 communication parameters (such as baud rate) are unaffected.

Softkey Location: Press **Utility, HP-IB/RS-232, Reset RS-232**

SCPI Commands:

```
:SYSTem:COMMunicate:SERial:RESet
```

Reverse Power Protection Normal HP8648

This softkey toggles the reverse power protection mode between the normal mode for the signal generator and the HP 8648-compatible mode.

When you have selected **Normal** and you trip the reverse power protection circuit, a caution message is displayed and the front panel is locked. Eliminate the source of the excess reverse power detected at the RF OUTPUT connector. Then press the **Reset RPP** softkey to continue normal signal generator operation.

When you have selected **HP8648** and you trip the reverse power protection circuit, a caution message is displayed and the front panel is locked. However, any command sent over HP-IB will reset the RPP circuit and return you to normal signal generator operation. This mode is provided for compatibility with systems that use the HP 8648. It is only available when you have selected HP8648A/B/C/D remote language. At all other times reverse power protection is set to **Normal**. Operate in this mode with *caution*. Repeatedly tripping the RPP can cause damage to the signal generator. It is still best to eliminate the source of the excess reverse power and then reset the reverse power protection circuit by pressing the **Reset RPP** softkey.

The RPP reset mode is a persistent state; it is not affected by an instrument preset or by a power cycle.

Softkey Location: Press **Utility, Power On/Preset, Reverse Power Protection Normal HP8648**

SCPI Commands:

```
:OUTPut:PROTection:MODE "NORMAL"|"HP8648"
```

```
:OUTPut:PROTection:MODE?
```

```
:OUTPut:PROTection:TRIPped?
```

```
:OUTPut:PROTection:CLEar
```

RS-232 Baud Rate

Press this softkey to set the baud rate in bits per second for the rear panel RS-232 connector (this connector is labeled AUXILIARY INTERFACE). To change the baud rate press the softkey. A menu is displayed of baud rates that are allowed. Press the softkey for the desired value. The baud rate is now set to the new value and the value is displayed below the

RS-232 Baud Rate softkey.

Baud rate is a persistent state; it is not affected by an instrument preset or by a power cycle.

Softkey Location: Press **Utility, HP-IB/RS-232, RS-232 Baud Rate**

SCPI Commands:

```
:SYSTem:COMMunicate:SERial:BAUD <number>
```

```
:SYSTem:COMMunicate:SERial:BAUD?
```

RS-232 Echo Off On

This softkey toggles the echo function on and off for the RS-232 serial port (AUXILIARY INTERFACE connector). When echo is set to on, every character sent to the signal generator is immediately sent back. No editing capability is available.

Echo is a persistent state; it is not affected by an instrument preset or by a power cycle.

Softkey Location: Press **Utility, HP-IB/RS-232, RS-232 Echo Off On**

SCPI Commands:

```
:SYSTem:COMMunicate:SERial:ECHO ON|OFF|1|0
```

```
:SYSTem:COMMunicate:SERial:ECHO?
```

RS-232 Pace

Pressing this softkey reveals a menu of choices for setting the RS-232 handshake protocol. In this menu you can choose transmit pacing, receive pacing, and RTS/CTS control.

Softkey Location: Press **Utility, HP-IB/RS-232, RS-232 Pace**

RTS/CTS

Pressing this softkey reveals a menu of choices for controlling the RTS/CTS behavior. This feature is used with RS-232 connections, including the HP 83300A Remote Interface.

RTS is a persistent state; it is not affected by an instrument preset or by a power cycle.

Softkey Location: Press **Utility, HP-IB/RS-232, RS-232 Pace, RTS/CTS**

SCPI Commands:

:SYSTem:COMMunicate:SERial:CONTrol:RTS?

RTS/CTS Pacing

Press this softkey to turn the RTS line on and instruct the signal generator to monitor the state of the CTS line (hardware handshaking). The signal generator monitors CTS and suspends transmission if this line transitions to its logically low state. Up to 16 characters may still be transmitted after the low transition. The signal generator will drop RTS if its receive buffer is nearly full. RTS will be raised again when there is sufficient room in the buffer. This setting is not compatible with an HP 83300A Remote Interface. Do not attempt to use this setting with a 3-wire connection.

RTS is a persistent state; it is not affected by an instrument preset or by a power cycle.

Softkey Location: Press **Utility, HP-IB/RS-232, RS-232 Pace, RTS/CTS, RTS/CTS Pacing**

SCPI Commands:

:SYSTem:COMMunicate:SERial:CONTrol:RTS STANdard

:SYSTem:COMMunicate:SERial:CONTrol:RTS?

RTS On

Press this softkey to turn the RTS line on. In this mode, the instrument will ignore the state of the CTS line (3-wire connection). This setting is intended for use with an HP 83300A Remote Interface, but it will also work with a 3-wire connection. **RTS On** is the default setting for the signal generator.

RTS is a persistent state; it is not affected by an instrument preset or by a power cycle.

Softkey Location: Press **Utility, HP-IB/RS-232, RS-232 Pace, RTS/CTS, ON**

SCPI Commands:

:SYSTem:COMMunicate:SERial:CONTRol:RTS ON

:SYSTem:COMMunicate:SERial:CONTRol:RTS?

Save User Preset

Use this softkey to establish your user-defined preset state. Set up all of the instrument state conditions that you want for your unique preset state. When you have defined the instrument state to suit your needs, press **Save User Preset**. Only one user-defined preset state is allowed, so when you save the instrument state you will save over any previously-saved state. Your instrument state will be recalled by the signal generator any time you press **Preset** as long as you have set the **Preset Normal User** softkey to **User**. For additional information about the **Preset Normal User** softkey, refer to its description in this section.

The user's state definition is a state file; it is not affected by an instrument preset or by a power cycle.

Softkey Location: Press **Utility, Power On/Preset, Save User Preset**

SCPI Commands:

:SYSTem:PRESet[:USER]:SAVE

SCPI

This softkey is one of the choices in both the Preset Language menu and the Remote Language menu. Press either the **Preset Language** softkey or the **Remote Language** softkey to view these menus. SCPI (Standard Commands for Programmable Instruments) is the language chosen for remote implementation of all supported instrument features. Choosing **SCPI** in the Preset Language menu allows you to select this remote language as the default after a normal preset. Choosing **SCPI** in the Remote Language menu allows you to immediately change the signal generator to use this remote language.

Softkey Location: Press **Utility, Power On/Preset, Preset Language, SCPI** or press **Utility, HP-IB/RS-232, Remote Language, SCPI**

SCPI Commands:

```
:SYSTem:PRESet:LANGUage "SCPI"  
:SYSTem:PRESet:LANGUage?  
:SYSTem:LANGUage "SCPI"  
:SYSTem:LANGUage?
```

Screen Saver Delay

This softkey sets the period of time before the screen saver is activated. The screen saver delay is set to 1 hour at the factory. You can change the delay by pressing **Utility, Display, Screen Saver Delay**. The current value for delay is displayed in the active entry area. To enter a new value, rotate the front panel knob, use the up and down arrow keys, or enter the value using the numeric keypad and press the **Enter** terminator softkey. The range of values allowed is 1 through 12 hours in 1 hour increments.

Screen saver delay is a persistent state; it is not affected by an instrument preset or by a power cycle.

Softkey Location: Press **Utility, Display, Screen Saver Delay**

SCPI Commands:

```
:SYSTem:SSAVer:DELay <val>  
:SYSTem:SSAVer:DELay?
```

Screen Saver Mode

This softkey toggles between **Light Only** and **Light & Text** mode for the screen saver. When you set the screen saver to **Light Only**, only the display light is turned on and off. When you set the screen saver to **Light & Text**, the display light and the text are turned on and off.

Screen saver mode is a persistent state; it is not affected by an instrument preset or by a power cycle.

Softkey Location: Press **Utility, Display, Screen Saver Mode**

SCPI Commands:

```
:SYSTem:SSAVer:MODE LIGHT|TEXT
```

```
:SYSTem:SSAVer:MODE?
```

Screen Saver Off On

This softkey toggles the signal generator's screen saver on and off. With the screen saver on, the display is turned off after a period of time with no input from the front panel. The display turns back on when any front panel key is pressed. The screen saver is set to **Off** at the factory. You can turn it on by pressing **Utility, Display Screen Saver**. Each time you press **Screen Saver Off On** the selection toggles between **Off** and **On**.

You can adjust the screen saver mode to turn the light on and off or to turn both the light and text on and off. Refer to the **Screen Saver Mode** softkey description in this section.

The screen saver delay is set to 1 hour at the factory. You can change the delay time. Refer to the **Screen Saver Delay** softkey description in this section.

Screen saver is a persistent state; it is not affected by an instrument preset or by a power cycle.

Softkey Location: Press **Utility, Display, Screen Saver Off On**

SCPI Commands:

```
:SYSTem:SSAVer:STATe ON|OFF|1|0
```

```
:SYSTem:SSAVer:STATe?
```

State

This softkey lets you specify that only instrument state files are to be listed on the display when **Memory Catalog** is selected.

Catalog type is a persistent state; it is not changed by an instrument preset or by a power cycle.

Softkey Location: Press **Utility, Memory Catalog, Catalog Type, State**

SCPI Commands:

:MEMory:CATalog:STATe?

Step/Knob Ratio

This softkey sets the ratio between the increment value of the step keys and the front panel knob. For example, if you set the increment value for frequency to 1 MHz and set the step/knob ratio to 10/1, when frequency is the active function the up and down arrow keys will change the frequency in 1 MHz steps and the front panel knob will change the frequency in 1/10th of 1 MHz steps. This ratio only applies when you have a function active that has an associated increment value.

To change the step/knob ratio, press **Utility, Instrument Adjustments, Step/Knob Ratio**. The number displayed in the active entry area represents the arrow keys step size in the ratio. To enter a new value, rotate the front panel knob until the desired value is displayed, use the up and down arrow keys, or enter the value using the numeric keypad and press the **Enter** terminator softkey.

The step/knob ratio is a persistent state; it is not affected by an instrument preset or by a power cycle.

Softkey Location: Press **Utility, Instrument Adjustments, Step/Knob Ratio**

Store Ref Osc Setting

This softkey is provided for adjusting the internal reference oscillator. This adjustment is for use by service personnel only. Refer to the calibration guide for more information.

Softkey Location: Press **Utility, Instrument Adjustments, Reference Oscillator Adjustment, Store Ref Osc Setting**

Transmit Pace None Xon

This softkey in the RS-232 Pace menu determines whether any pacing is acknowledged by the RS-232 transmit channel. If Xon pacing is used, the system will suspend transmitting data upon receiving an Xoff character until an Xon character is received. The signal generator may not be responsive to other channels, or to the front panel, while transmission is suspended. Xon pacing is not recommended if binary data will be sent to the signal generator via RS-232. Toggle **Transmit Pace None Xon** to **None** to turn off Xon pacing.

Pace is a persistent state; it is not affected by an instrument preset or by a power cycle.

Softkey Location: Press **Utility**, **HP-IB/RS-232**, **RS-232 Pace**, **Transmit Pace None Xon**

SCPI Commands:

```
:SYSTem:COMMunicate:SERial:TRANsmit:PACE XON|NONE
```

```
:SYSTem:COMMunicate:SERial:TRANsmit:PACE?
```

View Next Error Message

If the **ERR** annunciator is turned on in the display, you have at least one error message stored in the error message queue. Use this softkey to display the first error message in the queue. (The first error message is the oldest error.) There may be more than one error message in the queue; the number of error messages is displayed along with the first message. If there is more than one message, continue pressing this softkey to view the rest of the error messages. If you wish to back up and view a message you have already seen, press

View Previous Error Message. Press any front panel key to remove the error message from the display and return to normal signal generator operation.

The error queue can contain up to 30 error messages. When the front panel error queue overflows, error messages are deleted beginning with the oldest ones first. When the SCPI error queue overflows, newer error messages are not recorded.

You can scroll through the error messages in reverse order. Refer to the **View Previous Error Message** softkey description.

Softkey Location: Press **Utility**, **Error Info**, **View Next Error Message**

SCPI Commands:

```
:SYSTem:ERRor[:NEXT]?
```

View Previous Error Message

If the **ERR** annunciator is turned on in the display, you have at least one error message stored in the error message queue. Use this softkey to display the newest error message first. Continue pressing this softkey to view additional error messages in order of newest to oldest. Press any front panel key to remove the error message from the display and return to normal signal generator operation.

Softkey Location: Press **Utility, Error Info, View Previous Error Message**

White Pixels Screen Test

This softkey is provided for factory use in testing the display. Pressing this softkey sets all of the pixels on the display to white. Pressing the front panel Local key returns the display to normal operation.

Softkey Location: Press **Utility, Display, White Pixels Screen Test**

6 Options and Accessories

This chapter describes the options that can be ordered for your signal generator at the time of shipment, the options that can be retrofitted to your existing signal generator, and the upgrades and the accessories that you can order.

Signal Generator Options

This section describes the options available for your signal generator. You can order these options with your signal generator by ordering the option number shown, or you can order these options post-sales by requesting the HP part number that is provided.

Front Handles (Option 1CN)

This kit contains two handles and the necessary hardware to attach the handles to the front of the signal generator. Instructions for assembling the parts are included with the kit. To order this kit after receipt of your signal generator, order HP part number 5063-9227.

Rack Mount Flanges without Handles (Option 1CM)

This kit contains two flanges and the necessary hardware to rack mount the signal generator in an HP System II or System II Plus cabinet. Instructions for assembling the parts are included with the kit. To order this kit after receipt of your signal generator, order HP part number 5063-9214.

Rack Mount Flanges with Handles (Option 1CP)

This kit contains two handles, two flanges, and the necessary hardware to rack mount the signal generator in an HP System II or System II Plus cabinet. Instructions for assembling the parts are included with the kit. To order this kit after receipt of your signal generator, order HP part number 5063-9221.

Three Year Warranty (Option W30)

If you order Option W30 at the point of sale, you will receive a service contract that extends your return-to-HP repair benefits beyond the end of the warranty period for an additional two years. This additional support is not available as a post-sales option.

Move All Front Panel Connectors to Rear Panel (Option 1EM)

If you order Option 1EM at the point of sale, all of the front panel connectors will be moved to the rear panel.

A post-sales retrofit kit is available to move your signal generator's front panel connectors to the rear panel. To order this kit after receipt of your signal generator, request HP part number E4400-60027.

High Stability Timebase (Option 1E5)

If you order Option 1E5 at the point of sale, the standard timebase reference assembly will be replaced with a high-stability timebase reference assembly. The high-stability timebase reference assembly has improved specifications over the standard assembly including warranted specifications for aging rate. (The aging rate specification is typical for the standard assembly.) Refer to Chapter 9, "Specifications," for more information.

Delete Standard Manual Set (Option 0B0)

All instruments are supplied with one complete manual set (HP part number E4400-90075) which includes the following documents:

- User's Guide (HP part number E4400-90076)
- Programming Guide (HP part number E4400-90077)
- Quick Reference Guide (HP part number E4400-90078)
- Calibration Guide (HP part number E4400-90079)

If you order Option 0B0 at the point of sale, you will receive your signal generator with no documentation. If you later decide to purchase the documentation, you can order individual manuals by requesting the individual part numbers, or you can order the complete manual set by ordering HP part number E4400-90075.

Extra Manual Set (Option 0B1)

All instruments are supplied with one complete manual set (HP part number E4400-90075) which includes the following documents:

- User's Guide (HP part number E4400-90076)
- Programming Guide (HP part number E4400-90077)
- Quick Reference Guide (HP part number E4400-90078)
- Calibration Guide (HP part number E4400-90079)

If you order Option 0B1 at the point of sale, you will receive an additional set of this documentation. After shipment of your order, you can order additional manuals by requesting the individual part numbers or you can order the complete manual set by ordering HP part number E4400-90075.

NOTE

Service documentation is not part of the standard manual set. The service documentation is available as Options 0BW, 0BV, and 0BX.

Assembly-Level Service Guide (Option 0BW)

All instruments are supplied with one complete manual set (HP part number E4400-90075) which includes the following documents:

- User's Guide (HP part number E4400-90076)
- Programming Guide (HP part number E4400-90077)
- Quick Reference Guide (HP part number E4400-90078)
- Calibration Guide (HP part number E4400-90079)

If you order Option 0BW, at the point of sale, you will also receive the service guide (HP part number E4400-90008). This document provides the information required to troubleshoot and repair the signal generator to the assembly level. After shipment of your order, you can order additional copies of any of these documents by requesting the individual part numbers.

Component-Level Information Package (Option 0BV)

All instruments are supplied with one complete manual set (HP part number E4400-90075) which includes the following documents:

- User's Guide (HP E4400-90076)
- Programming Guide (HP part number E4400-90077)
- Quick Reference Guide (HP part number E4400-90078)
- Calibration Guide (HP part number E4400-90079)

If you order Option 0BV, at the point of sale, you will also receive the component-level information package (HP part number E4400-90015). This document provides schematics, component locator diagrams, and part lists for the signal generator. After shipment of your order, you can order additional copies of any of these documents by requesting the individual part numbers.

Assembly-Level Service Guide and Component-Level Information Package (Option 0BX)

All instruments are supplied with one complete manual set HP part number E4400-90075) which includes the following documents:

- User's Guide (HP E4400-90076)
- Programming Guide (HP part number E4400-90077)
- Quick Reference Guide (HP part number E4400-90078)
- Calibration Guide (HP part number E4400-90079)

If you order Option 0BX, at the point of sale, you will also receive the service guide (HP part number E4400-90008) and the component-level information package (HP part number E4400-90015). These documents provide you with the information required to troubleshoot and repair the signal generator to the assembly level, and also with schematics, component locator diagrams, and parts lists for the signal generator. After shipment of your order, you can order additional copies of any of these documents by requesting the individual part numbers.

User's Guide - Traditional Chinese for Taiwan (Option AB0)

In addition to the standard English language manual set, if you order Option AB0, at the point of sale, you will receive, at no charge, a subset of the user's guide translated into traditional Chinese for Taiwan. After shipment of your order, you can order additional copies of this document by requesting HP part number E4400-90024. This document is not free of charge when you order it after shipment of your signal generator.

User's Guide - Korean (Option AB1)

In addition to the standard English language manual set, if you order Option AB1, at the point of sale, you will receive, at no charge, a subset of the user's guide translated into Korean. After shipment of your order, you can order additional copies of this document by requesting HP part number E4400-90023. This document is not free of charge when you order it after shipment of your signal generator.

User's Guide - Chinese (Option AB2)

In addition to the standard English language manual set, if you order Option AB2, at the point of sale, you will receive, at no charge, a subset of the user's guide translated into Chinese. After shipment of your order, you can order additional copies of this document by requesting HP part number E4400-90022. This document is not free of charge when you order it after shipment of your signal generator.

User's Guide - German (Option ABD)

In addition to the standard English language manual set, if you order Option ABD, at the point of sale, you will receive, at no charge, a subset of the user's guide translated into German. After shipment of your order, you can order additional copies of this document by requesting HP part number E4400-90027. This document is not free of charge when you order it after shipment of your signal generator.

User's Guide - Spanish (Option ABE)

In addition to the standard English language manual set, if you order Option ABE, at the point of sale, you will receive, at no charge, a subset of the user's guide translated into Spanish. After shipment of your order, you can order additional copies of this document by requesting HP part number E4400-90026. This document is not free of charge when you order it after shipment of your signal generator.

User's Guide - Japanese (Option ABJ)

In addition to the standard English language manual set, if you order Option ABJ at the point of sale, you will receive, at no charge, a subset of the user's guide translated into Japanese. After shipment of your order, you can order additional copies of this document by requesting HP part number E4400-90025. This document is not free of charge when you order it after shipment of your signal generator.

Signal Generator Accessories

This section describes the accessories for the signal generator that can be ordered at any time.

Transit Case (HP Part Number 9211-1296)

The transit case is a sturdy, carrying container designed to protect your signal generator from physical damage during transportation. The interior of the container is lined with compressible foam that is form-fitting to the exterior shape of the signal generator.

Remote Interface (HP 83300A)

The remote interface is an accessory to the signal generator consisting of a keypad which is connected by a 1 meter cable to the AUXILIARY INTERFACE rear panel connector (RS-232). This keypad lets you recall instrument states. (This is the same recall function provided by the front panel keys.) The remote interface is a convenient accessory for use in production environments where multiple instrument states are repetitively utilized.

RS-232 Cable Kit

This kit contains the appropriate hardware (cable, adapters, and null modem) to connect the signal generator RS-232 interface to a computer controller. This hardware will be required for downloading firmware from the HP SoCo Web site. To order this kit, request HP part number E4400-60049.

Upgrade and Retrofit Kits

This section describes the kits available for upgrading an existing signal generator feature and the kits available to retrofit a feature to your signal generator. You can order these kits post-sales by requesting the option number or the HP part number that is provided.

Firmware Upgrade Kit

This kit contains the latest firmware available for the signal generator. Disks are included in the kit in both DOS and UNIX formats. Instructions for downloading the firmware are included. To order this kit, request HP part number E4400-60046.

Firmware Upgrade Kit with Documentation

This kit contains the latest firmware available for the signal generator. Disks are provided in the kit in both DOS and UNIX formats. Instructions for downloading the firmware are included. In addition, the standard documentation set for the signal generator is provided. To order this kit, request HP part number E4400-60054.

Analog to Digital Retrofit Kit

This kit contains all of the hardware and the instructions to retrofit an analog version of the signal generator (HP ESG-X000A) to a digital version (HP ESG-DX000A) with the same upper frequency limit. To order this kit, request HP part number E4400-60047.

Options and Accessories
Upgrade and Retrofit Kits

7 Operation

This chapter is reserved for future use.

Operation

8 Safety and Regulatory

This chapter provides product warranty information, regulatory declarations, and explanations of caution and warning statements marked on the instrument.

Safety Notes

The following safety notes are used throughout this manual. Familiarize yourself with each of the notes and its meaning before operating this instrument.

CAUTION

Caution denotes a hazard. It calls attention to a procedure that, if not correctly performed or adhered to, would result in damage to or destruction of the product. Do not proceed beyond a caution sign until the indicated conditions are fully understood and met.

WARNING

Warning denotes a hazard. It calls attention to a procedure which, if not correctly performed or adhered to, could result in injury or loss of life. Do not proceed beyond a warning note until the indicated conditions are fully understood and met.

Instrument Markings

The following markings and caution and warning labels are used on the instrument. Be sure to observe all cautions and warnings.

WARNING

No user serviceable parts inside. Refer servicing to qualified personnel.



The instruction manual symbol. The product is marked with this symbol when it is necessary for the user to refer to the instructions in the manual.



The CE mark is a registered trademark of the European Community (if accompanied by a year, it is the year when the design was proven).



The CSA mark is the Canadian Standards Association safety mark.



This symbol is used to mark the on position of the power line switch.



This symbol is used to mark the standby position of the power line switch.



This symbol indicates that the input power required is AC.

ISM 1-A

This is a symbol of an Industrial Scientific and Medical Group 1 Class A product. (CISPER 11, Clause 4)

General Safety Considerations

WARNING

**No operator serviceable parts inside. Refer servicing to qualified personnel.
To prevent electrical shock do not remove covers.**

CAUTION

Always use the three-prong AC power cord supplied with this product. Failure to ensure adequate earth grounding by not using this cord may cause product damage.

Statement of Compliance

This product has been designed and tested in accordance with IEC Publication 1010, Safety Requirements for Electronic Measuring Apparatus, and has been supplied in a safe condition. The instruction documentation contains information and warnings which must be followed by the user to ensure safe operation and to maintain the product in a safe condition.

Warranty

This Hewlett-Packard instrument product is warranted against defects in material and workmanship for a period of one year from date of shipment. During the warranty period, Hewlett-Packard Company will, at its option, either repair or replace products which prove to be defective.

For warranty service or repair, this product must be returned to a service facility designated by Hewlett-Packard. Buyer shall prepay shipping charges to Hewlett-Packard and Hewlett-Packard shall pay shipping charges to return the product to Buyer. However, Buyer shall pay all shipping charges, duties, and taxes for products returned to Hewlett-Packard from another country.

Hewlett-Packard warrants that its software and firmware designated by Hewlett-Packard for use with an instrument will execute its programming instructions when properly installed on that instrument. Hewlett-Packard does not warrant that the operation of the instrument, or software, or firmware will be uninterrupted or error-free.

LIMITATION OF WARRANTY

The foregoing warranty shall not apply to defects resulting from improper or inadequate maintenance by Buyer, Buyer-supplied software or interfacing, unauthorized modification or misuse, operation outside of the environmental specifications for the product, or improper site preparation or maintenance.

NO OTHER WARRANTY IS EXPRESSED OR IMPLIED. HEWLETT-PACKARD SPECIFICALLY DISCLAIMS THE IMPLIED WARRANTIES OF MERCHANTABILITY AND FITNESS FOR A PARTICULAR PURPOSE.

EXCLUSIVE REMEDIES

THE REMEDIES PROVIDED HEREIN ARE BUYER'S SOLE AND EXCLUSIVE REMEDIES. HEWLETT-PACKARD SHALL NOT BE LIABLE FOR ANY DIRECT, INDIRECT, SPECIAL, INCIDENTAL, OR CONSEQUENTIAL DAMAGES, WHETHER BASED ON CONTRACT, TORT, OR ANY OTHER LEGAL THEORY.

Assistance

Product maintenance agreements and other customer assistance agreements are available for Hewlett-Packard products. For any assistance, contact your nearest Hewlett-Packard sales and service office. Refer to the list of sales and service offices in Chapter 3.

Certification

Hewlett-Packard Company certifies that this product met its published specifications at the time of shipment from the factory. Hewlett-Packard further certifies that its calibration measurements are traceable to the United States National Institute of Standards and Technology, to the extent allowed by the Institute's calibration facility, and to the calibration facilities of other International Standards Organization members.

Declaration of Conformity

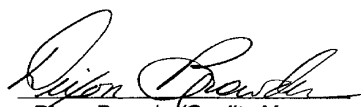
DECLARATION OF CONFORMITY <small>according to ISO/IEC Guide 22 and EN 45014</small>	
Manufacturer's Name:	<i>Hewlett-Packard Co.</i>
Manufacturer's Address:	<i>Microwave Instruments Division 1400 Fountaingrove Parkway Santa Rosa, CA 95403-1799 USA</i>
<i>declares that the product</i>	
Product Name:	<i>Signal Generator</i>
Model Number:	<i>HP ESG-1000A, HP ESG-2000A, HP ESG-2000A, HP ESG-4000A, HP ESG-D1000A, HP ESG-D2000A, HP ESG-D3000A, HP ESG-D4000A,</i>
Product Options:	<i>This declaration covers all options of the above products.</i>
<i>conforms to the following Product specifications:</i>	
<i>Safety: IEC 1010-1:1990+A1 / EN 61010-1:1993 CAN/CSA-C22.2 No. 1010.1-92</i>	
<i>EMC: CISPR 11:1990/EN 55011:1991 Group 1, Class A IEC 801-2:1984/EN 50082-1:1992 4 kV CD, 8 kV AD IEC 801-3:1984/EN 50082-1:1992 3 V/m, 27-500 MHz IEC 801-4:1988/EN 50082-1:1992 0.5 kV Sig. Lines, 1 kV Power Lines</i>	
Supplementary Information: <i>The products herewith comply with the requirements of the Low Voltage Directive 73/23/EEC and the EMC Directive 89/336/EEC and is marked accordingly.</i>	
<i>Santa Rosa, California, USA</i>	<i>3 June 1996</i>
	 <i>Dixon Browder/Quality Manager</i>
<small>European Contact: Your local Hewlett-Packard Sales and Service Office or Hewlett-Packard GmbH, Department HQ-TRE, Herrenberger Strasse 130, D-71034 Böblingen, Germany (FAX +49-7031-14-3143)</small>	

Compliance with German Noise Requirements

This is to declare that this instrument is in conformance with the German Regulation on Noise Declaration for Machines (Laermangabe nach der Maschinenlaermrerordnung -3.GSGV Deutschland).

Acoustic Noise Emission/Geraeuschemission	
LpA < 70 dB	LpA < 70 dB
Operator position	am Arbeitsplatz
Normal position	normaler Betrieb
per ISO 7779	nach DIN 45635 t.19

9 Specifications

This chapter lists the specifications and supplemental characteristics for the HP ESG Series Signal Generators whose serial prefixes are listed on the title page.

HP ESG Series Signal Generators Specifications

Specifications describe the instrument's warranted performance and apply after a 45 minute warm-up. All specifications are valid over the signal generator's entire operating and environmental range while in phase noise mode 2, unless otherwise noted.

Supplemental characteristics (shown in italics and denoted typical or nominal) provide additional, non-warranted, information useful in applying the signal generator.

Frequency

Range:

HP ESG-1000A: 250 kHz to 1000 MHz

HP ESG-2000A: 250 kHz to 2000 MHz

HP ESG-3000A: 250 kHz to 3000 MHz

HP ESG-4000A: 250 kHz to 4000 MHz

Underrange: 100 kHz

Resolution: 0.01 Hz

Accuracy: Same as timebase

Switching Speed¹:

Modulation On: < 45 ms, typical

Modulation Off: < 35 ms, typical

1. To within 0.1 ppm of final frequency above 250 MHz or within 100 Hz below 250 MHz.

Phase Offset: Phase is adjustable via HP-IB or from the front panel in nominal 0.1 degree increments.

Frequency Bands:		
Band	Frequency Range	N #
1	250 kHz to ≤ 249.999 MHz	1
2	> 249.999 to ≤ 500 MHz	0.5
3	> 500 MHz to ≤ 1 GHz	1
4	> 1 to ≤ 2 GHz	2
5	> 2 to 4 GHz	4

Sweep Modes

Operating Modes: Frequency Step, Amplitude Step, and Arbitrary List

Dwell Time: 1 ms to 60 s

Number of Points: 2 to 401

Internal Reference Oscillator

Stability:		
	Standard (typical)	High Stability (Option 1E5)
Aging Rate	$< \pm 2 \text{ ppm/year}$	$< \pm 0.1 \text{ ppm/year}$ or $< \pm 0.0005 \text{ ppm/day}$ after 45 days
Temperature (0 to 55°C)	$< \pm 1 \text{ ppm}$	$< \pm 0.05 \text{ ppm, typical}$
Line Voltage	$< \pm 0.1 \text{ ppm}$ (+5%, -10%)	$< \pm 0.002 \text{ ppm, typical}$ (+5%, -10%)

Timebase Reference Output:

Frequency: 10 MHz

Amplitude: $> 0.35 \text{ V}_{\text{rms}}$ into 50Ω load

External Reference Input:

Frequency: 1, 2, 5, 10 MHz \pm typically 10 ppm (typically 1 ppm, Opt. 1E5)

Amplitude: $> 0.15 \text{ V}_{\text{rms}}$

Input Impedance: 50Ω

Output

Range:

250 kHz to 1000 MHz: +13 to -136 dBm

> 1000 MHz to 3000 MHz: +10 to -136 dBm

> 3000 MHz to 4000 MHz: +7 to -136 dBm

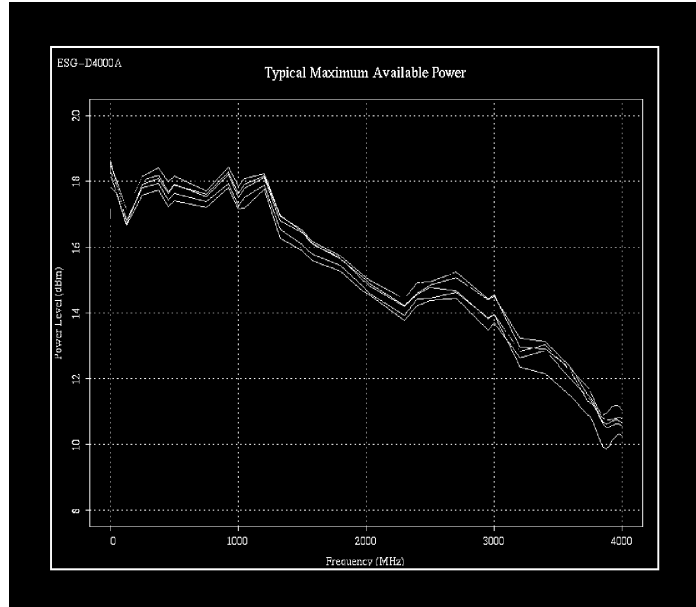

Resolution: 0.02 dB

Attenuator Hold Level Range:

250 kHz to 1000 MHz: 23 dB

> 1000 MHz to 3000 MHz: 20 dB

> 3000 MHz to 4000 MHz: 17 dB

Level Accuracy¹:		
	+7 to -127 dBm	< -127 dBm
250 kHz to 2 GHz:	±0.5 dB	±1.5 dB
> 2 to 4 GHz:	±0.9 dB	±2.5 dB

1. For 23° ±5°C. Accuracy degrades by 0.02 dB per degree C over the full temperature range and by 0.3 dB above +7 dBm.

Specifications
HP ESG Series Signal Generators Specifications

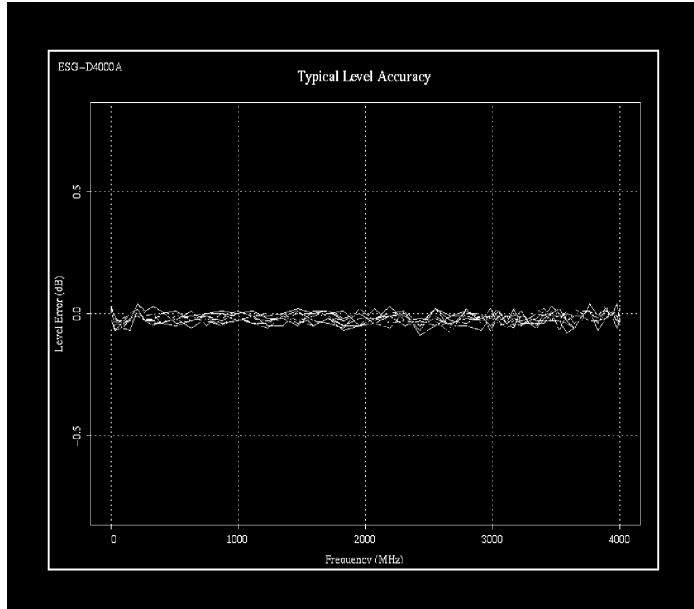

Amplitude Switching Speed: < 25 ms, typical

When Using Power Search: < 210 ms, typical

Reverse Power Protection¹:

250 kHz to 2000 MHz: 50 watts

> 2000 MHz to 4000 MHz: 25 watts

Maximum DC Voltage: 50 V

1. The reverse power protection circuitry triggers at nominally 1 watt.

SWR (typical):

250 kHz to 2000 MHz: < 1.4:1

> 2000 to 4000 MHz: < 1.9:1

Output Impedance: 50Ω

Spectral Purity

SSB Phase Noise (*typical, at 20 kHz offset*):

at 500 MHz: < -120 dBc/Hz

at 1000 MHz: < -116 dBc/Hz

at 2000 MHz: < -110 dBc/Hz

at 3000 MHz: < -104 dBc/Hz

at 4000 MHz: < -104 dBc/Hz

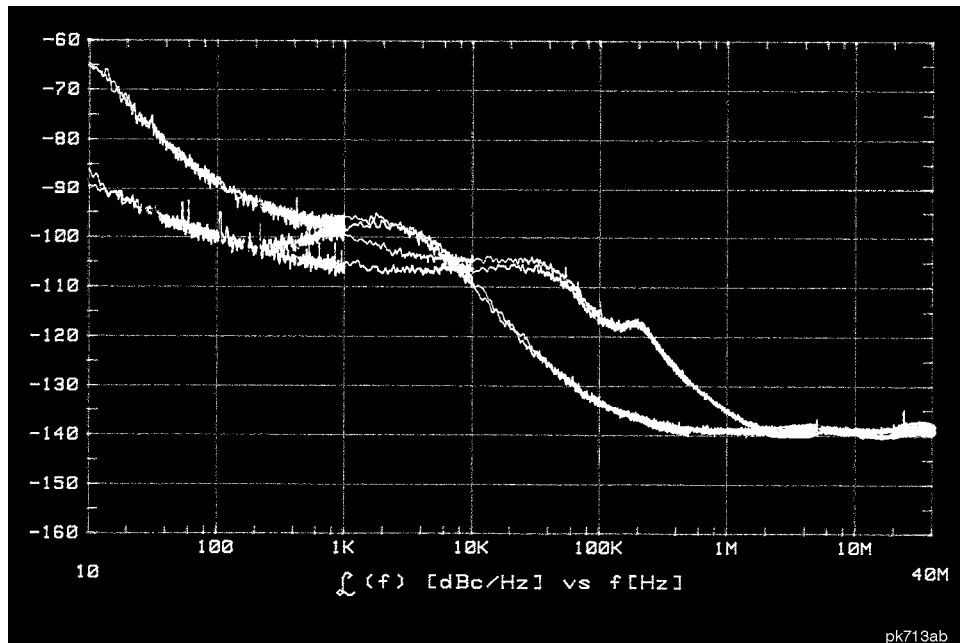

Typical Phase Noise Modes 1 and 2 Single Sideband Phase Noise at 1 GHz

Residual FM (CW mode, 0.3 to 3 kHz BW, CCITT, rms):

Phase Noise Mode 1: $< N \times 2$ Hz

Phase Noise Mode 2: $< N \times 4$ Hz

Harmonics ($\leq +4$ dBm output level): < -30 dBc

Specifications
HP ESG Series Signal Generators Specifications

Nonharmonics (< +7 dBm output level)¹:		
At Offsets:	> 3 kHz	> 10 kHz (<i>typical</i>)
250 kHz to 1000 MHz:	< -65 dBc	< -75 dBc
> 1000 to 2000 MHz:	< -59 dBc	< -69 dBc
> 2000 MHz:	< -53 dBc	< -33 dBc

1. Performance is typical for spurs at frequencies above the maximum operating frequency of the instrument. Performance typically is -60 dBc between 225 and 249.999 MHz. Specifications apply for FM deviations < 100 kHz and are not valid for Φ M.

Subharmonics:

≤ 1000 MHz: None
> 1000 MHz: < -40 dBc

Frequency Modulation

Maximum Deviation: N x 10 MHz

Resolution: 0.1% of deviation or 1 Hz, whichever is greater

Deviation Accuracy: < ±(3.5% of FM deviation setting + 20 Hz)
 (1 kHz rate, deviation < N x 100 kHz)

Modulation Frequency Response ¹ :		
Path	Rates (deviation = 100 kHz)	
	1 dB Bandwidth	3 dB Bandwidth (typical)
FM 1:	(dc/20 Hz to 100 kHz)	dc/5 Hz to 10 MHz
FM 2:	(dc/20 Hz to 100 kHz)	dc/5 Hz to 1 MHz

1. Since the internal modulation source operates over 0.1 Hz to 50 kHz, FM rates above 50 kHz must be supplied externally.

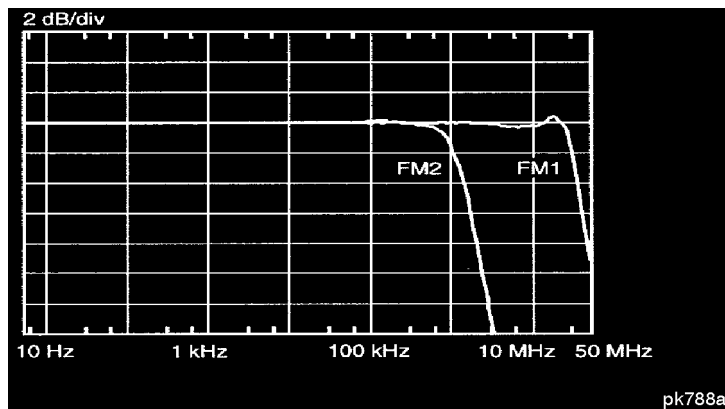

Typical FM 1 and FM 2 Frequency Response

Carrier Frequency Accuracy $\pm 0.1\%$ of set deviation + (N x 1 Hz)
Relative to CW in DCFM¹:

1. At the calibrated deviation and carrier frequency, within 5° C of ambient temperature at time of user calibration.

Distortion (1 kHz rate, THD, Deviations = N x 100 kHz): < 1%

External Inputs: Ext 1 or Ext 2

Sensitivity: 1 Vpk for indicated deviation

Specifications
HP ESG Series Signal Generators Specifications

Input Impedance: 50Ω, nominal

Paths: FM 1 and FM 2 are summed internally for composite modulation. Either path may be switched to any one of the modulation sources: Int, Ext 1, Ext 2. The FM 2 path is limited to a maximum rate of 1 MHz. The FM 2 path must be set to a deviation less than FM 1.

Phase Modulation

Maximum Deviation: N x 90 radians

Resolution: 0.1% of set deviation

Deviation Accuracy (1 kHz rate): < ±(5% of deviation + 0.01 radians)

Modulation Frequency Response:			
Phase Modulation Mode	Maximum Deviation	Rates (3 dB BW)	
		ΦM1	ΦM2
Normal	N x 90 radians:	dc - 100 kHz	dc - 100 kHz
High Bandwidth	N x 2π radians:	<i>dc - 1.5 MHz, typical</i>	<i>dc - 0.9 MHz, typical</i>
	N x π/2 radians:	<i>dc - 4 MHz, typical</i>	<i>dc - 1 MHz, typical</i>

Distortion (1 kHz rate, THD, deviations < N x 90 radians): < 1%

External Inputs: Ext 1 or Ext 2

Sensitivity: 1 Vpk for indicated deviation

Input Impedance: 50Ω, nominal

Paths: Φ M 1 and Φ M 2 are summed internally for composite modulation. Either path may be switched to any one of the modulation sources: Int, Ext 1, Ext2. The Φ M 2 path is limited to a maximum rate of 1 MHz. The Φ M 2 path must be set to a deviation less than Φ M 1.

Amplitude Modulation at $f_c > 500$ kHz

AM is typical above 3 GHz.

Range (envelope peak \leq maximum specified power): 0 to 100%

Rates (3 dB bandwidth): dc/10 Hz to 10 kHz

Resolution: 0.1%

Accuracy (1 kHz rate): $< \pm(5\%$ of setting + 1%)

Distortion (1 kHz rate, THD):

30% AM: $< 1.5\%$

90% AM: $< 4\%$

External Inputs: Ext 1 or Ext 2

Sensitivity: 1 Vpk for indicated depth

Input Impedance: 50Ω , nominal

Paths: AM 1 and AM 2 are summed internally for composite modulation. Either path may be switched to any one of the modulation sources: Int, Ext 1, Ext 2.

Pulse Modulation

On/Off Ratio:

≤ 3 GHz: > 80 dB

< 3 GHz: > 60 dB

Rise/Fall Times: *150 ns, typical*

Minimum Width:

ALC On: *2 μ s, typical*

ALC Off: *0.4 μ s, typical*

Pulse Repetition Frequency:

ALC On: *10 Hz to 250 kHz, typical*

ALC Off: *dc to 1.0 MHz, typical*

Level Accuracy (relative to CW)¹: ± 0.5 dB, typical

1. With ALC off, specifications apply after the execution of power search. With ALC on, specifications apply for repetition rates < 10 kHz and pulse widths ≥ 5 μ s.

External Input: Ext 2

Input Voltage:

RF On: > +0.5 V, nominal

RF Off: < +0.5 V, nominal

Input Impedance: 50 Ω , nominal

Internal Pulse Generator:

Squarewave Rate: 0.1 Hz to 50 kHz

Period: 16 μ s to 30s

Width: 8 μ s to 30s

Resolution: 4 μ s

Internal Modulation Source

Provides FM, Φ M, and AM modulation signals and LF Out.

Waveforms: Sine, Square, Ramp, Triangle, and Noise

Rate Range:

Sine: 0.1 Hz to 50 kHz

Square, Ramp, Triangle: 0.1 Hz to 10 kHz

Specifications
HP ESG Series Signal Generators Specifications

Resolution: 0.1 Hz

Pulse Only: 4 μ s

Frequency Accuracy: 0.005%

Swept Sine Mode (Frequency, Phase Continuous):

Operating Modes: Triggered or Continuous Sweeps

Frequency Range: 0.1 Hz to 50 kHz

Sweep Time: 1 ms to 65s

Resolution: 1 ms

Dual Sinewave Mode:

Frequency Range: 0.1 Hz to 50 kHz

Amplitude Ratio: 0 to 100%

Resolution: 0.1%

LF Out (Internal Modulation Source)

Amplitude: 0 to 3 Vpk into 50 Ω

Output Impedance: < 1 Ω

External Modulation Inputs

Modulation Types:

Ext 1: FM, Φ M, and AM

Ext 2: FM, Φ M, AM, and Pulse

High/Low Indicator: *Indicator is activated when input level error exceeds 3% (nominal)*
(100 Hz to 10 MHz BW, AC-coupled inputs only)

Simultaneous Modulation

All modulation types may be simultaneously enabled, except FM with Φ M, AM, FM and Φ M can sum simultaneous inputs from any two sources (Int, EXT 1, and EXT 2.) Any given source (Int, EXT 1, or EXT 2) may only be routed to one activated modulation type.

Remote Programming

Interface: HP-IB (IEEE-488.2-1987) with Listen and Talk. RS-232

Control Languages: SCPI version 1992.0, also compatible with HP 8656B and 8657A/B/C/D/J¹ mnemonics.

1. HP ESG series does not implement HP 8657A/B 'Standby' or 'On' (R0 or R1, respectively) mnemonics.

Functions Controlled: All front panel functions except power switch and knobs.

IEEE-488 Functions: SH1, AH1, T6, TE0, L4, LE0, SR1, RL1, PP0, DC1, DT0, C0, E2

ISO Compliant

The HP ESG Series RF signal generators are manufactured in an ISO 9001 registered facility in concurrence with Hewlett-Packard's commitment to quality.

General

Power Requirements: 90 to 132 V; 50, 60, or 400 Hz; 250 W maximum
198 to 254 V; 50 or 60 Hz; 250 W maximum

Operating Temperature Range: 0 to 55° C

Storage Temperature Range: -40 to +71 ° C

Shock and Vibration: Meets MIL STD 28800E Type III, Class 3

Leakage: Conducted and radiated interference meets MIL STD 461B RE02 Part 2 and CISPR 11. *Leakage is typically < 1 μV (nominally 0.1 μV with a 2-turn loop) at ≤ 1000 MHz, measured with a resonant dipole antenna one inch from any surface with output level < 0 dBm (all inputs/outputs properly terminated).*

Storage Registers: Up to 100 storage registers with sequence and register number displayed. Up to 10 sequences available.

Weight: < 12.7 kg (28 lb.) net, < 21 kg (46 lb.) shipping

Dimensions: 133 mm H x 426 mm W x 432 mm D
(5.25 in. H x 16.8 in. W x 17 in. D)

Accessories

Transit Case, HP Part Number 9211-1296

HP 83300A Remote Interface

Options

0B0	Delete Manual Set
0B1	Extra Manual Set
0BV	Add Component Level Information Package
0BW	Add Service Documentation (Assembly Level Repair)
0BX	Add Service Documentation and Component Level Information Package
1CM	Rack Flange Kit (without handles)
1CN	Front Handle Kit
1CP	Rack Flange Kit (with handles)
1E5	Add High Stability timebase
1EM	Move All Front Panel Connectors to Rear Panel
W30	Three Year Warranty

Specifications
HP ESG Series Signal Generators Specifications

Index

Symbols

Points softkey, 5-147
ΦM annunciator, 4-8
ΦM Dev Couple Off On softkey, 5-97
ΦM Dev softkey, 5-95
ΦM Dual Sine Ampl Ratio softkey, 5-97
ΦM hardkey, 5-95
ΦM Off On softkey, 5-98
ΦM Path 1 2 softkey, 5-99
ΦM Rate softkey, 5-100
ΦM Source softkey, 5-101
ΦM Start Rate softkey, 5-102
ΦM Stop Rate softkey, 5-103
ΦM Sweep Time softkey, 5-103
ΦM Tone 1 Rate softkey, 5-104
ΦM Tone 2 Rate softkey, 5-105
ΦM Waveform softkey, 5-105

Numerics

10 MHz OUT connector, 4-13

A

AC power receptacle, 4-11
AC symbol, 8-3
accessories, 6-8, 9-16
 remote interface, 6-8
 transit case, 6-8
active entry area, 4-8
add CLIP
 add option, 6-5
add manual set
 add option, 6-4
add service guide
 add option, 6-4
add service guide and CLIP
 add option, 6-5
add user's guide (Chinese)
 add option, 6-6
add user's guide (German)
 add option, 6-6
add user's guide (Japanese)
 add option, 6-7
add user's guide (Korean)
 add option, 6-6
add user's guide (Spanish)
 add option, 6-6
add user's guide (Taiwanese)
 add option, 6-5
Adjust Phase softkey, 5-53
air flow, 1-4

ALC OFF annunciator, 4-8, 5-21
ALC Off On softkey, 5-21
All softkey, 5-169
altitude requirements, 1-5
AM, 5-3
AM annunciator, 4-8
AM Depth Couple Off On softkey, 5-4
AM Depth softkey, 5-3
AM Dual Sine Ampl Ratio softkey, 5-4
AM hardkey, 5-3
AM Off On softkey, 5-5
AM Path 1 2 softkey, 5-5
AM Rate softkey, 5-6
AM Source softkey, 5-7
AM Start Rate softkey, 5-8
AM Stop Rate softkey, 5-9
AM Sweep Time softkey, 5-9
AM sweep trigger
 bus, 5-12, 5-33
 external, 5-12
 immediate, 5-16
 trigger key, 5-19, 5-51, 5-114
AM Sweep Trigger softkey, 5-10, 5-76, 5-104
AM Tone 1 Rate softkey, 5-10, 5-45
AM Tone 2 Rate softkey, 5-11
AM Waveform softkey, 5-11
Ampl hardkey, 5-21
Ampl Offset softkey, 5-22
Ampl Ref Off On softkey, 5-23
Ampl Ref Set softkey, 5-22
Ampl softkey, 5-148
Ampl Start softkey, 5-148
Ampl Stop softkey, 5-149
amplitude display area, 4-7
Amplitude hardkey, 4-5, 5-27
amplitude modulation, 5-3
 setting up, 2-6, 5-5
 specifications, 9-11
amplitude offset, 5-22
amplitude offset, setting, 2-4
amplitude reference, 5-23
 setting, 2-4
amplitude sweep, 5-148
annunciators, 4-8
 ΦM, 4-8
 ALC OFF, 4-8, 5-21
 AM, 4-8
 ARMED, 4-9
 ATTEN HOLD, 4-9
 ERR, 4-9
 EXT REF, 4-9

EXT1 HI, 4-9, 5-7
EXT1 LO, 4-9, 5-7
EXT2 HI, 4-9, 5-7
EXT2 LO, 4-9, 5-7
FM, 4-9
L, 4-9
MOD OFF, 4-9
MOD ON, 4-9
OVEN COLD, 4-9
PULSE, 4-10
RF OFF, 4-10
RF ON, 4-10
S, 4-10
SWEEP, 4-10
T, 4-10
UNLEVEL, 4-10
UNLOCK, 4-10
ARMED annunciator, 4-9
arrow keys, 4-4, 5-29
assistance, 8-7
ATTEN HOLD annunciator, 4-9
Atten Hold Off On softkey, 5-24
attenuator
 hold, 5-24
 number of cycles, 5-174
automatic leveling control, 5-21
AUXILIARY INTERFACE connector, 4-12

B

backspace key, 5-93
baud rate, 5-185
Binary softkey, 5-170
Black Pixels Screen Test softkey, 5-170
Brightness softkey, 5-170
Bus softkey, 5-12, 5-33, 5-67, 5-106, 5-149

C

Canadian Standards Association, 8-3
Catalog Type softkey, 5-171
caution sign, 8-2
CE mark, 8-3
certification
 specifications, 8-8
 traceability, 8-8
changing signs, 5-93
Clear Error Queue(s) softkey, 5-171
Clear Error Text softkey, 5-142, 5-171
command error, 3-11
compliance

Index

- statement of, 8-5
- Configure List Sweep softkey, 5-150
- Configure Step Sweep softkey, 5-150
- connectors
 - 10 MHz OUT, 4-13
 - AUXILIARY INTERFACE, 4-12
 - EXT 1 INPUT, 4-2
 - EXT 2 INPUT, 4-2
 - HP-IB, 4-11
 - LF OUTPUT, 4-3
 - RF OUTPUT, 4-3
 - RS-232, 4-12
 - SWEEP OUT, 4-12
 - TRIGGER IN, 4-13
 - TRIGGER OUT, 4-12
- connectors moved to rear panel
 - add option, 6-3
- cooling holes, 1-4
- Copy File softkey, 5-172
- coupling
 - FM deviation, 5-38
 - phase modulation deviation, 5-97
- CSA mark, 8-3

D

- DC softkey, 5-68
- DC Φ M calibration, 5-106
- DCFM/DC Φ M Cal softkey, 5-34, 5-106
- declaration of conformity, 8-9
- Delete All Binary Files softkey, 5-172
- Delete All Files softkey, 5-173
- Delete All List Files softkey, 5-173
- Delete All Regs in Seq [n] softkey, 5-133, 5-142
- Delete All Sequences softkey, 5-133, 5-143
- Delete All State Files softkey, 5-173
- Delete File softkey, 5-151, 5-174
- Delete Item softkey, 5-151
- delete manual set
 - delete option, 6-3
- Delete Row softkey, 5-151
- Delete Seq[n] Reg[nn] softkey, 5-134, 5-143
- device-specific error, 3-25
- Diagnostic Info softkey, 5-174
- digit keys, 5-93
- display
 - active entry area, 4-8
 - amplitude area, 4-7
 - annunciators, 4-8
 - brightness, 5-170

- contrast, 5-31
- error messages area, 4-8
- frequency area, 4-7
- location, 4-5
- modulation status, 5-179
- number of hours lit, 5-174
- text area, 4-8
- display contrast, 1-6
- display contrast decrease hardkey, 4-4, 5-31
- display contrast increase, 4-4
- display contrast increase hardkey, 4-4, 5-31
- display light, 1-6
- Display softkey, 5-174
- Do Power Search softkey, 5-24
- down arrow key, 5-29
- Dual Sine softkey, 5-12, 5-34, 5-68, 5-106
- dwelt time
 - incorrect, 3-4
- dwelt time, step sweep, 5-161
- Dwell Type List Step softkey, 5-151

E

- echo on/off, 5-185
- Edit Item softkey, 5-152
- Editing Keys softkey, 5-143, 5-175
- Editing Mode Insert Replace softkey, 5-144, 5-175
- electrical requirements, 1-5
- environmental requirements, 1-5
- ERR annunciator, 4-9
- Error Info softkey, 5-175
- error messages
 - description, 3-5
 - front panel error queue, 3-5
 - querying the error queue, 3-7
 - SCPI remote interface error queue, 3-5
 - SCPI standard, 3-10
- error messages area, 4-8
- error numbers, 3-8
- error, command, 3-11
- error, device-specific, 3-25
- error, execution, 3-17
- error, query, 3-28
- errors, none, 3-9
- errors, signal generator instrument-specific, 3-30
- European Community trademark, 8-3
- execution error, 3-17

- Ext 1 AC-Coupled softkey, 5-13, 5-35, 5-107
- Ext 1 DC-Coupled softkey, 5-14, 5-35, 5-108
- EXT 1 INPUT connector, 4-2
- Ext 2 AC-Coupled softkey, 5-15, 5-36, 5-108
- Ext 2 DC-Coupled softkey, 5-15, 5-36, 5-109
- EXT 2 INPUT connector, 4-2
- EXT REF annunciator, 4-9
- Ext softkey, 5-12, 5-34, 5-69, 5-107, 5-152
- EXT1 HI annunciator, 4-9, 5-7
- EXT1 LO annunciator, 4-9, 5-7
- Ext2 DC-Coupled softkey, 5-127
- EXT2 HI annunciator, 4-9, 5-7
- EXT2 LO annunciator, 4-9, 5-7

F

- files
 - binary, 5-170
 - instrument state, 5-190
 - list, 5-178
- firmware date, 5-174
- firmware revision, 5-174
- FM, 5-33
- FM annunciator, 4-9
- FM Dev Couple Off On softkey, 5-38
- FM Dev softkey, 5-37
- FM deviation, 5-37
- FM deviation coupling, 5-38
- FM Dual Sine Ampl Ratio softkey, 5-38
- FM hardkey, 5-33
- FM Off On softkey, 5-39
- FM Path 1 2 softkey, 5-40
- FM rate, 5-41
- FM Rate softkey, 5-41
- FM Source softkey, 5-42
- FM Start Rate softkey, 5-43
- FM Stop Rate softkey, 5-44
- FM Sweep Time softkey, 5-44
- FM sweep trigger
 - external, 5-34
 - immediate, 5-47
- FM Sweep Trigger softkey, 5-45
- FM Tone 2 Rate softkey, 5-46
- FM Waveform softkey, 5-46
- FM/ Φ M softkey, 5-37, 5-109
- Freq hardkey, 5-53
- Freq Multiplier softkey, 5-54
- Freq Offset softkey, 5-55

Index

- Freq Ref Off On softkey, 5-56
 - Freq Ref Set softkey, 5-56
 - Freq softkey, 5-153
 - Freq Start softkey, 5-154
 - Freq Stop softkey, 5-154
 - Freq&Ampl softkey, 5-153
 - frequency
 - offset, 5-55
 - reference, 5-56
 - setting, 2-2
 - frequency and amplitude sweep, 5-153
 - frequency display area, 4-7
 - Frequency hardkey, 4-5, 5-59
 - frequency modulation, 5-33
 - setting up, 2-8
 - frequency modulation specifications, 9-8
 - frequency multiplier, 5-54
 - frequency offset, setting, 2-3
 - frequency output, 5-59
 - frequency reference
 - setting, 2-3
 - frequency specifications, 9-2
 - frequency sweep, 5-153
 - front handles
 - add option, 6-2
 - installation, 1-4
 - front panel knob, 4-5
 - front panel overview, 4-2
 - Function Generator softkey, 5-69
- G**
- general specifications, 9-16
 - Goto Bottom Row softkey, 5-154
 - Goto Middle Row softkey, 5-155
 - Goto Row softkey, 5-155
 - Goto Top Row softkey, 5-155
- H**
- handles, front, 1-4
 - hardkey descriptions, 5-1
 - hardkeys, 4-4
 - ΦM, 5-95
 - AM, 5-3
 - Ampl, 5-21
 - Amplitude, 4-5, 5-27
 - arrow, 4-4
 - display contrast decrease, 4-4, 5-31
 - display contrast increase, 5-31
 - down arrow, 5-29
 - FM, 5-33
 - Freq, 5-53
 - Frequency, 4-5, 5-59
 - Help, 4-3, 5-61
 - Hold, 4-5, 5-63
 - Incr Set, 4-6, 5-65
 - left arrow, 5-29
 - LF Out, 5-67
 - Local, 5-87
 - menu, 4-6
 - Mod On/Off, 4-3, 5-89
 - Mode, 5-91
 - Preset, 5-117
 - Pulse, 5-127
 - Recall, 4-6, 5-133
 - Return, 5-137
 - RF On/Off, 4-3, 5-139
 - right arrow, 5-29
 - Save, 4-5, 5-141
 - Sweep/List, 5-147
 - Trigger, 4-3, 5-167
 - up arrow, 5-29
 - Utility, 5-169
- I**
- Help hardkey, 4-3, 5-61
 - help mode
 - changing, 5-176
 - turning off, 3-4
 - Help Mode Single Cont softkey, 5-176
 - high stability timebase
 - add option, 6-3
 - Hold hardkey, 4-5, 5-63
 - HP sales and service offices, 3-51
 - HP8648A/B/C/D softkey, 5-176
 - HP-IB address, 1-7
 - HP-IB Address softkey, 5-177
 - HP-IB connector, 4-11
 - HP-IB/RS-232 softkey, 5-177
 - humidity requirements, 1-5
- instrument-specific errors, 3-30**
- internal modulation input specifications, 9-14
 - internal modulation specifications, 9-13
 - Internal Pulse softkey, 5-128
 - internal reference oscillator specifications, 9-4
 - Internal softkey, 5-16, 5-47, 5-70, 5-110
 - Internal Square softkey, 5-128
 - Inverse Video Off On softkey, 5-178
 - ISM 1-A symbol, 8-3
 - ISO compliance, 9-15
- K**
- key descriptions, 5-1
 - kits
 - front handles, 1-4
 - rack mount, 1-4
 - knob, 4-5
- L**
- L annunciator, 4-9
 - language, 1-8
 - LED
 - green, 5-115
 - line power, 4-5
 - standby, 4-4
 - yellow, 5-115
 - left arrow key, 5-29
 - LF Out Amplitude softkey, 5-71
 - LF Out hardkey, 5-67
 - LF Out Mod Freq softkey, 5-71
 - LF Out Off On softkey, 5-72
 - LF Out Period softkey, 5-72
 - LF Out Source softkey, 5-73
 - LF out specifications, 9-14
 - LF Out Start Freq softkey, 5-74
 - LF Out Stop Freq softkey, 5-75
 - LF Out Sweep Time softkey, 5-76
 - LF Out Tone 1 Freq softkey, 5-77
 - LF Out Tone 2 Ampl % Of Peak softkey, 5-78
 - LF Out Tone 2 Freq softkey, 5-79
 - LF Out Waveform softkey, 5-79
 - LF Out Width softkey, 5-80
 - LF output
 - DC waveform, 5-68
 - incorrect signal, 3-4
 - LF OUTPUT connector, 4-3
 - LF output source
 - internal, 5-70
-

Index

- LF output sweep trigger
 - bus, 5-67
 - external, 5-69
 - immediate, 5-70
 - trigger key, 5-85
 - light bulb, 1-6
 - line power LED, 4-5
 - line settings, 1-5
 - List softkey, 5-178
 - list sweep, creating, 2-10
 - Load List From Selected File softkey, 5-157
 - Load List From Step Sweep softkey, 5-157
 - Load/Store List softkey, 5-157
 - Local, 4-4
 - Local hardkey, 4-4, 5-87
 - low frequency generator, 5-67
- M**
- maintenance agreements, 8-7
 - Manual Mode Off On softkey, 5-158
 - Manual Point softkey, 5-158
 - Memory Catalog softkey, 5-179
 - menu hardkeys, 4-6
 - MOD OFF annunciator, 4-9
 - MOD ON annunciator, 4-9
 - Mod On/Off hardkey, 4-3, 5-89
 - Mod Status Info Off On softkey, 5-179
 - Mode 1 Optimize <10kHz Offset softkey, 5-57
 - Mode 2 Optimize >10kHz Offset softkey, 5-57
 - Mode hardkey, 5-91
 - model number, 5-174
 - modulation
 - none, 3-2
 - turning on/off, 5-89
 - modulation status display, 5-179
 - multiplying frequency, 5-54
- N**
- NIST, 8-8
 - Noise softkey, 5-17, 5-48, 5-80, 5-111
 - numeric keypad, 4-4, 5-93
- O**
- Off softkey, 5-159, 5-179
 - offset
 - frequency, 5-55
 - operation, 7-1
 - operation verification, 1-9
 - operational problems, 3-2
 - operator's check, 1-9
 - Optimize Φ Noise softkey, 5-58
 - option ICN, 6-2
 - options, 6-2, 9-17
 - OB0, 6-3
 - OB1, 6-4
 - OBV, 6-5
 - OBW, 6-4
 - OBX, 6-5
 - ICM, 6-2
 - ICP, 6-2
 - IE5, 6-3
 - IEM, 6-3
 - AB0, 6-5
 - AB1, 6-6
 - AB2, 6-6
 - ABD, 6-6
 - ABE, 6-6
 - ABJ, 6-7
 - add CLIP, 6-5
 - add manual set, 6-4
 - add service guide, 6-4
 - add service guide and CLIP, 6-5
 - add user's guide (Chinese), 6-6
 - add user's guide (German), 6-6
 - add user's guide (Japanese), 6-7
 - add user's guide (Korean), 6-6
 - add user's guide (Spanish), 6-6
 - add user's guide (Taiwanese), 6-5
 - connectors moved to rear panel, 6-3
 - delete manual set, 6-3
 - front handles, 6-2
 - high stability timebase, 6-3
 - rack mount flanges with handles, 6-2
 - rack mount flanges without handles, 6-2
 - three year warranty, 6-2
 - W30, 6-2
- output
 - frequency, 5-59
 - power, 5-27
 - specifications, 9-4
- OVEN COLD annunciator, 4-9
- P**
- pace, 5-185
 - Page Down softkey, 5-159, 5-179
 - Page Up softkey, 5-159, 5-180
 - phase modulation, 5-95
 - dual sine amplitude ratio, 5-97
 - rate, 5-100
 - source, 5-101
 - start rate, 5-102
 - stop rate, 5-103
 - sweep time, 5-103
 - tone 1 rate, 5-104
 - tone 2 rate, 5-105
 - waveform, 5-105
 - phase modulation deviation, 5-95
 - phase modulation deviation coupling, 5-97
 - phase modulation specifications, 9-10
 - phase modulation sweep trigger
 - bus, 5-106
 - external, 5-107
 - immediate, 5-110
 - phase, changing, 5-53
 - point trigger
 - bus, 5-149
 - immediate, 5-156
 - trigger key, 5-164
 - Point Trigger softkey, 5-160
 - power cycles, number of, 5-174
 - Power On Last Preset softkey, 5-180
 - power on symbol, 8-3
 - Power On/Preset softkey, 5-180
 - power output, 5-27
 - power receptacle, 4-11
 - power search, 5-24
 - Power Search Manual Auto softkey, 5-25
 - power supply
 - shut down, 3-3
 - power switch, 4-5, 5-115
 - power, setting, 2-2
 - Preset, 4-4
 - Preset hardkey, 4-4, 5-117
 - Preset Language softkey, 5-181
 - Preset List softkey, 5-160
 - Preset Normal User softkey, 5-181
 - problems with operation, 3-2
 - programming language, 1-8
 - PULSE annunciator, 4-10
 - Pulse hardkey, 5-127
 - pulse modulation, 5-127
 - internal rectangular, 5-128
 - internal squarewave, 5-128
 - pulse modulation specifications, 9-12
 - Pulse Off On softkey, 5-129
 - Pulse Rate softkey, 5-129, 5-130
 - Pulse softkey, 5-81
 - Pulse Source softkey, 5-131

Index

pulsed LF output, 5-81

Q

query error, 3-28

R

rack mount flanges with handles
 add option, 6-2
rack mount flanges without handles
 add option, 6-2
rack mount flanges, installation, 1-4
Ramp softkey, 5-17, 5-48, 5-81, 5-111
rear panel overview, 4-11
Recall hardkey, 5-133
Recall hardkeys, 4-6
Recall Ref Osc Setting softkey, 5-182
Recall Reg softkey, 5-134
recalling instrument states, 2-13
Receive Pace None Xon softkey, 5-182
Ref Osc Coarse softkey, 5-183
Ref Osc Fine softkey, 5-183
Reference Oscillator Adjustment softkey, 5-182
registers
 contents incorrect, 3-3
 empty, 3-3
Reinternal reference oscillator adjustment, 5-182
remote interface, 6-8
Remote Language softkey, 5-183
remote programming specifications, 9-15
repair, returning your instrument, 3-50
Reset RS-232 softkey, 5-183
Return, 4-4
Return hardkey, 4-4, 5-137
Reverse Power Protection Normal HP8648 softkey, 5-184
reverse power protection trips, 5-174
RF OFF annunciator, 4-10
RF ON annunciator, 4-10
RF On/Off hardkey, 4-3, 5-139
RF output
 low, 3-2
 none, 3-2
RF OUTPUT connector, 4-3
right arrow key, 5-29
RS-232 Baud Rate softkey, 5-185
RS-232 connector, 4-12
RS-232 Echo Off On softkey, 5-185
RS-232 softkey, 5-185

RTS On softkey, 5-187
RTS/CTS Pacing softkey, 5-186
RTS/CTS softkey, 5-186

S

S annunciator, 4-10
safety, 8-1
sales and service offices, 3-51
Save hardkey, 4-5, 5-141
Save Seq[n] Reg[nn] softkey, 5-144
Save User Preset softkey, 5-187
saving instrument states, 2-13
SCPI softkey, 5-188
screen saver, 1-6
Screen Saver Delay softkey, 5-188
Screen Saver Mode softkey, 5-189
Screen Saver Off On softkey, 5-189
Select Reg softkey, 5-145
Select Seq softkey, 5-135, 5-145
serial number, 5-174
shipment
 checking, 1-2
 verification list, 1-3
signal generator instrument-specific errors, 3-30
simultaneous modulation specifications, 9-15
Sine softkey, 5-17, 5-48, 5-82, 5-111
Single Sweep softkey, 5-160
softkey descriptions, 5-1
softkey labels, 4-8
softkeys
 # Points, 5-147
 Φ M Dev, 5-95
 Φ M Dev couple Off On, 5-97
 Φ M Dual Sine Ampl Ratio, 5-97
 Φ M Off On, 5-98
 Φ M Path 1 2, 5-99
 Φ M Rate, 5-100
 Φ M Source, 5-101
 Φ M Start Rate, 5-102
 Φ M Stop Rate, 5-103
 Φ M Sweep Time, 5-103
 Φ M Tone 1 Rate, 5-104
 Φ M Tone 2 Rate, 5-105
 Φ M Waveform, 5-105
 Adjust Phase, 5-53
 ALC Off On, 5-21
 All, 5-169
 AM Depth, 5-3
 AM Depth Couple Off On, 5-4
 AM Dual Sine Ampl Ratio, 5-4

AM Off On, 5-5
AM Path 1 2, 5-5
AM Rate, 5-6
AM Source, 5-7
AM Start Rate, 5-8
AM Stop Rate, 5-9
AM Sweep Time, 5-9
AM Sweep Trigger, 5-10, 5-76, 5-104
AM Tone 1 Rate, 5-10, 5-45
AM Tone 2 Rate, 5-11
AM Waveform, 5-11
Ampl, 5-148
Ampl Offset, 5-22
Ampl Ref Off On, 5-23
Ampl Ref Set, 5-22
Ampl Start, 5-148
Ampl Stop, 5-149
Atten Hold Off On, 5-24
Binary, 5-170
Black Pixels Screen Test, 5-170
Brightness, 5-170
Bus, 5-12, 5-33, 5-67, 5-106, 5-149
Catalog type, 5-171
Clear Error Queue(s), 5-171
Clear Text, 5-142, 5-171
Configure List Sweep, 5-150
Configure Step Sweep, 5-150
Copy File, 5-172
DC, 5-68
DCFM/DC Φ M Cal, 5-34, 5-106
Delete All Binary Files, 5-172
Delete All Files, 5-173
Delete All List Files, 5-173
Delete All Regs in Seq [n], 5-133, 5-142
Delete All Sequences, 5-133, 5-143
Delete All State Files, 5-173
Delete File, 5-151, 5-174
Delete Item, 5-151
Delete Row, 5-151
Delete Seq[n] Reg[nn], 5-134, 5-143
Diagnostic Info, 5-174
Display, 5-174
Do Power Search, 5-24
Dual Sine, 5-12, 5-34, 5-68, 5-106
Dwell Type List Step, 5-151
Edit Item, 5-152
Editing Keys, 5-143, 5-175
Editing Mode Insert Replace, 5-144, 5-175
Error Info, 5-175
Ext, 5-12, 5-34, 5-69, 5-107, 5-152

Index

- Ext 1 AC-Coupled, 5-13, 5-35, 5-107
- Ext 1 DC-Coupled, 5-14, 5-35, 5-108
- Ext 2 AC-Coupled, 5-15, 5-36, 5-108
- Ext 2 DC-Coupled, 5-15, 5-36, 5-109
- Ext2 DC-Coupled, 5-127
- FM Dev, 5-37
- FM Dev Couple Off On, 5-38
- FM Dual Sine Ampl Ratio, 5-38
- FM Off On, 5-39
- FM Path 1 2, 5-40
- FM Rate, 5-41
- FM Source, 5-42
- FM Start Rate, 5-43
- FM Stop Rate, 5-44
- FM Sweep Time, 5-44
- FM Sweep Trigger, 5-45
- FM Tone 2 Rate, 5-46
- FM Waveform, 5-46
- FM/ΦM, 5-37, 5-109
- Freq, 5-153
- Freq Multiplier, 5-54
- Freq Offset, 5-55
- Freq Ref Off On, 5-56
- Freq Ref Set, 5-56
- Freq Start, 5-154
- Freq Stop, 5-154
- Freq&Ampl, 5-153
- Function Generator, 5-69
- Goto Bottom Row, 5-154
- Goto Middle Row, 5-155
- Goto Row, 5-155
- Goto Top Row, 5-155
- Help Mode Single Cont, 5-176
- HP8648A/B/C/D, 5-176
- HP-IB Address, 5-177
- HP-IB/RS-232, 5-177
- Immediate, 5-16, 5-47, 5-70, 5-110, 5-156
- Insert Item, 5-156
- Insert Row, 5-156
- Instrument Adjustments, 5-177
- Instrument Info/Help Mode, 5-178
- Internal, 5-16, 5-47, 5-70, 5-110
- Internal Pulse, 5-128
- Internal Square, 5-128
- Inverse Video Off On, 5-178
- LF Out Amplitude, 5-71
- LF Out Mod Freq, 5-71
- LF Out Off On, 5-72
- LF Out Period, 5-72
- LF Out Source, 5-73
- LF Out Start Freq, 5-74
- LF Out Stop Freq, 5-75
- LF Out Sweep Time, 5-76
- LF Out Tone 1 Freq, 5-77
- LF Out Tone 2 Ampl % Of Peak, 5-78
- LF Out Tone 2 Freq, 5-79
- LF Out Waveform, 5-79
- LF Out Width, 5-80
- List, 5-178
- Load List From Selected File, 5-157
- Load List From Step Sweep, 5-157
- Load/Store List, 5-157
- location, 4-5
- Manual Mode Off On, 5-158
- Manual Point, 5-158
- Memory Catalog, 5-179
- Mod Status Info Off On, 5-179
- Mode 1 Optimize <10kHz Offset, 5-57
- Mode 2 Optimize >10kHz Offset, 5-57
- Noise, 5-17, 5-48, 5-80, 5-111
- Off, 5-159, 5-179
- Optimize Φ Noise, 5-58
- Page Down, 5-159, 5-179
- Page Up, 5-159, 5-180
- Point Trigger, 5-160
- Power On Last Preset, 5-180
- Power On/Preset, 5-180
- Power Search Manual Auto, 5-25
- Preset Language, 5-181
- Preset List, 5-160
- Preset Normal User, 5-181
- Pulse, 5-81
- Pulse Off On, 5-129
- Pulse Rate, 5-129, 5-130
- Pulse Source, 5-131
- Ramp, 5-17, 5-48, 5-81, 5-111
- Recall Ref Osc Setting, 5-182
- Recall Reg, 5-134
- Receive Pace None Xon, 5-182
- Ref Osc Coarse, 5-183
- Ref Osc Fine, 5-183
- Reference Oscillator Adjustment, 5-182
- Remote Language, 5-183
- Reset RS-232, 5-183
- Reverse Power Protection Normal HP8648, 5-184
- RS-232, 5-185
- RS-232 Baud Rate, 5-185
- RS-232 Echo Off On, 5-185
- RTS On, 5-187
- RTS/CTS, 5-186
- RTS/CTS Pacing, 5-186
- Save Seq[n] Reg[nn], 5-144
- Save User Preset, 5-187
- SCPI, 5-188
- Screen Saver Delay, 5-188
- Screen Saver Mode, 5-189
- Screen Saver Off On, 5-189
- Select Reg, 5-145
- Select Seq, 5-135, 5-145
- Sine, 5-17, 5-48, 5-82, 5-111
- Single Sweep, 5-160
- Square, 5-18, 5-49, 5-82, 5-112
- State, 5-190
- Step Dwell, 5-161
- Step/Knob Ratio, 5-190
- Store Ref Osc Setting, 5-190
- Store To File, 5-161
- Sweep, 5-162
- Sweep direction Down Up, 5-162
- Sweep Repeat Single Cont, 5-163
- Sweep Trigger, 5-163
- Sweep Type List Step, 5-163
- Swept Sine, 5-18, 5-49, 5-83, 5-112
- Transmit Pace None Xon, 5-191
- Triangle, 5-18, 5-49, 5-83, 5-112
- Trigger In Polarity Neg Pos, 5-19, 5-50, 5-84, 5-113, 5-164
- Trigger Key, 5-19, 5-51, 5-85, 5-114, 5-164
- Trigger Out Polarity Neg Pos, 5-20, 5-51, 5-85, 5-114, 5-165
- View Next Error Message, 5-191
- View Previous Error Message, 5-192
- White Pixels Screen test, 5-192
- specifications, 9-1
 - amplitude modulation, 9-11
 - external modulation inputs, 9-14
 - frequency, 9-2
 - frequency modulation, 9-8
 - general, 9-16
 - internal modulation source, 9-13
 - internal reference oscillator, 9-4
 - LF out, 9-14
 - output, 9-4
 - phase modulation, 9-10
 - pulse modulation, 9-12
 - remote programming, 9-15
 - simultaneous modulation, 9-15
 - spectral purity, 9-7
 - sweep modes, 9-3
 - spectral purity specifications, 9-7

Index

- Square softkey, 5-18, 5-49, 5-82, 5-112
 - standby LED, 4-4
 - standby symbol, 8-3
 - State softkey, 5-190
 - statement of compliance, 8-5
 - Step Dwell softkey, 5-161
 - step sweep dwell time, 5-161
 - step sweep points, 5-147
 - step sweep, creating, 2-10
 - Step/Knob Ratio softkey, 5-190
 - Store Ref Osc Setting softkey, 5-190
 - Store To File softkey, 5-161
 - supplemental characteristics, 9-1
 - sweep
 - creating, 2-10
 - list not recalled, 3-3
 - triggering point-by-point, 5-160
 - turning off, 5-159
 - SWEEP annunciator, 4-10
 - Sweep Direction Down Up softkey, 5-162
 - sweep list dwell time, incorrect, 3-4
 - sweep mode
 - specifications, 9-3
 - turning off, 3-3
 - SWEEP OUT connector, 4-12
 - Sweep Repeat Single Cont softkey, 5-163
 - Sweep softkey, 5-162
 - sweep trigger
 - bus, 5-149
 - immediate, 5-156
 - trigger key, 5-164
 - Sweep Trigger softkey, 5-163
 - Sweep Type List Step softkey, 5-163
 - Sweep/List hardkey, 5-147
 - Swept Sine softkey, 5-18, 5-49, 5-83, 5-112
- T**
- T annunciator, 4-10
 - temperature requirements, 1-5
 - text area, 4-8
 - three year warranty
 - add option, 6-2
 - Trigger In Polarity Neg Pos softkey, 5-164
 - Trigger Out Polarity Neg Pos softkey, 5-165
 - transit case, 6-8
 - Transmit Pace None Xon softkey, 5-191
 - Triangle softkey, 5-18, 5-49, 5-83, 5-112
 - Trigger hardkey, 4-3, 5-167
 - TRIGGER IN connector, 4-13
 - Trigger In Polarity Neg Pos softkey, 5-19, 5-50, 5-84, 5-113
 - Trigger Key softkey, 5-19, 5-51, 5-85, 5-114, 5-164
 - TRIGGER OUT connector, 4-12
 - Trigger Out Polarity Neg Pos softkey, 5-20, 5-51, 5-85, 5-114
 - troubleshooting, 3-2
- U**
- UNLEVEL annunciator, 4-10
 - UNLOCK annunciator, 4-10
 - up arrow key, 5-29
 - Utility hardkey, 5-169
- V**
- ventilation requirements, 1-4
 - verification, operation, 1-9
 - View Next Error Message softkey, 5-191
 - View Previous Error Message softkey, 5-192
- W**
- warning sign, 8-2
 - warranty, 8-6
 - White Pixels Screen Test softkey, 5-192