

TOSHIBA BIPOLAR DIGITAL INTEGRATED CIRCUIT SILICON MONOLITHIC

TD62307P, TD62307F

7CH LOW SATURATION SINK DRIVER

The TD62307P, TD62307F are comprised of seven NPN low saturation drivers.

All units feature integral clamp diodes for switching inductive loads and protective diodes against a negative input voltage.

Applications include relay, hammer, lamp and LED driver.

FEATURES

- Low saturation output $V_{CE(sat)} = 0.6V$ (Max.)
@ $I_{OUT} = 120mA$
- Output rating (single output) 20V (Min.) / 150mA (Max.)
- Inputs compatible with 5~15V PMOS, CMOS
- Input protective diodes against a negative input voltage
- Package type-P : DIP-16 pin
- Package type-F : SOP-16 pin

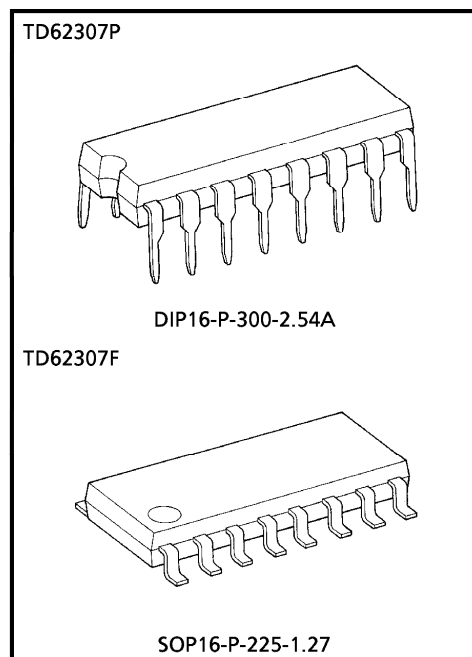

Weight
 DIP16-P-300-2.54A : 1.11g (Typ.)
 SOP16-P-225-1.27 : 0.16g (Typ.)

PIN CONNECTION (TOP VIEW)

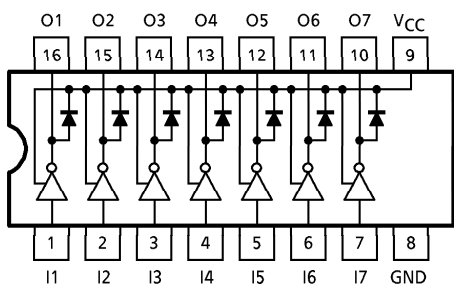

SCHEMATICS (EACH DRIVER)

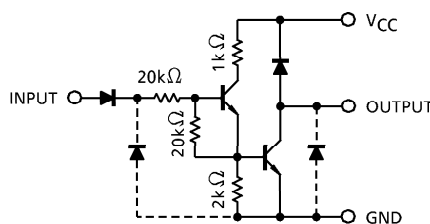

(Note) The input and output parasitic diodes cannot be used as clamp diodes.

961001EBA2

- TOSHIBA is continually working to improve the quality and the reliability of its products. Nevertheless, semiconductor devices in general can malfunction or fail due to their inherent electrical sensitivity and vulnerability to physical stress. It is the responsibility of the buyer, when utilizing TOSHIBA products, to observe standards of safety, and to avoid situations in which a malfunction or failure of a TOSHIBA product could cause loss of human life, bodily injury or damage to property. In developing your designs, please ensure that TOSHIBA products are used within specified operating ranges as set forth in the most recent products specifications. Also, please keep in mind the precautions and conditions set forth in the TOSHIBA Semiconductor Reliability Handbook.
- The products described in this document are subject to foreign exchange and foreign trade control laws.
- The information contained herein is presented only as a guide for the applications of our products. No responsibility is assumed by TOSHIBA CORPORATION for any infringements of intellectual property or other rights of the third parties which may result from its use. No license is granted by implication or otherwise under any intellectual property or other rights of TOSHIBA CORPORATION or others.
- The information contained herein is subject to change without notice.

MAXIMUM RATINGS (Ta = 25°C)

CHARACTERISTIC	SYMBOL	RATING	UNIT
Supply Voltage	V _{CC}	- 0.5~20	V
Output Sustaining Voltage	V _{CE (SUS)}	- 0.5~V _{CC} + 0.5	V
Output Current	I _{OUT}	150	mA / ch
Input Voltage	V _{IN}	- 37~20	V
Input Current	I _{IN}	1.5	mA
Clamp Diode Reverse Voltage	V _R	20	V
Clamp Diode Forward Current	I _F	120	mA
Power Dissipation	P	1.0	W
	F	0.625 (Note)	
Operating Temperature	P	- 30~75	°C
	F	- 40~85	
Storage Temperature	T _{stg}	- 55~150	°C

(Note) On Glass Epoxy PCB (30×30×1.6mm Cu 50%)

RECOMMENDED OPERATING CONDITIONS (Ta = - 40 ~ 85°C for Type-F and Ta = - 30 ~ 75°C for Type-P)

CHARACTERISTIC	SYMBOL	CONDITION	MIN.	TYP.	MAX.	UNIT
Supply Voltage	V _{CC}	—	4.75	—	18	V
Output Current	I _{OUT}	DC 1 Circuit	0	—	120	mA / ch
		T _{pw} = 25ms, Duty = 10%, 7 Circuits	0	—	100	
Input Voltage	V _{IN}	—	- 35	—	V _{CC}	V
Clamp Diode Reverse Voltage	V _R	—	—	—	18	V
Clamp Diode Forward Current	I _F	—	—	—	120	mA
Power Dissipation	P	—	—	—	0.44	W
	F	(Note)	—	—	0.325	

(Note) On Glass Epoxy PCB (30×30×1.6mm Cu 50%)

ELECTRICAL CHARACTERISTICS (Ta = 25°C)

CHARACTERISTIC		SYMBOL	TEST CIR-CUIT	TEST CONDITION	MIN.	TYP.	MAX.	UNIT	
Output Leakage Current	P	I _{CEX}	1	V _{CC} = 18V V _{OUT} = 18V	Ta = 75°C	—	—	100	μA
	F				Ta = 85°C	—	—	100	
Output Saturation Voltage		V _{CE (sat)}	2	V _{CC} = 5V, I _{IN} = 0.2mA I _{OUT} = 120mA	—	0.45	0.6	V	
DC Forward Current Transfer Ratio		h _{FE}	2	V _{CC} = 5V, V _{OUT} = 2V I _{OUT} = 120mA	1000	—	—	—	
Input Current	Output On	I _{IN (ON)}	3	V _{IN} = 5V, I _{OUT} = 120mA V _{IN} = 15V, I _{OUT} = 120mA	—	0.16	0.23	mA	
	Output Off	I _{IN (OFF)}			4	V _{IN} = -35V	—		—
Clamp Diode Forward Voltage		V _F	5	I _F = 120mA	—	1.25	1.6	V	
Supply Current	Output On	I _{CC (ON)}	6	V _{CC} = V _{IN} = 5V V _{CC} = V _{IN} = 15V	—	4.0	6.0	mA / Gate	
	Output Off	I _{CC (OFF)}		6	V _{CC} = 18V, V _{IN} = 0V	—	—		10
Turn-On Delay		t _{ON}	7	V _{CC} = 18V, R _L = 150Ω C _L = 15pF	—	0.1	—	μs	
Turn-Off Delay		t _{OFF}			—	0.8	—	μs	

TEST CIRCUIT

1. I_{CEX}

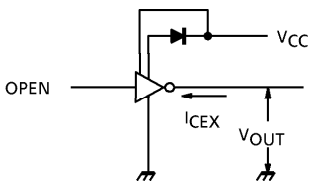

2. h_{FE}, V_{CE (sat)}

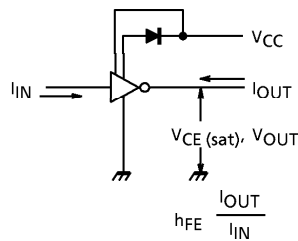

3. I_{IN (ON)}

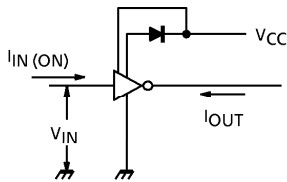

4. I_{IN (OFF)}

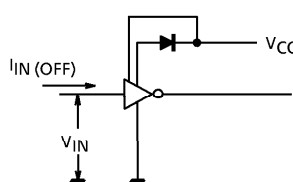

5. V_F

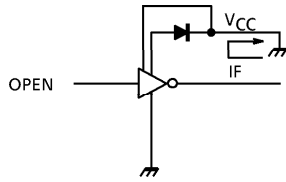

6. I_{CC}

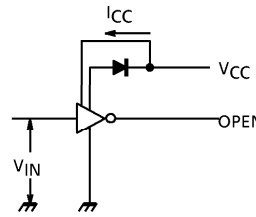

7. t_{ON} , t_{OFF}

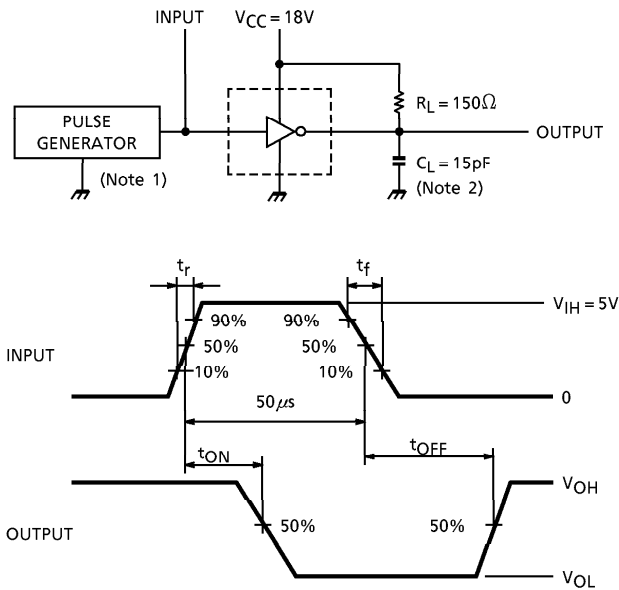

- (Note 1) Pulse Width $50\mu s$, Duty Cycle 10%,
Output Impedance 50Ω , $t_r \leq 5ns$, $t_f \leq 10ns$
- (Note 2) C_L includes probe and jig capacitance.

PRECAUTIONS for USING

Utmost care is necessary in the design of the output line, V_{CC} and GND line since IC may be destroyed due to short-circuit between outputs, air contamination fault, or fault by improper grounding.

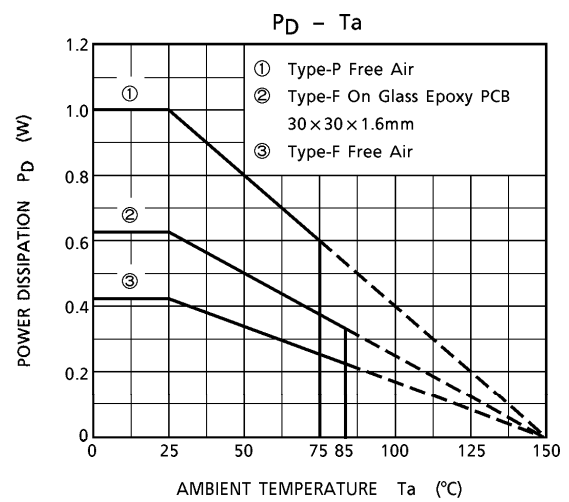
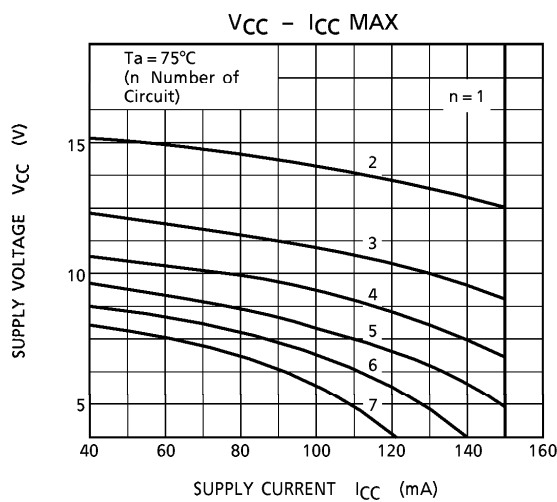
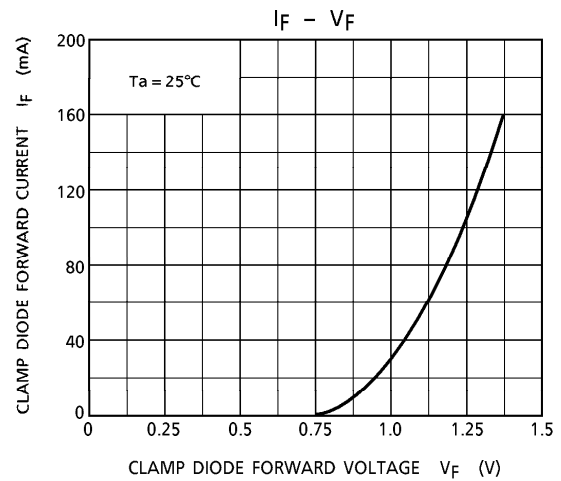
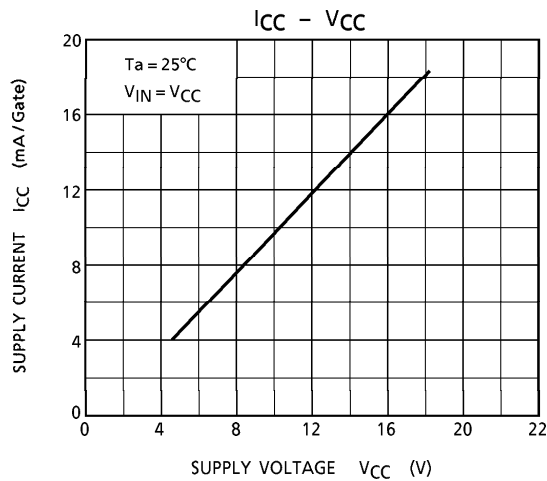
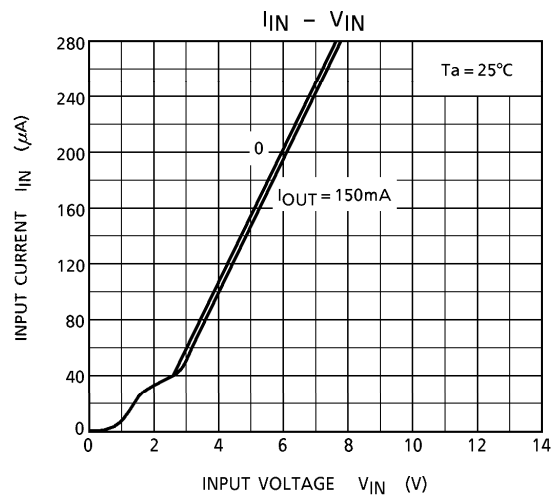
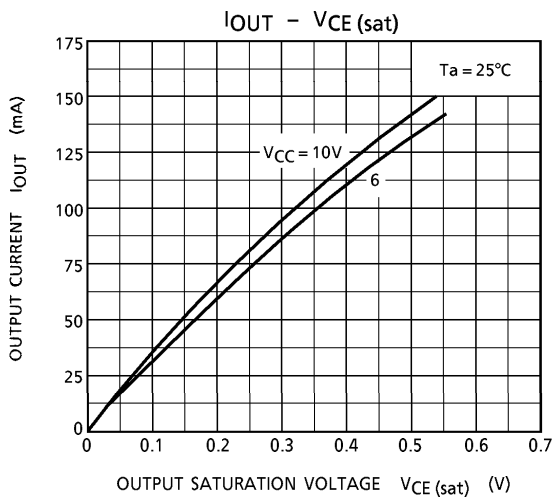

OUTLINE DRAWING
DIP16-P-300-2.54A

Unit : mm

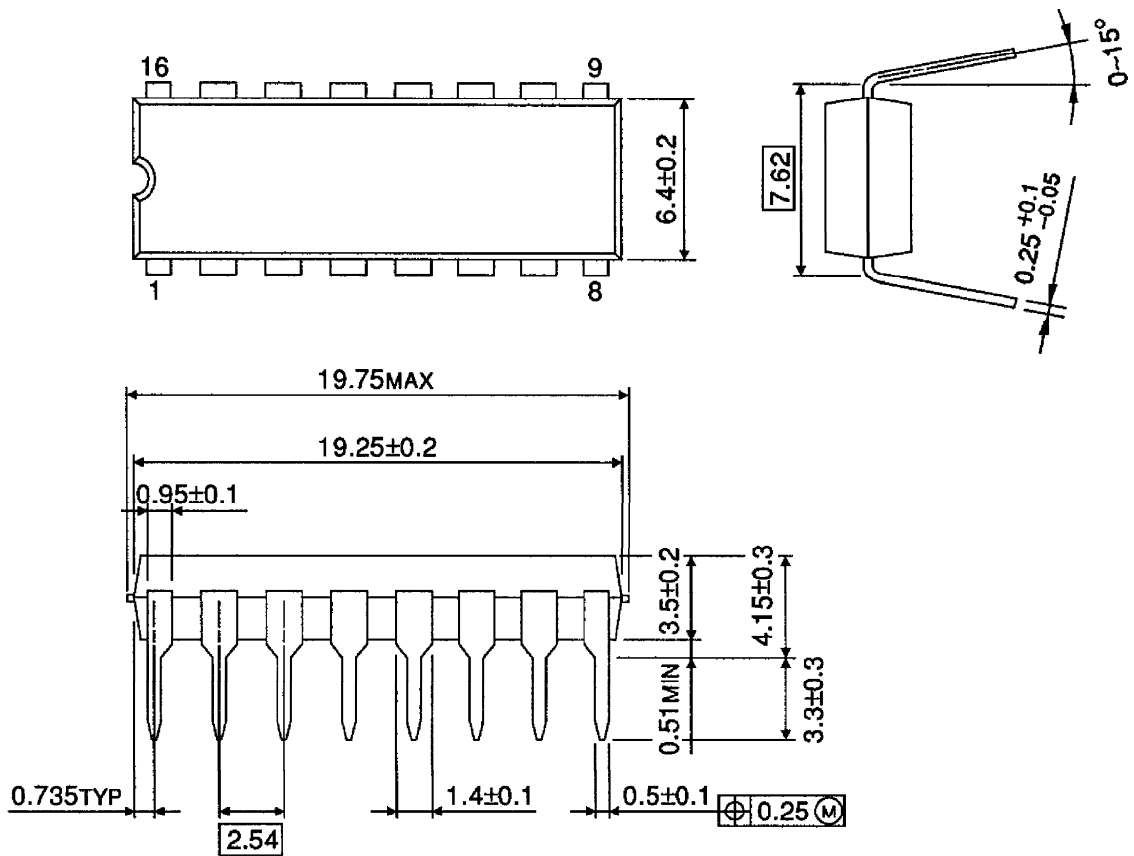

Weight : 1.11g (Typ.)

OUTLINE DRAWING
SOP16-P-225-1.27

Unit : mm

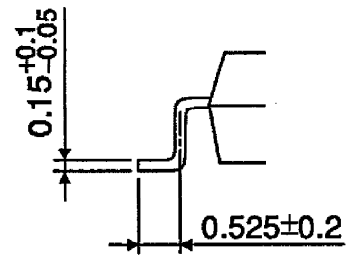
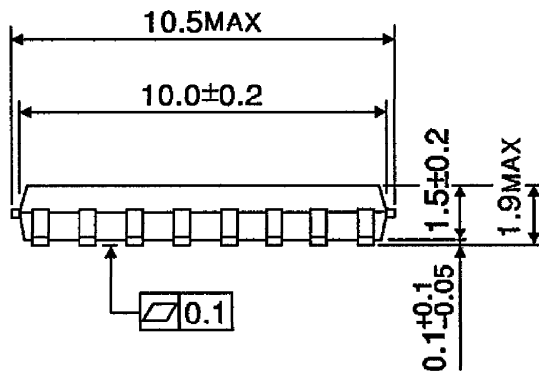
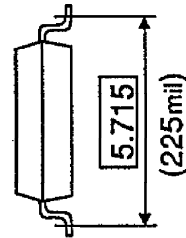
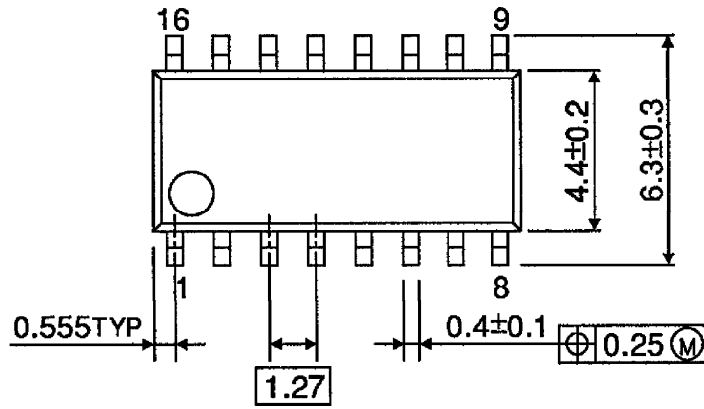

Weight : 0.16g (Typ.)