

**DC voltage/current source monitor ideal for  
electronic circuit/component evaluation  
by flexible source and measurement**

- **Wide ranging source/measurement**  
6243 Voltage: 0 to  $\pm 110\text{V}$  Current: 0 to  $\pm 2\text{A}$   
6244 Voltage: 0 to  $\pm 20\text{V}$  Current: 0 to  $\pm 10\text{A}$
- **5½-digit display with  $1\mu\text{V}/100\text{pA}$  (6243),  $1\mu\text{V}/1\text{nA}$  (6244) resolution in measurement**
- **Pulse measurement with a minimum pulse width of 1ms**
- **Sink-enabled bipolar output**



The 6243/6244 is a DC voltage and current source/monitor that offers wide ranging source and measurement as follows:

6243 Voltage: 0 to  $\pm 110\text{V}$  Current: 0 to  $\pm 2\text{A}$

6244 Voltage: 0 to  $\pm 20\text{V}$  Current: 0 to  $\pm 10\text{A}$

The 6243/6244 provides high accuracy with  $4\frac{1}{2}$ -digit source resolution and  $5\frac{1}{2}$ -digit measurement resolution, a variety of sweep functions, and a pulse measuring function with a minimum pulse width of 1ms. Thus, it can be used for a wide range of applications as a power source for evaluation in research and development of semiconductors and other electronic components or for characteristic test systems in a production line.

	6243	6244
Maximum output current	$\pm 2\text{A}$ at up to $\pm 32\text{V}$ $\pm 1\text{A}$ at up to $\pm 64\text{V}$ $\pm 0.5\text{A}$ at up to $\pm 110\text{V}$	$\pm 10\text{A}$ at up to $\pm 7\text{V}$ $\pm 4\text{A}$ at up to $\pm 20\text{V}$
Voltage source/measurement range	320mV-110V	320mV-20V
Current source/measurement range	32 $\mu\text{A}$ -2A	320 $\mu\text{A}$ -10A
Digits		
Source		$4\frac{1}{2}$
Measurement		$5\frac{1}{2}$
Voltage resolution		
Source		10 $\mu\text{V}$
Measurement		1 $\mu\text{V}$
Current resolution		
Source	1nA	10nA
Measurement	100pA	1nA

- **Wide ranging source/measurement**  
6243 Voltage: 0 to  $\pm 110\text{V}$  Current: 0 to  $\pm 2\text{A}$   
6244 Voltage: 0 to  $\pm 20\text{V}$  Current: 0 to  $\pm 10\text{A}$
- **$5\frac{1}{2}$ -digit display with 1 $\mu\text{V}/100\text{pA}$  (6243), 1 $\mu\text{V}/1\text{nA}$  (6244) resolution in measurement**
- **Pulse measurement with a minimum pulse width of 1ms**
- **Sink-enabled bipolar output**



## Output Range

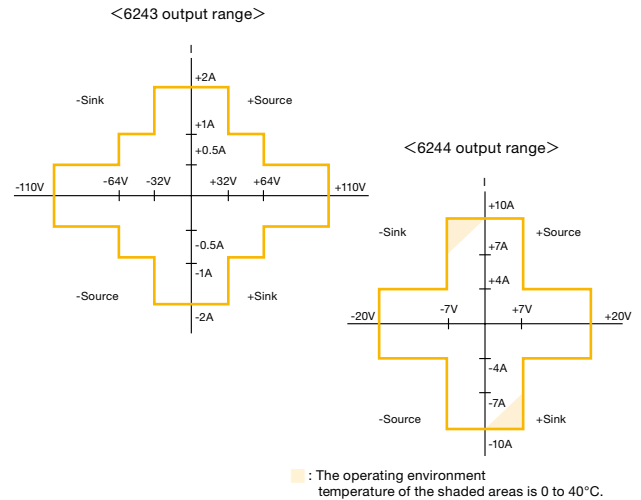

## Source/Measurement Functions

Voltage/current source and voltage/current measurement can be selected by specifying the source and measurement functions.

6243/6244

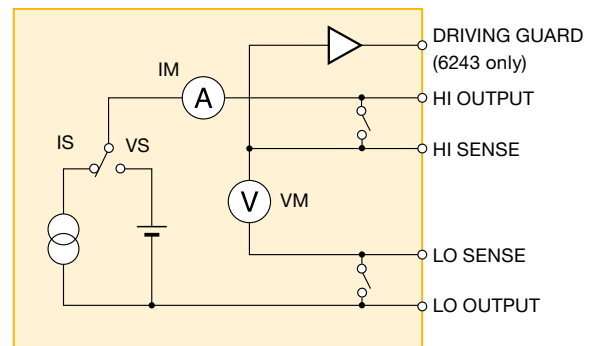

## Source Modes

There are four source modes; DC, pulse, DC sweep, pulse sweep. Then, the sweep modes are classified into three sweep types: linear sweep, log sweep and random sweep (user programmable sweep).

Source mode	DC	Pulse
Continuous spot		
Linear sweep		
Log sweep		
Random sweep		

The 6243/6244 can generate patterns necessary for device test without exchanging data with an external controller, and read out measurement results from the memory after the test. However, it cannot generate pulses across polarities.

## Source/Measurement Timing

In the pulse and sweep modes, the source and measurement timings are synchronous, and measurement can be done after a specified time from source value application.

Setting the measurement delay ( $T_d$ ) allows measurement after a specified time from the end of pulse application as stress test.

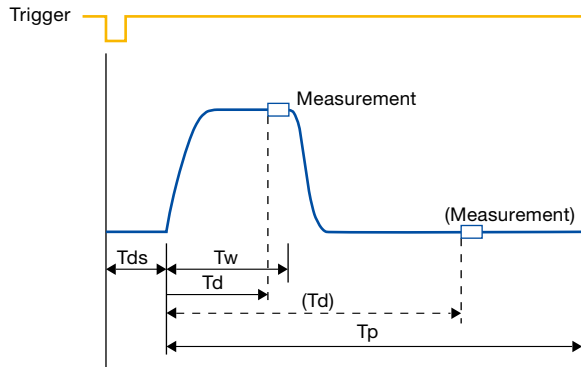

$T_{ds}$  : Source delay  $T_w$  : Pulse width  $T_d$  : Measurement delay  $T_p$  : Period

## Range Switching without Discontinuity

The voltage and current source ranges can be changed without lowering the output to zero from the level before switching. This allows no discontinuity at the output and reduces adverse effects on devices with hysteresis or high dielectric constant.

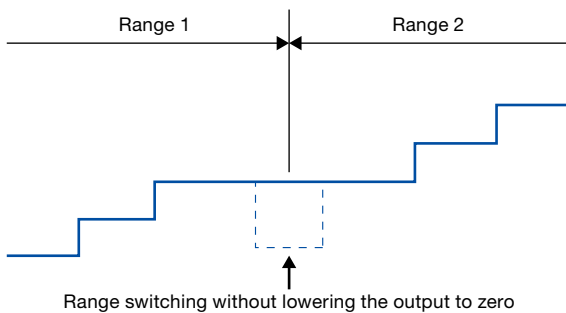

## Low Noise

The performance of a power supply basically depends on the accuracy of source voltage/current and the quantity of noise superimposed to them. The 6243/6244 adopts a minimum noise design effective for input signals of a DC amplifier and other cases susceptible to power noise. This model is the perfect power supply for linear ICs, optical devices or mobile communication amplifiers.

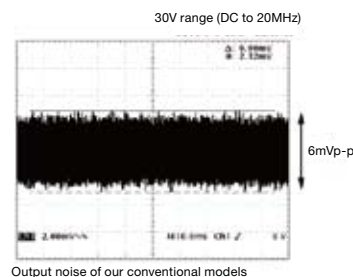
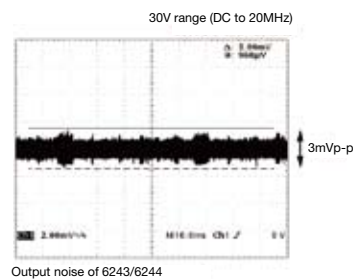

## For Characteristic Test for Transistor and FET

Synchronized operation of the two units of the 6243/6244 allows characteristic test of a transistor or FET.  $I_d$  and  $I_g$  can be measured simultaneously, as controlling the source timings of drain voltage and gate voltage to protect a device from stress.

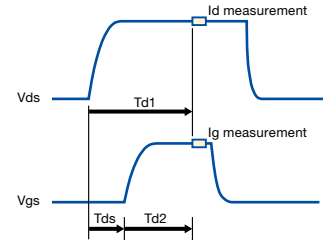
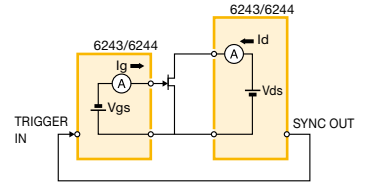

$T_{ds}$  : Source delay  
 $T_{d1}, T_{d2}$  : Measurement delay

- Linear, log and random sweep functions
- Pulse measurement with a minimum pulse of 1ms
- Measurement delay function for measurement timing control
- Source delay function for source timing control

<Example of FET measurement>

## For Battery Charge/Discharge Test

The 6243/6244 is available for battery charge and discharge test at constant current (CC) or constant voltage (CV) by DC or pulse application.

In a pulse charge and discharge test, measurement must be done at the time of and after the pulse application.

Using two units will allow measurement at the two points above and increase the current capacity up to 20A.

- Source sink current up to  $\pm 20A$  (7V)
- 20A (6244) and 4A (6243) by two-unit parallel operation
- Measurement at pulse HI/LO points
- Selectable from voltage measurement or current measurement

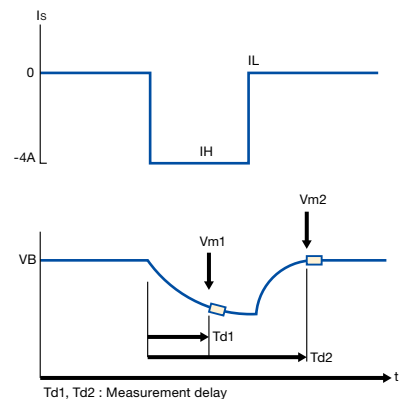
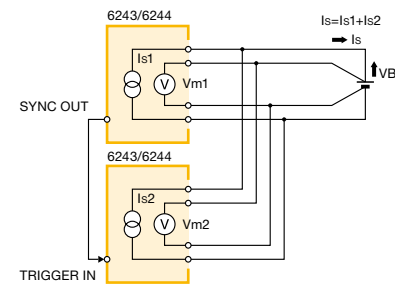

<Example of battery charge and discharge test>

## For Temperature Dependence Test of Diode VF

In a characteristic test on a power diode, applying pulse current is effective for avoiding the influence of self-heating.

The current pulse sweep function and pulse-synchronous voltage measurement ensure accurate VF characteristic test at large current.

Current pulse sweep ISVM

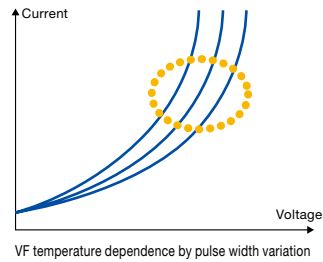
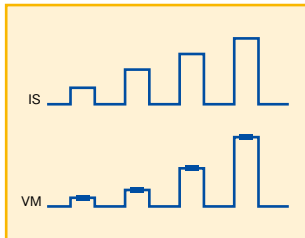
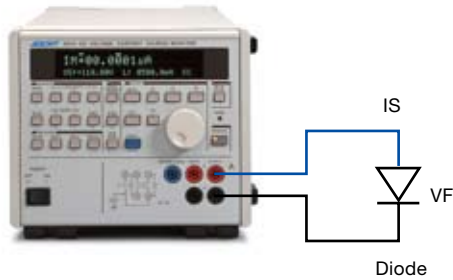

## For Dark Current Characteristic Test of Photodiode

The following functions of the 6243 are effective for photodiode characteristic test:

- Dark current-reverse voltage characteristic test function with 100pA resolution
- Breakdown voltage measurement by  $\pm 110V$  source and with the comparator function

DC voltage sweep VSIM

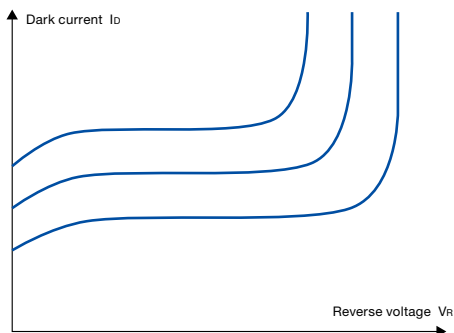
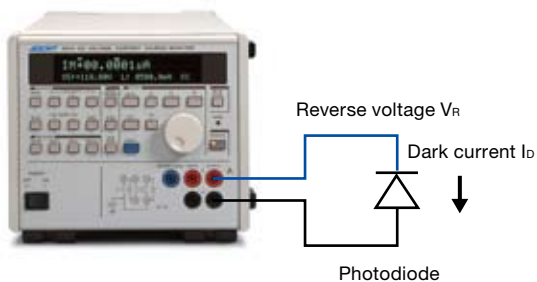

Temperature dependence of dark current-reverse voltage characteristic

## For DC/DC Converter Characteristic Test

The following functions are effective for DC/DC converter characteristic test:

- Parallel measurement of input current and output voltage/current by using two units
- Electronic load capable of operation down to 0V (General electronic loads do not operate at 0.8V or less.)
- Large output current up to 10A (7V) (6244)

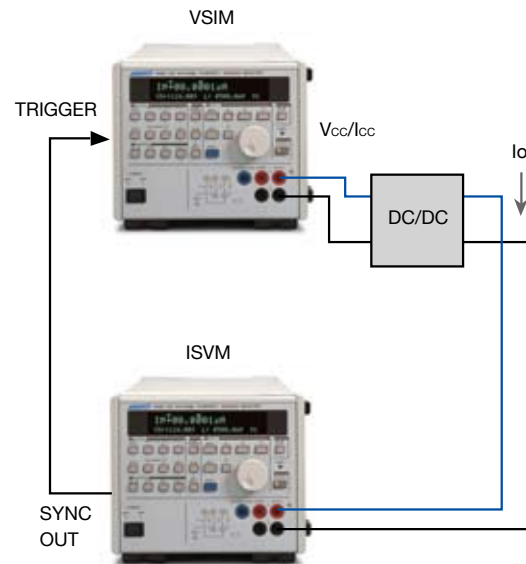

Parallel measurement of input current and output voltage

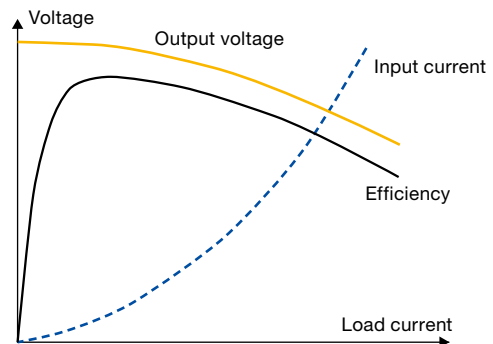

## Specifications

All accuracy specifications are guaranteed for one year at a temperature of 23 ±5°C and a relative humidity of 85% or less.

### 6243

#### Voltage source/measurement range

Range	Source range	Setting resolution	Measurement range	Measurement resolution
320mV	0 to ±320.00mV	10µV	0 to ±320.000mV	1µV
3.2V	0 to ±3.2000V	100µV	0 to ±3.20000V	10µV
32V	0 to ±32.000V	1mV	0 to ±32.0000V	100µV
110V	0 to ±110.00V	10mV	0 to ±110.000V	1mV

#### Current source/measurement range

Range	Source range	Setting resolution	Measurement range	Measurement resolution
32µA	0 to ±32.000µA	1nA	0 to ±32.0000µA	100pA
320µA	0 to ±320.00µA	10nA	0 to ±320.000µA	1nA
3.2mA	0 to ±3.2000mA	100nA	0 to ±3.20000mA	10nA
32mA	0 to ±32.000mA	1µA	0 to ±32.0000mA	100nA
320mA	0 to ±320.00mA	10µA	0 to ±320.000mA	1µA
2A	0 to ±2000.0mA	100µA	0 to ±2000.00mA	10µA

However, the measurement resolution with integration time 500µs and 1ms will be as follows

Integration time	500µs	1ms
Measurement resolution (digits)	5	3

#### Voltage limiter (compliance) range

Range	Maximum setting range	Minimum setting range	Setting resolution
320mV	320.00mV	3mV	10µV
3.2V	3.2000V	30mV	100µV
32V	32.000V	300mV	1mV
110V	110.00V	3V	10mV

#### Current limiter (compliance) range

Range	Maximum setting range	Minimum setting range	Setting resolution
32µA	32.000µA	300nA	1nA
320µA	320.00µA	3µA	10nA
3.2mA	3.2000mA	30µA	100nA
32mA	32.000mA	300µA	1µA
320mA	320.00mA	3mA	10µA
2A	2000.0mA	30mA	100µA

Overall accuracy: Includes calibration accuracy, 1-day stability, temperature coefficient and linearity

1-day stability: Under constant power and load

Temperature coefficient: At temperature of 0 to 50°C

#### Voltage source/voltage limiter

Range	Overall accuracy	1-day stability	Temperature coefficient
	±(% of setting+V)		±(ppm of setting+V)/°C
320mV	0.03+200µV	0.01+100µV	15+20µV
3.2V	0.03+600µV	0.01+300µV	15+50µV
32V	0.03+6mV	0.01+3mV	15+500µV
110V	0.03+30mV	0.01+20mV	15+2mV

#### Current source/current limiter

Range	Overall accuracy	1-day stability	Temperature coefficient
	±(% of setting+A+A×Vo/1V)		±(ppm of setting+A+A×Vo/1V)/°C
32µA	0.03+10nA+300pA	0.015+4nA+200pA	25+1nA+10pA
320µA	0.03+100nA+3nA	0.015+40nA+2nA	25+10nA+100pA
3.2mA	0.03+1µA+30nA	0.01+400nA+20nA	20+100nA+1nA
32mA	0.03+10µA+300nA	0.01+4µA+200nA	20+1µA+10nA
320mA	0.05+100µA+3µA	0.015+40µA+2µA	20+10µA+100nA
2A	0.06+1mA+30µA	0.03+400µA+20µA	20+100µA+1µA

Vo: Compliance voltage (0V to ±110V)

#### Voltage measurement (Auto zero: ON, integration time: 1PLC to 100PLC)

Range	Overall accuracy	1-day stability	Temperature coefficient
	±(% of reading+V)		±(ppm of reading+V)/°C
320mV	0.03+100µV	0.008+50µV	15+8µV
3.2V	0.03+150µV	0.008+100µV	15+10µV
32V	0.03+1mV	0.008+500µV	15+50µV
110V	0.03+8mV	0.008+3mV	15+500µV

#### Current measurement (Auto zero: ON, integration time: 1PLC to 100PLC)

Range	Overall accuracy	1-day stability	Temperature coefficient
	±(% of reading+A+A×Vo/1V)		±(ppm of reading+A+A×Vo/1V)/°C
32µA	0.03+8nA+300pA	0.015+3.5nA+200pA	25+600pA+10pA
320µA	0.03+80nA+3nA	0.015+35nA+2nA	25+6nA+100pA
3.2mA	0.03+800nA+30nA	0.01+350nA+20nA	20+60nA+1nA
32mA	0.03+8µA+300nA	0.01+3.5µA+200nA	20+600nA+10nA
320mA	0.05+80µA+3µA	0.015+35µA+2µA	20+6µA+100nA
2A	0.06+800µA+30µA	0.03+350µA+20µA	20+60µA+1µA

Vo: Compliance voltage (0V to ±110V)

The following errors are added to the accuracy and 1-day stability when the integration time is 10ms to 500µs.

Range	Integration time	Unit: digits		
		10ms	1ms	500µs
Voltage measurement	320mV	30	50	60
	3.2V to 110V	6	12	15
Current measurement	32µA	30	50	70
	320µA	15	25	30
	3.2mA to 2A	10	15	20

Source linearity: ±0.01% of range

Maximum output current: ±2A at up to 32V, ±1A at up to 64V, ±0.5A at up to 110V

Maximum compliance voltage: ±110V at up to 0.5A, ±64V at up to 1A, ±32V at up to 2A

### 6244

#### Voltage source/measurement range

Range	Source range	Setting resolution	Measurement range	Measurement resolution
320mV	0 to ±320.00mV	10µV	0 to ±320.000mV	1µV
3.2V	0 to ±3.2000V	100µV	0 to ±3.20000V	10µV
20V	0 to ±20.000V	1mV	0 to ±20.0000V	100µV

#### Current source/measurement range

Range	Source range	Setting resolution	Measurement range	Measurement resolution
320µA	0 to ±320.00µA	10nA	0 to ±320.000µA	1nA
3.2mA	0 to ±3.2000mA	100nA	0 to ±3.20000mA	10nA
32mA	0 to ±32.000mA	1µA	0 to ±32.0000mA	100nA
320mA	0 to ±320.00mA	10µA	0 to ±320.000mA	1µA
3.2A	0 to ±3200.0mA	100µA	0 to ±3200.00mA	10µA
10A	0 to ±10.000A	1mA	0 to ±10.0000A	100µA

However, the measurement resolution with integration time 500µs and 1ms will be as follows

Integration time	500µs	1ms
Measurement resolution (digits)	5	3

#### Voltage limiter (compliance) range

Range	Maximum setting range	Minimum setting range	Setting resolution
320mV	320.00mV	3mV	10µV
3.2V	3.2000V	30mV	100µV
20V	20.000V	300mV	1mV

#### Current limiter (compliance) range

Range	Maximum setting range	Minimum setting range	Setting resolution
320µA	320.00µA	3µA	10nA
3.2mA	3.2000mA	30µA	100nA
32mA	32.000mA	300µA	1µA
320mA	320.00mA	3mA	10µA
3.2A	3200.0mA	30mA	100µA
10A	10.000A	300mA	1mA



Overall accuracy: Includes calibration accuracy, 1-day stability, temperature coefficient and linearity

1-day stability: Under constant power and load

Temperature coefficient: At temperature of 0 to 50°C

#### Voltage source/voltage limiter

Range	Overall accuracy	1-day stability	Temperature coefficient
	±(% of setting+V)		±(ppm of setting+V)/°C
320mV	0.03+300µV	0.01+150µV	15+30µV
3.2V	0.03+600µV	0.01+300µV	15+50µV
20V	0.03+6mV	0.01+3mV	15+500µV

#### Current source/current limiter

Range	Overall accuracy	1-day stability	Temperature coefficient
	±(% of setting+A+A×Vo/1V)		±(ppm of setting+A+A×Vo/1V)/°C
320µA	0.03+100nA+3nA	0.015+42nA+2nA	25+10nA+100pA
3.2mA	0.03+1µA+30nA	0.01+420nA+20nA	20+100nA+1nA
32mA	0.03+10µA+300nA	0.01+4.2µA+200nA	20+1µA+10nA
320mA	0.05+100µA+3µA	0.015+42µA+2µA	20+10µA+100nA
3.2A	0.06+1mA+30µA	0.03+420µA+20µA	20+100µA+1µA
10A	0.1+10mA+300µA	0.08+4.2mA+200µA	90+1mA+10µA

Vo: Compliance voltage (0V to ±20V)

#### Voltage measurement

(Auto zero: ON, integration time: 1PLC to 100PLC)

Range	Overall accuracy	1-day stability	Temperature coefficient
	±(% of reading+V)		±(ppm of reading+V)/°C
320mV	0.03+200µV	0.008+100µV	15+20µV
3.2V	0.03+200µV	0.008+100µV	15+20µV
20V	0.03+1mV	0.008+500µV	15+50µV

#### Current measurement

(Auto zero: ON, integration time: 1PLC to 100PLC)

Range	Overall accuracy	1-day stability	Temperature coefficient
	±(% of reading+A+A×Vo/1V)		±(ppm of reading+A+A×Vo/1V)/°C
320µA	0.03+80nA+3nA	0.015+40nA+2nA	25+8nA+100pA
3.2mA	0.03+800nA+30nA	0.01+400nA+20nA	20+80nA+1nA
32mA	0.03+8µA+300nA	0.01+4µA+200nA	20+800nA+10nA
320mA	0.05+80µA+3µA	0.015+40µA+2µA	20+8µA+100nA
3.2A	0.06+800µA+30µA	0.03+400µA+20µA	20+800µA+1µA
10A	0.1+8mA+300µA	0.08+4mA+200µA	90+800µA+10µA

Vo: Compliance voltage (0V to ±20V)

The following errors are added to the accuracy and 1-day stability when the integration time is 10ms to 500µs.

	Range	Integration time			Unit: digits
		10ms	1ms	500µs	
Voltage measurement	320mA	30	50	60	
	3.2V to 110V	6	12	15	
Current measurement	320µA	15	25	30	
	3.2mA to 2A	10	15	20	

Source linearity: ±0.012% of range

However, the following errors are added for the 320mA, 3.2A, and 10A ranges.

	Range	±(% of setting)
Current measurement	320mA	0.01
	3.2A	0.02
	10A	0.07

Maximum output current: ±10A at up to 7V, ±4A at up to 20V

Maximum compliance voltage: ±20V at up to 4A, ±7V at up to 10A

## 6243/6244

#### 6243/6244 range table

	Range	6243	6244
Voltage source/voltage limiter	320mV	✓	✓
	3.2V	✓	✓
	20V	–	✓
	32V	✓	–
	110V	✓	–
Current source/current limiter	32µA	✓	–
	320µA	✓	✓
	3.2mA	✓	✓
	32mA	✓	✓
	320mA	✓	✓
	2A	✓	–
	3.2A	–	✓
10A	–	✓	

#### Voltage source/current source

Overall accuracy of reverse polarity limiters:

The accuracy of the source value and reverse polarity limiters is obtained by adding the data in the following table to the overall limiter accuracy. (The stability and the temperature coefficient are not added.)

	Range	Overall accuracy (% of setting+V)
Reverse polarity/voltage limiter	320mV	0.25+8mV
	3.2V	0.25+8mV
	20V/32V	0.25+80mV
	110V	0.25+300mV
	Range	Overall accuracy (% of setting+A)
Reverse polarity/current limiter	32µA	0.25+650nA
	320µA	0.25+6.5µA
	3.2mA	0.25+65µA
	32mA	0.25+650µA
	320mA	0.25+6.5mA
	2A/3.2A	0.25+65mA
	10A	0.25+650mA

Output noise: For voltage source, within the range from no load to the maximum load [Vp-p]

For current source, at the following load [Ap-p]

#### Voltage source

Range	Load resistance	Low frequency noise		High frequency noise
		DC to 100Hz	DC to 10kHz	DC to 20MHz
320mV	–	60µV	300µV	5mV
3.2V	–	100µV	400µV	5mV
20V/32V	–	1mV	3mV	6mV
110V	–	3mV	5mV	10mV

#### Current source

Range	Load resistance	Low frequency noise		High frequency noise
		DC to 100Hz	DC to 10kHz	DC to 20MHz
32µA	10kΩ	10nA	60nA	500nA
320µA	10kΩ	30nA	150nA	600nA
3.2mA	1kΩ	200nA	2µA	6µA
32mA	1kΩ	2µA	15µA	20µA
320mA	1kΩ	20µA	100µA	150µA
2A/3.2A	100Ω	200µA	1mA	1.5mA
10A	10Ω	2mA	10mA	15mA

### Switching noise

		Typical value [p-p]	Load resistance
Output ON/OFF noise	Voltage source	600mV	At 100kΩ
	Current source	600mV	At 100kΩ
Range switching noise	Voltage source	50mV	–
	Current source	70digits+50mV	–
	Voltage limiter	50mV <sup>*1</sup>	–
	Current limiter	50mV <sup>*1</sup>	–
	Voltage measurement	50mV <sup>*2</sup>	–
	Current measurement	50mV <sup>*1</sup>	–
Polarity switching noise	Voltage source	50mV	–
	Current source	50mV/RL	RL
Power OFF noise		600mV	At 100kΩ

\*1) 80mV when the voltage source range is the 110 V range.

\*2) The limiter is inactive. When the limiter is active, it is the same as the source range switching noise.

RL: Load resistor value

### Settling time

Time to reach the final value  $\pm 0.03\%$  when varying the output from zero to full-scale. This applies under the conditions of resistive load, load capacity of 2.5pF or less, and full-scale source and limiter setting values.

	Range	Settling time
Voltage source	320mV	300μs or less
	3.2V	
	20V/32V	700μs or less
	110V	2ms or less
Current source	32μA	3ms or less
	320μA	
	3.2mA	
	32mA	
	320mA	
	2A/3.2A	
	10A	

### Line regulation

$\pm 0.003\%$  of range

### Load regulation

Voltage source:  $\pm 0.003\%$  of range or less at 4-wire connection under the maximum load

Current source: Depending on the overall accuracy CMV ( $A \times V_o/1V$ )

Output resistance: At 2-wire connection (Output cable not included)

Maximum load capacitance: Maximum load capacitance that does not generate oscillation in voltage source or voltage limiter status

Range	Output resistance (Ω)		Maximum load capacitance
	Voltage source	Current source	
32μA	500mΩ or less	$1 \times 10^5 \Omega$ or higher	1μF
320μA	100mΩ or less	$1 \times 10^5 \Omega$ or higher	1μF
3.2mA	10mΩ or less	$1 \times 10^5 \Omega$ or higher	100μF
32mA	10mΩ or less	$1 \times 10^7 \Omega$ or higher	100μF
320mA	10mΩ or less	$1 \times 10^5 \Omega$ or higher	2000μF
2A/3.2A	10mΩ or less	$1 \times 10^5 \Omega$ or higher	2000μF
10A	10mΩ or less	$1 \times 10^4 \Omega$ or higher	2000μF

Supplied cable resistance: 100mΩ or less

### Maximum inductive load

Maximum inductive load that does not generate oscillation in current source or voltage limiter status

Current source range/current limiter range	32μA	320μA	3.2mA to 10A
Maximum inductive load	100μH	500μH	1mH

### Voltage/current measurement

Effective CMRR: At unbalanced impedance 1kΩ

In DC and AC 50/60 Hz  $\pm 0.08\%$

	Integration time	
	500μs to 10ms	1PLC to 100PLC
Voltage measurement/current measurement	60dB	120dB

NMRR: At AC 50/60 Hz  $\pm 0.08\%$

	Integration time	
	500μs to 10ms	1PLC to 100PLC
Voltage measurement/current measurement	0dB	60dB

### Source and measurement function

DC source and measurement	Source and measurement of DC voltage and current
Pulse source and measurement	Source and measurement of pulse voltage and current The LO and HI values of a pulse have the same polarity.
DC sweep source and measurement	Source and measurement by Linear, Log and Random levels
Pulse sweep source and measurement	Source and measurement by Linear, Log and Random levels The LO and HI values of a pulse have the same polarity.
Sweep mode	Reverse ON (round)/OFF (one way)
Sweep repeat count	1 to 1000 times or infinite
Maximum number of sweep steps	5000 steps
Maximum random sweep memory	5000 data
Measurement data buffer memory	5000 data
Calculation function	NULL calculation Comparator calculation (HI, GO, or LO)
Trigger style	Auto trigger (DC free run/Pulse repeat) External trigger
Output terminal	Front: Safety socket Rear: Safety socket (6243 only) HI OUTPUT, HI SENSE, LO OUTPUT, LO SENSE, DRIVING GUARD (6243 only)
Maximum input 6243	110V peak Max (between HI and LO, DG and LO) 1V peak Max (between OUTPUT and SENSE, HI and DG) 500V Max (between LO and chassis)
Maximum input 6244	20V peak Max (between HI and LO) 2V peak Max (between OUTPUT and SENSE) 250V Max (between LO and chassis)
Maximum remote sensing voltage	6243: $\pm 0.5V$ Max, 6244: $\pm 1V$ Max, HI OUTPUT - HI SENSE, LO OUTPUT - LO SENSE (The voltage between HI SENSE and LO SENSE must be within the maximum output voltage range)
Voltage measurement input resistance	1GΩ or higher
Voltage measurement input leak current	$\pm 2nA$ or lower
Maximum guard offset voltage	$\pm 2mV$ : between HI (SENSE) and DG (6243 only)
Maximum allowable guard capacity	1000pF: between HI (OUTPUT or SENSE) and DG (6243 only)
Maximum allowable shield capacity	5000pF: between DG and LO (OUTPUT or SENSE) (6243 only)
GPIB interface	Compliant with IEEE-488.1-1978 Interface function: SH1, AH1, T5, L4, SR1, RL1, PP0, DC1, DT1, C0, E2
External control signal	<ul style="list-style-type: none"> <li>● TRIGGER IN</li> <li>● SYNC OUT</li> <li>● COMPLETE OUT/BUSY IN/BUSY OUT</li> <li>● INTERLOCK/OPERATE IN/OPERATE OUT</li> </ul>

### Setting Time

Minimum pulse width: 1ms

Minimum step (repeat) time: Under fixed source range, in the free run or trigger mode, and with source delay time of 10μs

Measurement	Memory mode	Minimum step time
OFF	–	2ms
	BURST	4ms
	NORMAL	10ms
OFF		

For measurement ON, under fixed measurement range and with integration time of 500μs and source delay time of 300μs

Integration time: 500μs/1ms/10ms/1PLC/10PLC/100PLC

Source delay time

Setting range	Resolution	Setting accuracy
10μs to 600.00ms	10μs	$\pm (0.1\% + 30\mu s)$
600.1ms to 6000.0ms	100μs	
6001ms to 60000ms	1ms	

Period (pulse cycle)		
Setting range	Resolution	Setting accuracy
2ms to 600.00ms	10 $\mu$ s	$\pm(0.1\%+30\mu\text{s})$
600.1ms to 6000.0ms	100 $\mu$ s	
6001ms to 60000ms	1ms	
Pulse width		
Setting range	Resolution	Setting accuracy
1ms to 600.00ms	10 $\mu$ s	$\pm(0.1\%+30\mu\text{s})$
600.1ms to 6000.0ms	100 $\mu$ s	
6001ms to 60000ms	1ms	
Measurement delay time		
Setting range	Resolution	Setting accuracy
300 $\mu$ s to 600.00ms	10 $\mu$ s	$\pm(0.1\%+30\mu\text{s})$
600.1ms to 6000.0ms	100 $\mu$ s	
6001ms to 60000ms	1ms	
Hold time		
Setting range	Resolution	Setting accuracy
3ms to 60000ms	1ms	$\pm(2\%+1\text{ms})$
Auto range delay time		
Setting range	Resolution	Setting accuracy
0ms to 500ms	1ms	$\pm(5\%+1\text{ms})$

## General Specifications

Operating environment: Ambient temperature: 0°C to +50°C  
Relative humidity: 85% or less, no condensation  
However, for the 6244, the operating temperature is 0°C to +40°C in the following output ranges:

0V  $\leq$  Vo  $\leq$  7V: Io  $\geq$  3/7 Vo -10 [A]  
-7V  $\leq$  Vo  $\leq$  0V: Io  $\leq$  3/7 Vo +10 [A]  
Vo: Voltage between output terminals [V]  
Io: Output current [A]

Storage environment: Ambient temperature: -25°C to +70°C  
Relative humidity: 85% or less, no condensation  
Warm-up time: 60 minutes or more  
Display: 5  $\times$  7 dots matrix vacuum fluorescent display  
Power supply: AC power supply 100V/120V/220V/240V  
(User selectable)

Option number	Standard	OPT.32	OPT.42	OPT.44
Power voltage	100V	120V	220V	240V

Specify the option when ordering.  
Use a power cable and a fuse that are compliant with the safety standard when changing the power supply voltage.

Line frequency: 50Hz/60Hz  
Power consumption: 6243: 340VA or less  
6244: 400VA or less  
Dimensions: 6243: Approx. 212 (W)  $\times$  177 (H)  $\times$  450 (D) mm  
6244: Approx. 212 (W)  $\times$  177 (H)  $\times$  500 (D) mm  
Mass: 15kg or less

## Supplied Accessories

Name	Model	Quantity
Power cable	A01402	1
Input/output cable (safety plug)	A01044	1
Banana adapter (for A01044)	A08531	1

## Optional Accessories

Name	Model
Input cable (test probe)	A01041
Input/output cable (safety plug)	A01044
Banana adapter (for A01044)	A08531
Test fixture	12701A
JIS rack mount set (for 6243)	A02269
EIA rack mount set (for 6243)	A02469
Slide rail set	A02615
Side joint set (4U)	A02641
EIA rack mount set A (4U, with front handle)	A02710
JIS rack mount set A (4U, with front handle)	A02711
EIA rack mount set B (4U, without front handle)	A02720
JIS rack mount set B (4U, without front handle)	A02721
Input/output cable (banana- alligator, 1m for 6243)	A01023-100
Input/output cable (large current, 1m for 6243)	A01038-100
Input/output cable (large current, 0.5m for 6244)	A01047-01
Input/output cable (large current, 1m for 6244)	A01047-02
Input/output cable (large current, 1.5m for 6244)	A01047-03
Input/output cable (large current, 2m for 6244)	A01047-04

- Please read through the operation manual carefully before using the products.
- All specifications are subject to change without notice.



ADC CORPORATION

E-mail : [kcc@adcmt.com](mailto:kcc@adcmt.com) URL : <http://www.adcmt-e.com>

### Head Office

Shoei Bldg, 3-6-12, Kyobashi, Chuo-ku,  
Tokyo 104-0031, Japan  
Phone: +81-3-6272-4433 Fax: +81-3-6272-4437

### Higashimatsuyama Office (R&D Center)

77-1, Miyako Namegawa-machi, Hiki-gun,  
Saitama 355-0812, Japan  
Phone: +81-493-56-4433 Fax: +81-493-56-4281