

X-ray detectors

1 ■ Si photodiodes	P. 199
2 ■ CCD area image sensors	
2-1 Features	P. 200
2-2 Structure and characteristics	P. 200
2-3 How to use	P. 204
3 ■ CMOS area image sensors	
3-1 Features	P. 206
3-2 Usage	P. 207
3-3 New approaches	P. 207
4 ■ Flat panel sensors	
4-1 Features	P. 208
4-2 Structure	P. 208
4-3 Operating principle	P. 209
4-4 Characteristics	P. 210
4-5 How to use	P. 213
5 ■ Applications	
5-1 X-ray CT scanners	P. 215
5-2 Baggage inspection equipment	P. 215
5-3 Dental imaging	P. 215
5-4 Non-destructive inspection (for industry)	P. 216
5-5 Measurement of X-ray charge cloud shape	P. 216
5-6 X-ray imaging using pulsed X-ray source	P. 217
5-7 Acquiring enlarged images of small objects	P. 217
5-8 Cone beam CT	P. 218
5-9 X-ray diffraction	P. 218

X-ray detectors



X-rays were first discovered by Dr. W. Roentgen in Germany in 1895 and have currently been utilized in a wide range of fields including physics, industry, and medical diagnosis. Detectors for X-ray applications span a broad range including IP (imaging plates), single crystal detectors, and compound detectors, etc. Especially, there are many kinds of detectors made of silicon single crystals. HAMAMATSU offers Si photodiodes, Si APDs (avalanche photodiodes), CCD image sensors, and CMOS image sensors (flat panel sensors, etc.). Applications of our X-ray detectors include digital radiography, dental X-ray imaging, and X-ray CT in medical equipment fields, as well as physics experiments and non-destructive inspection of luggage, foods, and industrial products.

In the low energy X-ray region called the soft X-ray region from a few hundred eV to 20 keV, direct detectors such as Si PIN photodiodes, Si APDs, and CCD image sensors are utilized. These detectors provide high detection efficiency and high energy resolution, and so are used in physics experiments, X-ray analysis, and X-ray astronomical observation, etc. In recent years, research involving synchrotron radiation has been the subject of much attention. This field has also come to use CCD image sensors and CMOS image sensors.

The hard X-ray region with energy higher than soft X-rays is utilized in industrial and medical equipment because of high penetration efficiency through objects. Detectors combined with X-ray scintillators are widely used in these applications. Particularly, in medical equipment fields, semiconductor integration technology is supporting the amazing progress in improving image details and process speed for X-ray CT. These are just a few of the areas where use of CCD image sensors and CMOS image sensors is rapidly expanding and digitalization is in progress.

■ Example of detectable energy and spectral response range

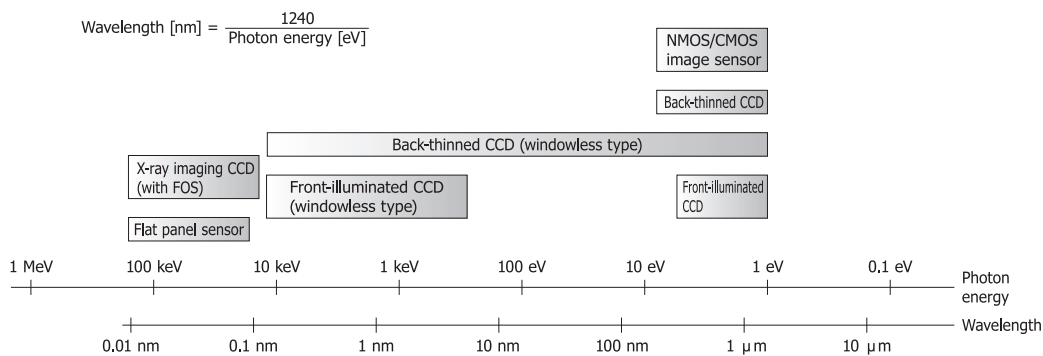

KMPDC0178EA

■ HAMAMATSU X-ray detectors

Type		Features
Si photodiode	Front-illuminated type	<ul style="list-style-type: none"> • Types with a large active area and low noise are available. • Products combined with ceramic or crystal scintillators are also available.
	Back-illuminated type	<ul style="list-style-type: none"> • CSP (chip size packages) capable of tiling (two-dimensional arrays)
Image sensor	CCD area image sensor	<ul style="list-style-type: none"> • Coupling of FOS to FFT-CCD • Front-illuminated CCD for direct X-ray detection also available
	Flat panel sensor	<ul style="list-style-type: none"> • For large-area two-dimensional imaging • Captures distortion-free, high-detail digital images in real time
	Photodiode array with amplifier	<ul style="list-style-type: none"> • Allows configuring a long, narrow image sensor by use of multiple arrays (See Chapter 4, "Image Sensors.")

1. Si photodiodes

Si photodiodes for X-ray detection are mainly used as scintillation detectors. In these detectors, a Si photodiode is bonded to a scintillator and sealed with high-purity epoxy resin to ensure high reliability. These detectors are also designed to allow as much scintillation light as possible into the active area of the photodiode.

Si photodiodes have a spectral response matching the emission spectra of typical scintillators [Figure 1-1]. HAMAMATSU also offers Si photodiodes combined with a ceramic scintillator or CsI scintillator. Except for the area bonded to the Si photodiode, these scintillators are coated with a reflector so light does not escape outside [Figure 1-2].

[Figure 1-1] Scintillator emission spectra and Si photodiode (S3590-08) spectral response

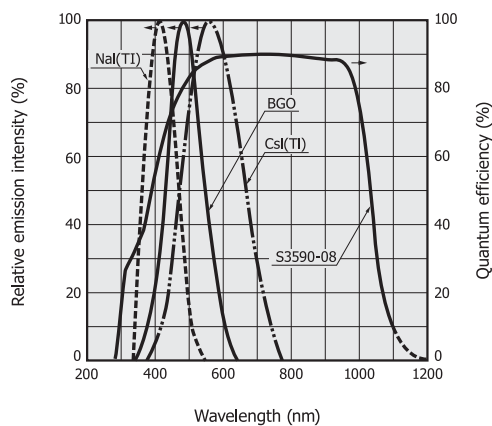

KSPDB0017EB

[Figure 1-2] Si photodiode with scintillator

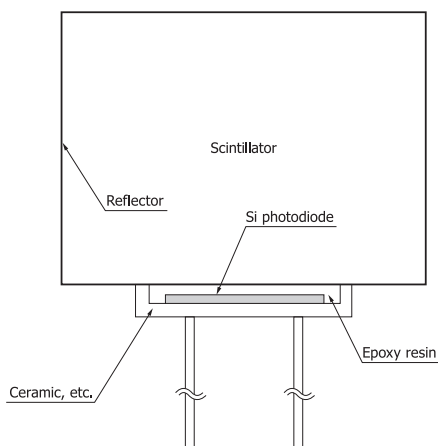

KSPDC0003EC

To detect high energy particles, we also provide large-area Si PIN photodiodes (S3590-08, etc.) that are used with reverse voltage applied.

When designing circuits for using Si photodiodes, the shot noise due to dark current and the capacitive noise in the circuit

have to be taken into account.

Two examples of Si photodiodes combined with a scintillator are shown in Figure 1-3.

[Figure 1-3] Examples of Si photodiodes combined with scintillator

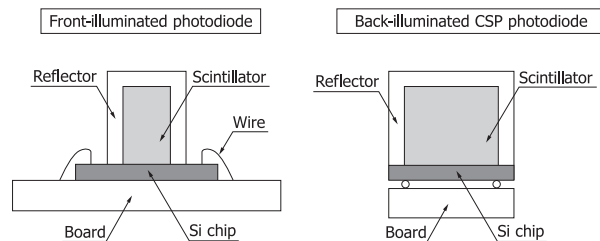

KSPDC0068EA

The wiring areas needed by front-illuminated photodiodes require making the chip and board sizes large by a corresponding amount. However, those wiring areas can be eliminated by using back-illuminated CSP (chip size package) photodiodes. This means that multiple-arrayed back-illuminated CSP photodiodes have narrow dead space.

As examples of scintillators, Table 1-1 shows characteristics of CsI(Tl) and ceramic scintillators. Ceramic scintillators feature small variations in light emission and high reliability. We do not recommend use of CWO as scintillator material since it contains cadmium which falls under environmental management substances.

[Table 1-1] Scintillator comparison table

Parameter	Condition	CsI(Tl)	Ceramic scintillator	Unit
Peak emission wavelength		560	520	nm
X-ray absorption coefficient	100 keV	10	7	-
Refractive index	At peak emission wavelength	1.74	2.2	-
Attenuation constant		1	3	μs
Afterglow	After 100 ms	0.3	0.01	%
Density		4.51	7.34	g/cm^3
Relative emission intensity	CWO=1.0	1.8	1.2	-
Color tone		Transparent	Faint yellow-green	-
Sensitivity variation		± 10	± 5	%

X-ray detection

Because X-rays have no electric charge, they do not directly create electron-hole pairs in a silicon crystal. However, the interaction of silicon atoms with X-rays causes the release from ground state of electrons whose energy equals that lost by irradiated X-rays. The Coulomb interaction of these electrons causes electron-hole pairs to be generated, so X-rays are indirectly detected by capturing these electron-hole pairs. The probability that X-rays will interact with silicon atoms is therefore a critical factor when detecting X-rays.

Si detectors can effectively detect X-rays at energy levels of 50

keV or less. Detection of X-rays less than 50 keV is dominated by the photoelectric effect that converts the X-ray energy into electron energy, so all energy of X-ray particles can then be detected by capturing the generated electrons with the detector. Detection of X-rays and gamma rays from 50 keV up to 5 MeV is dominated by the Compton scattering, and part of the X-ray and gamma ray energy is transformed into electron energy. In this case, the probability that the attenuated X-rays will further interact with silicon (by photoelectric effect and Compton scattering) also affects the detection probability, making the phenomenon more complicated.

Figure 1-4 shows the probabilities (dotted lines) of photoelectric effect and Compton scattering that may occur in a silicon substrate that is 200 μm thick, and the total interaction probabilities (solid lines) of silicon substrates that are 200 μm, 300 μm, and 500 μm thick.

As can be seen from the figure, Si detectors with a thicker substrate provide higher detection probability. With a 500 μm thick Si detector, the detection probability is nearly 100% at 10 keV, but falls to just a few percent at 100 keV. The approximate range of electrons inside a Si detector is 1 μm at 10 keV and 60 μm at 100 keV.

[Figure 1-4] Detection probabilities of Si detectors

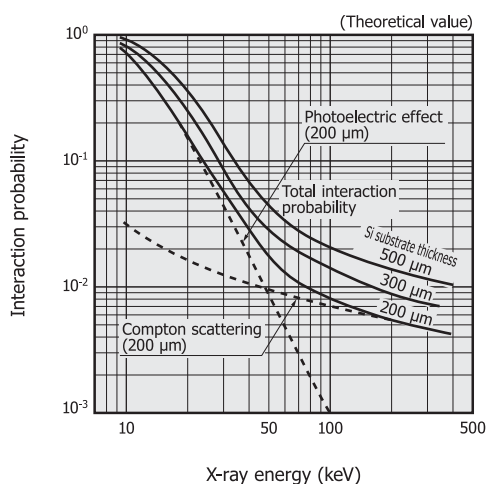

2. CCD area image sensors

Besides visible, infrared, and ultraviolet light, a CCD can directly detect and image X-rays below 10 keV. However, in the X-ray region from several dozen to more than 100 keV used for medical diagnosis and industrial non-destructive inspection, scintillators are needed to convert the X-rays into visible light. In this case, CsI and GOS scintillators are generally used, which convert X-rays into light at a peak of around 550 nm. The CCD then detects this light for X-ray detection.

In X-ray imaging applications requiring large-area detectors, HAMAMATSU provides front-illuminated CCD coupled to an FOS (fiber optic plate with scintillator). As a low cost type, we also offer CCD coupled to a GOS film. We also respond to requests for CCD coupled to an FOP (fiber optic plate).

2-1 Features

- Highly detailed images

High sensitivity and low noise are achieved by use of FFT (full frame transfer) type CCD, which is widely used for analysis and measurement.

- High-quality image type and low cost type available

The high-quality image type CCD uses a CsI (+ FOP) scintillator to convert X-rays to visible light, and the low-cost type CCD uses a GOS scintillator.

- Direct X-ray detection CCD (custom product) available

2-2 Structure and characteristics

Product lineup

(1) CCD area image sensors with FOS

This CCD is coupled to an FOS which is an FOP with scintillator. This CCD with FOS utilizes CsI as the scintillator to achieve high resolution. When X-rays strike the scintillator, it emits light of wavelengths around 550 nm which is guided to the CCD active area through the FOP. CCDs are damaged to some extent when exposed to X-rays. However, this CCD with FOS has an FOP on the CCD active area, and the FOP also serves as an X-ray shield to suppress damage by X-rays. Electric charges generated by X-rays incident near the surface of the CCD may cause noise, where white spots are seen at random positions. It degrades the image quality and makes the image noisy. This CCD with FOS, however, maintains high-quality images since the amount of X-rays incident on the CCD is small.

Thickening the scintillator increases the luminance, but

decreases the resolution (there is a trade-off here between luminance and resolution).

[Figure 2-1] X-ray transmittance in FOP

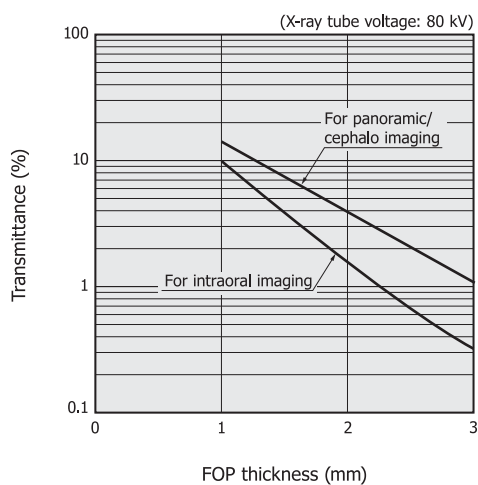

KMPDB0297EA

[Figure 2-2] CsI absorption coefficient

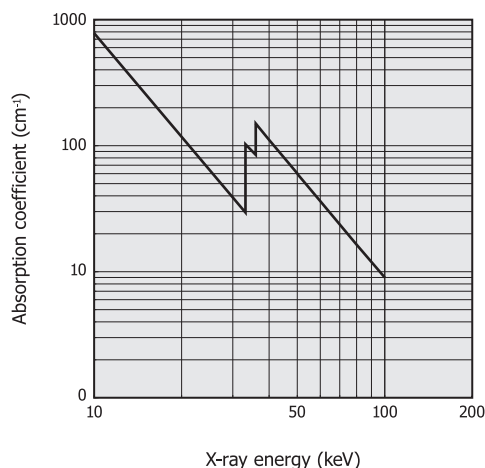

KMPDB0293EA

[Figure 2-3] CsI emission spectrum

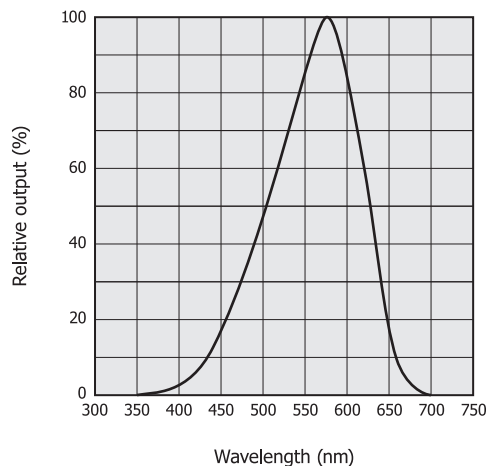

KMPDB0294EA

[Table 2-1] HAMAMATSU X-ray CCD area image sensors

Type	Scintillator*	Pixel size [μm (H) × μm (V)]	Number of effective pixels	Housing
CCD for intraoral imaging/ non-destructive inspection	CsI (+ FOP)	20 × 20	1500 × 1000	None
	GOS			Yes
	CsI (+ FOP)		1700 × 1200	None
	GOS			Yes
CCD for panoramic imaging/ non-destructive inspection	CsI (+ FOP)	48 × 48	1536 × 128 (× 2-chip buttable)	None
CCD for cephalo imaging/ non-destructive inspection			1536 × 128 (× 3-chip buttable)	
CCD for direct X-ray detection	None	24 × 24	512 × 512	None
			1024 × 124	
			1024 × 252	

* CsI (+ FOP): high-quality image type, GOS: low cost type

[Figure 2-4] CsI emission intensity

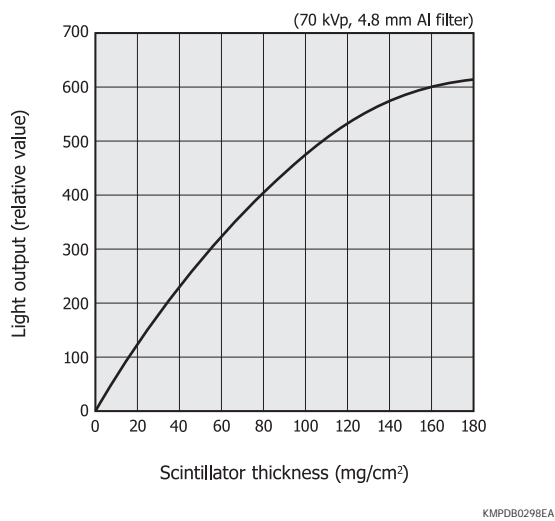

[Figure 2-5] CsI resolution

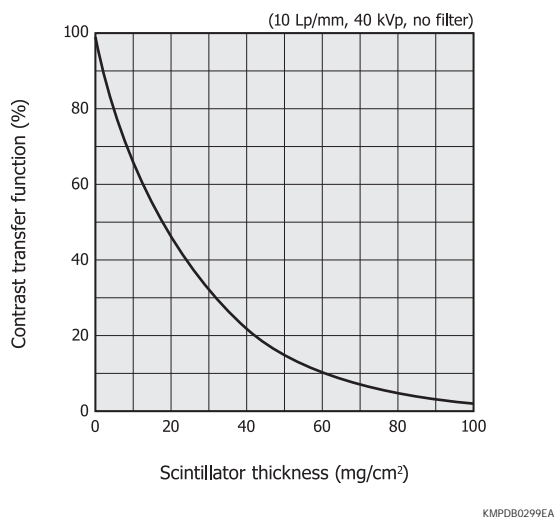

[Figure 2-6] Structure of CCD with FOS

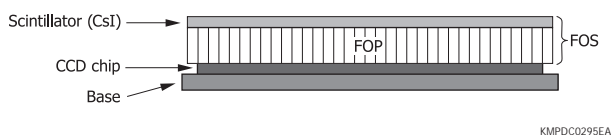

(2) CCD area image sensors with GOS scintillator

This type uses a GOS film directly coupled to the CCD as a scintillator. Unlike a CCD with FOS, this type does not use an FOP, so a larger amount of X-rays reach the CCD. In other words, compared to the CCD with FOS, the CCD with GOS scintillator is less resistant to X-rays, has poorer image quality compared to the CCD with FOS, but offers lower costs.

[Figure 2-7] Structure of CCD with GOS scintillator



(3) CCD area image sensors for direct X-ray detection

Windowless CCDs (front-illuminated type) are used for directly detecting X-rays from 0.5 keV to 10 keV. Direct X-ray detection CCDs are capable of both X-ray imaging and spectrometry. X-rays can be detected in photon-counting mode (method for counting individual photons one by one) to perform X-ray spectrometry. Direct X-ray detection CCDs are used in fields such as X-ray astronomy, plasma analysis, and crystal analysis. Incidentally, CCD with FOS or GOS scintillator can be used for X-ray imaging but not for X-ray spectrometry. Direct X-ray detection CCDs cannot be used to detect X-rays whose energy is lower than 0.5 keV since an absorption layer exists on the CCD surface. A back-thinned CCD must be used to detect X-rays whose energy is lower than 0.5 keV. To achieve high quantum efficiency in the energy region higher than 10 keV, a direct X-ray detection CCD with a thick depletion layer must be used. This type delivers high sensitivity in both the X-ray and infrared regions.

▣ Resolution

X-ray CCD resolution is mainly determined by the following factors:

- Pixel size
- Scintillator specifications (material, thickness)
- Gap between CCD chip and FOP (depends on thickness of coupling resin and the chip flatness)

Due to the CCD structure, the resolution determined by the pixel size cannot be exceeded.

Among scintillator materials used for X-ray CCDs, CsI offers higher resolution than GOS. The thicker scintillator results in higher emission intensity, yet the resolution falls as the thickness increases.

A gap between the CCD chip and FOP is determined by the chip flatness and also by the thickness of the resin used for coupling the chip to the FOP. Since the resolution decreases as this gap becomes wider, technology for keeping this gap at a narrow width is essential. The FOP flatness is superior to the chip flatness and so does not cause problems with the gap width.

▣ Buttable configuration

To obtain a long active area, panoramic imaging CCDs use two chips and cephalo imaging CCDs use three chips, with each chip being arranged in close proximity (buttable configuration). There is a narrow dead space between each chip. See Figure 2-8 for an example of this dead space.

Principle of direct X-ray detection

Photons at an energy higher than a specified level generate electron-hole pairs when they enter a CCD. If the photon energy is small as in the case of visible light, only one electron-hole pair is generated by one photon. In the vacuum UV and soft X-ray regions where photon energy is greater than 5 eV, multiple electron-hole pairs are generated by one photon. The average energy required for silicon to produce one electron-hole pair is approx. 3.6 eV. So an incident photon at 5.9 keV (K_{α} of manganese), for example, generates 1620 electron-hole pairs in the CCD. The number of electrons generated by direct X-ray detection is proportional to the energy of the incident photons. X-ray spectrometry is possible even if just one X-ray photon is incident on the CCD.

Factors that determine energy resolution

Figure 2-9 shows energy spectra measured by detecting soft X-rays ($Mn-K_{\alpha}/K_{\beta}$) incident on a CCD from an Fe-55 radiation source. Spectrum resolution is usually evaluated by using the FWHM (full width at half maximum). The Fano limit (theoretical limit of energy resolution) of Si detectors for Fe-55 is 109 eV.

Major factors that degrade energy resolution are CCD charge transfer efficiency and CCD noise including dark current. When a CCD is sufficiently cooled down and is operated at a charge transfer efficiency of 1×10^{-5} or less, the energy resolution is determined by the readout noise. To enhance energy resolution, the CCD readout noise has to be less than $5 e^{-}$ rms. The energy resolution of optimally adjusted HAMAMATSU CCDs is below 140 eV for Fe-55.

There are two modes for evaluating the CCD quantum efficiency in the X-ray region. One is the photon-counting mode, and the other is the flux mode that integrates all photons.

The quantum efficiency in the visible region is usually evaluated in the flux mode.

[Figure 2-9] CCD energy resolution in soft X-ray ($Mn-K_{\alpha}/K_{\beta}$) detection (typical example)

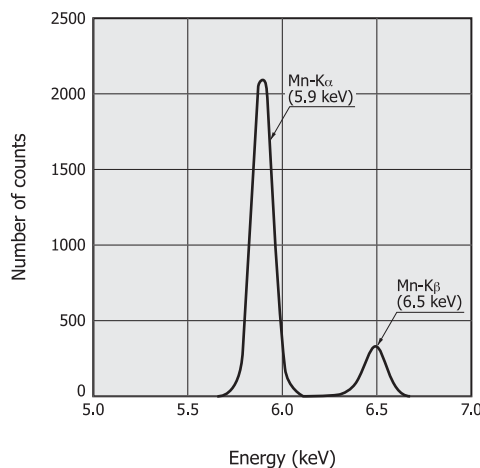

KMPDB0236EA

[Figure 2-8] Example of CCD for cephalo imaging and non-destructive inspection (S8658-01)

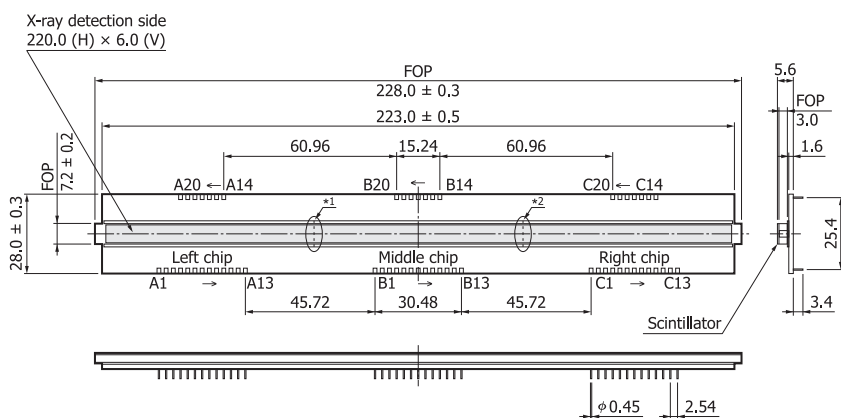

Enlarged view of portion *1

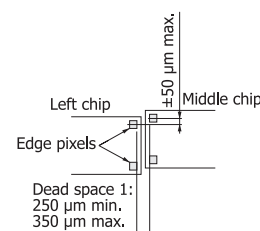

Enlarged view of portion *2

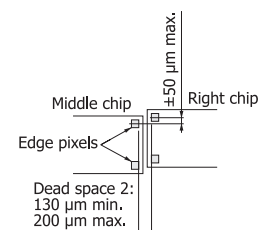

KMPDA0251EA

[Figure 2-10] Quantum efficiency vs. photon energy

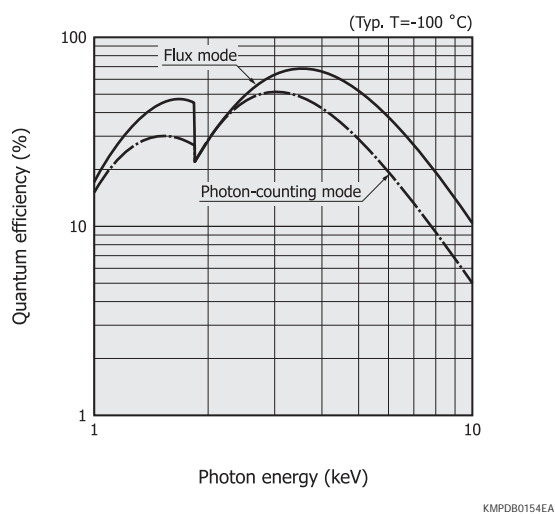

2-3 How to use

There are two methods for capturing X-ray images: one-shot and TDI operation imaging.

One-shot imaging is mainly used by CCDs for intraoral imaging and non-destructive inspection. During one-shot imaging, the CCD starts integration at a point that X-rays enter the CCD. To detect the X-ray input timing, a monitor photodiode is formed on the same chip of the CCDs for intraoral imaging and non-destructive inspection.

In the CCD pixels, charges are constantly generated due to dark current, so those charges are constantly drained when no X-rays are being input (standby state).

CCDs for panoramic/cephalo imaging and non-destructive inspection capture images mainly by TDI operation. When using TDI operation, the pixel transfer speed has to be made to match the motion speed of the object. (See Chapter 4, “Image sensors.”)

Correction

CCDs may sometimes have pixel defects known as white spots where the dark current is large, and black spots where the output is low (low sensitivity). Scintillator and FOP performance also affect the image quality of X-ray CCDs. To achieve high image quality, we recommend using software to compensate for the dark current and sensitivity. See Chapter 4, “Image sensors,” for information on compensating for pixel defects, dark current, and sensitivity.

Multiple CCD chips are combined in CCDs for panoramic/cephalo imaging and non-destructive inspection, and there is a seam joint between each chip. Software compensation may help suppress effects from these seam joints.

Precautions

Take the following precautions when using an X-ray CCD.

(1) Anti-static and surge measures

For measures to avoid electrostatic charge and surge voltage on an X-ray CCD, refer to “1-3 How to use” in section 1 “CCD area image sensors,” in Chapter 4, “Image sensors.”

(2) Operating and storage environment

X-ray CCDs are not hermetically sealed, so avoid operating or storing them in high humidity locations. Also do not store in locations subject to excessive vibrations.

(3) Deterioration by X-ray irradiation

Like other X-ray detectors, X-ray CCD performance deteriorates due to X-ray irradiation, for example causing the dark current to increase and X-ray sensitivity to decrease. In some applications, CCDs should be replaced as a consumable product.

(4) Handling CCD with FOS

- FOP is made from glass, so do not apply a strong force and shocks to it.
- Do not touch the scintillator section and active area. A soiled or scratched scintillator may cause changes in sensitivity. Bonding wire is coated with a protective resin but is soft, so be careful not to damage or break it.
- When holding the sensor, hold the board by the edges with your fingers as shown in the photos [Figure 2-11 (a)].
- Never apply force to the FOS [Figure 2-11 (b)].
- When inserting an FPC into the connector of an intraoral imaging CCD (with no housing), do not apply excessive force to the connector [Figure 2-11 (c)].

[Figure 2-11] Precautions when holding the sensor

(a) Hold the board by the edges with fingers.

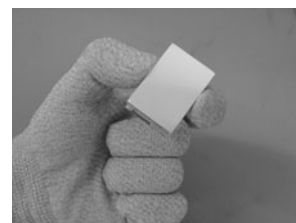
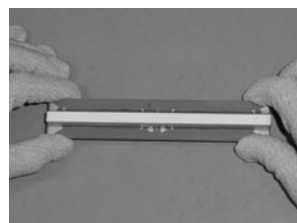

(b) Do not apply force to the FOS.

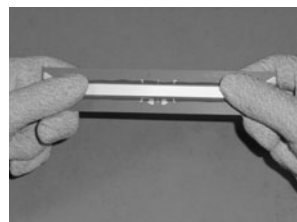

(c) Do not apply excessive force to the connector when inserting the FPC.

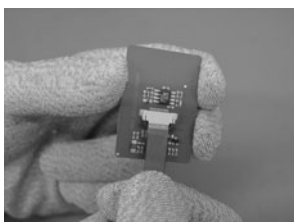

(5) Handling the intraoral imaging CCD (housing type)

- Do not apply excessive force to the CCD sensor section. Dropping it or biting it strongly while inside the mouth may cause failure.
- Applying an excessive force by bending or pulling on the cable may cause breakdowns such as the cable breaking internally, so use caution during handling.
- To clean the CCD, wipe it with an alcohol-based solution. Do not immerse the entire CCD in cleaning solution since this causes failure.
- When not using the sensor, store it after attaching the terminal shorting piece (pre-attached at factory before shipping) to the connector section.

(6) Others

If using an X-ray CCD for medical equipment, please contact us.

▣ CCD controller

HAMAMATSU provides a CCD controller (C9266-04) for intraoral imaging and non-destructive inspection.

This CCD controller consists of a driver circuit, signal processing circuit (12-bit A/D converter), timing generator, USB controller, and power supply, etc. An analog video signal from a CCD is output as a digital signal to an external unit. The controller connects to a PC using the USB connector (USB 2.0 supported) that comes supplied with the controller, and supports control and data acquisition from the PC. Power to the controller is supplied from the PC through the USB connector, so no external power supply is required.

Data acquisition timing is obtained by automatically detecting signals from the X-ray detection photodiode inside the CCD, and X-ray images then acquired. This controller contains a sub-array binning (2×2) function for making the image data size smaller and the transfer speed higher, as well as a gain and offset adjustment function, etc.

This CCD controller comes with an application software (C9266DCamAPL) that runs on Windows 2000/XP. This application software is supplied with a function library (DCamDLL) to help users develop their own software.

[Figure 2-12] CCD controller (C9266-04)



[Figure 2-13] Block diagram (C9266-04)

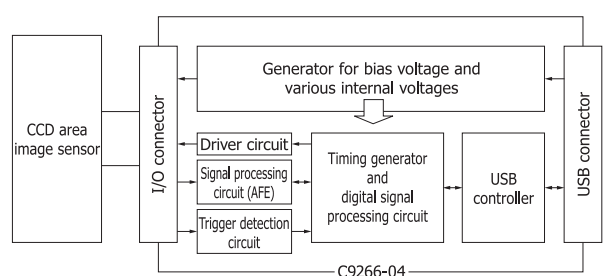

KACCC0472EB

3. CMOS area image sensors

These are CMOS area image sensors designed for intraoral imaging and non-destructive inspection. These image sensors make use of advantages offered by active pixel type CMOS devices, including high integration, sophisticated functions, and good S/N. The CMOS image sensor chip contains a timing generator, vertical and horizontal shift registers, readout amplifier, A/D converter, LVDS, etc. The digital input and output make these image sensors very easy to use. These image sensors contain a global shutter function (integrates charges simultaneously in all pixels) that allows acquiring one shot of an X-ray image in synchronization with the X-ray irradiation timing.

Since these image sensors also have an internal A/D converter, analog video wiring can be kept short to reduce noise. The internal A/D converter also simplifies the external circuit and helps hold down the overall cost. The digital video signal is output in LVDS format, so data can be transferred at high speeds using a cable about 2 meters long.

[Figure 3-1] Block diagram (external clock pulses input type)

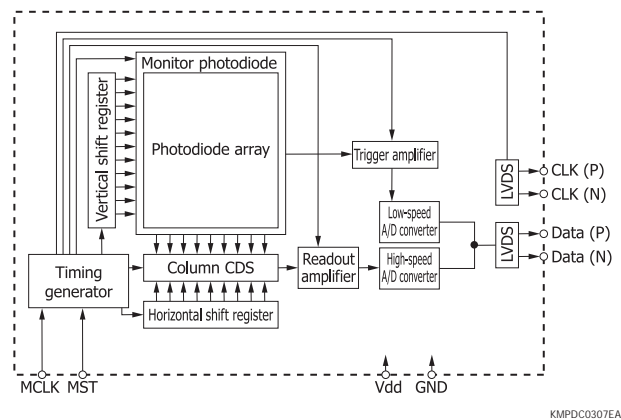

3-1 Features

▶ Comparing CMOS and CCD

In regions where signal levels are low, CCD area image sensors provide better image quality. The multifunctionality and ease

[Table 3-1] HAMAMATSU X-ray CMOS area image sensors

Type	Scintillator	Pixel size [μm (H) × μm (V)]	Number of effective pixels	Housing	Clock pulse
For intraoral imaging and non-destructive inspection	CsI (+ FOP)	20 × 20	1000 × 1500	None	Internally generated
				Yes	
			1300 × 1700	None	
				Yes	
1000 × 1500	Yes	Input from external			
			1300 × 1700		

of use are core parts of CMOS technology. CMOS area image sensors also offer the advantage of a lower overall cost because peripheral circuit functions can easily be built into the CMOS chip.

▶ Hexagonal active area

Using a hexagonal-shaped active area makes it easy to form the image sensor housing into a round shape. This round shape helps alleviate the strange sensation when the sensor housing is inserted in the patient's mouth. The vertical shift register for the obliquely cut portions of the active area are formed along the oblique lines.

▶ Internal monitor photodiode

In the X-ray CMOS area image sensors, a monitor photodiode for detecting the X-ray irradiation start timing (trigger) is mounted as a narrow strip along the entire circumference on the outer side of the active area. The output from this monitor photodiode is sent to an external control circuit. When this output exceeds a threshold value, the external control circuit recognizes X-ray emission, and then the CMOS area image sensor starts charge integration and readout.

[Figure 3-2] Hexagonal active area and monitor photodiode

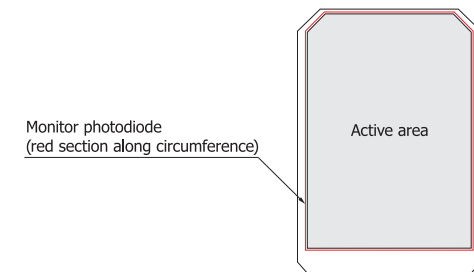

▶ Low power consumption

X-ray CMOS area image sensors have an internal high-speed A/D converter (14 bits) for image data, and a low-speed A/D converter (10 bits) for monitor photodiode data. The high-speed A/D converter which uses up much current starts only when image data is transferred. Only the low-speed A/D converter which consumes low power is on during the long periods of

standby for X-ray irradiation. This method keeps the average power consumption lower and suppresses heat generation in the sensor. This lower power consumption also makes the sensor suitable for battery operation.

[Figure 3-3] Block diagram

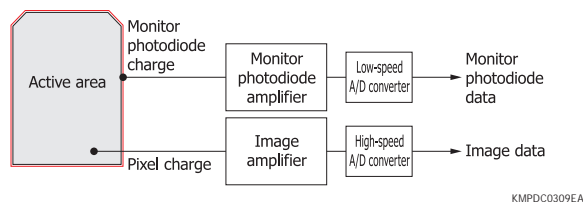

3-2 Usage

Since X-ray CMOS area image sensors have an internal timing generator, it is possible to monitor X-ray emission timing and also accumulate and read out image data just by input of a start pulse and clock pulse. Data from the monitor photodiode and image data are switched by an internal switch so that they are output from the same video line.

A type that generates internal clock pulses (with internal quartz IC) operates just by input of an external start pulse [Figure 3-4]. This type of sensor uses a small number of pins, so the cable shield can be made thicker to enhance reliability.

[Figure 3-4] Input/output wiring diagram of type generating internal clock pulses

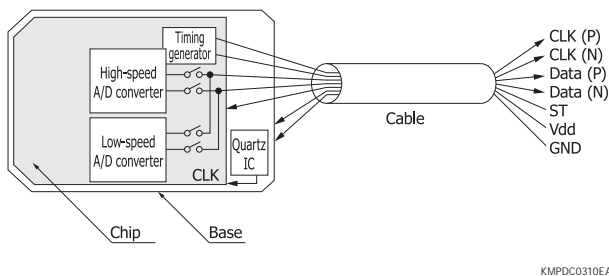

For information on “Correction” and “Precautions,” refer to “2. CCD area image sensors” in Chapter 8, “X-ray detectors.”

3-3 New approaches

HAMAMATSU is responding to market demands including higher performance by taking advantage of the sophisticated functions and high integration offered by CMOS devices. HAMAMATSU also responds to needs for custom package designs (shape, color, etc.).

4. Flat panel sensors

Flat panel sensors are X-ray imaging modules that use a large-area CMOS image sensor combined with a scintillator. The detector (two-dimensional photodiode array), high-performance charge amplifier, and scanning circuit are all integrated onto a large-area CMOS single-crystal silicon chip. The A/D converters, memories, interface circuit, and the control signal generator that controls these components are assembled into a module. There is no need to use an external circuit to operate the device. The flat panel sensor can capture megapixel-class, high definition digital images which are distortion-free in both still and moving images. The thin profile and light weight make the flat panel sensor easy to install into other equipment. Flat panel sensors are now widely used in various types of X-ray imaging systems including CT, etc.

[Figure 4-1] Flat panel sensors

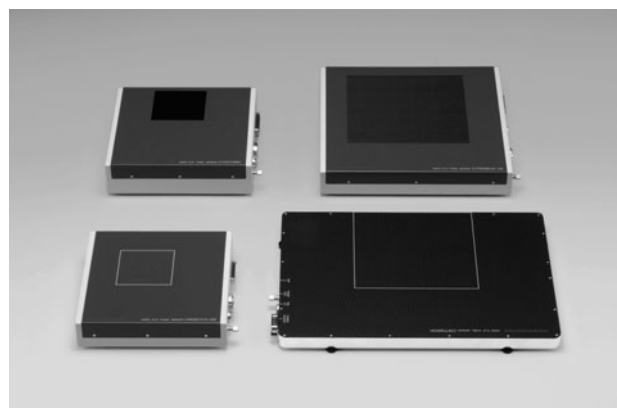

[Figure 4-2] Imaging examples

(a) Hornet



(b) Fish

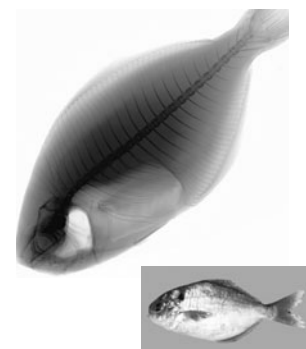

[Table 4-1] HAMAMATSU flat panel sensors

Type	Application examples	Features	
For radiography	<ul style="list-style-type: none"> • Digital radiography • Physics and chemistry measurement such as X-ray diffraction 	<ul style="list-style-type: none"> • High sensitivity • High frame rate • Thin profile 	<ul style="list-style-type: none"> • Large active area • Low noise • Light weight
For non-destructive inspection	<ul style="list-style-type: none"> • Material inspection for industrial products • Product inspection 	<ul style="list-style-type: none"> • High frame rate • Wide dynamic range • Compact size 	<ul style="list-style-type: none"> • High resolution • Distortion-free images

4-1 Features

- Large-area CMOS area image sensor made from single-crystal silicon
- High sensitivity
- High resolution
- High frame rate
- Wide dynamic range
- Distortion-free images
- Directly deposited CsI(Tl) scintillator type is available.

4-2 Structure

Figure 4-3 shows the internal circuit of a CMOS chip for flat panel sensors. Two-dimensional X-ray image signals converted into fluorescence by a scintillator are accumulated as an electric charge in the junction capacitance of each photodiode with excellent linearity. The accumulated charges are then output one row at a time through the data line by the vertical shift register when the address switch turns on. Since the flat panel sensor operates in charge integration mode, the output video signal voltage $V(t)$ is expressed by equation (1).

$$V(t) = G \times Q(t) = G \times I(t) \times t_1 = G \times I(t) \times 1/Sf \dots(1)$$

- G : amplifier gain
- Q(t) : integrated charge
- I(t) : photodiode photocurrent
- t1 : integration time
- Sf : frame rate

When a constant radiation dose is striking an object, the photocurrent generated in a photodiode is constant. The output voltage can be increased by slowing the frame rate (making the integration time longer). The frame rate can be controlled by the external trigger mode described later on. The saturation charge is determined by the photodiode junction capacitance. The maximum video output value after A/D conversion is set to the saturation charge value.

Amplifier circuit

There are two types of amplifier circuits for flat panel sensors: a passive pixel type and an active pixel type.

The passive pixel type has an amplifier for each column of the photodiode array, where the amplifier is connected to each photodiode via address switches. The amplifiers are formed on one side of the two-dimensional active area as an amplifier array. The passive pixel type allows a high fill factor and high radiation durability. However, the input capacitance caused by the long data line limits the reduction in amplifier thermal noise.

The active pixel type structure eliminates the foregoing problem in the passive pixel type. The active pixel type has an amplifier for each pixel, and the accumulated charges are converted into voltage there. This structure lowers the noise level below 180 electrons, which is less than 1/6 of the passive pixel type. Because of its low noise and high S/N features, the active pixel type flat panel sensor acquires high definition images from low energy X-rays.

[Figure 4-3] Internal circuits of CMOS chip

(a) Passive pixel type

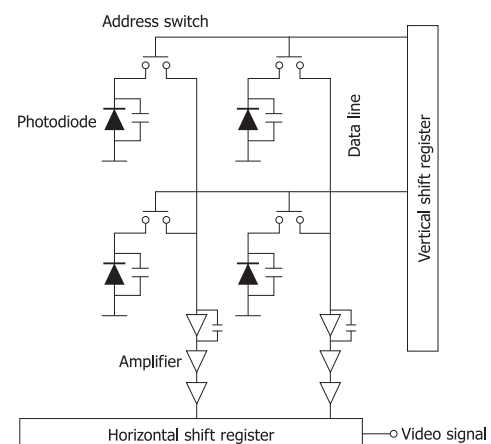

KACCC0224EA

(b) Active pixel type

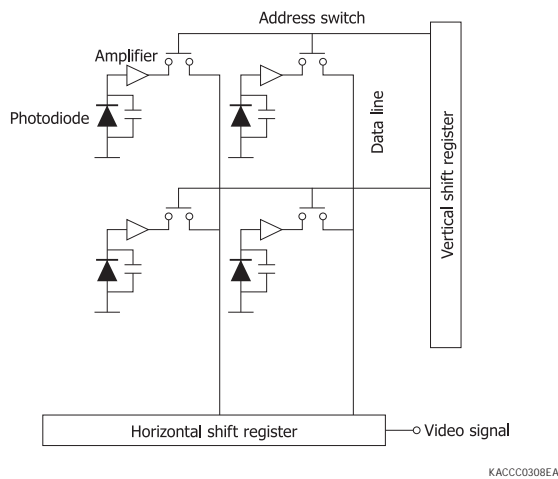

Scintillator

Flat panel sensors employ an indirect X-ray detection method that converts X-rays into visible light using a scintillator and then detects that light. This method requires photodiodes with spectral response that matches the peak wavelength and spectral range of the scintillator emission. By optimizing the wafer process technology, HAMAMATSU has succeeded in developing a high-sensitivity photodiode that matches the spectral characteristics of the scintillator.

The CsI(Tl) scintillator [Figure 4-4] used for most flat panel sensors has needle-like crystals through which scintillation light propagates, and flat panel sensors with CsI(Tl) scintillator therefore have superior resolution and luminance compared to flat panel sensors using other scintillators composed of grain (particle) crystals (such as GOS).

[Figure 4-4] Cross-section photo of CsI(Tl) scintillator showing needle-like crystals

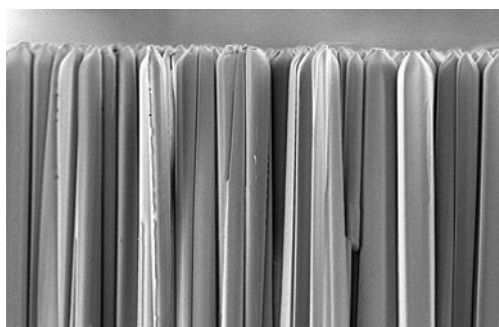

There are two scintillator-to-photodiode coupling methods. One method uses an FSP (flipped scintillator plate), which is a glass plate on which the scintillator is deposited, and the scintillator side of the FSP is attached in close contact with the photodiode. The other method is direct deposition of scintillator onto the photodiode. The method using a CsI(Tl) FSP has better fluorescent intensity and resolution than medical screens utilizing GOS. The direct deposition method further improves the resolution because it suppresses fluorescence scattering

compared to the FSP method.

HAMAMATSU provides both FSP type and direct deposition type flat panel sensors that can be selected according to the application.

[Figure 4-5] Cross-section structures of chip

(a) FSP type

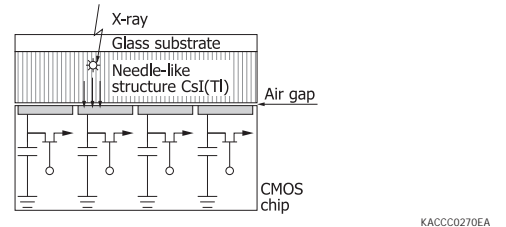

(b) Direct deposition type

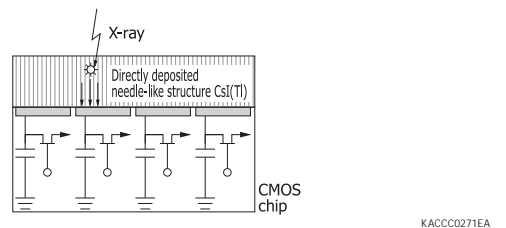

Tiling

Some flat panel sensors have a large-format active area achieved using the “tiling” technique. Highly precise tiling techniques now allow acquiring an X-ray image which contains no gaps at the tiling edges. Though the sensitivity of the pixels at the tiling edges decreases, it is still high enough to be corrected by software, so seamless images can be obtained.

[Figure 4-6] Cross-sectional diagram of tiling edges of active area

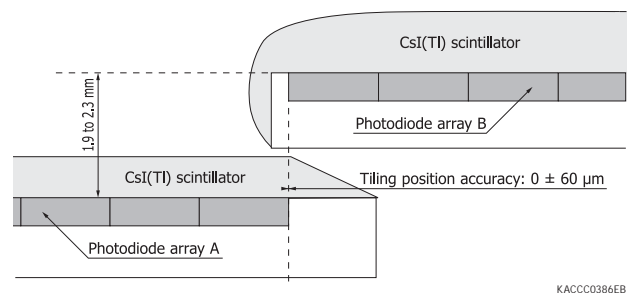

4 - 3 Operating principle

Signal readout method

The following methods are generally used to read out digital signals.

(1) Serial drive method

This method reads out video data by serially driving all pixels, so the frame rate slows down when there are a large number of pixels.

(2) Parallel drive method

- Single port readout method

This method divides the monolithic active area into multiple blocks, and reads out video data through a single port by driving each block in parallel.

Figure 4-7 shows a schematic of an active area divided into “n” blocks. Since flat panel sensors have many pixels numbering more than one million, the serial drive method causes the frame rate to drop. The single port readout method, however, offers high speed and easy processing of video data and so is used for most flat panel sensors.

- Multiport readout method

This method reads out video data through multiple ports to achieve even higher speed drive than the single port readout method. Providing multiple ports for video data readout can increase the image data transfer amount per unit time, which is larger than that of the single port readout method. Some flat panel sensors use this method.

[Figure 4-7] Schematic of parallel drive method

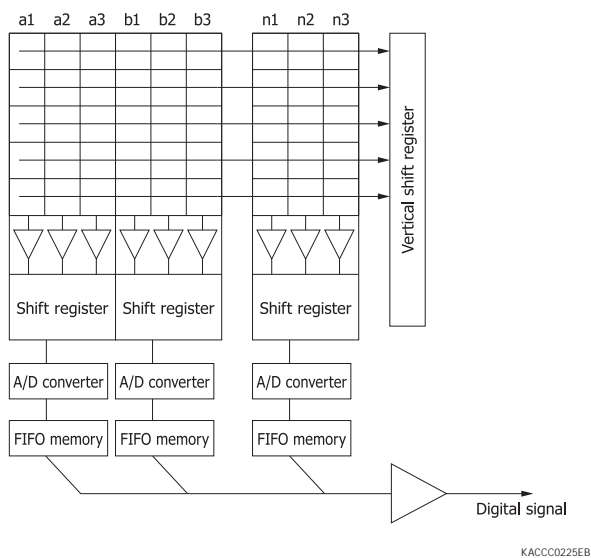

▶ Video output

Flat panel sensors provide 12-bit, 13-bit, or 14-bit digital video output. They use three types of synchronous signals: vertical sync signal (Vsync), horizontal sync signal (Hsync), and pixel clock (Pclk). The RS-422, LVDS, or USB 2.0 is used to ensure high-speed, long-distance data transmission of the digital video signals and synchronous signals. The USB 2.0 supports the DCAM that is our standard digital camera interface.

▶ Binning mode

Flat panel sensors have a binning mode function that simultaneously reads out multiple pixel data. In 2 × 2 binning mode for example, the neighboring 2 × 2 pixel data are read

out all at once. Up to 4 × 4 pixels can be selected for binning though this depends on the sensor models. Increasing the number of binning pixels also increases the sensor frame rate. Note that the highest resolution is obtained by single operation (1 × 1 mode) without using binning mode.

4 - 4 Characteristics

▶ Spectral response

The active area of flat panel sensors consists of a two-dimensional photodiode array. Figure 4-8 shows the spectral response of a typical flat panel sensor and the emission spectrum of a CsI(Tl) scintillator. To achieve high sensitivity, the photodiode array is designed to have high sensitivity in the vicinity of the peak emission wavelength of CsI(Tl).

The X-ray energy range at which flat panel sensors are sensitive differs depending on the sensor model. Refer to their datasheets for details.

[Figure 4-8] Example of spectral response and CsI(Tl) scintillator emission spectrum

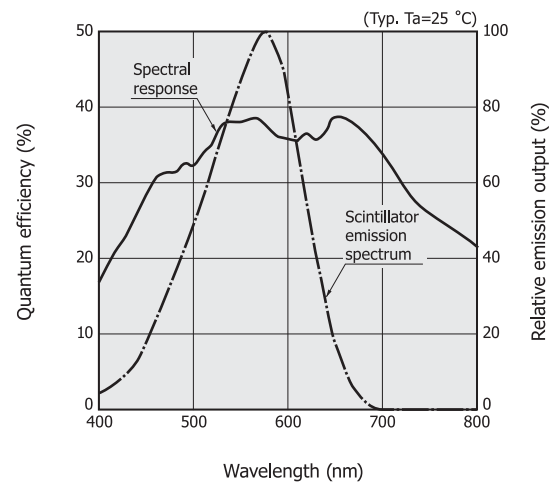

▶ Linearity

Flat panel sensors exhibit excellent linearity versus the incident X-ray levels. Figure 4-9 shows the output linearity of a flat panel sensor (14-bit output). The upper limit of the 14-bit output is 16383 gray levels.

[Figure 4-9] Output linearity (14-bit output, typical example)

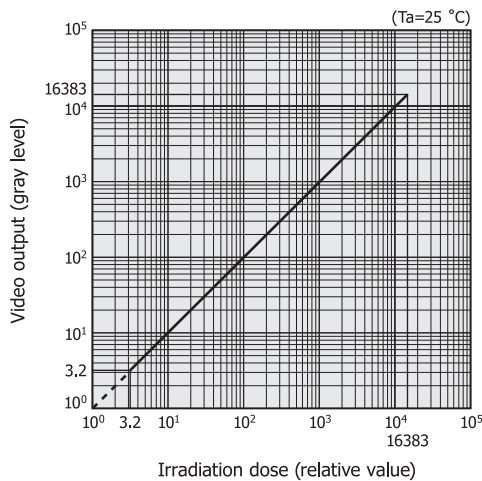

KACCB0063EB

Dark video output

When the integration time is set longer, dark video output slightly increases due to the photodiode dark current. Figure 4-10 shows the relationship between dark video output and integration time for a flat panel sensor (14-bit output). The photodiode dark current (I_D) is expressed by equation (2).

$$I_D = K/G [C/s] \dots\dots\dots(2)$$

K : increasing rate [gray levels/s] of dark video output versus integration time
 G : conversion gain

[Figure 4-10] Dark video output vs. integration time (14-bit output, typical example)

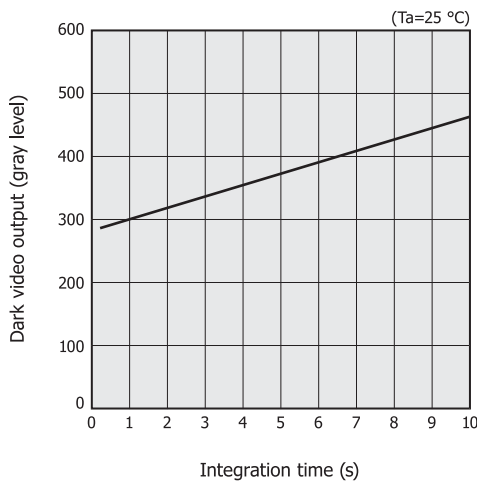

KACCB0064EA

A slight drift occurs in the dark video output after the power is turned on. Figure 4-11 shows examples from measuring this dark video output drift. In internal trigger mode (2 frames/s), the dark video output shows little change after the power is turned on. At a slow frame rate, however, the dark video output varies. In applications where fluctuations in the dark video output cause problems, determine how often dark images should be acquired for correction to meet the allowable drift level range.

[Figure 4-11] Drift characteristics of dark video output (12-bit output, typical example)

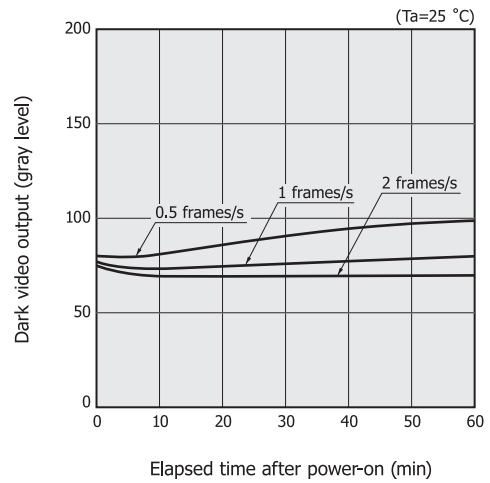

KACCB0065EA

Noise and dynamic range

Flat panel sensors were developed based on CMOS image sensors. CMOS image sensors transfer charges accumulated in the photodiodes to the readout circuit through the video line. In the passive pixel type CMOS image sensors, noise is expressed by equation (4). The video line parasitic capacitance (C_d) is very large compared to the photodiode junction capacitance (C_p) and charge amplifier feedback capacitance (C_f), so the video line parasitic capacitance becomes a dominant source of noise.

$$V_{tot}^2(rms) = \frac{8}{3} k T \frac{1}{gm} \left(\frac{C_t}{C_f}\right)^2 \beta_1 + \frac{K_f}{Cox^2 W L} \left(\frac{C_t}{C_f}\right)^2 \beta_2 \dots\dots(3)$$

$$V_{tot}(rms) = \frac{C_t}{C_f} \sqrt{\frac{8}{3} k T \frac{1}{gm} \beta_1 + \frac{K_f}{Cox^2 W L} \beta_2} \dots\dots\dots(4)$$

$$C_t = C_p + C_f + C_d \dots\dots\dots(5)$$

- Vtot : total noise voltage
- T : absolute temperature [K]
- gm : transconductance of charge amplifier first-stage transistor
- β_1, β_2 : constants determined by charge amplifier
- Kf : 1/f noise constant of charge amplifier first-stage transistor
- Cox : gate oxide film capacitance of charge amplifier first-stage transistor
- W : W length of charge amplifier first-stage transistor
- L : L length of charge amplifier first-stage transistor

The noise level of passive pixel type CMOS image sensors depends on the pixel size and the number of pixels, and ranges from 800 to 2500 e^- rms.

The lower limit of flat panel sensor dynamic range is determined by noise and the upper limit by the saturation charge. This means that the dynamic range is derived from the ratio of saturation charge to noise.

In the active pixel type, the video line parasitic capacitance is extremely low, so the noise is small.

Resolution

Resolution is a degree of detail to which image sensors can reproduce an input pattern in the output. The active area of a flat panel sensor consists of a number of regularly arrayed photodiodes, so the input pattern is output while being separated into pixels. Therefore as shown in Figure 4-12, when a square wave pattern of alternating black and white lines with different intervals is input, the difference between black and white level outputs becomes smaller as the pulse width of the input pattern becomes narrower. A contrast transfer function (CTF) is used to express this relation and is given by equation (6).

$$CTF = \frac{V_{WO} - V_{BO}}{V_W - V_B} \times 100 [\%] \dots \dots \dots (6)$$

- V_{WO} : output white level
- V_{BO} : output black level
- V_W : output white level (when input pattern pulse width is wide)
- V_B : output black level (when input pattern pulse width is wide)

[Figure 4-12] Contrast transfer function characteristics

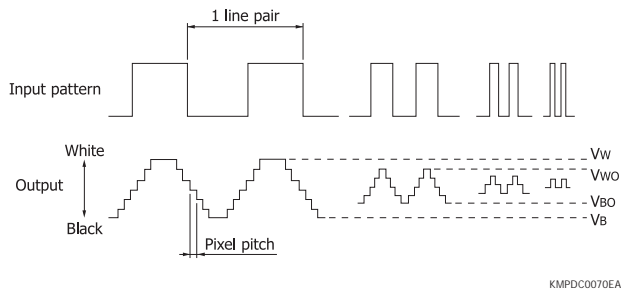

The fineness of the black and white lines on the input pattern is given by the spatial frequency of the input pattern. The spatial frequency is the number of black and white line pairs per unit length. In Figure 4-12, the spatial frequency corresponds to the reciprocal of the distance from one white edge to the next white edge in the pattern. It is usually represented in units of line pairs/mm. The finer the input pattern or the higher the spatial frequency, the lower the CTF will be.

[Figure 4-13] Contrast transfer function vs. spatial frequency [pixel size: 50 × 50 μm, CsI(Tl) direct deposition, typical example]

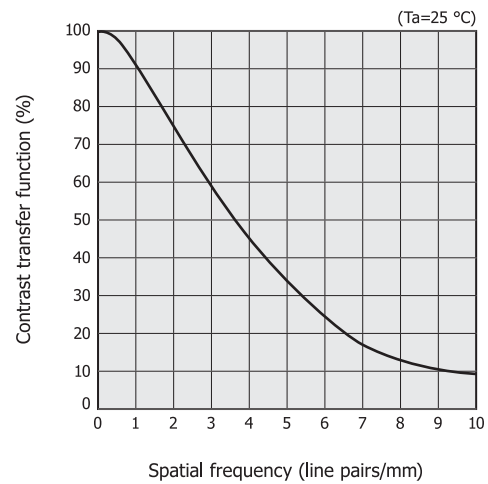

KACCB0193EA

The resolution and sensitivity of flat panel sensors to X-rays depend on the scintillator thickness. Both are in a trade-off relation. Our flat panel sensors are designed for optimal scintillator thickness by taking the application and pixel size into account to deliver high resolution and high sensitivity.

Reliability

In ordinary X-ray detectors, deterioration in performance such as a drop in sensitivity and an increase in dark video output occurs due to X-ray irradiation. Likewise, flat panel sensor characteristics deteriorate due to X-ray irradiation. For example, an FSP type flat panel sensor with an aluminum top cover intended for non-destructive inspection is designed for use at an X-ray energy from 20 kVp to 100 kVp, and can be used up to an accumulated irradiation dose of one million roentgens if used under 100 kVp X-ray energy. When the active area is uniformly irradiated with X-rays, the dark current also increases almost uniformly over the active area. The dark current might partially increase in the active area, but this can be eliminated by dark image correction. When the partial increase in dark video output caused by increased dark current has exceeded the dark image correction limit, the flat panel sensor should be replaced as a consumable part. The life of flat panel sensors can be extended by setting the X-ray dose to a lower level within the detectable range and by preventing X-rays from irradiating the flat panel sensor except during imaging. Another effective way to extend the detector life is to use pulsed X-rays.

A top cover for flat panel sensors not only reduces physical damage but also functions as a soft X-ray filter. A 1-mm thick aluminum cover can shut off soft X-rays and so is effective in extending the flat panel sensor service life.

We also provide flat panel sensors with a top cover using a carbon plate over the active area. These are designed for use

with soft X-rays. Our flat panel sensors also include a type suited for use with 17 keV X-ray energy from a molybdenum target X-ray source. It is noted that this type cannot be used for acquiring images using other X-ray sources or X-rays with energy exceeding 17 keV.

[Figure 4-14] Sensitivity and dark video output vs. irradiation dose

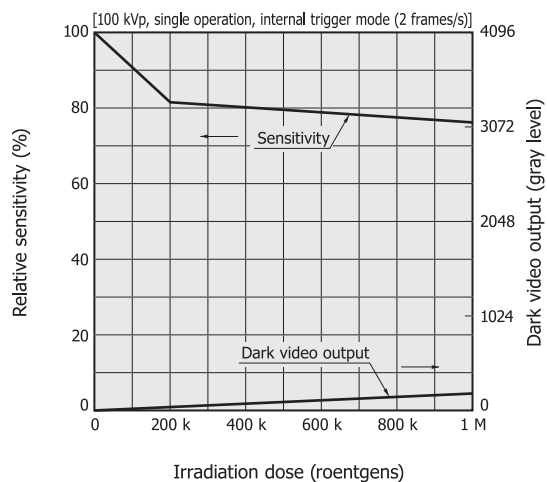

KACCB0066EA

4-5 How to use

Connection method

Setup is simple. All that is needed is to connect the flat panel sensor to a PC and power supply using the data cable and power cable (some models require an external trigger input cable). Then supplying the voltage to the flat panel sensor will start real-time X-ray image acquisition from the PC control. Figure 4-15 shows a connection example of an X-ray imaging system using a flat panel sensor.

[Figure 4-15] Connection example (C9252DK-14)

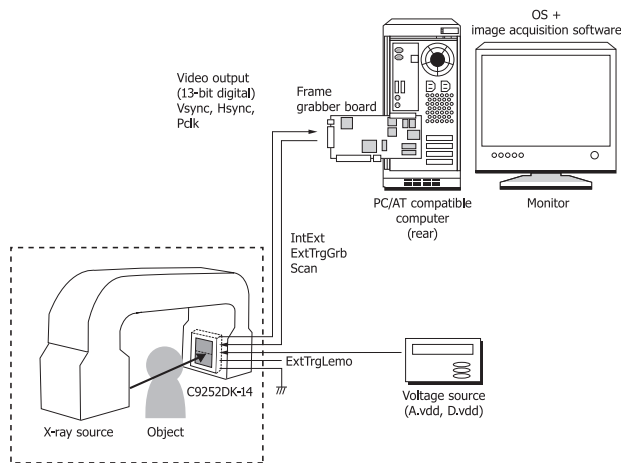

KACCC0382EC

Trigger mode

Flat panel sensors have two trigger modes (internal trigger mode and external trigger mode).

In internal trigger mode, the sensor always operates at the maximum frame rate and constantly outputs the sync signals and video signal.

The external trigger mode, on the other hand, is used when synchronizing a flat panel sensor with a pulsed X-ray source or extending the integration time to increase the output per frame. In external trigger mode, data output starts by input of an external trigger. The external trigger period is the reciprocal of the frame rate and serves as the integration time. Extending the external trigger interval can lower the frame rate down to the minimum frame rate specified for each product. Note that in external trigger mode, the image data output by the first external trigger is not valid because that data was not obtained in the defined integration time. The second and subsequent image data are valid since they are in the defined integration time.

The external trigger input signal is usually input via the I/O pins on the frame grabber board. HAMAMATSU flat panel sensors are equipped with a LEMO connector for external triggers. The external trigger is the logical product of the input from the frame grabber board I/O pin and the input from the LEMO connector. So the pin not used for input of external trigger signal should be fixed at high level or left unconnected.

Defect lines

Charges accumulated in the photodiodes are transferred to the readout circuit through the data line by turning on the CMOS switch for each pixel using the gate line from the shift register. An open-circuit fault occurring in the gate line or data line will make it impossible to read out some pixels. These continuous pixels are called the defect line. Although defect lines are inevitable in image sensors with a large active area, correcting them by software based on values of the surrounding pixels makes it possible to eventually acquire images with no defects. Charges leaking out of a defect line might increase the output of the pixels adjacent to the defect line. This phenomenon can also be corrected by software.

Correction

Flat panel sensors utilizing the latest CMOS process technology and CDS circuits can acquire images with very high uniformity, yet they also offer an even higher level of image quality by software correction. Those correction procedures are described below.

(1) Dark image correction

Image(d) as the dark image is the sum of the “offset output”

and “integration time-dependent photodiode dark current.” Image(x) [Figure 4-16], which is an X-ray image acquired by a flat panel sensor, contains the output component of this dark image, so Image(d) is then subtracted from Image(x) to acquire an image with the dark image subtracted, which is Image(c1). A higher quality image can be achieved by taking the average of the dark images from multiple frames.

$$\text{Image}(c1) = \text{Image}(x) - \text{Image}(d) \dots\dots\dots (7)$$

The dark image also depends on the operating temperature. So before acquiring an X-ray image, the dark image should be captured after the sensor temperature has stabilized.

[Figure 4-16] Image examples from dark correction

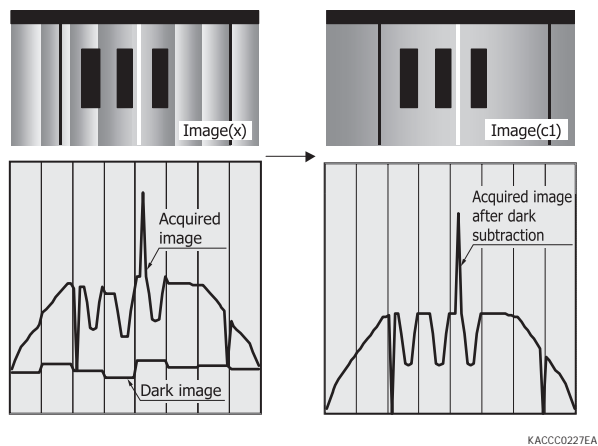

(2) Light field correction

Light field correction compensates for slight variations in sensitivity over the effective active area and for non-uniformities of the X-ray source.

Image(d) acquired as the dark image is first of all subtracted from Image(f) which is an X-ray image [Figure 4-17] taken in a state with no target object in order to obtain a “light field” image. The X-ray tube voltage should at this point be set at the value for actually acquiring images. The tube current should be adjusted so that the output level of Image(f) is nearly equal to the output level of the portion of interest in Image(x). Image(f) with higher image quality can be obtained by taking the average of multiple frames.

Next, Image(c1) obtained in “(1) Dark image correction” is divided by the light field image “Image(f) - Image(d)” for each pixel, and then multiplied by a constant (const1) which is approximately the average video output of all pixels in the light field image to obtain Image(c2) after light field correction.

$$\text{Image}(c2) = \frac{\text{Image}(c1)}{\text{Image}(f) - \text{Image}(d)} \times \text{const1} \dots\dots\dots (8)$$

const1: constant nearly equal to the average video output of all pixels in light field image “Image(f) - Image(d)”

[Figure 4-17] Image examples from light field correction

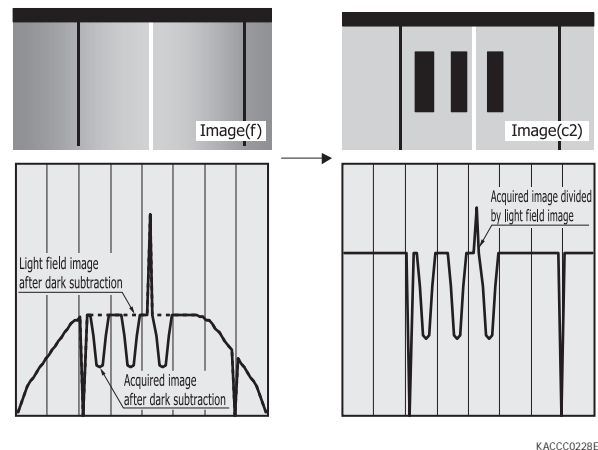

(3) Defect line correction

The following example shows the method for correcting a defect line (Vp) by using the pixels (Vp-1, Vp+1) on both sides of the defect line.

$$V_p = \frac{V_{p-1} + V_{p+1}}{2} \dots\dots\dots (9)$$

Images used for this correction must be acquired at the same integration time. There are several other methods for correcting defect lines.

A final image, Image(c3) is obtained after performing dark correction, light field correction, and defect line correction, as shown in Figure 4-18.

[Figure 4-18] Image example after performing dark correction, light field correction, and defect line correction

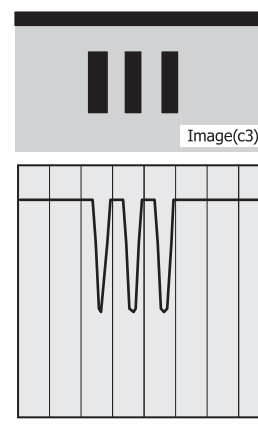

KACCC0229EB

▣ Precautions

Flat panel sensors deteriorate due to X-ray irradiation. After long term use or after use under large radiation doses, the sensor sensitivity decreases and the dark video output increases. Coping with this deterioration requires correcting the image by software to meet the desired detection accuracy, as well as periodically replacing the flat panel sensor as a consumable part.

5. Applications

5-1 X-ray CT scanners

In the measurement unit (rotary unit) of an X-ray CT scanner, the X-ray irradiator and the detector unit face each other as shown in Figure 5-1. The detector unit detects the X-rays that passed through the human body. Detection is performed while the “X-ray irradiator and detector unit” arranged facing each other are rotating 360 degrees. The Si photodiodes used in the detector unit are each coupled to a scintillator that emits light when irradiated with X-rays. The intensity levels of the X-rays passing through the human body are converted by the scintillators into light emission levels, and the detector unit then detects the light levels.

A large number of photodiodes are arrayed along the rotation direction, so the characteristic variations among individual photodiodes must be held to a minimum. Arranging a large number of photodiodes requires high positioning accuracy, so the photodiode chip mounting and the package dimensions must be highly precise.

Recent advances in X-ray CT scanners allow multi-slice where many tomograms can be obtained with just one rotation by the rotary unit. The detector unit comes to require more than several hundred channels of active areas in a two-dimensional format (matrix). HAMAMATSU high-performance photodiode arrays and CSP photodiode arrays capable of tiling for large area are widely used in multi-slice X-ray scanners.

[Figure 5-1] Cross section view of X-ray CT scanner

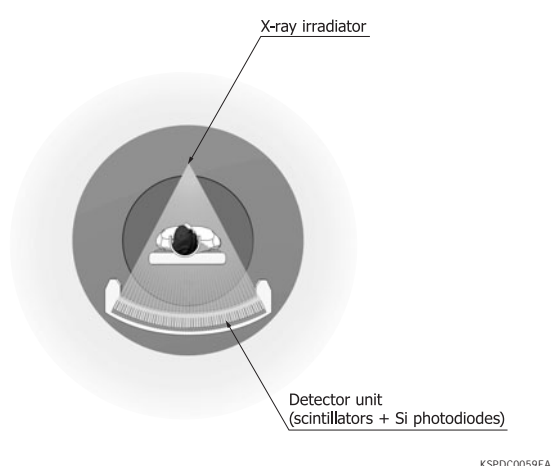

KSPDC0059EA

5-2 Baggage inspection equipment

HAMAMATSU Si photodiodes have sensitivity that matches the wavelengths of scintillator emissions, and feature low noise and small variation in characteristics including sensitivity. The sensor chip is mounted with high accuracy. These facts explain why our Si photodiodes are widely used in the detector units in

baggage inspection equipment.

The internal shapes and materials can be identified by processing the image of X-rays passing through the object. Baggage inspection equipment at locations like airports has to have high resolution and high reliability. Current methods use a sensor containing scintillators attached to Si photodiodes, in which the X-rays passing through the object are converted into visible light and then converted to electrical signals. CT-based baggage inspection equipment has been in the market, and the accuracy is getting higher and higher.

5-3 Dental imaging

HAMAMATSU X-ray CCD/CMOS area image sensors are mainly used for acquiring digital X-ray images in dental examinations. CCD/CMOS area image sensors offer the following advantages compared to methods that capture images on film.

- Low X-ray exposure (1/5 to 1/10 that of film)
- No developing process required
- Real-time display of diagnosis image. No need to dispose of developing fluid waste.
- Adjustable image contrast and enlarged display
- Diagnosis image databases are easy to make.

The following three types of imaging techniques are used in dental diagnosis.

▶ Intraoral imaging

Detailed diagnostic images of two to three teeth can be obtained by inserting a CCD or CMOS area image sensor for intraoral imaging and non-destructive inspection into the patient's mouth.

[Figure 5-2] Example of intraoral imaging

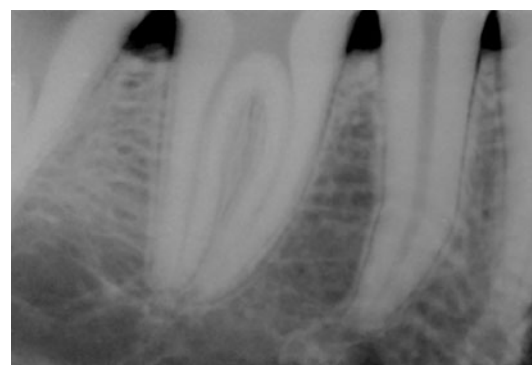

As CCD area image sensors for intraoral imaging and non-destructive inspection, HAMAMATSU provides CCD modules that use a relatively large area CCD of 1500 (H) × 1000 (V) pixels or 1700 (H) × 1200 (V) pixels, both with a pixel size of 20 × 20 μm and coupled to an FOS. The scintillator uses CsI

that achieves a high resolution of 15 to 20 line pairs/mm. Coupling the FOS to the CCD gives high durability against X-ray exposure. For example, these modules can operate up to 100000 times or more under X-ray irradiation of approx. 30 mR at 60 kVp. Besides this feature, the sensor unit of these CCD modules is thin and compact, allowing X-ray imaging even in a narrow section.

Capturing X-ray images requires synchronizing the X-ray irradiation time with the CCD integration time. For this purpose, a monitor photodiode is formed on the same plane of the CCD in order to trigger X-ray irradiation. Besides generally used AC type X-ray sources of 50 Hz or 60 Hz, this photodiode can also monitor irradiation from DC type X-ray sources.

[Figure 5-3] Contrast transfer function vs. spatial frequency (S8981)

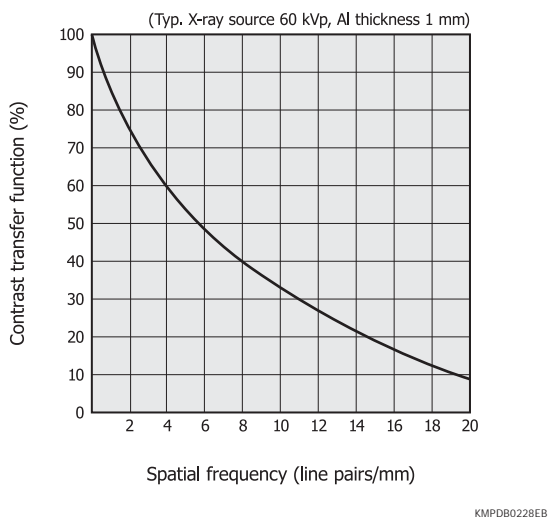

► Panoramic imaging

Panoramic X-ray imaging devices capture images by using the X-ray source and detector unit designed to rotate around the patient's head. A TDI-CCD allows capturing panoramic diagnostic images that are much longer than the sensor length.

[Figure 5-4] Example of panoramic imaging

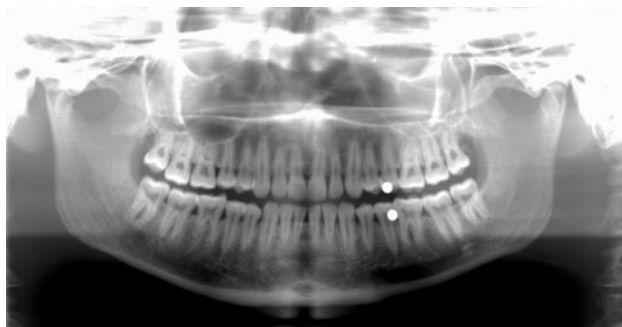

► Cephalo imaging

Cephalo X-ray imaging devices capture images of the head. These devices use TDI-CCDs for acquiring diagnostic images like panoramic imaging.

[Figure 5-5] Example of cephalo imaging



5 - 4 Non-destructive inspection (for industry)

This performs one-shot X-ray imaging like CCD or CMOS area image sensors used for intraoral imaging, and inspects objects moving on a conveyor belt like TDI-CCD for panoramic/cephalo imaging.

[Figure 5-6] Example of printed circuit board imaging

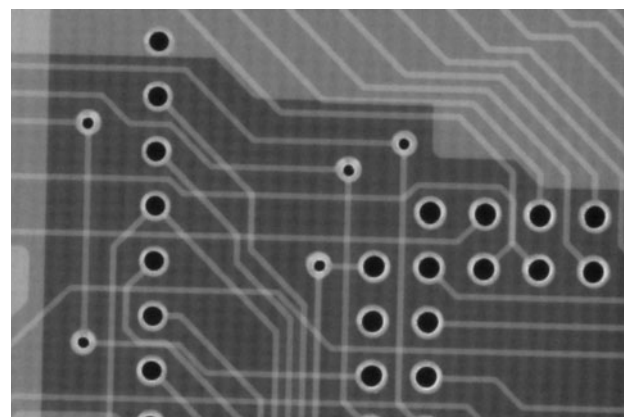

5 - 5 Measurement of X-ray charge cloud shape

The shape of a charge cloud formed by monochromatic X-rays in silicon can be found in a mesh experiment using a front-illuminated CCD of $12 \times 12 \mu\text{m}$ pixel size [Figure 5-7]. This experiment has achieved a position resolution even smaller than the CCD pixel size, and are likely to be promising methods for acquiring ultra-high accuracy X-ray images utilizing low-noise characteristics of the CCD.

[Figure 5-7] X-ray charge cloud shape

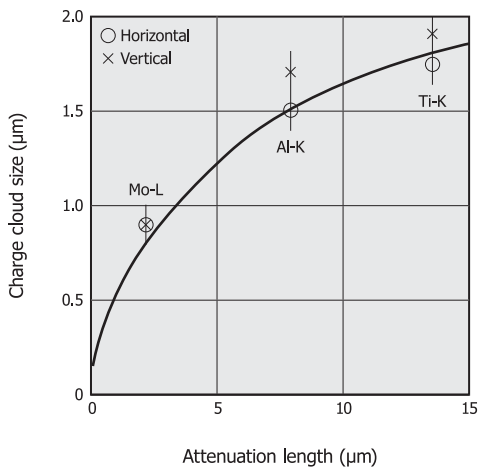

KMPDB0225EA

5-6 X-ray imaging using pulsed X-ray source

In most X-ray imaging using a continuous X-ray source, there is no need to synchronize the detector with the X-ray source during use. However, when using a pulsed X-ray source that emits a high radiation dose in a short time compared to continuous X-ray sources, the detector must be synchronized with the emission timing of the X-ray source to acquire an image.

If using a flat panel sensor with a pulsed X-ray source, then setting the flat panel sensor to external trigger mode will be convenient. In external trigger mode, inputting an external trigger signal to the flat panel sensor allows reading out the charges that have been kept accumulated in the photodiodes up until then. The charges are in this case continually accumulated until an external trigger signal is input. To acquire an image in synchronization with the pulsed X-ray source, the X-ray source must emit X-rays at the appropriate trigger intervals.

Figure 5-8 shows a timing chart for acquiring images with pulsed X-rays using an external trigger signal.

Here, an external trigger signal is input prior to pulsed X-ray emission, and starts readout of charges integrated in the photodiodes up until that time (①). Readout of the integrated charges ends after T_{prdy} from the rising edge of the external trigger signal (②), and the photodiodes are reset. Refer to the datasheet for information on other parameters.

$$T_{prdy} = T_{vd} + T_{vc} - T_{vdpw} \dots\dots\dots (10)$$

T_{vdpw} : T_{vd} period

Pulsed X-rays are emitted in the period between ② and ③ (rising edge of the next external trigger signal) on the timing chart. The next external trigger signal is input after the X-ray emission. The operation of ① to ③ then repeats.

[Figure 5-8] Timing chart

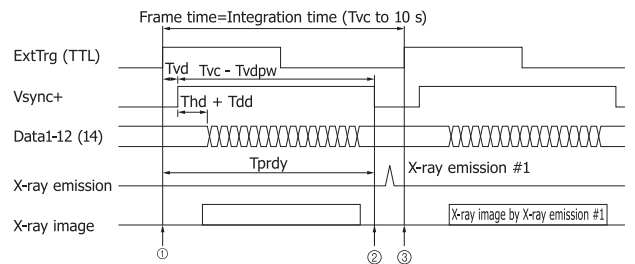

KACCC0460EA

5-7 Acquiring enlarged images of small objects

Flat panel sensors can acquire an enlarged image since they capture images with no distortion and have high resolution. The image magnification is expressed by equation (11).

$$\text{Magnification} = \frac{D_1}{D_2} \dots\dots\dots (11)$$

D_1 : distance between X-ray source focal point and flat panel sensor
 D_2 : distance between X-ray source focal point and object

If the distance between the flat panel sensor and X-ray source is fixed, then the magnification will increase as the object is brought closer to the X-ray source.

During enlargement, the image becomes fuzzier as the focal spot size of the X-ray source becomes larger. This means that using a microfocus X-ray source with a small focal spot size will yield sharp, clear images even when enlarged.

[Figure 5-9] Image distortion by X-ray source with different focal spot size

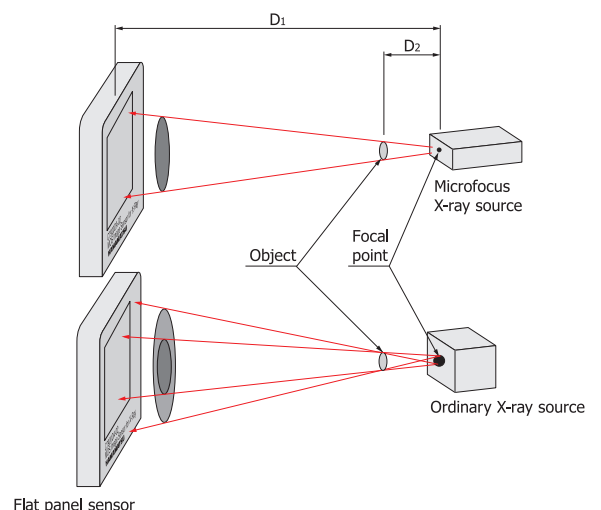

KACCC0245EB

5-8 Cone beam CT

As a method for making full use of the features of flat panel sensors with a large active area, there is a cone beam CT that uses a cone beam X-ray source capable of emitting X-rays over a wide area.

The cone beam X-ray source and the flat panel sensor are installed opposite each other with the object positioned in the center. Images of the object are then acquired while the X-ray source and flat panel sensor are rotated at the same speed around the object.

The two-dimensional image data acquired in this way is then reconstructed by a computer to create three-dimensional X-ray transmission images. The cone beam CT can also acquire three-dimensional X-ray images of large objects in a short time by using high-frame-rate flat panel sensors with a large active area.

[Figure 5-10] Concept image of cone beam CT

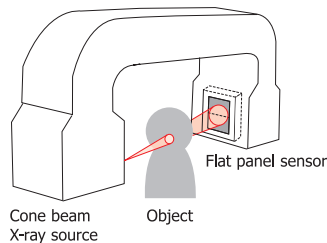

KACCC0461EA

5-9 X-ray diffraction

Flat panel sensors are useful for analysis of X-ray Laue method because of a large active area and high resolution. As shown in Figure 5-11, parallel X-rays irradiate the object, and interference fringes formed by the X-rays diffracted by the object are detected with the flat panel sensor. In this way high definition images equivalent to those obtained with an imaging plate can be obtained. The flat panel sensor will likely be used in the future for applications including structural analysis of crystals and proteins.

[Figure 5-11] Concept image of X-ray diffraction

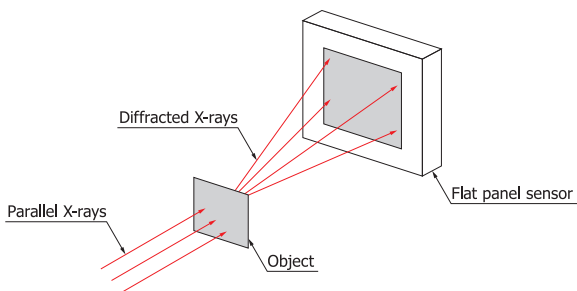

KACCC0462EA

[Figure 5-12] X-ray diffraction pattern example

