

Figure 1 - The Moxtek HPC150

Introduction

Moxtek HPC 150W 75kV X-ray tubes are designed to be used in XRF and imaging applications. The tube is designed to be air-cooled and the cooling can be adapted to meet specific needs. The push/pull fan configuration makes it easy to direct the warm air outward. For XRF applications the cone is designed for a vacuum seal at its base. The HPC tube incorporates radiation shielding.

Table of Contents

• Introduction	1
• X-ray Source Characteristics	2
• Tube Current and Power Operational Range	2
• Initial Inspection	2
• Handling	2
• Mechanical	3
• Tube Setup and Operating Instructions	4
• Operating Precautions - Warnings	7

X-ray Source Characteristics

Mechanical Specifications		X-ray Tube Characteristics	
Tube Type:	Metal-ceramic	HV Polarity:	Grounded anode
Operating Temp:	+10° C to +50° C*	High Voltage:	10kV to 60kV
Storage Temp:	-20° C to +60° C	Max Beam Current:	5mA (long life performance)
Cooling:	Filtered Air (three fin options*)	Maximum Power:	150 Watts
Weight:	2.5kg* (w/o cable)	Window:	Beryllium
Available Targets:	Tungsten, Molybdenum		
Fan Operating Voltage:	12V or 24V*		
Connector Type:	CA-11 typical (75kV max)		

*Fin and fan configurations can be optimized for the system and application

Tube Current and Power Operational Range



Figure 2 - Voltage vs. Current and Power

Initial Inspection

When a Mox HPC tube is received, it should be unpacked and inspected as soon as possible. **Caution: Do not lift or carry the tube by the high voltage cable.** Inspect the tube assembly for any damage. The Beryllium should not have any cracks or holes. The copper heat sinks should be tightly joined (See Figure 3). The fans should be free of chips or cracks and have the wires properly attached. Inspect the high voltage cable for proper tight and solid strain relief at the base of the tube. In the unlikely event that a tube has been damaged during shipping, note the damage and contact MOXTEK immediately. The serial number is

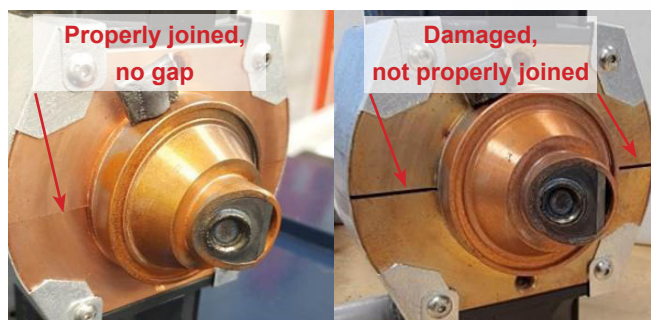

Figure 3 - Heat sinks joint inspection

Handling

Care should be taken when handling the tube. Do not drop or strike the tube on any surface. Care must be taken to not damage the beryllium window or high voltage cable. Support the weight of the tube when lifting or carrying.

Caution: Do not lift or carry the tube by the high voltage cable.

Mechanical

Cooling

The MoxHPC utilizes a fan and heat sink for a combination of forced-air convection and conduction cooling. The tube should be operated in an environment that allows convection and conduction to secondary parts. Place the tube in shielded enclosure with adequate air flow, >50 cfm (1400 lpm) of ambient air at 50°C or cooler.

Mounting

The MoxHPC may be mounted by the two ANSI 1/4-20 UNC threaded holes on the tube end of the heat sinks. Alternately, M5 or #10 bolts can be used in the thru-holes to capture the assembly.

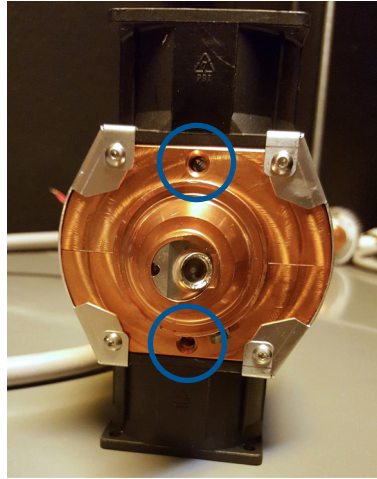
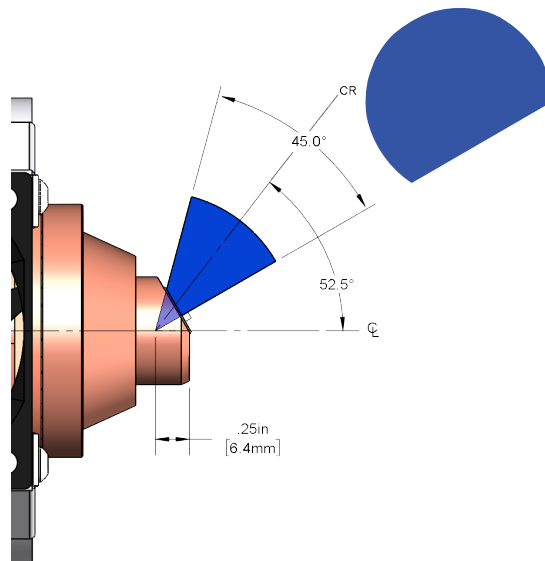

Figure 4 - MoxHPC threaded hole mounts

Cone Beam Configuration



DESCRIPTION	ANGLE
Cone Angle	45°
Center Line to Central Ray Angle	52.5°

Figure 5 - Cone Beam Configuration

Tube Setup and Operating Instructions

1. Ensure that the fans are unobstructed for 3 inches. Keep any loose objects away from the inlet and outlet fans. Use caution with tools and fingers in proximity to the fans to prevent damage to the fans or injuries to personnel.

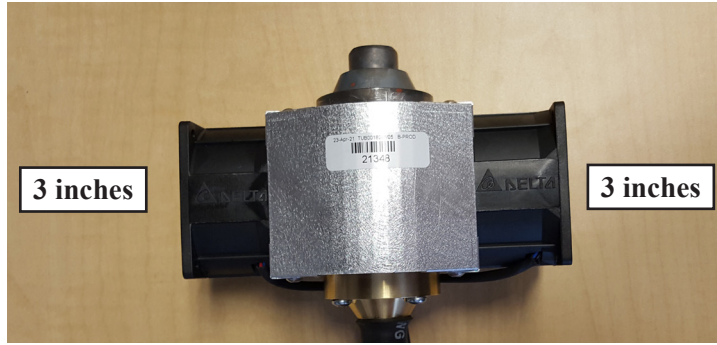
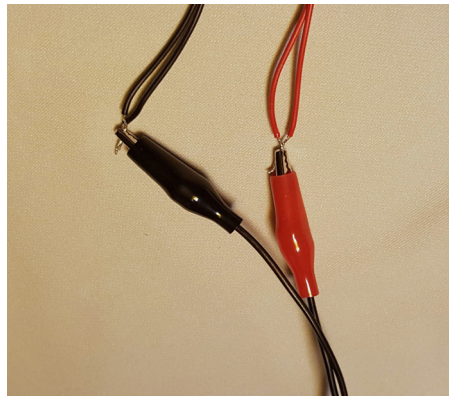

Figure 6 - MoxHPC fans

2. Confirm that the fan voltage matches the power supply (See Figure 7 for voltage call-out location). Connect the fans to the power supply by connecting the red lead to the positive (+) and black lead to the negative (-) terminals on the power supply. The power supply should provide the correct power (watts) for two fans. **Caution: Reversing these leads will damage the fans.**



Fan with voltage call-out



Red and black leads

Figure 7

3. The blue leads are for tachometer readings. It is recommended that the fans be interlocked to the high voltage power supply to prevent accidental operation of the tube when the fans are not operating. See figure 8 below for the circuit needed for the use of tachometer.

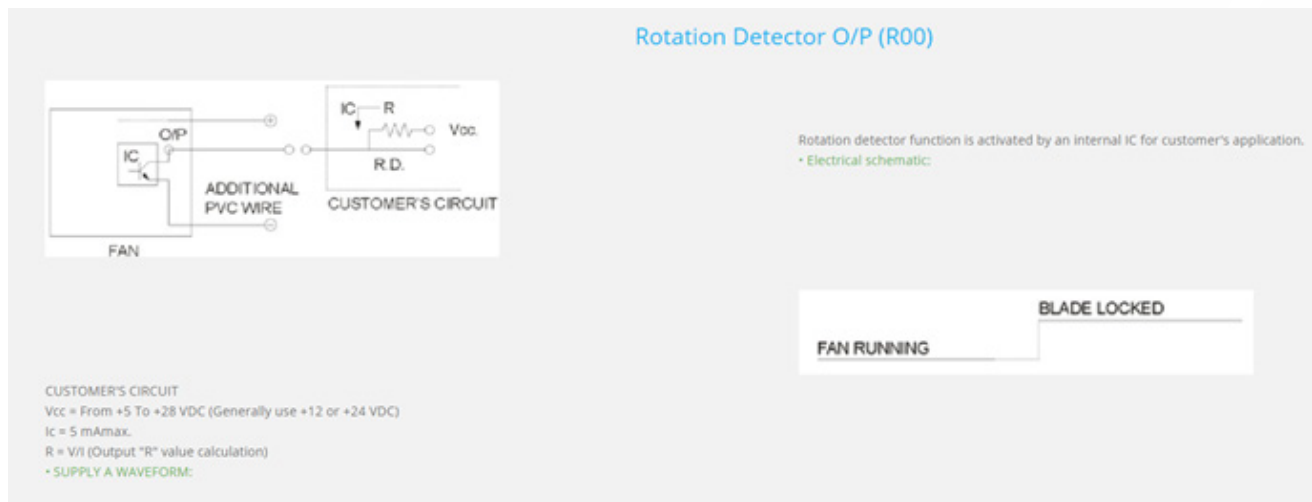

Figure 8 - Circuit needed for tachometer

4. Install the cable collar onto the tube cable if it is not installed already.



Figure 9 - Cable collar

5. Clean the cable connector with a lint free wipe.



Figure 10 - Cleaning the cable connector

6. Apply a small amount of silicone oil and spread it around the connector.

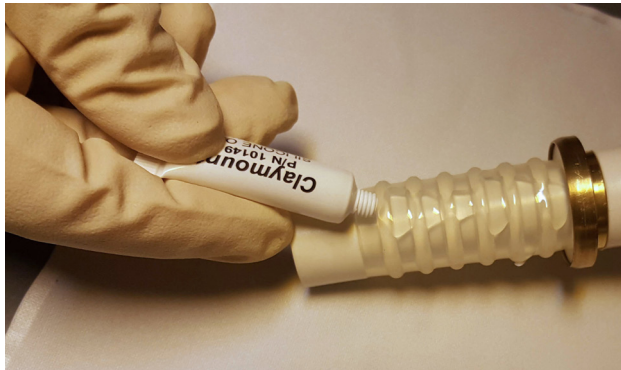

Figure 11 - Applying silicone oil

7. Line up the key notches and insert the connector into the receptacle. The connector may need to be rotated slightly to line up with the key notches. **Caution: Ensure safety interlocks are in place prior to connecting the tube to the generator.**

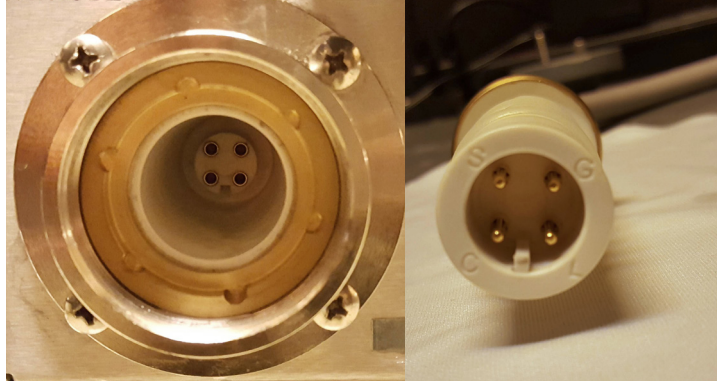

Figure 12 - Left: Power supply receptacle Right: Tube connector

8. Close the enclosure and all interlocks.

9. Turn on the filament to verify that the cable was properly connected. This can be done by turning the filament current to 0.5A **Caution: Do not exceed the beam current limits or the maximum power levels as outlined in the product datasheet for the best tube life.**

10. With the filament current confirmed, the high voltage can be applied in 10kV steps. Start at 20kV and step up to the full operating voltage of 60kV. Once the tube is stable at 60kV, the tube voltage can be raised directly to 60kV and full operational power; steps are not required after initial power up.





11. Power may now be applied to the tube by increasing the beam current. It is recommended that this be done in 0.2 mA steps the first time the tube is operated. The maximum power allowed is 150 watts and voltages up to 60kV, within the provided power and voltage combinations. **Caution: Do not exceed 150 watts of tube power at any voltage level.**

12. The tube power levels are dependent on voltage. The tube should be operated according to the operational chart in figure 2. **Caution: Short term inputs of more than 150 watts are not allowed. This will cause permanent damage to the window.**

13. It is permissible to attach thermocouples to the exterior of the tube to monitor the temperatures of the various surfaces. Kapton tape works well to attach thermocouples without damaging the tube or cooling assembly. Do not attach thermocouples to the beryllium window as this may damage the window. Please contact Moxtek for specific recommendations regarding the placement of thermocouples.

NOTE: The filament monitor current of Spellman power supplies have been shown to have significant variation. If you find that the desired beam current cannot be attained, please contact Moxtek for guidance on using increased current limits. The X-ray tube may be permanently damaged in only a few seconds if the filament is run at excessive current levels.

Operating Precautions-Warnings

- Caution**  Verify that the tube and the high voltage power supply are properly grounded before powering the tube on.
- Caution**  **MoxHPC tubes contain beryllium. Inhaling Beryllium dust may cause lung disease – refer to the MSDS. Under normal use, Beryllium dust is not generated. If the Beryllium target is broken, a very small amount of dust might be generated. If this occurs follow the instructions on the MSDS for cleanup.**
- Warning**  **MoxHPC X-ray tubes may become very hot during operation.**
- Warning**  **MoxHPC X-ray tubes produce x-ray radiation. HPC tubes are shielded with a metal shield and high-Z potting materials. Extra shielding may be required depending on the application. ONLY OPERATE X-RAY TUBES IN PROPERLY SHIELDED ENCLOSURES. It is the responsibility of the operator to ensure that all applicable safety precautions are taken and observed.**
- Warning**  **MoxHPC X-ray tubes operate at high voltages Refer to the cable preparation instructions on page 4. Precautions should be taken to protect the operator while applying high voltages to avoid serious injury or death.**



452 West 1260 North / Orem, UT 84057
Phone 801.225.0930 / Fax 801.221.1121
www.moxtek.com
info@moxtek.com

For warranty and ordering information, please visit www.moxtek.com.

TUB-MAN-1020 Rev C
Subject to technical change without notice