

Series 275

Mini-Convectron[®] Vacuum Gauge Module with Nonlinear Analog Outputs and Process Control Relays



Instruction Manual

Instruction manual part number 275512

Revision E- July 2017

Mini-Convectron® Vacuum Gauge Module with Nonlinear Analog Outputs and Process Control Relays

This Instruction Manual is for use with all Granville-Phillips Series 275 Mini-Convectron Vacuum Gauge Modules With Nonlinear Analog Outputs and Process Control Relays. A list of applicable catalog numbers is provided on the following page.



Customer Service / Technical Support:

MKS Pressure and Vacuum Measurement Solutions

MKS Instruments, Inc.
6450 Dry Creek Parkway
Longmont, Colorado 80503 USA
Tel: 303-652-4400
Fax: 303-652-2844
Email: mks@mksinst.com

MKS Corporate Headquarters

MKS Instruments, Inc.
2 Tech Drive, Suite 201
Andover, MA 01810 USA
Tel: 978-645-5500
Fax: 978-557-5100
Email: mks@mksinst.com

Catalog numbers for Series 275 Mini-Convectron Modules

With electrical connector. Operating power: 11.5 Vdc to 26.5 Vdc

Mini-Convectron Module with one (1) setpoint relay

1/8 NPT / 1/2 inch tubulation	275800-EU
1/4 inch VCR-type female fitting	275801-EU
1/2 inch VCR-type female fitting	275863-EU
3/8 inch VCO-type male fitting	275802-EU
1.33 inch (NW16CF) ConFlat-type flange	275803-EU
2.75 inch (NW35CF) ConFlat-type flange	275804-EU
NW10KF flange	275805-EU
NW16KF flange	275806-EU
NW25KF flange	275807-EU
NW40KF flange	275808-EU
NW50KF flange	275809-EU

Mini-Convectron Module with two (2) setpoint relays

1/8 NPT / 1/2 inch tubulation	275870-EU
1/4 inch VCR-type female fitting	275871-EU
1/2 inch VCR-type female fitting	275867-EU
3/8 inch VCO-type male fitting	275872-EU
1.33 inch (NW16CF) ConFlat-type flange	275873-EU
2.75 inch (NW35CF) ConFlat-type flange	275874-EU
NW10KF flange	275875-EU
NW16KF flange	275876-EU
NW25KF flange	275877-EU
NW40KF flange	275878-EU
NW50KF flange	275879-EU

Mini-Convectron Module with two (2) setpoint relays and 3-digit digital display

Display in Torr

1/8 NPT / 1/2 inch tubulation	275904-EU
1/4 inch VCR-type female fitting	275905-EU
1/2 inch VCR-type female fitting	275906-EU
3/8 inch VCO-type male fitting	275907-EU
1.33 inch (NW16CF) ConFlat-type flange	275908-EU
2.75 inch (NW35CF) ConFlat-type flange	275909-EU
NW10KF flange	275910-EU
NW16KF flange	275911-EU
NW25KF flange	275912-EU
NW40KF flange	275913-EU
NW50KF flange	275914-EU

(Continued on next page)

Catalog numbers (Continued)

Catalog numbers for Series 275 Mini-Convectron Modules

With electrical connector. Operating power: 11.5 Vdc to 26.5 Vdc

Mini-Convectron Module with two (2) setpoint relays and 3-digit digital display

Display in Pascal

1/8 NPT / 1/2 inch tubulation	275904-EU-P
1/4 inch VCR-type female fitting	275905-EU-P
1/2 inch VCR-type female fitting	275906-EU-P
3/8 inch VCO-type male fitting	275907-EU-P
1.33 inch (NW16CF) ConFlat-type flange	275908-EU-P
2.75 inch (NW35CF) ConFlat-type flange	275909-EU-P
NW10KF flange	275910-EU-P
NW16KF flange	275911-EU-P
NW25KF flange	275912-EU-P
NW40KF flange	275913-EU-P
NW50KF flange	275914-EU-P

Mini-Convectron Module with zero (0) setpoint relays and 3-digit digital display

Display in Torr

1/8 NPT / 1/2 inch tubulation	275915-EU
1/4 inch VCR-type female fitting	275916-EU
1.33 inch (NW16CF) ConFlat-type flange	275919-EU
2.75 inch (NW35CF) ConFlat-type flange	275920-EU
NW10KF flange	2759-21EU
NW16KF flange	275922-EU
NW25KF flange	275923-EU

Display in Pascal

1/8 NPT / 1/2 inch tubulation	275915-EU-P
1/4 inch VCR-type female fitting	275916-EU-P
1/2 inch VCR-type female fitting	275917-EU-P
3/8 inch VCO-type male fitting	275918-EU-P
1.33 inch (NW16CF) ConFlat-type flange	275919-EU-P
2.75 inch (NW35CF) ConFlat-type flange	275920-EU-P
NW10KF flange	275921-EU-P
NW16KF flange	275922-EU-P
NW25KF flange	275923-EU-P
NW40KF flange	275924-EU-P
NW50KF flange	275925-EU-P

Notes:

Table of Contents

Chapter 1	Before You Begin	9
	1.1 About These Instructions	9
	1.2 Customer Service	9
	1.3 Caution and Warning Statements	10
	1.4 System Grounding	11
	1.5 Implosion / Explosion	11
	1.6 Operation	12
	1.7 Reading and Following Instructions	12
Chapter 2	Installation	13
	2.1 Module Components	13
	2.2 Install Pressure Relief Devices	14
	2.3 Installation Procedure	15
	Step 1 Locate and orient the module	15
	Location of the Module	15
	Orient the Module	17
	Step 2 Attach the module to the vacuum chamber	18
	1/8 NPT pipe thread	18
	VCR type fitting	18
	KF flange	18
	ConFlat flange	18
	Step 3 Assemble and connect the wiring	19
	Connecting Cable	19
	Wiring Terminals	19
	Grounding	20
	Step 4 Configure the setpoint relays for the application	21
	Step 5 Calibrate the Convector gauge	21
	Atmospheric Pressure Calibration	21
	Vacuum Chamber Pressure Calibration	21
Chapter 3	Operation	23
	3.1 Preparing to Operate the Module	23
	3.2 Nonlinear Analog Output	28
	Commonly used Gases Other than N ₂ or Air	28
	Other Gases	28
	3.3 Setpoint Relays	39
	Preparing to Adjust Setpoint Relays	40
	Adjusting Setpoint Relays	41
	3.4 Reading Relay Status	44
	3.5 Calibrating Convector Gauge at Atmospheric Pressure	44
	3.6 Calibrating Convector Gauge at Vacuum Chamber Pressure	46
	3.7 Modules Operating at Low Pressure	46
	3.8 Factory Settings	47

Chapter 4	Maintenance	49
	4.1 Customer Service	49
	Damage Requiring Service	49
	4.2 Troubleshooting	50
	Precautions	50
	Symptoms, Causes, and Solutions	51
	4.3 Convectron Gauge Test	52
	4.4 Convectron Gauge Removal and Replacement	53
	Removing the Convectron Gauge	53
	Replacing the Convectron Gauge	53
Appendix A	Specifications	55
Appendix B	Theory of Operation	59
Index		61

1.1 About These Instructions

These instructions explain how to install, operate, and maintain the Granville-Phillips® Mini-Convectron® vacuum gauge module.

- *This chapter* explains caution and warning statements, which must be adhered to at all times; explains your responsibility for reading and following all instructions; defines the terms “module” and “Convectron gauge”; and tells you how to contact customer service.
- *Chapter 2* explains how to install the module.
- *Chapter 3* explains how to operate the module, which has two programmable setpoint relays.
- *Chapter 4* explains troubleshooting, Convectron gauge testing, removal and replacement, and module return procedures.
- *Appendix A* provides specifications for the module.
- *Appendix B* explains terminology and explains how the Convectron convection-enhanced Pirani heat-loss gauge measures pressure.

Table 1-1 Terms Describing the Mini-Convectron Module and Components

Term	Description
Module	The Mini-Convectron vacuum gauge module, which contains a Convectron convection-enhanced Pirani heat-loss pressure gauge.
Convectron gauge	The Convectron convection-enhanced Pirani heat-loss gauge, which measures pressure within the vacuum chamber

1.2 Customer Service

Customer Service / Technical Support:

If the product requires service, contact the MKS, Granville-Phillips Division Technical Support Department at 1-303-652-4400 or 1-800-776-6543 for troubleshooting help over the phone.

If the product must be returned to the factory for service, request a Return Material Authorization (RMA) from MKS, which can be completed at <https://www.mksinst.com/service/servicehome.aspx>. Do not return products without first obtaining an RMA. In most cases a hazardous materials disclosure form is required. The MKS Customer Service Representative will advise you if the hazardous materials document is required.

When returning products to Granville-Phillips, be sure to package the products to prevent shipping damage. Damaged returned products as a result of inadequate packaging is the Buyer's responsibility.

For Customer Service / Technical Support:

MKS Pressure and Vacuum Measurement Solutions

MKS Instruments, Inc.
6450 Dry Creek Parkway
Longmont, Colorado 80503 USA
Tel: 303-652-4400
Fax: 303-652-2844
Email: mks@mksinst.com

MKS Corporate Headquarters

MKS Instruments, Inc.
2 Tech Drive, Suite 201
Andover, MA 01810 USA
Tel: 978-645-5500
Fax: 978-557-5100
Email: mks@mksinst.com

1.3 Caution and Warning Statements

This manual contains caution and warning statements with which you *must* comply to prevent inaccurate measurement, property damage, or personal injury.

 **CAUTION**

Caution statements alert you to hazards or unsafe practices that could result in minor personal injury or property damage.

Each caution statement explains what you *must* do to prevent or avoid the potential result of the specified hazard or unsafe practice.

 **WARNING**

Warning statements alert you to hazards or unsafe practices that could result in severe property damage or personal injury due to electrical shock, fire, or explosion.

Each warning statement explains what you *must* do to prevent or avoid the potential result of the specified hazard or unsafe practice.

Caution and warning statements comply with American Institute of Standards Z535.1–2002 through Z535.5–2002, which set forth voluntary practices regarding the content and appearance of safety signs, symbols, and labels.

Each caution or warning statement explains:

- a. The specific hazard that you *must* prevent or unsafe practice that you *must* avoid,
- b. The potential result of your failure to prevent the specified hazard or avoid the unsafe practice, and
- c. What you *must* do to prevent the specified hazardous result.

1.4 System Grounding

Grounding, though simple, is very important! Be certain that ground circuits are correctly used on your ion gauge power supplies, gauges, and vacuum chambers, regardless of their manufacturer. Safe operation of vacuum equipment, including the Mini-Convectron Module, requires grounding of all exposed conductors of the gauges, the controller and the vacuum system. **LETHAL VOLTAGES** may be established under some operating conditions unless correct grounding is provided.

Ion producing equipment, such as ionization gauges, mass spectrometers, sputtering systems, etc., from many manufacturers may, under some conditions, provide sufficient electrical conduction via a plasma to couple a high voltage electrode potential to the vacuum chamber. If exposed conductive parts of the gauge, controller, and chamber are not properly grounded, they may attain a potential near that of the high voltage electrode during this coupling. Potential fatal electrical shock could then occur because of the high voltage between these exposed conductors and ground.

1.5 Implosion / Explosion

Danger of injury to personnel and damage to equipment exists on all vacuum systems that incorporate gas sources or involve processes capable of pressuring the system above the limits it can safely withstand.

For example, danger of explosion in a vacuum system exists during backfilling from pressurized gas cylinders because many vacuum devices such as ionization gauge tubes, glass windows, glass bell jars, etc., are not designed to be pressurized.

Do not attach cables to glass gauge pins while the gauge is under vacuum. Accidental bending of the pins may cause the glass to break and implode. Cables, once installed, should be secured to the system to provide strain relief for the gauge tube pins.

Install suitable devices that will limit the pressure from external gas sources to the level that the vacuum system can safely withstand. In addition, install suitable pressure relief valves or rupture disks that will release pressure at a level considerably below that pressure which the system can safely withstand.

Suppliers of pressure relief valves and pressure relief disks are listed in Thomas Register under "Valves, Relief", and "Discs, Rupture".

Confirm that these safety devices are properly installed before installing the the Mini-Convectron Module. In addition, check that (1) the proper gas

cylinders are installed, (2) gas cylinder valve positions are correct on manual systems, and (3) the automation is correct on automated systems.

1.6 Operation

It is the installer's responsibility to ensure that the automatic signals provided by the process control module are always used in a safe manner. Carefully check manual operation of the system and the setpoint programming before switching to automatic operation. Where an equipment malfunction could cause a hazardous situation, always provide for fail-safe operation. As an example, in an automatic backfill operation where a malfunction might cause high internal pressures, provide an appropriate pressure relief device.

1.7 Reading and Following Instructions

You must comply with all instructions while you are installing, operating, or maintaining the module. Failure to comply with the instructions violates standards of design, manufacture, and intended use of the module. MKS Instruments, Inc. disclaims all liability for the customer's failure to comply with the instructions.

- *Read instructions* – Read all instructions before installing or operating the product.
- *Follow instructions* – Follow all installation, operating and maintenance instructions.
- *Retain instructions* – Retain the instructions for future reference.
- *Heed warnings and cautions* – Adhere to all warnings and caution statements on the product and in these instructions.

Parts and accessories – Install only those replacement parts and accessories that are recommended by MKS. Substitution of parts is hazardous.

2.1 Module Components

The Mini-Convectron module contains a Convectron convection-enhanced Pirani heat-loss gauge.

WARNING

Using the module to measure the pressure of flammable or explosive gases can cause a fire or explosion resulting in severe property damage or personal injury.

Do not use the module to measure the pressure of flammable or explosive gases.

The module is shipped with an instrument screwdriver and a 15-pin female, high-density subminiature D connector that mates to the male connector on the module.

Figure 2-1 illustrates the module without the digital display. The module without the display may have one setpoint relay or two setpoint relays.

Figure 2-2 illustrates the module with the 3-digit digital display. The module with the display has two setpoint relays.

Figure 2-1 Mini-Convectron Module without Digital Display



Mini-Convectron module with one setpoint relay, no display



Mini-Convectron module with two setpoint relays, no display

Figure 2-2 Mini-Convectron Module with two Setpoint Relays and 3-Digit Digital Display



2.2 Install Pressure Relief Devices

Before you install the module, install appropriate pressure relief devices in the vacuum system.

Granville-Phillips does not supply pressure relief valves or rupture disks. Suppliers of pressure relief valves and rupture disks are listed in the *Thomas Register* under “Valves, Relief” and “Discs, Rupture.”

CAUTION

Operating the module above 1000 Torr (1333 mbar, 133 kPa) true pressure could cause pressure measurement error or product failure.

To avoid measurement error or product failure due to overpressurization, install pressure relief valves or rupture disks in the system if pressure exceeds 1000 Torr (1333 mbar, 133 kPa).

2.3 Installation Procedure

The module installation procedure includes the following steps:

1. Locating and orienting the module.
2. Attaching the module vacuum chamber fitting to its mate on the vacuum chamber.
3. Assembling and connecting module wiring.
4. Configuring the setpoint relays to the desired voltage levels.
5. Calibrating the Convectron gauge at atmospheric and vacuum pressures.



WARNING

Failure to use accurate pressure conversion data for N₂ or air to other gases can cause an explosion due to over-pressurization.

If the module will measure any gas other than N₂ or air, before putting the module into operation, adjust setpoint relays for the process gas that will be used.

Step 1 *Locate and orient the module*

To locate and orient the module, refer to Figure 2-3, Figure 2-4, and Table 2-1, and follow the instructions below.

Location of the Module

- For greatest accuracy and repeatability, locate the module in a stable, room-temperature environment. Ambient temperature should never exceed 40 °C (104 °F) operating, non-condensing, or 85 °C (185 °F) non-operating.
- Locate the module away from internal and external heat sources and in an area where ambient temperature remains reasonably constant.
- Do not locate the module where it requires long lengths of tubing or has constricted tubing. Length of tubing depends on the application. Longer tubing will affect vacuum pressure limit and response time.
- Do not locate the module near the pump, where gauge pressure might be lower than normal vacuum chamber pressure.
- Do not locate the module near a gas inlet or other source of contamination, where inflow of gas or particulates causes atmospheric pressure to be higher than system atmosphere.
- Do not locate the module where it will be exposed to corrosive gases such as mercury vapor or fluorine.
- Do not locate the module where it will vibrate. Vibration causes convection cooling, resulting in inaccurate high pressure readings.

Figure 2-3 Mini-Convectron Module Dimensions

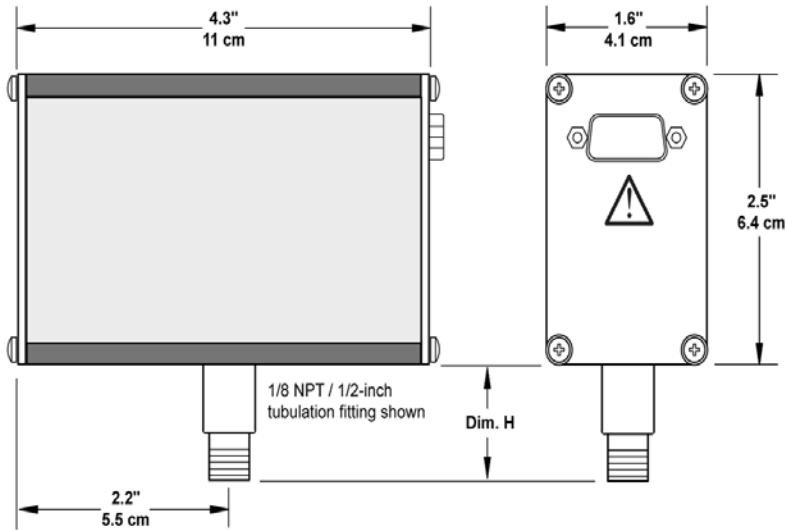

Table 2-1 Mini-Convectron Vacuum Connections

Vacuum Connections	Dim. H	
	cm	in.
1/8 NPT pipe thread, 1/2-inch inside diameter	2.2	0.9
1/2-inch 4 VCR® type fitting, female	3.0	1.2
1/2-inch 8 VCR type fitting, female	3.9	1.5
NW16KF flange	3.1	1.2
NW25KF flange	3.1	1.2
NW40KF flange	3.7	1.5
1.33-inch (NW16CF) ConFlat® flange	3.8	1.5
2.75-inch (NW35CF) ConFlat flange	3.8	1.5

Orient the Module

For proper operation of the module above 1 Torr, orient the module so the axis is horizontal (see Figure 2-4). Although the Convectron gauge will read correctly below 1 Torr with the module mounted in any position, inaccurate readings will result at pressures above 1 Torr if the module axis is not horizontal.

Figure 2-4 Module Orientation

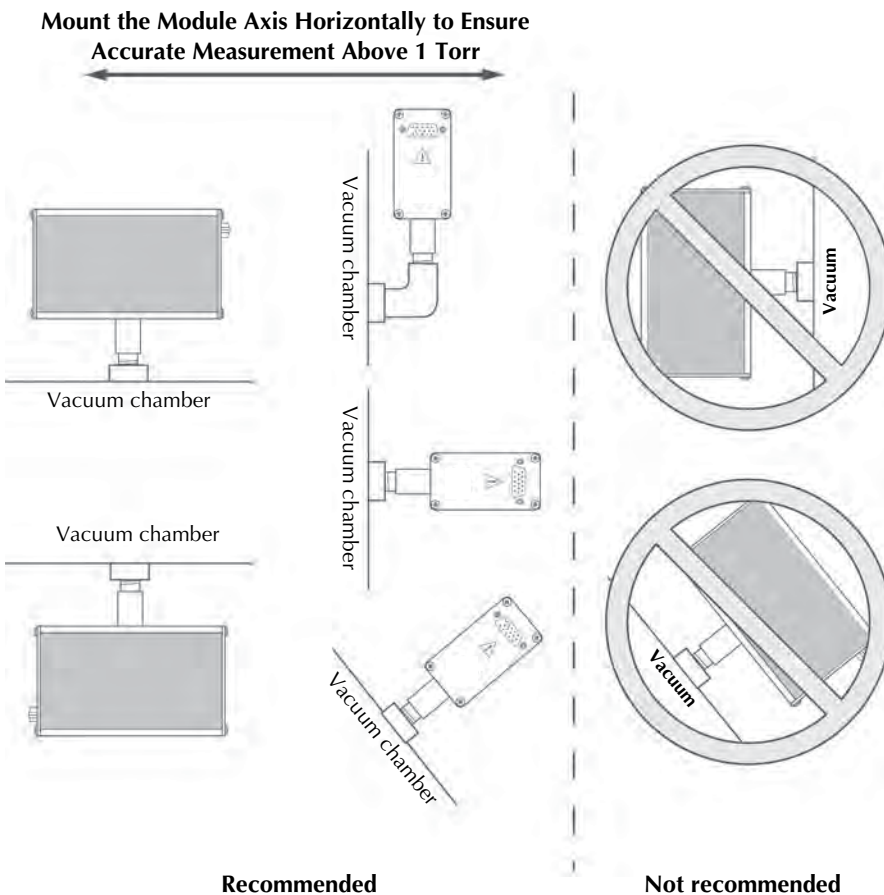

Installation

Step 2 *Attach the module to the vacuum chamber*

Attach the module vacuum chamber fitting to its mate on the vacuum chamber.

**CAUTION**

Twisting the module to tighten the fitting to the vacuum chamber can damage the module's internal connections.

- Do not twist the module to tighten the fitting.
- Use appropriate tools to tighten the fitting.

1/8 NPT pipe thread

The 1/8 NPT pipe thread accommodates a standard 1/8 NPT female fitting.

- a. Wrap the threads of the port to the vacuum chamber with thread seal tape.
- b. Without using a wrench or other tool, tighten the module just enough to achieve a seal.

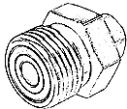
VCR type fitting

- a. Remove the plastic or metal bead protector cap from the fitting.
- b. If a gasket is used, place the gasket into the female nut.
- c. Assemble the components and tighten them to finger-tight.
- d. While holding a back-up wrench stationary, tighten the female nut 1/8 turn past finger-tight on 316 stainless steel or nickel gaskets, or 1/4 turn past finger-tight on copper or aluminum gaskets.

KF flange

The KF mounting system requires O-rings and centering rings between mating flanges.

- a. Tighten the clamp to compress the mating flanges together.
- b. Seal the O-ring.

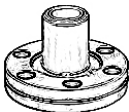
ConFlat flange

To minimize the possibility of leaks with ConFlat flanges, use high strength stainless steel bolts and a new, clean OFHC copper gasket. Avoid scratching the seal surfaces. To avoid contamination, install metal gaskets.

- a. Finger tighten all bolts.
- b. Use a wrench to continue tightening 1/8 turn at a time in crisscross order (1, 4, 2, 5, 3, 6) until flange faces make contact.
- c. Further tighten each bolt about 1/16 turn.

Step 3 Assemble and connect the wiring

Connecting Cable

The cable is user-supplied. Granville-Phillips does not supply the cable. Install externally shielded cable and connect the shield at both ends.

At the module end of the cable, connect the shield to the outer shell of the subminiature D connector.

On both versions of the module, connect the 11.5 to 26.5 Vdc power supply to terminals 3 and 4.

- Terminal 4 (ground) is negative (-).
- Terminal 3 (input) is positive (+).

For grounding instructions, see page 20.

Wiring Terminals

Figure 2-5 illustrates the 15-pin D subminiature wiring terminals for the module with two setpoint relays.

Figure 2-6 illustrates the 9-pin D subminiature wiring terminals for the module with one setpoint relay.

Figure 2-5 15-Pin Connector for Module with two Setpoint Relays

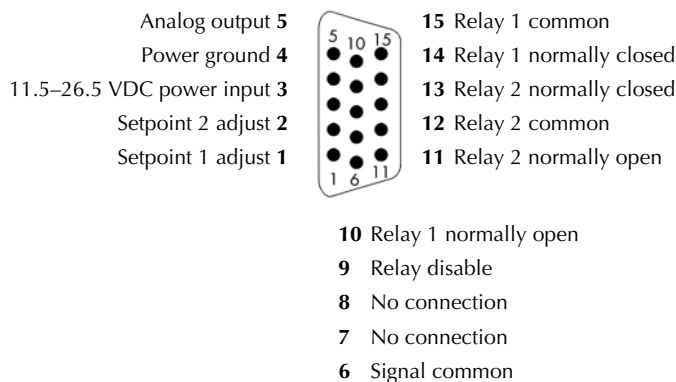
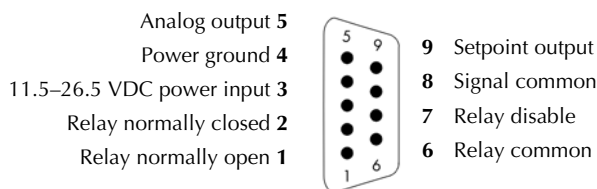

Figure 2-6 9-Pin Connector for Module with one Setpoint Relay



Grounding

! WARNING

Improper grounding could cause product failure, property damage, or serious personal injury.

To reduce the risk of product failure, property damage, or serious personal injury, follow ground network requirements for the facility.

- Maintain all exposed conductors at earth ground.
- Ground the module housing to the vacuum chamber as instructed below.
- Make sure the vacuum port to which the module is mounted is properly grounded.

If the fitting allows continuous metal-to-metal contact between the housing base and the vacuum chamber, the module is properly grounded via the fitting. If the fitting requires a rubber gasket, rubber O-ring, Teflon tape, or other material that prevents metal-to-metal contact between the housing base and the vacuum chamber, refer to Figure 2-7 and follow these instructions to ground the module to the vacuum chamber:

- Attach a metal hose clamp or other metal clamp to the gauge stem of the housing.
- Install a 3.31 mm² (12 AWG) or larger copper wire between the clamp and a metal ground lug, bolt, or stud on the vacuum chamber.

Figure 2-7 Ground Connection to the Vacuum Chamber

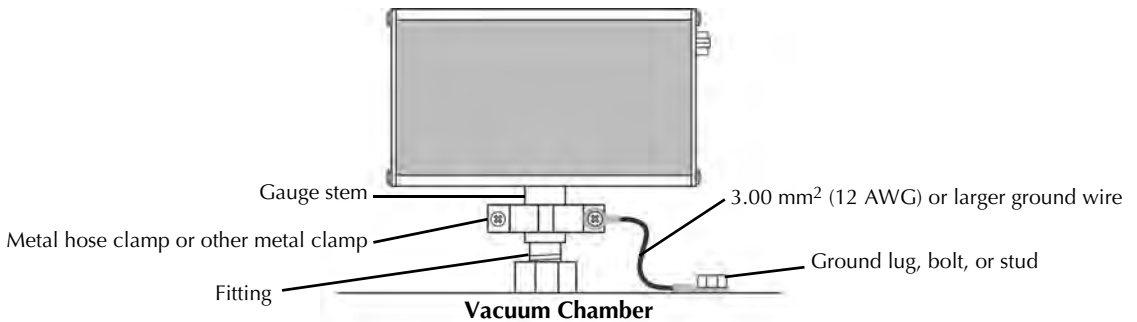

Step 4 *Configure the setpoint relays for the application*

To configure setpoint relays for the module, see pages 36–43.

If the module will measure the pressure of a gas other than N₂ or air, you *must* adjust relay setpoints for the process gas. The true pressure of a gas other than N₂ or air may be substantially different from the pressure that the output indicates. For example, outputs might indicate a pressure of 10 Torr (1.33 kPa, 13.3 mbar) for argon, although the true pressure of the argon is 250 Torr (33.3 kPa, 333.3 mbar). Such a substantial difference between indicated pressure and true pressure can cause overpressurization resulting in an explosion.

**WARNING**

Failure to use accurate pressure conversion data for N₂ or air to other gases can cause an explosion due to over-pressurization.

If the module will measure any gas other than N₂ or air, before connecting relays to system control devices, adjust setpoints for the process gas that will be used.

Step 5 *Calibrate the Convectron gauge*

Calibration improves the accuracy and repeatability of the Convectron gauge. To calibrate the Convectron gauge, see pages 44–46.

Atmospheric Pressure Calibration

An atmospheric calibration is performed on the Convectron gauge, using N₂, at the factory before the module is shipped. The factory calibration sets the atmospheric calibration point to 760 Torr (101.3 kPa, 1013 mbar) of N₂.

Because performance varies depending on the process gas, you may wish to reset the atmospheric calibration point if a gas other than N₂ or air is being used. Periodic resets of the atmospheric calibration point also improve the accuracy and repeatability of the Convectron gauge near atmospheric pressure, even if the process gas is N₂ or air.

Vacuum Chamber Pressure Calibration

Periodic resets of the vacuum chamber pressure calibration point improve the accuracy and repeatability of the Convectron gauge.

3.1 Preparing to Operate the Module



WARNING

Using the module to measure the pressure of flammable or explosive gases can cause a fire or explosion resulting in severe property damage or personal injury.

Do not use the module to measure the pressure of flammable or explosive gases.

This chapter explains how to operate the Mini-Convectron module with a non-linear analog output and one setpoint relay or two setpoint relays. If the module has two setpoint relays, it may also have an optional pressure value display.

- Figure 3-1 illustrates the module with two setpoint relays and the optional display. Table 3-1 lists features of the front panel if the module has the optional display.
- Figure 3-2 illustrates the module with one setpoint relay and no display. Table 3-2 lists features of the front panel if the module has one setpoint relay and no display.
- Figure 3-3 illustrates the module with two setpoint relays and no display. Table 3-3 lists features of the front panel if the module has two setpoint relays and no display.

Figure 3-1 Mini-Convectron Module with two Setpoint Relays and 3-Digit Display



Table 3-1 Front Panel Features of Mini-Convectron Module with 3-Digit Display

Feature	Description
ADJUST ATM potentiometer	Enables Convectron gauge calibration at atmospheric pressure
ADJUST VAC potentiometer	Enables Convectron gauge calibration at vacuum chamber pressure
S.P. ADJUST SET switch	Enables choosing of setpoint relay 1 or setpoint relay 2 for adjustment <ul style="list-style-type: none"> • Press the switch once to adjust setpoint relay 1 • Press the switch twice to adjust setpoint relay 2
S.P. ADJUST DOWN switch	Enables downward adjustment of setpoint 1 or setpoint 2
S.P. ADJUST UP switch	Enables upward adjustment of setpoint 1 or setpoint 2
Pressure value display	Provides 3-digit indication of measured pressure
TORR and mTORR LEDs	<ul style="list-style-type: none"> • TORR is solid green when 3-digit display indicates pressure in Torr • mTORR is solid green when 3-digit display indicates pressure in mTorr
RELAY ON SP1 and RELAY ON SP2 LEDs	<ul style="list-style-type: none"> • RELAY ON SP1 is solid green when setpoint relay 1 is activated • RELAY ON SP1 blinks green if S.P. ADJUST SET switch has been pressed once • RELAY ON SP2 is solid green when setpoint relay 2 is activated • RELAY ON SP2 blinks green if S.P. ADJUST SET switch has been pressed twice

Figure 3-2 Mini-Convectron Module with one Setpoint Relay, no Display

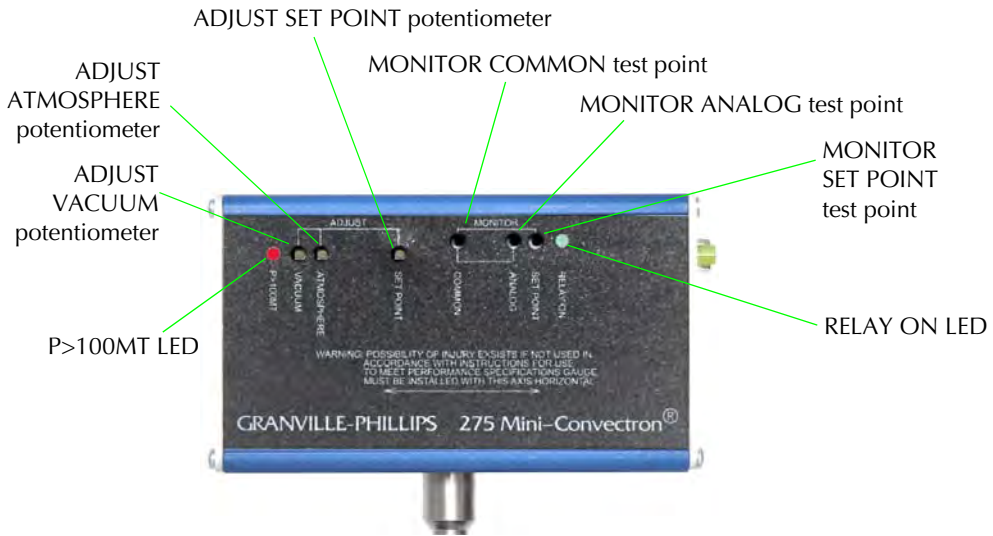

Table 3-2 Front Panel Features of Mini-Convectron Module with one Setpoint Relay, no Display

Feature	Description
ADJUST ATMOSPHERE potentiometer	Enables Convectron gauge calibration at atmospheric pressure
ADJUST VACUUM potentiometer	Enables Convectron gauge calibration at vacuum chamber pressure
ADJUST SET POINT potentiometer	Enables setting of vacuum pressure at which setpoint relay activates
MONITOR ANALOG test point	Enables reading of analog output voltage representing measured pressure
MONITOR COMMON test point	Enable checking of values for: <ul style="list-style-type: none"> • Convectron gauge calibration at atmospheric pressure • Convectron gauge calibration at vacuum chamber pressure
MONITOR SET POINT test point	Enables checking of setpoint relay voltage representing measured pressure
P>100MT LED	Turns solid red when pressure is >100 mTorr
RELAY ON LED	Turns solid green when setpoint relay is activated

Figure 3-3 Mini-Convectron Module with two Setpoint Relays, no Display

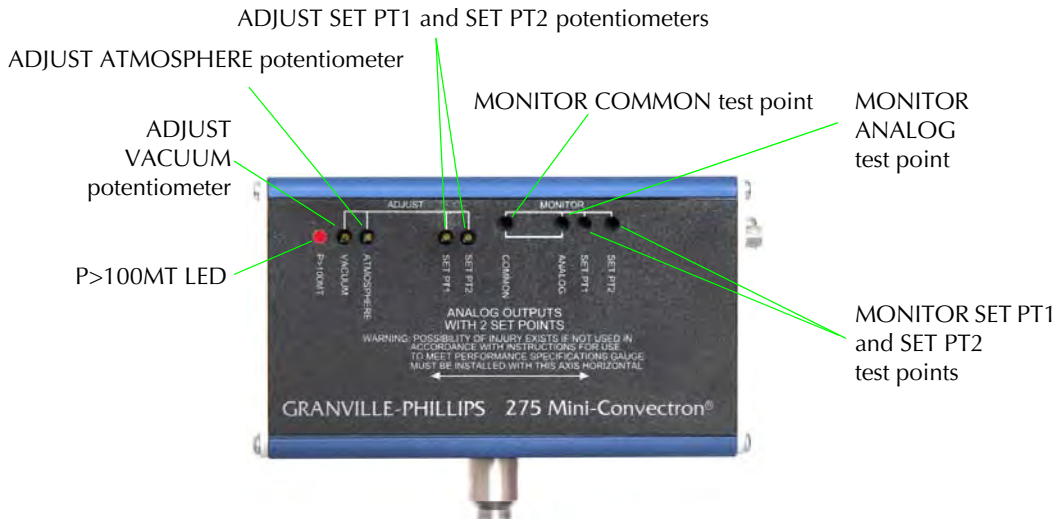

Table 3-3 Front Panel Features of Mini-Convectron Module with two Setpoint Relays, no Display

Feature	Description
ADJUST ATMOSPHERE potentiometer	Enables Convectron gauge calibration at atmospheric pressure
ADJUST VACUUM potentiometer	Enables Convectron gauge calibration at vacuum chamber pressure
ADJUST SET PT1 and ADJUST SET PT2 potentiometers	Enables setting of vacuum pressure at which setpoint relays activate
MONITOR ANALOG test point	Enables reading of analog output voltage representing measured pressure
MONITOR COMMON test point	Enable checking of values for: <ul style="list-style-type: none"> • Convectron gauge calibration at atmospheric pressure • Convectron gauge calibration at vacuum chamber pressure
MONITOR SET PT1 and MONITOR SET PT2 test points	Enables checking of setpoint relay voltage representing measured pressure
P>100MT LED	Turns solid red when pressure is >100 mTorr

Before putting the module into operation, you must perform the following procedures:

1. Install the module in accordance with the instructions on pages 15-21.
2. Develop a logic diagram of the process control function.
3. Use Table 3-4 to record the proposed setpoint in volts, corresponding pressure setting, and activation direction for each relay.

Table 3-4 Proposed Relay Setpoints

Relay	Setpoint (V)	Pressure Corresponding to Setpoint
Relay 1		
Relay 2		

4. Draw a circuit schematic that specifies exactly how each piece of system hardware will connect to the module relays.
5. Attach a copy of the process control circuit diagram to this manual for future reference and troubleshooting.
6. If the module will measure the pressure of a gas other than N₂ or air, you *must* adjust the setpoint relays for the process gas that will be used. See pages 36–43.

For application assistance, phone a Granville-Phillips application engineer at 1-303-652-4400 or 1-800-776-6543.

Once the module is operating, you may use the module front panel to perform the tasks listed in Table 3-5.

Table 3-5 Tasks and Page References for Module Operation

Task	For instructions, see this page
Reading the analog output	See pages 28–31
Programming relay setpoints	See pages 36–43
Reading activation or deactivation status of relays	See page 44
Calibrating Convectron gauge at atmospheric pressure	See page 44
Calibrating Convectron gauge at vacuum chamber pressure	See page 46
Resetting parameters to factory defaults	See page 47

3.2 Nonlinear Analog Output

The module contains a convection-enhanced Pirani thermal conductivity gauge. The gauge measures the heat loss from a heated sensing wire that is maintained at a constant temperature.

The analog output produces a nonlinear voltage that corresponds to measured pressure. Output voltage is measured across pins 5 and 8 if the module has one setpoint relay or across pins 5 and 6 if the module has two setpoint relays.

Refer to Table 3-6 on page 29 to calculate pressure (y) as a function of output voltage (x). Figure 3-4 and Figure 3-5 on pages 30–31 are graphs that represent true pressure for N₂ or air (y axis) versus voltage (x axis).

- Output impedance is 100 Ω.
- The output is normalized to 0.375 Vdc at vacuum chamber pressure and to 5.534 Vdc at 1000 Torr (133.3 kPa, 1333 mbar) for N₂ or air.

The vacuum chamber pressure indicated by the gauge depends on the gas type, gas density (pressure), and the module orientation. The module is factory calibrated for N₂ (air has approximately the same calibration). For gases other than N₂ or air, heat loss varies at any given pressure, and you must apply an appropriate conversion factor.

Commonly used Gases Other than N₂ or Air

Refer to Table 3-7 on page 32 for pressure versus output voltage for 10 commonly used process gases other than N₂ or air.

Refer to Figure 3-6, Figure 3-7, or Figure 3-8 to determine true pressure versus indicated pressure for the gas that is being used.

Other Gases

If the gas being used is not included in Table 3-7, or for a gas mixture, you will need to generate a calibration curve using a gas-independent transfer standard such as a capacitance manometer. Use the following equation to determine the maximum usable output voltage:

$$\text{Output voltage} = \text{Input voltage} - 4 \text{ Vdc}$$

Table 3-6 Equations for Calculating N₂ or Air Pressure Versus Analog Output Voltage

Segment	Output Voltage	Equation where y = Pressure and x = Voltage	Coefficients	
1	0.375 to 2.842 V	$y_{\text{Torr}} = a + bx + cx^2 + dx^3 + ex^4 + fx^5$ $y_{\text{Pa}} = (a + bx + cx^2 + dx^3 + ex^4 + fx^5) \times 133.3$ $y_{\text{mbar}} = (a + bx + cx^2 + dx^3 + ex^4 + fx^5) \times 1.333$	a	-0.02585
			b	0.03767
			c	0.04563
			d	0.1151
			e	-0.04158
			f	0.008737
2	2.842 to 4.945 V	$y_{\text{Torr}} = \frac{a + cx + ex^2}{1 + bx + dx^2 + fx^3}$ $y_{\text{Pa}} = \left(\frac{a + cx + ex^2}{1 + bx + dx^2 + fx^3} \right) \times 133.3$ $y_{\text{mbar}} = \left(\frac{a + cx + ex^2}{1 + bx + dx^2 + fx^3} \right) \times 1.333$	a	0.1031
			b	-0.3986
			c	-0.02322
			d	0.07438
			e	0.07229
			f	-0.006866
3	4.94 to 5.659 V	$y_{\text{Torr}} = \frac{a + cx}{1 + bx + dx^2}$ $y_{\text{Pa}} = \left(\frac{a + cx}{1 + bx + dx^2} \right) \times 133.3$ $y_{\text{mbar}} = \left(\frac{a + cx}{1 + bx + dx^2} \right) \times 1.333$	a	100.624
			b	-0.37679
			c	-20.5623
			d	0.0348656

Figure 3-4 Analog Output Voltage vs. Indicated N₂ or Air Pressure, 1 mTorr to 100 mTorr

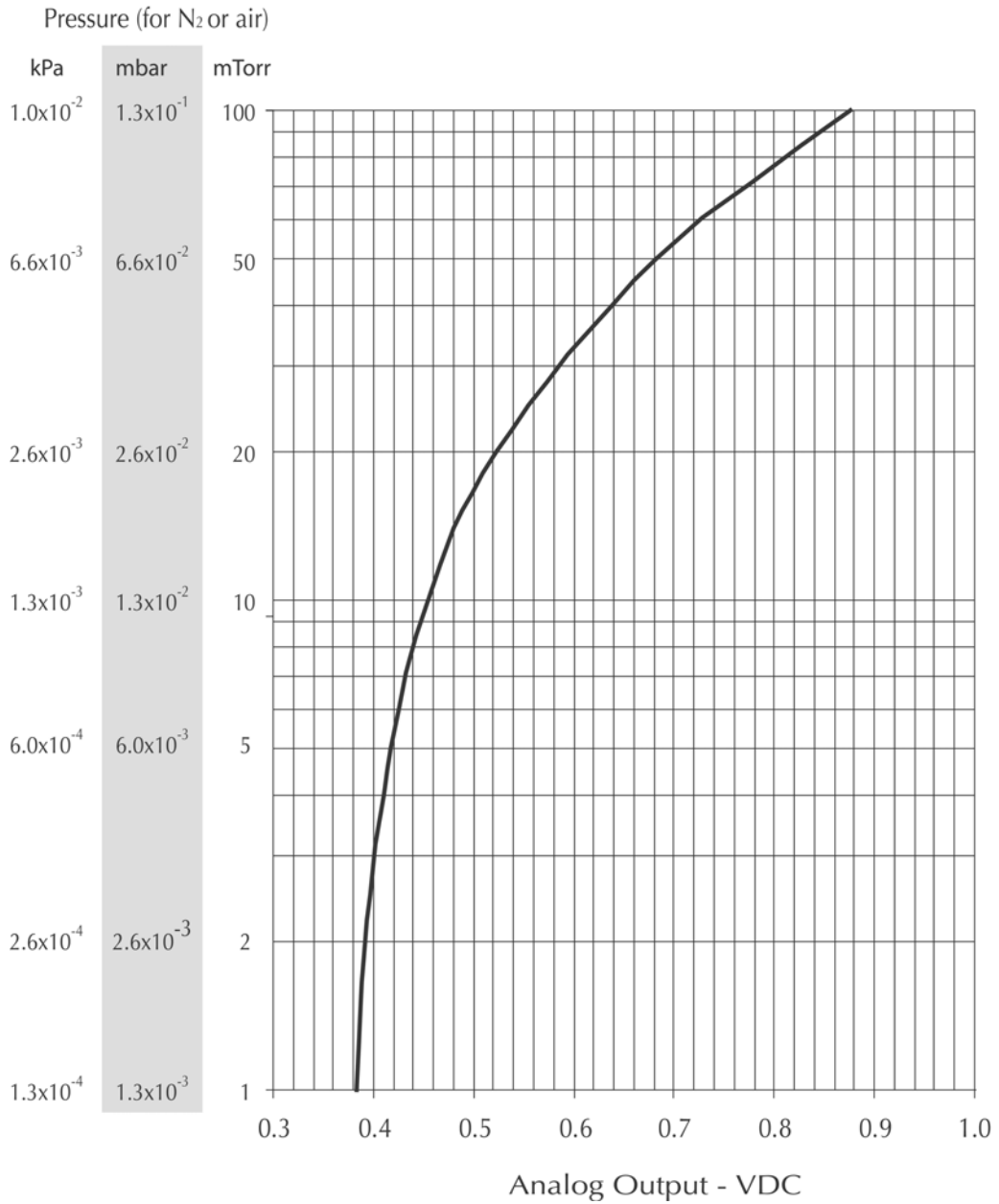
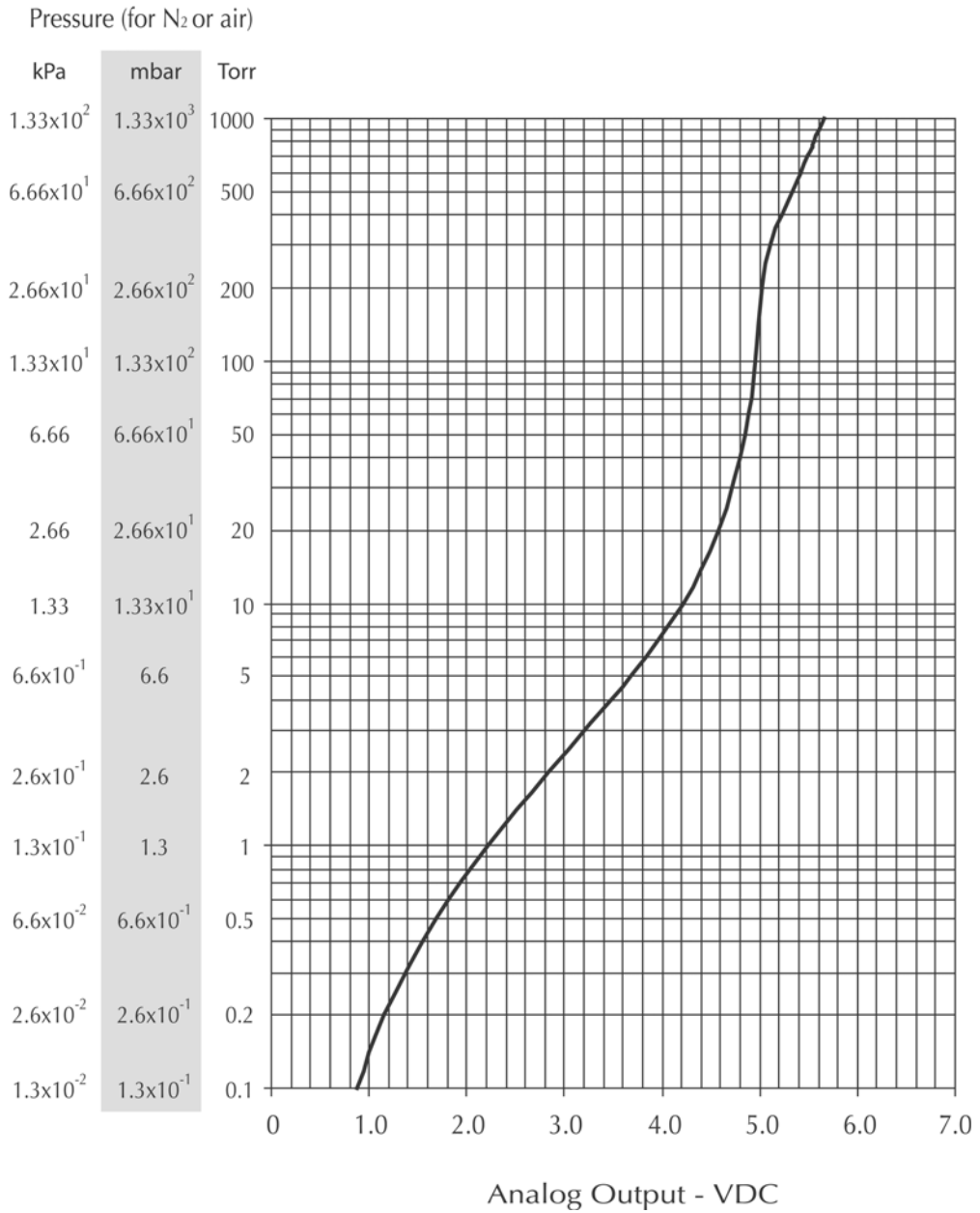

Figure 3-5 Analog Output Voltage vs. Indicated N₂ or Air Pressure, 0.1 Torr to 1000 Torr



Operation

Table 3-7 Voltages (Vdc) for Commonly used Gases, 0.1 mTorr to 1000 Torr

Torr or mTorr	True pressure		N ₂ (air)	Argon	Helium	O ₂	CO ₂	KR	Freon _{1,2}	Freon ₂₂	D ₂	Ne	CH ₄
	kPa	mbar											
1 mTorr	1.3 x 10 ⁻⁴	1.3 x 10 ⁻³	.384	.381	.382	.384	.385	.379	.388	.388	.386	.381	.3896
2 mTorr	2.6 x 10 ⁻⁴	2.6 x 10 ⁻³	.392	.387	.389	.392	.395	.384	.401	.400	.396	.388	.403
5 mTorr	6.0 x 10 ⁻⁴	6.0 x 10 ⁻³	.417	.403	.409	.417	.412	.395	.437	.432	.425	.405	.438
10 mTorr	1.3 x 10 ⁻³	1.3 x 10 ⁻²	.455	.429	.441	.453	.462	.415	.488	.480	.470	.433	.492
20 mTorr	2.6 x 10 ⁻³	2.6 x 10 ⁻²	.523	.477	.497	.521	.536	.451	.581	.566	.549	.484	.584
50 mTorr	6.6 x 10 ⁻³	6.6 x 10 ⁻²	.682	.595	.637	.679	.705	.544	.778	.764	.727	.608	.796
100 mTorr	1.3 x 10 ⁻²	1.3 x 10 ⁻¹	.876	.745	.814	.868	.900	.668	1.009	.990	.944	.768	1.053
0.2 Torr	2.6 x 10 ⁻²	2.6 x 10 ⁻¹	1.155	.962	1.068	1.141	1.179	.847	1.315	1.291	1.265	1.002	1.392
0.5 Torr	6.6 x 10 ⁻²	6.6 x 10 ⁻¹	1.683	1.386	1.589	1.664	1.668	1.194	1.826	1.805	1.914	1.469	2.014
1 Torr	1.3 x 10 ⁻¹	1.3	2.217	1.818	2.164	2.195	2.172	1.536	2.257	2.247	2.603	1.976	2.632
2 Torr	2.6 x 10 ⁻¹	2.6	2.842	2.333	2.939	2.814	2.695	1.921	2.647	2.666	3.508	2.631	3.313
5 Torr	6.6 x 10 ⁻¹	6.6	3.675	3.028	4.387	3.672	3.316	2.429	3.029	3.090	5.059	3.715	-
10 Torr	1.33	1.33 x 10 ¹	4.206	3.480	5.774	4.225	3.670	2.734	3.204	3.330	6.361	4.605	4.699
20 Torr	2.66	2.66 x 10 ¹	4.577	3.801	7.314	4.620	3.903	2.966	3.308	3.414	-	5.406	5.172
50 Torr	6.66	6.66 x 10 ¹	4.846	4.037	-	4.916	4.071	3.075	3.430	3.509	-	6.159	5.583
100 Torr	1.33 x 10 ¹	1.33 x 10 ²	4.945	4.122	-	5.026	4.154	3.134	3.618	3.660	-	6.483	5.720
200 Torr	2.66 x 10 ¹	2.66 x 10 ²	5.019	4.192	-	5.106	4.336	3.269	3.827	3.883	-	6.661	5.860
300 Torr	3.99 x 10 ¹	3.99 x 10 ²	5.111	4.283	-	5.200	4.502	3.384	3.938	4.005	-	6.726	-
400 Torr	5.33 x 10 ¹	5.33 x 10 ²	5.224	4.386	-	5.315	4.621	3.466	4.016	4.088	-	6.767	6.103
500 Torr	6.66 x 10 ¹	6.66 x 10 ²	5.329	4.477	-	5.422	4.708	3.526	4.076	4.151	-	6.803	-
600 Torr	7.99 x 10 ¹	7.99 x 10 ²	5.419	4.550	-	5.515	4.775	3.573	4.124	4.203	-	6.843	6.342
700 Torr	9.33 x 10 ¹	9.33 x 10 ²	5.495	4.611	-	5.592	4.830	3.613	4.166	4.247	-	6.890	-
760 Torr	1.01 x 10 ²	1.01 x 10 ³	5.534	4.643	-	5.633	4.860	3.632	4.190	4.271	-	6.920	-
800 Torr	1.06 x 10 ²	1.06 x 10 ³	5.558	4.663	-	5.658	4.877	3.645	4.203	4.286	-	6.942	6.519
900 Torr	1.19 x 10 ²	1.19 x 10 ³	5.614	4.706	-	5.713	4.919	3.674	4.237	4.321	-	7.000	-
1000 Torr	1.33 x 10 ²	1.33 x 10 ³	5.659	4.745	-	5.762	4.955	-	4.270	4.354	-	7.056	6.642

Figure 3-6 True Pressure versus Indicated Pressure for Commonly used Gases, 10^{-4} to 10^{-1} Torr

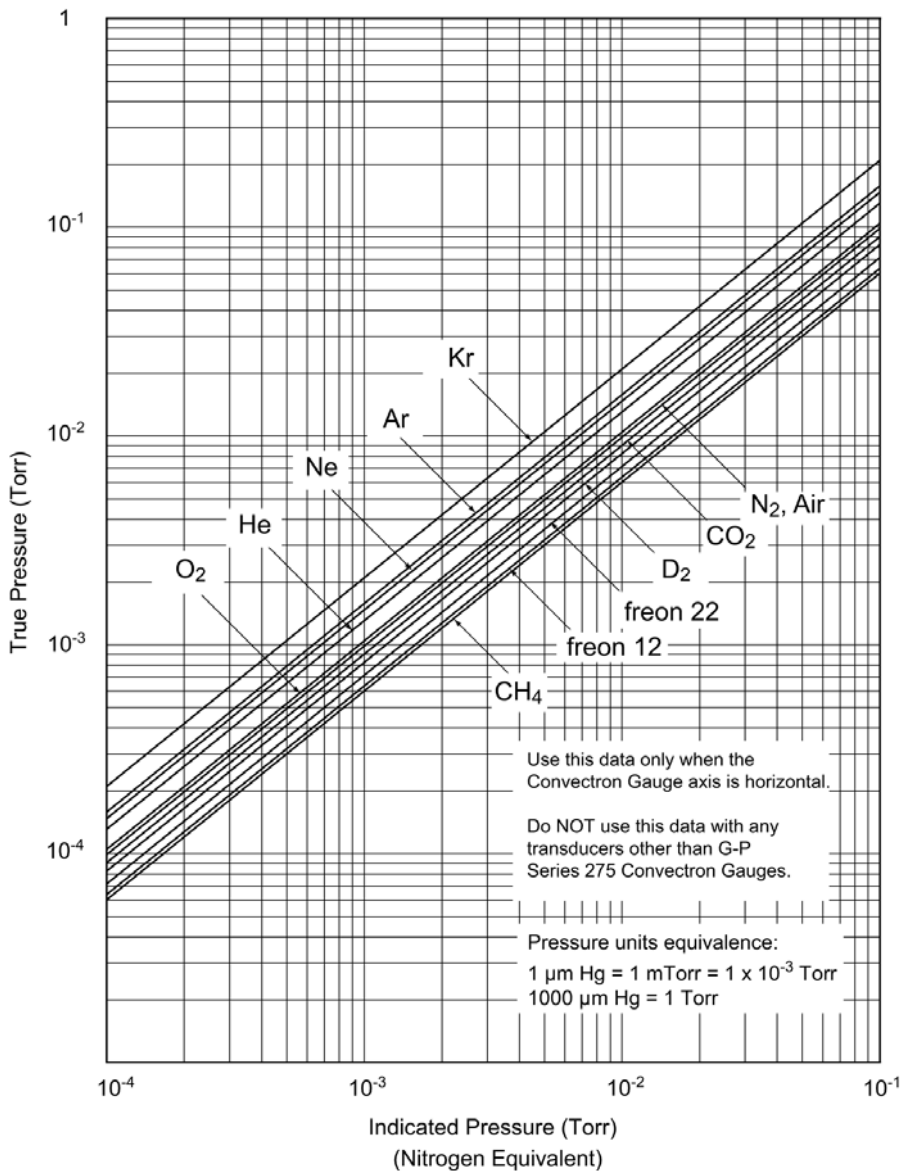

Indicated pressure in Torr (N_2 equivalent)
To convert Torr to pascal, multiply by 133.3
To convert Torr to mbar, multiply by 1.333

Operation

Figure 3-7 True Pressure versus Indicated Pressure for Commonly used Gases, 10^{-1} to 1000 Torr

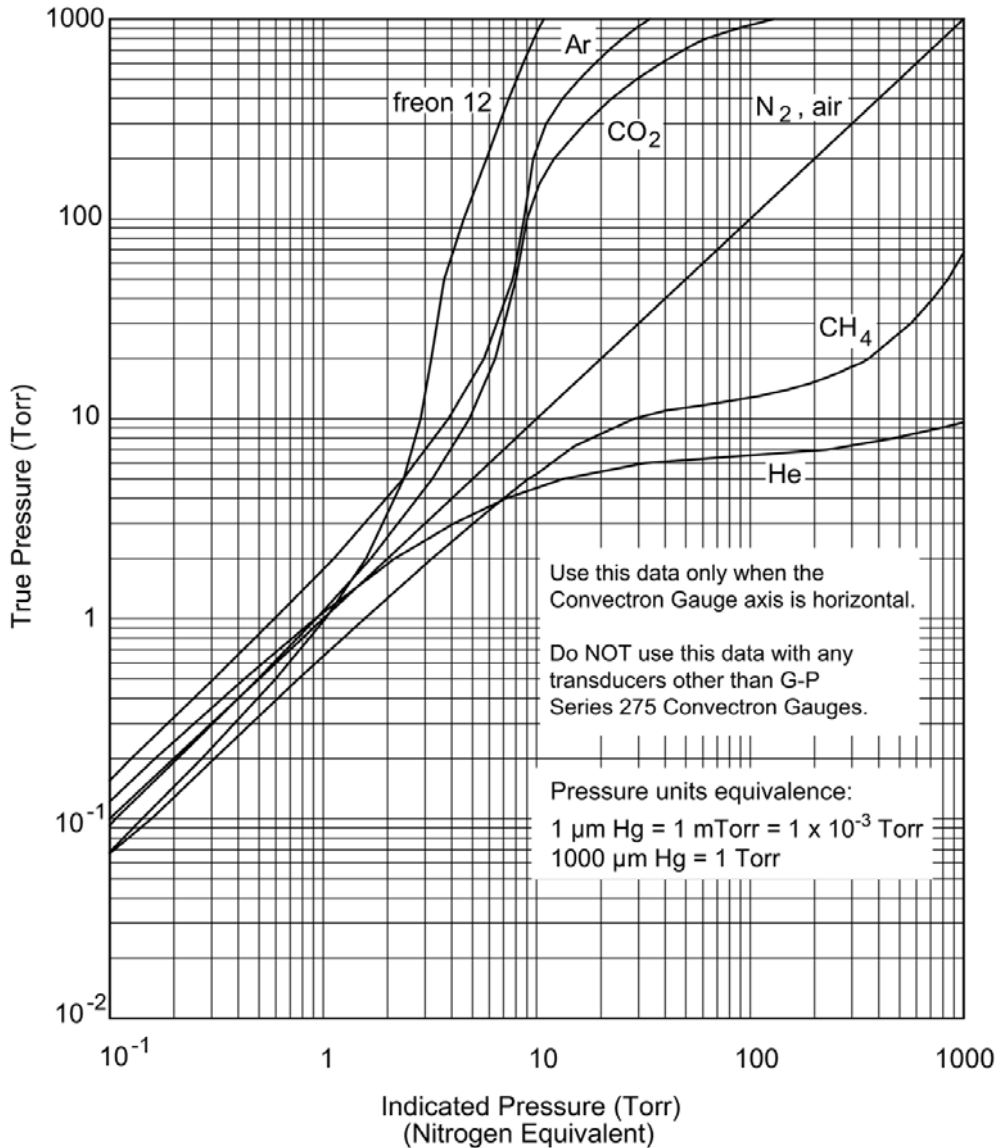

Indicated pressure in Torr (N_2 equivalent)
 To convert Torr to pascal, multiply by 133.3
 To convert Torr to mbar, multiply by 1.333

Figure 3-8 True Pressure versus Indicated Pressure for Commonly used Gases, 10⁻¹ to 1000 Torr

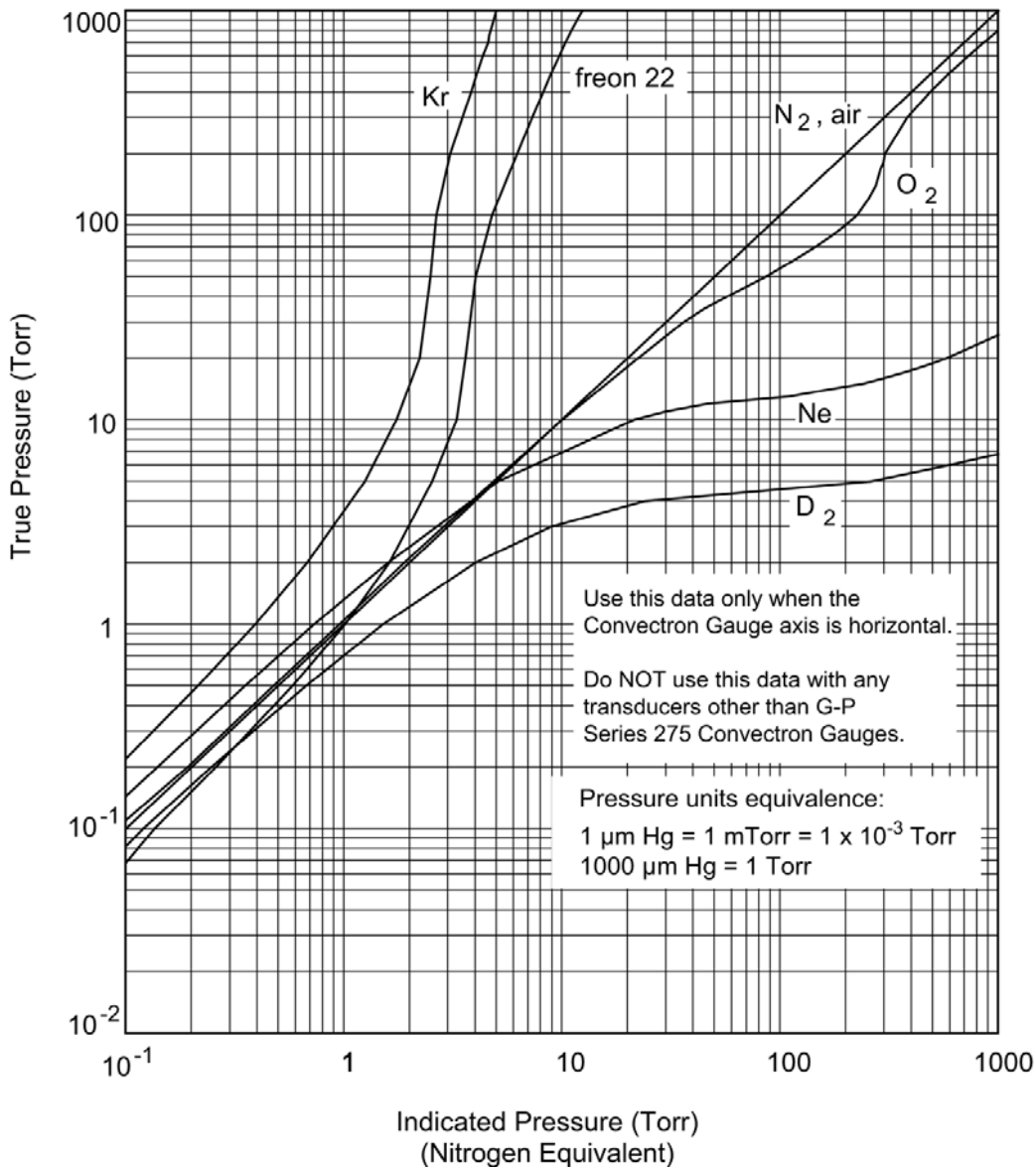

Indicated pressure in Torr (N₂ equivalent)
 To convert Torr to pascal, multiply by 133.3
 To convert Torr to mbar, multiply by 1.333

Operation

Figure 3-9 True Pressure versus Indicated Pressure for Commonly used Gases, 10^{-4} to 0.1 mbar

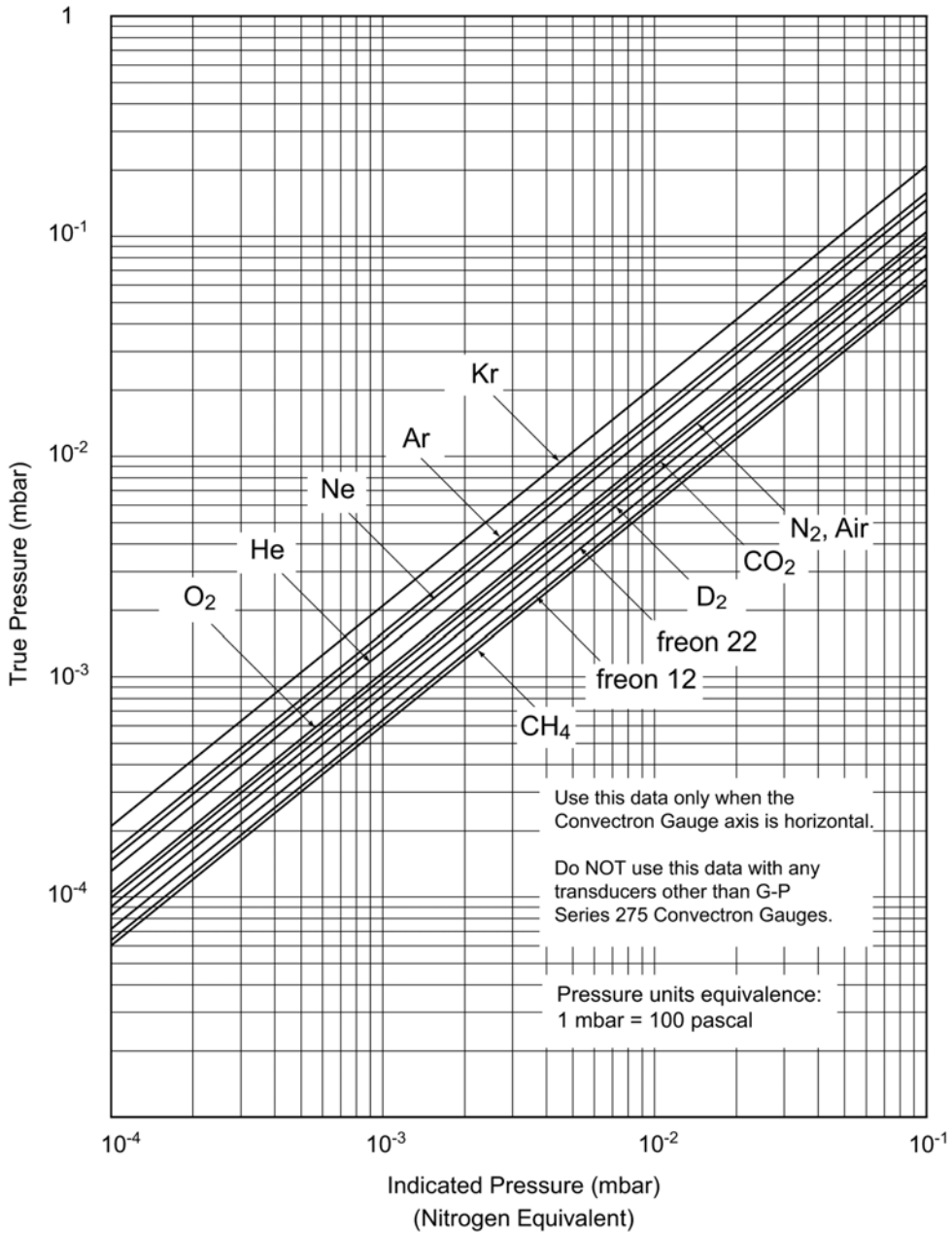

Figure 3-10 True Pressure versus Indicated Pressure for Commonly used Gases, 0.1 to 1000 mbar

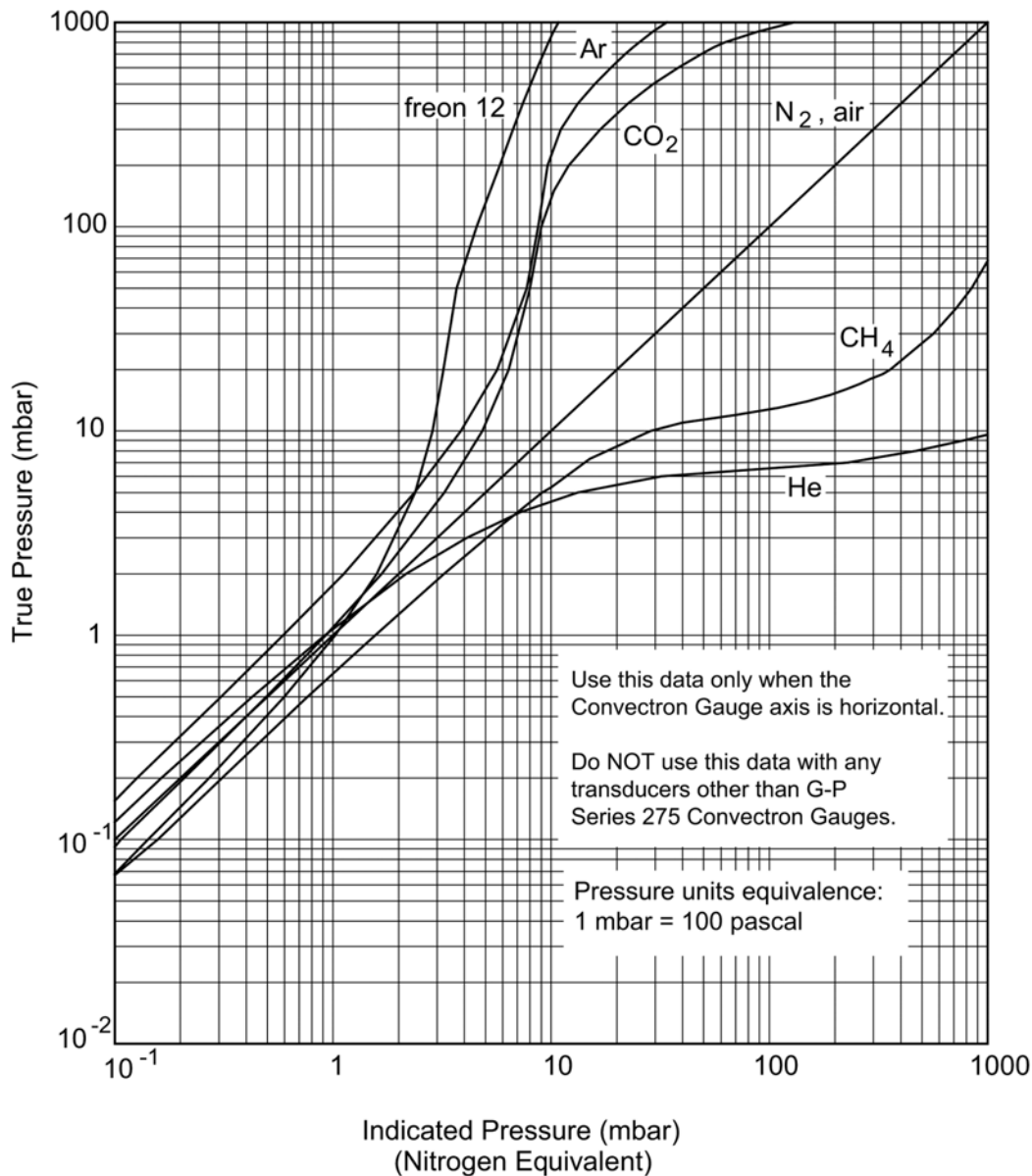
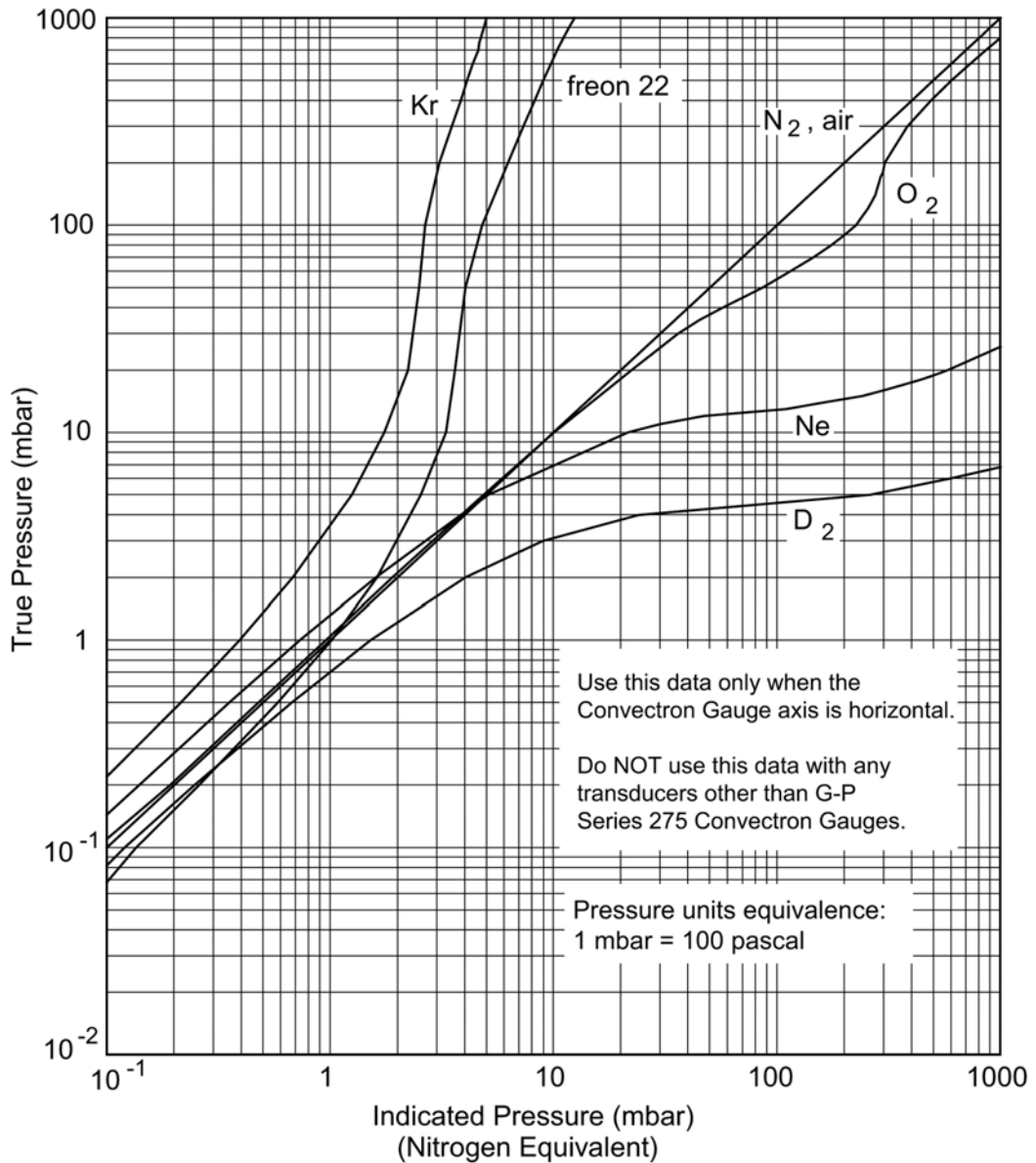

Figure 3-11 True Pressure versus Indicated Pressure for Commonly used Gases, 0.1 to 1000 mbar



3.3 Setpoint Relays

The module includes one single-pole, double throw (SPDT) relay or two such relays. Each relay has a programmable setpoint. The setpoint is a voltage level that corresponds to a specified pressure at which the relay activates and deactivates.

When the module is shipped from the factory, relays are set to activate below 0.0 Torr. The relays will not operate until they have been adjusted for the application.

Adjustment causes setpoint relays to activate with decreasing pressure and deactivate at a higher pressure than the activation pressure, as illustrated in Figure 3-12.

Figure 3-12 Setpoint Relay Behavior

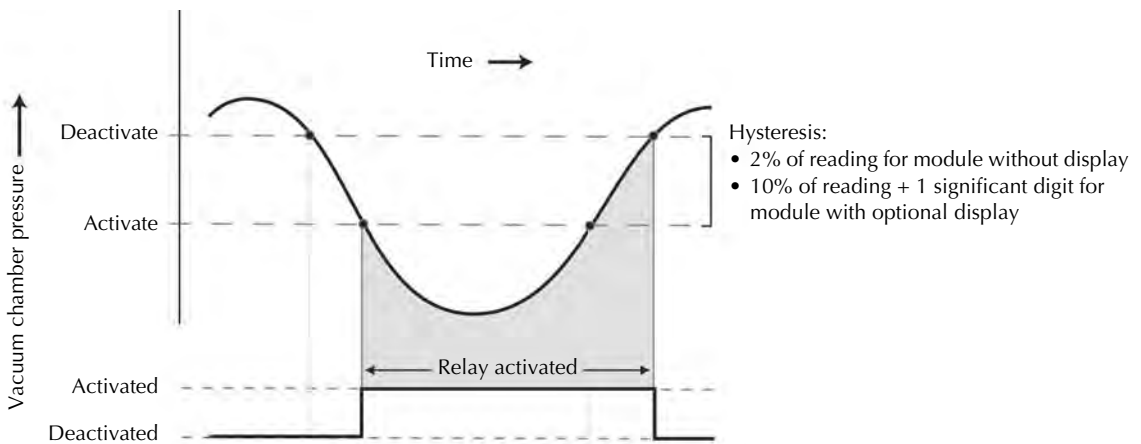

Preparing to Adjust Setpoint Relays

If the module will measure the pressure of any process gas other than N₂ or air, you must adjust setpoint relays for the process gas that will be used.

The true pressure of a gas other than N₂ or air may be substantially different from the pressure that the output indicates. For example, outputs might indicate a pressure of 10 Torr for argon, although the true pressure of the argon is 250 Torr. Such a substantial difference between indicated pressure and true pressure can cause overpressurization resulting in an explosion.

**WARNING**

Failure to use accurate pressure conversion data for N₂ or air to other gases can cause an explosion due to overpressurization.

If the module will measure any gas other than N₂ or air, before connecting relays to system control devices, adjust setpoints for the process gas that will be used.

Table 3-7 on page 32 and Figure 3-13 and Figure 3-14 on pages 42–43 enable you to determine the amount of voltage that corresponds to a specific N₂ or air pressure.

1. Make sure the module is properly installed, the axis is horizontal (see page 17), and the power supply is ON.
2. Figure 3-13 and Figure 3-14 are graphs that show test point voltage versus pressure for N₂ or air. Table 3-7 on page 32 lists test point voltage versus pressure for 12 commonly used process gases, including N₂ and air.

If you are using Figure 3-13 or Figure 3-14, find the point at which the horizontal line representing the desired trip point for N₂ or air pressure intercepts the vertical line representing test point voltage. For example:

- in Figure 3-13, a test point voltage of 0.64 V represents an N₂ or air pressure of 40 mTorr (5.3×10^{-3} kPa, 5.3×10^{-2} mbar).
- In Figure 3-14, a test point voltage of 4.8 V indicates an N₂ or air pressure of 40 Torr (5.33 kPa, 53.3 mbar).

If the gas being used is not included in Table 3-7, or for a gas mixture, you will need to generate a calibration curve using a gas-independent transfer standard such as a capacitance manometer.

A built-in hysteresis prevents oscillation around the setpoint.

- For the module without a display, hysteresis is 2% of reading.
- For the module with the optional display, hysteresis is 10% of reading plus one significant digit.

Hysteresis depends on the vacuum chamber pressure at which the setpoint has been established and on whether or not the module has the optional display.

Adjusting Setpoint Relays

The procedure for adjusting relays depends on the number of relays and on whether or not the module has the optional display.

If the module without a display has one setpoint relay:

1. Use a high-precision, high-input impedance DVM to measure the voltage across the MONITOR SET POINT and MONITOR COMMON test points on the module front panel.
2. Use a flat-head instrument screwdriver to adjust the ADJUST SET POINT potentiometer for the desired setpoint voltage at which the relay will activate with decreasing pressure.

If the module without a display has two setpoint relays:

1. Use a high-precision, high-input impedance DVM to measure the voltage across the MONITOR SET PT1 or MONITOR SET PT2 and MONITOR COMMON test points on the module front panel.
2. Use a flat-head instrument screwdriver to adjust the ADJUST SET PT1 or ADJUST SET PT2 potentiometer for the desired setpoint voltage at which relay 1 will activate with decreasing pressure.

If the module has a digital display:

1. Press the S.P. ADJUST SET switch once to adjust setpoint relay 1 or twice to adjust setpoint relay 2.
 - If relay 1 will be adjusted, the RELAY ON SP1 LED blinks green.
 - If relay 2 will be adjusted, the RELAY ON SP2 LED blinks green.
2. *Within three seconds*, press the S.P. ADJUST UP or S.P. ADJUST DOWN switch until the display indicates the pressure, in Torr or mTorr, at which the relay should activate with decreasing pressure.

Figure 3-13 Example Test Point Voltage: 0.64 V equals 40 mTorr (5.3×10^{-3} kPa, 5.3×10^{-2} mbar) of N₂ or Air

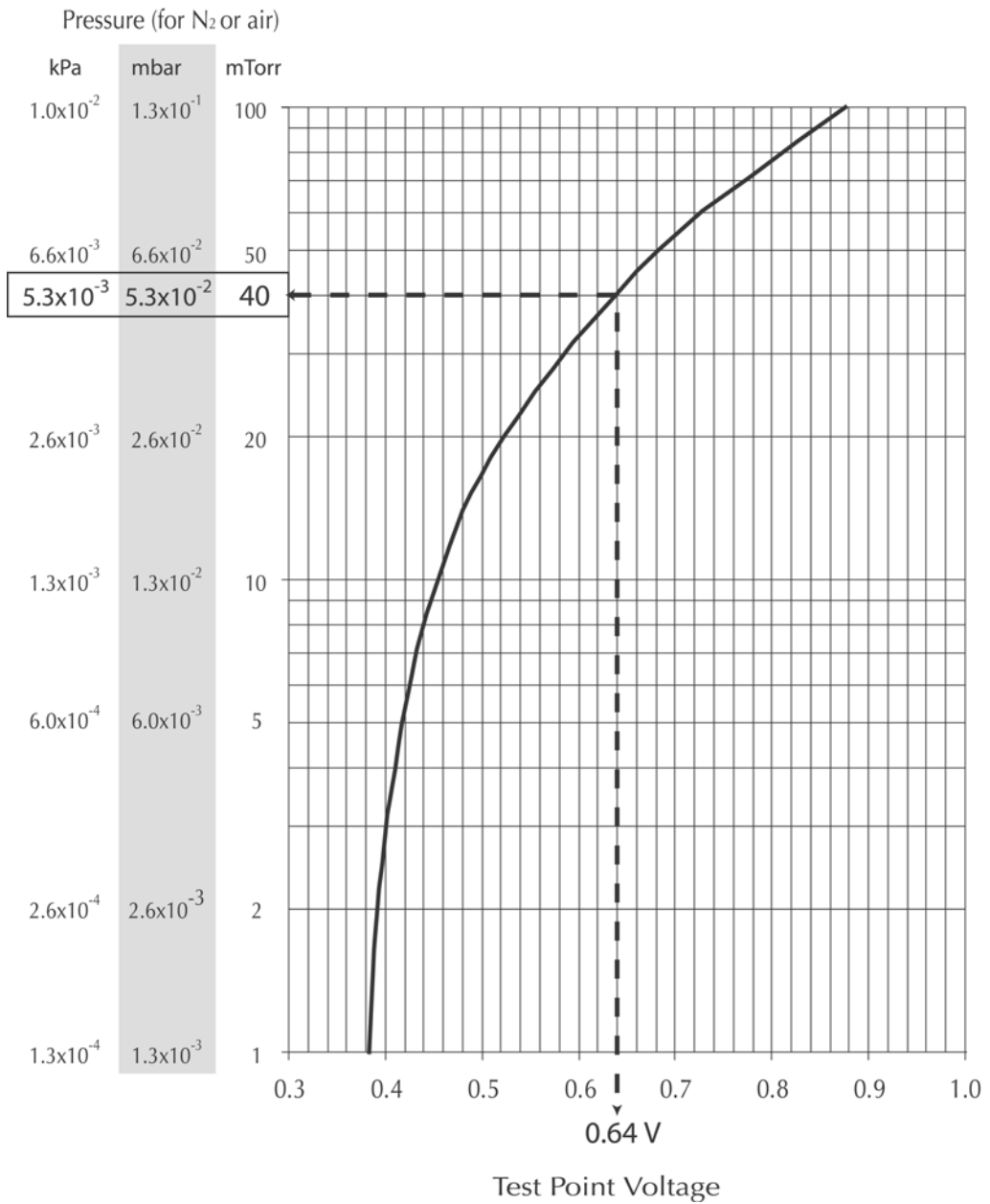
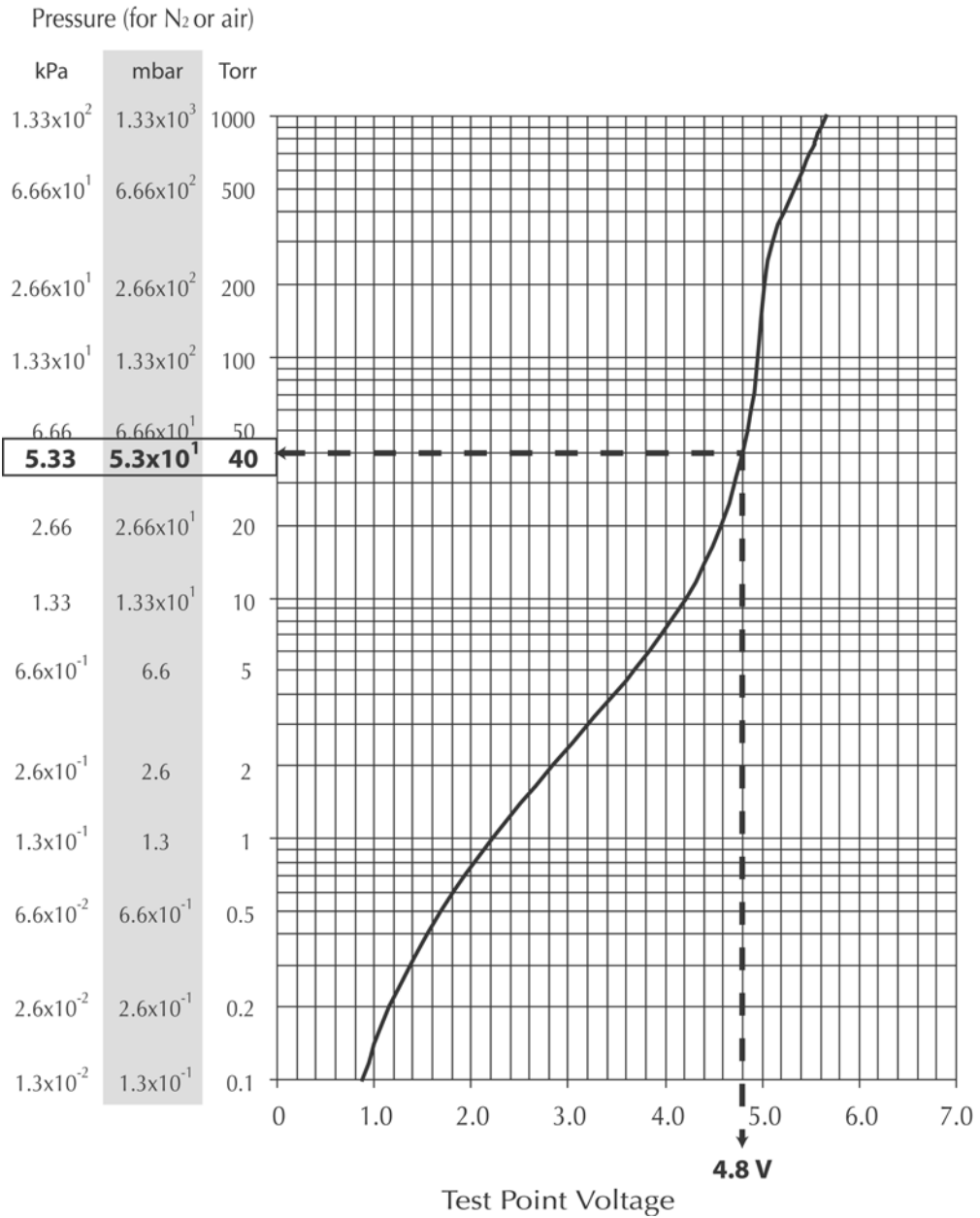

Figure 3-14 Example Test Point Voltage: 4.8 V equals 40 Torr (5.33 kPa, 53.3 mbar) of N₂ or Air



Operation

3.4 Reading Relay Status

If the module without a display has one setpoint relay, or if the module has the optional display, use the setpoint LEDs to read activation/deactivation status of relays.

If the module without a display has one setpoint relay:

The RELAY ON LED is solid green when the setpoint relay is activated.

If the module has a digital display:

- The RELAY ON SP1 LED is solid green when relay 1 is activated.
- The RELAY ON SP2 LED is solid green when relay 2 is activated.

You cannot read relay status if the module without a display has two setpoint relays.

3.5 Calibrating Convectron Gauge at Atmospheric Pressure

An atmospheric pressure calibration is performed on the Convectron gauge, using N₂, at the factory before the module is shipped. The factory calibration sets the atmospheric calibration point for N₂ to 760 Torr (101 kPa, 1013 mbar) of N₂.

Because performance varies depending on the process gas, you may wish to reset the atmospheric calibration point if a gas other than N₂ or air is being used. Periodic resets of the atmospheric calibration point also improve the accuracy and repeatability of the Convectron gauge near atmospheric pressure, even if the process gas is N₂ or air.

Regardless of the process gas that is being used, you should always use N₂ or air to calibrate the Convectron gauge at atmospheric pressure.

The procedure for calibrating the Convectron gauge at atmospheric pressure depends on whether or not the module has the optional display.

If the module does not have a digital display:

1. Shut off the pump and, using N₂ or air, allow the vacuum chamber pressure to increase to the value at which the atmospheric pressure point will be set.
2. Use a high-precision, high-input impedance DVM to measure the voltage across the MONITOR ANALOG and MONITOR COMMON test points on the module front panel.
3. Use a flat-head instrument screwdriver to adjust the ADJUST ATMOSPHERE potentiometer to a voltage that corresponds to the atmospheric pressure at your location. Table 3-8 on page 45 lists typical atmospheric pressure at altitude/Torr/voltage relationships.

If the module has a digital display:

1. Shut off the pump and, using N₂ or air, allow the vacuum chamber pressure to increase to the value at which the atmospheric pressure point will be set.
2. When the display indicates that pressure has achieved the atmospheric pressure point, use a flat-head instrument screwdriver to adjust the ADJUST ATM potentiometer to a voltage that corresponds to the displayed pressure. Table 3-8 lists typical atmospheric pressure at altitude/pressure/voltage relationships.

Table 3-8 Typical Atmospheric Pressures at Altitude/Pressure/Voltage Relationships

Altitude Above Sea Level		Pressure of N ₂ or Air			Analog Output Voltage (Vdc)
Feet	Meters	Torr	kPa	mbar	
0	0	760	101	1013	5.534
1000	305	733	97	977	5.513
2000	610	707	94	942	5.493
3000	914	681	90	908	5.473
4000	1219	656	87	874	5.454
5000	1524	632	84	842	5.435
6000	1829	609	81	812	5.417
7000	2134	586	78	781	5.399
8000	2438	564	75	752	5.382
9000	2743	543	72	724	5.366
10,000	3048	523	69	697	5.350

3.6 Calibrating Convectron Gauge at Vacuum Chamber Pressure

Periodic resets of the vacuum chamber calibration point improve the accuracy and repeatability of the Convectron gauge.

Regardless of the process gas that is being used, you should always use N₂ or air to calibrate the Convectron gauge at vacuum chamber pressure.

The procedure for calibrating the Convectron gauge at atmospheric pressure depends on whether or not the module has the optional display.

If the module does not have a digital display:

1. Turn on the pump and, using N₂ or air, allow vacuum chamber pressure to descend to a pressure that is lower than 10⁻⁴ Torr (1.3 x 10⁻⁵ kPa, 1.3 x 10⁻⁴ mbar).
2. Use a high-precision, high-input impedance ($Z_{in} > 1\text{ M}\Omega$) DVM to measure the voltage across the MONITOR ANALOG and MONITOR COMMON test points on the module front panel.
3. Use a flat-head instrument screwdriver to adjust the ADJUST VACUUM potentiometer to a reading of 0.375 Vdc.

If the module has a digital display:

1. Turn on the pump and, using N₂ or air, allow vacuum chamber pressure to descend to a pressure that is lower than 10⁻⁴ Torr (1.3 x 10⁻⁵ kPa, 1.3 x 10⁻⁴ mbar).
2. When the display indicates pressure is 0.00 mTorr, use a flat-head instrument screwdriver to adjust the ADJUST VAC potentiometer to a reading of 0.375 Vdc.

3.7 Modules Operating at Low Pressure

During a fast pumpdown from atmospheric pressure, thermal effects temporarily prevent the module from measuring pressure accurately below 1 x 10⁻³ Torr (1.3 x 10⁻⁴ kPa, 1.3 x 10⁻³ mbar). After approximately 15 minutes, pressure indications the 1 x 10⁻⁴ Torr (1.3 x 10⁻⁵ kPa, 1.3 x 10⁻⁴ mbar) range will be accurate.

When pressure indication in the 1 x 10⁻⁴ Torr (1.3 x 10⁻⁵ kPa, 1.3 x 10⁻⁴ mbar) range has stabilized, a Convectron gauge calibration at vacuum chamber pressure may be performed.

The calibration may be performed at a higher pressure if readings in the 1 x 10⁻⁴ Torr (1.3 x 10⁻⁵ kPa, 1.3 x 10⁻⁴ mbar) range are not required. In the 1 x 10⁻⁴ Torr (1.3 x 10⁻⁵ kPa, 1.3 x 10⁻⁴ mbar) range, resolution is ±0.1 millitorr, if the Convectron gauge has been properly calibrated at vacuum chamber pressure. If the module frequently operates in the 1 x 10⁻⁴ Torr (1.3 x 10⁻⁵ kPa, 1.3 x 10⁻⁴ mbar) range, Convectron gauge calibration at vacuum chamber pressure should be performed frequently.

3.8 Factory Settings

Table 3-9 lists factory relay setpoint values.

Table 3-9 Factory Settings for Relays

Parameter	Factory Setting
Setpoint	Below 0.0 vacuum chamber pressure
State	Deactivated
Returning pressure hysteresis	<ul style="list-style-type: none">• 2% of reading for module without display• 10% of reading + 1 significant digit for module with optional display
Activation direction	Activates below vacuum chamber pressure setpoint, not programmable

4.1 Customer Service

If the product requires service, contact the MKS Technical Support Department at 1-303-652-4400 or 1-800-776-6543 for troubleshooting help over the phone.

If the product must be returned to the factory for service, request a Return Material Authorization (RMA) from MKS, which can be completed at <https://www.mksinst.com/service/servicehome.aspx>. Do not return products without first obtaining an RMA. In most cases a hazardous materials disclosure form is required. The MKS Customer Service Representative will advise you if the hazardous materials document is required.

When returning products to MKS, be sure to package the products to prevent shipping damage. Damaged returned products as a result of inadequate packaging is the Buyer's responsibility.

For Customer Service / Technical Support:

MKS Pressure and Vacuum Measurement Solutions

MKS Instruments, Inc.
6450 Dry Creek Parkway
Longmont, Colorado 80503 USA
Tel: 303-652-4400
Fax: 303-652-2844
Email: mks@mksinst.com

MKS Corporate Headquarters

MKS Instruments, Inc.
2 Tech Drive, Suite 201
Andover, MA 01810 USA
Tel: 978-645-5500
Fax: 978-557-5100
Email: mks@mksinst.com

Damage Requiring Service

Shut off power to the module and refer servicing to qualified service personnel under the following conditions:

- a. If any liquid has been spilled onto, or objects have fallen into, the module.
- b. If a circuit board is faulty.
- c. If the Convectron gauge sensing wire is open or the gauge is contaminated.
- d. If the module has been exposed to moisture.
- e. If the module does not operate normally even if you follow the operating instructions. Adjust only those controls that are explained in this instruction manual. Improper adjustment of other controls may

result in damage and will often require extensive work by a qualified technician to restore the module to its normal operation.

- f. If the module has been dropped or the enclosure has been damaged.
- g. If the module exhibits a distinct change in performance.

4.2 Troubleshooting

If any of the conditions described above have occurred, troubleshooting is required to determine the repairs that are necessary.

Precautions

Because the Convector gauge contains static-sensitive electronic parts, follow these precautions while troubleshooting:

- Use a grounded, conductive work surface. Wear a high impedance ground strap for personal protection.
- Do not operate the module with static sensitive devices or other components removed from the product.
- Do not handle static sensitive devices more than absolutely necessary, and only when wearing a ground strap.
- Rely on voltage measurements for troubleshooting module circuitry. Do not use an ohmmeter.
- Use a grounded, electrostatic discharge safe soldering iron.



WARNING

Substitution or modifying parts can result in serious product damage or personal injury due to electrical shock or fire.

- Install only those replacement parts that are specified by Helix Technology.
- Do not install substitute parts or perform any unauthorized modification to the module.
- Do not use the module if unauthorized modifications have been made.



WARNING

Failure to perform a safety check after the module has been repaired can result in serious property damage or personal injury due to electrical shock or fire.

If the module has been repaired, before putting it back into operation, make sure qualified service personnel perform a safety check.

Symptoms, Causes, and Solutions

Table 4-1 lists failure symptoms, causes, and solutions.

Table 4-1 Failure Symptoms, Causes, and Solutions

Symptom	Possible Causes	Solution
Output voltage = 0 V	11.5 to 26.5 V power supply cable is improperly connected or faulty.	Repair or replace power supply cable (see page 19).
Pressure reading is too high.	<ul style="list-style-type: none"> Conductance in connection to vacuum chamber is inadequate. Plumbing to module leaks or is contaminated. Chamber pressure is too high due to leak, contamination, or pump failure. Power supply or output cable is improperly connected or faulty. 	<ul style="list-style-type: none"> If conductance is inadequate, reconnect Convector gauge port to vacuum chamber (see page 18). If plumbing leaks or is contaminated, clean, repair or replace plumbing. If pump failed, repair or replace it. If cable is improperly connected or faulty, repair or replace cable (see page 19).
Pressure reading is inaccurate.	<ul style="list-style-type: none"> Module is not calibrated for the process gas that is being used. Module is not mounted horizontally. Convector gauge or differential pressure sensor is damaged (for example, by reactive gas) or contaminated. Temperature or mechanical vibration is extreme. 	<ul style="list-style-type: none"> If Convector gauge is out of calibration, recalibrate it (see page 44). If module is not mounted horizontally, re-mount it (see page 17). If Convector gauge is damaged, replace it (see page 53). If Convector gauge is contaminated, return it to factory (see pages 53 and 53). If temperature or vibration is extreme, relocate module or eliminate source of heat or vibration.
Indicated pressure is different than pressure indications from other measurement devices.	<ul style="list-style-type: none"> Process gas is a not the gas that the user anticipated using in the system. Convector gauge is defective. 	<ul style="list-style-type: none"> If the process gas is not what was anticipated, calibrate Convector gauge for gas that is being used (see page 44). If Convector gauge is defective, return it to factory (see pages 53 and 53).
Relay LED indicator is ON, but relay is not functioning.	Relay contacts are defective.	Make sure relay load is within specified rating and is non-inductive (see page 56).
<ul style="list-style-type: none"> Relay will not activate. Output voltage is < 0.10 V. 	<ul style="list-style-type: none"> A circuit board is faulty. Convector gauge sensing wire is open. 	Return module to factory (see page 53).

4.3 Convectron Gauge Test

**CAUTION**

Performing a Convectron gauge test with instruments that apply more than 0.1 V with the gauge at vacuum chamber pressure can result in property damage.

Do not perform a Convectron gauge test with an instrument that applies more than 0.1 V of electromotive force.

Even a small amount of voltage can damage the small diameter sensing wire inside the Convectron gauge.

To determine if the Convectron gauge sensing wire has been damaged, follow these instructions:

1. Remove the Convectron gauge as instructed on page 53.
2. Use a *low-voltage (maximum 0.1 V) ohmmeter* to check resistance values across the pins on the base of the gauge. Pin numbers are embossed on the base. Figure 4-1 illustrates the base of the gauge.

The resistance across the pins should be within the ranges listed in Figure 4-1. If resistance across pins 1 and 2 is not approximately 20 to 30 Ω or if other listed resistance values are greater than the listed values, the gauge is defective. Install a replacement Convectron gauge as instructed on page 53.

Figure 4-1 Convectron Gauge Pins



- Pins 1 to 2: 19 to 22 ohms
- Pins 2 to 3: 50 to 60 ohms
- Pins 1 to 5: 180 to 185 ohms

If the resistance from pins 1 to 2 reads about 800 ohms, the sensor wire in the gauge is broken. Replace the gauge tube.

Note: If the resistance values shown here are correct, but you still think the gauge is not reading correctly, the gold plating on the sensor wire may be eroded and the gauge will have to be replaced.

4.4 Convectron Gauge Removal and Replacement



WARNING

Removing or replacing the Convectron gauge in a high-voltage environment can cause an electrical discharge through a gas or plasma, resulting in serious property damage or personal injury due to electrical shock.

Vent the vacuum chamber to atmospheric pressure and shut off power to the module before you remove or replace the Convectron gauge.

Removing the Convectron Gauge

To avoid contaminating the Convectron gauge, wear sterile gloves during the removal procedure.

1. Vent the vacuum chamber to atmospheric pressure and *shut off power to the module*.
2. Use the fitting to detach the module from the vacuum chamber.
3. Remove the four Phillips-head screws from both module end plates, but do not remove the hex nuts that hold the D subminiature connector in place.
4. Remove the end plate that does *not* have a connector, then remove both sides of the blue housing.
5. *Carefully* unplug the Convectron gauge from the spring-loaded sockets in the printed circuit board.

Replacing the Convectron Gauge

To avoid contaminating the Convectron gauge, wear sterile gloves during the replacement procedure.

1. *Shut off power to the module*.
2. Align the gauge pins so they mate with spring-loaded sockets in the printed circuit board. *Carefully* insert the Convectron gauge pins into the sockets.
3. Position the end plates and put both blue parts of the housing into place, making sure the gauge grounding springs and cradles are in line with the gauge envelope.
4. Re-install the Phillips-head screws into the end plates.
5. Use the fitting to re-attach the module to the vacuum chamber.

Appendix A Specifications

Pressure Measurement

Measurement Range for Air or N₂	Torr	1 x 10 ⁻⁴ to 1000
	mbar	1 x 10 ⁻⁴ to 1333
	Pascal	1 x 10 ⁻² to 1.33 x 10 ⁵
Resolution	Torr	1 x 10 ⁻⁴
	mbar	1 x 10 ⁻⁴
	Pascal	1 x 10 ⁻²

Measurements will change with different gases and mixtures. Do not use the module with flammable or explosive gases. The module is factory calibrated for use on N₂. It also measures the pressure of air correctly within the accuracy specification for the instrument. If the module will measure the pressure of a gas other than N₂ or air, you must adjust relays for the process gas.

Temperature Limits

Operating Temperature	+0 to +40 °C (+32 to +104 °F) ambient, non-condensing
Non-operating Temperature	-40 to +70 °C (-40 to +158 °F)

Power Requirements and Electrical Connections

Power Requirements

<i>With optional display</i>	11.5 to 26.5 Vdc, 0.15 A at 11.5 Vdc, 3.5 W maximum
<i>Without display</i>	11.5 to 26.5 Vdc, 0.1 A at 11.5 Vdc, 1.6 W maximum

I/O connectors

<i>2 setpoint relays</i>	15-pin male, high-density subminiature D
<i>1 setpoint relay</i>	9-pin male, subminiature D

Relays and outputs

Setpoint Relays

<i>Relay type</i>	Single-pole, double-throw (SPDT), Form A
<i>Contact rating</i>	1 A at 30 Vdc resistive, 30 VAC non-inductive
<i>Range</i>	Torr 1×10^{-3} to 1000 mbar 1×10^{-3} to 1333 Pascal 1×10^{-1} to 1.33×10^5
<i>Hysteresis</i>	2% of reading for module without display 10% of reading plus 1 significant digit for module with optional display
<i>Resolution</i>	Two significant digits

Analog Output

0.375 to 5.659 Vdc for 0 to 1000 Torr of N₂, non-linear
0 to 1333 mbar of N₂, non-linear
0 to 1.33×10^{-1} kPa of N₂, non-linear

Mini-Convectron Gauge

Sensing Wire Filament	Gold-plated tungsten (standard) or solid platinum (optional)
Internal Volume	40 cc (2.5 cu in.)
Materials Exposed to Vacuum	304 stainless steel, gold, borosilicate glass, kovar, alumina, NiFe alloy, polyimide
Bakeout Temperature	150 °C (302 °F) maximum, non-operating, with electronics removed

Physical Characteristics

Mounting Position	Horizontal axis (see page 17)
Case Material	Powder-coated extruded aluminum
Weight	340 g (12 oz.) with 1/8 NPT fitting
IP Rating	IP20

Dimensions

Dimensions are in cm (in.)

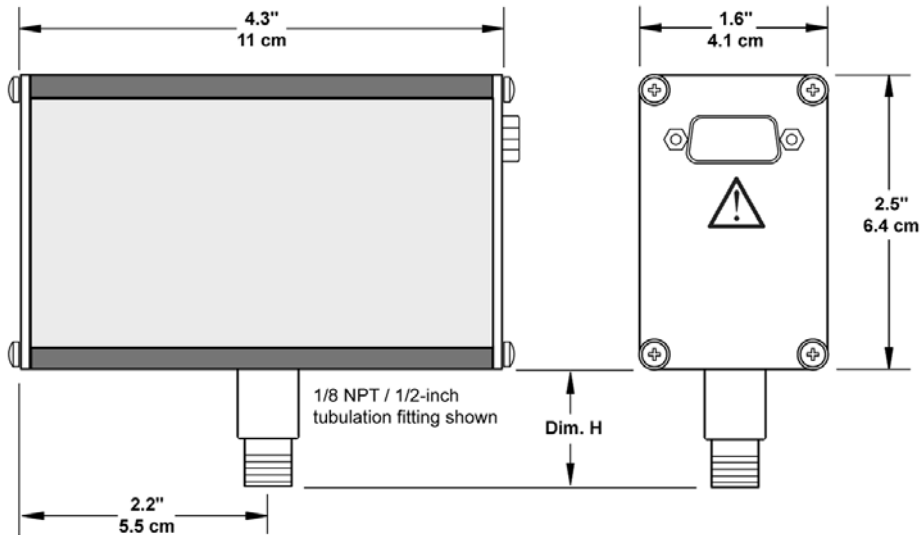

Vacuum Connections	Dim. H	
	cm	in.
1/8 NPT pipe thread, 1/2-inch inside diameter	2.2	0.9
1/2-inch 4 VCR® type fitting, female	3.0	1.2
1/2-inch 8 VCR type fitting, female	3.9	1.5
NW16KF flange	3.1	1.2
NW25KF flange	3.1	1.2
NW40KF flange	3.7	1.5
1.33-inch (NW16CF) ConFlat® flange	3.8	1.5
2.75-inch (NW35CF) ConFlat flange	3.8	1.5

Optional Display

Pressure Units

Torr or mTorr

Pressure Value

Green 3-digit LED, automatic ranging from Torr to mTorr

Appendix B Theory of Operation

The module measures gas pressures from 1×10^{-4} Torr to 1000 Torr. Vacuum chamber pressure is measured by a Convector convection-enhanced Pirani heat-loss gauge.

The Convector gauge operates like a standard Pirani gauge, which employs the principle of a Wheatstone bridge to convert pressure to voltage, but uses convection cooling to enable accurate pressure measurement, when properly calibrated, from 10^{-4} to 1000 Torr.

The sensing wire is an ultra-fine strand of gold-plated tungsten or solid platinum. The heated sensing wire loses more heat as the ambient gas pressure increases. The more molecules contact the sensing wire, the more power is required to keep the sensing wire at a constant temperature. So, as pressure increases, the voltage across the Wheatstone bridge also increases.

The Convector gauge has a temperature compensator, which causes bridge voltage to remain unaffected by changes in ambient temperature.

Figure B-1 is a diagram of the module controller. The Convector gauge sensing wire is designated R_1 in the Wheatstone bridge circuit. The temperature compensator is designated R_2 . At bridge null, the following equation applies:

$$R_1 = \frac{R_2 + R_3}{R_4}$$

Bridge voltage is a non-linear function of pressure. This relationship is illustrated in Figure B-1. If the ambient temperature does not change, R_1 remains constant.

Figure B-1 Wheatstone Bridge Diagram

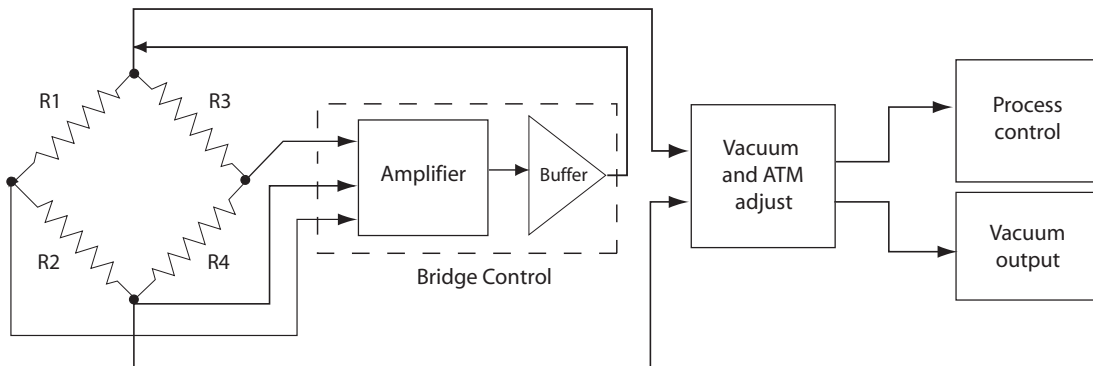

As vacuum chamber pressure decreases, the number of molecules in the vacuum chamber and the resulting heat loss from the sensing wire also decrease. Temperature and R_1 resistance therefore increase.

The increased resistance through R_1 causes the bridge to become unbalanced and a voltage to develop across the null terminals. The bridge controller senses the null voltage and decreases the voltage across the bridge until the null voltage again equals zero. When the bridge voltage decreases, the power dissipation in the sensing wire decreases, causing R_1 resistance to decrease to its previous value.

A pressure increase causes an opposing series of occurrences, during which the bridge controller increases the bridge voltage to maintain a zero null voltage.

A

- Analog output
 - voltage versus commonly used gas pressure **28**
 - voltage versus N₂ or air pressure **29–31**
 - voltage versus other gas pressure **28**
 - wiring **19**

Appendixes

- Specifications **55**
- Theory of Operation **59**

B

- Before you begin **9**

C

- Calibration
 - at atmospheric pressure **44**
 - at vacuum chamber pressure **46**
 - Convectron gauge **21**
- Caution and warning statements **10**
- Chapters
 - Before you Begin **9**
 - Installation **13**
 - Maintenance **49**
 - Operation **23**
- Commonly used gases **28**
- Components of module
 - with one relay, no display **13, 25**
 - with two relays, no display **13, 26**
 - with two relays, optional display **14, 24**
- Connecting cable **19**
- Connections to vacuum chamber **16, 57**
- Convectron gauge
 - calibration at atmospheric pressure **44**
 - calibration at vacuum chamber pressure **46**
 - internal volume **56**
 - Pins **52**
 - removal **53**
 - replacement **53**
 - sensing wire filament **56**
 - setpoint relays **39–43**
 - test **52**
- Customer service **9, 49**

D

- Damage requiring service **49**

F

- Factory settings for module **47**

Figures

- 15-pin connector, module with two relays **19**
- 9-pin connector, module with one relay **19**
- Convectron gauge base **52**
- example test point voltage **42–43**
- ground connection to vacuum chamber **20**
- module dimensions **16**
- module orientation **17**
- module with one relay, no display **25**
- module with optional display **14**
- module with two relays, no display **24, 26**
- module without display **13**
- output voltage versus N₂ or air pressure
 - 0.1 Torr to 1000 Torr **31**
 - 1 mTorr to 100 mTorr **30**
- setpoint relay behavior **39**
- true pressure versus indicated pressure
 - 10⁻¹ to 1000 Torr **34–35**
 - 10⁻⁴ to 10⁻¹ Torr **33, 36, 37, 38**
- Wheatstone bridge diagram **59**

Fittings

- 1/8 NPT pipe thread **18**
- ConFlat flange fitting **18**
- KF flange **18**
- VCR type **18**

Front panel features

- with one relay, no display **25**
- with one relay, optional display **24**
- with two relays, no display **26**

G

Ground

- connection to vacuum chamber **20**
- wiring **20**

I

I/O connector

- 15-pin for module with two relays **19**
- 9-pin for module with one relay **19**

Implosion / Explosion **11**

Indicators

analog setpoints **24, 25, 26**

Installation **13**

attaching module to vacuum chamber **18**

calibrating Convectron gauge **21**

configuring relays for application **21**

locating and orienting module **15**

module components **13**

mounting position **56**

pressure relief devices **14**

wiring **19**

Instructions

about **9**

installation **13**

maintenance **49**

module operation **23**

L

LETHAL VOLTAGES **11**

M

Maintenance **49**

Convectron Gauge Pins **52**

Convectron gauge removal **53**

Convectron gauge replacement **53**

Convectron gauge test **52**

customer service **49**

damage requiring service **49**

failure symptoms, causes, and solutions **51**

troubleshooting **50**

troubleshooting precautions **50**

Module

analog output **28**

analog output from **28**

analog output specifications **56**

attaching to vacuum chamber **18**

components

with one relay, no display **13, 25**

with two relays, no display **13, 26**

with two relays, optional display **14, 24**

dimensions **57**

front panel features

with one relay, no display **25**

with two relays, no display **26**

with two relays, optional display **24**

location **15**

operation **23**

operation at low pressure **46**

orientation **17**

other gases **28**

physical characteristics **56**

power supply **55**

preparing to operate **23**

setpoint relays **39–43**

temperature **55**

O

Operation

analog output **28**

at low pressure **46**

preparing module **23**

setpoint relay behavior **39**

setpoint relays **39–43**

tasks and page references for **27**

Optional display

power supply voltage for **55**

specifications **57**

P

Potentiometers

Convectron ATM adjust **24, 25, 26**

Convectron VAC adjust **24, 25, 26**

Diaphragm ATM zero adjust **24, 25, 26**

setpoint 1 adjust **24, 25, 26**

setpoint 2 adjust **24, 25, 26**

Power supply

voltage with optional display **31, 55**

voltage without optional display **55**

wiring **19**

Precautions for troubleshooting **50**

Pressure

atmospheric at altitude/pressure/voltage relationships **45**

relief devices **14**

true versus indicated **33–35, 37–??, 38–??**

versus analog output voltage **29–32**

R

Reading and following instructions **12**

Reading setpoints **44**

Relief devices **14**

S

Setpoint relays

behavior **39**

configuring for application **21**

contact rating **56**

reading **44**

test point voltage versus pressure **42–43**

type **56**

wiring **19**

Specifications **55**

analog output **56**

Convectron gauge internal volume **56**

Convectron gauge sensing wire **56**

I/O connector **55**

module dimensions **57**

mounting position **56**

optional display **57**

physical characteristics **56**

power supply **55**

setpoint relays **56**

temperature **55**

vacuum connections **16, 57**

System Grounding **11**

T

Temperature

non-operating **55**

operating **55**

Testing Convectron gauge **52**

Theory of operation **59**

Troubleshooting **50**

failure symptoms, causes, and solutions **51**

precautions **50**

V

Vacuum chamber

1/8 NPT pipe thread fitting **18**

attaching module to **18**

ConFlat flange **18**

connections **16, 57**

ground connection to **20**

KF flange fitting **18**

VCR type fitting **18**

Voltage

analog output versus pressure **29–32**

example test point **42–43**

power supply with optional display **31, 55**

power supply without optional display **55**

W

Wiring

analog output **19**

connecting cable **19**

ground connection to vacuum chamber **20**

grounding **20**

I/O connector

module with one relay **19**

module with two relays **19**

specifications **55**

installation **19**

power supply **19**

terminals **19**

Series 275

Mini-Convectron® Vacuum Gauge Module with Nonlinear Analog Outputs and Process Control Relays



Customer Service / Technical Support:

MKS Pressure and Vacuum Measurement Solutions

MKS Instruments, Inc.
6450 Dry Creek Parkway
Longmont, Colorado 80503 USA
Tel: 303-652-4400
Fax: 303-652-2844
Email: mks@mksinst.com

MKS Corporate Headquarters

MKS Instruments, Inc.
2 Tech Drive, Suite 201
Andover, MA 01810 USA
Tel: 978-645-5500
Fax: 978-557-5100
Email: mks@mksinst.com

Instruction Manual

Instruction manual part number 275512

Revision E - July 2017