



**MKS Baratron®
Type 722A
Absolute Pressure Transducer
Instruction Manual**

2 Technology Drive
Andover, MA, USA 01810

Main: 978.645.5500
USA: 800.227.8766
www.mksinst.com

119475-P1
Revision E, 3/13
Instruction Manual



WARRANTY

Type 722A Equipment

MKS Instruments, Inc. (**MKS**) warrants that for two years from the date of shipment the equipment described above (the "equipment") manufactured by **MKS** shall be free from defects in materials and workmanship and will correctly perform all date-related operations, including without limitation accepting data entry, sequencing, sorting, comparing, and reporting, regardless of the date the operation is performed or the date involved in the operation, provided that, if the equipment exchanges data or is otherwise used with equipment, software, or other products of others, such products of others themselves correctly perform all date-related operations and store and transmit dates and date-related data in a format compatible with **MKS** equipment. THIS WARRANTY IS **MKS'** SOLE WARRANTY CONCERNING DATE-RELATED OPERATIONS.

For the period commencing with the date of shipment of this equipment and ending two years later, **MKS** will, at its option, either repair or replace any part which is defective in materials or workmanship or with respect to the date-related operations warranty without charge to the purchaser. The foregoing shall constitute the exclusive and sole remedy of the purchaser for any breach by **MKS** of this warranty.

The purchaser, before returning any equipment covered by this warranty, which is asserted to be defective by the purchaser, shall make specific written arrangements with respect to the responsibility for shipping the equipment and handling any other incidental charges with the **MKS** sales representative or distributor from which the equipment was purchased or, in the case of a direct purchase from **MKS**, with the **MKS** home office in Andover, Massachusetts, USA.

This warranty does not apply to any equipment which has not been installed and used in accordance with the specifications recommended by **MKS** for the proper and normal use of the equipment. **MKS** shall not be liable under any circumstances for indirect, special, consequential, or incidental damages in connection with, or arising out of, the sale, performance, or use of the equipment covered by this warranty.

MKS recommends that all **MKS** pressure and flow products be calibrated periodically (typically every 6 to 12 months) to ensure accurate readings. When a product is returned to **MKS** for this periodic re-calibration it is considered normal preventative maintenance not covered by any warranty.

THIS WARRANTY IS IN LIEU OF ALL OTHER RELEVANT WARRANTIES, EXPRESSED OR IMPLIED, INCLUDING THE IMPLIED WARRANTY OF MERCHANTABILITY AND THE IMPLIED WARRANTY OF FITNESS FOR A PARTICULAR PURPOSE, AND ANY WARRANTY AGAINST INFRINGEMENT OF ANY PATENT.

SPECIAL NOTICE

This warranty is void if the product is installed using single or double metal ferrule compression type vacuum fittings, shown below. These fittings are commonly tightened incorrectly, causing damage to the pressure sensor.

Single Ferrule

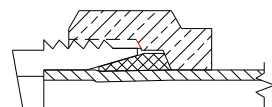

Double Ferrule

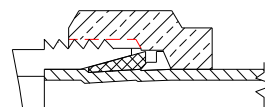

MKS Baratron®
Type 722A
Absolute Pressure Transducer

Copyright © 2013 by MKS Instruments, Inc.

All rights reserved. No part of this work may be reproduced or transmitted in any form or by any means, electronic or mechanical, including photocopying and recording, or by any information storage or retrieval system, except as may be expressly permitted in writing by MKS Instruments, Inc.

Baratron® is a registered trademark of MKS Instruments, Inc., Andover, MA, USA.

VCR® and VCO® are registered trademarks of Swagelok Company, Solon, OH, USA.

Inconel® and Incoloy® are registered trademarks of Inco Alloys International, Inc., Huntington, WV, USA.

Some Baratron® products may not be exported to many end user countries without both US and local government export licenses under ECCN 2B230.

Table of Contents

Pressure Transducer Safety Information	9
Symbols Used in This Instruction Manual.....	9
Symbols Found on the Unit	10
Safety Procedures and Precautions	11
Sicherheitshinweise für den Druckmeßumformer	13
In dieser Betriebsanleitung vorkommende Symbole	13
Erklärung der am Gerät angebrachten Symbole	14
Sicherheitsvorschriften und Vorsichtsmaßnahmen.....	15
Informations relatives à la sécurité pour le transducteur de pression	17
Symboles utilisés dans ce manuel d'utilisation	17
Symboles apparaissant sur l'unité	18
Mesures de sécurité et précautions	19
Medidas de seguridad del transductor de presión	21
Símbolos usados en este manual de instrucciones	21
Símbolos hallados en la unidad.....	22
Procedimientos y precauciones de seguridad	23
Chapter One: General Information	25
Introduction.....	25
How This Manual is Organized	26
Customer Support	26
Chapter Two: Installation	27
How To Unpack the Type 722A Unit.....	27
Unpacking Checklist.....	27
Product Location and Requirements.....	28
Operating Environmental Requirements.....	28
Dimensions	28
Setup	31
Mounting.....	31
Fittings	32

Making Mechanical Connections	32
Connectors	33
How to Wire a PDR-C and PDR-D Series Readout to a Type 722A Transducer with a 9-pin Type “D” Connector.....	35
Electrical Information	36
NW-16-KF Fitting Information	36
Interface Cables	38
Attaching the Terminal Block Connector Cable.....	40
How To Check the Transducer Zero.....	41
How To Zero the 722A Transducer	41
Span Adjustment.....	42
Chapter Three: Overview.....	45
General Information.....	45
Sensor.....	45
Signal Conditioning Electronics	46
Label	46
Chapter Four: Operation	47
General.....	47
Lowest Suggested Pressure Available for Reading	47
Lowest Suggested Pressure to Use for Control.....	47
Chapter Five: Maintenance and Troubleshooting.....	49
General.....	49
Zero Adjustment	49
Troubleshooting	50
Appendix A: Product Specifications.....	51
Performance Specifications	51
Physical Specifications	51
NW-16-KF Fitting Information	52
Electrical Specifications.....	52
Appendix B: Model Code Explanation.....	53
Model Code.....	53
NW-16-KF Fitting Information	55

Index57

List of Figures and Tables

Figures

Figure 1: Dimensions of the Low Pressure (up to 1000 Torr) Type 722A Transducer	29
Figure 2: Fitting Dimensions for the Low Pressure Type 722A Transducer	29
Figure 3: Dimensions of the High Pressure (>1000 to 25,000 Torr) Type 722A Transducer	30
Figure 4: Fitting Dimensions of the High Pressure Type 722A Transducer.....	30
Figure 5: Vertical Mounting Positions.....	31
Figure 6: Acceptable Horizontal Mounting Position	31
Figure 7: Electrical Scheme for a Voltage Unit.....	36
Figure 8: How To Connect the Cable to a Terminal Block (Example 1)	40
Figure 9: How To Connect the Cable to a Terminal Block (Example 2)	40
Figure 10: Product Label	46

Tables

Table 1: Definition of Symbols Found on the Unit	10
Tabelle 2: Bedeutung der am Gerät angebrachten Symbole	14
Tableau 3: Définition des symboles apparaissant sur l'unité	18
Tabla 4: Definición de los símbolos hallados en la unidad.....	22
Table 5: Pinout of the 9-Pin Type “D” Connector.....	33
Table 6: Pinout of the 5-Pin Terminal Block Connector	33
Table 7: Pinout of the 15-Pin Type “D” Connector.....	34
Table 8: Connections Between a Transducer with a Type “D” Connector and a PDR-C /- D Readout	35
Table 9: Interface Cables	38
Table 10: Highest Pressure for Proper Zero Adjustment	42
Table 11: Suggested Pressures for Reading and Control	47
Table 12: Troubleshooting Chart	50

Pressure Transducer Safety Information

Symbols Used in This Instruction Manual

Definitions of WARNING, CAUTION, and NOTE messages used throughout the manual.

Warning



The **WARNING** sign denotes a hazard to personnel. It calls attention to a procedure, practice, condition, or the like, which, if not correctly performed or adhered to, could result in injury to personnel.

Caution



The **CAUTION** sign denotes a hazard to equipment. It calls attention to an operating procedure, practice, or the like, which, if not correctly performed or adhered to, could result in damage to or destruction of all or part of the product.

Note



The **NOTE** sign denotes important information. It calls attention to a procedure, practice, condition, or the like, which is essential to highlight.

Symbols Found on the Unit

The following table describes symbols that may be found on the unit.





















Definition of Symbols Found on the Unit			
  Off (Supply) IEC 417, No.5008	 Off (Supply) IEC 417, No.5008	  Protective earth (ground) IEC 417, No.5019	 Protective earth (ground) IEC 417, No.5019
   Direct current IEC 417, No.5021	  Direct current IEC 417, No.5021	  Direct current IEC 417, No.5021	 Alternating current IEC 417, No.5032
 Both direct and alternating current IEC 417, No.5033-a	  Three phase alternating current IEC 617-2 No.020206	 Three phase alternating current IEC 617-2 No.020206	
 Caution, refer to accompanying documents ISO 3864, No.B.3.1	 Caution, risk of electric shock ISO 3864, No.B.3.6	 Caution, hot surface IEC 417, No.5041	

Table 1: Definition of Symbols Found on the Unit

Safety Procedures and Precautions

Observe the following general safety precautions during all phases of operation of this instrument. Failure to comply with these precautions or with specific warnings elsewhere in this manual violates safety standards of intended use of the instrument and may impair the protection provided by the equipment. MKS Instruments, Inc. assumes no liability for the customer's failure to comply with these requirements.

DO NOT SUBSTITUTE PARTS OR MODIFY INSTRUMENT

Do not install substitute parts or perform any unauthorized modification to the instrument. Return the instrument to an MKS Calibration and Service Center for service and repair to ensure that all safety features are maintained.

SERVICE BY QUALIFIED PERSONNEL ONLY

Operating personnel must not attempt component replacement and internal adjustments. Any service must be made by qualified service personnel only.

USE CAUTION WHEN OPERATING WITH HAZARDOUS MATERIALS

If hazardous materials are used, users must take responsibility to observe the proper safety precautions, completely purge the instrument when necessary, and ensure that the material used is compatible with the materials in this product, including any sealing materials.

PURGE THE INSTRUMENT

After installing the unit, or before removing it from a system, purge the unit completely with a clean, dry gas to eliminate all traces of the previously used flow material.

USE PROPER PROCEDURES WHEN PURGING

This instrument must be purged under a ventilation hood, and gloves must be worn for protection.

DO NOT OPERATE IN AN EXPLOSIVE ENVIRONMENT

To avoid explosion, do not operate this product in an explosive environment unless it has been specifically certified for such operation.

USE PROPER FITTINGS AND TIGHTENING PROCEDURES

All instrument fittings must be consistent with instrument specifications, and compatible with the intended use of the instrument. Assemble and tighten fittings according to manufacturer's directions.

CHECK FOR LEAK-TIGHT FITTINGS

Carefully check all vacuum component connections to ensure leak-tight installation.

OPERATE AT SAFE INLET PRESSURES

Never operate at pressures higher than the rated maximum pressure (refer to the product specifications for the maximum allowable pressure).

INSTALL A SUITABLE BURST DISC

When operating from a pressurized gas source, install a suitable burst disc in the vacuum system to prevent system explosion should the system pressure rise.

KEEP THE UNIT FREE OF CONTAMINANTS

Do not allow contaminants to enter the unit before or during use. Contamination such as dust, dirt, lint, glass chips, and metal chips may permanently damage the unit or contaminate the process.

ALLOW PROPER WARM UP TIME FOR TEMPERATURE-CONTROLLED UNITS

Temperature-controlled units will only meet specifications when sufficient time is allowed for the unit to meet, and stabilize at, the designed operating temperature. Do not zero or calibrate the unit until the warm up is complete.

Sicherheitshinweise für den Druckmeßumformer

In dieser Betriebsanleitung vorkommende Symbole

Bedeutung der mit WARNUNG!, VORSICHT! und HINWEIS gekennzeichneten Absätze in dieser Betriebsanleitung.

Warnung!



Das Symbol **WARNUNG!** weist auf eine Gefahr für das Bedienpersonal hin. Es macht auf einen Arbeitsablauf, eine Arbeitsweise, einen Zustand oder eine sonstige Gegebenheit aufmerksam, deren unsachgemäße Ausführung bzw. ungenügende Berücksichtigung zu Verletzungen führen kann.

Vorsicht!



Das Symbol **VORSICHT!** weist auf eine Gefahr für das Gerät hin. Es macht auf einen Bedienungsablauf, eine Arbeitsweise oder eine sonstige Gegebenheit aufmerksam, deren unsachgemäße Ausführung bzw. ungenügende Berücksichtigung zu einer Beschädigung oder Zerstörung des Gerätes oder von Teilen des Gerätes führen kann.

Hinweis



Das Symbol **HINWEIS** macht auf wichtige Informationen bezüglich eines Arbeitsablaufs, einer Arbeitsweise, eines Zustands oder einer sonstige Gegebenheit aufmerksam.

Erklärung der am Gerät angebrachten Symbole

Nachstehender Tabelle sind die Bedeutungen der Symbole zu entnehmen, die am Gerät angebracht sein können.















Bedeutung der am Gerät angebrachten Symbole			
			
Ein (Energie) IEC 417, No.5007	Aus (Energie) IEC 417, No.5008	Erdanschluß IEC 417, No.5017	Schutzleiteranschluß IEC 417, No.5019
			
Masseanschluß IEC 417, No.5020	Aquipotential- anschluß IEC 417, No.5021	Gleichstrom IEC 417, No.5031	Wechselstrom IEC 417, No.5032
			
Gleich- oder Wechselstrom IEC 417, No.5033-a	Durchgängige doppelte oder verstärkte Isolierung IEC 417, No.5172-a	Dreileiter- Wechselstrom (Drehstrom) IEC 617-2, No.020206	
			
Warnung vor einer Gefahrenstelle (Achtung, Dokumen- tation beachten) ISO 3864, No.B.3.1	Warnung vor gefährlicher elektrischer Spannung ISO 3864, No.B.3.6	Höhere Temperatur an leicht zugänglichen Teilen IEC 417, No.5041	

Tabelle 2: Bedeutung der am Gerät angebrachten Symbole

Sicherheitsvorschriften und Vorsichtsmaßnahmen

Folgende allgemeine Sicherheitsvorschriften sind während allen Betriebsphasen dieses Gerätes zu befolgen. Eine Mißachtung der Sicherheitsvorschriften und sonstiger Warnhinweise in dieser Betriebsanleitung verletzt die für dieses Gerät und seine Bedienung geltenden Sicherheitsstandards, und kann die Schutzvorrichtungen an diesem Gerät wirkungslos machen. MKS Instruments, Inc. haftet nicht für Mißachtung dieser Sicherheitsvorschriften seitens des Kunden.

Niemals Teile austauschen oder Änderungen am Gerät vornehmen!

Ersetzen Sie keine Teile mit baugleichen oder ähnlichen Teilen, und nehmen Sie keine eigenmächtigen Änderungen am Gerät vor. Schicken Sie das Gerät zwecks Wartung und Reparatur an den MKS-Kalibrierungs- und -Kundendienst ein. Nur so wird sichergestellt, daß alle Schutzvorrichtungen voll funktionsfähig bleiben.

Wartung nur durch qualifizierte Fachleute!

Das Auswechseln von Komponenten und das Vornehmen von internen Einstellungen darf nur von qualifizierten Fachleuten durchgeführt werden, niemals vom Bedienpersonal.

Vorsicht beim Arbeiten mit gefährlichen Stoffen!

Wenn gefährliche Stoffe verwendet werden, muß der Bediener die entsprechenden Sicherheitsvorschriften genauestens einhalten, das Gerät, falls erforderlich, vollständig spülen, sowie sicherstellen, daß der Gefahrstoff die am Gerät verwendeten Materialien, insbesondere Dichtungen, nicht angreift.

Spülen des Gerätes mit Gas!

Nach dem Installieren oder vor dem Ausbau aus einem System muß das Gerät unter Einsatz eines reinen Trockengases vollständig gespült werden, um alle Rückstände des Vorgängermediums zu entfernen.

Anweisungen zum Spülen des Gerätes

Das Gerät darf nur unter einer Ablufthaube gespült werden. Schutzhandschuhe sind zu tragen.

Gerät nicht zusammen mit explosiven Stoffen, Gasen oder Dämpfen benutzen!

Um der Gefahr einer Explosion vorzubeugen, darf dieses Gerät niemals zusammen mit (oder in der Nähe von) explosiven Stoffen aller Art eingesetzt werden, sofern es nicht ausdrücklich für diesen Zweck zugelassen ist.

Anweisungen zum Installieren der Armaturen!

Alle Anschlußstücke und Armaturenteile müssen mit der Gerätespezifikation übereinstimmen, und mit dem geplanten Einsatz des Gerätes kompatibel sein. Der Einbau, insbesondere das Anziehen und Abdichten, muß gemäß den Anweisungen des Herstellers vorgenommen werden.

Verbindungen auf Undichtigkeiten prüfen!

Überprüfen Sie sorgfältig alle Verbindungen der Vakuumkomponenten auf undichte Stellen.

Gerät nur unter zulässigen Anschlußdrücken betreiben!

Betreiben Sie das Gerät niemals unter Drücken, die den maximal zulässigen Druck (siehe Produktspezifikationen) übersteigen.

Geeignete Berstscheibe installieren!

Wenn mit einer unter Druck stehenden Gasquelle gearbeitet wird, sollte eine geeignete Berstscheibe in das Vakuumsystem installiert werden, um eine Explosionsgefahr aufgrund von steigendem Systemdruck zu vermeiden.

Verunreinigungen im Gerät vermeiden!

Stellen Sie sicher, daß Verunreinigungen jeglicher Art weder vor dem Einsatz noch während des Betriebs in das Instrumenteninnere gelangen können. Staub- und Schmutzpartikel, Glassplitter oder Metallspäne können das Gerät dauerhaft beschädigen oder Prozeß und Meßwerte verfälschen.

Bei Geräten mit Temperaturkontrolle korrekte Anwärmzeit einhalten!

Temperaturkontrollierte Geräte arbeiten nur dann gemäß ihrer Spezifikation, wenn genügend Zeit zum Erreichen und Stabilisieren der Betriebstemperatur eingeräumt wird. Kalibrierungen und Nulleinstellungen sollten daher nur nach Abschluß des Anwärmvorgangs durchgeführt werden.

Informations relatives à la sécurité pour le transducteur de pression

Symboles utilisés dans ce manuel d'utilisation

Définitions des indications AVERTISSEMENT, ATTENTION, et REMARQUE utilisées dans ce manuel.

Avertissement



L'indication **AVERTISSEMENT** signale un danger pour le personnel. Elle attire l'attention sur une procédure, une pratique, une condition, ou toute autre situation présentant un risque d'accident pour le personnel, en cas d'exécution incorrecte ou de non respect des consignes.

Attention



L'indication **ATTENTION** signale un danger pour l'appareil. Elle attire l'attention sur une procédure d'exploitation, une pratique, ou toute autre situation, présentant un risque d'endommagement ou de destruction d'une partie ou de la totalité de l'appareil, en cas d'exécution incorrecte ou de non respect des consignes.

Remarque



L'indication **REMARQUE** signale une information importante. Elle attire l'attention sur une procédure, une pratique, une condition, ou toute autre situation, présentant un intérêt particulier.

Symboles apparaissant sur l'unité

Le tableau suivant décrit les symboles pouvant apparaître sur l'unité.















Définition des symboles apparaissant sur l'unité			
 Marche (sous tension) IEC 417, No.5007	 Arrêt (hors tension) IEC 417, No.5008	 Terre (masse) IEC 417, No.5017	 Terre de protection (masse) IEC 417, No.5019
 Masse IEC 417, No.5020	 Equipotentialité IEC 417, No.5021	 Courant continu IEC 417, No.5031	 Courant alternatif IEC 417, No.5032
 Courant continu et alternatif IEC 417, No.5033-a	 Matériel de classe II IEC 417, No.5172-a	 Courant alternatif triphasé IEC 617-2, No.020206	
 Attention : se reporter à la documentation ISO 3864, No.B.3.1	 Attention : risque de choc électrique ISO 3864, No.B.3.6	 Attention : surface brûlante IEC 417, No.5041	

Tableau 3: Définition des symboles apparaissant sur l'unité

Mesures de sécurité et précautions

Prendre les précautions générales de sécurité suivantes pendant toutes les phases d'exploitation de cet appareil. Le non respect de ces précautions ou des avertissements contenus dans ce manuel constitue une violation des normes de sécurité relatives à l'utilisation de l'appareil et peut diminuer la protection fournie par l'appareil. MKS Instruments, Inc. n'assume aucune responsabilité concernant le non respect des consignes par les clients.

PAS DE SUBSTITUTION DE PIÈCES OU DE MODIFICATION DE L'APPAREIL

Ne pas installer des pièces de substitution ou effectuer des modifications non autorisées sur l'appareil. Renvoyer l'appareil à un centre de service et de calibrage MKS pour tout dépannage ou réparation afin de garantir l'intégrité des dispositifs de sécurité.

DÉPANNAGE UNIQUEMENT PAR DU PERSONNEL QUALIFIÉ

Le personnel d'exploitation ne doit pas essayer de remplacer des composants ou de faire des réglages internes. Tout dépannage doit être uniquement effectué par du personnel qualifié.

PRÉCAUTION EN CAS D'UTILISATION AVEC DES PRODUITS DANGEREUX

Si des produits dangereux sont utilisés, l'utilisateur est responsable de la prise des mesures de précaution appropriées, de la purge complète de l'appareil quand cela est nécessaire, et de la garantie que les produits utilisés sont compatibles avec les composants de cet appareil, y compris les matériaux d'étanchéité.

PURGE DE L'APPAREIL

Après l'installation de l'unité, ou avant son enlèvement d'un système, purger l'unité complètement avec un gaz propre et sec afin d'éliminer toute trace du produit de flux utilisé précédemment.

UTILISATION DES PROCÉDURES APPROPRIÉES POUR LA PURGE

Cet appareil doit être purgé sous une hotte de ventilation, et il faut porter des gants de protection.

PAS D'EXPLOITATION DANS UN ENVIRONNEMENT EXPLOSIF

Pour éviter toute explosion, ne pas utiliser cet appareil dans un environnement explosif, sauf en cas d'homologation spécifique pour une telle exploitation.

UTILISATION D'ÉQUIPEMENTS APPROPRIÉS ET PROCÉDURES DE SERRAGE

Tous les équipements de l'appareil doivent être cohérents avec ses spécifications, et compatibles avec l'utilisation prévue de l'appareil. Assembler et serrer les équipements conformément aux directives du fabricant.

VÉRIFICATION DE L'ÉTANCHÉITÉ DES CONNEXIONS

Vérifier attentivement toutes les connexions des composants pour le vide afin de garantir l'étanchéité de l'installation.

EXPLOITATION AVEC DES PRESSIONS D'ENTRÉE NON DANGEREUSES

Ne jamais utiliser des pressions supérieures à la pression nominale maximum (se reporter aux spécifications de l'unité pour la pression maximum admissible).

INSTALLATION D'UN DISQUE D'ÉCHAPPEMENT ADAPTÉ

En cas d'exploitation avec une source de gaz pressurisé, installer un disque d'échappement adapté dans le système à vide, afin d'éviter une explosion du système en cas d'augmentation de la pression.

MAINTIEN DE L'UNITÉ À L'ABRI DES CONTAMINATIONS

Ne pas laisser des produits contaminants pénétrer dans l'unité avant ou pendant l'utilisation. Des produits contaminants tels que des poussières et des fragments de tissu, de glace et de métal peuvent endommager l'unité d'une manière permanente ou contaminer le processus.



RESPECT DU TEMPS D'ÉCHAUFFEMENT APPROPRIÉ POUR LES UNITÉS À TEMPÉRATURE CONTRÔLÉE

Les unités à température contrôlée atteignent leurs spécifications uniquement quand on leur laisse un temps suffisant pour atteindre d'une manière stable la température d'exploitation. Ne pas remettre à zéro ou calibrer l'unité tant que l'échauffement n'est pas terminé.

Medidas de seguridad del transductor de presión

Símbolos usados en este manual de instrucciones

Definiciones de los mensajes de advertencia, precaución y de las notas usados en el manual.

Advertencia		El símbolo de advertencia indica la posibilidad de que se produzcan daños personales. Pone de relieve un procedimiento, práctica, estado, etc. que en caso de no realizarse u observarse correctamente puede causar daños personales.
Precaución		El símbolo de precaución indica la posibilidad de producir daños al equipo. Pone de relieve un procedimiento operativo, práctica, estado, etc. que en caso de no realizarse u observarse correctamente puede causar daños o la destrucción total o parcial del equipo.
Nota		El símbolo de notas indica información de importancia. Este símbolo pone de relieve un procedimiento, práctica o condición cuyo conocimiento es esencial destacar.

Símbolos hallados en la unidad

La tabla siguiente contiene los símbolos que puede hallar en la unidad.















Definición de los símbolos hallados en la unidad			
			
Encendido (alimentación eléctrica) IEC 417, N° 5007	Apagado (alimentación eléctrica) IEC 417, N° 5008	Puesta a tierra IEC 417, N° 5017	Protección a tierra IEC 417, N° 5019
			
Caja o chasis IEC 417, N° 5020	Equipotencialidad IEC 417, N° 5021	Corriente continua IEC 417, N° 5031	Corriente alterna IEC 417, N° 5032
			
Corriente continua y alterna IEC 417, N° 5033-a	Equipo de clase II IEC 417, N° 5172-a	Corriente alterna trifásica IEC 617-2, N° 020206	
			
Precaución. Consulte los documentos adjuntos ISO 3864, N° B.3.1	Precaución. Riesgo de descarga eléctrica ISO 3864, N° B.3.6	Precaución. Superficie caliente IEC 417, N° 5041	

Tabla 4: Definición de los símbolos hallados en la unidad

Procedimientos y precauciones de seguridad

Las precauciones generales de seguridad descritas a continuación deben observarse durante todas las etapas de funcionamiento del instrumento. La falta de cumplimiento de dichas precauciones o de las advertencias específicas a las que se hace referencia en el manual, constituye una violación de las normas de seguridad establecidas para el uso previsto del instrumento y podría anular la protección proporcionada por el equipo. Si el cliente no cumple dichas precauciones y advertencias, MKS Instruments, Inc. no asume responsabilidad legal alguna.

NO UTILICE PIEZAS NO ORIGINALES O MODIFIQUE EL INSTRUMENTO

No instale piezas que no sean originales ni modifique el instrumento sin autorización. Para asegurar el correcto funcionamiento de todos los dispositivos de seguridad, envíe el instrumento al Centro de servicio y calibración de MKS toda vez que sea necesario repararlo o efectuar tareas de mantenimiento.

LAS REPARACIONES DEBEN SER EFECTUADAS ÚNICAMENTE POR TÉCNICOS AUTORIZADOS

Los operarios no deben intentar reemplazar los componentes o realizar tareas de ajuste en el interior del instrumento. Las tareas de mantenimiento o reparación deben ser realizadas únicamente por personal autorizado.

TENGA CUIDADO CUANDO TRABAJE CON MATERIALES TÓXICOS

Cuando se utilicen materiales tóxicos, es responsabilidad de los operarios tomar las medidas de seguridad correspondientes, purgar totalmente el instrumento cuando sea necesario y comprobar que el material utilizado sea compatible con los materiales del instrumento e inclusive, con todos los materiales de sellado.

PURGUE EL INSTRUMENTO

Una vez instalada la unidad o antes de retirarla del sistema, purgue completamente la unidad con gas limpio y seco para eliminar todo resto de la sustancia líquida empleada anteriormente.

USE PROCEDIMIENTOS ADECUADOS PARA REALIZAR LA PURGA

El instrumento debe purgarse debajo de una campana de ventilación y deben utilizarse guantes protectores.

NO HAGA FUNCIONAR EL INSTRUMENTO EN AMBIENTES CON RIESGO DE EXPLOSIÓN

Para evitar que se produzcan explosiones, no haga funcionar este instrumento en un ambiente con riesgo de explosiones, excepto cuando el mismo haya sido certificado específicamente para tal uso.

USE ACCESORIOS ADECUADOS Y REALICE CORRECTAMENTE LOS PROCEDIMIENTOS DE AJUSTE

Todos los accesorios del instrumento deben cumplir las especificaciones del mismo y ser compatibles con el uso que se debe dar al instrumento. Arme y ajuste los accesorios de acuerdo con las instrucciones del fabricante.

COMPRUEBE QUE LAS CONEXIONES SEAN A PRUEBA DE FUGAS

Inspeccione cuidadosamente las conexiones de los componentes de vacío para comprobar que hayan sido instalados a prueba de fugas.

HAGA FUNCIONAR EL INSTRUMENTO CON PRESIONES DE ENTRADA SEGURAS

No haga funcionar nunca el instrumento con presiones superiores a la máxima presión nominal (en las especificaciones del instrumento hallará la presión máxima permitida).

INSTALE UNA CÁPSULA DE SEGURIDAD ADECUADA

Cuando el instrumento funcione con una fuente de gas presurizado, instale una cápsula de seguridad adecuada en el sistema de vacío para evitar que se produzcan explosiones cuando suba la presión del sistema.

MANTENGA LA UNIDAD LIBRE DE CONTAMINANTES

No permita el ingreso de contaminantes en la unidad antes o durante su uso. Los productos contaminantes tales como polvo, suciedad, pelusa, lascas de vidrio o virutas de metal pueden dañar irreparablemente la unidad o contaminar el proceso.

CALIENTE ADECUADAMENTE LAS UNIDADES CONTROLADAS POR MEDIO DE TEMPERATURA

Las unidades controladas por medio de temperatura funcionarán de acuerdo con las especificaciones sólo cuando se las caliente durante el tiempo suficiente para permitir que lleguen y se estabilicen a la temperatura de operación indicada. No calibre la unidad y no la ponga en cero hasta que finalice el procedimiento de calentamiento.

Chapter One: General Information

Introduction

Note

Some Baratron® products may not be exported to many end user countries without both US and local government export licenses under ECCN 2B230.

The Baratron® Type 722A Absolute Pressure Transducer offers the proven technology of the Baratron transducer in a smaller package. The unit provides an accuracy of 0.5% of Reading and carries a CE Mark to indicate full compliance with the EMC Directive 2004/108/EEC.

The 722A transducer is available with a selection of options.

- *Range:* 1 Torr through 25,000 Torr (0.2 psia through 500 psia)
- *Fittings:* ½" tube, 4-VCR®, 8-VCR®, 8-VCO®, Mini-CF, and NW-16-KF
- *Connectors:* 5-pin terminal block, 9-pin Type "D", and 15-pin Type "D" on a six inch length of cable

Refer to *Appendix A: Product Specifications*, page 51, for a complete list of product specifications. The model code of your transducer specifies the options chosen. Refer to *Appendix B: Model Code Explanation*, page 53, for more information on the model code.

How This Manual is Organized

This manual is designed to provide instructions on how to set up, install, and operate a Type 722A unit.

Before installing your Type 722A unit in a system and/or operating it, carefully read and familiarize yourself with all precautionary notes in the *Safety Messages and Procedures* section at the front of this manual. In addition, observe and obey all WARNING and CAUTION notes provided throughout the manual.

Pressure Transducer Safety Information

Symbols Used in This Instruction Manual

Definitions of WARNING, CAUTION, and NOTE messages used throughout the manual.

Warning



The WARNING sign denotes a hazard to personnel. It calls attention to a procedure, practice, condition, or the like, which, if not correctly performed or adhered to, could result in injury to personnel.

Caution

The CAUTION sign denotes a hazard to equipment. It calls attention to an operating procedure, practice, or the like, which, if not correctly performed or adhered to, could result in damage to or destruction of all or part of the product.

Note

The NOTE sign denotes important information. It calls attention to a procedure, practice, condition, or the like, which is essential to highlight.

Symbols Found on the Unit

The following table describes symbols that may be found on the unit.





















Definition of Symbols Found on the Unit			
  Off (Supply) IEC 417, No.5008	 Off (Supply) IEC 417, No.5008	  Protective earth (ground) IEC 417, No.5019	 Protective earth (ground) IEC 417, No.5019
   Direct current IEC 417, No.5021	  Direct current IEC 417, No.5021	  Alternating current IEC 417, No.5032	 Alternating current IEC 417, No.5032
 Both direct and alternating current IEC 417, No.5033-a	  Three phase alternating current IEC 617-2 No.020206	 Three phase alternating current IEC 617-2 No.020206	
 Caution, refer to accompanying documents ISO 3864, No.B.3.1	 Caution, risk of electric shock ISO 3864, No.B.3.6	 Caution, hot surface IEC 417, No.5041	

Table 1: Definition of Symbols Found on the Unit

Safety Procedures and Precautions

Observe the following general safety precautions during all phases of operation of this instrument. Failure to comply with these precautions or with specific warnings elsewhere in this manual violates safety standards of intended use of the instrument and may impair the protection provided by the equipment. MKS Instruments, Inc. assumes no liability for the customer's failure to comply with these requirements.

DO NOT SUBSTITUTE PARTS OR MODIFY INSTRUMENT

Do not install substitute parts or perform any unauthorized modification to the instrument. Return the instrument to an MKS Calibration and Service Center for service and repair to ensure that all safety features are maintained.

SERVICE BY QUALIFIED PERSONNEL ONLY

Operating personnel must not attempt component replacement and internal adjustments. Any service must be made by qualified service personnel only.

USE CAUTION WHEN OPERATING WITH HAZARDOUS MATERIALS

If hazardous materials are used, users must take responsibility to observe the proper safety precautions, completely purge the instrument when necessary, and ensure that the material used is compatible with the materials in this product, including any sealing materials.

PURGE THE INSTRUMENT

After installing the unit, or before removing it from a system, purge the unit completely with a clean, dry gas to eliminate all traces of the previously used flow material.

USE PROPER PROCEDURES WHEN PURGING

This instrument must be purged under a ventilation hood, and gloves must be worn for protection.

DO NOT OPERATE IN AN EXPLOSIVE ENVIRONMENT

To avoid explosion, do not operate this product in an explosive environment unless it has been specifically certified for such operation.

USE PROPER FITTINGS AND TIGHTENING PROCEDURES

All instrument fittings must be consistent with instrument specifications, and compatible with the intended use of the instrument. Assemble and tighten fittings according to manufacturer's directions.

CHECK FOR LEAK-TIGHT FITTINGS

Carefully check all vacuum component connections to ensure leak-tight installation.

OPERATE AT SAFE INLET PRESSURES

Never operate at pressures higher than the rated maximum pressure (refer to the product specifications for the maximum allowable pressure).

INSTALL A SUITABLE BURST DISC

When operating from a pressurized gas source, install a suitable burst disc in the vacuum system to prevent system explosion should the system pressure rise.

KEEP THE UNIT FREE OF CONTAMINANTS

Do not allow contaminants to enter the unit before or during use. Contamination such as dust, dirt, lint, glass chips, and metal chips may permanently damage the unit or contaminate the process.

ALLOW PROPER WARM UP TIME FOR TEMPERATURE-CONTROLLED UNITS

Temperature-controlled units will only meet specifications when sufficient time is allowed for the unit to meet, and stabilize at, the designed operating temperature. Do not zero or calibrate the unit until the warm up is complete.

Sicherheitshinweise für den Druckmeßumformer

In dieser Betriebsanleitung vorkommende Symbole

Bedeutung der mit **WARNUNG!**, **VORSICHT!** und **HINWEIS** gekennzeichneten Absätze in dieser Betriebsanleitung.

Warnung!



Das Symbol **WARNUNG!** weist auf eine Gefahr für das Bedienpersonal hin. Es macht auf einen Arbeitsablauf, eine Arbeitsweise, einen Zustand oder eine sonstige Gegebenheit aufmerksam, deren unsachgemäße Ausführung bzw. ungenügende Berücksichtigung zu Verletzungen führen kann.

Vorsicht!

Das Symbol **VORSICHT!** weist auf eine Gefahr für das Gerät hin. Es macht auf einen Bedienungsablauf, eine Arbeitsweise oder eine sonstige Gegebenheit aufmerksam, deren unsachgemäße Ausführung bzw. ungenügende Berücksichtigung zu einer Beschädigung oder Zerstörung des Gerätes oder von Teilen des Gerätes führen kann.

Hinweis

Das Symbol **HINWEIS** macht auf wichtige Informationen bezüglich eines Arbeitsablaufs, einer Arbeitsweise, eines Zustands oder einer sonstige Gegebenheit aufmerksam.

Erklärung der am Gerät angebrachten Symbole

Nachstehender Tabelle sind die Bedeutungen der Symbole zu entnehmen, die am Gerät angebracht sein können.















Bedeutung der am Gerät angebrachten Symbole			
			
Ein (Energie) IEC 417, No.5007	Aus (Energie) IEC 417, No.5008	Erdanschluß IEC 417, No.5017	Schutzleiteranschluß IEC 417, No.5019
			
Masseanschluß IEC 417, No.5020	Equipotential- anschluß IEC 417, No.5021	Gleichstrom IEC 417, No.5031	Wechselstrom IEC 417, No.5032
			
Gleich- oder Wechselstrom IEC 417, No.5033-a	Durchgängige doppelte oder verstärkte Isolierung IEC 417, No.5172-a	Dreileiter- Wechselstrom (Drehstrom) IEC 617-2, No.020206	
			
Warnung vor einer Gefahrenstelle (Achtung, Dokumen- tation beachten) ISO 3864, No.B.3.1	Warnung vor gefährlicher elektrischer Spannung ISO 3864, No.B.3.6	Höhere Temperatur an leicht zugänglichen Teilen IEC 417, No.5041	

Tabelle 2: Bedeutung der am Gerät angebrachten Symbole

Sicherheitsvorschriften und Vorsichtsmaßnahmen

Folgende allgemeine Sicherheitsvorschriften sind während allen Betriebsphasen dieses Gerätes zu befolgen. Eine Mißachtung der Sicherheitsvorschriften und sonstiger Warnhinweise in dieser Betriebsanleitung verletzt die für dieses Gerät und seine Bedienung geltenden Sicherheitsstandards, und kann die Schutzvorrichtungen an diesem Gerät wirkungslos machen. MKS Instruments, Inc. haftet nicht für Mißachtung dieser Sicherheitsvorschriften seitens des Kunden.

Niemals Teile austauschen oder Änderungen am Gerät vornehmen!

Ersetzen Sie keine Teile mit baugleichen oder ähnlichen Teilen, und nehmen Sie keine eigenmächtigen Änderungen am Gerät vor. Schicken Sie das Gerät zwecks Wartung und Reparatur an den MKS-Kalibrierungs- und -Kundendienst ein. Nur so wird sichergestellt, daß alle Schutzvorrichtungen voll funktionsfähig bleiben.

Wartung nur durch qualifizierte Fachleute!

Das Auswechseln von Komponenten und das Vornehmen von internen Einstellungen darf nur von qualifizierten Fachleuten durchgeführt werden, niemals vom Bedienpersonal.

Vorsicht beim Arbeiten mit gefährlichen Stoffen!

Wenn gefährliche Stoffe verwendet werden, muß der Bediener die entsprechenden Sicherheitsvorschriften genauestens einhalten, das Gerät, falls erforderlich, vollständig spülen, sowie sicherstellen, daß der Gefahrstoff die am Gerät verwendeten Materialien, insbesondere Dichtungen, nicht angreift.

Spülen des Gerätes mit Gas!

Nach dem Installieren oder vor dem Ausbau aus einem System muß das Gerät unter Einsatz eines reinen Trockengases vollständig gespült werden, um alle Rückstände des Vorgängermediums zu entfernen.

Anweisungen zum Spülen des Gerätes

Das Gerät darf nur unter einer Ablufthaube gespült werden. Schutzhandschuhe sind zu tragen.

Gerät nicht zusammen mit explosiven Stoffen, Gasen oder Dämpfen benutzen!

Um der Gefahr einer Explosion vorzubeugen, darf dieses Gerät niemals zusammen mit (oder in der Nähe von) explosiven Stoffen aller Art eingesetzt werden, sofern es nicht ausdrücklich für diesen Zweck zugelassen ist.

Anweisungen zum Installieren der Armaturen!

Alle Anschlußstücke und Armaturenteile müssen mit der Gerätespezifikation übereinstimmen, und mit dem geplanten Einsatz des Gerätes kompatibel sein. Der Einbau, insbesondere das Anziehen und Abdichten, muß gemäß den Anweisungen des Herstellers vorgenommen werden.

Verbindungen auf Undichtigkeiten prüfen!

Überprüfen Sie sorgfältig alle Verbindungen der Vakuumkomponenten auf undichte Stellen.

Gerät nur unter zulässigen Anschlußdrücken betreiben!

Betreiben Sie das Gerät niemals unter Drücken, die den maximal zulässigen Druck (siehe Produktspezifikationen) übersteigen.

Geeignete Berstscheibe installieren!

Wenn mit einer unter Druck stehenden Gasquelle gearbeitet wird, sollte eine geeignete Berstscheibe in das Vakuumsystem installiert werden, um eine Explosionsgefahr aufgrund von steigendem Systemdruck zu vermeiden.

Verunreinigungen im Gerät vermeiden!

Stellen Sie sicher, daß Verunreinigungen jeglicher Art weder vor dem Einsatz noch während des Betriebs in das Instrumenteninnere gelangen können. Staub- und Schmutzpartikel, Glassplitter oder Metallspäne können das Gerät dauerhaft beschädigen oder Prozeß und Meßwerte verfälschen.

Bei Geräten mit Temperaturkontrolle korrekte Anwärmzeit einhalten!

Temperaturkontrollierte Geräte arbeiten nur dann gemäß ihrer Spezifikation, wenn genügend Zeit zum Erreichen und Stabilisieren der Betriebstemperatur eingeräumt wird. Kalibrierungen und Nulleinstellungen sollten daher nur nach Abschluß des Anwärmvorgangs durchgeführt werden.

Informations relatives à la sécurité pour le transducteur de pression

Symboles utilisés dans ce manuel d'utilisation

Définitions des indications AVERTISSEMENT, ATTENTION, et REMARQUE utilisées dans ce manuel.

Avertissement



L'indication **AVERTISSEMENT** signale un danger pour le personnel. Elle attire l'attention sur une procédure, une pratique, une condition, ou toute autre situation présentant un risque d'accident pour le personnel, en cas d'exécution incorrecte ou de non respect des consignes.

Attention

L'indication **ATTENTION** signale un danger pour l'appareil. Elle attire l'attention sur une procédure d'exploitation, une pratique, ou toute autre situation, présentant un risque d'endommagement ou de destruction d'une partie ou de la totalité de l'appareil, en cas d'exécution incorrecte ou de non respect des consignes.

Remarque

L'indication **REMARQUE** signale une information importante. Elle attire l'attention sur une procédure, une pratique, une condition, ou toute autre situation, présentant un intérêt particulier.

Symboles apparaissant sur l'unité

Le tableau suivant décrit les symboles pouvant apparaître sur l'unité.















Définition des symboles apparaissant sur l'unité			
			
Marche (sous tension) IEC 417, No.5007	Arrêt (hors tension) IEC 417, No.5008	Terre (masse) IEC 417, No.5017	Terre de protection (masse) IEC 417, No.5019
			
Masse IEC 417, No.5020	Equipotentialité IEC 417, No.5021	Courant continu IEC 417, No.5031	Courant alternatif IEC 417, No.5032
			
Courant continu et alternatif IEC 417, No.5033-a	Matériel de classe II IEC 417, No.5172-a	Courant alternatif triphase IEC 617-2, No.020206	
			
Attention : se reporter à la documentation ISO 3864, No.B.3.1	Attention : risque de choc électrique ISO 3864, No.B.3.6	Attention : surface brûlante IEC 417, No.5041	

Tableau 3: Définition des symboles apparaissant sur l'unité

Mesures de sécurité et précautions

Prendre les précautions générales de sécurité suivantes pendant toutes les phases d'exploitation de cet appareil. Le non respect de ces précautions ou des avertissements contenus dans ce manuel constitue une violation des normes de sécurité relatives à l'utilisation de l'appareil et peut diminuer la protection fournie par l'appareil. MKS Instruments, Inc. n'assume aucune responsabilité concernant le non respect des consignes par les clients.

PAS DE SUBSTITUTION DE PIÈCES OU DE MODIFICATION DE L'APPAREIL

Ne pas installer des pièces de substitution ou effectuer des modifications non autorisées sur l'appareil. Renvoyer l'appareil à un centre de service et de calibrage MKS pour tout dépannage ou réparation afin de garantir le l'intégrité des dispositifs de sécurité.

DÉPANNAGE UNIQUEMENT PAR DU PERSONNEL QUALIFIÉ

Le personnel d'exploitation ne doit pas essayer de remplacer des composants ou de faire des réglages internes. Tout dépannage doit être uniquement effectué par du personnel qualifié.

PRÉCAUTION EN CAS D'UTILISATION AVEC DES PRODUITS DANGEREUX

Si des produits dangereux sont utilisés, l'utilisateur est responsable de la prise des mesures de précaution appropriées, de la purge complète de l'appareil quand cela est nécessaire, et de la garantie que les produits utilisés sont compatibles avec les composants de cet appareil, y compris les matériaux d'étanchéité.

PURGE DE L'APPAREIL

Après l'installation de l'unité, ou avant son enlèvement d'un système, purger l'unité complètement avec un gaz propre et sec afin d'éliminer toute trace du produit de flux utilisé précédemment.

UTILISATION DES PROCÉDURES APPROPRIÉES POUR LA PURGE

Cet appareil doit être purgé sous une hotte de ventilation, et il faut porter des gants de protection.

PAS D'EXPLOITATION DANS UN ENVIRONNEMENT EXPLOSIF

Pour éviter toute explosion, ne pas utiliser cet appareil dans un environnement explosif, sauf en cas d'homologation spécifique pour une telle exploitation.

UTILISATION D'ÉQUIPEMENTS APPROPRIÉS ET PROCÉDURES DE SERRAGE

Tous les équipements de l'appareil doivent être cohérents avec ses spécifications, et compatibles avec l'utilisation prévue de l'appareil. Assembler et serrer les équipements conformément aux directives du fabricant.

VÉRIFICATION DE L'ÉTANCHÉITÉ DES CONNEXIONS

Vérifier attentivement toutes les connexions des composants pour le vide afin de garantir l'étanchéité de l'installation.

EXPLOITATION AVEC DES PRESSIONS D'ENTRÉE NON DANGEREUSES

Ne jamais utiliser des pressions supérieures à la pression nominale maximum (se reporter aux spécifications de l'unité pour la pression maximum admissible).

INSTALLATION D'UN DISQUE D'ÉCHAPPEMENT ADAPTÉ

En cas d'exploitation avec une source de gaz pressurisé, installer un disque d'échappement adapté dans le système à vide, afin d'éviter une explosion du système en cas d'augmentation de la pression.

MAINTIEN DE L'UNITÉ À L'ABRI DES CONTAMINATIONS

Ne pas laisser des produits contaminants pénétrer dans l'unité avant ou pendant l'utilisation. Des produits contaminants tels que des poussières et des fragments de tissu, de glace et de métal peuvent endommager l'unité d'une manière permanente ou contaminer le processus.

RESPECT DU TEMPS D'ÉCHAUFFEMENT APPROPRIÉ POUR LES UNITÉS À TEMPÉRATURE CONTRÔLÉE

Les unités à température contrôlée atteignent leurs spécifications uniquement quand on leur laisse un temps suffisant pour atteindre d'une manière stable la température d'exploitation. Ne pas remettre à zéro ou calibrer l'unité tant que l'échauffement n'est pas terminé.

Medidas de seguridad del transductor de presión

Símbolos usados en este manual de instrucciones

Definiciones de los mensajes de advertencia, precaución y de las notas usados en el manual.

Advertencia



El símbolo de advertencia indica la posibilidad de que se produzcan daños personales. Pone de relieve un procedimiento, práctica, estado, etc. que en caso de no realizarse u observarse correctamente puede causar daños personales.

Precaución

El símbolo de precaución indica la posibilidad de producir daños al equipo. Pone de relieve un procedimiento operativo, práctica, estado, etc. que en caso de no realizarse u observarse correctamente puede causar daños o la destrucción total o parcial del equipo.

Nota

El símbolo de notas indica información de importancia. Este símbolo pone de relieve un procedimiento, práctica o condición cuyo conocimiento es esencial destacar.

Símbolos hallados en la unidad

La tabla siguiente contiene los símbolos que puede hallar en la unidad.















Definición de los símbolos hallados en la unidad			
			
Encendido (alimentación eléctrica) IEC 417, N° 5007	Apagado (alimentación eléctrica) IEC 417, N° 5008	Puesta a tierra IEC 417, N° 5017	Protección a tierra IEC 417, N° 5019
			
Caja o chasis IEC 417, N° 5020	Equipotencialidad IEC 417, N° 5021	Corriente continua IEC 417, N° 5031	Corriente alterna IEC 417, N° 5032
			
Corriente continua y alterna IEC 417, N° 5033-a	Equipo de clase II IEC 417, N° 5172-a	Corriente alterna trifásica IEC 617-2, N° 020206	
			
Precaución. Consulte los documentos adjuntos ISO 3864, N° B.3.1	Precaución. Riesgo de descarga eléctrica ISO 3864, N° B.3.6	Precaución. Superficie caliente IEC 417, N° 5041	

Tabla 4: Definición de los símbolos hallados en la unidad

Procedimientos y precauciones de seguridad

Las precauciones generales de seguridad descritas a continuación deben observarse durante todas las etapas de funcionamiento del instrumento. La falta de cumplimiento de dichas precauciones o de las advertencias específicas a las que se hace referencia en el manual, constituye una violación de las normas de seguridad establecidas para el uso previsto del instrumento y podría anular la protección proporcionada por el equipo. Si el cliente no cumple dichas precauciones y advertencias, MKS Instruments, Inc. no asume responsabilidad legal alguna.

NO UTILICE PIEZAS NO ORIGINALES O MODIFIQUE EL INSTRUMENTO

No instale piezas que no sean originales ni modifique el instrumento sin autorización. Para asegurar el correcto funcionamiento de todos los dispositivos de seguridad, envíe el instrumento al Centro de servicio y calibración de MKS toda vez que sea necesario repararlo o efectuar tareas de mantenimiento.

LAS REPARACIONES DEBEN SER EFECTUADAS ÚNICAMENTE POR TÉCNICOS AUTORIZADOS

Los operarios no deben intentar reemplazar los componentes o realizar tareas de ajuste en el interior del instrumento. Las tareas de mantenimiento o reparación deben ser realizadas únicamente por personal autorizado.

TENGA CUIDADO CUANDO TRABAJE CON MATERIALES TÓXICOS

Cuando se utilicen materiales tóxicos, es responsabilidad de los operarios tomar las medidas de seguridad correspondientes, purgar totalmente el instrumento cuando sea necesario y comprobar que el material utilizado sea compatible con los materiales del instrumento e inclusive, con todos los materiales de sellado.

PURGUE EL INSTRUMENTO

Una vez instalada la unidad o antes de retirarla del sistema, purgue completamente la unidad con gas limpio y seco para eliminar todo resto de la sustancia líquida empleada anteriormente.

USE PROCEDIMIENTOS ADECUADOS PARA REALIZAR LA PURGA

El instrumento debe purgarse debajo de una campana de ventilación y deben utilizarse guantes protectores.

NO HAGA FUNCIONAR EL INSTRUMENTO EN AMBIENTES CON RIESGO DE EXPLOSIÓN

Para evitar que se produzcan explosiones, no haga funcionar este instrumento en un ambiente con riesgo de explosiones, excepto cuando el mismo haya sido certificado específicamente para tal uso.

USE ACCESORIOS ADECUADOS Y REALICE CORRECTAMENTE LOS PROCEDIMIENTOS DE AJUSTE

Todos los accesorios del instrumento deben cumplir las especificaciones del mismo y ser compatibles con el uso que se debe dar al instrumento. Arme y ajuste los accesorios de acuerdo con las instrucciones del fabricante.

COMPRUEBE QUE LAS CONEXIONES SEAN A PRUEBA DE FUGAS

Inspeccione cuidadosamente las conexiones de los componentes de vacío para comprobar que hayan sido instalados a prueba de fugas.

HAGA FUNCIONAR EL INSTRUMENTO CON PRESIONES DE ENTRADA SEGURAS

No haga funcionar nunca el instrumento con presiones superiores a la máxima presión nominal (en las especificaciones del instrumento hallará la presión máxima permitida).

INSTALE UNA CÁPSULA DE SEGURIDAD ADECUADA

Cuando el instrumento funcione con una fuente de gas presurizado, instale una cápsula de seguridad adecuada en el sistema de vacío para evitar que se produzcan explosiones cuando suba la presión del sistema.

MANTENGA LA UNIDAD LIBRE DE CONTAMINANTES

No permita el ingreso de contaminantes en la unidad antes o durante su uso. Los productos contaminantes tales como polvo, suciedad, pelusa, lascas de vidrio o virutas de metal pueden dañar irreparablemente la unidad o contaminar el proceso.

CALIENTE ADECUADAMENTE LAS UNIDADES CONTROLADAS POR MEDIO DE TEMPERATURA

Las unidades controladas por medio de temperatura funcionarán de acuerdo con las especificaciones sólo cuando se las caliente durante el tiempo suficiente para permitir que lleguen y se estabilicen a la temperatura de operación indicada. No calibre la unidad y no la ponga en cero hasta que finalice el procedimiento de calentamiento.

Chapter One: General Information, (this chapter) introduces the product and describes the organization of the manual.

Chapter Two: Installation, explains the environmental requirements and describes how to mount the instrument in your system.

Chapter Three: Overview, gives a brief description of the instrument and its functionality.

Chapter Four: Operation, describes how to use the instrument and explains all the functions and features.

Chapter Five: Maintenance and Troubleshooting, lists a few general practices to follow to ensure that the unit will perform optimally. It also includes a table of hints for reference in the event the unit malfunctions.

Appendix A: Product Specifications, lists the specifications of the instrument.

Appendix B: Model Code Explanation, describes the model code.

Customer Support

Standard maintenance and repair services are available at all of our regional MKS Calibration and Service Centers listed on the back cover. In addition, MKS accepts the instruments of other manufacturers for recalibration using the Primary and Transfer Standard calibration equipment located at all of our regional service centers. Should any difficulties arise in the use of your Type 722A instrument, or to obtain information about companion products MKS offers, contact any authorized MKS Calibration and Service Center. If it is necessary to return the instrument to MKS, please obtain an RMA (Return Material Authorization) Number from the MKS Calibration and Service Center before shipping. The RMA Number expedites handling and ensures proper servicing of your instrument.

Please refer to the inside of the back cover of this manual for a list of MKS Calibration and Service Centers.

Warning



All returns to MKS Instruments must be free of harmful, corrosive, radioactive, or toxic materials.

Chapter Two: Installation

How To Unpack the Type 722A Unit

MKS has carefully packed the Type 722A unit so that it will reach you in perfect operating order. Upon receiving the unit, however, you should check for defects, cracks, broken connectors, etc., to be certain that damage has not occurred during shipment.

Note

Do *not* discard any packing materials until you have completed your inspection and are sure the unit arrived safely.

If you find any damage, notify your carrier and MKS immediately. If it is necessary to return the unit to MKS, obtain an RMA (Return Material Authorization) Number from the MKS Service Center before shipping. Please refer to the inside of the back cover of this manual for a list of MKS Calibration and Service Centers.

Caution

Only qualified individuals should perform the installation and any user adjustments. They must comply with all the necessary ESD and handling precautions while installing and adjusting the instrument. Proper handling is essential when working with all highly sensitive precision electronic instruments.

Unpacking Checklist

Standard Equipment:

- Type 722A Unit
- Type 722A Instruction Manual (this book)

Optional Equipment:

- Electrical Connector Accessories Kit - 722A-K1 (includes a mating connector for the electrical connector)
- Most pressure, flow, flow ratio, and throttling valve controllers
- MKS Type 146, Type 660, Type PDR-C-1C, or Type PDR-C-2C power supply/readout unit, or PDR 2000 dual channel power supply/readout unit
- Cables to connect the 722A transducer to the above equipment

Product Location and Requirements

Operating Environmental Requirements

- Ambient Operating Temperature: 0° C to 50° C (32° F to 122° F),
15° C to 40° C(59° F to 104° F) 1 and 2 torr only.
- Ventilation requirements include sufficient air circulation

Dimensions

Note



All dimensions are listed in inches with millimeters referenced in parentheses.

The dimensions of the 722A transducer vary depending upon the full scale range:

Full scale ranges up to and including 1000 Torr: are referred to as “low pressure” transducers

Full scale ranges above 1000 Torr: are referred to as “high pressure” transducers

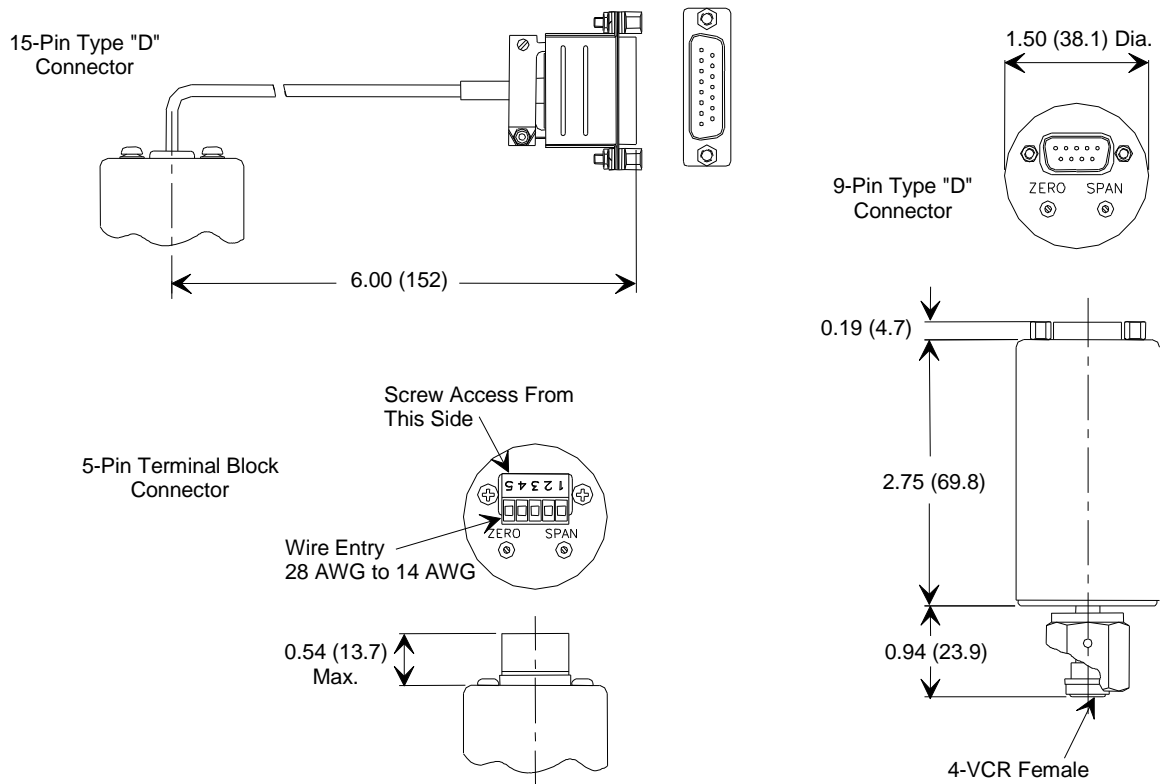

Figure 1: Dimensions of the Low Pressure (up to 1000 Torr) Type 722A Transducer

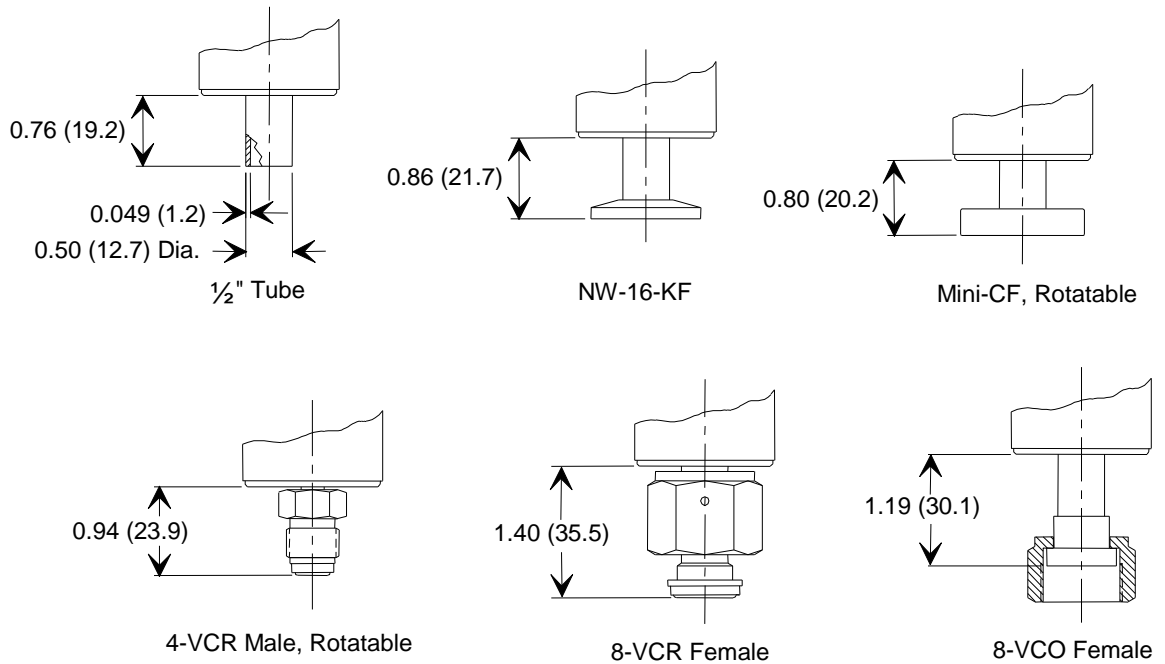

Figure 2: Fitting Dimensions for the Low Pressure Type 722A Transducer

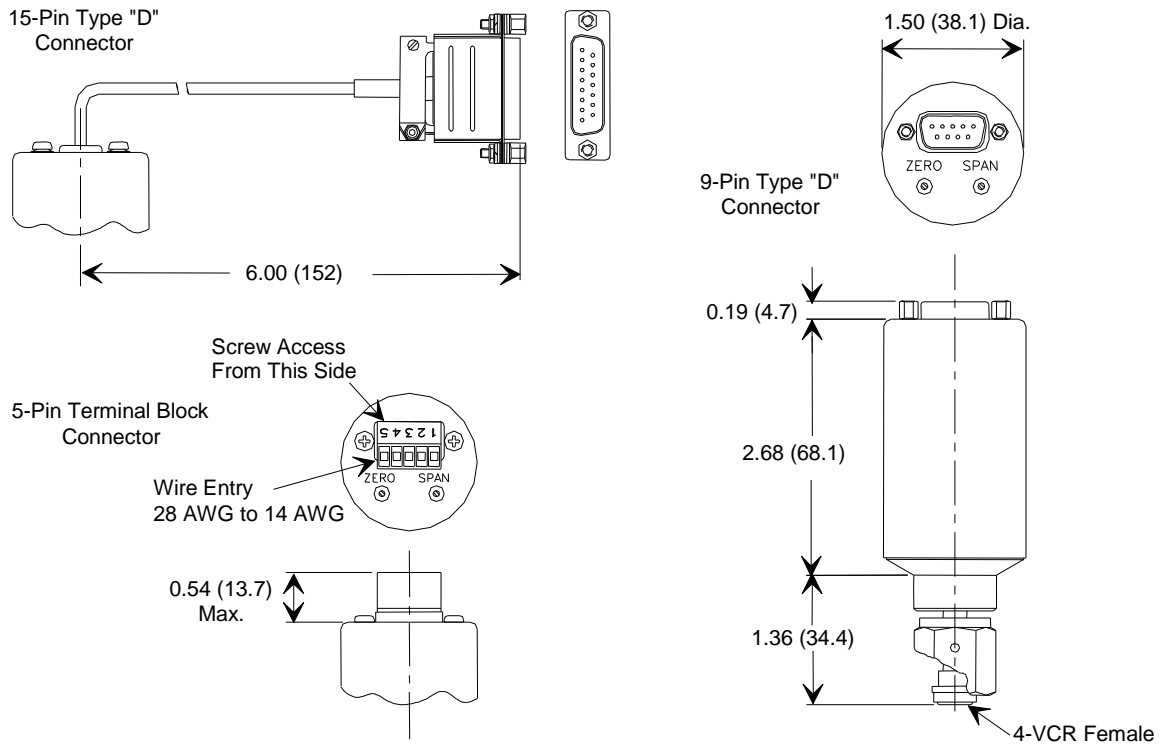

Figure 3: Dimensions of the High Pressure (>1000 to 25,000 Torr) Type 722A Transducer

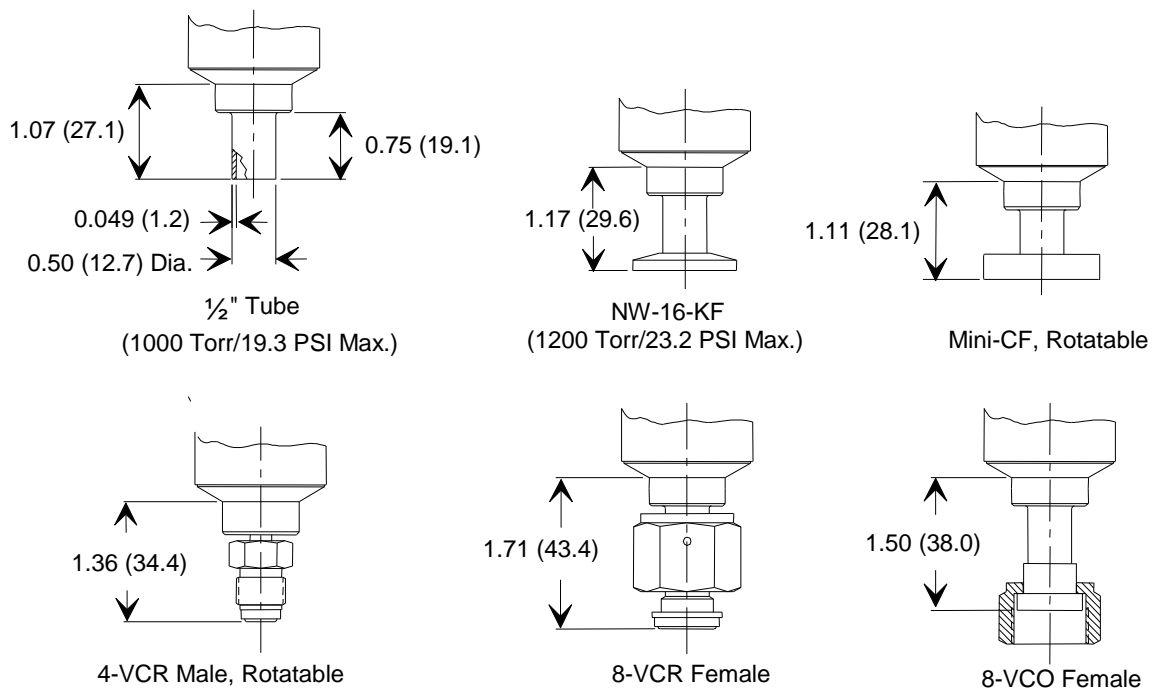

Figure 4: Fitting Dimensions of the High Pressure Type 722A Transducer

Setup

Mounting

The 722A transducer can be mounted with the cylindrical end in either a vertical (upright) or horizontal position. The mounting requirements allow any foreign matter entering the pressure port to fall *away from* the sensing diaphragm.

Mounting the Unit in a Vertical Position

If the unit is mounted in a vertical position, the cylindrical end of the unit must point upwards, as shown in Figure **Error! Bookmark not defined.**. Do not install the unit with the cylindrical end of the unit pointing downward because particulate impurities may accumulate on the sensing diaphragm and alter the pressure reading.

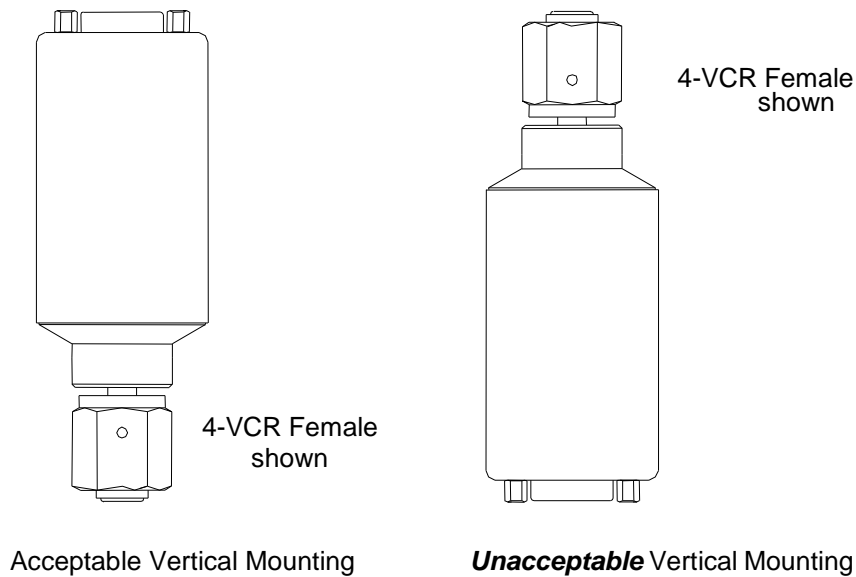

Figure 5: Vertical Mounting Positions

Mounting the Unit in a Horizontal Position

In a horizontal position, the cylindrical end of the unit can point in any direction.

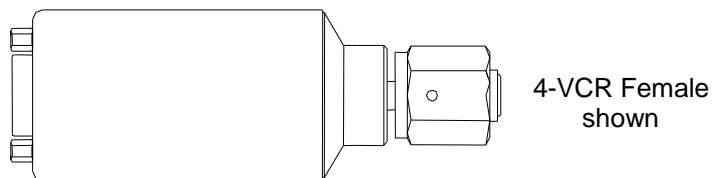

Figure 6: Acceptable Horizontal Mounting Position

Fittings

The 722A transducer is available with a variety of different fittings, listed below:

- ½" Tube
- 4-VCR® type Female
- 8-VCR® type Female
- 8-VCO® type Female
- NW-16-KF
- Mini-CF

Caution



-
1. MKS *does not warranty* the 722A transducer when single or double metal ferrule compression-type vacuum fittings are used because damage will occur to the transducer when improper tightening procedures are followed.
 2. Before proceeding to *Setup*, page 31, carefully check all plumbing connections to the instrument to ensure a leak-tight installation.
-

Making Mechanical Connections

To make mechanical connections in line to a system, use the recommended installation practices, as specified by the fitting manufacturer or by an appropriate standard.

Warning



Improper installation can cause personal injury or damage equipment. Follow proper installation procedures at all times.

How To Tighten Fitting Attachments

For VCR Fittings: Tighten 1/8 turn past the finger tight position for 316 SS or nickel gaskets (1/4 turn for copper or aluminum).

Connectors

The 722A transducer is available with a 9-pin Type “D”, a 5-pin terminal block connector, or a 15-pin Type “D” on a 6 inch cable

Note



A “No Connection” pin assignment means that the pin has no internal connection.

Pinout of the 9-Pin Type “D” Connector	
Pin	Assignment
1	Pressure Output
2	No Connection
3	No Connection
4	+ Power Input
5	No Connection
6	No Connection
7	No Connection
8	Pressure Return
9	Power Return

Table 5: Pinout of the 9-Pin Type “D” Connector

Pinout of the 5-Pin Terminal Block Connector	
Pin	Assignment
1	Power Return
2	Pressure Return
3	Pressure Output
4	No Connection
5	+ Power Input

Table 6: Pinout of the 5-Pin Terminal Block Connector

Pinout of the 15-Pin Type “D” Connector	
Pin	Assignment
1	No Connection
2	Pressure Output
3	No Connection
4	No Connection
5	Power Return
6	No Connection
7	+ Power Input
8	No Connection
9	No Connection
10	No Connection
11	No Connection
12	Pressure Return
13	No Connection
14	No Connection
15	Chassis

Table 7: Pinout of the 15-Pin Type “D” Connector

How to Wire a PDR-C and PDR-D Series Readout to a Type 722A Transducer with a 9-pin Type “D” Connector.

Caution



DO NOT use the -15 VDC output of the PDR-C and PDR-D readout to power the 722A transducer. When the -15 VDC signal of the PDR-C and PDR-D is connected to the power return of the transducer, a short between the -15 VDC of the transducer and the A GND of the PDR-C and PDR-D occurs. The PDR –C and PDR-D readout will blank out. Either unit may be damaged.

The correct cable to use to connect the 9 pin Type “D” connector to the PDR-C and PDR- D readout is a CB700-2 cable. This cable has the mating Type “D” connector on the transducer end and flying leads on the PDR-C and PDR-D end. Table 4 lists the pin assignments for the various colored wires on the flying leads end of the cable.

Connections Between a Transducer with a Type “D” Connector and a PDR-C/-D Readout			
Pin Number	Transducer Signal	Flying Lead Color Code	PDR Signal
1	Pressure Output	Red	Pressure Input
4	+ Power Input	Green	+ 15 VDC
8	Pressure Return	Black	Signal Ground (A GND)
9	Power Return	White	Power Ground (D GND)

Table 8: Connections Between a Transducer with a Type “D” Connector and a PDR-C /- D Readout

Electrical Information

The 722A transducer requires an external power source capable of supplying the voltages listed in *Appendix A: Product Specifications*, page 51. Noise and ripple should be less than 2 mV (peak-to-peak) over a 10 kHz bandwidth. You may use any readout device capable of reading from -0.6 V to 11 V. Refer to Figure 1 for the power, signal and chassis grounding scheme for a voltage unit.

Note



The ground of any external power supply and readout should be the same as the transducer ground (chassis ground) to minimize any possible ground loops and power supply noise which can affect the performance and stability of the system.

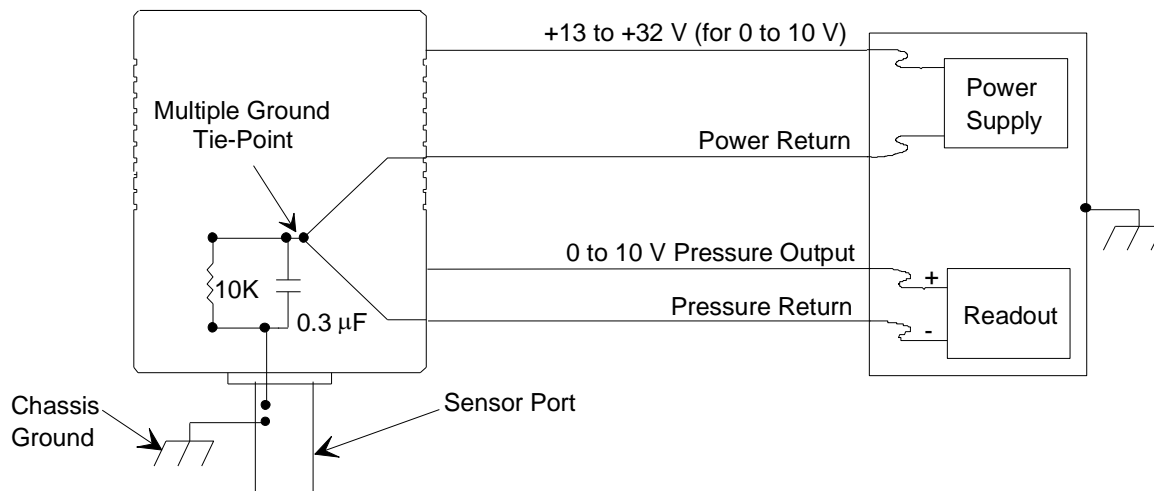

Note 1: For best results, use a readout with fully differential inputs.

Note 2: The absolute value of the potential difference between the chassis ground and signal common/power ground should not exceed 14 Volts.

Figure 1: Electrical Scheme for a Voltage Unit

NW16-KF Fitting Information

The NW16-KF fittings are only available for units with full scale pressure of a maximum of 5000 Torr (100 psia).

Warning



Units with NW16-KF fittings and a full scale range greater than 1200 Torr (23 psi) require an HPS overpressure ring. Operating the unit without a protective overpressure ring may result in injury.

The HPS part number for the overpressure ring is HPS 10031.

Interface Cables

Interface cables to all MKS companion products can be purchased from MKS. Refer to Table 5 for a listing of the cable numbers.

As of July 20, 2009, all products shipped to the European Community must comply with the EMC Directive 2004/108/EC, which covers radio frequency emissions and immunity tests. MKS products that meet these requirements are identified by application of the CE Mark.

Note



Metal braided, shielded cables are required to meet CE Mark specifications.

Interface Cables			
Transducer Connector	MKS Power Supply/Readout	Cable Description	Cable Number
9-pin Type "D"	Type 146, 660	9-pin Type "D" to 15-pin Type "D"	CB700-S-1-X
	PDR-C-1C, PDR-C-2C, PDR-D-1	9-pin Type "D" to flying leads	CB700-S-2-X
9-Pin Type "D"	PDR 2000 Dual Channel	Single 9-Pin Type "D" to Dual 9-Pin Type "D"	CB2000-2-m1 (10ft) -M2 (20ft)-M3 (30ft)
<i>where X indicates the length of the cable, in feet</i>			

Table 9: Interface Cables

Generic Shielded Cable Description

MKS offers a full line of cables for all MKS equipment. Should you choose to manufacture your own cables, follow the guidelines listed below:

1. The cable must have a *braided* shield, covering all wires. Neither aluminum foil nor spiral shielding will be as effective; using either may nullify regulatory compliance.
2. The connectors must have a metal case, which has direct contact to the cable's shield on the whole circumference of the cable. The inductance of a flying lead or wire from the shield to the connector will seriously degrade the shield's effectiveness. The shield should be grounded to the connector before its internal wires exit.
3. With very few exceptions, the connector(s) must make good contact to the device's case (ground). "Good contact" is about 0.01 ohms; and the ground should surround all wires. Contact to ground at just one point may not suffice.
4. For shielded cables with flying leads at one or both ends; it is important at each such end, to ground the shield *before* the wires exit. Make this ground with absolute minimum length. Refer to Figures 2 and 3, page 40. (A ¼ inch piece of #22 wire may be undesirably long since it has approximately 5 nH of inductance, equivalent to 31 ohms at 1000 MHz). After picking up the braid's ground, keep wires and braid flat against the case. With very few exceptions, grounded metal covers are not required over terminal strips. If one is required, it will be stated in the Declaration of Conformity or in the instruction manual.
5. In selecting the appropriate type and wire size for cables, consider:
 - A. The voltage ratings;
 - B. The cumulative I^2R heating of all the conductors (keep them safely cool);
 - C. The IR drop of the conductors, so that adequate power or signal voltage gets to the device;
 - D. The capacitance and inductance of cables which are handling fast signals, (such as data lines or stepper motor drive cables); and
 - E. That some cables may need internal shielding from specific wires to others; please see the instruction manual for details regarding this matter.

Attaching the Terminal Block Connector Cable

The cable to the terminal block connector must be firmly attached to the top of the transducer, in order to comply with CE Mark requirements. Figure 2 shows the preferred method to connect the cable; using a metal cable clamp to affix the cable to the transducer. Figure 3 shows an alternate method; wrapping the braided shield under the screw. Both examples show the cable securely clamped to the transducer.

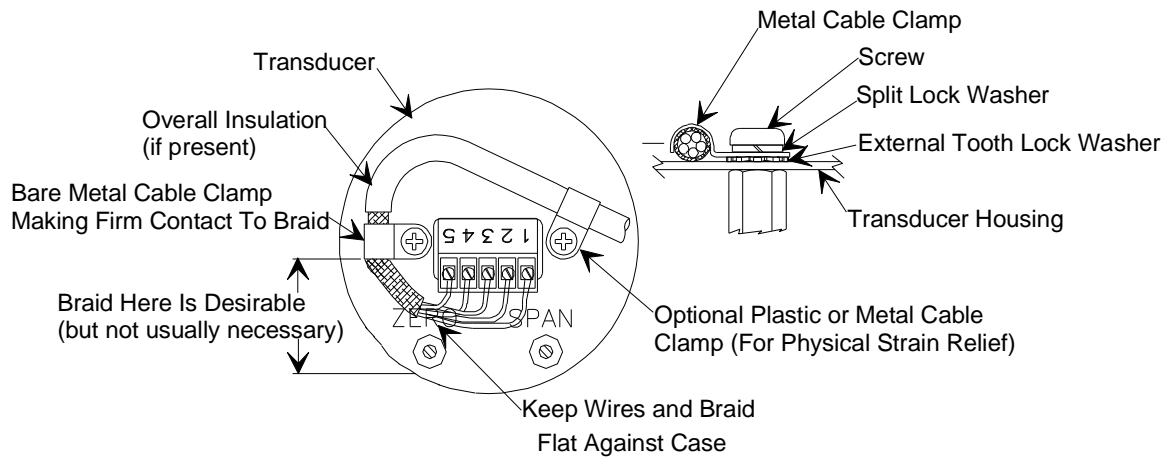

Figure 2: How To Connect the Cable to a Terminal Block (Example 1)

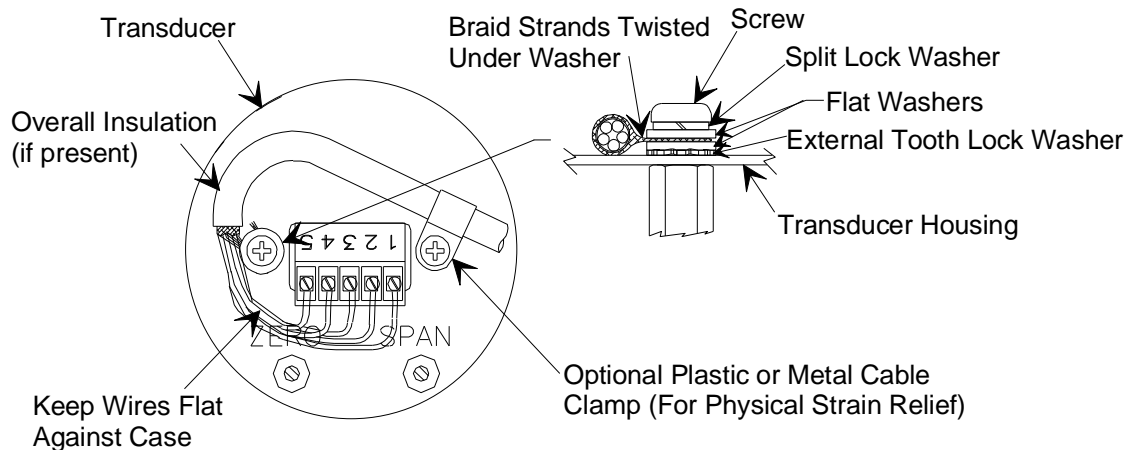

Figure 3: How To Connect the Cable to a Terminal Block (Example 2)

How To Check the Transducer Zero

Check the transducer zero prior to the initial operation and then periodically as required. The zero can be set (or reset) by adjusting the zero potentiometer located on the top cover of the transducer or, on the front panel of an MKS Power Supply/Readout, if you are using one. Refer to Figure **Error! Bookmark not defined.**, page 29, for the location of the zero potentiometer on a low pressure 722A transducer; Figure **Error! Bookmark not defined.**, page 30, for a high pressure 722A transducer.

How To Zero the 722A Transducer

To zero the 722A transducer, you must pump the unit, with the power on, down to a pressure less than the transducer's resolution (0.01% of Full Scale).

Note



The zero adjustment *must* be made at a pressure less than the transducer's resolution (0.01% of F.S.).

In addition, you should position the transducer in the *same orientation* as it will be positioned when installed in your system.

Zeroing a transducer at a pressure above its stated minimum resolution creates a *zero offset* relative to true absolute pressure. All subsequent readings are then linear and accurate *relative to the offset value*.

Note



If your system cannot achieve a sufficiently low pressure to set the transducer zero, you may use a vacuum leak detector with sufficient vacuum pumping (to achieve proper zeroing pressures). In this case, mount the transducer on the leak detector *in the same plane of orientation as it will be during actual use*.

To properly zero an absolute transducer, follow this procedure:

1. Install the transducer in a system and connect a power supply/readout.
2. Pump the system down to a pressure below the resolution of the transducer.
Refer to Table 6, page 42, for recommended pressure levels.
3. Using a small screwdriver, adjust the ZERO pot until the readout displays zero (0000).
Refer to the figure listed below for the location of the ZERO pot.
Low Pressure 722A Transducer: Figure **Error! Bookmark not defined.**, page 29,
High Pressure 722A Transducer: Figure **Error! Bookmark not defined.**, page 30.

Highest Pressure for Proper Zero Adjustment	
Full Scale Range	Pressure
1 Torr	$< 5 \times 10^{-5}$ Torr
2 Torr	$< 2 \times 10^{-5}$ Torr
10 Torr	$< 5 \times 10^{-4}$ Torr
100 Torr	$< 5 \times 10^{-3}$ Torr
500 Torr	$< 5 \times 10^{-3}$ Torr
1000 Torr	$< 5 \times 10^{-2}$ Torr
30 psia	$< 1 \times 10^{-3}$ psia
100 psia	$< 5 \times 10^{-3}$ psia
500 psia	$< 2 \times 10^{-2}$ psia

Table 10: Highest Pressure for Proper Zero Adjustment

Span Adjustment

The span setting may require adjustment periodically. Only adjust the SPAN pot in conjunction with a calibration transfer standard. **Do not** adjust the span setting if a calibration transfer standard is not available. Instead, send the unit back to an MKS Service Center for calibration.

This page intentionally left blank

Chapter Three: Overview

General Information

A complete pressure transducer system requires three components to convert pressure to a linear DC voltage output: a sensor, signal conditioner, and power supply. An analog or digital meter is required to display the DC output in pressure units.

The 722A transducer contains two of the above components: the sensor and signal conditioner. An MKS or MKS-compatible power supply is required to complete the pressure to DC voltage output conversion, and an MKS or MKS-compatible display unit is required for direct pressure readout. The display unit could be a personal computer, an MKS pressure controller, or an MKS PDR Series power supply/readout unit.

Sensor

The variable capacitance sensor consists of a pressure inlet tube (port) connected to a small chamber in the transducer body. One wall of this chamber is a metal diaphragm. The front side of the diaphragm is exposed to the gas whose pressure is to be measured. The back, or *reference* side of the diaphragm faces a rigidly mounted ceramic disc containing two electrodes. The diaphragm is positioned opposite the inlet port.

The reference side is permanently evacuated below the resolution of the instrument and its vacuum is maintained with a chemical getter system.

The diaphragm deflects with changing pressure (force per unit area) independently of the gas type or composition of the measured gas. This deflection causes an imbalance of the sensor electrode capacitances since the distance to the diaphragm is now different for each electrode. Using a precision constant frequency oscillator for excitation, the imbalance of capacitances is converted to a DC voltage. The resultant signal is then linearized, zeroed, and amplified via the signal conditioner electronics, to produce a precise output signal scaled to the range of the transducer.

Signal Conditioning Electronics

The signal conditioner contains state-of-the-art balanced bridge circuitry, self-compensated for thermal stability with ambient temperature changes. The circuit board construction uses surface mount technology. The output is either a DC voltage or mA current, which is linear with pressure. The transducer is then calibrated against a transfer standard to provide the selected output over the range of the transducer.

Label

The 722A transducer has one product identification label, shown in Figure 4.



Figure 4: Product Label

Chapter Four: Operation

General

After installation and during periodic maintenance, check the transducer zero to verify proper output. If the output is incorrect, set the output by adjusting the zero potentiometer. Refer to *How To Check the Transducer Zero*, page 41, for zeroing instructions.

Lowest Suggested Pressure Available for Reading

The pressures listed in the middle column of Table 7 reflect reliable and practical pressures for different range transducers. Lower readings may be obtained in environments, which have stable temperature and air flow.

Lowest Suggested Pressure to Use for Control

The pressures listed in the last column of Table 7 are for reference, and represent the pressure reading of the transducer at 50 mV signal output. A DC signal of at least 50 mV is the recommended minimum signal level to use when integrating any transducer into complex processing systems.

Suggested Pressures for Reading and Control		
Full Scale Range	Lowest Suggested Pressure for Reading	Lowest Suggested Pressure for Control
1 Torr	5×10^{-4}	5×10^{-3}
2 Torr	1×10^{-3}	1×10^{-2}
10 Torr	5×10^{-3} Torr	5×10^{-2} Torr
100 Torr	5×10^{-2} Torr	5×10^{-1} Torr
500 Torr	5×10^{-2} Torr	5×10^{-1} Torr
1000 Torr	0.5 Torr	5 Torr
30 psia	3×10^{-2} psia	3×10^{-1} psia
100 psia	0.1 psia	1 psia
500 psia	0.5 psia	5 psia

Table 11: Suggested Pressures for Reading and Control

This page intentionally left blank.

Chapter Five: Maintenance and Troubleshooting

General

In general, no maintenance is required other than proper installation and operation, and an occasional zero adjustment. If a transducer fails to operate properly upon receipt, check for shipping damage, and check the power/signal cable for correct continuity. Any damage should be reported to the carrier and MKS Instruments immediately. If there is no obvious damage and the continuity is correct, obtain an ERA Number (Equipment Return Authorization Number) before returning the unit to MKS Instruments for service.

Caution



Only qualified individuals should perform the installation and any user adjustments. They must comply with all the necessary ESD and handling precautions while installing and adjusting the instrument. Proper handling is essential when working with all highly sensitive precision electronic instruments.

In production operations, verify the transducer zero (and adjust if necessary) each time the equipment is shut down for routine maintenance.

Periodically check for wear on the cables and inspect the enclosure for visible signs of damage.

Note



The zero adjustment is the *only* adjustment that should usually be made in the field. Only adjust the span setting if you have access to proper calibration standards. Return the transducer to MKS Instruments for other adjustments, calibration, or servicing.

Zero Adjustment

All pressure transducers require initial and periodic zero adjustments. Make these adjustments at a pressure *lower than* the transducer's minimum resolution to achieve the full dynamic range specified for the transducer. Refer to *How To Zero the 722A Transducer*, page 41, for instructions on adjusting the zero setting.

Troubleshooting

Troubleshooting Chart		
Symptom	Possible Cause	Solution
Overrange positive or negative signal	A shorted transducer or a damaged interconnect cable (transducer to electronics module).	Measure supply voltages at the connector. Inspect cable and transducer. Replace if necessary.
Measurement slowly goes positive over time	Overpressure and/or a build-up of contamination in the P _x cavity.	Return to MKS for servicing or transducer replacement.
Unstable zero output	The ambient temperature may be too high. <i>or</i> The ambient temperature is varying over a wide range.	Refer to <i>Operating Environmental Requirements</i> , page 28, and be sure the ambient temperature is within product requirements.

Table 12: Troubleshooting Chart

Appendix A: Product Specifications

Performance Specifications

Accuracy	0.5% of Reading
CE Mark Compliance ¹	EMC Directive 2004/108/EC
Temperature Coefficients	
Zero	0.008% of F.S./ °C 10 Torr through 25,000 Torr 0.020% of F.S./ °C 1 and 2 Torr
Span	0.04% of Rdg./ °C 0.05% of Rdg./ °C 1 and 2 Torr

Physical Specifications

Ambient Operating Temperature Range	0° to 50° C (32° to 122° F), 15° to 40° C (59° to 104° F) 1&2 Torr only
Fittings	½ inch Tube; 4-VCR female, 8-VCR female, 8-VCO female, NW16-KF, Mini-CF.
Full Scale Pressure Ranges	1 Torr through 25,000 Torr (0.02 psia through 500 psia)
Material Exposed to Gas	Inconel® and Incoloy®. Some optional fittings may be built from 300-series stainless steel.
Overpressure Limit	45 psia or 2 times full scale, whichever is greater
Weight	< 10 oz. (< 283 g)

¹ Requires a metal, braided, shielded cable properly grounded at both ends.

NW-16-KF Fitting Information

The NW16-KF fittings are only available for units with full scale pressure up to a maximum of 5000 Torr (100 psia).

Warning



Units with NW16-KF fittings and a full scale range greater than 1200 Torr (23 psi) require an HPS overpressure ring. Operating the unit without a protective overpressure ring may result in injury.

The HPS part number for the overpressure ring is HPS 10031.

Electrical Specifications

Input Required	
0 to 5 Volt output	10.8 VDC to +32 VDC (regulated if below 13 VDC) @ 10 mA max.
0 to 10 Volt output	+13 VDC to +32 VDC @ 10 mA max.
Output	
0 to 5 VDC	into >10 K ohm load
0 to 10 VDC	into >10 K ohm load

Due to continuing research and development activities, these product specifications are subject to change without notice.

Appendix B: Model Code Explanation

Model Code

The options of your transducer are identified in the model code when you order the unit.

The model code is identified as follows:

722AXXXYYZF#

where:

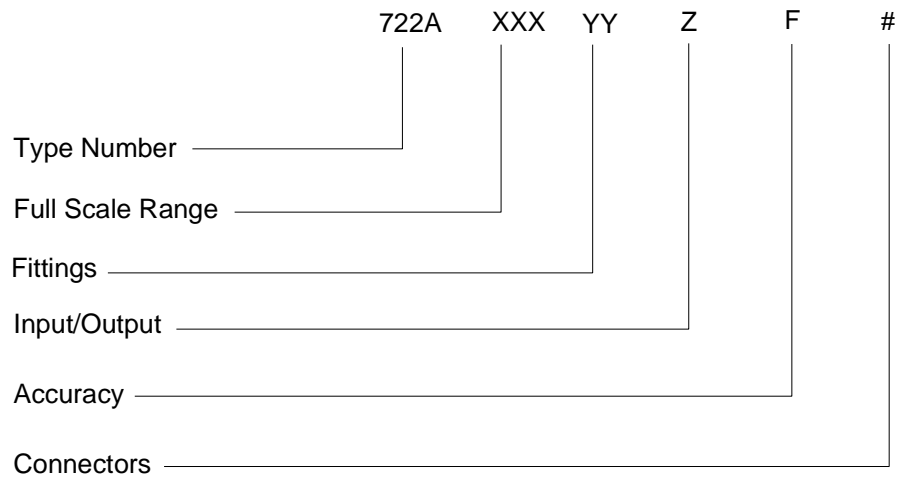

Type Number (722A)

This designates the model number of the instrument.

Full Scale Range (XXX)

The full scale range is indicated by a two digit / one letter code.

Full Scale Range	Ordering Code
1	01T
2	02T
10	11T
20	21T
100	12T
500	52T
1,000*	13T
5,000*	53T
10,000*	14T
25,000*	RCT

*must include a fitting.

Fittings (YY)

Six types of fittings are available, designated by a two letter code.

	Ordering Code
4-VCR Type Female	CD
½0 tube weld stub	BA
8-VCR Type Female	CE
8-VCO Type Female	DA
Mini-CF, rotatable	HA
NW-16-KF	GA

Power (Z)

The input/output power is designated by a single number code.

	Ordering Code
+13 to +32 VDC/0 to 10 VDC	2
+10.8 to 32 VDC/0 to 5 VDC	3

NW-16-KF Fitting Information

The NW-16-KF fittings are only available for units with full scale pressure of a maximum of 5000 Torr (100 psia).

Warning



Units with NW-16-KF fittings and a full scale range greater than 1200 Torr (23 psi) require an HPS overpressure ring. Operating the unit without a protective overpressure ring may result in injury.

The HPS part number for the overpressure ring is HPS 10031.

Accuracy (F)

The accuracy (0.5% of Reading) is specified by a letter F in this field.

Connector (#)

Three types of connectors are available, indicated by a single code.

	Ordering Code
9-pin Type "D"	A
15-pin Type "D" with a 6 inch cable	K
5-pin terminal strip	J

This page intentionally left blank.

Index

A

Accuracy, 25, 49, 53

C

Cables, interface, 37

CE Mark, 25, 37, 49

Connectors, 25, 33, 53

Customer support, 26

D

Dimensions, 28–30

E

Electrical information, 36, 50, 52

F

Fittings, 25, 32, 49, 52

 high pressure, 30

 low pressure, 29

I

Interface cables, 37

M

Maintenance, 47

Manual organization, 26

Model code, 51

Mounting, 31

O

Options, 25

Orientation, 31, 40

P

Pinout

 5-pin terminal block, 33

 9-pin Type, 33

Power, 52

Pressure limit, 49

Pressure, lowest for control, 45

Pressure, lowest reading, 45

R

Range, 25, 49, 52

Readout device, 36, 43

Returning the product, 26, 27

S

Safety information, 9–24

Sensor operation, 43

Signal conditioner, 44

Span, 41

Span adjustment, 47

T

Temperature, 28, 49

Troubleshooting, 48

Z

Zero, 40

Zero adjustment, 47