



116527-P1
Rev E, 3/99
Instruction Manual

MKS Type 1179A and 2179A Mass-Flo[®] Controller and Type 179A Mass-Flo Meter



WARRANTY

Type 1179A/2179A/179A Equipment

MKS Instruments, Inc. (**MKS**) warrants that for three years from the date of shipment the equipment described above (the "equipment") manufactured by **MKS** shall be free from defects in materials and workmanship and will correctly perform all date-related operations, including without limitation accepting data entry, sequencing, sorting, comparing, and reporting, regardless of the date the operation is performed or the date involved in the operation, provided that, if the equipment exchanges data or is otherwise used with equipment, software, or other products of others, such products of others themselves correctly perform all date-related operations and store and transmit dates and date-related data in a format compatible with **MKS** equipment. **THIS WARRANTY IS MKS' SOLE WARRANTY CONCERNING DATE-RELATED OPERATIONS.**

For the period commencing with the date of shipment of this equipment and ending three years later, **MKS** will, at its option, either repair or replace any part which is defective in materials or workmanship or with respect to the date-related operations warranty without charge to the purchaser. The foregoing shall constitute the exclusive and sole remedy of the purchaser for any breach by **MKS** of this warranty.

The purchaser, before returning any equipment covered by this warranty, which is asserted to be defective by the purchaser, shall make specific written arrangements with respect to the responsibility for shipping the equipment and handling any other incidental charges with the **MKS** sales representative or distributor from which the equipment was purchased or, in the case of a direct purchase from **MKS**, with the **MKS** home office in Andover, Massachusetts, USA.

This warranty does not apply to any equipment which has not been installed and used in accordance with the specifications recommended by **MKS** for the proper and normal use of the equipment. **MKS** shall not be liable under any circumstances for indirect, special, consequential, or incidental damages in connection with, or arising out of, the sale, performance, or use of the equipment covered by this warranty.

MKS recommends that all **MKS** pressure and flow products be calibrated periodically (typically every 6 to 12 months) to ensure accurate readings. When a product is returned to **MKS** for this periodic re-calibration it is considered normal preventative maintenance not covered by any warranty.

THIS WARRANTY IS IN LIEU OF ALL OTHER RELEVANT WARRANTIES, EXPRESSED OR IMPLIED, INCLUDING THE IMPLIED WARRANTY OF MERCHANTABILITY AND THE IMPLIED WARRANTY OF FITNESS FOR A PARTICULAR PURPOSE, AND ANY WARRANTY AGAINST INFRINGEMENT OF ANY PATENT.

**MKS Type 1179A and 2179A
Mass-Flo[®] Controller
and
Type 179A Mass-Flo Meter**

Copyright © 1999 by MKS Instruments, Inc.

All rights reserved. No part of this work may be reproduced or transmitted in any form or by any means, electronic or mechanical, including photocopying and recording, or by any information storage or retrieval system, except as may be expressly permitted in writing by MKS Instruments, Inc.

Printed in the United States of America

Mass-Flo[®] is a registered trademark of MKS Instruments, Inc., Andover, MA

Swagelok[®], VCR[®], and VCO[®] are registered trademarks of Swagelok Marketing Company, Solon, OH

Kalrez[®] and Viton[®] are registered trademarks of DuPont Dow Elastomers Inc., Wilmington, DE

NUPRO[®] is a registered trademark of Crawford Fitting Company, Solon, OH

Kel-F[®] is a registered trademark of 3M, Minneapolis, MN

DeviceNet[™] is a trademark of Open DeviceNet Vendor Association, Inc., Coral Springs, FL

Protected by U.S. Patent 5,461,913; foreign patents pending

Table of Contents

Mass Flow Controller Safety Information.....	1
Symbols Used in This Instruction Manual.....	1
Symbols Found on the Unit	2
Safety Procedures and Precautions	3
Sicherheitshinweise für den Massenflußregler	5
In dieser Betriebsanleitung vorkommende Symbole	5
Erklärung der am Gerät angebrachten Symbole	6
Sicherheitsvorschriften und Vorsichtsmaßnahmen.....	7
Informations relatives à la sécurité pour le contrôleur de débit de masse	9
Symboles utilisés dans ce manuel d'utilisation	9
Symboles apparaissant sur l'unité.....	10
Mesures de sécurité et précautions	11
Medidas de seguridad del controlador de flujo de masa	13
Símbolos usados en este manual de instrucciones.....	13
Símbolos hallados en la unidad	14
Procedimientos y precauciones de seguridad	15
Chapter One: General Information.....	17
Introduction	17
Design Features.....	17
Reliability	18
Cleanliness Features	18
How This Manual is Organized.....	19
Customer Support.....	20
Chapter Two: Installation	21
How To Unpack the Type 1179 Series Unit	21
Opening the Package	21
Unpacking Checklist.....	22
Environmental Requirements	23

Interface Cables.....	24
Generic Shielded Cable Description.....	25
Setup.....	26
Dimensions.....	27
Gas Line Connections	29
Standard Fittings.....	29
Optional Fittings.....	29
Mounting a Type 1179 MFC	29
Mounting a Type 2179 MFC	30
Chapter Three: Overview	31
Type 2179 MFC with a Positive Shutoff Valve	31
Electrical Connections.....	31
9-Pin Type “D” Connector.....	32
P.C. Edge Card Connector	33
15-Pin Type “D” Connector.....	34
The Gas Correction Factor (GCF).....	35
How To Calculate the GCF for Pure Gases	35
How To Calculate the GCF for Gas Mixtures.....	36
How To Read Mass Flow at a Different Reference Temperature	37
Labels	38
Control Valve (MFC only)	38
Chapter Four: Operation	39
How To Start Up the MFC/MFM.....	39
How To Zero the Flow Controller	40
How To Adjust the Controller Gain (MFC only)	41
How To Override the Valve (MFC only)	42
Priority of the Commands	42
How To Use the Optional Input (MFC only)	43
Chapter Five: Theory of Operation.....	45
General Information	45
Flow Path.....	45
Measurement Technique.....	45

Control Circuitry	46
Chapter Six: Maintenance.....	47
General	47
Zero Adjustment	47
Repair.....	48
Chapter Seven: Troubleshooting.....	49
Troubleshooting Chart	49
How To Adjust the Valve Preload (MFC only)	50
Appendix A: Product Specifications	57
Performance Specifications	57
Environmental Specifications.....	58
Electrical Specifications.....	58
Physical Specifications	59
Appendix B: Model Code Explanation	61
Model Code	61
Appendix C: Gas Correction Factors	65
Common Gases.....	65
Appendix D: MFC Sizing Guidelines	69
General Information.....	69
How To Determine the Flow Controller Range	70
How To Determine the Valve Configuration	71
Example.....	73
Appendix E: Positive Shutoff Valve Information.....	75
How To Operate the Positive Shutoff Valve.....	75
Index.....	77

List of Figures and Tables

Figures

Figure 1: Outline Dimensions of the Type 1179 MFC and Type 179 MFM	27
Figure 2: Side View of the Type 1179 MFC and Type 179 MFM.....	28
Figure 3: Outline Dimensions of the Type 2179 MFC (with optional mounting plate)	28
Figure 4: Mounting Dimensions of the 1179 Flow Controller.....	29
Figure 5: Mounting Dimensions of the Base Aluminum Plate	30
Figure 6: Mounting Dimensions of the Type 2179 Flow Controller	30
Figure 7: Serial Number Label	38
Figure 8: Location of the Retaining Screws	51
Figure 9: Location of the Lock Nut and Centershaft	52
Figure 10: Location of the R85 Potentiometer on the PC Board.....	55
Figure 11: Connecting the Type 2179 MFC to a Solenoid Valve	76

Tables

Table 1: Definition of Symbols Found on the Unit	2
Tabelle 2: Bedeutung der am Gerät angebrachten Symbole.....	6
Tableau 3: Définition des symboles apparaissant sur l'unité.....	10
Tabla 4: Definición de los símbolos hallados en la unidad	14
Table 5: MKS Cables	24
Table 6: 9-Pin Type “D” Connector Pinout.....	32
Table 7: 20-Pin Edge Card Connector Pinout	33
Table 8: 15-Pin Type “D” Connector Pinout.....	34
Table 9: Troubleshooting Chart	49
Table 10: Maximum Valve Currents.....	54
Table 11: Valve Current Headroom	54
Table 12: C_v Pressure Factors	71
Table 13: Valve Configuration Selection Guide.....	72
Table 14: Suitable Two-Way Solenoid Valves.....	75

Mass Flow Controller Safety Information

Symbols Used in This Instruction Manual

Definitions of WARNING, CAUTION, and NOTE messages used throughout the manual.

Warning

The **WARNING** sign denotes a hazard to personnel. It calls attention to a procedure, practice, condition, or the like, which, if not correctly performed or adhered to, could result in injury to personnel.

Caution

The **CAUTION** sign denotes a hazard to equipment. It calls attention to an operating procedure, practice, or the like, which, if not correctly performed or adhered to, could result in damage to or destruction of all or part of the product.

Note

The **NOTE** sign denotes important information. It calls attention to a procedure, practice, condition, or the like, which is essential to highlight.

Symbols Found on the Unit

The following table describes symbols that may be found on the unit.















Definition of Symbols Found on the Unit			
 On (Supply) IEC 417, No.5007	 Off (Supply) IEC 417, No.5008	 Earth (ground) IEC 417, No.5017	 Protective earth (ground) IEC 417, No.5019
 Frame or chassis IEC 417, No.5020	 Equipotentiality IEC 417, No.5021	 Direct current IEC 417, No.5031	 Alternating current IEC 417, No.5032
 Both direct and alternating current IEC 417, No.5033-a	 Class II equipment IEC 417, No.5172-a	 Three phase alternating current IEC 617-2 No.020206	
 Caution, refer to accompanying documents ISO 3864, No.B.3.1	 Caution, risk of electric shock ISO 3864, No.B.3.6	 Caution, hot surface IEC 417, No.5041	

Table 1: Definition of Symbols Found on the Unit

Safety Procedures and Precautions

The following general safety precautions must be observed during all phases of operation of this instrument. Failure to comply with these precautions or with specific warnings elsewhere in this manual violates safety standards of intended use of the instrument and may impair the protection provided by the equipment. MKS Instruments, Inc. assumes no liability for the customer's failure to comply with these requirements.

DO NOT SUBSTITUTE PARTS OR MODIFY INSTRUMENT

Do not install substitute parts or perform any unauthorized modification to the instrument. Return the instrument to an MKS Calibration and Service Center for service and repair to ensure that all safety features are maintained.

SERVICE BY QUALIFIED PERSONNEL ONLY

Operating personnel must not attempt component replacement and internal adjustments. Any service must be made by qualified service personnel only.

USE CAUTION WHEN OPERATING WITH HAZARDOUS MATERIALS

If hazardous materials are used, observe the proper safety precautions, completely purge the instrument when necessary, and ensure that the material used is compatible with the wetted materials in this product, including any sealing materials.

PURGE THE INSTRUMENT

After installing the unit, or before removing it from a system, purge the unit completely with a clean, dry gas to eliminate all traces of the previously used flow material.

USE PROPER PROCEDURES WHEN PURGING

This instrument must be purged under a ventilation hood, and gloves must be worn for protection.

DO NOT OPERATE IN AN EXPLOSIVE ENVIRONMENT

To avoid explosion, do not operate this product in an explosive environment unless it has been specifically certified for such operation.

USE PROPER FITTINGS AND TIGHTENING PROCEDURES

All instrument fittings must be consistent with instrument specifications, and compatible with the intended use of the instrument. Assemble and tighten fittings according to manufacturer's directions.

CHECK FOR LEAK-TIGHT FITTINGS

Carefully check all vacuum component connections to ensure leak-tight installation.

OPERATE AT SAFE INLET PRESSURES

Never operate at pressures higher than the rated maximum pressure (refer to the product specifications for the maximum allowable pressure).

INSTALL A SUITABLE BURST DISC

When operating from a pressurized gas source, install a suitable burst disc in the vacuum system to prevent system explosion should the system pressure rise.

KEEP THE UNIT FREE OF CONTAMINANTS

Do not allow contaminants to enter the unit before or during use. Contamination such as dust, dirt, lint, glass chips, and metal chips may permanently damage the unit or contaminate the process.

ALLOW THE UNIT TO WARM UP

If the unit is used to control dangerous gases, they should not be applied before the unit has completely warmed up. Use a positive shutoff valve to ensure that no erroneous flow can occur during warm up.

Sicherheitshinweise für den Massenflußregler

In dieser Betriebsanleitung vorkommende Symbole

Bedeutung der mit WARNUNG!, VORSICHT! und HINWEIS gekennzeichneten Absätze in dieser Betriebsanleitung.

Warnung!



Das Symbol **WARNUNG!** weist auf eine Gefahr für das Bedienpersonal hin. Es macht auf einen Arbeitsablauf, eine Arbeitsweise, einen Zustand oder eine sonstige Gegebenheit aufmerksam, deren unsachgemäße Ausführung bzw. ungenügende Berücksichtigung zu Verletzungen führen kann.

Vorsicht!



Das Symbol **VORSICHT!** weist auf eine Gefahr für das Gerät hin. Es macht auf einen Bedienungsablauf, eine Arbeitsweise oder eine sonstige Gegebenheit aufmerksam, deren unsachgemäße Ausführung bzw. ungenügende Berücksichtigung zu einer Beschädigung oder Zerstörung des Gerätes oder von Teilen des Gerätes führen kann.

Hinweis



Das Symbol **HINWEIS** macht auf wichtige Informationen bezüglich eines Arbeitsablaufs, einer Arbeitsweise, eines Zustands oder einer sonstige Gegebenheit aufmerksam.

Erklärung der am Gerät angebrachten Symbole

Nachstehender Tabelle sind die Bedeutungen der Symbole zu entnehmen, die am Gerät angebracht sein können.















Bedeutung der am Gerät angebrachten Symbole			
			
Ein (Energie) IEC 417, No.5007	Aus (Energie) IEC 417, No.5008	Erdanschluß IEC 417, No.5017	Schutzleiteranschluß IEC 417, No.5019
			
Masseanschluß IEC 417, No.5020	Equipotential- anschluß IEC 417, No.5021	Gleichstrom IEC 417, No.5031	Wechselstrom IEC 417, No.5032
			
Gleich- oder Wechselstrom IEC 417, No.5033-a	Durchgängige doppelte oder verstärkte Isolierung IEC 417, No.5172-a	Dreileiter- Wechselstrom (Drehstrom) IEC 617-2, No.020206	
			
Warnung vor einer Gefahrenstelle (Achtung, Dokumen- tation beachten) ISO 3864, No.B.3.1	Warnung vor gefährlicher elektrischer Spannung ISO 3864, No.B.3.6	Höhere Temperatur an leicht zugänglichen Teilen IEC 417, No.5041	

Tabelle 2: Bedeutung der am Gerät angebrachten Symbole

Sicherheitsvorschriften und Vorsichtsmaßnahmen

Folgende allgemeine Sicherheitsvorschriften sind während allen Betriebsphasen dieses Gerätes zu befolgen. Eine Mißachtung der Sicherheitsvorschriften und sonstiger Warnhinweise in dieser Betriebsanleitung verletzt die für dieses Gerät und seine Bedienung geltenden Sicherheitsstandards, und kann die Schutzvorrichtungen an diesem Gerät wirkungslos machen. MKS Instruments, Inc. haftet nicht für Mißachtung dieser Sicherheitsvorschriften seitens des Kunden.

Niemals Teile austauschen oder Änderungen am Gerät vornehmen!

Ersetzen Sie keine Teile mit baugleichen oder ähnlichen Teilen, und nehmen Sie keine eigenmächtigen Änderungen am Gerät vor. Schicken Sie das Gerät zwecks Wartung und Reparatur an den MKS-Kalibrierungs- und -Kundendienst ein. Nur so wird sichergestellt, daß alle Schutzvorrichtungen voll funktionsfähig bleiben.

Wartung nur durch qualifizierte Fachleute!

Das Auswechseln von Komponenten und das Vornehmen von internen Einstellungen darf nur von qualifizierten Fachleuten durchgeführt werden, niemals vom Bedienpersonal.

Vorsicht beim Arbeiten mit gefährlichen Stoffen!

Wenn gefährliche Stoffe verwendet werden, muß der Bediener die entsprechenden Sicherheitsvorschriften genauestens einhalten, das Gerät, falls erforderlich, vollständig spülen, sowie sicherstellen, daß der Gefahrstoff die von ihm benetzten, am Gerät verwendeten Materialien, insbesondere Dichtungen, nicht angreift.

Spülen des Gerätes mit Gas!

Nach dem Installieren oder vor dem Ausbau aus einem System muß das Gerät unter Einsatz eines reinen Trockengases vollständig gespült werden, um alle Rückstände des Vorgängermediums zu entfernen.

Anweisungen zum Spülen des Gerätes

Das Gerät darf nur unter einer Ablufthaube gespült werden. Schutzhandschuhe sind zu tragen.

Gerät nicht zusammen mit explosiven Stoffen, Gasen oder Dämpfen benutzen!

Um der Gefahr einer Explosion vorzubeugen, darf dieses Gerät niemals zusammen mit (oder in der Nähe von) explosiven Stoffen aller Art eingesetzt werden, sofern es nicht ausdrücklich für diesen Zweck zugelassen ist.

Anweisungen zum Installieren der Armaturen!

Alle Anschlußstücke und Armaturenteile müssen mit der Gerätespezifikation übereinstimmen, und mit dem geplanten Einsatz des Gerätes kompatibel sein. Der Einbau, insbesondere das Anziehen und Abdichten, muß gemäß den Anweisungen des Herstellers vorgenommen werden.

Verbindungen auf Undichtigkeiten prüfen!

Überprüfen Sie sorgfältig alle Verbindungen der Vakuumkomponenten auf undichte Stellen.

Gerät nur unter zulässigen Anschlußdrücken betreiben!

Betreiben Sie das Gerät niemals unter Drücken, die den maximal zulässigen Druck (siehe Produktspezifikationen) übersteigen.

Geeignete Berstscheibe installieren!

Wenn mit einer unter Druck stehenden Gasquelle gearbeitet wird, sollte eine geeignete Berstscheibe in das Vakuumssystem installiert werden, um eine Explosionsgefahr aufgrund von steigendem Systemdruck zu vermeiden.

Verunreinigungen im Gerät vermeiden!

Stellen Sie sicher, daß Verunreinigungen jeglicher Art weder vor dem Einsatz noch während des Betriebs in das Instrumenteninnere gelangen können. Staub- und Schmutzpartikel, Glassplitter oder Metallspäne können das Gerät dauerhaft beschädigen oder Prozeß und Meßwerte verfälschen.

Geräteeinheit auf Arbeitstemperatur bringen!

Wird das Gerät zur Flußregelung gefährlicher Gase verwendet, so dürfen diese nur nach Abschluß des Anwärmvorgangs zugeführt werden. Um das versehentliche Fließen von Gas während der Aufheizperiode zu verhindern, sollte ein Absperrventil (normal geschlossen) eingebaut werden.

Informations relatives à la sécurité pour le contrôleur de débit de masse

Symboles utilisés dans ce manuel d'utilisation

Définitions des indications AVERTISSEMENT, ATTENTION, et REMARQUE utilisées dans ce manuel.

Avertissement



L'indication **AVERTISSEMENT** signale un danger pour le personnel. Elle attire l'attention sur une procédure, une pratique, une condition, ou toute autre situation présentant un risque d'accident pour le personnel, en cas d'exécution incorrecte ou de non respect des consignes.

Attention



L'indication **ATTENTION** signale un danger pour l'appareil. Elle attire l'attention sur une procédure d'exploitation, une pratique, ou toute autre situation, présentant un risque d'endommagement ou de destruction d'une partie ou de la totalité de l'appareil, en cas d'exécution incorrecte ou de non respect des consignes.

Remarque



L'indication **REMARQUE** signale une information importante. Elle attire l'attention sur une procédure, une pratique, une condition, ou toute autre situation, présentant un intérêt particulier.

Symboles apparaissant sur l'unité

Le tableau suivant décrit les symboles pouvant apparaître sur l'unité.















Définition des symboles apparaissant sur l'unité			
			
Marche (sous tension) IEC 417, No.5007	Arrêt (hors tension) IEC 417, No.5008	Terre (masse) IEC 417, No.5017	Terre de protection (masse) IEC 417, No.5019
			
Masse IEC 417, No.5020	Equipotentialité IEC 417, No.5021	Courant continu IEC 417, No.5031	Courant alternatif IEC 417, No.5032
			
Courant continu et alternatif IEC 417, No.5033-a	Matériel de classe II IEC 417, No.5172-a	Courant alternatif triphase IEC 617-2, No.020206	
			
Attention : se reporter à la documentation ISO 3864, No.B.3.1	Attention : risque de choc électrique ISO 3864, No.B.3.6	Attention : surface brûlante IEC 417, No.5041	

Tableau 3: Définition des symboles apparaissant sur l'unité

Mesures de sécurité et précautions

Prendre les précautions générales de sécurité suivantes pendant toutes les phases d'exploitation de cet appareil. Le non respect des ces précautions ou des avertissements contenus dans ce manuel constitue une violation des normes de sécurité relatives à l'utilisation de l'appareil et peut diminuer la protection fournie par l'appareil. MKS Instruments, Inc. n'assume aucune responsabilité concernant le non respect des consignes par les clients.

PAS DE SUBSTITUTION DE PIÈCES OU DE MODIFICATION DE L'APPAREIL

Ne pas installer des pièces de substitution ou effectuer des modifications non autorisées sur l'appareil. Renvoyer l'appareil à un centre de service et de calibrage MKS pour tout dépannage ou réparation afin de garantir l'intégrité des dispositifs de sécurité.

DÉPANNAGE UNIQUEMENT PAR DU PERSONNEL QUALIFIÉ

Le personnel d'exploitation ne doit pas essayer de remplacer des composants ou de faire des réglages internes. Tout dépannage doit être uniquement effectué par du personnel qualifié.

PRÉCAUTION EN CAS D'UTILISATION AVEC DES PRODUITS DANGEREUX

Si des produits dangereux sont utilisés, prendre les mesures de précaution appropriées, purger complètement l'appareil quand cela est nécessaire, et s'assurer que les produits utilisés sont compatibles avec les composants liquides de l'appareil, y compris les matériaux d'étanchéité.

PURGE DE L'APPAREIL

Après l'installation de l'unité, ou avant son enlèvement d'un système, purger l'unité complètement avec un gaz propre et sec afin d'éliminer toute trace du produit de flux utilisé précédemment.

UTILISATION DES PROCÉDURES APPROPRIÉES POUR LA PURGE

Cet appareil doit être purgé sous une hotte de ventilation, et il faut porter des gants de protection.

PAS D'EXPLOITATION DANS UN ENVIRONNEMENT EXPLOSIF

Pour éviter toute explosion, ne pas utiliser cet appareil dans un environnement explosif, sauf en cas d'homologation spécifique pour une telle exploitation.

UTILISATION D'ÉQUIPEMENTS APPROPRIÉS ET PROCÉDURES DE SERRAGE

Tous les équipements de l'appareil doivent être cohérents avec ses spécifications, et compatibles avec l'utilisation prévue de l'appareil. Assembler et serrer les équipements conformément aux directives du fabricant.

VÉRIFICATION DE L'ÉTANCHÉITÉ DES CONNEXIONS

Vérifier attentivement toutes les connexions des composants pour le vide afin de garantir l'étanchéité de l'installation.

EXPLOITATION AVEC DES PRESSIONS D'ENTRÉE NON DANGEREUSES

Ne jamais utiliser des pressions supérieures à la pression nominale maximum (se reporter aux spécifications de l'unité pour la pression maximum admissible).

INSTALLATION D'UN DISQUE D'ÉCHAPPEMENT ADAPTÉ

En cas d'exploitation avec une source de gaz pressurisé, installer un disque d'échappement adapté dans le système à vide afin d'éviter une explosion du système en cas d'augmentation de la pression.

MAINTIEN DE L'UNITÉ À L'ABRI DES CONTAMINATIONS

Ne pas laisser des produits contaminants pénétrer dans l'unité avant ou pendant l'utilisation. Des produits contaminants tels que des poussières et des fragments de tissu, de glace et de métal peuvent endommager l'unité d'une manière permanente ou contaminer le processus.

RESPECT DU TEMPS D'ÉCHAUFFEMENT

Si l'unité est utilisée pour contrôler des gaz dangereux, ceux-ci ne doivent pas être appliqués avant l'échauffement complet de l'unité. Utiliser une valve de fermeture positive afin de garantir qu'aucun flux ne se produise par erreur pendant l'échauffement.

Medidas de seguridad del controlador de flujo de masa

Símbolos usados en este manual de instrucciones

Definiciones de los mensajes de advertencia, precaución y de las notas usados en el manual.

Advertencia



El símbolo de advertencia indica la posibilidad de que se produzcan daños personales. **Pone de relieve un procedimiento, práctica, estado, etc. que en caso de no realizarse u observarse correctamente puede causar daños personales.**

Precaución



El símbolo de precaución indica la posibilidad de producir daños al equipo. **Pone de relieve un procedimiento operativo, práctica, estado, etc. que en caso de no realizarse u observarse correctamente puede causar daños o la destrucción total o parcial del equipo.**

Nota



El símbolo de notas indica información de importancia. Este símbolo pone de relieve un procedimiento, práctica o condición cuyo conocimiento es esencial destacar.

Símbolos hallados en la unidad

La tabla siguiente contiene los símbolos que puede hallar en la unidad.















Definición de los símbolos hallados en la unidad			
			
Encendido (alimentación eléctrica) IEC 417, N° 5007	Apagado (alimentación eléctrica) IEC 417, N° 5008	Puesta a tierra IEC 417, N° 5017	Protección a tierra IEC 417, N° 5019
			
Caja o chasis IEC 417, N° 5020	Equipotencialidad IEC 417, N° 5021	Corriente continua IEC 417, N° 5031	Corriente alterna IEC 417, N° 5032
			
Corriente continua y alterna IEC 417, N° 5033-a	Equipo de clase II IEC 417, N° 5172-a	Corriente alterna trifásica IEC 617-2, N° 020206	
			
Precaución. Consulte los documentos adjuntos ISO 3864, N° B.3.1	Precaución. Riesgo de descarga eléctrica ISO 3864, N° B.3.6	Precaución. Superficie caliente IEC 417, N° 5041	

Tabla 4: Definición de los símbolos hallados en la unidad

Procedimientos y precauciones de seguridad

Las precauciones generales de seguridad descritas a continuación deben observarse durante todas las etapas de funcionamiento del instrumento. La falta de cumplimiento de dichas precauciones o de las advertencias específicas a las que se hace referencia en el manual, constituye una violación de las normas de seguridad establecidas para el uso previsto del instrumento y podría anular la protección proporcionada por el equipo. Si el cliente no cumple dichas precauciones y advertencias, MKS Instruments, Inc. no asume responsabilidad legal alguna.

NO UTILICE PIEZAS NO ORIGINALES O MODIFIQUE EL INSTRUMENTO

No instale piezas que no sean originales o modifique el instrumento sin autorización. Para asegurar el correcto funcionamiento de todos los dispositivos de seguridad, envíe el instrumento al Centro de servicio y calibración de MKS toda vez que sea necesario repararlo o efectuar tareas de mantenimiento.

LAS REPARACIONES DEBEN SER EFECTUADAS ÚNICAMENTE POR TÉCNICOS AUTORIZADOS

Los operarios no deben intentar reemplazar los componentes o realizar tareas de ajuste en el interior del instrumento. Las tareas de mantenimiento o reparación deben ser realizadas únicamente por personal autorizado.

TENGA CUIDADO CUANDO TRABAJE CON MATERIALES TÓXICOS

Cuando se utilicen materiales tóxicos, es responsabilidad de los operarios cumplir las medidas de seguridad correspondientes, purgar totalmente el instrumento cuando sea necesario y comprobar que el material utilizado sea compatible con los materiales humedecidos de este producto e inclusive, con los materiales de sellado.

PURGUE EL INSTRUMENTO

Una vez instalada la unidad o antes de retirarla del sistema, purgue completamente la unidad con gas limpio y seco para eliminar todo resto de la sustancia líquida empleada anteriormente.

USE PROCEDIMIENTOS ADECUADOS PARA REALIZAR LA PURGA

El instrumento debe purgarse debajo de una campana de ventilación y deben utilizarse guantes protectores.

NO HAGA FUNCIONAR ESTE INSTRUMENTO EN UN AMBIENTE CON RIESGO DE EXPLOSIONES

Para evitar que se produzcan explosiones, no haga funcionar este producto en un ambiente con riesgo de explosiones, excepto cuando el mismo haya sido certificado específicamente para tal uso.

USE ACCESORIOS ADECUADOS Y REALICE CORRECTAMENTE LOS PROCEDIMIENTOS DE AJUSTE

Todos los accesorios del instrumento deben cumplir las especificaciones del mismo y ser compatibles con el uso que se debe dar al instrumento. Arme y ajuste los accesorios de acuerdo con las instrucciones del fabricante.

COMPRUEBE QUE LAS CONEXIONES SEAN A PRUEBA DE FUGAS

Inspeccione cuidadosamente las conexiones de los componentes de vacío para comprobar que hayan sido instalados a prueba de fugas.

HAGA FUNCIONAR EL INSTRUMENTO CON PRESIONES DE ENTRADA SEGURAS

No haga funcionar nunca el instrumento con presiones superiores a la máxima presión nominal (en las especificaciones del instrumento hallará la presión máxima permitida).

INSTALE UNA CÁPSULA DE SEGURIDAD ADECUADA

Cuando el instrumento funcione con una fuente de gas presurizado, instale una cápsula de seguridad adecuada en el sistema de vacío para evitar que se produzcan explosiones cuando suba la presión del sistema.

MANTENGA LA UNIDAD LIBRE DE CONTAMINANTES

No permita el ingreso de contaminantes en la unidad antes o durante su uso. Los productos contaminantes tales como polvo, suciedad, pelusa, lascas de vidrio o virutas de metal pueden dañar irreparablemente la unidad o contaminar el proceso.

PERMITA QUE LA UNIDAD SE CALIENTE

Si se utiliza la unidad para controlar gases peligrosos, no libere los gases hasta que la unidad termine de calentarse. Use una válvula de cierre positivo para impedir todo flujo no deseado durante el período de calentamiento.

Chapter One: General Information

Introduction

The Type 1179A Mass-Flo[®] controller and the Type 2179A Mass-Flo controller with a positive shutoff valve, accurately measure and control the mass flow rates of gases. The Type 179A Mass-Flo Meter measures the flow rate of gases. Based upon an MKS measurement technique, patent pending, these instruments use a laminar flow device whose precise indication of mass flow is achieved through the use of a bypass element in parallel with a sensor tube. The 1179 controller and 179 meter have a three-inch footprint. The 1179 and 2179 controllers feature the ability to accept TTL level commands to remotely open and close the control valve. The controller includes a metal cover and RF bypass capacitors, and incorporates a design that virtually eliminates RFI and EMI interference.

The 1179 Series units can interface to complementary MKS equipment (Type 647, 246, 247, PR4000) to display the reading and to provide the power, and set point commands. (Additionally, the 167 unit can be used as a readout and set point generator, but it does not supply power; the 660 unit can be used as a power supply and readout, though it cannot send a set point to the flow controller.) Refer to the corresponding manuals for requirements and instructions.

The 1179 Series flow units are available in a variety of types and configurations to suit specific needs. The options that must be specified when you order the flow unit include:

- *Connector:* 9-pin or 15-pin Type “D” connector, recessed P.C. Edge Card connector, Digital RS-485, Digital DeviceNet[®]
- *Range:* 10, 20, 50, 100, 200, 500, 1000, 2000, 5000, 10,000, 20,000, 30,000 sccm (N₂ equivalent)
- *Fittings:* Swagelok[®] 4-VCR[®] male compatible, Cajon 4-VCO[®] male compatible, and ¼ inch Swagelok[®] compatible
- *Seals:* Viton[®], Neoprene, Buna-N, Kalrez[®], all-metal

All 1179 controllers have normally *closed* valves.

Design Features

The design of the 1179 flow controller incorporates an advanced flow sensor, a new control valve, and an optimized bypass. (U.S. and Foreign Patents; Patents Pending on the sensor.) The latest generation two-element sensing circuit provides accurate, repeatable performance even in low flow ranges (< 10 sccm). Low temperature effect from ambient temperature change and a low altitude sensitivity effect are also ensured. The newly optimized sensor/bypass arrangement minimizes the flow splitting error for gases with different densities, which dramatically improves measurement accuracy when gases other than the calibration gas are used. The surface mount

electronics feature optional pin-to-pin compatibility with other manufacturer's flow controllers. In addition, the variable valve control electronics provides for fast response to any set point.

Reliability

To help provide excellent reliability, the design contains a low mechanical and electronic components count and has successfully passed the following tests:

- STRIFE, including temperature cycling and vibration (sine and random tests)

and with an overall metal braided shielded cable, properly grounded at both ends:

- CE Compliance - EMC Directive 89/336/EEC (units with a Type "D" connector only; the Edge Card connector is not CE compliant)

Cleanliness Features

With only three elastomeric external seals, the design of the flow controller ensures extremely low external leakage and minimizes a key source of particle generation, outgassing, and permeation. The design also incorporates minimal wetted surface area. To further ensure its cleanliness, the 1179 controller undergoes precision machining as well as a proprietary cleaning process. The instrument is assembled and double-bagged under Class 100 conditions.

How This Manual is Organized

This manual is designed to provide instructions on how to set up and install a Type 1179 Series unit.

Before installing your Type 1179 Series unit in a system and/or operating it, carefully read and familiarize yourself with all precautionary notes in the *Safety Messages and Procedures* section at the front of this manual. In addition, observe and obey all WARNING and CAUTION notes provided throughout the manual.

Chapter One: General Information, (this chapter) introduces the product and describes the organization of the manual.

Chapter Two: Installation, explains environmental requirements and practical considerations to take into account when selecting the proper setting for the mass flow controller.

Chapter Three: Overview, describes, in a general way, how the flow controller operates in a gas flow system. This chapter also provides information on how to use a Gas Correction Factor when interpreting the output signal for a gas other than the calibration gas.

Chapter Four: Operation, explains how to start up and operate the mass flow controller. It also discusses how to override the control valve.

Chapter Five: Theory of Operation, provides additional information on how the flow controller operates.

Chapter Six: Maintenance, lists a few general practices to follow to ensure that the flow controller will perform optimally.

Chapter Seven: Troubleshooting, includes a table of hints for reference in the event that your flow controller malfunctions.

Appendix A: Product Specifications, lists the specifications of the instrument.

Appendix B: Model Code Explanation, describes the instrument's ordering code.

Appendix C: Gas Correction Factors, provides a table listing the gas correction factors for the most commonly used gases.

Appendix D: MFC Sizing Guidelines, is provided for reference and describes how to calculate the correct size MFC for an application. This information is useful if you need to purchase another MFC or if you plan to use your MFC in another, different application.

Appendix E: Positive Shutoff Valve Information, describes how to attach a solenoid valve to a Type 2179 MFC.

Customer Support

Standard maintenance and repair services are available at all of our regional MKS Calibration and Service Centers, listed on the back cover. In addition, MKS accepts the instruments of other manufacturers for recalibration using the Primary and Transfer Standard calibration equipment located at all of our regional service centers. Should any difficulties arise in the use of your Type 1179 instrument, or to obtain information about companion products MKS offers, contact any authorized MKS Calibration and Service Center. If it is necessary to return the instrument to MKS, please obtain an ERA Number (Equipment Return Authorization Number) from the MKS Calibration and Service Center before shipping. The ERA Number expedites handling and ensures proper servicing of your instrument.

Please refer to the inside of the back cover of this manual for a list of MKS Calibration and Service Centers.

Warning

All returns to MKS Instruments must be free of harmful, corrosive, radioactive, or toxic materials.

Chapter Two: Installation

How To Unpack the Type 1179 Series Unit

MKS has carefully packed the 1179 Series unit so that it will reach you in perfect operating order. Upon receiving the unit, however, you should check for defects, cracks, broken connectors, etc., to be certain that damage has not occurred during shipment.

Note

Do *not* discard any packing materials until you have completed your inspection and are sure the unit arrived safely.

If you find any damage, notify your carrier and MKS immediately. If it is necessary to return the unit to MKS, obtain an ERA Number (Equipment Return Authorization Number) from the MKS Service Center before shipping. Please refer to the inside of the back cover of this manual for a list of MKS Calibration and Service Centers.

Opening the Package

The 1179 Series unit is assembled, leak tested with helium, and calibrated in a clean room environment. The instrument is double-bagged in this environment to ensure maintenance of its particle free condition during shipment. It is very important to remove the bags according to clean room practices. To maintain at least a minimal level of clean room standards, follow the instructions below.

1. Remove the outer bag in an ante room (garmenting room) or transfer box.
Do not allow this outer bag to enter the clean room.
2. Wipe down the exterior of the inner bag with a clean room wipe.
This step reduces the contamination introduced into the clean room.
3. Remove the inner bag in the clean room.

Unpacking Checklist

Standard Parts:

- The 1179 or 2179 mass flow controller, or 179 mass flow meter
- The 1179/2179/179 instruction manual (this book)

Optional Equipment:

- Electrical Connector Accessories Kit, M100B-K1 (includes a mate to the electrical connector if you choose to make your own interface cable)
- Interface cables (refer to *Interface Cables*, page 24)
- Power supply readout, such as the Type 647, 246, 247, PR4000, 167 (no power supply, readout, and set point generator only), or 660 (no set point, readout and power supply only)
- Length Adapter Kit - allows the 1179 Series unit to be a drop-in replacement for a 1259/1260 or 2259/2260 unit

Environmental Requirements

Follow the guidelines listed below when installing and using the 1179 flow controller.

1. Maintain the normal operating temperature between 0° and 50° C (32° and 122° F).
2. Observe the pressure limits:
 - A. Maximum gas inlet pressure is 150 psig.
 - B. Operational differential pressure is:
 - 10 to 40 psid for ≤ 5000 sccm units
 - 15 to 40 psid for 10,000 to 30,000 sccm unitsThe standard orifice is sized for control over this range with the outlet at atmospheric pressure.
3. Provide power input at ± 15 VDC ($\pm 5\%$) @ 200 mA.
 - A. Maximum voltage/current at startup is ± 15 VDC ($\pm 5\%$) @ 200 mA.
 - B. Typical steady state voltage/current should be ± 15 VDC ($\pm 5\%$) @ 100 mA.
4. Allow 2 minutes for warm-up time.
5. Use high purity gas and filters in line upstream of the MFC.
6. Leave the power to the instrument on at all times, for optimal performance.

For additional information refer to *Appendix A: Product Specifications*, page 57.

Interface Cables

As of January 1, 1996, most products shipped to the European Community must comply with the EMC Directive 89/336/EEC, which covers radio frequency emissions and immunity tests. In addition, as of January 1, 1997, some products shipped to the European Community must also comply with the Product Safety Directive 92/59/EEC and Low Voltage Directive 73/23/EEC, which cover general safety practices for design and workmanship. MKS products that meet these requirements are identified by application of the CE Mark.

Note



Only 1179 Series units with a Type “D” connector or digital communications connector can be CE marked. The Edge Card connector is not CE compliant.

To ensure compliance with EMC Directive 89/336/EEC, an overall metal braided shielded cable, properly grounded at both ends, is required during use. No additional installation requirements are necessary to ensure compliance with Directives 92/59/EEC and 73/23/EEC.

Note



1. An overall metal braided, shielded cable, properly grounded at both ends, is required during use to meet CE specifications.
2. To order an overall metal braided shielded cable, add an “S” after the cable type designation. For example, to order a cable to connect an 1179 unit equipped with a 15-pin Type “D” connector to a 146 unit, use part number CB47-1-XX, where XX designates the cable length; for a braided, shielded cable use part number CB147S-1-XX.

MKS offers a variety of interface cables, listed in Table 5.

MKS Cables			
To Connect To A . . .	15-pin Type “D”	9-pin Type “D”	20-pin Edge Card
PR4000, 146, 186, 167, 647	CB147-1-xx	CB147-12-xx	CB147-7-xx
246, 247	CB259-5-xx	CB147-12-xx	CB259-10-xx
<i>where xx indicates the cable length</i>			

Table 5: MKS Cables

Generic Shielded Cable Description

Note



1. To meet CE specifications, an overall metal braided shielded cable, properly grounded at both ends, is required during use.
2. Use an overall metal braided shielded cable assemblies, especially if the environment contains high EMI/RFI noise.
3. Provide adequate clearance for Type “D” cable assemblies:
 - Straight Shielded connectors require approximately 3” height.
 - Right Angle connectors require approximately 2” height.

Should you choose to manufacture your own cables, follow the guidelines listed below:

1. The cable must have a *braided* shield, covering all wires. Neither aluminum foil nor spiral shielding will be as effective; using either may nullify regulatory compliance.
2. The connectors must have a metal case which has direct contact to the cable’s shield on the whole circumference of the cable. The inductance of a flying lead or wire from the shield to the connector will seriously degrade the shield’s effectiveness. The shield should be grounded to the connector before its internal wires exit.
3. With very few exceptions, the connector(s) must make good contact to the device’s case (ground). “Good contact” is about 0.01 ohms; and the ground should surround all wires. Contact to ground at just one point may not suffice.
4. For shielded cables with flying leads at one or both ends; it is important at each such end, to ground the shield *before* the wires exit. (A ¼ inch piece of #22 wire may be undesirably long since it has approximately 5 nH of inductance, equivalent to 31 ohms at 1000 MHz). After picking up the braid’s ground, keep wires and braid flat against the case. With very few exceptions, grounded metal covers are not required over terminal strips. If one is required, it will be stated in the Declaration of Conformity or in this instruction manual.
5. In selecting the appropriate type and wire size for cables, consider:
 - A. The voltage ratings.
 - B. The cumulative I^2R heating of all the conductors (keep them safely cool).
 - C. The IR drop of the conductors, so that adequate power or signal voltage gets to the device.
 - D. The capacitance and inductance of cables which are handling fast signals, (such as data lines or stepper motor drive cables).
 - E. That some cables may need internal shielding from specific wires to others; please see the instruction manual for details regarding this matter.

Setup

Follow the guidelines below when setting up the 1179 flow controller.

1. Set the controller into position where it will be connected to a gas supply.
Placement of flow components in an orientation other than that in which they were calibrated (typically horizontal) may cause a small zero shift. The zero offset can be removed according to the instructions in *How To Zero the Flow Controller*, page 40.
2. Install the flow controller in the gas stream such that the flow will be in the direction of the arrow on the side of the controller.
3. Allow adequate clearance for the cable connector and tubing.
Straight Shielded connectors require approximately 3" height. Right Angle connectors require approximately 2" height.
4. Position the flow controller to provide access to the zero potentiometer.
The zero potentiometer is located on the inlet side of the flow controller body.

Refer to Figures 1, and 2, page 28, for outline dimensions, and Figure 4, page 29, for mounting dimensions of the flow controller.

Dimensions

Note  All dimensions are listed in inches with millimeters referenced in parentheses.

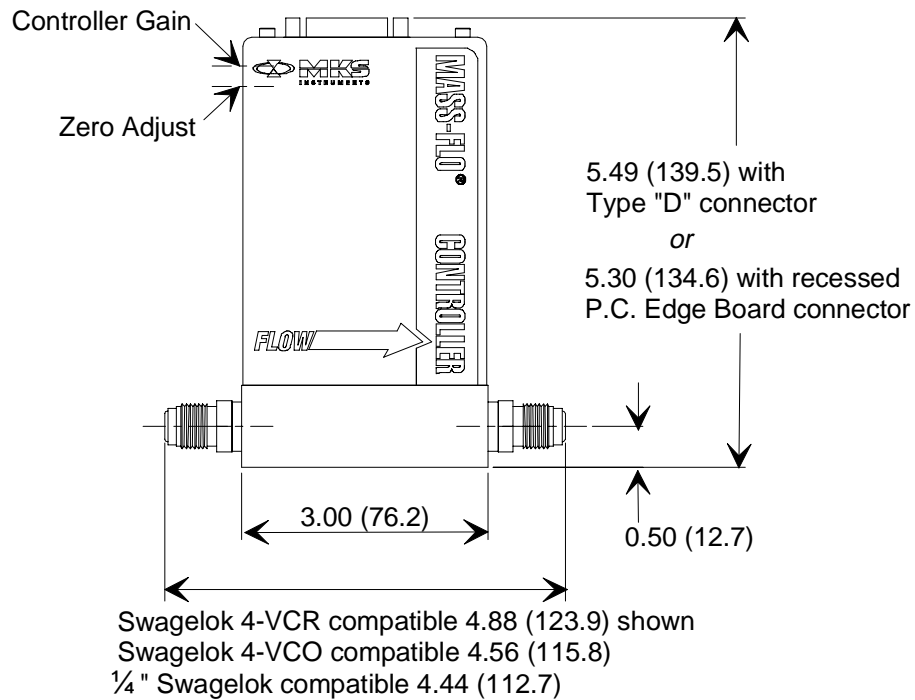



Figure 1: Outline Dimensions of the Type 1179 MFC and Type 179 MFM

Note  The method used to measure the overall length of the unit varies with the type of fitting. For VCR and VCO compatible fittings, the unit is measured from mating face to mating face. For Swagelok compatible fittings, the unit is measured from fitting end to fitting end (less nut).

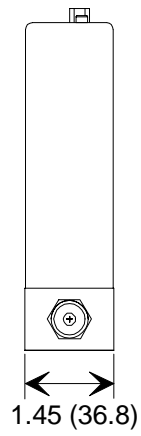

Figure 2: Side View of the Type 1179 MFC and Type 179 MFM

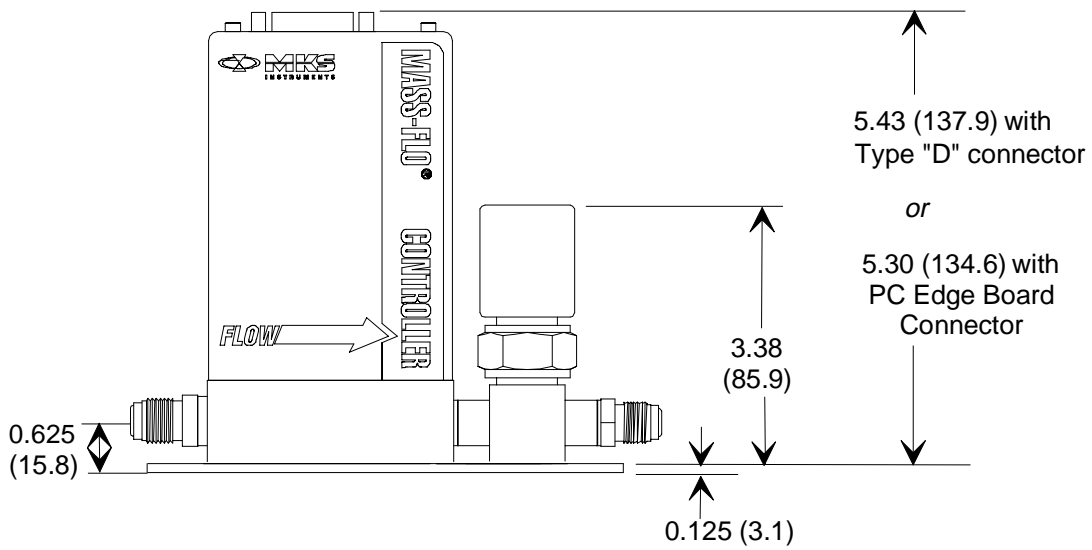

Figure 3: Outline Dimensions of the Type 2179 MFC (with optional mounting plate)

Gas Line Connections

Connect the gas line (via tubing) from the gas supply to the flow controller's inlet, and from the flow controller's outlet, to the downstream tubing.

Standard Fittings

The 1179 flow controller is equipped with Swagelok 4-VCR male compatible fittings. For specific information regarding these fittings, refer to the manufacturer's documentation.

Optional Fittings

As an option, ¼ inch Swagelok compatible, or Swagelok 4-VCO male compatible fittings, are available when specified.

Mounting a Type 1179 MFC

Tapped holes are provided in the base of the unit for mounting. Refer to Figure 4 for the size and location of the mounting holes.

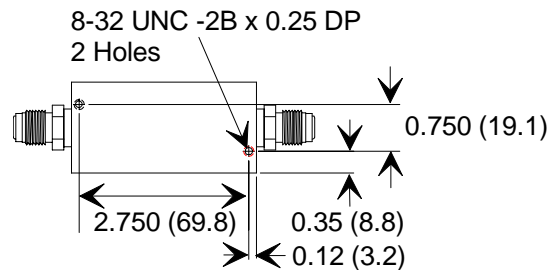

Figure 4: Mounting Dimensions of the 1179 Flow Controller

Mounting a Type 2179 MFC

The Type 2179 MFC includes a positive shutoff valve. Mount each assembly horizontally, if possible. Placement of flow components in a different orientation may cause a small zero shift. The zero offset can be removed according to the instructions in *How To Zero the Flow Controller*, page 40. The air operator port is a 1/8 NPT (National Pipe Thread) internal fitting. The aluminum plate can be mounted via four mounting holes. Refer to Figure 5 for the location of the mounting holes on the aluminum plate.

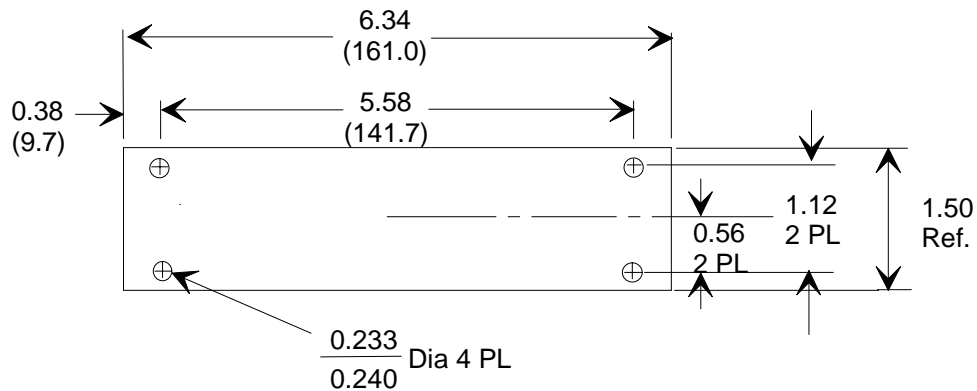

Figure 5: Mounting Dimensions of the Base Aluminum Plate

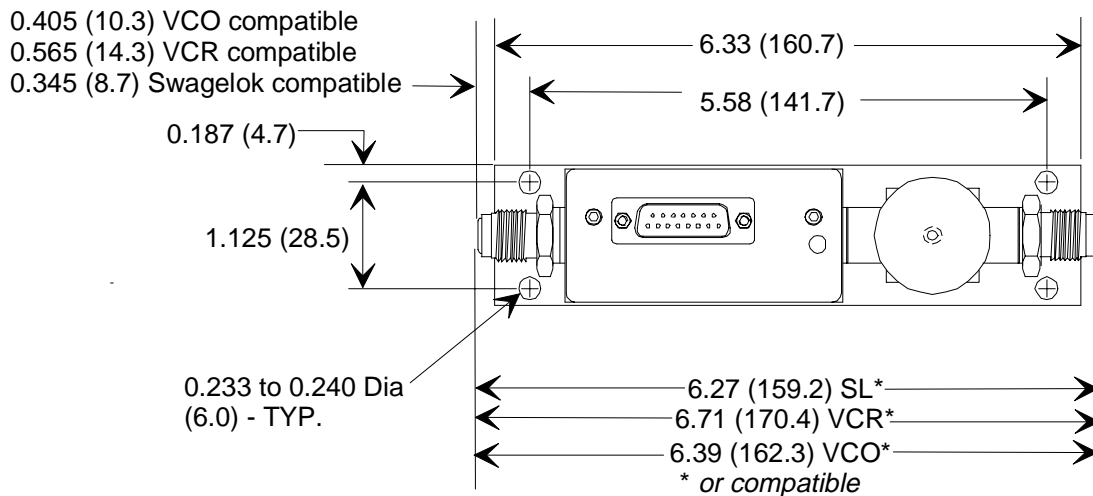

Figure 6: Mounting Dimensions of the Type 2179 Flow Controller

Chapter Three: Overview

Type 2179 MFC with a Positive Shutoff Valve

The Type 2179 consists of a Type 1179 flow controller configured with a positive shutoff valve downstream. A pneumatically operated valve may be used in series with a mass flow controller when a no-leakage condition is required. The shutoff valve is an all 316L VAR SST diaphragm valve with a Kel-F[®] valve seat. It has a maximum leak rate across the ports of 4×10^{-9} sccm He and a leak rate of less than 1×10^{-9} sccm He, to the outside.

Refer to Figure 3, page 28, for the dimensions of a Type 2179 flow controller.

Electrical Connections

If you are using the 1179 instrument with any equipment other than corresponding MKS power supply/readout units, consult the manufacturer's specifications for connection, and for proper electrical and power characteristics. Refer to *Appendix A: Product Specifications*, page 57, for electrical requirements of the Type 1179 flow controller.

The 1179 flow controller is available with either a Type "D" or an Edge Card connector.

9-Pin Type “D” Connector

Table 8 lists the pinout of the 9-pin Type “D” connector for a mass flow controller.

9-Pin Type “D” Connector Pinout	
Pin Number	Assignment
1	Valve Open/Close*
2	Flow Signal Output
3	+15 V
4	Power Common
5	-15 V
6	Set Point*
7	Signal Common
8	Signal Common
9	MKS Test Point*
<i>* For an MFC only, No Connection for an MFM</i>	

Table 6: 9-Pin Type “D” Connector Pinout

Note



1. Chassis ground is not available on a separate pin. Instead, it is carried out through the cable shielding. Be sure that the connector on the other end of the cable is properly grounded to its chassis ground.
2. The 0 to 5 VDC flow signal output comes from pin 2 and is referenced to pin 7 (signal common).
3. Use any appropriate 0 to 5 VDC input signal of less than 20K ohm source impedance referenced to pin 7 as the set point signal to pin 8.

P.C. Edge Card Connector

Table 7 shows the pinout of the 20-pin Edge Card connector for a mass flow controller.

20-Pin Edge Card Connector Pinout			
Pin Number	Function	Pin Number	Function
1	Chassis Ground	A	Set Point Input (0 to +5 VDC)*
2	Power Supply Common	B	Signal Common
3	Flow Output (0 to +5 VDC)	C	Signal Common
4	+15 VDC	D	Valve Open (TTL low)*
5	Optional Input*	E	No Connection
6	No Connection	F	-15 VDC
7	Key	H	Key
8	No Connection	J	MKS Test Point*
9	No Connection	K	No Connection
10	Signal Common	L	Valve Close (TTL low)*
* For an MFC only, No Connection for an MFM			

Table 7: 20-Pin Edge Card Connector Pinout

Note



1. The “No Connection” pin assignment refers to a pin with no internal connection.
2. Pins 1 through 10 are located on one side of the gold finger connection and pins A through L are located on the opposite side of the gold finger connection.
3. The 0 to 5 VDC flow signal output comes from pin 3 and is referenced to pin B (signal ground).
4. Any appropriate 0 to 5 VDC input signal of less than 20K ohm source impedance referenced to pin B can be used to supply a set point signal to pin A.

15-Pin Type “D” Connector

Table 8 lists the pinout of the 15-pin Type “D” connector for a mass flow controller.

15-Pin Type “D” Connector Pinout			
Pin	Assignment	Pin	Assignment
1	MKS Test Point*	9	No Connection
2	Flow Signal Output (0 to +5 VDC)	10	Optional Input*
3	Valve Close* (TTL low)	11	Signal Common
4	Valve Open* (TTL low)	12	Signal Common
5	Power Supply Common	13	No Connection
6	-15 VDC	14	No Connection
7	+15 VDC	15	Chassis Ground
8	Set Point Input* (0 to +5 VDC)		
<i>* For an MFC only, No Connection for an MFM</i>			

Table 8: 15-Pin Type “D” Connector Pinout

Note



1. The “No Connection” pin assignment refers to a pin with no internal connection.
2. The 0 to 5 VDC flow signal output comes from pin 2 and is referenced to pin 12 (signal common).
3. Any appropriate 0 to 5 VDC input signal of less than 20K ohm source impedance referenced to pin 12 can be used to supply a set point signal to pin 8.

The Gas Correction Factor (GCF)

A Gas Correction Factor (GCF) is used to indicate the ratio of flow rates of different gases which will produce the same output voltage from a mass flow controller. The GCF is a function of specific heat, density, and the molecular structure of the gases. Nitrogen is used as the baseline gas (GCF = 1) since flow controllers are usually calibrated with nitrogen.

Appendix C: Gas Correction Factors, page 65, lists the gas correction factors for some commonly used pure gases. If the gas you are using is not listed in *Appendix C: Gas Correction Factors*, page 65, you must calculate its GCF. The equations for calculating gas correction factors are listed in *How To Calculate the GCF for Pure Gases*, page 35, and *How To Calculate the GCF for Gas Mixtures*, page 36.

Note



1. When using the GCF, the accuracy of the flow reading may vary by $\pm 5\%$, however, the repeatability will remain $\pm 0.2\%$ of FS.
2. All MKS readouts have Gas Correction Adjustment controls to provide direct readout.

How To Calculate the GCF for Pure Gases

To calculate the Gas Correction Factor for *pure* gases, use the following equation:

$$\text{GCF}_x = \frac{(0.3106) (s)}{(d_x) (cp_x)}$$

where:

GCF_x = Gas Correction Factor for gas X

0.3106 = (Standard Density of nitrogen) (Specific Heat of nitrogen)

s = Molecular Structure correction factor where S equals:

1.030 for Monatomic gases

1.000 for Diatomic gases

0.941 for Triatomic gases

0.880 for Polyatomic gases

d_x = Standard Density of gas X, in g/l (at 0° C and 760 mm Hg)

cp_x = Specific Heat of gas X, in cal/g° C

How To Calculate the GCF for Gas Mixtures

For gas mixtures, the calculated Gas Correction Factor is not simply the weighted average of each component's GCF. Instead, the GCF (relative to nitrogen) is calculated by the following equation:

$$\text{GCF}_M = \frac{(0.3106) (a_1s_1 + a_2s_2 + \dots a_ns_n)}{(a_1d_1cp_1 + a_2d_2cp_2 + \dots a_nd_ncp_n)}$$

where:

GCF_M = Gas Correction Factor for a gas mixture

0.3106 = (Standard Density of nitrogen) (Specific Heat of nitrogen)

a_1 through a_n = Fractional Flow of gases 1 through n
Note: a_1 through a_n must add up to 1.0

s_1 through s_n = Molecular Structure correction factor for gases 1 through n
 where S equals:

1.030 for Monatomic gases

1.000 for Diatomic gases

0.941 for Triatomic gases

0.880 for Polyatomic gases

d_1 through d_n = Standard Density for gases 1 through n, in g/l
 (at 0° C and 760 mmHg)

cp_1 through cp_n = Specific Heat of gases 1 through n, cal/g° C

Note



The values for s, d, and cp_x are available for most gases, refer to *Appendix C: Gas Correction Factors*, page 65.

The values for a_1 through a_n (which must add up to 1.0) are application dependent.

Example

Calculate the GCF for a gas mixture of argon (gas 1) flowing at 150 sccm and nitrogen (gas 2) flowing at 50 sccm, where:

Argon (Ar)	Nitrogen (N₂)
$a_1 = \frac{150}{200} = 0.75$	$a_2 = \frac{50}{200} = 0.25$
$s_1 = 1.030$	$s_2 = 1.000$
$d_1 = 1.782 \text{ g/l}$	$d_2 = 1.250 \text{ g/l}$
$cp_1 = 0.1244 \text{ cal/g } ^\circ\text{C}$	$cp_2 = 0.2485 \text{ cal/g } ^\circ\text{C}$

then:

$$\begin{aligned}
 \text{GCF}_M &= \frac{(0.3106) [(0.75)(1.030) + (0.25)(1.000)]}{(0.75)(1.782)(0.1244) + (0.25)(1.250)(0.2485)} \\
 &= \frac{(0.3106) [(0.7725) + (0.25)]}{(0.1663) + (0.0777)} \\
 &= \frac{(0.3106) (1.0225)}{0.244} \\
 &= \frac{0.3176}{0.244} \\
 \text{GCF}_M &= 1.302
 \end{aligned}$$

How To Read Mass Flow at a Different Reference Temperature

The equations for calculating the GCF assume that the MFC was calibrated at a reference temperature of 0° C (~273° K). If you want to read the mass flow as if the MFC was calibrated at a different reference temperature, adjust the calculated GCF value using the following equation:

$$\text{Temperature Corrected GCF} = \text{GCF} \times \frac{T_x}{T_s}$$

where:

$$T_x = \text{Reference temperature (} ^\circ\text{K)}$$

$$T_s = 273.15^\circ\text{K} \text{ (~ equal to } 0^\circ\text{C)}$$

Labels

Each 1179 unit has two serial number labels, a small one on top side and the standard, larger label on the back side. Each label shows the serial number, the model code, the full scale flow range, and the calibration gas.

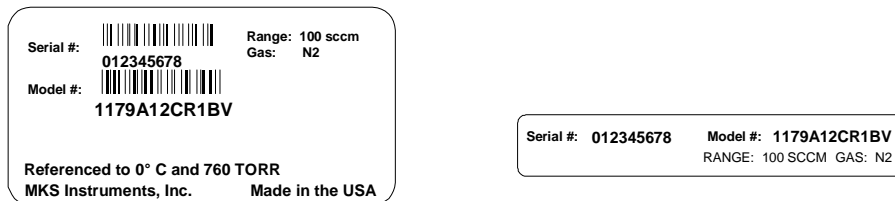

Figure 7: Serial Number Label

Control Valve (MFC only)

The Control Valve is a specially constructed solenoid valve in which the armature (moving valve mechanism) is suspended by two springs. This arrangement ensures that no friction is present and makes precise control possible. The 1179 controller has the valve normally *closed*, the control current is used to *lift* the armature *from* the seat, allowing a controlled flow of gas.

Chapter Four: Operation

How To Start Up the MFC/MFM

1. Leak test the fittings on the MFC/MFM using standard leak test procedures.
Do *not* proceed to the next step until you are certain that there is no gas leakage.

2. Plug the power supply/readout cable (MKS or customer-supplied) into the connector (either a 9-pin Type “D”, 15-pin Type “D” or a PC Edge Card connector) located at the top of the flow controller.

Plug the other end of the cable into an MKS or MKS-compatible power supply/readout unit.

3. Apply power to the MFC/MFM instrument.

When power is first applied, the output signal jumps to + 7.5 VDC.

You can monitor the flow output signal as the heaters stabilize and the output approaches zero. Approximately 2 minutes after power up, the output signal should be within 10 mV (0.2% F.S.) of the final voltage at all specified flow rates.

Warning

If the instrument is being used to control dangerous gases, be sure that the system is *fully warmed up* before applying gases to the system. You may choose to install a positive shutoff valve to prevent inadvertent gas flow during the warm-up period.

Once the MFC/MFM is completely warmed up, you can proceed to zero the unit as required.

How To Zero the Flow Controller

Ensure that no gas flow is entering the flow controller.

1. Apply gas, at a regulated pressure, to the flow controller.
2. If your system includes a positive shutoff valve, located either upstream or downstream of the instrument, close it.
3. *For an MFC:* Command the control valve open by sending a full scale set point (5 VDC) signal, or:
15-pin Type “D” connector: Connect pin 4 (valve open) to pin 11 or 12 (signal ground).
9-pin Type “D” connector: Supply +5 Volts to pin 1 (to open the valve).
Edge Card connector: Connect pin D (valve open) to pins 10, B, or C (signal ground).

A positive flow may occur momentarily while the gas pressure equalizes across the flow controller.

Note

A set point command signal greater than 50 mV (1% of full scale) is required for the flow controller to generate an output.

For an MFM: Skip to step 2 in *Adjust the Zero Pot*

Adjust the Zero Pot

1. *For an MFC:* Once flow through the controller has stopped (reached zero flow), remove the set point or valve open command.
2. Turn the Zero pot (located on the inlet side of the flow controller) until the readout displays zero.

Refer to Figure 1, page 27, for the location of the Zero pot.

If you are using an MKS power supply/readout unit, the flow controller can also be zeroed at the front panel of the readout unit.

Note

A DeviceNet™ MFC/MFM does not have a zero pot, use the zero offset command instead.

3. Open the positive shutoff valve.

An MFC may indicate a small, positive flow (<1.0% F.S.) due to a leak through its control valve. However, do **not** “zero out” this flow since it represents an actual flow measurement inherent in the system.

How To Adjust the Controller Gain (MFC only)

Adjust the controller gain if the flow signal oscillates. Reducing the controller gain will reduce the signal oscillation. The controller gain adjustment pot is located on the upstream side of the controller.

- *To decrease flow signal oscillation:* Turn the controller gain counter-clockwise to decrease the controller gain setting.

Note

Lowering the supply pressure to the MFC will have the same effect as decreasing the gain since it will reduce the overflow/underflow effect of the valve.

If the MFC responds too slowly to a change in set point, you may need to increase the controller gain slightly. To increase the controller gain, turn the controller gain pot clockwise.

How To Override the Valve (MFC only)

The valve override feature enables the control valve to be fully opened (purged) or closed independent of the set point command signal. Refer to Table 8, page 34, or Table 7, page 33, for the appropriate pin locations.

If the 1179 flow controller is equipped with a 15-pin Type “D” connector:

To *open* the valve, apply a TTL low to pin 4 *or* connect pin 4 to signal ground (pin 12).

To *close* the valve, apply a TTL low to pin 3 *or* connect pin 3 to signal ground (pin 12).

If the 1179 flow controller is equipped with a 9-pin Type “D” connector:

To *open* the valve, apply a +5 Volt signal to pin 1.

To *close* the valve, apply ground to pin 1.

Note

To control with a TTL signal, use a tri-stated device.

If the 1179 flow controller is equipped with an Edge Card connector:

To *open* the valve, apply a TTL low to pin D *or* connect pin D to signal ground (pin 10).

To *close* the valve, apply a TTL low to pin L *or* connect pin L to signal ground (pin 10).

Priority of the Commands

The 1179 flow controller executes commands based on a hierarchical command structure. The highest priority command is Valve Open, followed by Valve Close, and Set Point Control. Therefore, if the flow controller is operating under Set Point Control, you can send a Valve Open command to force the valve to the full open position.

Note

When both the Valve Close and Valve Open pins are pulled down, the Valve Open command takes precedence and the valve is moved to the open position.

How To Use the Optional Input (MFC only)

The 1179 and 2179 units provide an optional input feature which allows them to control flow based on 0 to 5 V signals from external sensing devices. A common application of this feature is pressure control using inputs from a pressure transducer.

Implement the optional feature by simply routing the output from the desired external device to the appropriate “optional input” position for the particular connector. Refer to Table 8, page 34, and Table 7, page 33, for the pinout assignments. Voltage to the optional input overrides the signal generated by the unit’s own internal flow sensor. The control electronics drives the valve so that the optional input signal matches the set point. Provide the 0 to 5 V set point to the same input pin as in standard flow control.

Metered flow output is still available on the standard output pin identified in the applicable pin assignments. Refer to Table 8, page 34, and Table 7, page 33, for the pinout assignments.

This page intentionally left blank.

Chapter Five: Theory of Operation

General Information

The 1179 Flow Controller measures the mass flow rate of a gas and controls the flow rate according to a given set point. The control range is from 2 to 100% of Full Scale (F.S.) with an accuracy of $\pm 1\%$ of F.S.

Flow Path

Upon entering the flow controller, the gas stream passes first through the metering section of the instrument for its mass flow to be measured. The gas moves on through the control valve for its rate of flow to be regulated according to the given set point, and then exits the instrument at the established rate of flow.

The metering section consists of one of the following:

- A sensor tube for ranges ≤ 10 sccm (N_2 equivalent)
- A sensor tube and parallel bypass for ranges > 10 sccm (N_2 equivalent)

The geometry of the sensor tube, in conjunction with the specified full scale flow rate, ensures fully developed laminar flow in the sensing region. The bypass elements, in those instruments containing them, are specifically matched to the characteristics of the sensor tube to achieve a laminar flow splitting ratio which remains constant throughout each range.

Measurement Technique

The flow measurement is based on differential heat transfer between temperature sensing heater elements which are attached symmetrically to the sensor tube. This senses the thermal mass movement which is converted to mass flow via the specific heat, C_p , of the gas. The resulting signal is amplified to provide a 0 to 5 VDC output which is proportional to mass flow.

Control Circuitry

The controller employs the above measurement technique and utilizes a control circuit that provides drive current for the proportioning control valve. The flow controller accepts a 0 to 5 VDC set point signal, compares it to its own flow signal, and generates an error voltage. This error signal is then conditioned by a PID (Proportional-Integral-Derivative) algorithm and amplified so that it can reposition the controlling valve, thus reducing the controller error to within the resolution specification of the instrument.

Since the control valve is *normally closed*, the 1179 unit pulls the plug *away* from the seat to regulate the gas flow rate.

Chapter Six: Maintenance

General

In general, no maintenance is required other than proper installation and operation, and zero adjustment. If a controller fails to operate properly upon receipt, check for shipping damage, and check the power/signal cable for correct continuity. Any damage should be reported to the carrier and MKS Instruments immediately. If there is no obvious damage and the continuity is correct, obtain an ERA Number (Equipment Return Authorization Number) before returning the unit to MKS Instruments for service.

Zero Adjustment

For best accuracy and repeatability, you should check the zero setting periodically and reset it, if necessary. Refer to *How To Zero the Flow Controller*, page 40, for instructions on setting the zero. The frequency of checking the zero is dependent on the specific accuracy and repeatability required by your process. It is also recommended that the instrument be recalibrated annually if no other time interval has been specifically established. Refer to the inside of the back cover of this instruction manual for a complete list of MKS Calibration and Service centers.

Repair

Contact any authorized MKS Sales Office or Calibration and Service Center should you encounter any difficulties or problems using your flow controller.

Note

If it is necessary to return the instrument to MKS for repair, please contact any of the MKS international service/calibration centers listed on the inside of the back cover of this manual for an ERA (Equipment Return Authorization) number to expedite handling and ensure proper servicing of your instrument.

Chapter Seven: Troubleshooting

Troubleshooting Chart

Symptoms	Possible Cause	Remedy
No output or overrange at zero (after warm-up)	Improper cable	Check cable for type
	Valve override function applied	Disconnect valve override
	Electronics malfunctioning	Return for service
Unit indicates a negative flow	Unit installed in gas stream backwards	Reinstall unit in proper flow direction
Controller does not track set point	Improper zero adjustment	Zero meter output, according to <i>How To Zero the Flow Controller</i> , page 40.
Controller does not function	Electronics malfunctioning	Return for service
	Valve sticking	Readjust the valve, following the instructions in <i>How To Adjust the Valve Preload</i> , page 50.
Oscillation	Too high a controller gain setting	Reduce (turn counter-clockwise)
	Incorrect upstream pressure regulator	Check manufacturers' specifications
	Upstream pressure too high	Reduce upstream pressure
Excessive closed conductance	Inadequate valve preload	Readjust the valve, according to <i>How To Adjust the Valve Preload</i> , page 50.
Unit does not achieve full flow	Upstream pressure too low	Increase upstream pressure
	Excessive valve preload	Readjust the valve, according to <i>How To Adjust the Valve Preload</i> , page 50.

Table 9: Troubleshooting Chart

How To Adjust the Valve Preload (MFC only)

Warning



Before performing MFC valve adjustments, you **MUST** purge your process equipment and the MFC with an inert gas, such as argon or nitrogen, and isolate the MFC from toxic and hazardous gases. Use an inert surrogate gas while adjusting the valve preload as a safeguard against inadvertent exposure to any toxic or hazardous gas. A release of hazardous or toxic gas could cause serious injury. If necessary, remove the MFC from the process equipment to adjust the valve.

Questions concerning the safe handling of toxic or hazardous gases may be answered by consulting your corporate policy, a government agency such as OSHA or NIOSH, or experts familiar with your process gas.

MKS assumes no liability for safe handling of toxic or hazardous gases.

Caution



All valves are adjusted at the factory for proper leak integrity and flow control response. Adjust the valve *only* if the *Troubleshooting Chart*, page 49, recommends that you do so.

This procedure requires the following equipment:

- Any special safety equipment necessary to handle the gas in use
- $\frac{3}{32}$ " allen wrench for retaining screws (4-40 socket head cap screws)
- $\frac{3}{16}$ " allen wrench for the centershaft
- $\frac{9}{16}$ " wrench for the lock nut
- Digital Multi Meter (DMM)

1. Disconnect the cable to power down the unit.
2. Use a $\frac{3}{32}$ " allen wrench to remove the enclosure retaining screws. Remove the enclosure cover.

Figure 8 shows the location of the retaining screws.

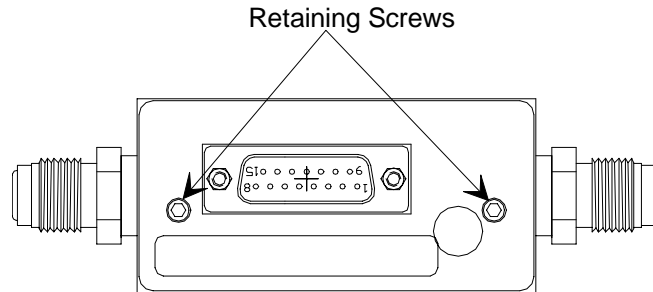

Figure 8: Location of the Retaining Screws

3. Reconnect the cable to power up the unit.
4. Set your processing system to supply the MFC with a non-hazardous gas (Ar, N₂, or He) and purge thoroughly.

Warning



You MUST use a “safe” gas while making any valve adjustments to safeguard against inadvertent exposure to any toxic or hazardous gas. DO NOT adjust the valve while a hazardous or toxic gas is flowing through the MFC.

If you cannot use a “safe” gas within your processing system, remove the MFC and purge the unit as required by your corporate policies and any appropriate safety procedures. Once the unit is purged properly perform the valve adjustment outside of the system, maintaining the same orientation (flow direction) as used in the processing system.

Choose a “safe” gas with a similar molecular weight as the actual process gas. More specifically, helium is best used as a substitute for other very light gases such as hydrogen.

5. Set the gas supply regulator to the maximum expected operating pressure of your processing system.

Warning

Follow your corporate policy on handling toxic or hazardous gases. Your corporate policy on handling these gases *supersedes* the instructions in this manual. MKS assumes no liability for the safe handling of such materials.

If appropriate, remove the MFC from the process tool and make the adjustments using a surrogate gas.

6. Close all isolation valves in the system, both upstream and downstream of the MFC.
7. Zero the unit, following the instructions in *How To Zero the Flow Controller*, page 40.
8. Disconnect one electrical valve lead from its post on the PC Control board and connect a DMM in series. Set the DMM to measure current in the 10 to 100 mA range.
9. Open all upstream and downstream isolation valves in the system.
10. Hold the centershaft in place with a $\frac{3}{16}$ " allen wrench and loosen the jam nut using a $\frac{9}{16}$ " crescent wrench.

Refer to Figure 9 for the location of the lock nut and centershaft.

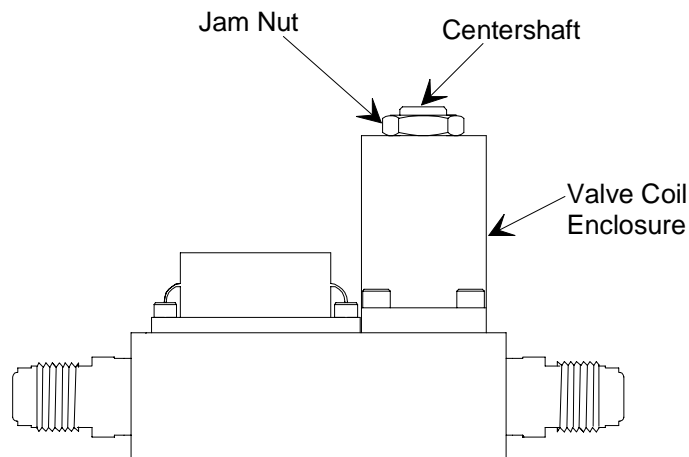

Figure 9: Location of the Lock Nut and Centershaft

11. Provide a set point input signal to the MFC of 0.25 Volts to represent 5% flow.

12. *Slowly* turn the centershaft while monitoring the DMM: clockwise rotation increases the current required to open the valve; counterclockwise rotation decreases it. ***Adjust to a target value of 25 mA, except for 10, 20, and 50 sccm units containing Viton, Buna-N, or Neoprene elastomers which require 20 mA preload.***

Note

Always make adjustments by turning counterclockwise first and then turning clockwise to the proper setting. This procedure ensures that the adjustment will remain fixed when you retighten the lock nut.

Caution

Do not overturn the centershaft! Excessive turning may damage the plug and cause poor closed conductance and flow control.

13. Holding the centershaft in place, re-tighten the jam nut. As you tighten the jam nut, monitor the DMM to ensure that the current remains within 1 mA of the target value.

14. Change the set point input signal to 0.0 Volts.

15. Monitor the MFC output to verify that the valve closed conductance is within specification.

Refer to *Appendix A: Product Specifications*, page 57, for the valve closed conductance specification. If the valve fails to meet the closed conductance specification, return the unit to MKS for service.

16. Change the inlet pressure to the minimum expected in use.

17. Change the set point input signal to 5.0 Volts (100% of full scale).

18. Observe the MFC output and control valve current. *Record the valve current.*

The MFC output should be 5.0 Volts (100%) and the valve current no greater than the limits in Table 10. If the valve current exceeds these limits, return the unit to MKS for service.

Maximum Valve Currents	
UUT Flow Capacity (N ₂ Equivalent)	Maximum Valve Current at 100% Set Point and Minimum Pressure
50 sccm and under	39 milliAmps
100 to 500 sccm	45 milliAmps
1000 sccm and above	51 milliAmps

Table 10: Maximum Valve Currents

19. Re-adjust the Valve Current Limit Potentiometer, R85.

- a. Find the current limiting potentiometer, R85, on the PC board.

Refer to Figure 10, page 55. R85 is located in the top right hand corner of the board. It is the only **black** potentiometer on the board and is much smaller than the others.

- b. Determine the required valve current limit by adding the appropriate headroom from Table 11 to the valve current recorded in Step 18.

Valve Current Headroom	
UUT Flow Capacity (N ₂ Equivalent)	Required Valve Current Headroom
50 sccm and under	24 milliAmps
100 to 500 sccm	18 milliAmps
1000 sccm and above	12 milliAmps

Table 11: Valve Current Headroom

- c. Provide a 5 V set point signal and turn the gas supply off.
- d. When the indicated flow output has dropped to zero, adjust R85 until the required valve current limit is obtained. Note that *counterclockwise* rotation *increases* the maximum current, while *clockwise* rotation *decreases* it.
20. Remove the DMM and reconnect the valve lead.
21. Reposition the enclosure over the unit and tighten the retaining screws.
22. Reconnect the cable.

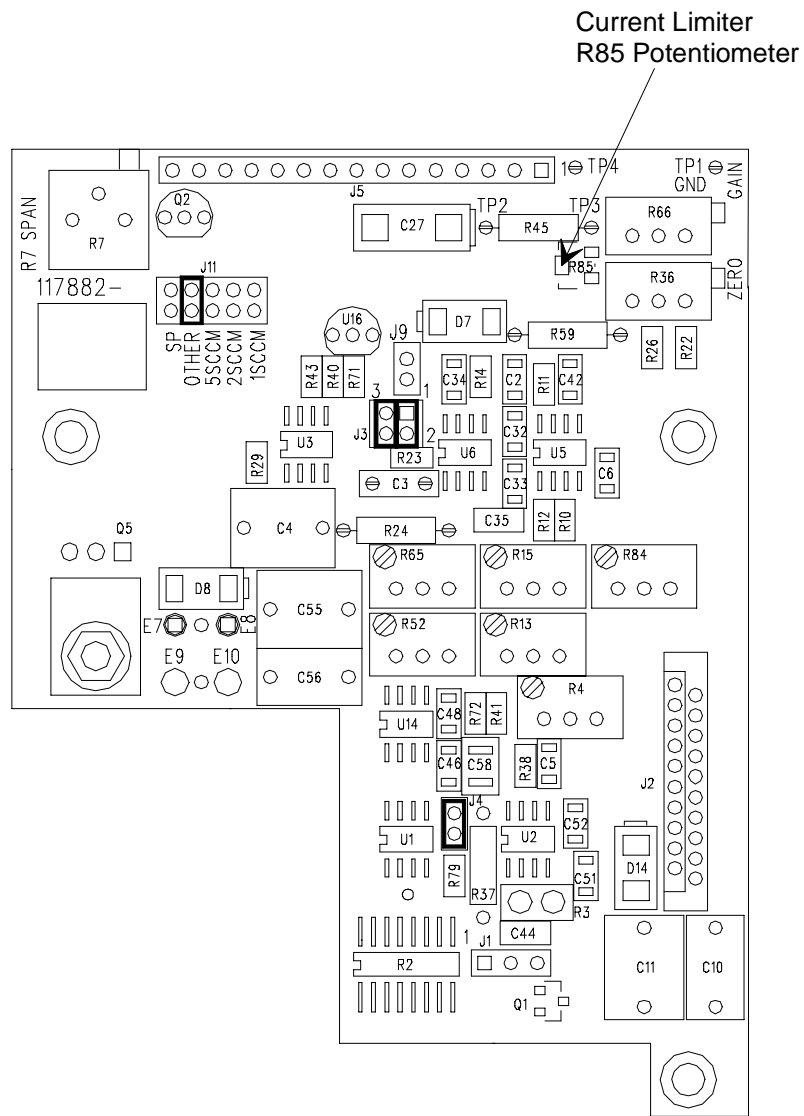

Figure 10: Location of the R85 Potentiometer on the PC Board

This page intentionally left blank.

Appendix A: Product Specifications

Performance Specifications

Accuracy ¹	± 1% F.S.
CE Compliance ^{2, 3}	EMC Directive 89/336/EEC
Control Range (MFC only)	2.0 to 100% F.S.
Controller Settling Time ⁴ (MFC only)	<2 seconds (to within 2% of set point)
Full Scale Ranges (nitrogen equivalent)	10, 20, 50, 100, 200, 500, 1000, 2000, 5000, 10,000, 20,000, 30,000 sccm
Maximum Inlet Pressure	150 psig
Operational Differential Pressure ⁵	
≤ 5000 sccm	10 to 40 psid
10,000 to 30,000 sccm	15 to 40 psid
Pressure Coefficient	0.02% Rdg./psi
Repeatability (MFC only)	± 0.2% F.S.
Resolution (measurement)	0.1% F.S.
Temperature Coefficients	
Zero	< 0.05% F.S./° C (500 ppm)
Span	<0.08% of Rdg/° C (800 ppm)
Warm up Time (to within 0.2% of steady-state)	2 minutes

¹Includes non-linearity, hysteresis, and non-repeatability referenced to 760 mmHg and 0° C.

²An overall metal braided, shielded cable, properly grounded at both ends, is required during use.

³Units with Edge Card connectors are not CE compliant.

⁴Controller settling time per SEMI E17-91, specified for flows starting from 0 to 10% (or greater) F.S.

⁵Operational differential pressure is referenced to an MFC outlet pressure at atmosphere.

Environmental Specifications

Storage Humidity Range	0 to 95% relative humidity, non-condensing
Operating Temperature	0° to 50° C (32° to 122° F)
Storage Temperature	-20° to 50° C (-4° to 122° F)

Electrical Specifications

Connector Options	9-pin Type “D”, 15-pin Type “D” 20-pin Edge Card, Digital RS-485, Digital DeviceNet
Input Voltage/Current Required	
Maximum at Start Up (first 5 seconds) ⁶	±15 VDC (±5%) @ 200 mA
Typical at Steady State	±15 VDC (±5%) @ 100 mA
Output Impedance	< 1 ohm
Output Signal/Minimum Load	0 to 5 VDC into > 10K ohm
Set Point Command Signal (MFC only)	0 to 5 VDC from < 20K ohm

⁶Add 100 mA to start up current if the valve is energized.

Physical Specifications

Body (height x width x length) <i>without fittings</i>	<5.5 in x ≤ 1.5 in x 3 in <14.0 cm x ≤ 3.8 cm x 7.6 cm
Fittings	Swagelok® 4-VCR® male compatible Swagelok 4-VCO® (male) compatible, ¼" Swagelok compatible
Internal Surface Area (500 sccm unit)	7.7 in ² (49.7 cm ²)
Internal Volume (500 sccm unit)	0.27 in ³ (4.43 cm ³)
Leak Integrity	
External (scc/sec He)	< 1 x 10 ⁻⁹
Through closed valve (MFC only)	< 1.0% F.S. @40 psi
Materials Wetted	
Body and Valve Seat	316L SST, nickel, Elgelloy
Seals	Viton®, Buna-N, Kalrez® Neoprene, all-metal
Weight	≤1.9 lbs (0.86 kg)

Due to continuing research and development activities, these product specifications are subject to change without notice.

This page intentionally left blank.

Appendix B: Model Code Explanation

Model Code

Use the MKS Type 1179 Mass-Flo® Controller (MFC) when both gas flow control and measurement are required. The instrument is available with the flow control valve in a normally closed configuration. Use the MKS Type 179 Mass-Flo® Meter (MFM) when only gas measurement is required.

The desired instrument and options are identified in the model code when you order the unit. All parts of the product code apply to both the mass flow controller and the mass flow meter.

The model code is identified as follows:

XXXXAXXXYZCA

where:

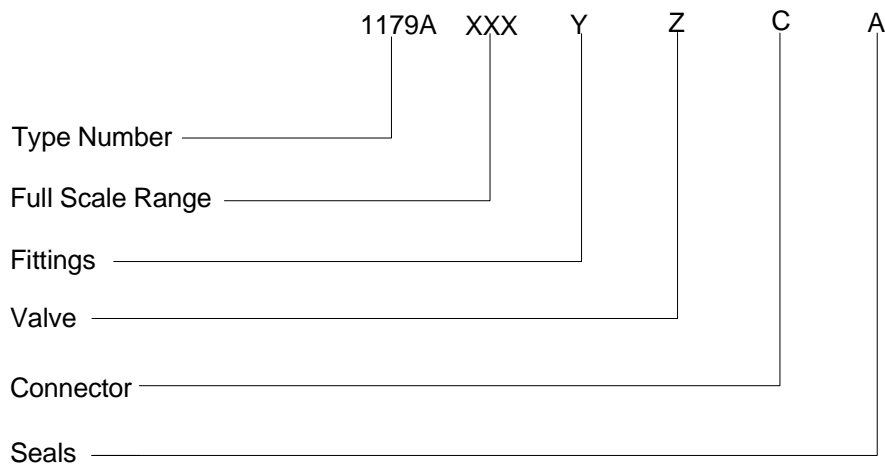

Type Number (XXXXA)

This designates the model number of the instrument.

The mass flow controller is identified as the Type 1179A.

The mass flow controller and a positive shutoff valve is identified as the Type 2179A.

The mass flow meter is identified as the Type 179A.

Full Scale Range - sccm of Nitrogen (XXX)

The full scale range is indicated by a two digit / one letter code.

	Ordering Code
10	11C
20	21C
50	51C
100	12C
200	22C
500	52C
1,000	13C
2,000	23C
5,000	53C
10,000	14C
20,000	24C

Fittings (Y)

Three types of fittings are available, designated by a single letter code.

	Ordering Code
Swagelok 4-VCR Male	R
Swagelok 4-VCO Male	G
Swagelok 1/4" tube	S
Length adapter with VCR fittings	L
Length adapter with Swagelok fittings	W

Valve (Z)

Two valve configurations are available, designated by a single number code.

	Ordering Code
Normally Closed (Type 1179 MFC <i>only</i>)	1
No Valve (Type 179 MFM <i>only</i>)	3

Connector (C)

The type of connector is indicated by a single code.

	Ordering Code
9-pin Type "D"	A
15-pin Type "D"	B
20-pin Edge Card	C
Digital RS-485	5
Digital, DeviceNet*	6
* <i>Consult factory for availability</i>	

Seals (A)

The seal material is indicated by a single letter code.

	Ordering Code
Viton, standard	V
Neoprene (with Kel-F plugs)	N
Buna-N (with Kel-F plugs)	B
Kalrez (with Kel-F plugs)	K
All-metal (Type 179 MFM <i>only</i>)	M

How To Order a Mass Flow Controller

To order the Type 1179 MFC with a 500 sccm full scale range, Swagelok 4-VCR fittings, a normally closed valve, 15-pin Type "D" connector, and Viton sealing materials, the product code is:

1179A 52C R 1 B V

How To Order a Mass Flow Meter

To order the Type 179 MFM with a 500 sccm full scale range, Swagelok 4-VCR fittings, 15-pin Type "D" connector, no valve, and all-metal sealing materials, the product code is:

179A 52C R 3 B M

This page intentionally left blank.

Appendix C: Gas Correction Factors

Common Gases

GAS	SYMBOL	SPECIFIC HEAT, Cp cal/g ^o C	DENSITY g/l @ 0 ^o C	CONVERSION FACTOR
Air	---	0.240	1.293	1.00
Ammonia	NH ₃	0.492	0.760	0.73
Argon	Ar	0.1244	1.782	1.39 ¹
Arsine	AsH ₃	0.1167	3.478	0.67
Boron Trichloride	BCl ₃	0.1279	5.227	0.41
Bromine	Br ₂	0.0539	7.130	0.81
Carbon Dioxide	CO ₂	0.2016	1.964	0.70 ¹
Carbon Monoxide	CO	0.2488	1.250	1.00
Carbon Tetrachloride	CCl ₄	0.1655	6.86	0.31
Carbon Tetrafluoride (Freon - 14)	CF ₄	0.1654	3.926	0.42
Chlorine	Cl ₂	0.1144	3.163	0.86
Chlorodifluoromethane (Freon - 22)	CHClF ₂	0.1544	3.858	0.46
Chloropentafluoroethane (Freon - 115)	C ₂ ClF ₅	0.164	6.892	0.24
Chlorotrifluoromethane (Freon - 13)	CClF ₃	0.153	4.660	0.38
Cyanogen	C ₂ N ₂	0.2613	2.322	0.61
Deuterium	D ₂	1.722	0.1799	1.00
Diborane	B ₂ H ₆	0.508	1.235	0.44
Dibromodifluoromethane	CBr ₂ F ₂	0.15	9.362	0.19
Dichlorodifluoromethane (Freon - 12)	CCl ₂ F ₂	0.1432	5.395	0.35
Dichlorofluoromethane (Freon - 21)	CHCl ₂ F	0.140	4.592	0.42
Dichloromethylsilane	(CH ₃) ₂ SiCl ₂	0.1882	5.758	0.25

(Table continued on next page)

GAS	SYMBOL	SPECIFIC HEAT, Cp cal/g°C	DENSITY g/l @ 0°C	CONVERSION FACTOR
Dichlorosilane	SiH ₂ Cl ₂	0.150	4.506	0.40
1,2-Dichlorotetrafluoroethane (Freon - 114)	C ₂ Cl ₂ F ₄	0.160	7.626	0.22
1,1-Difluoroethylene (Freon - 1132A)	C ₂ H ₂ F ₂	0.224	2.857	0.43
2,2-Dimethylpropane	C ₅ H ₁₂	0.3914	3.219	0.22
Ethane	C ₂ H ₆	0.4097	1.342	0.50
Fluorine	F ₂	0.1873	1.695	0.98
Fluoroform (Freon - 23)	CHF ₃	0.176	3.127	0.50
Freon - 11	CCl ₃ F	0.1357	6.129	0.33
Freon - 12	CCl ₂ F ₂	0.1432	5.395	0.35
Freon - 13	CClF ₃	0.153	4.660	0.38
Freon - 13 B1	CBrF ₃	0.1113	6.644	0.37
Freon - 14	CF ₄	0.1654	3.926	0.42
Freon - 21	CHCl ₂ F	0.140	4.592	0.42
Freon - 22	CHClF ₂	0.1544	3.858	0.46
Freon - 23	CHF ₃	0.176	3.127	0.50
Freon - 113	C ₂ Cl ₃ F ₃	0.161	8.360	0.20
Freon - 114	C ₂ Cl ₂ F ₄	0.160	7.626	0.22
Freon - 115	C ₂ ClF ₅	0.164	6.892	0.24
Freon - 116	C ₂ F ₆	0.1843	6.157	0.24
Freon - C318	C ₄ F ₈	0.185	8.397	0.17
Freon - 1132A	C ₂ H ₂ F ₂	0.224	2.857	0.43
Helium	He	1.241	0.1786	.- - -2
Hexafluoroethane (Freon - 116)	C ₂ F ₆	0.1843	6.157	0.24
Hydrogen	H ₂	3.419	0.0899	.- - -2
Hydrogen Bromide	HBr	0.0861	3.610	1.00

(Table continued on next page)

GAS	SYMBOL	SPECIFIC HEAT, Cp cal/g ^o C	DENSITY g/l @ 0 ^o C	CONVERSION FACTOR
Hydrogen Chloride	HCl	0.1912	1.627	1.00
Hydrogen Fluoride	HF	0.3479	0.893	1.00
Isobutylene	C ₄ H ₈	0.3701	2.503	0.29
Krypton	Kr	0.0593	3.739	1.543
Methane	CH ₄	0.5328	0.715	0.72
Methyl Fluoride	CH ₃ F	0.3221	1.518	0.56
Molybdenum Hexafluoride	MoF ₆	0.1373	9.366	0.21
Neon	Ne	0.246	0.900	1.46
Nitric Oxide	NO	0.2328	1.339	0.99
Nitrogen	N ₂	0.2485	1.250	1.00
Nitrogen Dioxide	NO ₂	0.1933	2.052	-. - -2
Nitrogen Trifluoride	NF ₃	0.1797	3.168	0.48
Nitrous Oxide	N ₂ O	0.2088	1.964	0.71
Octafluorocyclobutane (Freon - C318)	C ₄ F ₈	0.185	8.937	0.17
Oxygen	O ₂	0.2193	1.427	0.993
Pentane	C ₅ H ₁₂	0.398	3.219	0.21
Perfluoropropane	C ₃ F ₈	0.194	8.388	0.17
Phosgene	COCl ₂	0.1394	4.418	0.44
Phosphine	PH ₃	0.2374	1.517	0.76
Propane	C ₃ H ₈	0.3885	1.967	0.36
Propylene	C ₃ H ₆	0.3541	1.877	0.41
Silane	SiH ₄	0.3189	1.433	0.60
Silicon Tetrachloride	SiCl ₄	0.1270	7.580	0.28
Silicon Tetrafluoride	SiF ₄	0.1691	4.643	0.35
Sulfur Dioxide	SO ₂	0.1488	2.858	0.69

(Table continued on next page)

GAS	SYMBOL	SPECIFIC HEAT, Cp cal/g ^o C	DENSITY g/l @ 0 ^o C	CONVERSION FACTOR
Sulfur Hexafluoride	SF ₆	0.1592	6.516	0.26
Trichlorofluoromethane (Freon - 11)	CCl ₃ F	0.1357	6.129	0.33
Trichlorosilane	SiHCl ₃	0.1380	6.043	0.33
1,1,2-Trichloro - 1,2,2-Trifluoroethane (Freon - 113)	CCl ₂ FCFClF ₂ or (C ₂ Cl ₃ F ₃)	0.161	8.360	0.20
Tungsten Hexafluoride	WF ₆	0.0810	13.28	0.25
Xenon	Xe	0.0378	5.858	1.32

¹Empirically defined²Consult MKS Instruments, Inc. for special applications.

NOTE: Standard Pressure is defined as 760 mmHg (14.7 psia). Standard Temperature is defined as 0°C.

Appendix D: MFC Sizing Guidelines

General Information

To select the correct MFC for an application, you must determine the:

- flow controller range
- appropriate valve configuration

The flow controller range depends on the desired flow rate and the gas correction factor for the gas to be used. MKS states the flow controller ranges based on flow rate of nitrogen; the flow rate for other gases may vary.

The proper valve configuration depends upon the flow range, inlet pressure, differential pressure across the unit, and density of the gas. Proper valve configurations have been established for all standard flow ranges flowing nitrogen under standard operating pressures. These configurations are suitable for virtually all gases and pressure conditions.

How To Determine the Flow Controller Range

The Type 1179 controller is available in ranges of 10, 20, 50, 100, 200, 500, 1000, 2000, 5000, 10,000, 20,000, and 30,000 sccm (N₂ equivalent). To select the appropriate range, you must determine the flow rate of nitrogen that is equivalent to the flow rate of the desired gas. Calculate the ratio of the GCF of nitrogen (1.00) to the GCF of the desired gas (refer to *Appendix C: Gas Correction Factors*, page 65) as shown in the following example.

Example:

You need a flow rate of 250 sccm of argon (Ar). What range flow controller should you use?

1. Find the Gas Correction Factor of Ar (refer to *Appendix C: Gas Correction Factors*, page 65).

The GCF for Ar is 1.41.

2. Insert the GCF of Ar in the following formula:

$$\frac{(\text{GCF of N}_2)}{(\text{GCF of Ar})} = \frac{(x)}{(\text{Desired flow rate of Ar})}$$

where x is the equivalent flow rate of nitrogen (sccm).

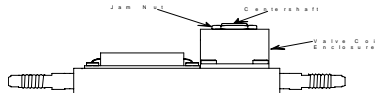

$$x = 177 \text{ sccm N}_2$$

A flow rate of 250 sccm of Ar will produce a flow rate equivalent to 177 sccm of N₂. This falls within the range of a 200 sccm flow controller.

When calculating equivalent N₂ flows using gas correction factors, be sure to use a flow controller with a sufficient flow rate range. For example, if the calculated equivalent N₂ flow in the example shown above is 205 sccm, use a 500 sccm flow controller. The 500 sccm instrument can then be calibrated such that 205 sccm N₂ = full scale.

Note



When using a gas with a density *higher* than nitrogen, be sure that the control valve Full Scale range can accommodate the desired flow rate. Please call the MKS Applications group if you have any questions.

How To Determine the Valve Configuration

1. Determine the maximum flow coefficient (C_v), for the gas of interest, using the equation:

$$C_v (\text{max}) = \left(\text{Max. Flow Rate, sccm} \right) \left(\sqrt{\frac{\text{Gas Density}}{1.293}} \right) \left(C_v \text{ Pressure Factor} \right)$$

where:

Gas Density is listed in *Appendix C: Gas Correction Factors*, page 65.

C_v *Pressure Factor* is listed in Table 12, page 71.

C_v Pressure Factors (multiplied by 100,000)										
P1 (psia)	Differential Pressure (psid)									
	50	40	30	20	15	10	5	2	1	0.5
165	0.042	0.046	0.052	0.063	0.072	0.087	0.122	0.192	0.272	0.384
150	0.044	0.048	0.055	0.066	0.075	0.092	0.128	0.202	0.285	0.403
125	0.049	0.054	0.061	0.073	0.083	0.101	0.141	0.221	0.312	0.441
100	0.058	0.062	0.069	0.082	0.094	0.113	0.158	0.248	0.349	0.493
75	0.077	0.077	0.082	0.097	0.110	0.132	0.183	0.286	0.404	0.570
50	0.116	0.116	0.116	0.123	0.138	0.164	0.226	0.352	0.495	0.699
30	—	—	0.194	0.194	0.194	0.220	0.297	0.458	0.642	0.904
25	—	—	—	0.232	0.232	0.246	0.329	0.503	0.704	0.991
20	—	—	—	0.291	0.291	0.291	0.373	0.565	0.789	1.109
15	—	—	—	—	0.387	0.387	0.441	0.659	0.915	1.283
10	—	—	—	—	—	0.578	0.581	0.821	1.131	1.578
5	—	—	—	—	—	—	1.156	1.232	1.643	2.261
2	—	—	—	—	—	—	—	2.890	2.905	3.725
1	—	—	—	—	—	—	—	—	5.779	5.811

Table 12: C_v Pressure Factors

2. Select the valve configuration with the C_v value that is closest to, though larger than, the C_v value calculated in step 1.

The C_v value represents the *maximum* flow rate for the unit. Choose the valve configuration *above* your calculated C_v value to ensure that the unit can deliver the required flow.

Valve Configuration Selection Guide		
Valve Configuration	Nominal Range (N₂) sccm	C_v x 10⁵
1	10	2.44
2	20	4.88
3	50	12.21
4	100	24.42
5	200	48.84
6	500	122.11
7	1000	244.22
8	2000	488.44
9	5000	1221.11
10	10000	1924.47
11	20000	3848.94
12	30000	5773.41

Table 13: Valve Configuration Selection Guide

Example

Suppose you need to flow boron trichloride at a rate of 250 sccm and the inlet pressure is 20 psia. Your process runs at atmospheric pressure, so the differential pressure is 5 psid.

1. Determine the maximum flow factor (C_V) for the gas of interest, using the equation listed in step 1, on page 71.

The *Gas Density* for boron trichloride, listed in *Appendix C: Gas Correction Factors*, page 65, is 5.227. The *C_V Pressure Factor*, read from Table 12, page 71, for a 20 psia inlet and 5 psid differential pressure, is 0.373. Therefore, our equation becomes:

$$C_V (\text{max}) = \left(250 \text{ sccm} \right) \left(\sqrt{\frac{5.227}{1.293}} \right) \left(0.373 \right)$$

$$C_V = 187.5$$

2. Select the valve configuration with a C_V value that is closest to, though larger than, the C_V value calculated in step 1.

A C_V value of 187.5 falls between 122.11 (configuration 6) and 244.22 (configuration 7). To ensure that the unit can deliver the 250 sccm flow, choose configuration 7.

This page intentionally left blank.

Appendix E: Positive Shutoff Valve Information

How To Operate the Positive Shutoff Valve

The Type 2179 mass flow controller includes a NUPRO® positive shutoff valve. The positive shutoff valve is a normally closed, air actuated valve, therefore, you must connect an air supply to operate the valve. The air supply should be between 70 and 80 psig.

The valve opens when air is supplied to the valve; the air pressure must be released for the valve to close. NUPRO offers several 2-way solenoid valves which can serve this purpose. When the solenoid is energized, the air pressure is applied to the actuator of the positive shutoff valve, so the valve opens. When the solenoid is de-energized, the air supply is disconnected from the positive shutoff valve and the actuator is vented to atmosphere, so the valve closes.

Suitable NUPRO solenoid valves are listed in Table 14.

Suitable Two-Way Solenoid Valves		
For BN Valves	All Others	Operating Voltage
MS-SOL-1K-BN	MS-SOL-1K	24 VDC
MS-SOL-2K-BN	MS-SOL-2K	110/120 VAC
MS-SOL-3K-BN	MS-SOL-3K	24 VAC
MS-SOL-4K-BN	MS-SOL-4K	12 VDC
MS-SOL-5K-BN	MS-SOL-5K	220/240 VAC
MS-SOL-6K-BN	MS-SOL-6K	5 VDC

Table 14: Suitable Two-Way Solenoid Valves

Figure 11 shows how to connect the 2179 MFC to the solenoid valve.

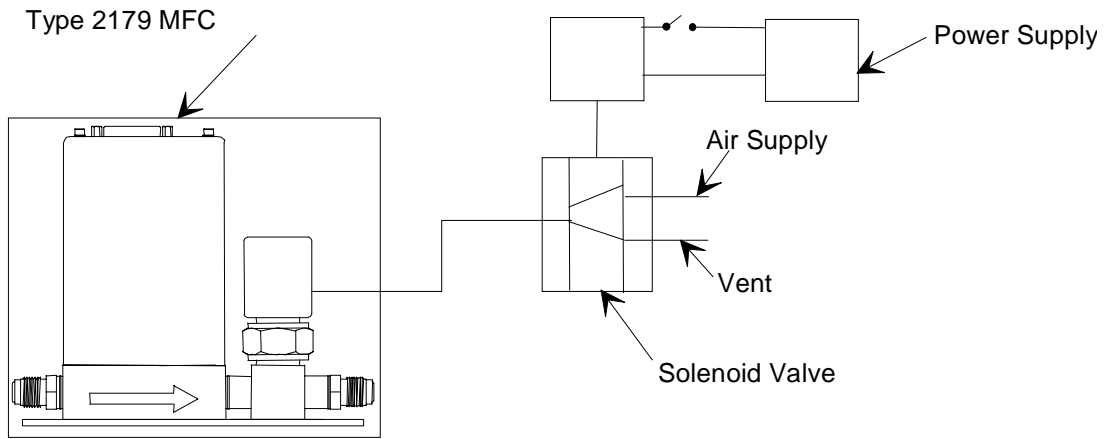

Figure 11: Connecting the Type 2179 MFC to a Solenoid Valve

Index

A

Ambient operating temperature, 23

C

Cleanliness features, 18

Connections, 29

Connector

 Edge Card, 33

 Type "D", 32, 34

Control circuitry, 46

Control valve, 38

Customer support, 20

D

Design, 17

Dimensions, 27

E

Electrical, 23

Environmental requirements, 23

F

Fittings, 29

Flow path, 45

G

Gas connections, 29

Gas correction factors

 description of, 35

 gas mixtures, 36

 pure gases, 35

 reference temperature, 35

I

Interface cables, 24

Interface connectors, 24

Introduction, 17

L

Leak rate, 31

Leak testing, 50

M

Maintenance, 47

Manual organization, 19

Measurement technique, 45

Mounting, 29

N

Nupro valve, 30, 31

P

Performance specifications, 57, 58, 59

PID control, 46

Power requirements, 23

R

Reliability, 18

Repair, 48

Returns, 20, 21

S

Safety information, 1–16

Set point, 17

Setup, 26

Specifications

performance, 57, 58, 59

T

Troubleshooting, 49

U

Unpacking, 21

 checklist, 22

 opening, 21

V

Valve

 adjustment, 50

 override, 42

Z

Zero, 40