

**BENCH & FLOOR TYPE  
HARDNESS TESTERS**

**2017**



© INNOVATEST Europe BV

**Edition:**  
**Bench & Floor type hardness testing 2017**

Changes in products and/or product specifications can emerge due to new technologies and continuous development. We reserve the right to change or modify specifications of products without prior notice. We recommend you to contact our sales office for up-to-date information.

© All rights reserved

**Trademarks:**

INNOVATEST®, INNOVATECH®, MASTERBLOCK®, IMPRESSIONS™ are trade names of INNOVATEST/INNOVATECH Group of Companies.

All other brands and trade names are the unconditional property of their respective owners.

**WWW.INNOVATEST-EUROPE.COM**

# About us

## INNOVATEST® Group of companies

With its foundation laying in the 19th century (1890) INNOVATEST® has a rock solid position in the market of materials testing instruments, optical measuring equipment and general testing instruments such as surface roughness, wall thickness, vibration, and other portable testing equipment.

For the last 28 years, the owners have largely invested in the product tier Hardness Testing, while still keeping their focus on other product lines.

### Commitment

With a wide range -, fit to any budget -, offering both traditional and state-of-the-art testing instruments, INNOVATEST® is one of the market leaders in hardness testing solutions.

Committed to solve your testing problem and not just selling products:

- Solution driven
- High quality standard
- Traditional and state-of-the art technology
- Solutions and technology that fit your budget
- Global sales network
- Global service capabilities
- Superior guarantee system

### Development

A significant part of our revenues combined with European and local government funding are continuously invested in new product development. With our eyes firmly focused on the future, we are committed to advance and innovate our product line, in order to be a competent market player, offering our customers reliable, "fit for purpose" technology and affordable service and support.

The VERZUS™ series of Load Cell Closed Loop hardness testers are just a first step towards implementing new technologies. The NEMESIS 9000™ will change the way we look at hardness testing for ever.

New machine vision systems will complete hardness testing technology, while new materials offer the possibility to develop more advanced multifunction equipment.

### Service and calibration

We have confidence in our products. Therefore we offer a (limited) guarantee of 2 years or longer on all our products. All products are supplied with a quality and guarantee certificate and a service passport. Our modern workshops and professional technical staff offer service on demand, at any time and at any location in the world. First line, local after sales service and support.

### Product portfolio

INNOVATEST® develops and manufactures hardness testing instruments, accessories and machine vision systems as well as tester automation. The company further supplies a range of optical instruments such as microscopes, profile projectors, vision measuring systems, roughness testers, wall thickness testers, coating thickness gauges, vibration meters and other quality assurance instruments.

Our goal is to bring you confidence and to reach absolute customer satisfaction by offering high quality affordable instruments and an ever lasting service.

We welcome you to challenge us.

R.H.J.M. Engbersen  
Managing Director  
Chief Executive Officer

# Hardness testing

## Hardness

Hardness is the property of a material enabling it to resist plastic deformation, usually by penetration of another object. The term “hardness” may also refer to stiffness, temper or resistance to bending, scratching, abrasion or cutting. Scientists and journalists often confuse stiffness with hardness. This however is incorrect. Osmium (platinum family) is stiffer than diamond but not as hard as diamond. In materials science there are three principal operational definitions of hardness:

- **Scratch hardness:**  
Resistance to fracture or plastic (permanent) deformation due to friction from a sharp object.
- **Indentation hardness:**  
Resistance to plastic (permanent) deformation due to a constant load from a sharp object.
- **Rebound hardness:**  
Height or speed of the bounce of an object dropped on the material, related to elasticity.

## Measuring hardness

Hardness is not an intrinsic material property. There are no precise definitions in terms of fundamental units of mass, length and time. A hardness property value is the result of a defined measurement procedure. Hardness of materials has probably long been assessed by resistance to scratching or cutting. An example would be material B scratches material C, but not material A. Alternatively, material A scratches material B slightly and scratches material C heavily.

The usual method to obtain a hardness value is to measure the depth or area of an indentation left by an indenter of a specific shape, with a specific force applied for a specific time. There are several principal standard test methods to express the relationship between hardness and the size of the impression or the rebound velocity on specific materials. Vickers, Rockwell, Brinell and Leeb are the most common scales. For practical and calibration reasons, each of these methods is divided into a range of scales, defined by a combination of applied load and indenter geometry or in case of the rebound method, by the weight of the impact body.

# Hardness testing

## Most common hardness tests

### Rockwell (HR scales)

Indenting the test material with a diamond cone (HRC) or hardened (tungsten) steel ball indenter (HRB etc.) applying a preload of 10Kgf first and a main test force of 60Kgf, 100Kgf, or 150Kgf.

### Rockwell Superficial (HR scales)

Indenting the test material with a diamond cone or hardened (tungsten) steel ball indenter, depending on the scale preliminary set. The Superficial Rockwell scales use lower force and shallower impressions on brittle and very thin materials. Applying a preload of 3Kgf first and a main test force of 15Kgf, 30Kgf, or 45Kgf.

### Vickers (HV)

Indenting the test material with a diamond indenter, in the form of an inverted perfect pyramid with a square base and an angle of 136 degrees between opposite faces, subjected to test forces of 1Kgf to 120Kgf.

A microscope or USB camera is used to visualize and measure the indentation.

### Micro Vickers (HV)

Indenting the test material with a diamond indenter, in the form of an inverted perfect pyramid with a square base and an angle of 136 degrees between opposite faces, subjected to test forces usually not exceeding 1Kgf.

A precision microscope or high resolution USB camera is used to visualize and measure the indentations, magnifications up to 600x are most common. However, magnifications up to 1000x are becoming popular as well.

### Knoop (HK)

Indenting the test material with a "elongated" diamond pyramid, subjected to test forces usually not exceeding 1Kgf.

A precision microscope or high resolution USB camera is used to visualize and measure the indentations, magnifications up to 600x are most common.

### Brinell (HB)

Indenting the to be tested material with a 1, 2.5, 5, or 10mm diameter hardened steel or carbide ball subjected to a load/force ranging from 1kg to 3000kg. A microscope or USB camera is used to visualize and measure the rather large indentations.

### Leeb (HL) (rebound method)

Portable hardness testing.

An impact body which has a spherical tungsten carbide tip, is impelled onto the test surface by spring force.

The impact creates a plastic deformation of the surface, an indentation, due to which the impact body loses part of its original speed (or energy). Consequently, the softer the material is, the more speed will be lost at rebound of the impact body.

Applicable for a wide variety of components, minimum test requirements should be obeyed.

### Ultrasonic (UCI)

Portable hardness testing.

A Vickers shaped diamond indenter fixed on a vibrating rod that presses on the test surface with a specific force and then measures its hardness by applying ultrasonic vibrations and analyzing its damping effect.

Commonly used for small, thin components that cannot be tested by rebound hardness testers.

# Hardness testing

## Most common hardness tests

### Shore (HS scales)

Portable (rubber/plastics) hardness testing.

The hardness value is determined by pressing the indenter foot firmly onto the sample. The indenter is connected to a linear measuring device and measures the indent depth which is then converted through a mechanical or an electronical system to the Shore value. The deeper the indent, the softer the material.

### IRHD

Measures the indentation resistance of elastomeric or rubber materials based on the depth of penetration of a ball indenter. An initial contact force is applied to a 1, 2.5 or 5mm ball indenter and the penetration is set to zero.

The force is increased to a specified total load and the depth of the penetration is measured. The IRHD value is related to the depth of indenter penetration.

The method is commonly used for testing small parts and O-rings.

### Webster

Portable hardness testing.

The object to be tested is placed between the anvil and the penetrator.

Pressure is then applied to the handles until "bottom" is felt, at which time the dial indicator is read.

There are different types of indenters and different force settings for different materials.

## Less common hardness scales

The following hardness methods are less frequently used or superseded by other methods:

- **HM** Martens (instrumented indentation testing, formerly HU – universal hardness)
- **H** Ball indentation hardness
- **HVT** Modified Vickers method, depth measurement
- **HBT** Modified Brinell method, depth measurement
- **BARCOL** Impression hardness



# Service

## Installation of your tester



### **Rest assure with a proper installation.**

INNOVATEST® engineers have installed thousands of hardness testers worldwide.

Against reasonable costs, you can count on our expertise to make the installation of your valuable tester a success.

Our service team is equipped with load cells and test materials traceable to international standards.

The final check list and final testing will be done in your presence, ensuring you of a good working machine, properly installed and meeting its all over specifications when our engineers leave.

## Relocation of your equipment

Hardness testing instruments are sensitive equipment. They need to be installed on a solid table, in a vibration free environment. After installation, hardness testers cannot just be relocated to another area without taking proper precautions. Our experienced engineering team can advise you on how to move your tester or better, take care of the detailed planning, transport preparation, reinstalling, calibration and certification of your tester.

## Product training



### **Product training, user interface & test sample familiarization**

We offer training packages for each of our instruments in our well equipped training center. A one or two days course can be done directly after the installation of your equipment (on location).

Alternatively, it is also possible to do a full training at our facilities in The Netherlands.

# Service

## Support Desk



If you are in need of any immediate advice or assistance with regards to any of our products, contact the INNOVATEST® support desk at +31-43-3520060. In many cases, the support desk can offer immediately assistance to answer any questions you might have or solve any problem fast and effectively.

## Software customizing

In the early stage of your interest in our testers, our sales team will gather the required information to offer a product adapted to your individual requirements. Do not hesitate and ask for customized solutions on both software and hardware. In close cooperation with our customers we will develop and supply the right configuration for your job.

## Mechanical & software customizing



INNOVATEST® has developed many customized testers for particular testing tasks such as testing of irregular components at high and low temperatures. But also specific testing cases such as the testing of bullet shells (casings). We also design special fixtures to hold your sample perfectly in position.

Our testers can be equipped with motorized spindles, rotary tables, inclination systems, while workpiece positioning by robots are nowadays common requests.

## Service & maintenance



Reduce your possible down time risk. INNOVATEST® Service is available to do a regular check and standard maintenance on any of our testers regardless of the location. Regular service avoids unpleasant surprises.

At the same time our staff can update the standard software, if such updates are available. If in spite of regular service and good maintenance a tester is faulty, you can count on our service staff to be available at your request. (See also our general sales conditions).



# Service

## Calibration



Count on the broad experience of the INNOVATEST® service personnel for yearly calibration of your hardness testing machines.

Reference measuring equipment traceable to international standards such as ISO & ASTM make part of our calibration set.

Our calibration, which includes possibly required adjusting, assures reliable testing results.

## Rental equipment

On many occasions INNOVATEST® will be able to offer you rental equipment if a short or long term lease will be more attractive than buying.

In particular we offer rental options for a wide range of portable instruments or leasing options for a wide range of bench hardness testers.

**Ask our sales department for rates and arrangements.**



# Table of contents

## Index

<b>Introduction</b>	<b>3-9</b>
<b>Company information</b>	<b>3</b>
<b>Hardness testing</b>	<b>4-6</b>
<b>Service</b>	<b>7-9</b>
<b>Bench hardness testing</b>	<b>12-59</b>
<b>IMPRESSIONS™</b>	<b>11</b>
<b>Rockwell hardness testing</b>	<b>12-23</b>
600A and 600MBDL	15
NEXUS 605RS & NEXUS 605RSB	16
NEXUS 610RS & NEXUS 610RSB	17
VERZUS 710RS & VERZUS 710RSB	18
	18
NEMESIS 9000RS	20
NEMESIS 9000RSB	21
NEMESIS 9500RS	22
NEMESIS 9503RSB	23
<b>Vickers hardness testing</b>	<b>24-35</b>
FALCON 450/450XL	26-27
FALCON 500	28-29
FALCON 5000	30-31
NOVA 130/240 & Micro-Vickers & Knoop indent measuring vision systems	32-33
NOVA 330/360 Micro/Macro Vickers & Brinell indent measuring vision systems	34-35
<b>Brinell hardness testing</b>	<b>36-45</b>
NEXUS 3001 series	38
NEXUS 3200 series	39
NEXUS 3001XLM-IMPRESSIONS™	40
NEXUS 8003HBT BIOS	41
NEXUS 8003HBT XXL BIOS	42
NEMESIS 9503HBT BIOS	43
NEMESIS 9803HBT BIOS	44
HB100	45
<b>Universal hardness testing</b>	<b>46-59</b>
VERZUS 700AS	48
VERZUS 750CCD	49
NEMESIS 9000 series	50
NEMESIS 9001M	51
NEXUS 7501	52
NEXUS 8000 series	53
NEXUS 8000XL series	54
NEMESIS 9500 series	55
NEMESIS 9800 series	56
Single indenter test head	58
Universal test head with turret	59
<b>Portable hardness testing</b>	<b>60-61</b>
MET-U1A & Webster WH100 series	61
<b>Bench stands</b>	<b>63-65</b>
<b>Testblocks &amp; Indenters</b>	<b>66-67</b>

# IMPRESSIONS™

## IMPRESSIONS™ software

Hardness testing workflow control & user interface.

Hardness testing and work flow control software with full tester control functionality, easy to operate intuitive controls and a number of graphical presentations. IMPRESSIONS™ has been developed on a concept following the normal sequential procedures related to the particular hardness test (standard), such as:  
preparing and setting up the test, executing the test, reviewing and editing results, and managing and reporting data.

No need to change pages or tab to another screen. All common tester functionality can be selected directly from the main screen without the need to view any other screen. Less frequently used settings are in sub menus that can be reached simply by a touch of on the high resolution screen.

The progress indicator follows and guides you through the natural workflow of the hardness test, prompting you to input information when needed. No unnecessary and confusing software options are displayed when not needed, as only necessary software functions will be available on the different steps.

As well as full tester control, IMPRESSIONS™ allows you to create an endless variety of standard test programs for retained parts or retained procedures. Setting up your tester from scratch is no longer required as all saved product settings are available in a blink of an eye.

Setting up a test program from scratch requires no more than 10 seconds while it can be stored with name and/or number as per your requirement. IMPRESSIONS™ not only controls the standard operation of your tester. Behind the start button, that will immediately launch the testing procedure, there are many additional functions.

With IMPRESSIONS™, INNOVATEST® has developed a software system, that eliminates user influence on the testing results, while guaranteeing the application of ASTM, ISO or JIS standards in the test process.

High resolution camera technology, overview camera's, automatic turret control, descending test head operation, optical ZOOM system and many additional advanced functions such as;

- Manual indent measurement
- Automatic indent measurement
- Indent ZOOM function
- Automatic focusing
- Unlimited file storage
- Advanced reporting system (PDF or printed)
- Automatic illumination control (LED light sources)
- Pattern configurator
- Automatic pattern testing (for Vickers, Micro Vickers, Rockwell and Brinell)
- Contour scanning of embedded samples
- Weld inspection pattern configurator
- KiC Crack Indent measurement
- Force/depth diagram
- Automatic multi sample Chd/Nht/Rht
- 3D/2D color hardness mapping
- Automatic Jominy testing
- Turret position animation
- Force bar animation
- Indenter position animation



IMPRESSIONS™ has a remote control function and remote update and upgrade functionality.

Training on IMPRESSIONS™ software can be done online, if required at all. The average training time takes no more than 1 or 2 hours and is applicable to all the INNOVATEST® testers running on IMPRESSIONS™.

Industrial computer technology with solid state discs guarantees a lifelong hassle free operation **but most of all; hardness testing control you can rely upon.**

# Rockwell hardness testing

## Rockwell hardness testing

Industrial computer technology with solid state discs guarantees a lifelong hassle free operation but most of all; hardness testing control you can rely upon.

The Rockwell Hardness test is a hardness measurement based on the net increase in depth of impression when a load is applied. Hardness values are commonly given in the A, B, C, R, L, M, E and K scales. The higher the value in each of the scales, the harder the material.

Hardness has been variously defined as resistance to local penetration, scratching, machining, wear or abrasion. In the Rockwell method of hardness testing, the depth of penetration of an indenter under certain arbitrary test conditions is determined. The indenter may either be a steel (carbide) ball of some specified diameter or a spherical diamond-tipped cone of 120° angle and 0.2mm tip radius also called indenter. The type of indenter and the test load determine the hardness scale (A, B, C, etc.)

A minor load of 3kg or 10kg is first applied, causing an initial penetration and holding the indenter in place.

Then, the dial is set to zero and the major load is applied. Upon removal of the major load, the depth reading is taken while the minor load is still on. The hardness number may then be read directly from the scale.

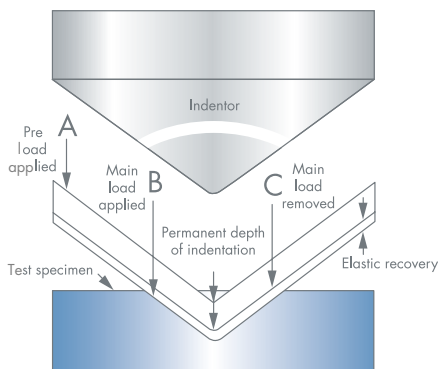

The Rockwell scale characterizes the indentation hardness of materials through the depth of penetration of an indenter, loaded on a material sample and compared to the penetration in some reference material. It is one of several definitions of hardness in materials science. Its hardness values are noted by HR'X' is the letter for the scale used. Hardness relation to strength is that both are measures of the pressure it takes to get plastic deformation to occur in materials.

The Rockwell hardness test was devised by metallurgist Stanley P. Rockwell in Syracuse, NY, around 1919, in order to quickly determine the effects of heat treatment on steel bearing races. The Brinell hardness test, invented in 1900 in Sweden, was slow, not useful on fully hardened steel, and left too large

impressions to be considered non-destructive. Rockwell collaborated with an instrument manufacturer to commercialize his invention and develop standardized testing machines.

## Operation

The determination of the Rockwell hardness of a material involves the application of a minor load followed by a major load, and then noting the depth of penetration, converted to a hardness value directly from a dial or display, in which a harder material gives a higher number. The major advantage of Rockwell hardness is its ability to display hardness values directly, thus obviating tedious calculations involved in other hardness measurement techniques. Also, the relatively simple and inexpensive set-up enables installation under various conditions.

Rockwell testers are typically used in engineering, metallurgy and industrial environments.

The commercial popularity arises from its speed, reliability, robustness, resolution and small area of indentation.

# Rockwell hardness testing

## Good practices

Cleaning indenter and test-piece to be clear of dirt, grease, rust or paint. Measuring on a perpendicular, flat surface (round work correction factors are invoked to adjust for test-piece curvature). Ensuring that the thickness of the test-piece is at least 10 times the depth of the indentation. Maintaining an adequate spacing between multiple indentations. Controlling the speed of indentation and assuring that the load duration (dwell)time is applied correctly.

## Scales and values

The most common used are the "C", and "B" scales. Both express hardness as an arbitrary dimensionless number. The B-scale is used for softer materials (such as aluminum, brass, and softer steels). It employs a tungsten carbide ball as the indenter and a 100-kg weight to obtain a value expressed as "HRB". The C-scale, for harder materials, uses a diamond cone and a 150-kg weight to obtain a value expressed as "HRC". There are several alternative scales for other purposes.

The superficial Rockwell scales use lower loads and shallower impressions on brittle and very thin materials. The 45N scale employs a 45-kg load on a diamond cone-shaped Brale indenter, and can be used on dense ceramics. The 15T scale employs a 15-kg load on a 1/16-inch diameter hardened steel ball, and can be used on sheet metal. Readings below HRC 20 are generally considered unreliable, as are readings much above HRB 100.

### Typical values

Very hard steel (e.g. a good knife blade):

HRC 55 - HRC 62 Axes, chisels, etc.: HRC 40 - 45

Several other scales, including the extensive A-scale, are used for specialized applications.

There are special scales for measuring case-hardened specimen.

ASTM standards

- **E18** Rockwell hardness and Rockwell Superficial hardness of metallic materials

EN-ISO standards

- **6508** Rockwell hardness and Rockwell Superficial hardness of metallic materials

## Dead weight versus force feedback

Traditional dead weight versus force feedback load cell testers

Traditional hardness testers apply test force through a mechanical system of levers & weights.

The required weights can usually be selected by turning a selector knob. The system of weights is complex and may cause load application problems or tester uncertainty.

New technology, making use of highly accurate load cells and state of the art amplifier and filter technology, have reduced 70% of the parts in so called Closed Loop hardness testers. Basically, a motor applies direct force to the load actuator.

The indenter which is mounted on the load cell (force sensor) gives feed back to the computer, which on its turn adjusts the force applied load application motor. All of this in just a fraction of a second. Fast, secure and highly accurate.

INNOVATEST® load cell, closed loop, force feedback Rockwell hardness testers provide a computer controlled load application system that assures superior GR&R results at an unmatched testing cycle speed.

# NEXUS 610 RS Standard frame



# Rockwell hardness testing

## 600A / MA



### 600A

- Traditional dead weight system
- Manual load selection
- **Rockwell Scales:** C, B, A and F
- Manually operated
- Analogue
- Meets or exceeds ISO, ASTM and JIS standards
- Hydraulic load damper

### 600MA

- All specifications according to 600A
- Automatic motorized test cycle

## 600BDL / MBDL



### 600BDL

- Traditional dead weight system
- Manual load selection
- **Rockwell Scales:** A, B, C, D, E, F, G, H, K, L, M, P, R, S and V
- Full color multi-function OLED display; Shape correction settings for curved surfaces, Go/No Go function with visual and acoustic warning, easy calibration function, testing program storage
- Conversion to Vickers, Brinell, Shore, PSI, MPa and Rockwell scales
- Connectivity USB
- Meets or exceeds ISO, ASTM and JIS standards
- Manually operated
- Hydraulic load damper

### 600MBDL

- All specifications according to 600BDL
- Automatic motorized test cycle

# Rockwell/Brinell hardness testing

## NEXUS 605RS



### Rockwell, Superficial Rockwell

- Load cell, force feedback, closed loop system
- Excellent accuracy, best in class GR & R
- Load range 2.5kgf/24.5N up to 187.5kgf/1838N (depending on model)
- **Rockwell Scales:** A, B, C, D, E, F, G, H, K, L, M, P, R, S, V, 15N, 30N, 45N, 15T, 30T, 45T, 15W, 30W, 45W, 15X, 30X, 45X, 15Y, 30Y, 45Y
- Full color multi-function OLED display;
- Fully automatic operation
- Meets or exceeds ISO, ASTM and JIS standards
- Shape correction settings for curved surfaces
- Go/No Go function with color full visual and acoustic warning
- Large memory for test results storage
- Easy calibration function
- Testing program storage
- Standard workpiece clamping attachment
- Connectivity USB-2
- External Brinell microscope (RSB model)
- Large workpiece accommodation

## NEXUS 605RSB



### Rockwell, Superficial Rockwell, Brinell

- Load cell, force feedback, closed loop system
- Excellent accuracy, best in class GR & R
- Load range 2.5kgf/24.5N up to 187.5kgf/1838N (depending on model)
- **Rockwell Scales:** A, B, C, D, E, F, G, H, K, L, M, P, R, S, V, 15N, 30N, 45N, 15T, 30T, 45T, 15W, 30W, 45W, 15X, 30X, 45X, 15Y, 30Y, 45Y
- **Brinell Scales:** HB1/2.5Kgf, 5Kgf, 10Kgf, 30Kgf; HB 2.5/6.25Kgf, 15.625Kgf, 31.25Kgf, 62.5Kgf, 187.5Kgf; HB5/25Kgf, 62.5Kgf, 125Kgf; HB10/100Kgf
- External Brinell microscope

All other specifications as mentioned with NEXUS 601RS



# Rockwell/Brinell hardness testing

## NEXUS 610RS



### Rockwell, Superficial Rockwell

- Load cell, force feedback, closed loop system
- Load range 3Kgf to 150Kgf
- Automatic force setting
- **Rockwell Scales:** A, B, C, D, E, F, G, H, K, L, M, P, R, S, V, 15N, 30N, 45N, 15T, 30T, 45T, 15W, 30W, 45W, 15X, 30X, 45X, 15Y, 30Y, 45Y
- 6.5" Full color multi-function touch screen, embedded micro system controller;
- Windows 7 Embedded, shape correction settings for curved surfaces, Go/No Go function with visual, large memory for measurements with statistic results, report generator, testing program storage
- Easy calibration function
- Unmatched GR & R results in its class
- Excellent accuracy
- Standard workpiece clamping attachment
- Meets or exceeds ISO, ASTM and JIS standards
- Printer & USB (3x), RJ45-LAN, W-LAN (optional), Wi-Fi onboard (optional), Bluetooth (optional) output
- Wireless mouse and keyboard
- Large workpiece accommodation
- Software service over the internet with pre-installed "INNOVATEST® Team Viewer"

## NEXUS 610RSB



### Rockwell, Superficial Rockwell, Brinell

- Load cell, force feedback, closed loop system
- Load range 2.5Kgf to 187.5Kgf
- Automatic force setting
- **Rockwell Scales:** A, B, C, D, E, F, G, H, K, L, M, P, R, S, V, 15N, 30N, 45N, 15T, 30T, 45T, 15W, 30W, 45W, 15X, 30X, 45X, 15Y, 30Y, 45Y
- **Brinell Scales:** HB1/2.5Kgf, 5Kgf, 10Kgf, 30Kgf; HB2.5/6.25Kgf, 15.625Kgf, 31.25Kgf, 62.5Kgf, 187.5Kgf; HB5/25Kgf, 62.5Kgf, 125Kgf; HB10/100Kgf
- External Brinell microscope

All other specifications as mentioned with NEXUS 610RS

# Rockwell/Brinell hardness testing

## VERZUS 710RS



- **Rockwell, Superficial Rockwell, HBT & HVT, Ball indentation for plastic ISO 2039/1**
- Load cell, force feedback, closed loop system
- Load range 1Kgf to 250Kgf
- Automatic force setting
- **Rockwell Scales:** A, B, C, D, E, F, G, H, K, L, M, P, R, S, V, 15N, 30N, 45N, 15T, 30T, 45T, 15W, 30W, 45W, 15X, 30X, 45X, 15Y, 30Y, 45Y
- **HBT Scales:** HBT/5Kgf - 250Kgf;  
**HVT Scales:** HVT/5Kgf - 120Kgf
- **Ball indentation for plastic ISO 2039/1**
- 6.5" Industrial HD Touch screen, Embedded Powerful Fanless System Controller, 32GB SSD data storage drive, Windows 7 Embedded, RJ45 LAN, WLAN, USB, RS-232
- IMPRESSIONS™, full tester & configuration control, graphic indent simulation, test program setting for user defined test programs, large test results storage, 5 simultaneous conversions to other hardness scales, limit settings, advanced test report generator, CSV export, graphics display engine & many more functions
- Meets or exceeds ISO, ASTM and JIS standards
- Standard workpiece clamping attachment
- Replaceable body parts, shock proof ABS cover
- Extra large workpiece accommodation
- Motorized spindle (optional)

## VERZUS 710RSB



- **Rockwell, Superficial Rockwell, Brinell, HBT & HVT, Ball indentation for plastic ISO 2039/1**
- Load cell, force feedback, closed loop system
- Load range 1Kgf to 250Kgf
- Automatic force setting
- **Rockwell Scales:** A, B, C, D, E, F, G, H, K, L, M, P, R, S, V, 15N, 30N, 45N, 15T, 30T, 45T, 15W, 30W, 45W, 15X, 30X, 45X, 15Y, 30Y, 45Y
- **Brinell Scales:** HB1/1, 2.5, 5, 10, 30Kgf; HB2.5/6.25, 15.625, 31.25, 62.5, 187.5Kgf; HB5/25, 62.5, 125, 250Kgf; HB10/100, 250Kgf;  
**HBT Scales:** HBT/5Kgf - 250Kgf;  
**HVT Scales:** HVT/5Kgf - 120Kgf
- Ball indentation for plastic ISO 2039/1
- Motorized spindle (optional)
- Brinell Indent Optical Scanner, BIOS, hand scanner with 5Mpx camera for automatic Brinell measurements
- All other specifications as mentioned with VERZUS 710RS

# NEMESIS 9000RS



# Rockwell hardness testing / XY-Stage / Jominy

## NEMESIS 9000RS



### Rockwell, Superficial Rockwell, HBT & HVT, Ball indentation for plastic ISO 2039/1

- Top end reference class Rockwell hardness testing machine
- Load cell, force feedback, closed loop system
- Load range 1Kgf to 250Kgf
- Automatic test force setting related to scale
- **Rockwell Scales:** A, B, C, D, E, F, G, H, K, L, M, P, R, S, V, 15N, 30N, 45N, 15T, 30T, 45T, 15W, 30W, 45W, 15X, 30X, 45X, 15Y, 30Y, 45Y,
- **HBT Scales:** 5Kgf - 250Kgf;
- **HVT Scales:** 5Kgf - 120Kgf
- **Ball indentation for plastic ISO 2039/1**
- Certified depth measuring system, accuracy 0.1 $\mu$ m
- 15" Industrial HD Touch screen, Embedded Powerful Fanless System Controller, 2x 80GB SSD data storage drives, Windows 7 Embedded, RJ45 LAN, WLAN, USB, RS-232
- IMPRESSIONS™, full tester & configuration control, graphic indent simulation, test program setting for user defined test programs, large test results storage, 5 simultaneous conversions to other hardness scales, limit settings, advanced test report generator, CSV export, graphics display engine & many more functions
- Force / depth graphic on screen
- Embedded 5 axis CNC controller (standard)
- Connection for 1 axis or 2 axis CNC motorized X, or X-Y Jominy stages (standard)
- Jominy sample holders (optional)
- Meets or exceeds ISO, ASTM and JIS standards
- Standard workpiece clamping attachment
- Replaceable body parts, shock proof ABS cover
- Wireless mouse and keyboard
- Extra large workpiece accommodation

Can be supplied as a ROCKWELL STANDARDIZING tester according to ISO and ASTM standards, with enhanced system depth measuring system accuracy or 0.02 $\mu$ m (9000RSLAB) and test force accuracy and reproduction within **0,1% (9000RS-LAB)**



# Rockwell/Brinell hardness testing / BIOS

## NEMESIS 9000RSB



### **Rockwell, Superficial Rockwell, Brinell, HBT & Vickers HVT, Ball indentation for plastic ISO 2039/1**

- Reference class standardization Rockwell hardness testing machine
- Load cell, force feedback, closed loop system
- Load range 1Kgf to 250Kgf
- Automatic force setting
- Descending testhead fixed workpiece position
- **Rockwell Scales:** A, B, C, D, E, F, G, H, K, L, M, P, R, S, V, 15N, 30N, 45N, 15T, 30T, 45T, 15W, 30W, 45W, 15X, 30X, 45X, 15Y, 30Y, 45Y,  
**Brinell Scales:** HB1/1Kgf, 2.5Kgf, 5Kgf, 10Kgf, 30Kgf; HB2.5/6.25Kgf, 15.625Kgf, 31.25Kgf, 62.5Kgf, 187.5Kgf; HB5/25Kgf, 62.5Kgf, 125Kgf, 250Kgf; HB10/100Kgf, 250Kgf;  
**HBT Scales:** HBT/5Kgf - 250Kgf;  
**HVT Scales:** HVT/5Kgf - 120Kgf
- **Ball indentation for plastic ISO 2039/1**
- 15" Industrial HD Touch screen, Embedded Powerful Fanless System Controller, 2x 80GB SSD data storage drives, Windows 7 Embedded, RJ45 LAN, WLAN, USB, RS-232
- IMPRESSIONS™, full tester & configuration control, graphic indent simulation, test program setting for user defined test programs, large test results storage, 5 simultaneous conversions to other hardness scales, limit settings, advanced test report generator, CSV export, graphics display engine & many more functions
- Embedded 5 axis CNC controller (standard)
- Connection for 1 axis or 2 axis CNC motorized X, or X-Y Jominy stages (standard)
- Jominy sample holders (optional)
- Meets or exceeds ISO, ASTM and JIS standards
- Standard workpiece clamping attachment
- Replaceable body parts, shock proof ABS cover
- Wireless mouse and keyboard
- Extra large workpiece accommodation
- Brinell Indent Optical Scanner, BIOS, hand scanner with 5Mpx camera for automatic Brinell measurements

# Rockwell hardness testing / XY-Stage / Jominy

## NEMESIS 9500RS



### Rockwell, Superficial Rockwell, HBT & HVT, Ball indentation for plastic ISO 2039/1

- Heavy duty hardness testing machine
- Heavy duty, XXL Rockwell tester
- Load cell, force feedback, closed loop system
- Load range 1Kgf to 250Kgf
- Automatic force setting
- Descending testhead fixed workpiece position
- Motorized spindle with 800Kgf lifting capacity
- **Rockwell Scales:** A, B, C, D, E, F, G, H, K, L, M, P, R, S, V, 15N, 30N, 45N, 15T, 30T, 45T, 15W, 30W, 45W, 15X, 30X, 45X, 15Y, 30Y, 45Y,
- **HBT Scales:** 5Kgf - 250Kgf;
- **HVT Scales:** 5Kgf - 120Kgf
- Ball indentation for plastic ISO 2039/1
- 15" Industrial HD Touch screen, Embedded Powerful Fanless System Controller, 2x 80GB SSD data storage drives, Windows 7 Embedded, RJ45 LAN, WLAN, USB, RS-232
- IMPRESSIONS™, full tester & configuration control, graphic indent simulation, test program setting for user defined test programs, large test results storage, 5 simultaneous conversions to other hardness scales, limit settings, advanced test report generator, CSV export, graphics display engine & many more functions
- Embedded 5 axis CNC controller (standard)
- Connection for motorized X-Y stages (standard)
- Meets or exceeds ISO, ASTM and JIS standards
- Standard workpiece clamping attachment
- Wireless mouse and keyboard
- Extra large workpiece accommodation



# Rockwell/Brinell hardness testing / BIOS

## NEMESIS 9503RSB



### Rockwell, Brinell, HBT & HVT,

- Heavy duty hardness testing machine
- Heavy duty, XXL Rockwell tester
- Load cell, force feedback, closed loop system
- Load range 10Kgf to 3000Kgf
- Automatic force setting
- Descending testhead fixed workpiece position
- **Rockwell Scales:** A, B, C, D, E, F, G, H, K, L, M, P, R, S, V
- **Brinell Scales:** HB1/10Kgf, 30Kgf; HB2.5/15.625Kgf, 31.25Kgf, 62.5Kgf, 187.5Kgf; HB5/25Kgf, 62.5Kgf, 125Kgf, 250Kgf; HB10/100Kgf, 250Kgf;
- **HBT Scales:** HBT/62.5Kgf - 3000Kgf;
- **HVT Scales:** HVT/50Kgf - 120Kgf
- 15" Industrial HD Touch screen, Embedded Powerful Fanless System Controller, 2x 80GB SSD data storage drives, Windows 7 Embedded, RJ45 LAN, WLAN, USB, RS-232
- IMPRESSIONS™, full tester & configuration control, graphic indent simulation, test program setting for user defined test programs, large test results storage, 5 simultaneous conversions to other hardness scales, limit settings, advanced test report generator, CSV export, graphics display engine & many more functions
- Embedded 5 axis CNC controller (standard)
- Connection for motorized X-Y stages (standard)
- Meets or exceeds ISO, ASTM and JIS standards
- Standard workpiece clamping attachment
- Wireless mouse and keyboard
- Extra large workpiece accommodation
- Brinell Indent Optical Scanner, BIOS, hand scanner with 5Mpx camera for automatic Brinell measurements



# Vickers hardness testing

## Vickers hardness testing

The Vickers hardness test was developed in 1924 by Smith and Sandland at Vickers Ltd as an alternative to the Brinell method to measure the hardness of materials.

The Vickers test is often easier to use than other hardness tests, since the required calculations are independent of the size of the indenter, and the indenter can be used for all materials irrespective of hardness.

The basic principle, as with all common measures of hardness, is to observe the questioned material's ability to resist plastic deformation from a standard source.

The Vickers test can be used for all metals and has one of the widest scales among hardness tests.

The unit of hardness given by the test is known as the Vickers Pyramid Number (HV) or Diamond Pyramid Hardness (DPH).

The hardness number can be converted into units of Pascals, but should not be confused with a pressure, which also has units of Pascals. The hardness number is determined by the load over the surface area of the indentation and not the area normal to the force, and is therefore not a pressure.

The hardness number is not really a true property of the material and is an empirical value that should be seen in conjunction with the experimental methods and hardness scale used.

When doing the hardness tests the distance between indentations must be more than 2.5 indentation diameters apart to avoid interaction between the work-hardened regions.





# Vickers hardness testing

## Implementation

An indentation left in case-hardened steel after a Vickers hardness test. The indenter shape should be capable of producing geometrically similar impressions, irrespective of size; the impression should have well-defined points of measurement; and the indenter should have high resistance to self-deformation. A diamond in the form of a square-based pyramid satisfied these conditions. It had been established that the ideal size of a Brinell impression was  $3/8$  of the ball diameter. As two tangents to the circle at the ends of a chord  $3d/8$  long intersect at  $136^\circ$ , it was decided to use this as the included angle of the indenter. The angle was varied experimentally and it was found that the hardness value obtained on a homogeneous piece of material remained constant, irrespective of load. Accordingly, loads of various magnitudes are applied to a flat surface, depending on the hardness of the material to be measured.

The HV number is then determined by the ratio  $F/A$  where  $F$  is the force applied to the diamond in kilograms-force and  $A$  is the surface area of the resulting indentation in square millimeters.

$A$  can be determined by the formula which can be approximated by evaluating the sine term to give where  $d$  is the average length of the diagonal left by the indenter.

Vickers hardness numbers are reported as  $xxxHV_{yy}$ , e.g.  $440HV_{30}$ , or  $xxxHV_{yy/zz}$  if duration of force differs from 10s to 15s, e.g.  $440Hv_{30/20}$ , where:

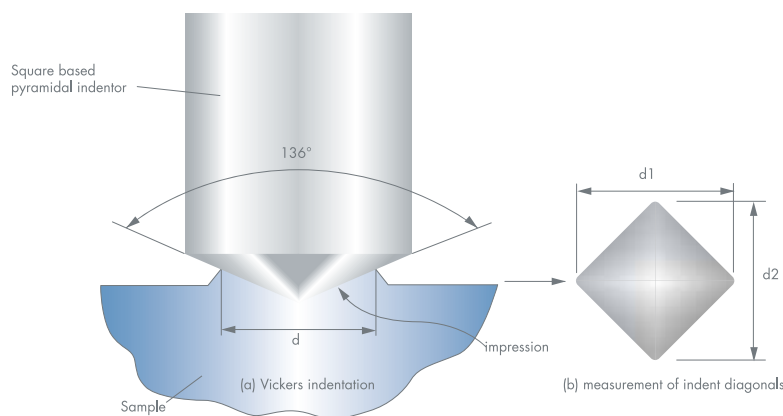

440 is the hardness number,  
HV gives the hardness scale (Vickers),  
30 indicates the load used in kg.  
20 indicates the loading time if it differs from 10s to 15s

Vickers values are generally independent of the test force:  
they will come out the same for 500gf and 50Kgf, as long as the force is at least 200gf.

Examples of HV values for various materials

Material	Value
316L stainless steel	140HV30
347L stainless steel	180HV30
Carbon steel	55–120HV5
Iron	30–80HV5

### Standards

- European & international EN ISO 6507
- American ASTM E384/E92

# Micro/Macro Vickers hardness testing

## FALCON 450 / 450XL



**FALCON 450**



**FALCON 459XL**

### The new FALCON 450

Based on the successful fully automatic range of FALCON 500 Micro/Macro Vickers hardness testers, Innovatest has designed a versatile and user friendly eyepiece/ microscope version at this series for less demanding purposes.

The new FALCON 450 offers unique features comparing to similar machines within the industry;

- **Micro/Macro Vickers, Knoop & Brinell scales**
- Multi Load cell, Closed loop, force application system
- Load range 1gf up to 62.5Kgf
- Automatic test force setting
- Unbelievable test force range 1gf up to 62,5kgf
- 6 position motorized turret, with 2 indenters and 4 objectives
- High powered LED illumination
- Best in class optical system and objectives
- Motorized z-axis ball bearing slide, with dynamic speed controlled height adjustment
- Manual, high force (100kgf), X-Y stage with micrometer heads
- Choice between standard or XL frame height
- 6,5" Full color declinable High Definition touch screen
- Optional High Definition integrated CCD camera, positioned under front cover, no visible wires or attachments, protected from dirt, damage & accidental misalignment

- Unique dual view system: eyepiece and CCD camera can show crisp images simultaneously; excellent for group use or educational purposes
- Smart graphical user interface with dialog system and color support
- Optional IMPRESSIONS™ tester automation and workflow control system, automatic measurement
- USB output to CSV file, can be opened in most MS Office applications such as Excel®.
- Strong, shock and damage resistant, High End ABS machine covers
- **Vickers Scales:** HV0.001, 0.002, 0.003, 0.004, 0.005, 0.006, 0.007, 0.008, 0.009, 0.010, 0.015, 0.020, 0.025, 0.050, 0.1, 0.2, 0.3, 0.5, 1, 2, 2.5, 3, 4, 5, 10, 20, 25, 30, 40, 50
- **Knoop Scales:** HK/0.001, 0.003, 0.005, 0.01, 0.015, 0.02, 0.025, 0.05, 0.1, 0.2, 0.3, 0.5, 1, 2, 5, 10, 20, 30, 50
- **Brinell Scales:**  
HB1/1Kgf, 1.25Kgf, 2.5Kgf, 5Kgf, 10Kgf, 30Kgf;  
HB2.5/6.25Kgf, 7.8125Kgf, 15.625Kgf,  
31.25Kgf, 62.5Kgf  
HB5/25Kgf, 62.5Kgf
- Test force tolerance  
<0,5% for test force 100gr to 62.5kg,  
<1% for test force below 100gr

# Micro/Macro Vickers hardness testing

## FALCON 450 / 450XL



### **Smart graphical user interface with dialog system and color indication support**

The clearly structured full color High Definition Touch Screen Tablet can be simply operated through finger touch or a screen pen. The ridged screen cover is made out of solid aluminum. The table base can be inclined and declined, to ensure an ideal viewing angle regardless of operation position (standing or sitting). The software functions are advanced, the screen is graphical and most of the functions or tester actions are visibly supported with live animations. Color Screen and measured values change from green to red depending on test limit settings and values recorded. The user interface also supports set up, save and recall of test programs and has a large memory for test readings. At a finger touch data can be send to the USB-2 printer or a USB storage device.



### **Ultra precise Z-axis movement**

The Z-axis height adjustment of the manual or motorized work table is provided by a high precision spindle.

### **Safety first/collision detection system**

In order to ensure maximum safety for the user, but also to protect the tester against user errors, all FALCON models have an advanced collision detection, warning & Z-axis retraction system.

This system is triggered by any uncommon force on the turret and will stop & retract the Z-axis in milliseconds. Fingers, hands and work pieces are safe, but also damage to indenters and objectives belong to the past.

# Micro/Macro Vickers hardness testing

## FALCON 500



### Fully automatic Micro/Macro Vickers, Knoop & Brinell system

- Load cell, force feedback, closed loop system
- Load range 1gf up to 62.5Kgf
- Automatic test force setting
- **Vickers Scales:** HV0.001, 0.002, 0.003, 0.004, 0.005, 0.006, 0.007, 0.008, 0.009, 0.010, 0.015, 0.020, 0.025, 0.050, 0.1, 0.2, 0.3, 0.5, 1, 2, 2.5, 3, 4, 5, 10, 20, 25, 30, 40, 50
- **Knoop Scales:** HK/0.001, 0.003, 0.005, 0.01, 0.015, 0.02, 0.025, 0.05, 0.1, 0.2, 0.3, 0.5, 1, 2, 5, 10, 20, 30, 50
- **Brinell Scales:** HB1/1Kgf, 1.25Kgf, 2.5Kgf, 5Kgf, 10Kgf, 30Kgf; HB2.5/6.25Kgf, 7.8125Kgf, 15.625Kgf, 31.25Kgf, 62.5Kgf  
HB5/25Kgf, 62.5Kgf
- **KIC fracture toughness**
- Welding testing
- Test force tolerance  
<0,5% for test force 100gr to 62.5kg,  
<1% for test force below 100gr
- 15" Industrial HD Touch screen, Embedded Powerful Fanless System Controller, 80GB SSD data storage drive, Windows 7 Embedded, RJ45 LAN, WLAN, USB, RS-232, HDMI & VGA
- IMPRESSIONS™, full tester & configuration control, graphic indent simulation, test program setting for user defined test programs, large test results storage, 5 simultaneous conversions to other hardness scales, limit settings, advanced test report generator, CSV export, graphics display engine & many more functions
- Meets or exceeds ISO, ASTM and JIS standards
- Automatic Brightness, Contrast and Sharpness control
- Auto Focus
- Automatic indent measurement
- CAM 2 Zoom Overview (Optional)
- Calibrated stepless Indent ZOOM system
- Auto save, program setup, data storage
- Motorized Z-axis with dynamic Intelli control
- 2 indenter positions, 4 objective positions
- Quality optical system
- 5Mpx HD camera
- Collision detection and z-axis retraction system, avoids turret damage
- Connection for motorized X-Y stages (standard)
- Embedded 5 axis CNC controller (standard)

# Micro/Macro Vickers hardness testing

## FALCON 500

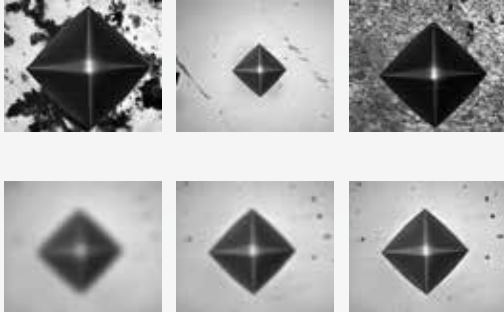

IMPRESSIONS™ tester control evaluates sharpness and brightness of all camera images and measures the indentation without influence of the operator. The automatic adjustment of the picture parameters ensures reproducible test results, even for difficult materials and scratched or damaged test surfaces.

The standard fast auto-focus technology guarantees a sharp image of the indentation, in just a few seconds.

The dual screen option gives the image of the overview camera (normally also provided on a single screen solution) next to the standard operator screen.

The advantage is that a larger image of the overview image can be viewed simultaneously with the normal measurement camera images.

Advanced viewing for complicated test patterns or precision positioning on complicated parts will be easier by applying 2 of the industrial touch screens.



### CHD/Nht/Rht measurement

For the performance of test series for CHD/Nht/Rht data of specimen according to standard. The test can be started directly from the surface view or from the overview. Additional core points of hardness can be defined separately for Nht measurements.



Intelligent Precision positioning of the work piece is a standard feature on the FALCON series.

The 2 button control system allows ultra-fast pre-positioning, while the scroll wheel provides a pulse by pulse control on the actual fine adjustment of the focus position.

A dynamic system, as the speed depends on the selected magnification of the vertical microscope and camera system. Speed varies further by the velocity of the scroll wheel and is therefore in perfect harmony with the displacement feeling feedback to the operator.

\* All FALCON 500 models have a standard auto-focus system!

Calibrated stepless zoom of the indent image provided by the objective, while maintaining the same high standard of image quality. This unique zoom system is a standard feature on the entire FALCON series.

Combined with the 4 objectives installed on the 6 position turret, the zoom system allows a further magnification of the indentation, even up to 2500X.

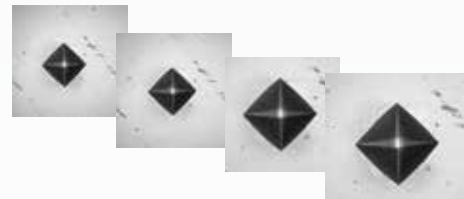

### Safety first/collision detection system

In order to ensure maximum safety for the user, but also to protect the tester against user errors, all FALCON models have an advanced collision detection, warning & Z-axis retraction system.

This system is triggered by any uncommon force on the turret and will stop & retract the Z-axis in milliseconds. Fingers, hands and work pieces are safe, but also damage to indenters and objectives belong to the past.

# Micro/Macro Vickers hardness testing

## FALCON 5000



### **If merely the best and most versatile hardness testing machine has your interest...**

The Innovatest® FALCON 5000 is the most revolutionary, advanced and powerful Micro Vickers, Vickers hardness testing machine currently available.

Apart from Micro Vickers, Vickers, Knoop and low force Brinell scales, configuration of the FALCON 5000 is freely to define and offers flawless upgrades to hardness testing according to standards of Superficial Rockwell, regular Rockwell & higher force Brinell hardness scales. In its ultimate configuration and most advanced version, the FALCON 5000 offers fully automatic advanced coordinate pattern and free style testing of metallic and plastic parts in any common hardness scale;

#### **Micro Vickers Vickers Knoop**

- Superficial Rockwell
- Rockwell
- KIC fracture toughness
- Brinell
- HVT (Vickers depth)
- HBT (Brinell depth)
- ISO 2039 1 & 2 for plastics

#### **Stunning test force range**

The servo driven testers force actuator allows test forces from 10gf up to 250kgf, currently unique on the world market. Great efforts have been taken by INNOVATEST® in designing our own ultra-precise load cells and force control electronics, that are the foundation of this new product.

#### **Setting the GLOBAL standard for advanced high speed turrets**

The FALCON 5000's high speed, 8 position turret, has the first in the industry, standard built in:

#### **laser positioning system.**

The 8 position turret also contains 2 HD, camera's, with auto focus and optical zoom system, allowing stage (over)viewing at indenter position

Quick Change stage & anvil post

Workpiece Clamping device for depth measurement

Ultra fast, dedicated system controller with i7 processor and 2 INTEL SSD hard drives.

Advanced report generator with extended CSV export functionality.



**LASER POSITIONING SYSTEM**

# Standard overview camera and surface illumination

## FALCON 5000



**Dual Surface illumination**      **Laser Positioning**      **Overview Camera**



**Collision detection system**      **Tool protection skirt**

### Safety first/collision detection system

In order to ensure maximum safety for the user, but also to protect the tester against user errors, all FALCON models have an advanced collision detection, warning & Z-axis/test head retraction system.

This system is triggered by any uncommon force on the turret and will stop & retract the test head in milliseconds. Fingers, hands and work pieces are safe, but also damage to indenters and objectives belong to the past.

### Micro/Macro Vickers & Knoop, (Optional: Brinell, Rockwell, Superficial Rockwell, HVT, HBT, ISO 2039 1/2)

- Load cell, force feedback, closed loop system
- Load range 10gf up to 250Kgf
- **Vickers Scales:** HV0.010, HV0.015, HV0.020, HV0.025, HV0.050, HV0.1, HV0.2, HV0.3, HV0.5, HV1, HV2, HV2.5, HV3, HV4, HV5, HV10, HV20, HV25, HV30, HV40, HV50, HV100, HV120
- \* All test forces are also available for the HVT scales
- **KIC fracture toughness**
- **Knoop Scales:** HK/0.01, 0.02, 0.025, 0.05, 0.1, 0.2, 0.3, 0.5, 1, 2, 5, 10, 20, 30, 50

### Brinell Scales:

HB1/1kgf, HB1/2.5kgf, HB1/5kgf, HB1/10kgf, HB1/30kgf;  
HB2.5/6.25kgf, HB2.5/15.625kgf, HB2.5/31.25kgf, HB2.5/62.5kgf;  
HB5/25kgf, HB5/62.5kgf, HB5/125kgf  
HB5/250kgf;  
HB10/100kgf, HB10/250kgf;

\* All test forces are also available for the HBT scales

### Rockwell & Superficial Rockwell

- Pre Load 3kgf & 10kgf
- Main Load 15kgf, 30kgf, 45kgf, 60kgf, 100kgf & 150kgf
- **ISO 2039 1/2** for plastics
- Welding testing
- Test force tolerance <0,5% for test force 100gr to 62.5kg, <1% for test force below 100gr
- Meets or exceeds ISO, ASTM and JIS standards
- 15" Industrial HD Touch screen,
- IMPRESSIONS™, full tester, configuration and work flow control
- Auto Brightness, Contrast and Sharpness control
- Auto Focus
- Automatic indent measurement
- CAM 2 Zoom Overview system
- Descending test head with dynamic Intelligent control
- 2 indenter positions, 4 objective positions
- Quality optical system, 5Mpx HD camera
- Connection for motorized X-Y stages (standard)
- Connectivity USB, RJ45 LAN, WLAN & HDMI
- Embedded 5 axis CNC controller (standard)



# Micro Vickers & Knoop hardness testing

## NOVA 130 / 240



The new NOVA 130 & 240 series Vickers, Knoop & Brinell (optional) hardness testing instruments offer a versatile and user friendly solution for a wide range of Vickers, Knoop & Low Force Brinell hardness testing.

- Traditional dead weight system
- Motorized turret, 2 objectives or 3 objectives
- Load range 10gr - 2Kgf
- 6,5" Full color High Definition touch screen
- Built-in hardness calculator
- Easy to use Smart graphical user interface with dialog system and color indication support
- Optional analogue or Digital/Electronic eyepiece with 15X magnification
- Dual Channel optical system
- Advance hardness value conversion according to ISO/ASTM
- Shows 3 hardness conversion values simultaneously
- Large workpiece accommodation
- Host and Device USB connectivity
- Integrated high speed thermal printer

### Others:

- Prepared for optional remote operation
- Prepared for optional IMPRESSIONS HD Camera & auto measurement systems
- Prepared for optional motorized CNC, X-Y stages
- Prepared for optional motorized Z axis / auto-focus

### NOVA 130

- 2 (10x & 40x) objectives for measuring/ observation, test forces 10gr to 1Kgf

### NOVA 240

- 3 (5x, 10x & 40x) objectives for measuring/ observation, test forces 10gr to 2Kgf





# Micro Vickers & Knoop indent vision systems

## Indent vision systems

### **NOVA IMP SET-2 (Standard)**

IMPRESSIONS XT V1.01 license (for manual X-Y stage).  
(CCD camera and C-mount included)  
Software for manual and automatic measurement of Vickers / Knoop, Indent ZOOM function, automatic light adjustment, LCD industrial DVI touch screen included.  
Advanced test report generator & CSV export.

### **NOVA IMP SET-3 (With one stage micrometer)**

IMPRESSIONS XT V1.01 license (manual 1 axis digital X-Y stage).  
(CCD camera and C-mount included)  
Software for manual and automatic measurement of Vickers / Knoop, Indent ZOOM function, digital micrometer (1) on X-Y stage, automatic light adjustment, LCD industrial DVI touch screen included.  
Advanced test report generator & CSV export.

### **NOVA IMP SET-4 (With two stage micrometers)**

IMPRESSIONS XT V1.01 license (manual 2 axis digital X-Y stage).  
(CCD camera and C-mount included)  
Software for manual and automatic measurement of Vickers / Knoop, Indent ZOOM function, digital micrometers (2) on X-Y stage, automatic light adjustment, LCD industrial DVI touch screen included.  
CHD/Nht/ Rht measurement. Advanced test report generator & CSV export.

### **NOVA IMP SET-5MV/V (With motorized X-Y stage)**

IMPRESSIONS XT V1.01 license (motorized X-Y stage).  
(CCD camera and C-mount included)  
Software for manual and automatic measurement of Vickers / Knoop, Indent ZOOM function, automatic light adjustment, coordinate multi pattern testing module, motorized X-Y stage, LCD industrial DVI touch screen included, virtual mouse function.  
CHD/Nht/ Rht measurement. Advanced test report generator & CSV export.

### **NOVA IMP SET-6MV/V (With motorized X-Y stage & AF)**

IMPRESSIONS XT V1.01 license  
(motorized X-Y stage and motorized Z-axis, auto focus).  
(CCD camera and C-mount included)  
Software for manual and fully automatic measurement of Vickers / Knoop, Indent ZOOM function, automatic indent focus, automatic light adjustment, coordinate multi pattern testing module, motorized X-Y stage, LCD industrial DVI touch screen included, virtual mouse function.  
CHD/Nht/ Rht measurement. Advanced test report generator & CSV export.

AUTOMATIC MEASUREMENT



MAGNIFIED, FINE ADJUSTMENT



FULL SCREEN, ZOOM



REPORT GENERATOR



# Micro/Macro Vickers & Brinell hardness testing

## NOVA 330 / 360



The new NOVA 330 & 360 series, Load Cell, Closed Loop, Vickers, Knoop & Brinell (optional) hardness testing instruments offer a versatile and user friendly solution for a wide range of Vickers, Knoop & Low Force Brinell hardness testing.

- Standard objectives 5X, 10X and 40X installed (NOVA 330)
- Standard objectives 5X, 10X and 20X installed (NOVA 360)
- Optional High Resolution CCD camera system can be integrated, directly or afterwards
- High quality objectives providing maximum viewing comfort
- Vertical LED Illuminator
- Dual Channel optical system
- Optional Analogue or Digital/Electronic eyepiece with 15X magnification
- Measuring confirmation button on digital eyepiece
- 6,5" Full color high resolution touch screen, tablet type
- Language selectable interaction dialog system
- Graphic tester motion control interface
- Easy operation, no expert skills required, short training time
- Save and load test programs, tester settings
- Limit settings, real time statistics
- Shape correction settings for testing on round parts
- Host and Device USB connectivity
- Integrated high speed thermal printer

### Others:

- Prepared for optional remote operation
- Prepared for optional IMPRESSIONS HD Camera & auto measurement systems
- Prepared for optional motorized CNC, X-Y stages
- Prepared for optional motorized Z axis / auto-focus
- Brinell scale optional for Nova 330/360

### NOVA 330

- (Micro) Vickers & Knoop, 3 objectives for measuring/observation, test forces 20gf to 31.25kgf

### NOVA 360

- (Micro) Vickers & Knoop, 3 objectives for measuring/observation, test forces 100gf to 62.5kgf



# Micro Vickers & Knoop indent vision systems

## Indent vision systems

### **NOVA IMP SET-2 (Standard)**

IMPRESSIONS XT V1.01 license (for manual X-Y stage).  
(CCD camera and C-mount included)  
Software for manual and automatic measurement of Vickers / Knoop, Indent ZOOM function, automatic light adjustment, LCD industrial DVI touch screen included.  
Advanced test report generator & CSV export.

### **NOVA IMP SET-3 (With one stage micrometer)**

IMPRESSIONS XT V1.01 license (manual 1 axis digital X-Y stage).  
(CCD camera and C-mount included)  
Software for manual and automatic measurement of Vickers / Knoop, Indent ZOOM function, digital micrometer (1) on X-Y stage, automatic light adjustment, LCD industrial DVI touch screen included.  
Advanced test report generator & CSV export.

### **NOVA IMP SET-4 (With two stage micrometers)**

IMPRESSIONS XT V1.01 license (manual 2 axis digital X-Y stage).  
(CCD camera and C-mount included)  
Software for manual and automatic measurement of Vickers / Knoop, Indent ZOOM function, digital micrometers (2) on X-Y stage, automatic light adjustment, LCD industrial DVI touch screen included.  
CHD/Nht/ Rht measurement. Advanced test report generator & CSV export.

### **NOVA IMP SET-5MV/V (With motorized X-Y stage)**

IMPRESSIONS XT V1.01 license (motorized X-Y stage).  
(CCD camera and C-mount included)  
Software for manual and automatic measurement of Vickers / Knoop, Indent ZOOM function, automatic light adjustment, coordinate multi pattern testing module, motorized X-Y stage, LCD industrial DVI touch screen included, virtual mouse function.  
CHD/Nht/ Rht measurement. Advanced test report generator & CSV export.

### **NOVA IMP SET-6MV/V (With motorized X-Y stage & AF)**

IMPRESSIONS XT V1.01 license  
(motorized X-Y stage and motorized Z-axis, auto focus).  
(CCD camera and C-mount included)  
Software for manual and fully automatic measurement of Vickers / Knoop, Indent ZOOM function, automatic indent focus, automatic light adjustment, coordinate multi pattern testing module, motorized X-Y stage, LCD industrial DVI touch screen included, virtual mouse function.  
CHD/Nht/ Rht measurement. Advanced test report generator & CSV export.

AUTOMATIC MEASUREMENT



MAGNIFIED, FINE ADJUSTMENT



FULL SCREEN, ZOOM



REPORT GENERATOR



# NEXUS 3200 Standard frame with BIOS



# Brinell hardness testing

## Brinell hardness testing

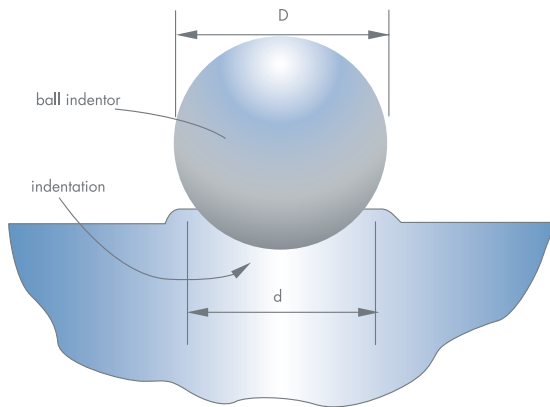

(a) Brinell indentation

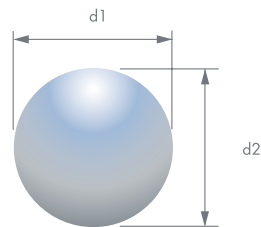

(b) measurement of indent diameter

The Brinell scale characterizes the indentation hardness of materials through the scale of penetration of an indenter, loaded on a material test-piece.

Proposed by Swedish engineer Johan August Brinell in 1900, it was the first widely used and standardized hardness test in engineering and metallurgy.

The typical tests use a 10, 5, 2.5 or 1 mm diameter steel ball as an indenter with a test force starting at 1Kgf up to 3,000Kgf (29 kN) force. For softer materials, a lower force is used; for harder materials, a tungsten carbide ball is substituted for the steel ball.

After the impression is made, a measurement of the diameter of the resulting round impression ( $d$ ) is taken.

It is measured to plus or minus 0.05mm using a low-magnification microscope. The hardness is calculated by dividing the load by the area of the curved surface of the indentation, (the area of a hemispherical surface is arrived at by multiplying the square of the diameter by 3.14159 and then dividing by 2).

## Common values

The standard format for specifying tests can be seen in the example "HBW 10/3000".

"HBW" means that a tungsten carbide (from the chemical symbol for tungsten) ball indenter was used, as opposed to "HBS", which means a hardened steel ball.

The "10" is the ball diameter in millimeters.

The "3000" is the force in kilograms force.

### Standards

- European & international EN ISO 6506
- American ASTM E10

# Brinell hardness testing

## NEXUS 3001 SERIES



**NEXUS 3001**  
+ ANALOGUE MICROSCOPE

### Brinell

- Load cell, closed loop system
- Load range 30Kgf - 3000Kgf
- LCD display showing Brinell value statistics and tester settings
- Simultaneous conversion to Rockwell, Vickers, Brinell and Leeb
- External microscope with analogue scale for indentation measurement
- Optional Brinell video microscope system HB100 (see pag. 43)



**NEXUS 3001XL**  
+ ANALOGUE MICROSCOPE

### Brinell

- Load cell, closed loop system
- Load range 30Kgf - 3000Kgf
- LCD display showing Brinell value, statistics and tester settings
- Simultaneous conversion to Rockwell, Vickers, Brinell and Leeb
- External microscope with analogue scale for indentation measurement
- Optional Brinell video microscope system HB100 (see pag. 43)
- XL version, 450mm workpiece height, 220mm throat depth

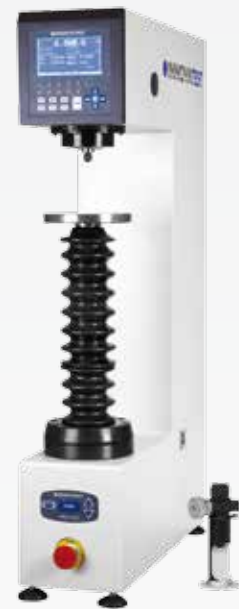

**NEXUS 3001XLM**  
+ MOTORIZED SPINDLE

### Brinell

- Load cell, closed loop system
- Load range 30Kgf - 3000Kgf
- Simultaneous conversion to Rockwell, Vickers, Brinell and Leeb
- External microscope with analogue scale for indentation measurement
- Optional Brinell video microscope system HB100 (see pag. 43)
- XLM version, 450mm workpiece height, 220mm throat depth  
**Motorized spindle, featuring automatic workpiece detection, force application, unloading, repositioning**

# Brinell hardness testing

## NEXUS 3200 SERIES



**NEXUS 3200**  
+ BIOS

### Brinell

- Load cell, closed loop system
- Load range 62.5Kgf - 3000Kgf
- 6.5" Industrial HD Touch screen, Embedded Powerful Fanless System Controller, 32GB SSD data storage drive,
- Windows 7 Embedded, RJ45 LAN, WLAN, USB, RS-232
- IMPRESSIONS™, full tester & configuration control, graphic indent simulation, test program setting for user defined test programs, large test results storage, 2 simultaneous hardness scales conversions, limit settings, advanced test report generator, CSV export, graphics display engine & many more functions
- Brinell Indent Optical Scanner, BIOS, hand scanner with 5Mpx camera for automatic Brinell measurements



**NEXUS 3200 XL**  
+ BIOS

### Brinell

- Load cell, closed loop system
- Load range 62.5Kgf - 3000Kgf
- 6.5" Industrial HD Touch screen, Embedded Powerful Fanless System Controller, 32GB SSD data storage drive,
- Windows 7 Embedded, RJ45 LAN, WLAN, USB, RS-232
- IMPRESSIONS™, full tester & configuration control, graphic indent simulation, test program setting for user defined test programs, large test results storage, 2 simultaneous hardness scales conversions, limit settings, advanced test report generator, CSV export, graphics display engine & many more functions
- Brinell Indent Optical Scanner, BIOS, hand scanner with 5Mpx camera for automatic Brinell measurements
- 390mm workpiece height, 220mm throat depth (XL version)



**NEXUS 3200XLM**  
+ BIOS & MOTORIZED SPINDLE

### Brinell

- Load cell, closed loop system
- Load range 62.5Kgf - 3000Kgf
- 6.5" Industrial HD Touch screen, Embedded Powerful Fanless System Controller, 32GB SSD data storage drive,
- Windows 7 Embedded, RJ45 LAN, WLAN, USB, RS-232
- IMPRESSIONS™, full tester & configuration control, graphic indent simulation, test program setting for user defined test programs, large test results storage, 2 simultaneous hardness scales conversions, limit settings, advanced test report generator, CSV export, graphics display engine & many more functions
- Brinell Indent Optical Scanner, BIOS, hand scanner with 5Mpx camera for automatic Brinell measurements
- 390mm workpiece height, 220mm throat depth (XLM version)  
**Motorized spindle, featuring automatic workpiece detection, force application, unloading, repositioning**

# Brinell hardness testing

## NEXUS 3001XLM-IMP



### Brinell

- Fully automatic system
- Load range 30Kgf - 3000Kgf
- 2-Position motorized turret (indenter/objective)
- High resolution CCD camera
- Fully automatic indent video measuring system, equipped with an automatic motorized turret/revolver (indenter/objective positions)
- Optical system with high quality objective
- Indent ZOOM function
- Automatic focus, automatic measurement, database testing results storage, image storage, report generator
- Standard equipped with motorized spindle for fully automatic procedure
- 15" Industrial HD Touch screen, Embedded Powerful Fanless System Controller, 32GB SSD data storage drive, Windows 7 Embedded, RJ45 LAN, WLAN, USB, RS-232
- IMPRESSIONS™, full tester & configuration control, graphic indent simulation, test program setting for user defined test programs, large test results storage, 3 simultaneous conversions to other hardness scales, limit settings, advanced test report generator, CSV export, graphics display engine & many more functions

### Procedure (1 full cycle):

Auto-approaching, automatic indentation, dwelling, automatic focus, automatic indent measuring, unloading, pre-positioning, ready!

### Manual mode use:

- LCD display showing Brinell value, statistics and tester settings
- Simultaneous conversion to Rockwell, Vickers, Brinell



## NEXUS 8003HBT BIOS™



### **Brinell, HBT (Brinell depth measurement) Heavy duty, XL Brinell tester**

- Descending test head with extended indenter base to access difficult to reach test surfaces
- Load cell, force feedback, closed loop system
- Load range 10Kgf to 3000Kgf (depending on model)
- Automatic force setting
- Motorized spindle (optional)
- Ergonomic height adjustable worktable
- **Brinell Scales:** HB1/10Kgf, 30Kgf, HB2.5/15.625Kgf, 31.25Kgf, 62.5Kgf, 187.5Kgf; HB5/25Kgf, 62.5Kgf, 125Kgf, 250Kgf, 750Kgf; HB10/100Kgf, 250Kgf, 500Kgf, 750Kgf, 1000Kgf, 1500Kgf, 3000Kgf;
- **HBT Scales:** HBT/62.5Kgf - 3000Kgf
- Force application tolerance <0.5%
- 15" Industrial HD Touch screen, Embedded Powerful Fanless System Controller, 2x 80GB SSD data storage drive Windows 7 Embedded, RJ45 LAN, WLAN, USB, RS-232
- IMPRESSIONS™, full tester & configuration control, graphic indent simulation, test program setting for user defined test programs, large test results storage, 3 simultaneous conversions to other hardness scales, limit settings, advanced test report generator, CSV export, graphics display engine & many more functions
- Indent ZOOM function
- Meets or exceeds ISO, ASTM and JIS standards
- Standard workpiece clamping attachment
- Wireless mouse and keyboard
- Workpiece accommodation:  
350mm workpiece height,  
260mm throat depth
- Brinell Indent Optical Scanner, BIOS, hand scanner with 5Mpx camera for automatic Brinell measurements
- Motorized spindle (optional)

## NEXUS 8003HBT XXL™ BIOS



### **Brinell, HBT (Brinell depth measurement) Heavy duty, XXL Brinell tester**

- Descending test head with extended indenter base to access difficult to reach test surfaces
- Load cell, force feedback, closed loop system
- Load range 10Kgf to 3000Kgf
- Automatic force setting
- Motorized spindle (optional)
- Ergonomic height adjustable worktable
- **Brinell Scales:** HB1/10Kgf, 30Kgf, HB2.5/15.625Kgf, 31.25Kgf, 62.5Kgf, 187.5Kgf; HB5/25Kgf, 62.5Kgf, 125Kgf, 250Kgf, 750Kgf; HB10/100Kgf, 250Kgf, 500Kgf, 750Kgf, 1000Kgf, 1500Kgf, 3000Kgf;
- **HBT Scales:** HBT/62.5Kgf - 3000Kgf
- Force application tolerance <0.5%
- 15" Industrial HD Touch screen, Embedded
- Powerful Fanless System Controller, 2x 80GB SSD data storage drive Windows 7 Embedded, RJ45 LAN, WLAN, USB, RS-232
- IMPRESSIONS™, full tester & configuration control, graphic indent simulation, test program setting for user defined test programs, large test results storage, 3 simultaneous conversions to other hardness scales, limit settings, advanced test report generator, CSV export, graphics display engine & many more functions
- Indent ZOOM function
- Meets or exceeds ISO, ASTM and JIS standards
- Standard workpiece clamping attachment
- Wireless mouse and keyboard
- Workpiece accommodation:
  - 520mm workpiece height,
  - 300mm throat depth
- Brinell Indent Optical Scanner, BIOS, hand scanner with 5Mpx camera for automatic Brinell measurements
- Motorized spindle (optional)



## NEMESIS 9503HBT™ BIOS



### **Brinell, HBT (Brinell depth measurement) Heavy duty, XXL Brinell tester**

- Descending test head for difficult to reach test surface positions
- Load cell, force feedback, closed loop system
- Load range 10Kgf to 3000Kgf
- Automatic force setting
- Motorized spindle with 800Kg lifting capacity
- Ergonomic height adjustable worktable
- **Brinell Scales:** HB1/10Kgf, 30Kgf, HB2.5/15.625Kgf, 31.25Kgf, 62.5Kgf, 187.5Kgf; HB5/25Kgf, 62.5Kgf, 125Kgf, 250Kgf, 750Kgf; HB10/100Kgf, 250Kgf, 500Kgf, 750Kgf, 1000Kgf, 1500Kgf, 3000Kgf;
- **HBT Scales:** HBT/62.5Kgf - 3000Kgf
- Force application tolerance <0.5%
- 15" Industrial HD Touch screen, Embedded Powerful Fanless System Controller, 2x 80GB SSD data storage drive Windows 7 Embedded, RJ45 LAN, WLAN, USB, RS-232
- IMPRESSIONS™, full tester & configuration control, graphic indent simulation, test program setting for user defined test programs, large test results storage, 3 simultaneous conversions to other hardness scales, limit settings, advanced test report generator, CSV export, graphics display engine & many more functions
- Indent ZOOM function
- Meets or exceeds ISO, ASTM and JIS standards
- Standard workpiece clamping attachment
- Wireless mouse and keyboard
- Workpiece accommodation:  
650mm workpiece height  
(750mm extended, optional),  
400mm throat depth
- Brinell Indent Optical Scanner, BIOS, hand scanner with 5Mpx camera for automatic Brinell measurements

## NEMESIS 9803HBT™ BIOS



### **Brinell, HBT (Brinell depth measurement) Heavy duty, XXL Brinell tester**

- Descending test head for difficult to reach test surface positions
- Load cell, force feedback, closed loop system
- Load range 10Kgf to 3000Kgf
- **Brinell Scales:** HB1/10Kgf, 30Kgf  
HB2.5/15.625Kgf, 31.25Kgf, 62.5Kgf,  
187.5Kgf; HB5/25Kgf, 62.5Kgf, 125Kgf, 250Kgf,  
750Kgf; HB10/100Kgf, 250Kgf, 500Kgf, 750Kgf,  
1000Kgf, 1500Kgf, 3000Kgf;
- **HBT Scales:** HBT/62.5Kgf - 3000Kgf
- Force application tolerance <0.5%
- 15" Industrial HD Touch screen, Embedded  
Powerful Fanless System Controller, 2x 80GB SSD  
data storage drive Windows 7 Embedded, RJ45  
LAN, WLAN, USB, RS-232
- IMPRESSIONS™, full tester & configuration  
control, graphic indent simulation, test program  
setting for user defined test programs, large test results  
storage, 3 simultaneous conversions to other hardness  
scales, limit settings, advanced test  
report generator, CSV export, graphics display  
engine & many more functions
- Indent ZOOM function
- Meets or exceeds ISO, ASTM and JIS standards
- Standard workpiece clamping attachment
- Wireless mouse and keyboard
- Workpiece accommodation:  
maximum test height 1600mm,  
maximum 1500mm depth  
2 times 180° rotation
- Brinell Indent Optical Scanner, BIOS,  
hand scanner with 5Mpx camera for automatic Brinell  
measurements

# Brinell hardness testing

## IMPRESSIONS™ HB100



### BRINELL OPTICAL SCANNING SYSTEM HB100

Portable video scanning system to automatically measure Brinell indentations and determine the Brinell hardness value. Excellent solution for quick and easy measurement of Brinell hardness values with diameters 1, 2, 2.5, 5 and 10mm and for applied loads of 1Kgf to 3000Kgf.

- Including (removable) magnetic base for accurate and precise measuring
- Easy to use: Position the scanning system on the indentation made in a flat or curved surface, press the button to determine the relative hardness and diameter of the indentation
- Accuracy of the measured diameter is up to 0.001mm
- Possibility to set tolerance value Yes/No (upper & lower limits)
- Possibility to show the last 5 hardness measurements taken
- Automatic storage of images and accompanying measurement data files
- Storage of operator id, date/hour, hardness parameters, measured hardness values, location of stored image

#### Software Features

- Measures the indentation automatically or by hand
- Saves the image of the indentation in a dedicated format and folder
- Test results can be imported into Excel
- Each measurement is filled with information about the ball diameter, applied load, load duration
- The 5 last measurements can be shown on screen
- Images taken can be copied

# NEXUS 8000XL

Ideal for large components



# Universal hardness testing

## Universal hardness testing

Universal hardness testers are in fact hybrid instruments allowing the user to make Rockwell, Vickers and Brinell hardness tests according to the applicable ISO, ASTM and JIS standards, with one single machine.

Universal hardness testers do not convert hardness values but apply tests according to standard procedures.

While most hardness testers in particular measure only one kind of scale either Rockwell or Vickers or Brinell, the Universal testers cover a wide range of testloads and measurement procedures.

While traditional Universal hardness testers were complex mechanical structures, built of many parts and complicated weight stacks, newer generations based on load cell technology and closed loop force feedback systems have taken away most of the complexity of earlier models.

Nowadays, Universal hardness testers offer the user the comfort of having one single tester covering all scales. The advantage is obvious. While Universal hardness testers are often a more expensive asset, money can be saved on maintenance, after sales service and calibration. Due to technology of the load application system, closed loop Universal hardness testers offer a wide range of testloads generally superceeding single scale testers traditionally having dead weight load application systems.

INNOVATEST® manufactures a vast range of Universal hardness testers. Regardless of your budget, there is a tester for each application. Simple to operate but very advanced models to state-of-the-art machines like the new NEMESIS 9000™ series.

Due to the size of the range we present on this page and following pages a more detailed overview. Don't hesitate to ask our sales department for your particular requirement or advice on the best choice for your budget or application.



# Universal hardness testing

## VERZUS 700AS



### **Rockwell, Superficial Rockwell, Brinell, Vickers, Knoop, HBT & HVT, Ball indentation for plastic ISO 2039/1**

- Load cell, closed loop force feedback system
- Load range 1Kgf to 250Kgf
- Advanced user interface
- **Rockwell Scales:** A, B, C, D, E, F, G, H, K, L, M, P, R, S, V, 15N, 30N, 45N, 15T, 30T, 45T, 15W, 30W, 45W, 15X, 30X, 45X, 15Y, 30Y, 45Y
- **Vickers Scales:** HV/1Kgf, 2Kgf, 3Kgf, 4Kgf, 5Kgf, 10Kgf, 20Kgf, 30Kgf, 50Kgf, 100Kgf, 120Kgf;
- **Brinell Scales:** HB1/1Kgf, 2.5Kgf, 5Kgf, 10Kgf, 30Kgf; HB2.5/6.25Kgf, 15.625Kgf, 31.25Kgf, 62.5Kgf, 187.5Kgf; HB5/25Kgf, 62.5Kgf, 125Kgf, 250Kgf; HB10/100Kgf, 250Kgf;
- **HVT Scales:** HVT/5Kgf - 120Kgf;
- **HBT Scales:** HBT/5Kgf - 250Kgf;
- **Ball indentation for plastic ISO 2039/1**
- Motorized elevator spindle (optional)
- Build on digital Brinell/Vickers microscope
- Objectives 37.5x, 75x, 150x magnification
- Replaceable body parts, shock proof ABS cover
- Adjustable LED illumination
- LED Ringlight for dark field illumination (optional)
- Meets or exceeds ISO, ASTM and JIS standards
- Precision workpiece sliding table
- Workpiece accommodation:
  - 300mm workpiece height,
  - 200mm throat depth
- Large workpiece accommodation
- On-line statistics and USB output





# Universal hardness testing

## VERZUS 750CCD



### Rockwell, Superficial Rockwell, Brinell, Vickers, Knoop, HBT & HVT, Ball indentation for plastic ISO 2039/1

- Load cell, closed loop force feedback system
- Load range 1Kgf to 250Kgf
- Advanced user interface
- **Rockwell Scales:** A, B, C, D, E, F, G, H, K, L, M, P, R, S, V, 15N, 30N, 45N, 15T, 30T, 45T, 15W, 30W, 45W, 15X, 30X, 45X, 15Y, 30Y, 45Y
- **Vickers Scales:** HV/1Kgf, 2Kgf, 3Kgf, 4Kgf, 5Kgf, 10Kgf, 20Kgf, 30Kgf, 50Kgf, 100Kgf, 120Kgf;
- **Brinell Scales:** HB1/1Kgf, 2.5Kgf, 5Kgf, 10Kgf, 30Kgf; HB2.5/6.25Kgf, 15.625Kgf, 31.25Kgf, 62.5Kgf, 187.5Kgf; HB5/25Kgf, 62.5Kgf, 125Kgf, 250Kgf; HB10/100Kgf, 250Kgf;
- **HVT Scales:** HVT/5Kgf - 120Kgf;
- **HBT Scales:** HBT/5Kgf - 250Kgf;
- **Ball indentation for plastic ISO 2039/1**
- High resolution CCD Video system
- 8.5" Industrial HD Touch screen, Embedded Powerful Fanless System Controller, 2x 80GB SSD data storage drive Windows 7 Embedded, RJ45 LAN, WLAN, USB, RS-232
- IMPRESSIONS™, full tester & configuration control, graphic indent simulation, test program setting for user defined test programs, large test results storage, 2 simultaneous conversions to other hardness scales, limit settings, advanced test report generator, CSV export, graphics display engine & many more functions
- Indent ZOOM function
- Motorized elevator spindle (optional)
- Objectives 37.5x, 75x, 150x magnification
- Adjustable LED illumination
- LED Ringlight for dark field illumination (optional)
- Replaceable body parts, shock proof ABS cover
- Precision workpiece sliding table
- Large workpiece accommodation
- On-line statistics and USB output
- Meets or exceeds ISO, ASTM and JIS standards
- Wireless mouse and keyboard

# Universal hardness testing

## NEMESIS 9000™ SERIES



### Rockwell, Superficial Rockwell, Brinell, Vickers, Knoop, HVT & HBT, Ball indentation for plastic ISO 2039/1

- Load cell, force feedback, closed loop system
- Load range 1Kgf - 250Kgf (9001), 3Kgf until 750Kgf (9002), 10Kgf until 3000Kgf (9003)
- **Rockwell Scales:** A, B, C, D, E, F, G, H, K, L, M, P, R, S, V, 15N, 30N, 45N, 15T, 30T, 45T, 15W, 30W, 45W, 15X, 30X, 45X, 15Y, 30Y, 45Y
- **Vickers Scales:** HV/1Kgf, 2Kgf, 3Kgf, 4Kgf, 5Kgf, 10Kgf, 20Kgf, 30Kgf, 50Kgf, 100Kgf, 120Kgf;
- **Brinell Scales:** HB1/1Kgf, 2.5Kgf, 5Kgf, 10Kgf, 30Kgf; HB2.5/6.25Kgf, 15.625Kgf, 31.25Kgf, 62.5Kgf, 187.5Kgf; HB5/25Kgf, 62.5Kgf, 125Kgf, 250Kgf, 750Kgf; HB10/100Kgf, 250Kgf, 500Kgf, 750Kgf, 1000Kgf, 1500Kgf, 3000Kgf;
- **HVT Scales:** HVT/5Kgf - 120Kgf
- **HBT Scales:** HBT/5Kgf - 3000Kgf;
- **Ball indentation for plastic ISO 2039/1** (scales depending on model)
- Descending test head with 6, 7 or 8 position turret, standard 3 indenters, 3 objectives
- 15" Industrial HD Touch screen, Embedded Powerful Fanless System Controller, 2x 80GB SSD data storage drive Windows 7 Embedded, RJ45 LAN, WLAN, USB, RS-232
- IMPRESSIONS™, full tester & configuration control, graphic indent simulation, test program setting for user defined test programs, large test results storage, 3 simultaneous conversions to other hardness scales, limit settings, advanced test report generator, CSV export, graphics display engine & many more functions
- Indent ZOOM function
- High accuracy depth measuring system
- Built-in driver pack for X-Y or Jominy stages
- Workpiece accommodation: maximum test height 300mm, maximum depth 220mm
- Meets or exceeds ISO, ASTM and JIS standards
- Wireless mouse and keyboard



# Universal hardness testing

## NEMESIS 9001M™



### Rockwell, Superficial Rockwell, Brinell, Vickers, Knoop, HVT & HBT, Ball indentation for plastic ISO 2039/1

- Load cell, force feedback, closed loop system
- Load range 1Kgf - 150Kgf
- **Rockwell Scales:** A, B, C, D, E, F, G, H, K, L, M, P, R, S, V, 15N, 30N, 45N, 15T, 30T, 45T, 15W, 30W, 45W, 15X, 30X, 45X, 15Y, 30Y, 45Y
- **Vickers Scales:** HV/1Kgf, 2Kgf, 3Kgf, 4Kgf, 5Kgf, 10Kgf, 20Kgf, 30Kgf, 50Kgf, 100Kgf, 120Kgf;
- **Brinell Scales:** HB1/1Kgf, 2.5Kgf, 5Kgf, 10Kgf, 30Kgf; HB2.5/6.25Kgf, 15.625Kgf, 31.25Kgf, 62.5Kgf; HB5/25Kgf, 62.5Kgf, 125Kgf; HB10/100Kgf;
- **Ball indentation for plastic ISO 2039/1**

### 9001M VERSION:

The 9001M has been developed for the fully automatic testing of ammunition (bullet casing/shells). The 9001M has the ability to detect irregular surface heights and provides advanced test pattern settings and a comprehensive reporting system for Vickers and Brinell testing.

Ask our Sales department for more details.



# Universal hardness testing

## NEXUS 7501



### **Rockwell, Superficial Rockwell, Brinell, Vickers, Knoop, HVT & HBT, Ball indentation for plastic ISO 2039/1**

- Load cell, force feedback, closed loop system
- Load range 0.5Kgf - 250Kgf
- **Rockwell Scales:** A, B, C, D, E, F, G, H, K, L, M, P, R, S, V, 15N, 30N, 45N, 15T, 30T, 45T, 15W, 30W, 45W, 15X, 30X, 45X, 15Y, 30Y, 45Y
- **Vickers Scales:** HV/0.5Kgf, 1Kgf, 2Kgf, 3Kgf, 4Kgf, 5Kgf, 10Kgf, 20Kgf, 30Kgf, 50Kgf, 100Kgf, 120Kgf;
- **Brinell Scales:** HB1/1Kgf, 2.5Kgf, 5Kgf, 10Kgf, 30Kgf; HB2.5/6.25Kgf, 15.625Kgf, 31.25Kgf, 62.5Kgf, 187.5Kgf; HB5/25Kgf, 62.5Kgf, 125Kgf, 250Kgf; HB10/100Kgf, 250Kgf;
- **HVT Scales:** HVT/5Kgf - 120Kgf;
- **HBT Scales:** HBT/5Kgf - 250Kgf;
- **Ball indentation for plastic ISO 2039/1**
- 15" Industrial HD Touch screen, Embedded Powerful Fanless System Controller, 2x 80GB SSD data storage drive Windows 7 Embedded, RJ45 LAN, WLAN, USB, RS-232
- IMPRESSIONS™, full tester & configuration control, graphic indent simulation, test program setting for user defined test programs, large test results storage, 3 simultaneous conversions to other hardness scales, limit settings, advanced test report generator, CSV export, graphics display engine & many more functions
- Indent ZOOM function
- Bright LED illumination (ringlight optional)
- Shape correction for curved surfaces
- High accuracy depth measuring system (Rockwell, HBT, HVT)
- Software controlled swivel operation
- High precision spindle
- Workpiece accommodation:  
320mm workpiece height,  
205mm throat depth
- Motorized spindle (optional)
- Meets or exceeds, ISO, ASTM and JIS standards
- Wireless mouse and keyboard



## NEXUS 8000 SERIES



**Rockwell, Superficial Rockwell, Brinell, Vickers, Knoop, HVT & HBT, Ball indentation for plastic ISO 2039/1**

- Load cell, force feedback, closed loop system
- Load range 1Kgf - 250Kgf (8001), 3Kgf until 750Kgf (8002), 10Kgf until 3000Kgf (8003)
- **Rockwell Scales:** A, B, C, D, E, F, G, H, K, L, M, P, R, S, V, 15N, 30N, 45N, 15T, 30T, 45T, 15W, 30W, 45W, 15X, 30X, 45X, 15Y, 30Y, 45Y
- **Vickers Scales:** HV/1Kgf, 2Kgf, 3Kgf, 4Kgf, 5Kgf, 10Kgf, 20Kgf, 30Kgf, 50Kgf, 100Kgf, 120Kgf;  
**Brinell Scales:** HB1/1Kgf, 2.5Kgf, 5Kgf, 10Kgf, 30Kgf; HB2.5/6.25Kgf, 15.625Kgf, 31.25Kgf, 62.5Kgf, 187.5Kgf; HB5/25Kgf, 62.5Kgf, 125Kgf, 250Kgf, 750Kgf; HB10/100Kgf, 250Kgf, 500Kgf, 750Kgf, 1000Kgf, 1500Kgf, 3000Kgf;  
**HVT Scales:** HVT/5Kgf - 120Kgf;  
**HBT Scales:** HBT/5Kgf - 3000Kgf;  
**Ball indentation for plastic ISO 2039/1** (scales depending on model)
- Descending test head with 6, 7 or 8 position turret, standard 3 indenters, 3 objectives
- 15" Industrial HD Touch screen, Embedded Powerful Fanless System Controller, 2x 80GB SSD data storage drive Windows 7 Embedded, RJ45 LAN, WLAN, USB, RS-232
- IMPRESSIONS™, full tester & configuration control, graphic indent simulation, test program setting for user defined test programs, large test results storage, 3 simultaneous conversions to other hardness scales, limit settings, advanced test report generator, CSV export, graphics display engine & many more functions
- Indent ZOOM function
- High accuracy depth measuring system
- Built-in driver pack for X-Y or Jominy stages
- Workpiece accommodation: maximum test height 330mm, maximum depth 260mm
- Standard workpiece clamping attachment
- Meets or exceeds, ISO, ASTM and JIS standards
- Wireless mouse and keyboard
- Motorized spindle (optional)

## NEXUS 8000XL SERIES



**Rockwell, Superficial Rockwell, Brinell, Vickers, Knoop, HVT & HBT, Ball indentation for plastic ISO 2039/1**

- Load cell, force feedback, closed loop system
- Load range 1Kgf - 250Kgf (8001XL), 3Kgf until 750Kgf (8002XL), 10Kgf until 3000Kgf (8003XL)
- **Rockwell Scales:** A, B, C, D, E, F, G, H, K, L, M, P, R, S, V, 15N, 30N, 45N, 15T, 30T, 45T, 15W, 30W, 45W, 15X, 30X, 45X, 15Y, 30Y, 45Y
- **Vickers Scales:** HV/1Kgf, 2Kgf, 3Kgf, 4Kgf, 5Kgf, 10Kgf, 20Kgf, 30Kgf, 50Kgf, 100Kgf, 120Kgf;  
**Brinell Scales:** HB1/1Kgf, 2.5Kgf, 5Kgf, 10Kgf, 30Kgf; HB2.5/6.25Kgf, 15.625Kgf, 31.25Kgf, 62.5Kgf, 187.5Kgf; HB5/25Kgf, 62.5Kgf, 125Kgf, 250Kgf, 750Kgf; HB10/100Kgf, 250Kgf, 500Kgf, 750Kgf, 1000Kgf, 1500Kgf, 3000Kgf;  
**HVT Scales:** HVT/5Kgf - 120Kgf;  
**HBT Scales:** HBT/5Kgf - 3000Kgf;  
**Ball indentation for plastic ISO 2039/1** (scales depending on model)
- Descending test head with 6, 7 or 8 position turret, standard 3 indenters, 3 objectives
- 15" Industrial HD Touch screen, Embedded Powerful Fanless System Controller, 2x 80GB SSD data storage drive Windows 7 Embedded, RJ45 LAN, WLAN, USB, RS-232
- IMPRESSIONS™, full tester & configuration control, graphic indent simulation, test program setting for user defined test programs, large test results storage, 3 simultaneous conversions to other hardness scales, limit settings, advanced test report generator, CSV export, graphics display engine & many more functions
- Indent ZOOM function
- High accuracy depth measuring system
- Built-in driver pack for X-Y or Jominy stages
- Workpiece accommodation: maximum test height 490mm or 520mm (XLM), maximum depth 285mm
- Standard workpiece clamping attachment
- Meets or exceeds, ISO, ASTM and JIS standards
- Wireless mouse and keyboard
- Motorized spindle (optional)

# Universal hardness testing

## NEMESIS 9500™ SERIES



### **Brinell, Vickers, Knoop, Rockwell, Superficial Rockwell, HVT & HBT, Ball indentation for plastic ISO 2039/1**

- Load cell, force feedback, closed loop system
- Load range 1Kgf - 250Kgf (9501), 3Kgf until 750Kgf (9502), 10Kgf until 3000Kgf (9503)
- **Rockwell Scales:** A, B, C, D, E, F, G, H, K, L, M, P, R, S, V, 15N, 30N, 45N, 15T, 30T, 45T, 15W, 30W, 45W, 15X, 30X, 45X, 15Y, 30Y, 45Y
- **Vickers Scales:** HV/1Kgf, 2Kgf, 3Kgf, 4Kgf, 5Kgf, 10Kgf, 20Kgf, 30Kgf, 50Kgf, 100Kgf, 120Kgf;
- **Brinell Scales:** HB1/1Kgf, 2.5Kgf, 5Kgf, 10Kgf, 30Kgf; HB2.5/6.25Kgf, 15.625Kgf, 31.25Kgf, 62.5Kgf, 187.5Kgf; HB5/25Kgf, 62.5Kgf, 125Kgf, 250Kgf, 750Kgf; HB10/100Kgf, 250Kgf, 500Kgf, 750Kgf, 1000Kgf, 1500Kgf, 3000Kgf;
- **HVT Scales:** HVT/5Kgf - 120Kgf;
- **HBT Scales:** HBT/5Kgf - 3000Kgf;
- **Ball indentation for plastic ISO 2039/1** (scales depending on model)
- Descending test head with 6, 7 or 8 position turret, standard 3 indenters, 3 objectives
- 15" Industrial HD Touch screen, Embedded Powerful Fanless System Controller, 2x 80GB SSD data storage drive Windows 7 Embedded, RJ45 LAN, WLAN, USB, RS-232
- IMPRESSIONS™, full tester & configuration control, graphic indent simulation, test program setting for user defined test programs, large test results storage, 3 simultaneous conversions to other hardness scales, limit settings, advanced test report generator, CSV export, graphics display engine & many more functions
- Indent ZOOM function
- High accuracy depth measuring system
- Built-in driver pack for X-Y or Jominy stages
- Workpiece accommodation: maximum test height 650mm, maximum depth 400mm
- Meets or exceeds ISO, ASTM and JIS standards
- Wireless mouse and keyboard
- Motorized spindle with 800Kg lifting capacity

# Universal hardness testing

## NEMESIS 9800™ SERIES



- **Brinell, Vickers, Knoop, Rockwell, Superficial Rockwell, HVT & HBT, Ball indentation for plastic ISO 2039/1**
- Load cell, force feedback, closed loop system
- Load range 1Kgf - 250Kgf (9801), 3Kgf until 750Kgf (9802), 10Kgf until 3000Kgf (9803)
- **Rockwell Scales:** A, B, C, D, E, F, G, H, K, L, M, P, R, S, V, 15N, 30N, 45N, 15T, 30T, 45T, 15W, 30W, 45W, 15X, 30X, 45X, 15Y, 30Y, 45Y
- **Vickers Scales:** HV/10Kgf, 20Kgf, 30Kgf, 50Kgf, 100Kgf, 120Kgf;  
**Brinell Scales:** HB1/10Kgf, 30Kgf; HB2.5/15.625Kgf, 31.25Kgf, 62.5Kgf, 187.5Kgf; HB5/25Kgf, 62.5Kgf, 125Kgf, 250Kgf, 750Kgf; HB10/100Kgf, 250Kgf, 500Kgf, 750Kgf, 1000Kgf, 1500Kgf, 3000Kgf;
- **HVT Scales:** HVT/5Kgf - 120Kgf;  
**HBT Scales:** HBT/5Kgf - 3000Kgf;  
**Ball indentation for plastic ISO 2039/1** (scales depending on model)
- Motorized test head movement
- Descending test head with 6, 7 or 8 position turret, standard 3 indenters, 3 objectives
- Automatic hydraulic clamping of 3-axis
- 15" Industrial HD Touch screen, Embedded Powerful Fanless System Controller, 2x 80GB SSD data storage drive Windows 7 Embedded, RJ45 LAN, WLAN, USB, RS-232
- IMPRESSIONS™, full tester & configuration control, graphic indent simulation, test program setting for user defined test programs, large test results storage, 3 simultaneous conversions to other hardness scales, limit settings, advanced test report generator, CSV export, graphics display engine & many more functions
- Indent ZOOM function
- High accuracy depth measuring system
- Built-in driver pack for X-Y or Jominy stages
- Workpiece accommodation: maximum test height 1600mm, maximum depth 1500mm 2 times 180° rotation
- Meets or exceeds ISO, ASTM and JIS standards
- Wireless mouse and keyboard



# NEMESIS 9800 SERIES

Ideal for very large components



# Single indenter test head

## Single indenter test head



**Rockwell, Superficial Rockwell,  
HVT & HBT,  
Ball indentation for plastic ISO 2039/1**

- Load cell, force feedback, closed loop system
- Load range 1Kgf - 250Kgf (UN-HEAD250SI), 3Kgf until 750Kgf (UN-HEAD2750SI), 10Kgf until 3000Kgf (UN-HEAD3000SI)
- **Rockwell Scales:** A, B, C, D, E, F, G, H, K, L, M, P, R, S, V, 15N, 30N, 45N, 15T, 30T, 45T, 15W, 30W, 45W, 15X, 30X, 45X, 15Y, 30Y, 45Y
- **HVT Scales:** HVT/5Kgf - 120Kgf;  
**HBT Scales:** HBT/5Kgf - 3000Kgf
- **Ball indentation for plastic ISO 2039/1**  
(scales depending on model)
- Descending test head with single indenter position and workpiece clamp
- 15" Industrial HD Touch screen, Embedded Powerful Fanless System Controller, 2x 80GB SSD data storage drive Windows 7 Embedded, RJ45 LAN, WLAN, USB, RS-232
- IMPRESSIONS™, full tester & configuration control, graphic indent simulation, test program setting for user defined test programs, large test results storage, 3 simultaneous conversions to other hardness scales, limit settings, advanced test report generator, CSV export, graphics display engine & many more functions
- Indent ZOOM function
- High accuracy depth measuring system
- Built-in driver pack for X-Y or Jominy stages
- Meets or exceeds ISO, ASTM and JIS standards
- Wireless mouse and keyboard

# Universal test head

## Universal test head with turret



- **Brinell, Vickers, Knoop, Rockwell, Superficial Rockwell, HVT & HBT, Ball indentation for plastic ISO 2039/1**
- Load cell, force feedback, closed loop system
- Load range 1Kgf - 250Kgf (UN-THEAD250), 3Kgf until 750Kgf (UN-THEAD750), 10Kgf until 3000Kgf (UN-THEAD3000)
- **Rockwell Scales:** A, B, C, D, E, F, G, H, K, L, M, P, R, S, V, 15N, 30N, 45N, 15T, 30T, 45T, 15W, 30W, 45W, 15X, 30X, 45X, 15Y, 30Y, 45Y
- **Vickers Scales:** HV/1Kgf, 2Kgf, 3Kgf, 4Kgf, 5Kgf, 10Kgf, 20Kgf, 30Kgf, 50Kgf, 100Kgf, 120Kgf;
- **Brinell Scales:** HB1/1Kgf, 2.5Kgf, 5Kgf, 10Kgf, 30Kgf; HB2.5/6.25Kgf, 15.625Kgf, 31.25Kgf, 62.5Kgf, 187.5Kgf; HB5/25Kgf, 62.5Kgf, 125Kgf, 250Kgf, 750Kgf; HB10/100Kgf, 250Kgf, 500Kgf, 750Kgf, 1000Kgf, 1500Kgf, 3000Kgf;
- **HVT Scales:** HVT/5Kgf - 120Kgf;
- **HBT Scales:** HBT/5Kgf - 3000Kgf
- **Ball indentation for plastic ISO 2039/1** (scales depending on model)
- Descending test head with 6, 7 or 8 position turret, standard 3 indenters, 3 objectives
- 15" Industrial HD Touch screen, Embedded Powerful Fanless System Controller, 2x 80GB SSD data storage drive Windows 7 Embedded, RJ45 LAN, WLAN, USB, RS-232
- IMPRESSIONS™, full tester & configuration control, graphic indent simulation, test program setting for user defined test programs, large test results storage, 3 simultaneous conversions to other hardness scales, limit settings, advanced test report generator, CSV export, graphics display engine & many more functions
- Indent ZOOM function
- High accuracy depth measuring system
- Built-in driver pack for X-Y or Jominy stages
- Meets or exceeds ISO, ASTM and JIS standards
- Wireless mouse and keyboard

# Portable hardness testing

## Portable hardness testing

INNOVATEST® offers a wide range of portable hardness testing instruments.

Most of the common testing methods are represented in this overview.

Portable instruments often offer an excellent alternative if the workpiece is too heavy or too large to be tested on a bench hardness tester.

## Reliability

A common view is that portable hardness testing instruments are less reliable or less accurate than bench type hardness testers.

This however is a misunderstanding. Portable hardness testers, considering to be manufactured according to the applicable standards, are as accurate as bench hardness tester.

The importance of portable instruments is that they should be applied in a correct manner, respecting the testing conditions as advised for the particular testing method.

Incorrect use is often the cause of wrong values obtained by portable testing instruments.

Another recent problem is that there are many cheap, poor quality portable testing instruments available on the market. Such instruments offer promising specifications which in many cases cannot be reached or can be reached but only for a short period of the "life time" of such instrument.

It is strongly recommended to buy portable testing instruments that are covered by a decent service system offering regular checks and which have a proven track record of reliability and quality.

## Portable testing methods

Most common testing methods are the Leeb hardness, rebound technology, or the UCI ultrasonic hardness test.

While the rebound technology conforms to the ASTM and DIN standards, UCI offers the advantage of being more suitable for light weighted and thin components. Barcol and Webster are based on impressing the material with a sharp indenter, portable Rockwell or portable Brinell are more or less spin-offs from the applicable standard methods of such scales.



# Portable hardness testing

## MET-U1A



### Ultrasonic Contact Impedance (UCI) system (Vickers)

- Hardness measurements of metals and alloys on standardized hardness scales: Rockwell (HRC), Brinell (HB), Vickers (HV) and Shore (HSD)
- Three additional scales H1, H2, H3 for calibration of self defined hardness scales
- Rm scale for determination of tensile strength
- Typically suitable for components that are unsuitable for dynamic hardness testers (small articles, structures with thin walls, pipes, reservoirs, steel sheets etc.)

## WEBSTER



### Portable hardness tester

- The WEBSTER hardness method is ideal for sheet metal, sheet aluminum and other thin materials
- Test is made by simply applying pressure to the handles until "bottom" is felt
- Easy - to - read dial indicator with 20 graduations, permits use of the tester as "Go" and "No - Go" gauge
- Tests materials up to 13mm in thickness

INNOVATEST®



# Bench tester stand

## Bench stands

- Low stand:  
710mm × 750mm × 700mm (UN-STAND/950),  
suitable for larger testers such as 3000, 3200, 7000, 7501, 9000RS and 9000 series
  - Low stand:  
710mm × 900mm × 570mm (UN-STAND/955),  
suitable for large and heavy testers such as 8000 series
  - High stand:  
710mm × 750mm × 800mm (UN-STAND/960),  
suitable for medium size testers such as 600, 400, 4000, 700, 750 series
  - Large stand:  
1500mm × 750mm × 800mm (UN-STAND/965),  
suitable for Vickers, Micro-Vickers and automated systems (PC and video systems)
- 
- 100% retractable drawer, bearing guidance, max 100kg load.  
Rubber anti slip bottom
  - Big drawer, 360mm high
  - Adjustable feet, (+/- 50mm height adjustable to reach ergonomic working position)
  - Made of corrosion resistant zinc plated steel with RAL powder coating
  - Carrying capacity of 1500kg
  - Top surface made of 40mm Plywood with 1.5mm chemical resistant plastic plating,  
edges made of shock resistant 3mm ABS side liner
  - Industrial quality, for workshop or laboratory
  - Designed for hardness testing instruments, painted in INNOVATEST® RAL colors that match with the testers



# Bench tester stand

## Technical drawing UN-STAND 950

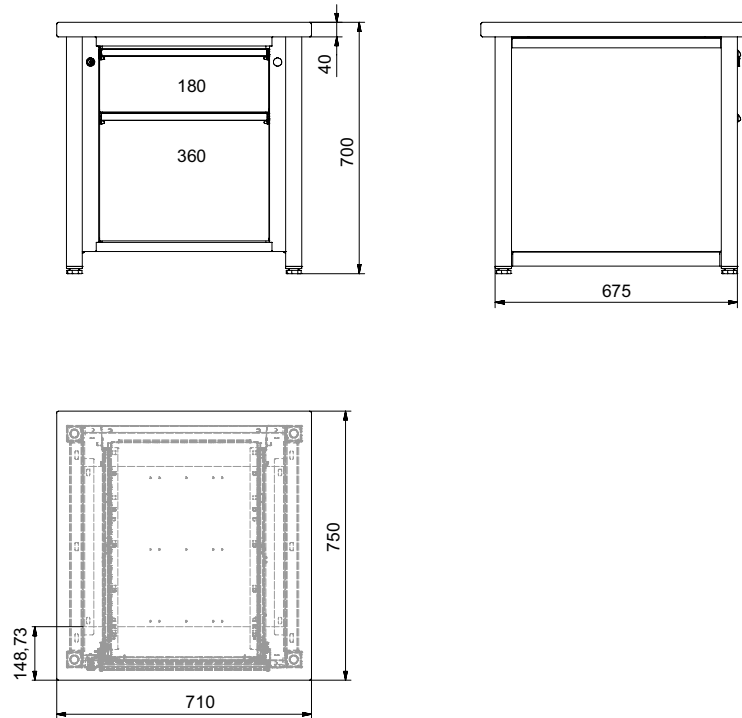

## Technical drawing UN-STAND 955

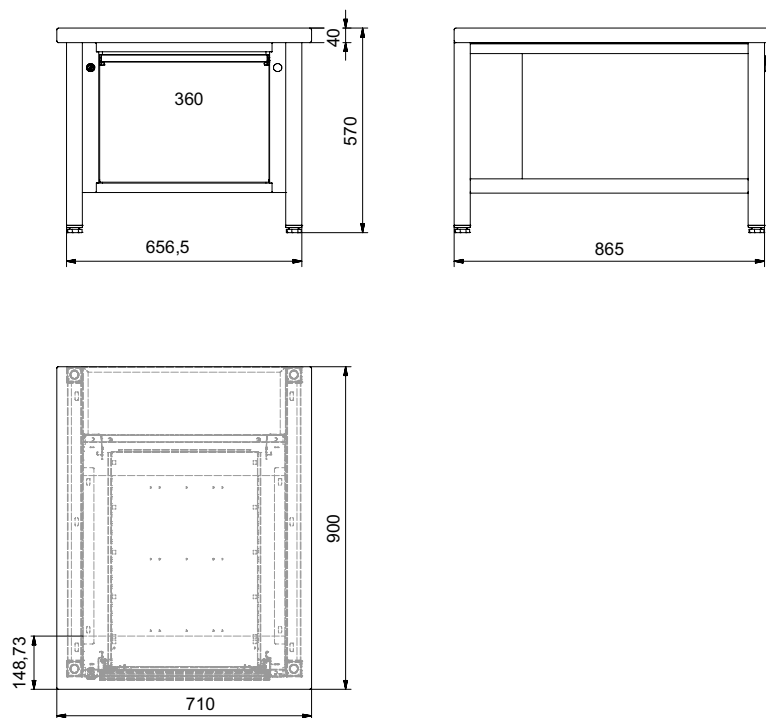



# Bench tester stand

## Technical drawing UN-STAND 960

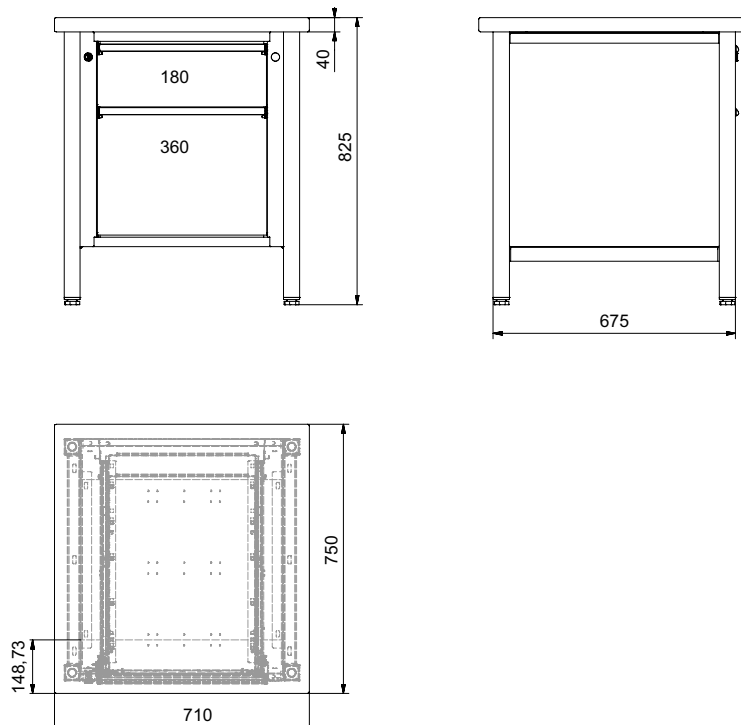

## Technical drawing UN-STAND 965

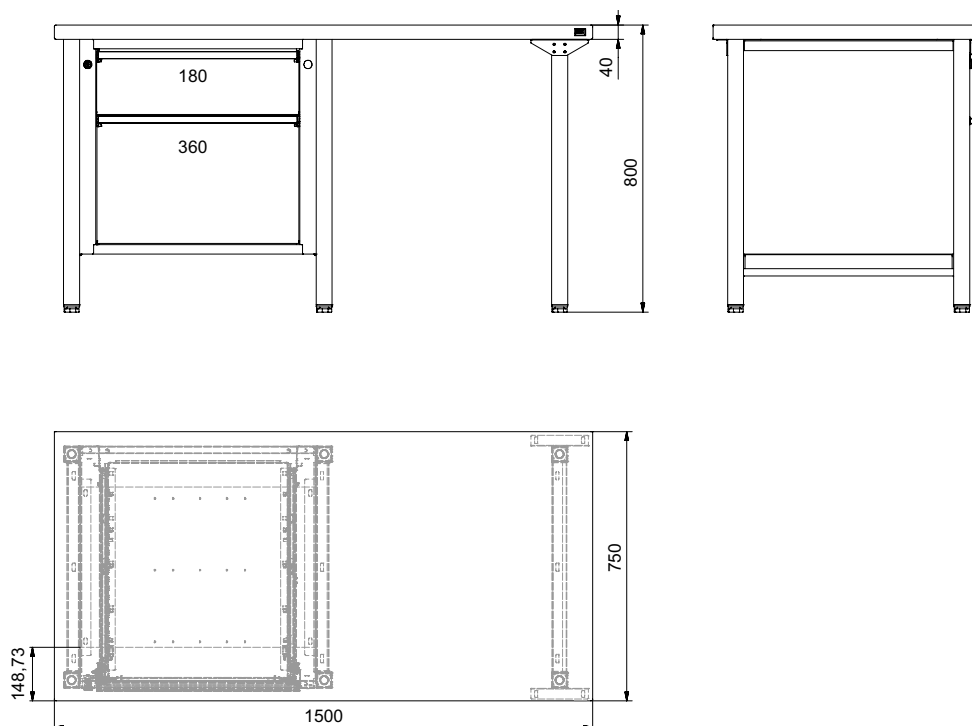

# Testblocks and Indenters

## Wide range of indenters

### According to international standards ISO & ASTM

INNOVATEST® offers a wide range of indenters. All certified indenters will be supplied with a certificate traceable to internationally recognized standards according to ISO and ASTM.

### Specials

INNOVATEST® also offers special adaptors for indenters to enlarge the field of application.

Small gooseneck adaptors are available in three sizes to permit regular or superficial Rockwell hardness testers to perform internal tests on rings, tubes and annular parts where the inside diameter, plus the wall thickness, is less than 50.8mm or 2 inches.

These adaptors will fit any of the standard Rockwell hardness testers. The gooseneck adaptor can be clamped into the bottom of the plunger rod (in the same manner as an indenter) and is not heavy enough to affect a reading due to increasing the applied load. The minimum internal diameter which can be tested is 11.5mm or 7/16 inch.



# Testblocks and Indenters

## Reference hardness blocks

### With INNOVATEST® certificate according to international standards ISO & ASTM

INNOVATEST® reference hardness blocks are used for annual verification and calibration of hardness testing machines, as well as for periodical checking and sometimes to transferring hardness scales on a hardness tester.

That's why reference hardness blocks are a necessary help of industrial Quality Management.

Only the use of high quality, precise reference hardness blocks calibrated to applicable standards can ensure the functionality and relative reliability and accuracy of measurement of a hardness testing machine.

The reference hardness blocks used for indirect verification should conform largely to the workpiece to be tested, in terms of material characteristics and hardness range. For this reason a reference hardness block made of aluminum was developed for the lower hardness range which cannot be covered by steel.

When using reference hardness blocks it is irrelevant whether the value of the nominal hardness to be delivered corresponds exactly to the actual calibration value observed, since scale adaptation should be carried out with at least two hardness values. A reference hardness block shall only be used according to the standards to that method and test condition for which it was calibrated.

INNOVATEST® certified reference hardness blocks are available as follows and all conform to the international standards as mentioned.

#### All INNOVATEST® reference hardness block certificates are based on following international standards:

Brinell	ISO 6506-3	ASTM E 10
Vickers	ISO 6507-3	ASTM E 92/E 384
Rockwell	ISO 6508-3	ASTM E 18
Knoop	ISO 4545-3	ASTM E 384
Rockwell carbide	ISO 3738	
Martens hardness	ISO DIS 14577	

Scale	ISO	ISO/MPA	ASTM	INNOVATEST®
Regular Rockwell (all scales)	•	•	•	•
Superficial Rockwell (all scales)	•	•	•	•
Brinell (all scales)	•	•	•	•
Macro Vickers (all scales)	•	•	•	•
Micro Vickers (all scales)	•	•	•	•
Knoop	•	•	•	•
Martens hardness	•	•	•	•

Order your blocks based on nominal values.

Please ask for our separate product list of nominal hardness values available per hardness scale and type of certificate.

Represented by:

## **CORPORATE HEAD OFFICE**

**INNOVATEST Europe BV**  
**MANUFACTURING, DISTRIBUTION & SERVICE**

Borgharenweg 140  
6222 AA Maastricht (The Netherlands)  
Phone: +31 43 3520060  
Fax: +31 43 3631168  
E-mail: [info@innovatest-europe.com](mailto:info@innovatest-europe.com)  
Website: [www.innovatest-europe.com](http://www.innovatest-europe.com)

INNOVATEST has a global presence for sales and service. Please contact our head office for contact details on the nearest branch office or distributor.

---

**INNOVATEST Shanghai Co., Ltd.**  
**DISTRIBUTION, SALES & SERVICE**

Building 2, No.123, 1165 Nong Jindu Road,  
South Metropolis Industrial Park  
Minhang District, Shanghai, P.R. China  
Zip code: 201108  
Phone: +86 21 60906200  
Fax: +86 21 60912595  
E-mail: [info@innovatest-shanghai.com](mailto:info@innovatest-shanghai.com)  
Website: [www.innovatest-shanghai.com](http://www.innovatest-shanghai.com)

**INNOVATEST SOUTH EAST ASIA**  
**CUSTOMER SUPPORT CENTER**

(c/o LMS Technologies Pte Ltd)  
20 Sin Ming Lane #05-58 Midview City  
Singapore 573 968  
Phone: +65 6451 1123  
Fax: +65 6452 1011  
E-mail: [info@lmstech.com.sg](mailto:info@lmstech.com.sg)  
Website: [www.lmsscscientific.com](http://www.lmsscscientific.com)