

# Profibus

DP/V1 Interface for Bayard-Alpert / Pirani Gauge  
and High Pressure / Pirani Gauge

BPG400-SP  
HPG400-SP

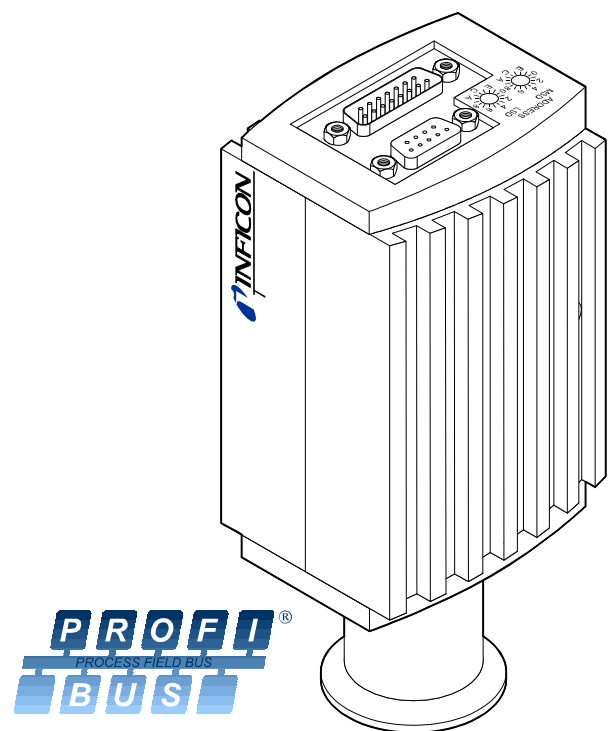

## About this Document

This document describes the functionality and programming of the Profibus interface of the BPG400-SP and HPG400-SP gauges. The interface hardware, the firmware, and the communication protocol are practically the same for both gauges. Information that applies to only one of the above gauge types is correspondingly identified in this document.



For safety information on and technical data of the gauges, please refer to their respective operating manuals (→ [1], [3] for BPG400-SP and [4], [6] for HPG400-SP).

In information referring to the ionization vacuum measuring part of the gauge, the short designations

"BA" (BPG400-SP, Bayard-Alpert measuring principle)  
 "HP" (HPG400-SP High Pressure Gauge)

are used. The short designation "BA/HP" means that the corresponding information applies to both gauge types.

The designation "Pirani" is used in information referring to the Pirani vacuum measuring part of the gauge.

## Product Identification

In all communications with INFICON, please specify the information on the product nameplate. For convenient reference copy that information into the space provided below.

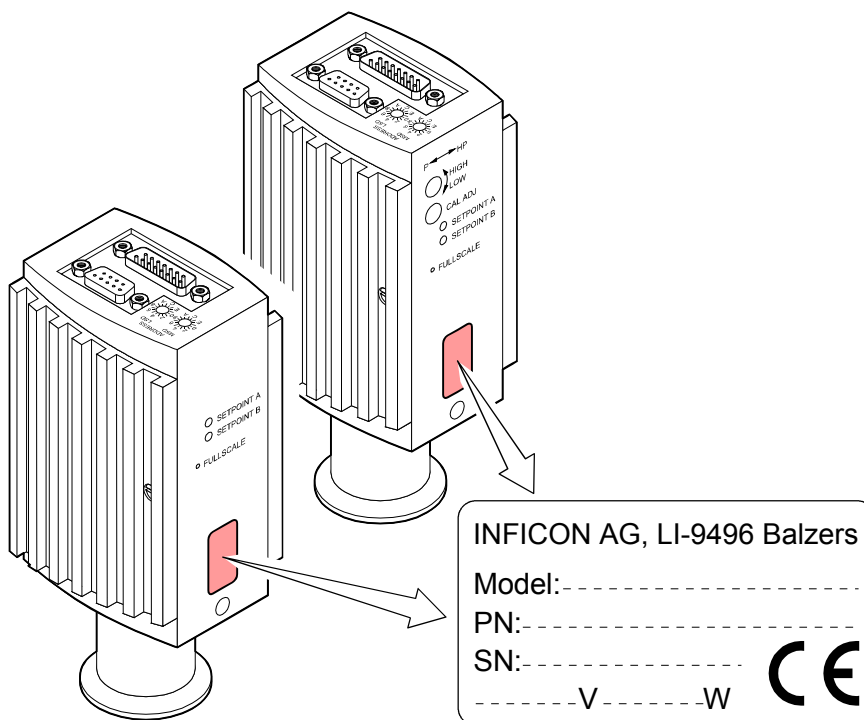

## Validity

This document applies to products with part numbers

BPG400-SP (with Profibus interface and switching functions)

353-505 (vacuum connection DN 25 ISO-KF)

353-506 (vacuum connection DN 40 CF-R)



HPG400-SP (with Profibus interface and switching functions)

353-525 (vacuum connection DN 25 ISO-KF)

353-526 (vacuum connection DN 40 CF-R)



The part number (PN) can be taken from the product nameplate.

## Intended Use

The BPG400-SP and HPG400-SP gauges allow vacuum measurement of non flammable gases and gas mixtures (pressure ranges →  [1], [3] for BPG400-SP and  [4], [6] for HPG400-SP).

The gauges can be operated with an INFICON controller or another instrument or control device.

## Functional Principle

The functions of the gauges are described in their respective operating manuals (→  [1], [2], [3] for BPG400-SP and  [4], [5], [6] for HPG400-SP).

The integrated Profibus interface allows operating the gauge in connection with other suitable devices in a Profibus network according to the standard described in  [6], [7].

## Trademarks

SEMI<sup>®</sup> Semiconductor Equipment and Materials International, California

# Contents

About this Document	2
Product Identification	2
Validity	2
Intended Use	3
Functional Principle	3
Trademarks	3
<b>1 General Data</b>	<b>6</b>
1.1 Data Rate	6
1.2 Device Address	6
1.3 Ident Number	6
1.4 Configuration Data	6
1.5 User Parameter Data	7
1.6 Types of Communication	7
<b>2 Data Exchange Mode</b>	<b>8</b>
2.1 Acyclic Data Transmission with Profibus DPV1 Functionality	8
2.2 Structure of the Cyclic Data Telegrams in Data Exchange Mode	9
2.2.1 Parameter Channel	10
2.2.1.1 PKE Parameter Signature Value	10
2.2.1.2 PWE Parameter Process Value	11
2.2.1.3 Error Code (Error Message)	11
2.3 Cyclic Message Telegrams	12
<b>3 Block Model</b>	<b>13</b>
3.1 Device Block	14
3.1.1 Information on the Individual Indices	15
3.1.1.1 Block Type ID 16	15
3.1.1.2 Device Type ID 17	15
3.1.1.3 Standard Revision Level ID 18	15
3.1.1.4 Device Manufacturer Identifier ID 19	15
3.1.1.5 Manufacturer Model Number ID 20	15
3.1.1.6 Software or Firmware Revision Level ID 21	15
3.1.1.7 Hardware Revision Level ID 22	15
3.1.1.8 Device Configuration ID 24	15
3.1.1.9 Device State ID 25	15
3.1.1.10 Exception Status ID 26	16
3.1.1.11 Exception Detail Alarm ID 27	17
3.1.1.12 Exception Detail Warning ID 28	19
3.1.1.13 Emission On Switch ID 202 (HPG400-SP Only)	20
3.1.1.14 Sensor Calibration Switch ID 203 (HPG400-SP Only)	21
3.1.1.15 Copy Common Exception Detail Alarm 0 ID 204	21
3.1.1.16 Copy Device Exception Detail Alarm 0 ... 3 ID 205	21
3.1.1.17 Copy Manufacturer Exception Detail Alarm 0 ID 206	21
3.1.1.18 Copy Common Exception Detail Warning 0 ID 207	21
3.1.1.19 Copy Device Exception Detail Warning 1 ... 4 ID 208	21
3.1.1.20 Copy Manufacturer Exception Detail Warning 0 ID 209	21
3.1.2 Device Block, Device Behavior	22
3.1.2.1 Device Block State Command	23
3.2 Analog Input Block	23
3.2.1 One Of N Analog Input Function Block / SLOT 1	24
3.2.1.1 AI Block Adjust Command (Adjustment at Atmospheric Pressure)	24
3.2.1.2 Block Type	24
3.2.1.3 Channel Instance Selector	24
3.2.1.4 PV Selector	24
3.2.2 Analog Sensor Input Function Block Instance 1 / SLOT 1	25
3.2.2.1 Process Value	25
3.2.2.2 Status	25
3.2.2.3 Data Type	26
3.2.2.4 Data Unit	26
3.2.2.5 Reading Valid	26
3.2.2.6 Full Scale	26
3.2.2.7 Safe State	27
3.2.2.8 Safe Value	27
3.2.2.9 Overrange	27
3.2.2.10 Underrange	27
3.2.3 Analog Sensor Input Function Block Instance 2 / SLOT 1	28
3.2.3.1 Process Value	28

3.2.3.2	Status	29
3.2.3.3	Data Type	29
3.2.3.4	Data Unit	29
3.2.3.5	Reading Valid	30
3.2.3.6	Full Scale	30
3.2.3.7	Safe State	30
3.2.3.8	Safe Value	30
3.2.3.9	Overrange	31
3.2.3.10	Underrange	31
3.2.4	Analog Sensor Input Function Block Instances 3 and 4 / SLOT 1	32
3.2.4.1	Process Value	32
3.2.4.2	Status	33
3.2.4.3	Data Type	33
3.2.4.4	Data Unit	33
3.2.4.5	Reading Valid	33
3.3	Transducer Block	33
3.3.1	One Of N Vacuum Gauge Transducer Block / SLOT 1	33
3.3.1.1	One Of N Status Extension	33
3.3.2	Heat Transfer Vacuum Gauge Transducer Block / SLOT 1	33
3.3.2.1	Block Type	33
3.3.2.2	Status Extension	34
3.3.2.3	Sensor Alarm	34
3.3.2.4	Sensor Warning	34
3.3.2.5	Full Scale State	34
3.3.3	Hot Cathode Ion Gauge Transducer Block / SLOT 1	35
3.3.3.1	Block Type	35
3.3.3.2	Status Extension	35
3.3.3.3	Sensor Alarm	35
3.3.3.4	Sensor Warning	35
3.3.3.5	Emission Status	36
3.3.3.6	Emission Current (BPG400-SP Only)	36
3.3.3.7	Degas Status (BPG400-SP Only)	36
3.3.3.8	Hot Cathode Block State Command (BPG400-SP Only)	36
<b>Appendix A: Definitions</b>		<b>37</b>
<b>Appendix B: Block Type</b>		<b>40</b>
<b>Appendix C: Electrical Connections</b>		<b>41</b>
<b>Appendix D: Literature</b>		<b>43</b>

For cross-references to other documents, the symbol (→  [XY]) is used.

# 1 General Data

## 1.1 Data Rate

The gauge supports all data rates defined in the EN 50170 standard (→ [8]) up to 12 Mbaud. Automatic data rate setting is supported. Alternatively, a fixed data rate can be selected.

## 1.2 Device Address

The device address (≙ node address) must be set via two rotary switches when the gauge is installed.

For unambiguous identification of the gauge in a Profibus environment, a node address is required. The node address setting is made on the gauge.

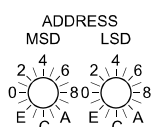

The node address (0 ... 125<sub>dec</sub>) is set in hexadecimal form (00 ... 7D<sub>hex</sub>) via the "ADDRESS" switches. The "MSD" switch is used for setting the high-order address nibble and the "LSD" switch for defining the low-order address nibble.

The node address is polled by the firmware when the gauge is switched on. If the setting deviates from the stored value, the new value is taken over into the NVRAM. If a value >7D<sub>hex</sub> (>125<sub>dec</sub>) is entered, the node address setting currently stored in the device remains valid. However, the address can be set via the Profibus master with the "Set Slave Address" service. This address setting will be stored in the EEPROM of the gauge.

## 1.3 Ident Number

The ident numbers assigned to the gauges by the PNO (→ [7]) are:

Gauge	Ident number (hexadecimal)
BPG400-SP	06A9
HPG400-SP	06A8

## 1.4 Configuration Data

Depending on the standard telegrams used (→ section "Cyclic Message Telegrams"), the following configuration data have to be transmitted to the gauge during the configuration phase:

Standard telegram Master ⇒ Slave	Standard telegram Slave ⇒ Master	Configuration data
-	2	0x44, 0x84, 0x05, 0x05, 0x05, 0x03
-	3	0x44, 0x86, 0x05, 0x05, 0x05, 0x08
1	4	0xC6, 0x87, 0x8c, 0x0A, 0x0A, 0x05, 0x05, 0x05, 0x03
1	5	0xC6, 0x87, 0x8E, 0x0A, 0x0A, 0x05, 0x05, 0x05, 0x08

## 1.5 User Parameter Data

Depending on the pressure unit setting ( $\hat{=}$  data unit), the following configuration string has to be transmitted to the gauge (parameter data in hexadecimal format):

Pressure unit	User parameter data string
COUNTS <sup>1)</sup>	00 00 00 03 E9
Torr	00 00 00 05 15
Micron	00 00 00 05 16
mbar	00 00 00 05 1C
Pascal	00 00 00 05 1D

<sup>1)</sup> If COUNTS is selected as pressure unit, a value is output, which can be converted into a corresponding pressure value by means of a formula ( $\rightarrow$  section "Analog Sensor Input Function Block" for more information).

## 1.6 Types of Communication

BPG400-SP and HPG400-SP work according to the Profibus DPV1 specification and can be addressed in cyclic or acyclic data traffic ( $\rightarrow$   [7]).

Acyclic data traffic should be used to make device or process specific settings such as definition of the Safe Values, Safe States etc. or for reading or writing of rarely used attributes.

Cyclic data traffic is used for continuous exchange of the required process parameter values, i.e. pressure value and status indications. A number of standard telegrams are available for cyclic data traffic. They can be selected according to requirements ( $\rightarrow$  section "Cyclic Message Telegrams").

## 2 Data Exchange Mode

### 2.1 Acyclic Data Transmission with Profibus DPV1 Functionality

The reading and writing operations defined in the Profibus are based on a slot index address scheme. In BPG400-SP / HPG400-SP, all device functions are organized in the following blocks:

- A device block describing all organizational parameters of the gauge (serial number, manufacturer, software version, ...)
- An Analog Sensor Function Block describing the function of the pressure presentation
- An Analog Sensor Transducer Block describing the physical interface between the gauge and the process (emission current, ion current, ...).

The block model is described in detail in section "Block Model".

Each block is assigned to a separate slot. The exact assignment Block  $\Rightarrow$  Slot  $\Rightarrow$  Index is described in section "Block Model". The Device Block is assigned to Slot 0, the transducer and functional blocks to Slot 1.

Block, slot and index assignment

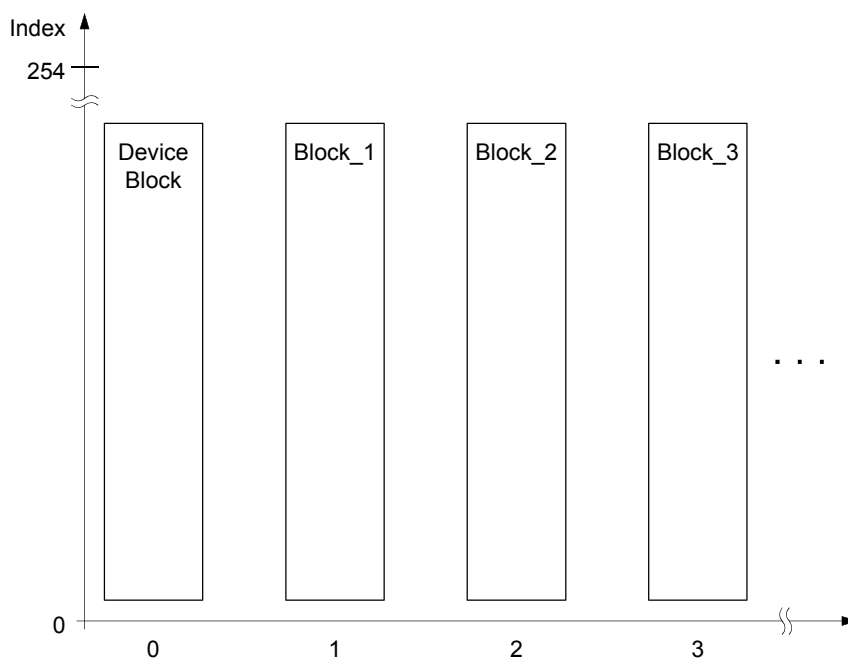

There are 254 indices per slot. The indices can have a width of 255 bytes. All values that can be accessed via Profibus have to be mirrored to one of these slots/indices.

The parameters are generally numbered in ascending order, starting with index 16. Services such as "Degas On" or "Full scale" are numbered in descending order, starting with index 15.



Assignment of the block elements to the slot indices

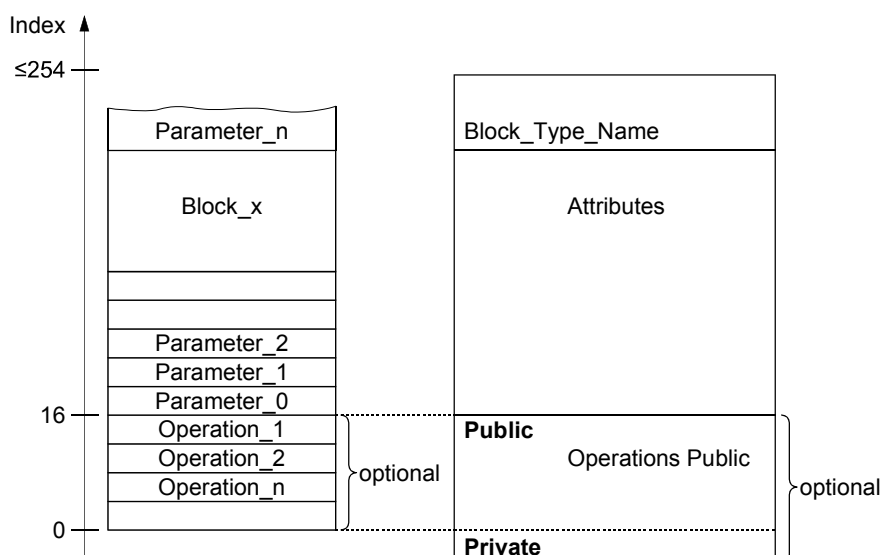

## 2.2 Structure of the Cyclic Data Telegrams in Data Exchange Mode

In Data Exchange mode, the DP master class 1 cyclically transmits data from and to all slaves that are connected to the bus.

In this document, data transmitted from the slave to the master are called "input data" and data transmitted from the master to the slave are called "output data".

The input and output data of the BPG400-SP / HPG400-SP have two logic parts:

- 1) the parameter channel
- 2) the process data channel

There is a number of standard telegrams, consisting of:

- a) the parameter channel only
- b) the process data channel only
- c) both, the parameter and process data channel

The parameter channels allows masters without Profibus DPV1 to access device specific parameters that are not part of the normal cyclic data telegram. For masters with Profibus DPV1, no parameter channel is required.

Input data

The input data (transmitted by the BPG400-SP / HPG400-SP) consist of the 8 bytes of the parameter channel (if there is a parameter channel in the standard telegram) and of 5 ... 7 bytes of process data depending on the selected standard telegram.

Byte								Byte						
1	2	3	4	5	6	7	8	9	10	11	12	13	14	15
Parameter channel								Process data						
PKE	IND	res.	PWE											

Where: PKE = Parameter Signature Value    ≙ Reading or writing command and definition of the slot  
 IND = Sub Index    ≙ Index No. of the index to be read (→ "Block Model")  
 res. = reserved  
 PWE = Process Value    ≙ Value to be read or written

## Output data

The output data (transmitted by the master) consist of 8 bytes of the parameter channel or, if there is no parameter channel in the standard telegram, of 0 bytes.

Byte							
1	2	3	4	5	6	7	8
Parameter channel							
PKE		IND	res.	PWE			

### 2.2.1 Parameter Channel

The structure of the parameter channel is described in the table below.

The parameter channel (called PKW Interface hereinafter) consists of 8 bytes.

Octets							
1	2	3	4	5	6	7	8
PKE		IND	res.	PWE			

The PKW Interface allows reading and writing of slave parameters with a maximum data length of 4 bytes. Strings cannot be read.

The slave generates exactly one response per instruction transmitted by the master. The instruction and response cannot be blocked. This means that exactly one instruction per output telegram can be transmitted to the slave and that exactly one response per input telegram can be transmitted to the master. 4 bytes of actual data can thus be transmitted at a time.

#### 2.2.1.1 PKE Parameter Signature Value

The instruction and response are represented in the first two bytes (PKE) of the parameter channel:

Bit position															
15	14	13	12	11	10	9	8	7	6	5	4	3	2	1	0
AK				res.				Slot							

Where:	Bits	Meaning
	15 ... 12	AK $\hat{=}$ Instruction/response signature
	11 ... 8	Reserved
	7 ... 0	Define the slot from which data are read or onto which a value is to be written

## Instruction signature

In Master  $\Rightarrow$  Slave communication, the AK field contains the instruction signature of the master.

In Slave  $\Rightarrow$  Master communication, the AK field contains the instruction signature of the slave.

AK	Function Master $\Rightarrow$ Slave (Instruction signature)	AK normal	Function Slave $\Rightarrow$ Master (Response signature)	AK error
0	No instruction	0	No response	
1	Read parameter value	1 2 11	Transmit parameter value (word) Transmit parameter value (double word) Transmit parameter value (byte)	7 <sup>1)</sup>
2	Write parameter value (data type: word)	1	Transmit parameter value (word)	7 <sup>1)</sup>
3	Write parameter value (data type: double word)	2	Transmit parameter value (double word)	7 <sup>1)</sup>
10	Write parameter value (data type: byte)	11	Transmit parameter value (byte)	7 <sup>1)</sup>

<sup>1)</sup> Instruction cannot be executed (error code)

On the left of the table, the instruction signatures of the master are listed according to their function. On the right of the table, the corresponding normal responses (AK Normal) and error codes (AK Error) transmitted by the slave are listed.

Instruction – response sequence

- 1) The master transmits an instruction to the slave and repeats that instruction until it receives a response from the slave.
- 2) The slave keeps transmitting the response to the instruction until the master transmits a new instruction.
- 3) The master marks the end of the first instruction cycle by setting AK to zero. Only after that, a new instruction/response cycle may be started.

### 2.2.1.2 PWE Parameter Process Value

The PWE represents the data element to be transmitted.

If a byte is to be transmitted, that byte has to be in position 8 of the parameter channel.

Integers are transmitted with bytes 7 and 8. Double integer and float values are transmitted with bytes 5 ... 8.

### 2.2.1.3 Error Code (Error Message)

In the event of a transmission error (AK response signature = 7), the slave transmits an error code in byte positions 7 and 8 (data type: INT16).

Error code	Meaning
0	Undefined slot
1	Parameter not changeable
2	Lower or upper value range limit overflow
3	Index error
5	Data type error
17	Instruction not allowed in this state
18	Other errors
201	Already in requested state
202	Object state conflict

The following diagram shows an example of a data request from a master to a BPG400-SP / HPG400-SP via parameter channel.

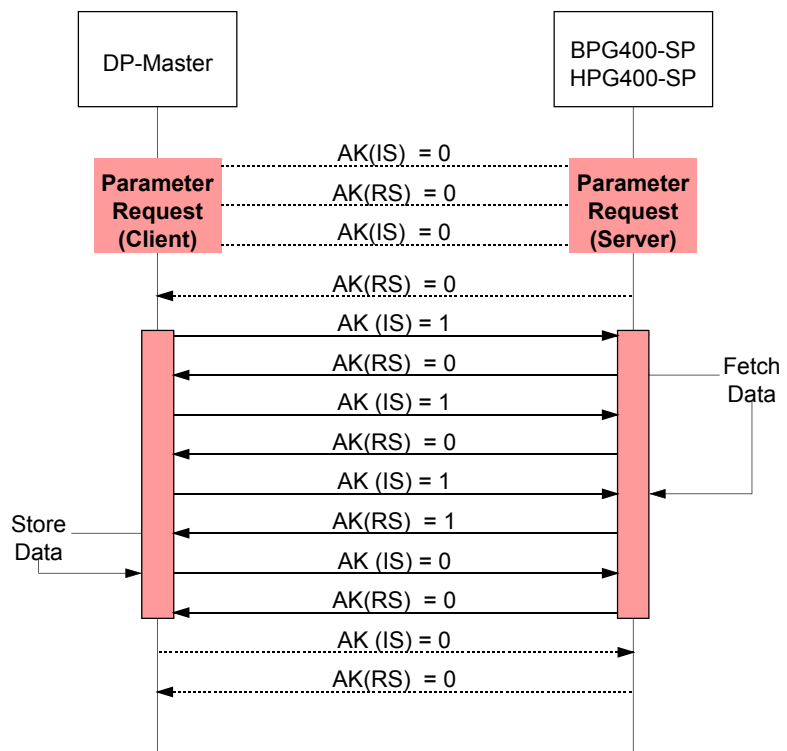

## 2.3 Cyclic Message Telegrams

The message telegrams listed below are implemented in the gauge. They can be selected according to requirements. When selecting a message telegram, ascertain what output format of the measured value (integer/float) is required and whether a parameter channel is needed or not. The gauge can also be operated in such a way that the master does not transmit any output data to the slave.

Standard telegram	Master ↔ Slave	Byte	Meaning
1	M ⇒ S	1 ... 8	Parameter channel
2	S ⇒ M	1 2 3 4 ... 5	Exception status One Of N status extension One Of N PV selector Process value UINT16
3	S ⇒ M	1 2 3 4 ... 7	Exception status One Of N status extension One Of N PV selector Process value float
4	S ⇒ M	1 ... 8 9 10 11 12 ... 13	Parameter channel Exception status One Of N status extension One Of N PV selector Process value UINT16
5	S ⇒ M	1 ... 8 9 10 11 12 ... 15	Parameter channel Exception status One Of N status extension One Of N PV selector Process value float

### Configuration data

In the following table, the possible reasonable combinations are listed with the corresponding configuration data.

Standard telegram Master ⇒ Slave	Standard telegram Slave ⇒ Master	Configuration data
-	2	0x44, 0x84, 0x05, 0x05, 0x05, 0x03
-	3	0x44, 0x86, 0x05, 0x05, 0x05, 0x08
1	4	0xC6, 0x87, 0x8c, 0x0A, 0x0A, 0x05, 0x05, 0x05, 0x03
1	5	0xC6, 0x87, 0x8E, 0x0A, 0x0A, 0x05, 0x05, 0x05, 0x08

## 3 Block Model

Data to the BPG400-SP / HPG400-SP can be transmitted by means of a number of communication protocols and corresponding masters. Profibus defines a master class 1 as normal control unit of the slave (typically a PLC) and a master class 2 as configuration and service unit. The following communication protocols are defined according to the Profibus DPV1 standard.

MS0	Cyclic data traffic between master class 1 and slave
MS1	Acyclic data traffic between master class 1 and slave
MS2	Acyclic data traffic between master class 2 and slave

In BPG400-SP / HPG400-SP, all functions that are made available by the gauge via Profibus are organized in blocks. Access to the individual parameters of the blocks is possible via acyclic services or, for byte, integer and float values, also in cyclic data traffic via the parameter channel.

### Block types

The following block types are defined in the gauge.

Device Block	The Device Block contains all data that are required for describing the device and handling its state (status of Device State Machine).
Transducer Block	<p>The physical, process specific functions or interfaces between the BPG400-SP / HPG400-SP and the process such as current and voltage values are represented in transducer blocks.</p> <p>The following transducer blocks are implemented:</p> <ul style="list-style-type: none"> <li>• One of N Vacuum Gauge Transducer Block</li> <li>• Heat Transfer Vacuum Gauge Transducer Block (Pirani)</li> <li>• Hot Cathode Ion Gauge Transducer Block (BA/HP)</li> </ul>
Function Block	<p>Application specific values such as pressure values that result from or can be calculated from the values of the transducer block are represented in the function blocks.</p> <ul style="list-style-type: none"> <li>• One Of N Analog Input Function Block</li> <li>• Analog Input Function Block, Instance 1, Instance 2, Instance 3, Instance 4</li> </ul>

### 3.1 Device Block

The following table lists the services and parameters integrated in the Device Block (→ Appendix A for abbreviations).

ID	Name	Structure	Data type	Bytes	Access	Value	Store
15	Device Block State	Simple	Unsigned8	1	1_R/W 2_R/W		
16	Block Type	Simple	Octet string	4	1/2_R	1	N
17	Device Type	Simple	Visible string	8	1/2_R	CG	N
18	Standard Revision Level	Simple	Visible string	9	1/2_R	E54-0997	N
19	Device Manufacturer Identifier	Simple	Visible string	20	1/2_R	INFICON AG	N
20	Manufacturer Model Number	Simple	Visible string	20	1/2_R	e.g. 353-525	N
21	Software or Firmware Revision Level	Simple	Visible string	8	1/2_R	e.g. 1.01	N
22	Hardware Revision Level	Simple	Visible string	8	1/2_R	e.g. 1.0	N
23	Serial Number	Simple	Visible string	30	1/2_R	e.g. 100	N
24	Device Configuration	Simple	Visible string	50	1/2_R	e.g. HPG400-SP	N
25	Device State	Simple	Unsigned8	1	1/2_R		V
26	Exception Status	Simple	Unsigned8	1	0_XI 1/2_R		V
27	Exception Detail Alarm	Record	→ below	-	1/2_R		V
28	Exception Detail Warning	Record	→ below	-	1/2_R		V
202	Emission On Switch	Simple	Analogical to data type value (parameter 21)	1	1/2_R		V
203	Sensor Calibration Switch	Simple	UINT8	1	1/2_R		V
204	Common Exception Detail Alarm 0	Simple	UINT8	1	1/2_R		V
205	Device Exception Detail Alarm 0 ... 3	Struct	Array of 4 bytes	4	1/2_R		V
206	Manufacturer Exception Detail Alarm 0	Simple	UINT8	1	1/2_R		V
207	Common Exception Detail Warning 0	Simple	UINT8	1	1/2_R		V
208	Device Exception Detail Warning 1 ... 4	Struct	Array of 4 bytes	4	1/2_R		V
209	Manufacturer Exception Detail Warning 0	Simple	UINT8	1	1/2_R		V

### 3.1.1 Information on the Individual Indices

#### 3.1.1.1 Block Type ID 16

The Block Type Parameter contains an ID which describes the block type. The block type ID of the Device Block 1. The other defined block types are listed in Appendix B.

#### 3.1.1.2 Device Type ID 17

The Device Type identifies the device type which is connected to the field bus via Profibus.

The Device Type of the BPG400-SP / HPG400-SP gauges is "CG", the abbreviation of "Combination Gauge".

#### 3.1.1.3 Standard Revision Level ID 18

This parameter describes the version of the "Sensor/Actuator Network Specific Device Model" published by the SEMI® (Semiconductor Equipment and Materials International, California), according to which the profile of this device has been developed.

The fixed setting of this parameter is "E54-0997".

#### 3.1.1.4 Device Manufacturer Identifier ID 19

This parameter describes the manufacturer of the device, "INFICON AG".

#### 3.1.1.5 Manufacturer Model Number ID 20

This parameter represents the part number of the gauge (→ section "Validity"). BPG400-SP and HPG400-SP are available with two different vacuum connection types each, for example:

Gauge	Vacuum connection	Part number
HPG400-SP	25 KF	353-525

#### 3.1.1.6 Software or Firmware Revision Level ID 21

This parameter indicates the software version of the Profibus option in the format "1.01".

#### 3.1.1.7 Hardware Revision Level ID 22

This parameter indicates the hardware version of the gauge in the format "1.0".

#### 3.1.1.8 Device Configuration ID 24

This parameter indicates the device name. If the BPG400-SP is connected, BPG400-SP is output, if the HPG400-SP is connected, HPG400-SP is output.

#### 3.1.1.9 Device State ID 25

This parameter indicates the status of the gauge. Due to the structure of the Device State Machine, the following statuses are possible:

Parameter value	Status
0	Undefined
1	Self testing
2	Idle
3	Self test exception
4	Executing
5	Abort
6	Critical fault

The device statuses are described in detail in section "Device Block, Device Behavior".

### 3.1.1.10 Exception Status ID 26

The Exception Status describes the alarm and warning statuses of the gauge in an "Expanded error output format".

A difference is made between warnings and errors.

Alarms and errors are divided into three groups (→ sections "Exception Detail Alarm" and "Exception Detail Warning" for details):

- ALARM / Warning Device Common      For errors that occur independently of the type of device used, e.g. supply error, RAM, ROM, or EEPROM error.
- ALARM / Warning Device Specific      For device specific errors, e.g. filament rupture (Pirani), or cathode rupture (BA/HP).
- ALARM / Warning Manufacturer Specific      For errors defined by the manufacturer that are not mentioned in the standard.

In each of the above groups, there are several error or warning conditions. The individual fields are presented in the "Exception Detail Alarm" and "Exception Detail Warning". If an error message occurs in "Exception Detail Alarm" or "Exception Detail Warning", the corresponding bit is set in the Exception Status. Therefore, if bits 0 ... 6 of the Exception Status are on "0" there is no warning message pending. If a bit is set, the actual error can be read in the corresponding group.

The Exception Status is output in cyclic data and informs on the current error status using only one byte. If an error occurs, the current error status can be read via acyclic services or in cyclic data exchange via the parameter channel. This ensures that while the current error status is always available in the cyclic data, no unnecessary data overhead is transmitted.

Bit	Function	Meaning
0	ALARM, device common	The bit is set if an error of the Alarm Device Common group is detected.
1	ALARM, device specific	The bit is set if an error of the Alarm Device Specific group is detected.
2	ALARM, manufacturer specific	The bit is set if an error of the Alarm Manufacturer Specific group is detected.
3	-	-
4	WARNING, device common	The bit is set if an error of the Warning Device Common group is detected.
5	WARNING, device specific	The bit is set if an error of the Warning Device Specific group is detected.
6	WARNING, manufacturer specific	The bit is set if an error of the Warning Manufacturer Common group is detected.
7	Expanded Format	Is constantly on "1" and marks the use of the expanded error output format.



### 3.1.1.11 Exception Detail Alarm ID 27

If, in the Exception Status, one of the bits 0 ... 2 is set, the current error can be read in the "Exception Detail Alarm" parameter. The "Exception Detail Alarm" parameter consists of a total of 10 bytes that inform on the error status of the gauge.

Due to the use of the expanded error output format, these bytes have the following structure:

Byte No	Name	Description	Value
0	Common Exception Detail Size	Indicates the number of subsequent bytes that contain the Common Exception Detail Alarm.	2
1	Common Exception Detail 0	Contains current error messages from the Common Exception Detail Alarm group.	Depending on error status
2	Common Exception Detail 1	Contains current error messages from the Common Exception Detail Alarm group.	Depending on error status
3	Device Exception Detail Size	Indicates the number of subsequent bytes that contain the Device Exception Detail Alarm.	4
4	Device Exception Detail 0 (Pirani error data)	This error information from the Common Exception Detail Alarm group refers to Pirani.	Depending on error status
5	Device Exception Detail 1 (Pirani error data)	This error information from the Common Exception Detail Alarm group refers to Pirani.	Depending on error status
6	Device Exception Detail 2 (BA/HP error data)	This error information from the Common Exception Detail Alarm group refers to BA/HP.	Depending on error status
7	Device Exception Detail 3 (BA/HP error data)	This error information from the Common Exception Detail Alarm group refers to BA/HP.	Depending on error status
8	Manufacturer Exception Detail Size	Indicates the number of subsequent bytes that contain the Device Exception Detail Alarm.	1
9	Manufacturer Exception Detail 0	Contains current error messages from the Manufacturer Exception Detail Alarm group.	Depending on error status

#### Common Exception Detail Alarm

Bit	Common Exception Detail 0
0	0
1	0
2	EPROM exception
3	EPROM exception
4	RAM exception
5	0
6	0
7	0

Bit	Common Exception Detail 1
0	0
1	0
2	0
3	0
4	0
5	0
6	0
7	0

Device Exception  
Detail Alarm

Bit	Device Exception Detail 0 Referring to Pirani <sup>1)</sup>
0	0
1	0
2	0
3	0
4	0
5	0
6	0
7	0

<sup>1)</sup> This byte is a copy of Sensor Alarm byte 0 of the Heat Transfer Vacuum Gauge Transducer Block Common Exception Detail 0.

Bit	Device Exception Detail 1 Referring to Pirani <sup>2)</sup>
0	0
1	Electronics/sensor error Pirani
2	0
3	0
4	0
5	0
6	0
7	0

<sup>2)</sup> This byte is a copy of Sensor Alarm byte 1 of the Heat Transfer Vacuum Gauge Transducer Block.

Bit	Device Exception Detail 2 Referring to BA/HP <sup>3)</sup>
0	0
1	0
2	0
3	0
4	0
5	0
6	0
7	0

<sup>3)</sup> This byte is a copy of Sensor Alarm byte 0 of the Hot Cathode Ion Gauge Transducer Block.

Bit	Device Exception Detail 3 Referring to BA/HP <sup>4)</sup>
0	0
1	Electronics/sensor error BA/HP
2	0
3	0
4	0
5	0
6	0
7	0

<sup>4)</sup> This byte is a copy of Sensor Alarm byte 1 of the Hot Cathode Ion Gauge Transducer Block.

Manufacturer Exception  
Detail Alarm 0

If there is an internal communication error in the gauge, the byte Manufacturer Exception Detail 0 is set to "1".

### 3.1.1.12 Exception Detail Warning ID 28

If, in the Exception Status, one of bits 4 ... 6 is set, the current warning can be read in the parameter "Exception Detail Warning". The Exception Detail Warning parameter consists of a total of 11 bytes that inform on the error status of the gauge.

Due to the use of the expanded error output format, these bytes have the following structure:

Byte No	Name	Description	Value
0	Common Exception Detail Size	Indicates the number of subsequent bytes that contain the Common Exception Detail Warning.	2
1	Common Exception Detail 0	Contains current error messages from the Common Exception Detail Warning group.	Depending on warning status
2	Common Exception Detail 1	Contains current error messages from the Common Exception Detail Warning group.	Depending on warning status
3	Device Exception Detail Size	Indicates the number of subsequent bytes that contain the Device Exception Detail Warning.	5
4	Device Exception Detail 0	One Of N Status Extension.	Depending on warning status
5	Device Exception Detail 1 (Pirani)	This error information from the Common Exception Detail Warning group refers to Pirani.	Depending on warning status
6	Device Exception Detail 2 (Pirani)	This error information from the Common Exception Detail Warnings group refers to Pirani.	Depending on warning status
7	Device Exception Detail 3 (BA/HP)	This error information from the Common Exception Detail Alarm group refers to BA/HP.	Depending on warning status
8	Device Exception Detail 4 (BA/HP)	This error information from the Common Exception Detail Alarm group refers to BA/HP.	Depending on warning status
9	Manufacturer Exception Detail Size	Indicates the number of subsequent bytes that contain the Device Exception Detail Warning.	1
10	Manufacturer Exception Detail	Contains current error messages from the Manufacturer Exception Detail Alarm group.	Depending on warning status

#### Common Exception Detail Warning

Bit	Common Exception Detail 0
0	0
1	0
2	EPROM exception
3	EPROM exception
4	RAM exception
5	0
6	0
7	0

Bit	Common Exception Detail 1
0	0
1	0
2	0
3	0
4	0
5	0
6	0
7	0

The warning bits are set in the same way as the error bits because here, warnings have the same meaning as errors.

Device Exception  
Detail Warning

Bit	Device Exception Detail 0
0	Bit set if Reading Invalid
1	Bit set if Device Overrange
2	Bit set if Device Underrange
3	0
4	0
5	0
6	0
7	0

Bit	Device Exception Detail 1 Referring to Pirani <sup>1)</sup>
0	0
1	0
2	0
3	0
4	0
5	0
6	0
7	0

Bit	Device Exception Detail 2 Referring to Pirani <sup>2)</sup>
0	0
1	Electronics/sensor warning Pirani
2	0
3	0
4	0
5	0
6	0
7	0

<sup>1)</sup> This byte is a copy of Sensor Warning byte 0 of the Heat Transfer Vacuum Gauge Transducer Block.

<sup>2)</sup> This byte is a copy of Sensor Warning byte 1 of the Heat Transfer Vacuum Gauge Transducer Block.

Bit	Device Exception Detail 3 Referring to BA/HP <sup>3)</sup>
0	0
1	0
2	0
3	0
4	0
5	0
6	0
7	0

Bit	Device Exception Detail 4 Referring to BA/HP <sup>4)</sup>
0	0
1	Electronics/sensor warning BA/HP
2	0
3	0
4	0
5	0
6	0
7	0

<sup>3)</sup> This byte is a copy of Sensor Warning byte 0 of the Hot Cathode Ion Gauge Transducer Block.

<sup>4)</sup> This byte is a copy of Sensor Warning byte 1 of the Hot Cathode Ion Gauge Transducer Block.

Manufacturer Exception  
Detail Warning 0

If there is an internal communication error in the gauge, the byte "Manufacturer Exception Detail 0" is set to "1" (according to the alarm condition).

**3.1.1.13 Emission On Switch  
ID 202  
(HPG400-SP Only)**

The parameter contains the value of the switchover point from Pirani to HP measurement (→ [4], [5], [6]).

This value can be read only and corresponds to the value that can be set with the "LOW-HIGH" switch on the side of the gauge (→ [4], [6]). The value of the switchover point is output in the currently selected data unit (≙ pressure unit).

If COUNTS is selected as pressure unit, the switchover pressure can be calculated by means of the following formula (PV is the abbreviation of Process Value):

$$PV_{\text{mbar}} = 10^{(6 \times \text{COUNTS} / 4000) - 42.5}$$

The following settings can be made with the five possible switch positions.

Switch position	Switchover pressure	COUNTS
0; 1	1 mbar	28 333
2; 3	$5 \times 10^{-1}$ mbar	32 632
4; 5	$2 \times 10^{-1}$ mbar	27 867
6; 7	$1 \times 10^{-1}$ mbar	27 666
8; 9	$5 \times 10^{-2}$ mbar	27 466

### 3.1.1.14 Sensor Calibration Switch ID 203 (HPG400-SP Only)

This parameter represents the setting of the calibration switch "CAL ADJ", which is used for adjusting the sensitivity of the gauge (→  [4], [6]).

The value output corresponds to the marking on the switch.



The following parameters (ID 204 ... ID 209) present copies of elements of the Exception Detail Alarm (ID 27) or the Exception Detail Warning (ID 28). These parameters are made available in order to allow masters that do not support the Profibus DPV1 to access the elements of the Exception Detail Alarm and Warning via the parameter channel. Since the parameter channel has a limited actual data length (4 bytes), the attributes ID 27 and ID 28 cannot be read via the parameter channel.

### 3.1.1.15 Copy Common Exception Detail Alarm 0 ID 204

This parameter corresponds to the Common Exception Detail Alarm of the Exception Detail Alarm (ID 27).

### 3.1.1.16 Copy Device Exception Detail Alarm 0 ... 3 ID 205

This parameter corresponds to the Device Exception Detail Alarm of the Exception Detail Alarm (ID 27).

### 3.1.1.17 Copy Manufacturer Exception Detail Alarm 0 ID 206

This parameter corresponds to the Manufacturer Exception Detail Alarm of the Exception Detail Alarm (ID 27).

### 3.1.1.18 Copy Common Exception Detail Warning 0 ID 207

This parameter corresponds to the Common Exception Detail Warning of the Exception Detail Warning (ID 28).

### 3.1.1.19 Copy Device Exception Detail Warning 1 ... 4 ID 208

This parameter corresponds to the Device Exception Detail Warning of the Exception Detail Warning (ID 28).

### 3.1.1.20 Copy Manufacturer Exception Detail Warning 0 ID 209

This parameter corresponds to the Manufacturer Exception Detail Warning of the Exception Detail Warning (ID 28).

### 3.1.2 Device Block, Device Behavior

The BPG400-SP / HPG400-SP behaves as described in the status diagram below.

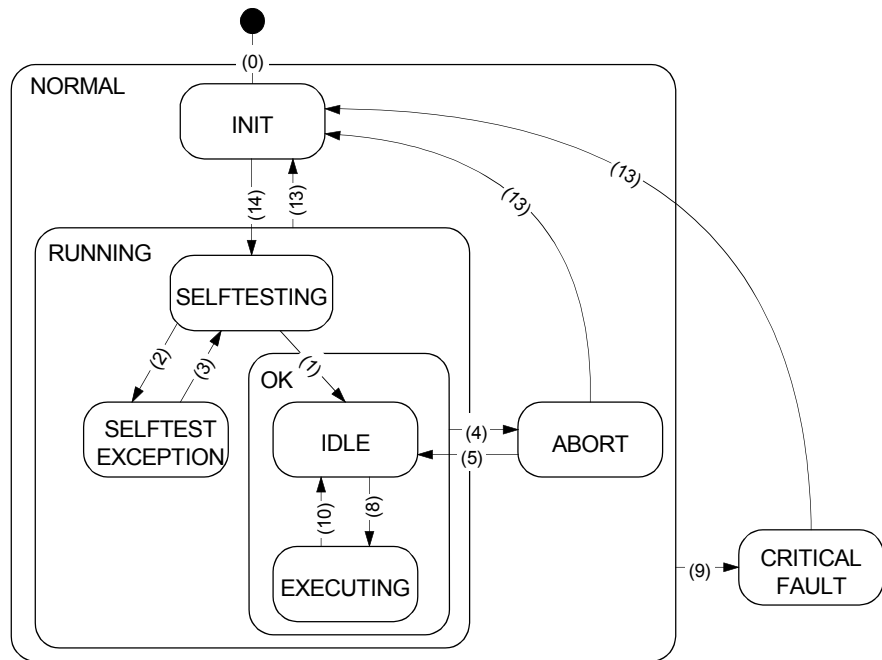

After the start, the gauge independently runs through the INIT and SELFTESTING status and eventually changes to the IDLE status (if there is no error) or to the SELFTEST\_EXCEPTION status (if there is a gauge error).

When data traffic is taken up, a difference has to be made between cyclic and acyclic data traffic.

Cyclic data traffic

As soon as cyclic data interchange is taken up, the gauge automatically changes to the EXECUTING status.

Acyclic data traffic

In acyclic data traffic, a START service has to be transmitted to bring the gauge to the EXECUTING status.

## Device statuses

Status name	Description
NORMAL	The communication interface can respond to commands. All defined blocks of the gauge exist.
RUNNING	All block instances are initialized and the individual parameters have their initial or default values.
SELFTESTING	In this status, the gauge performs a selftest.
IDLE	All blocks defined in the gauge are initialized and the complete hardware has been tested and found free of errors. The value defined in the Safe State is output as measured value.
SELFTESTEXCEPTION	During the self test, an error has been detected. The gauge has changed to the SELFTESTEXCEPTION status. The cause of the error can be found in the attributes Device Exception Detail Alarm/Warning of the Device Block. The value defined in the Safe State is output as measured value.
EXECUTING	The gauge functions normally and outputs the measured value.
ABORT	The Device Block is in the ABORT status. The gauge specific measurement functions are not carried out.
CRITICALFAULT	A device error has occurred. The gauge specific measurement functions are not carried out. The value defined in the Safe State is output as measured value.

### 3.1.2.1 Device Block State Command

There are a number of special commands for bringing the gauge into a status it does not automatically go to.

ID	Name	Structure	Data type	Bytes	Access	Store	Range
15	Device Block State Command	Simple	Unsigned8	1	1_R/W 2_R/W	N	→ below

ID value	Name	Description
0	Inactive	No action.
1	Reset	Used for reinitializing the device.
2	Abort	Brings the device to the ABORT status.
3	Recover	Used for bringing the device from the ABORT status into the Recovered State $\hat{=}$ IDLE.
4	Execute	Brings the unit to the EXECUTING status, in which the gauge functions normally. As soon as cyclic data traffic is initialized, this status command is executed automatically.
5	Stop	Brings the gauge to the IDLE status.
6	Perform Diagnostic	Stops the running activity and starts SELFTEST.

## 3.2 Analog Input Block

All gauge functions of the BPG400-SP / HPG400-SP are described in the Analog Input Block.

Since the gauge includes two measuring systems, there are also two Analog Input Block Instances representing the Pirani measuring part and the ionization measuring part (BA/HP) respectively.

### 3.2.1 One Of N Analog Input Function Block / SLOT 1

ID	Name <sup>1)</sup>	Structure	Data type	Bytes	Access	Store
15	AI Block Adjust Command	Simple	Unsigned8	1	1/2_W	-
16	Block Type	Simple	Octet string	4	2_R	N
46	Channel Instance Selector	Simple	Unsigned8	1	1/2_R/W	N
47	PV Selector	Simple	Unsigned8	1	0_XI 1/2_R	D

<sup>1)</sup> The above parameters are described below.

#### 3.2.1.1 AI Block Adjust Command (Adjustment at Atmospheric Pressure)

This service is used for adjusting the gauge at atmospheric pressure (→ [1], [3] for BPG400-SP and [4], [6] for HPG400-SP). For this purpose, the value "1" has to be transmitted.

#### 3.2.1.2 Block Type

The value of the Block Type ID is "3" (→ table in Appendix A).

#### 3.2.1.3 Channel Instance Selector

The gauge has two instances of the Analog Input Function Block and two instances of the Vacuum Gauge Transducer Block, or one instance of each block per measuring systems (Pirani and BA/HP). There are two additional instances for describing the switching functions (→ section "Analog Sensor Input Function Block", Instances 3 and 4).

However, there is only one address range for both, querying and setting the corresponding parameters. The Parameter Channel Instance Selector is used for defining the parameters that are written into the address range.

If the Parameter Channel Instance Selector is set to "1", the attributes of Instance 1 are mapped into that address range and can be written or read by addressing Slot → Instance → Parameter-ID.

#### 3.2.1.4 PV Selector

The PV Selector is determined by the gauge and defines the Analog Input Function Block Instance from which the measured value is copied into the cyclic output data telegrams. Therefore, the value output in the cyclic data is always the measured value of the active instance, i.e. the one that is currently measuring. While the gauge is measuring in the BA/HP range, the measured value of the ionization vacuum meter is output in the cyclic data and while the gauge is measuring in the Pirani range, the measured value of the Pirani is output.



The measured values of Instances 3 and 4 (thresholds of the switching functions) are not output in the cyclic data.

The pressure ranges, in which measurement is performed either by the Pirani measuring part or by the BA/HP measuring part, and which are thus called "active", are indicated below:

Measuring range  
BPG-400-SP

Pressure [mbar]	PV Selector
$5.5 \times 10^{-3} < p \leq \text{Overrange}$ <sup>1)</sup>	Pirani (=1)
$5 \times 10^{-10} < p < 5.5 \times 10^{-3}$	BA (=2)

<sup>1)</sup> Overrange means pressure values >1000 mbar.

Measuring range  
HPG-400-SP



The activation value of the emission of the HPG400-SP can be defined via a switch on the gauge (→ [4], [6]). The selected value is called "p\_active\_threshold". The activation value of the emission can be read with the parameter ID 202 "Emission Switch ON Switch" in the Device Block.

Pressure [mbar]	PV Selector
$p\_active\_threshold < p < \text{Overrange}$ <sup>1)</sup>	Pirani (=1)
$\text{Underrange} \leq p < p\_active\_threshold$	HP (=2)

<sup>1)</sup> Overrange means pressure values >1000 mbar.



### 3.2.2 Analog Sensor Input Function Block Instance 1 / SLOT 1

Instance 1 of the Analog Sensor Input Function Blocks describes the functionality of the Pirani measuring part of the gauge.

The following attributes are supported:

ID	Name	Structure	Data type	Bytes	Access	Store
19	Process Value (PV)	Simple	According to Parameter Data Type	-	0_XI 1_R 2_R	D
20	Status	Simple	Unsigned8	1	0_XI 1/2_R	D
21	Data Type	Simple	Unsigned8	1	2_R/W	N
22	Data Units	Simple	Unsigned16	2	2_R/W	N
23	Reading Valid	Simple	Boolean	1	1_R 2_R	D
24	Full Scale	Simple	According to Data Type value (Parameter 21)	-	1/2_R	N
39	Safe State	Simple	Unsigned8	1	1/2_R/W	N
40	Safe Value	Simple	According to Data Type value (Parameter 21)	-	1/2_R/W	N
44	Overrange	Simple	According to Data Type value (Parameter 21)	-	1/2_R	N
45	Underrange	Simple	According to Data Type value (Parameter 21)	-	1/2_R	N

#### 3.2.2.1 Process Value

The Process Value contains the measured value of the Pirani Device Instance in the currently selected data unit (ID 22) and in the selected data type (ID 21).

If the device is not in the Executing Status (ID 25, Device Block), the value defined in the Safe State is output.

Values output in the data unit COUNTS can be converted into a pressure value by means of the following formulas:

BPG400-SP

Calculation of the pressure (PV is the abbreviation used for Process Value):

$$PV_{\text{mbar}} = 10^{(\text{COUNTS} / 1000) - 12.5}$$

$$PV_{\text{Torr}} = 0.75006168 \times PV_{\text{mbar}}$$

$$PV_{\text{Micron}} = 10^{-3} \times PV_{\text{Torr}}$$

$$PV_{\text{Pa}} = 100 \times PV_{\text{mbar}}$$

HPG400-SP

Calculation of the pressure (PV is the abbreviation used for Process Value):

$$PV_{\text{mbar}} = 10^{(6 \times \text{COUNTS} / 4000) - 42.5}$$

$$PV_{\text{Torr}} = 0.75006168 \times PV_{\text{mbar}}$$

$$PV_{\text{Micron}} = 10^{-3} \times PV_{\text{Torr}}$$

$$PV_{\text{Pa}} = 100 \times PV_{\text{mbar}}$$

#### 3.2.2.2 Status

This parameter remains on "0".

### 3.2.2.3 Data Type

Two data types are supported: Float and Integer16.

In cyclic data exchange, the data type cannot be modified. The data type setting can only be modified when the gauge is in the IDLE status. By defining the configuration data for cyclic data exchange (selection of standard telegrams), the data type used in the selected standard telegram is taken over. All settings previously made in acyclic data traffic are thus overwritten.

If the data type is set in one instance, that data type setting applies to all instances. Likewise, when a standard telegram is selected, the data type used by that standard telegram will be valid for all instances.

Coding	Data type
3	Integer16
8	Float

### 3.2.2.4 Data Unit

The gauge supports the following pressure units:

Coding	Data type
1001	COUNTS
1301	Torr
1302	mTorr (Micron)
1308	mbar
1309	Pascal



For safety reasons, it is not possible to change the pressure unit while the gauge is cyclically interchanging data with a DP/V0 master.

The data unit setting can only be modified when the gauge is in the IDLE status.

In cyclic data traffic, the data unit must be set in the User Parameter Data. All settings previously made in acyclic data traffic are overwritten (→ section "User Parameter Data").

If the data unit is set in one instance, that data unit setting applies to all instances. Likewise, the data unit setting made in the User Parameter Data is valid for all instances.

### 3.2.2.5 Reading Valid

This parameter indicates that the pressure reading is within a valid range, which means that:

- The gauge is in the EXECUTING status.
- There is no error (ID 26, 27 or 28 of the Device Block)
- The measured value is lower than the overrange value and higher than the underrange value.



If this value is set to zero, the pressure reading is not valid. In such a case, either check Exception Status (ID 26, Device Block) to find out whether there is an error or check One Of N Status Extension (ID 120, One Of N Vacuum Gauge Transducer Block) to find out whether the measured value is out of the specified measuring range (overrange or underrange mode).

### 3.2.2.6 Full Scale

BGP400-SP

This parameter contains the valid maximum value of the pressure reading (1000 mbar) in the currently selected data unit and data type.

Pressure unit	Full scale
COUNTS	31 000
Torr	750.06168
mTorr (Micron)	750 061.68
mbar	1 000
Pascal	100 000

HGP400-SP

Pressure unit	Full scale
COUNTS	30 333
Torr	750.06168
mTorr (Micron)	750 061.68
mbar	1 000
Pascal	100 000

### 3.2.2.7 Safe State

When the gauge is not in the EXECUTING status (ID 25, Device Block) or if there is a device error, a value defined by Safe State is output as pressure value. You can select among:

- "0"
- Full scale
- Last valid value
- Safe Value (user-definable in ID 40)

Safe State	Coding	PV behavior
Zero	0	The Process Value (measured value ID 19) is set to 0.
Full Scale	1	The Process Value (measured value ID 19) is set to the full scale value (ID 24).
Hold Last Value	2	The Process Value is set to the last valid value obtained in the EXECUTING status.
Use Safe Value	3	The Process Value (measured value ID 19) is set to the Safe Value (ID 40).

### 3.2.2.8 Safe Value

The Safe Value is the value output with the Process Value parameter (ID 19) when an error occurs or the gauge goes to the NOT EXECUTING status. If this value is set to zero, it will remain on zero when the data unit is changed.

### 3.2.2.9 Overrange

Overrange is the highest valid measured value at which Reading Valid is still on "1".

BGP400-SP

Pressure unit	Overrange
COUNTS	31 000
Torr	750.06168
mTorr (Micron)	750 061.68
mbar	1 000
Pascal	100 000

HGP400-SP

Pressure unit	Overrange
COUNTS	30 333
Torr	750.06168
mTorr (Micron)	750 061.68
mbar	1 000
Pascal	100 000

### 3.2.2.10 Underrange

Underrange is the lowest valid measured value at which Reading Valid is still on "1".

BGP400-SP

Pressure unit	Underrange
COUNTS	20 480.7254
Torr	$4.12534 \times 10^{-3}$
mTorr (Micron)	4.12534
mbar	$5.5 \times 10^{-3}$
Pascal	0.55

HGP400-SP

Pressure unit	Underrange
COUNTS	27 000
Torr	$7.50053 \times 10^{-3}$
mTorr (Micron)	7.50053
mbar	$1.0 \times 10^{-2}$
Pascal	1

### 3.2.3 Analog Sensor Input Function Block Instance 2 / SLOT 1

Instance 2 of the Analog Sensor Input Function Block describes the functionality of the BA/HP measuring part of the gauge.

In Instance 2, the same attributes as in Instance 1 are supported:

ID	Name	Structure	Data type	Bytes	Access	Store
19	Process Value (PV)	Simple	According to Parameter Data Type	-	0_XI 1_R 2_R	D
20	Status	Simple	Unsigned8	1	0_XI 1/2_R	D
21	Data Type	Simple	Unsigned8	1	2_R/W	N
22	Data Units	Simple	Unsigned16	2	2_R/W	N
23	Reading Valid	Simple	Boolean	1	1_R 2_R	D
24	Full Scale	Simple	According to Data Type value (parameter 21)	-	1/2_R	N
39	Safe State	Simple	Unsigned8	1	1/2_R/W	N
40	Safe Value	Simple	According to Data Type value (parameter 21)	-	1/2_R/W	N
44	Ovrange	Simple	According to Data Type value (parameter 21)	-	1/2_R	N
45	Underrange	Simple	According to Data Type value (parameter 21)	-	1/2_R	N

#### 3.2.3.1 Process Value

The Process Value contains the measured value of the BA/HP Device Instance in the currently selected data unit (ID 22) and in the selected data type (ID 21).

If the device is not in the EXECUTING status (ID 25, Device Block), the value defined in the Safe State is output.

Values output in the data unit COUNTS can be converted into a pressure value by means of the following formulas:

### BPG400-SP

Calculation of the pressure (PV is the abbreviation used for Process Value):

$$PV_{\text{mbar}} = 10^{(\text{COUNTS} / 2000) - 12.5}$$

$$PV_{\text{Torr}} = 0.75006168 \times PV_{\text{mbar}}$$

$$PV_{\text{Micron}} = 10^{-3} \times PV_{\text{Torr}}$$

$$PV_{\text{Pa}} = 100 \times PV_{\text{mbar}}$$

### HPG400-SP

Calculation of the pressure (PV is the abbreviation used for Process Value):

$$PV_{\text{mbar}} = 10^{(6 \times \text{COUNTS} / 16000) - 9.125}$$

$$PV_{\text{Torr}} = 0.75006168 \times PV_{\text{mbar}}$$

$$PV_{\text{Micron}} = 10^{-3} \times PV_{\text{Torr}}$$

$$PV_{\text{Pa}} = 100 \times PV_{\text{mbar}}$$

#### 3.2.3.2 Status

This parameter is remains on "0".

#### 3.2.3.3 Data Type

Two data types are supported: Float and Integer16.

In cyclic data traffic, the data type cannot be modified. The data type setting can only be modified when the gauge is in the IDLE status. By defining the configuration data for cyclic data traffic (selection of standard telegram), the data type used in the selected standard telegram is taken over. All settings previously made in acyclic data traffic are thus overwritten.

If the data type is set in one instance, that data type setting applies to all instances. Likewise, when a standard telegram is selected, the data type used by that standard telegram will be valid for all instances

Coding	Data type
3	Integer16
8	Float

#### 3.2.3.4 Data Unit

The gauge supports the following pressure units:

Coding	Pressure unit
1001	COUNTS
1301	Torr
1302	mTorr (Micron)
1308	mbar
1309	Pascal



For safety reasons, it is not possible to change the pressure unit while the gauge is cyclically interchanging data with a DP/V0 master.

The data unit setting can only be modified when the gauge is in the IDLE status.

In cyclic data traffic, the data unit must be set in the User Parameter Data. All settings previously made in acyclic data traffic are overwritten (→ section "User Parameter Data").

If the data unit is set in one instance, that data unit setting applies to all instances. Likewise, the data unit setting made in the User Parameter Data is valid for all instances.

### 3.2.3.5 Reading Valid

This parameter indicates that the pressure reading is within a valid range, which means that:

- The gauge is in the EXECUTING status.
- There is no error (ID 26, 27 or 28 of the Device Block)
- The measured value is lower than the overrange value and higher than the underrange value.



If this value is set to zero, the pressure reading is not valid. In such a case, either check Exception Status (ID 26, Device Block) to find out whether there is an error or check One Of N Status Extension (ID 120, One Of N Vacuum Gauge Transducer Block) to find out whether the measured value is out of the specified measuring range (overrange or underrange mode).

### 3.2.3.6 Full Scale

This parameter contains the valid maximum value of the pressure reading (1000 mbar) in the currently selected data unit and data type.

BGP400-SP

Pressure unit	Full scale
COUNTS	21 602.06
Torr	$1.50 \times 10^{-2}$
mTorr (Micron)	1.5
mbar	$2.0 \times 10^{-2}$
Pascal	2

HGP400-SP

Pressure unit	Full scale
COUNTS	24 333
Torr	$7.5006168 \times 10^{-1}$
mTorr (Micron)	$7.5006168 \times 10^2$
mbar	1
Pascal	100

### 3.2.3.7 Safe State

When the gauge is not in the EXECUTING status (ID 25, Device Block) or if there is a device error, a value defined by Safe State is output as pressure value. You can select among:

- "0"
- Full scale
- Last valid value
- Safe Value (user-definable in ID 40)

Safe State	Coding	PV behavior
Zero	0	The Process Value (measured value ID 19) is set to 0.
Full Scale	1	The Process Value (measured value ID 19) is set to the full scale value (ID 24).
Hold Last Value	2	The Process Value is set to the last valid value obtained in the EXECUTING status.
Use Safe Value	3	The Process Value (measured value ID 19) is set to the Safe Value (ID 40).

### 3.2.3.8 Safe Value

The Safe Value is the value output with the Process Value Parameter (ID 19) when an error occurs or the gauge goes to the NOT EXECUTING status. If this value is set to zero, it will remain on zero when the data unit is changed.

### 3.2.3.9 Overrange

Overrange is the highest valid measured value at which Reading Valid is still on "1".

BGP400-SP

Pressure unit	Overrange
COUNTS	21 602.06
Torr	$1.5 \times 10^{-2}$
mTorr (Micron)	1.5
mbar	$2 \times 10^{-2}$
Pascal	2.0

HGP400-SP

Pressure unit	Overrange
COUNTS	24 333
Torr	$7.5006168 \times 10^{-1}$
mTorr (Micron)	$7.5006168 \times 10^2$
mbar	1
Pascal	100

### 3.2.3.10 Underrange

Underrange is the lowest valid measured value at which Reading Valid is still on "1".

BGP400-SP

Pressure unit	Underrange
COUNTS	6397.95
Torr	$3.7503 \times 10^{-10}$
mTorr (Micron)	$3.7503 \times 10^{-7}$
mbar	$5.0 \times 10^{-10}$
Pascal	$5.0 \times 10^{-8}$

HGP400-SP

Pressure unit	Underrange
COUNTS	8333
Torr	$7.5006168 \times 10^{-7}$
mTorr (Micron)	$7.5006168 \times 10^{-4}$
mbar	$1 \times 10^{-6}$
Pascal	$1 \times 10^{-4}$

### 3.2.4 Analog Sensor Input Function Block Instances 3 and 4 / SLOT 1

Instances 3 and 4 of the Analog Sensor Input Function Block describe the functionality of the two switching functions (Setpoint A / Setpoint B) of the gauge (setting the switching functions → [2], [3] for BPG400-SP and [5], [6] for HPG400-SP):

Instance	Setpoint
3	A
4	B

With Process Values (ID 19), the current threshold setting (made by means of the potentiometers) is read; with Status, the relay status (open/closed) can be read.

ID	Name	Structure	Data type	Bytes	Access	Store
19	Process Value (PV)	Simple	Unsigned16	-	1_R 2_R	D
20	Status	Simple	Unsigned8	1	1_R 2_R	D
21	Data Type	Simple	Unsigned8	1	2_R 2_W	N
22	Data Units	Simple	Unsigned16	2	2_R 2_W	N
23	Reading Valid	Simple	Boolean	1	1_R 2_R	D

#### 3.2.4.1 Process Value

The Process Value contains the current setting of the threshold potentiometers for "Setpoint A" and "Setpoint B" in the currently selected data unit and data type.

If the pressure drops below the set threshold, the relay is closed. If after that, the pressure rises above that threshold with a hysteresis of 10%, the relay is opened again (→ [2], [3] for BPG400-SP and [5], [6] for HPG400-SP).

The Process Value PV is output in the currently selected data unit and data type.

Values output in the pressure unit COUNTS can be converted into a pressure value by means of the following formulas:

BPG400-SP

$$p_{\text{mbar}} = 10^{(\text{COUNTS} / 2000) - 12.5}$$

HPG400-SP

$$p_{\text{mbar}} = 10^{(\text{COUNTS} - 22\,999) / 2444}$$

The threshold voltages of the Setpoint potentiometer converted into a pressure value by means of the following formulas:

BPG400-SP

$$p_{\text{mbar}} = 10^{(1.23011 \times U) - 9.30102999}$$

HPG400-SP

$$p_{\text{mbar}} = 10^{(9 \times U / 10) - 6}$$

Where: U is the threshold voltage [V] of the corresponding Setpoint (A, B), measured at the D-Sub connector (sensor cable connector) of the gauge (→ [2], [3] for BPG400-SP and [5], [6] for HPG400-SP).



The switching functions work only at pressures <100 mbar. If a higher threshold has been selected, the relay is only activated at pressures lower than 100 mbar.



### 3.2.4.2 Status

If the pressure drops below the set threshold, the relay is activated (normally open contact closed). If the pressure then rises above the set threshold with a hysteresis of 10%, the relay is deactivated again (normally open contact open).

Bit	Definition
0	0
1	Low Alarm Exception: 0 = cleared; 1 = set
2	0
3	Low Warning Exception: 0 = cleared; 1 = set
4	0
5	0
6	0
7	0

### 3.2.4.3 Data Type

Description → Instance 1.

### 3.2.4.4 Data Unit

Description → Instance 1.

### 3.2.4.5 Reading Valid

This parameter is always on "1".

## 3.3 Transducer Block

### 3.3.1 One Of N Vacuum Gauge Transducer Block / SLOT 1

ID	Name	Structure	Data type	Bytes	Access	Store
120	One Of N Status Extension	Simple	UINT8	1	1_R 2_R	V

#### 3.3.1.1 One Of N Status Extension

This parameter indicates whether the overrange or underrange of the gauge is exceeded.

Bit7	Bit6	Bit5	Bit4	Bit3	Bit2	Bit1	Bit0
0	0	0	0	0	Underrange Exceeded	Overrange Exceeded	Reading Invalid

If the gauge is operated in its overrange or underrange, the corresponding bit and additionally the bit "Reading Invalid" is set.

If an error occurs, the bit "Reading Invalid" as well as the corresponding error bits in Device Block (ID 26, 27, 28 Device Block) are set.

### 3.3.2 Heat Transfer Vacuum Gauge Transducer Block / SLOT 1

ID	Name	Structure	Data type	Bytes	Access	Store
101	Block Type	Simple	Octet string	4	2_R	
102	Status Extension	Simple	UINT8	1	1/2_R	V
103	Sensor Alarm	Struct	Array of 2 bytes	2	1/2_R	V
104	Sensor Warning	Struct	Array of 2 bytes	2	1/2_R	V
140	Full Scale State	Simple	UINT8	1	1/2_R	V

#### 3.3.2.1 Block Type

According to the table in Appendix A, the Block Type ID has the value "13".

### 3.3.2.2 Status Extension

This parameter indicates whether the overrange or underrange of the Heat Transfer Vacuum Gauge device instance is exceeded.

Bit7	Bit6	Bit5	Bit4	Bit3	Bit2	Bit1	Bit0
0	0	0	0	0	Underrange Exceeded	Overrange Exceeded	Reading Invalid

If the instance is operated in its overrange or underrange, the corresponding bit and additionally the bit "Reading Invalid" is set.

If an error occurs, the bit "Reading Invalid" as well as the corresponding error bits in Device Block (ID 26, 27, 28 Device Block) are set.

### 3.3.2.3 Sensor Alarm

This parameter indicates the detectable errors occurring in connection with the Pirani measuring part. The present implementation allows detection of one error.

	Bit7	Bit6	Bit5	Bit4	Bit3	Bit2	Bit1	Bit0
Byte 0	0	0	0	0	0	0	Reserved	0
Byte 1	0	0	0	0	0	0	Electronics Failure <sup>1)</sup>	0

<sup>1)</sup> Electronics Failure includes a sensor error.

The Sensor Alarm bits defined here are copied into the Device Block ID 27 in the "Device Exception Detail Alarm" range of the Pirani measuring part.

### 3.3.2.4 Sensor Warning

This parameter indicates the detectable warnings occurring in connection with the Pirani measuring part. The present implementation allows detection of one warning.

	Bit7	Bit6	Bit5	Bit4	Bit3	Bit2	Bit1	Bit0
Byte 0	0	0	0	0	0	0	Reserved	0
Byte 1	0	0	0	0	0	0	Electronics Warning <sup>1)</sup>	0

<sup>1)</sup> Electronics Warning indicates that the Pirani measuring part has to be adjusted (→  [1], [3] for BPG400-SP and [4], [6] for HPG400-SP).

The Sensor Warning bits defined here are copied into the Device Block ID 28 in the "Device Exception Detail Warning" range of the Pirani measuring part.

### 3.3.2.5 Full Scale State

This Parameter is set to "1" while the Full Scale adjustment is carried out (→  [1], [3] for BPG400-SP and [4], [6] for HPG400-SP).

### 3.3.3 Hot Cathode Ion Gauge Transducer Block / SLOT 1

ID	Name	Structure	Data type	Bytes	Access	Store	Initial Value
14	Hot Cathode Block State Command	Rec		1	1_W 2_W		FALSE
101	Block Type	Simple	Octet string	4	2_R		16
102	Status Extension	Simple	UINT8	1	1_R 2_R	V	0
103	Sensor Alarm	Struct	Array of 2 bytes	2	1_R 2_R	V	0
104	Sensor Warning	Struct	Array of 2 bytes	2	1_R 2_R	V	0
105	Emission Status	Simple	Boolean	1	1_R/W 2_R/W	V	0
106	Emission Current	Simple	FLOAT	4	1_R/W 2_R/W	NV	BPG400-SP only
109	Degas Status	Simple	Boolean	1	1_R 2_R	V	BPG400-SP only

#### 3.3.3.1 Block Type

According to the table in Appendix a, the Block Type ID has the value "16".

#### 3.3.3.2 Status Extension

This parameter indicates that the overrange or underrange of the Hot Cathode Ion Gauge instance is exceeded.

Bit7	Bit6	Bit5	Bit4	Bit3	Bit2	Bit1	Bit0
0	0	0	0	0	Underrange Exceeded	Overrange Exceeded	Reading Invalid

If the instance is operated in its overrange or underrange, the corresponding bit and additionally the bit "Reading Invalid" is set.

If an error occurs, the bit "Reading Invalid" as well as the corresponding error bits in Device Block (ID 26, 27, 28 Device Block) are set.

#### 3.3.3.3 Sensor Alarm

This parameter indicates the detectable errors occurring in connection with the BA/HP measuring part. The present implementation allows detection of one error.

	Bit7	Bit6	Bit5	Bit4	Bit3	Bit2	Bit1	Bit0
Byte 0	0	0	0	0	0	0	0	0
Byte 1	0	0	0	0	0	0	Electronics Failure <sup>1)</sup>	0

<sup>1)</sup> Electronics Failure includes a sensor error.

The Sensor Alarm bits defined here are copied into the Device Block ID 27 in the "Device Exception Detail Alarm" range of the BA measuring part.

#### 3.3.3.4 Sensor Warning

This parameter indicates the detectable warnings occurring in connection with the BA/HP measuring part. The present implementation allows detection of one warning.

	Bit7	Bit6	Bit5	Bit4	Bit3	Bit2	Bit1	Bit0
Byte 0	0	0	0	0	0	0	0	0
Byte 1	0	0	0	0	0	0	Electronics Warning	0

The Sensor Warning bits defined here are copied into the Device Block ID 28 in the "Device Exception Detail Warning" range of the BA/HP measuring part.

### 3.3.3.5 Emission Status

BPG400-SP

This parameter indicates the emission status of the gauge.

Emission status	Bit 1	Bit 0	Meaning
False	0	0	Emission Off
TRUE	0	1	Emission current low
TRUE	1	0	Emission current high
TRUE	1	1	Degas

HPG400-SP

Emission status	Bit 0	Meaning
FALSE	0	Emission Off
TRUE	1	Emission On

### 3.3.3.6 Emission Current (BPG400-SP Only)

This parameter indicates the value of the emission current in mA.

Emission current [mA]	Bit 1	Bit 0
0	0	0
0.025	0	1
5	1	0
20	1	1

### 3.3.3.7 Degas Status (BPG400-SP Only)

This parameter indicates whether the gauge is in Degas mode.

Degas Status	Bit 0	Bit 1	Meaning
FALSE	0	0	Degas Off
TRUE	1	1	Degas On

### 3.3.3.8 Hot Cathode Block State Command (BPG400-SP Only)

This service is used for activating the Degas mode via Profibus.

Byte	Name	Structure	Data type	Bytes	Access
0	State Command	Simple	Unsigned8	1	1/2_W
1	State Command Data Field... <sup>1)</sup>	Simple	Unsigned8	1	1/2_W

State Command	Name	Description
0	Inactive	No action
1	Set Degas State	Activates/deactivates the Degas mode  This service is used for activating/deactivating the Degas mode ( $p < 7.2 \times 10^{-6}$ mbar). If the Degas mode has not been deactivated with Degas Off before, it is automatically turned off after 3 minutes.

<sup>1)</sup> The State Command Data Field can have the following values:  
0  $\hat{=}$  Degas Off  
1  $\hat{=}$  Degas On

## Appendix A: Definitions

### Data types

Abbreviation	Range	Data type
INT8	$-2^7 \dots (2^7 - 1)$	Integer 1 byte
INT16	$-2^{15} \dots (2^{15} - 1)$	Integer 2 byte
INT32	$-2^{31} \dots (2^{31} - 1)$	Integer 4 byte
UINT8	$0 \dots (2^8 - 1)$	Unsigned integer 1 byte
UINT16	$0 \dots (2^{16} - 1)$	Unsigned integer 2 byte
UINT32	$0 \dots (2^{31} - 1)$	Unsigned integer 4 byte
FLOAT	$\pm 3.402 \times 10^{38}$	Floating Point, IEEE 754 Short Real Number, 4 byte
VSTRING(n)		ISO 646 and ISO 2375
OSTRING(n)		Octet string

### Definitions

Term	Meaning
Byte	Number of bytes used by a data structure (integer value)
Store	This parameter defines whether the values are stored in non-volatile memory ( $\rightarrow$ store characteristics)
Default	Manufacturer-defined value

### Store characteristics

Abbreviation	Meaning
V	"Volatile": Value is not saved to the RAM or EEPROM and is lost in the event of a power failure
N	"Nonvolatile": Value is saved to the RAM or EEPROM and is not lost in the event of a power failure

### Data access

Abbreviation	Meaning
1_R/W	Acyclically readable and writeable by a Master Class 1
2_R/W	Acyclically readable and writeable by a Master Class 2
1/2_R/W	Acyclically readable and writeable by a Master Class 1 and 2
1_R	Acyclically readable by a master Class 1
2_R	Acyclically readable by a master Class 2
1/2_R	Acyclically readable by a master Class 1 and 2
1_W	Acyclically writeable by a master Class 1
2_W	Acyclically writeable by a master Class 2
1/2_W	Acyclically writeable by a master Class 1 and 2
0_XI	Cyclic output data with master Class 1

## Definitions from the Profibus standard

The following table explains terms used in connection with the Profibus.

Term	Meaning
Alert Elements	Alert Elements are used to communicate notification messages from slave to master when warnings, alarms or events are detected.
Application	A <i>software functional unit</i> consisting of an interconnected aggregation of <i>function blocks, events and objects</i> , which may be distributed and which may have <i>interfaces</i> with other <i>applications</i> .
Characteristic	An characteristic is a property or characteristic of an <i>entity</i> . (Au) In block applications a block interface is defined by input/output parameters. These parameters have characteristics called parameter characteristics. Examples are access rights and identification names. (IT) The UML defines characteristics as a feature within a classifier that describes a range of values that instances of the classifier may hold. It is a property of a class instance (object).
Block (Block Instance)	A logical processing unit of software comprising an individual, named copy of the block and associated parameters specified by a block type, which persists from one invocation of the block to the next. Concept similar to the class/object approach, but well suited to the automation requirements.
Class	(IT) A class represents a template for several objects and describes how these objects are structured internally. Objects of the same class have the same definition both for their operations and for their information structures.
Configuration (of a system/device)	A step in system design: selecting functional units, assigning their locations and identifiers and defining their interconnections.
Data Structure	An <i>aggregate</i> whose elements need not be of the same <i>data type</i> , and each of them is uniquely referenced by an <i>offset identifier</i> .
Data Type	A data item with certain characteristics and permissible operations on that data, e.g. INT8.
Device	A physical entity capable of performing one or more specified functions in a particular context and delimited by its interfaces.
Direction of Data	<i>Input data</i> are transmitted from the device to the bus. <i>Output data</i> are transmitted from the bus to the device.
Direction of Flow	A positive set point causes a flow from P to A.
Entity	A particular thing, such as a person, place, <i>process</i> , object, concept, association or <i>event</i> .
Function	(1) A specific purpose of an entity. (2) One of a group of actions performed by an entity.
Function Block	A named <i>block</i> consisting of one or more input, output and contained parameters. Function blocks represent the basic automation functions performed by an application which is as independent as possible from the specifics of I/O devices and the network. Each function block processes input parameters according to a specified algorithm and an internal set of contained parameters. They produce output parameters that are available for use within the same function block application or by other function block applications.

Definitions from the Profibus standard (cont.)

Term	Meaning
Function Block Application	Application of an automation system performed by a Device Block, Function Block, Transducer Block and accompanied elements.
Instance	A set of data related to an invocation of a function block or a class.
Internal Resolution (ir)	The internal resolution is 16383 (3FFF <sub>hex</sub> ) for 100% and -16384 (C000 <sub>hex</sub> ) for -100% of the range.
Mode	Determines the block operating mode and available modes for a block instance.
Object	(IT) A software entity having identity, attributes and behavior.
Parameter	A <i>variable</i> that is given a constant value for a specified <i>application</i> and that may denote the <i>application</i> .
Device Block	A Device Block is a named block. Hardware specific parameters of a field device, which are associated with a resource, are made visible through the Device Block. Similar to transducer blocks, they insulate function blocks from the physical hardware by a set of implementation independent hardware parameters.
Record	A set of <i>data items</i> of different data types treated as a unit.
Resource	A resource is considered to be a logical subdivision within the software (and possibly hardware) structure of a device. Resources have independent control of their operation. The definition of a resource may be modified without affecting other resources within a device. A resource accepts and processes data and/or events from the process and/or communication interfaces and returns data and/or events to the process and/or communication interfaces, as specified by the applications utilizing the resource. An interoperable network view of applications is provided through device resources. Each resource specifies the network visible aspects of one or more local applications (or parts of distributed applications).
Simple Variable	A single variable which is characterized by a defined Data Type.
Substitute Value	In case an optional parameter has not been implemented, the device behaves according to the substitute value for this parameter.
Transducer Block	Transducer Block is a named block. Transducer blocks insulate function blocks from the specifics of I/O devices, such as sensors, actuators, and switches. Transducer blocks control access to I/O devices through a device independent interface defined for use by function blocks. Transducer blocks also perform functions, such as calibration and linearization, on I/O data to convert it to a device independent representation. Their interface to function blocks is defined as one or more implementation independent I/O channels.
Variable	A <i>software</i> entity that may assume any one of a set of values. The values of a variable are usually restricted to a certain data type.

## Appendix B: Block Type

Currently defined Block Type IDs

Block Name	Block Type ID
Device Block	1
Sensor Analog Input Function Block	2
One of N Channel Sensor Analog Input Function Block	3
Multi Channel Sensor Analog Input Function Block	4
Discrete Input Function Block	5
Actuation Analog Output Function Block	6
Discrete Output Function Block	7
Analog Output Function Block	8
Single Stage Controller Function Block	9
Gas Calibration Transducer Block	10
Flow Transducer Block	11
Sensor Analog Input Ambient Temperature Transducer Block	12
Heat Transfer Vacuum Gauge... <sup>1)</sup>	13
Diaphragm Gauge	14
Cold Cathode Ion Gauge	15
Hot Cathode Ion Gauge <sup>2)</sup>	16
Trip Point Function Block	17
Reserved	18 ... $2^8 - 1$
Manufacturer-specific	$2^8 \dots 2^{16} - 1$

1) = Pirani measuring system

2) = BA/HP measuring system



## Appendix C: Electrical Connections

Technical data of gauges → [1],[2] [3] for BPG400-SP and [4], [5], [6] for HPG400-SP.

Sensor cable connection  
BPG400-SP, HPG400-SP

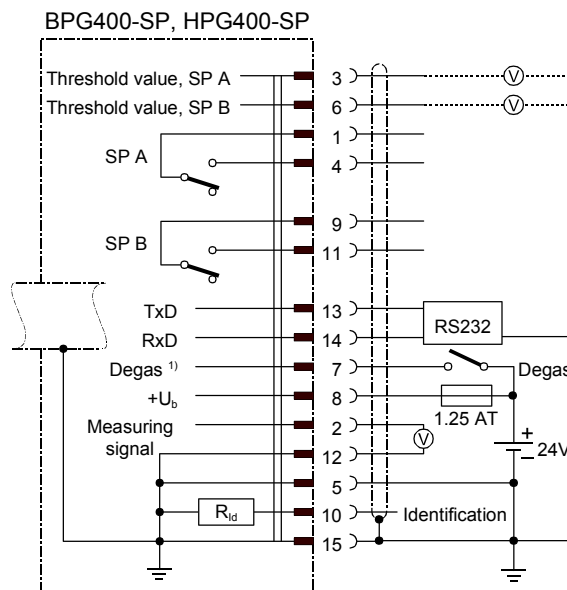

### Electrical connection

Pin 1	Relay Switching function A, common	
Pin 2	Signal output (measuring signal)	0 ... +10 V
Pin 3	Threshold value (Setpoint) A	0 ... +10 V
Pin 4	Relay Switching function A, normally open contact	
Pin 5	Supply common, GND	
Pin 6	Threshold value (Setpoint) B	0 ... +10 V
Pin 7	Degas on, active high <sup>1)</sup>	+24 V
Pin 8	Supply of electronics unit	+24 V
Pin 9	Relay Switching function B, Common	
Pin 10	Gauge identification:	
	BPG400-SP: $R_{id} = 42 \text{ k}\Omega$	
	HPG400-SP: $R_{id} = 56 \text{ k}\Omega$	
Pin 11	Relay Switching function B, normally open contact	
Pin 12	Signal common GND	
Pin 13	RS232, TxD	
Pin 14	RS232, RxD	
Pin 15	Shielding, housing GND	

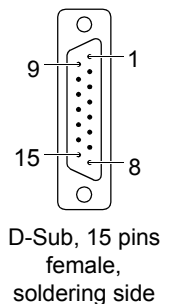

<sup>1)</sup> Degas function only for BPG400-SP; pin 7 is not connected in the HPG400-SP.

## Profibus connection

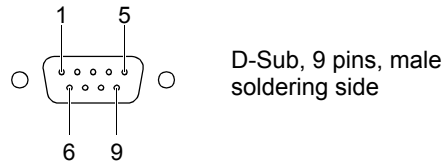

Pin 1 not connected

Pin 2 not connected

Pin 3 RxD/TxD-P

Pin 4 CNTR-P 1)

Pin 5 DGND 2)

Pin 6 VP 2)

Pin 7 not connected









Pin 8 RxD/TxD-N

Pin 9 not connected

1) Only to be connected if an *optical link* module is used.

2) Only required as line termination for devices at both ends of bus cable  
(→  [7], [8]).

## Appendix D: Literature

-  [1] [www.inficon.com](http://www.inficon.com)  
 Instruction Sheet  
 BPG400, BPG400-SP, BPG400-SD, BPG400-SR  
 tima03e1  
 INFICON AG, LI-9496 Balzers, Liechtenstein
-  [2] [www.inficon.com](http://www.inficon.com)  
 Instruction Sheet  
 BPG400-SP, BPG400-SD, BPG400-SR  
 tima36e1  
 INFICON AG, LI-9496 Balzers, Liechtenstein
-  [3] [www.inficon.com](http://www.inficon.com)  
 Operating Manual  
 BPG400, BPG400-SP, BPG400-SD, BPG400-SR  
 tina03e1  
 INFICON AG, LI-9496 Balzers, Liechtenstein
-  [4] [www.inficon.com](http://www.inficon.com)  
 Instruction Sheet  
 HPG400, HPG400-SP, HPG400-SD  
 tima31e1  
 INFICON AG, LI-9496 Balzers, Liechtenstein
-  [5] [www.inficon.com](http://www.inficon.com)  
 Instruction Sheet  
 HPG400-SP, HPG400-SD  
 tima32e1  
 INFICON AG, LI-9496 Balzers, Liechtenstein
-  [6] [www.inficon.com](http://www.inficon.com)  
 Operating Manual  
 HPG400, HPG400-SP, HPG400-SD  
 tina31e1  
 INFICON AG, LI-9496 Balzers, Liechtenstein
-  [7] [www.profibus.com](http://www.profibus.com)  
 (Profibus user organization)
-  [8] European Standard for Profibus EN 50170

Original: German tira36d1-a (0310)



tira36e1-a



*LI-9496 Balzers  
Liechtenstein  
Tel +423 / 388 3111  
Fax +423 / 388 3700  
reach.liechtenstein@inficon.com*

*www.inficon.com*