

# One-dimensional PSD



S3931

S3932

## 6 to 12 mm resistance length PSD for precision distance measurement

Hamamatsu provides various types of one-dimensional PSD (position sensitive detector) designed for precision distance measurement such as displacement meters. The S3931 and S3932 have a photosensitive area of 1 × 6 mm and 1 × 12 mm respectively, and are mounted on a compact ceramic package with a transparent resin window. Variant types (S3931-01, S3932-01) with a visible-cut resin window are also available.

### Features

- ➔ Superior position detection ability
- ➔ High reliability
- ➔ Easy to use 4-pin small ceramic package

### Applications

- ➔ Displacement sensing
- ➔ Distance measurement
- ➔ Proximity switching

### Structure / Absolute maximum ratings

Type no.	Package	Window material*1	Photosensitive area size (mm)	Absolute maximum ratings		
				Reverse voltage VR max (V)	Operating temperature*2 Topr (°C)	Storage temperature*2 Tstg (°C)
S3931	Ceramic	R	1 × 6	20	-10 to +60	-20 to +80
S3932		R	1 × 12			

\*1: R: resin coating

\*2: No dew condensation

When there is a temperature difference between a product and the surrounding area in high humidity environments, dew condensation may occur on the product surface. Dew condensation on the product may cause deterioration in characteristics and reliability.

Note: Exceeding the absolute maximum ratings even momentarily may cause a drop in product quality. Always be sure to use the product within the absolute maximum ratings.

### Electrical and optical characteristics (Typ. Ta=25 °C, unless otherwise noted)

Type no.	Spectral response range λ (nm)	Peak sensitivity wavelength λp (nm)	Photo sensitivity S λ=λp (A/W)	Interelectrode resistance Rie Vb=0.1 V			Position detection error*3 E VR=5 V light spot φ200 μm		Saturation photocurrent*4 VR=5 V RL=1 kΩ (μA)	Dark current ID VR=5 V		Temp. coefficient of ID TCID (times/°C)	Rise time tr VR=5 V RL=1 kΩ (μs)	Terminal capacitance Ct VR=5 V f=10 kHz (pF)	Position resolution*5 (μm)
				Min. (kΩ)	Typ. (kΩ)	Max. (kΩ)	Typ. (μm)	Max. (μm)		Typ. (nA)	Max. (nA)				
				S3931	320 to 1100	920	0.55	30		50	80				
S3932	±60	±240	0.2	20					3.0			80	0.3		

\*3: A range of 75% of that from the center of the photosensitive surface to the edge

\*4: The upper limit of linearity of photocurrent in response to the quantity of light is defined as the point where the linearity deviates by 10%.

\*5: Position resolution

This is the minimum detectable light spot displacement. The detection limit is indicated by the distance on the photosensitive surface. The numerical value of the resolution of a position sensor using a PSD is proportional to both the length of the PSD and the noise of the measuring system (resolution deteriorates) and inversely proportional to the photocurrent (incident energy) of the PSD (resolution improves).

- Light source: LED (900 nm)
- Light spot size: φ200 μm
- Frequency range: 1 kHz
- Photocurrent: 1 μA
- Circuit system input noise: 1 μV (1 kHz)
- Interelectrode resistance: Typical value (refer to the specification table)

**Spectral response**

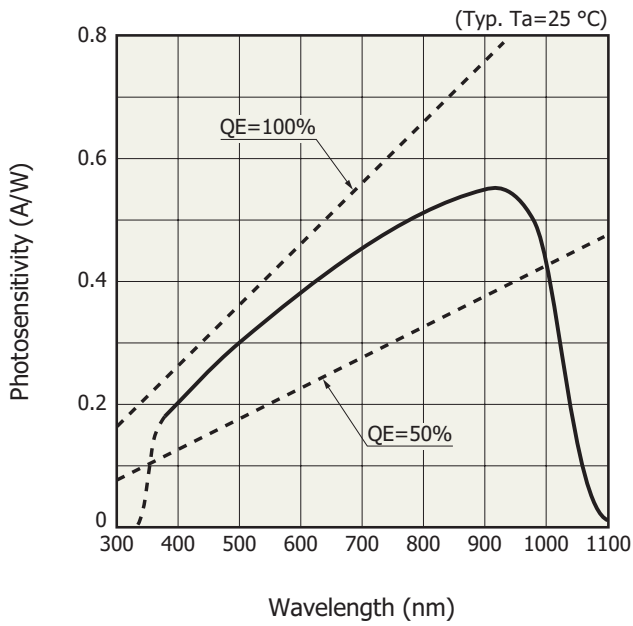

**Photosensitivity temperature characteristics**

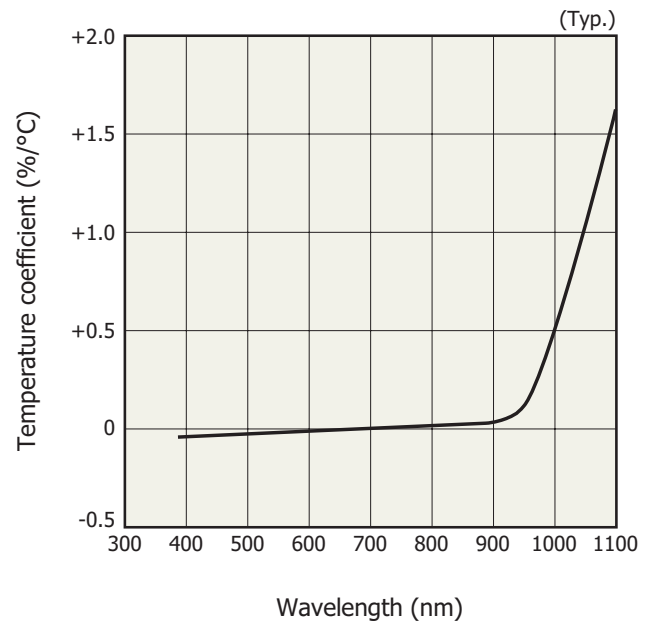

**Dark current vs. reverse voltage**

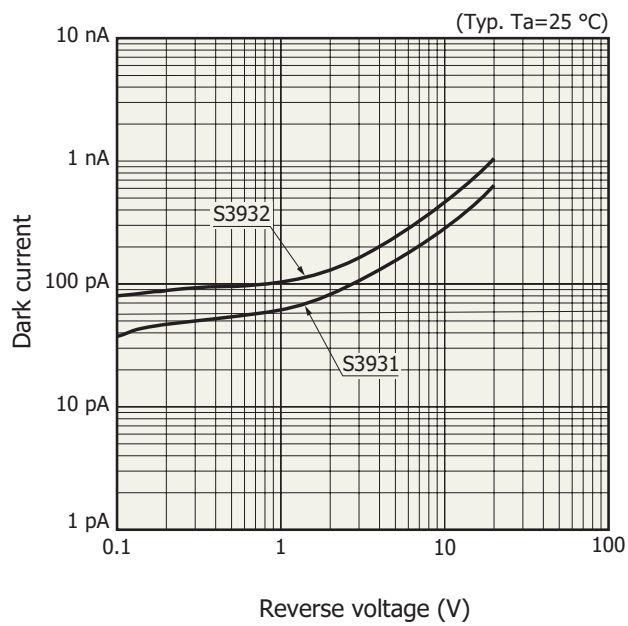

**Terminal capacitance vs. reverse voltage**

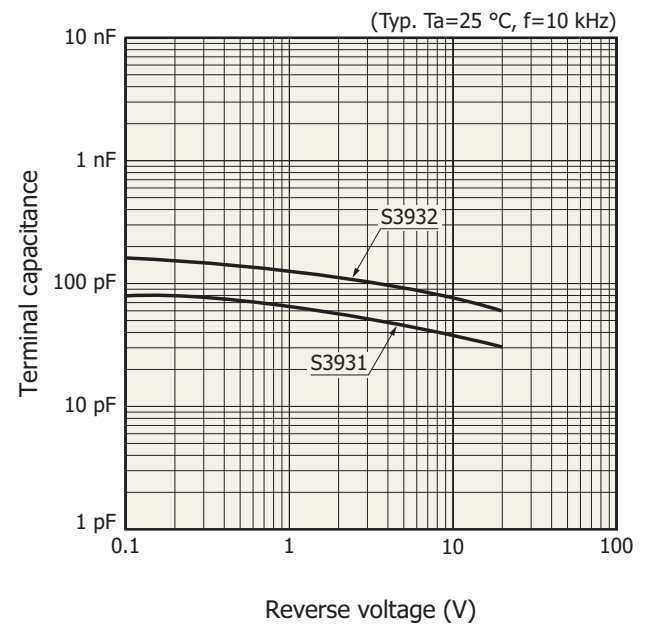

Examples of position detectability (Ta=25 °C, λ=900 nm, light spot size: φ0.2 mm)

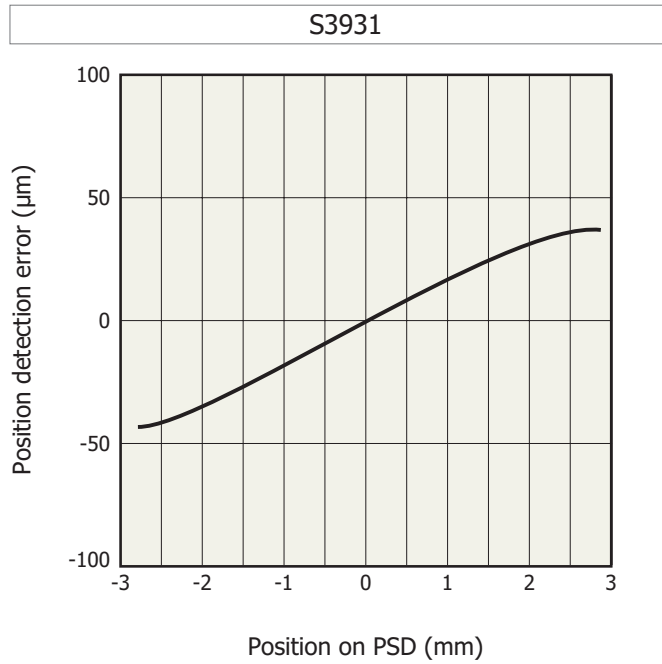

KPSDB0011ED

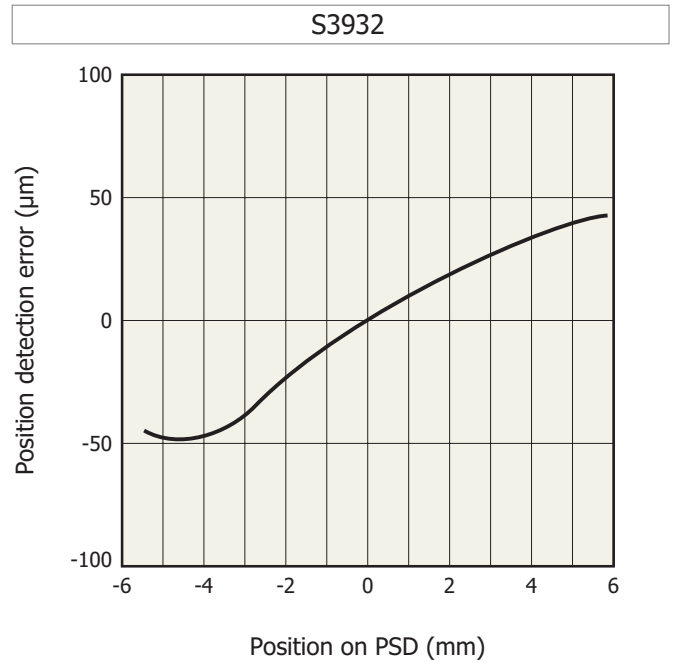

KPSDB0012ED

Conversion formula of spot light position on the PSD

If output signals (photocurrent) I<sub>1</sub> and I<sub>2</sub> are obtained from electrodes X<sub>1</sub> and X<sub>2</sub>, then the light spot position (x) on the PSD can be found by the following formula.

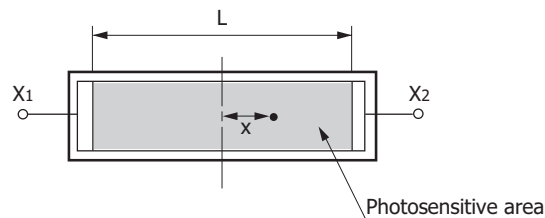

KPSDC0010EB

$$\frac{I_2 - I_1}{I_1 + I_2} = \frac{2x}{L}$$

Correction for position detection error

Position detection characteristics obtained by the above formula can be corrected to reduce position detection errors. For example, the maximum position detection error (±120 μm) of the S3931 can be significantly reduced to ±9 μm by using the least square method.

**Dimensional outlines (unit: mm)**

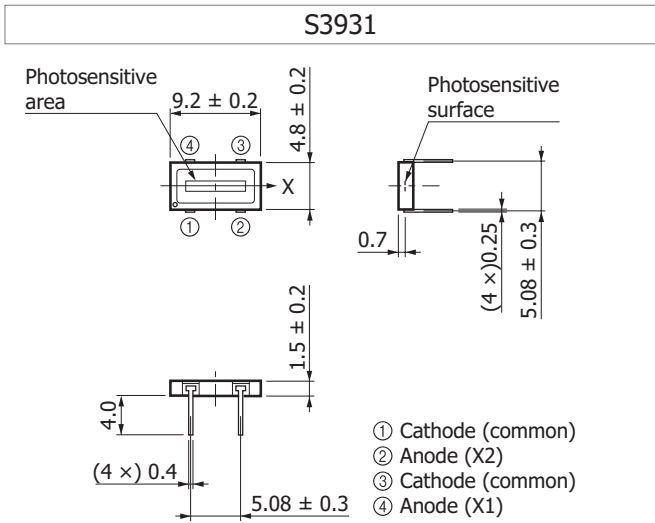

KPSDA0048EB

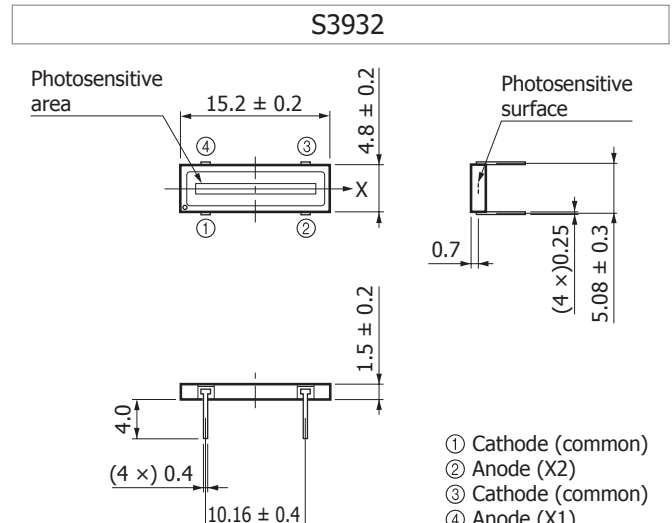

KPSDA0049EB

**Recommended soldering conditions**

· Solder temperature: 260 °C (5s or less, once)

· Solder the leads at a point at least 2 mm away from the package body.

Note: When you set soldering conditions, check that problems do not occur in the product by testing out the conditions in advance.

**Related information**

[www.hamamatsu.com/sp/ssd/doc\\_en.html](http://www.hamamatsu.com/sp/ssd/doc_en.html)

■ Precautions

- Disclaimer
- Metal, ceramic, plastic package products

■ Technical note

- PSD

Information described in this material is current as of July 2022.

Product specifications are subject to change without prior notice due to improvements or other reasons. This document has been carefully prepared and the information contained is believed to be accurate. In rare cases, however, there may be inaccuracies such as text errors. Before using these products, always contact us for the delivery specification sheet to check the latest specifications.

The product warranty is valid for one year after delivery and is limited to product repair or replacement for defects discovered and reported to us within that one year period. However, even if within the warranty period we accept absolutely no liability for any loss caused by natural disasters or improper product use. Copying or reprinting the contents described in this material in whole or in part is prohibited without our prior permission.

**HAMAMATSU**

[www.hamamatsu.com](http://www.hamamatsu.com)

HAMAMATSU PHOTONICS K.K., Solid State Division

1126-1 Ichino-cho, Higashi-ku, Hamamatsu City, 435-8558 Japan, Telephone: (81)53-434-3311, Fax: (81)53-434-5184

U.S.A.: HAMAMATSU CORPORATION: 360 Foothill Road, Bridgewater, NJ 08807, U.S.A., Telephone: (1)908-231-0960, Fax: (1)908-231-1218 E-mail: [usa@hamamatsu.com](mailto:usa@hamamatsu.com)

Germany: HAMAMATSU PHOTONICS DEUTSCHLAND GMBH.: Arzbergerstr. 10, 82211 Herrsching am Ammersee, Germany, Telephone: (49)8152-375-0, Fax: (49)8152-265-8 E-mail: [info@hamamatsu.de](mailto:info@hamamatsu.de)

France: HAMAMATSU PHOTONICS FRANCE S.A.R.L.: 19, Rue du Saule Trapu, Parc du Moulin de Massy, 91882 Massy Cedex, France, Telephone: (33)1 69 53 71 00, Fax: (33)1 69 53 71 10 E-mail: [infos@hamamatsu.fr](mailto:infos@hamamatsu.fr)

United Kingdom: HAMAMATSU PHOTONICS UK LIMITED: 2 Howard Court, 10 Tewin Road, Welwyn Garden City, Hertfordshire AL7 1BW, UK, Telephone: (44)1707-294888, Fax: (44)1707-325777 E-mail: [info@hamamatsu.co.uk](mailto:info@hamamatsu.co.uk)

North Europe: HAMAMATSU PHOTONICS NORDEN AB: Torshamnsgatan 35 16440 Kista, Sweden, Telephone: (46)8-509 031 00, Fax: (46)8-509 031 01 E-mail: [info@hamamatsu.se](mailto:info@hamamatsu.se)

Italy: HAMAMATSU PHOTONICS ITALIA S.R.L.: Strada della Moia, 1 int. 6, 20044 Arese (Milano), Italy, Telephone: (39)02-93 58 17 33, Fax: (39)02-93 58 17 41 E-mail: [info@hamamatsu.it](mailto:info@hamamatsu.it)

China: HAMAMATSU PHOTONICS (CHINA) CO., LTD.: 1201 Tower B, Jianning Center, 27 Dongsanhuan Beilu, Chaoyang District, 100020 Beijing, P.R. China, Telephone: (86)10-6586-6006, Fax: (86)10-6586-2866 E-mail: [hpc@hamamatsu.com.cn](mailto:hpc@hamamatsu.com.cn)

Taiwan: HAMAMATSU PHOTONICS TAIWAN CO., LTD.: 8F-3, No.158, Section 2, Gongdao 5th Road, East District, Hsinchu, 300, Taiwan R.O.C. Telephone: (886)3-659-0080, Fax: (886)3-659-0081 E-mail: [info@hamamatsu.com.tw](mailto:info@hamamatsu.com.tw)