

# CCD image sensors

S11850-1006-01

S11850-1106-01

S11851-1106-01



## Improved etaloning characteristics, Constant element temperature control

These are back-thinned CCD image sensors designed for spectrometers. Two types consisting of a low noise type (S11850-1106-01, S11850-1106-01) and high-speed type (S11851-1106-01) are available with improved etaloning characteristics. They offer nearly flat spectral response characteristics with high quantum efficiency from the UV to near infrared region. A thermoelectric cooler is placed inside the package to keep the element temperature constant (approx. 5 °C) during operation.

### Features

- Improved etaloning characteristics
- One-stage TE-cooled type  
(element temperature: approx. 5 °C)
- High sensitivity over a wide spectral range  
Nearly flat spectral response characteristics
- High CCD node sensitivity:  
6.5  $\mu\text{V}/\text{e}^-$  (S11850-1006-01, S11850-1106-01)  
8  $\mu\text{V}/\text{e}^-$  (S11851-1106-01)
- High full well capacity, wide dynamic range  
(with anti-blooming function)
- Pixel size: 14 × 14  $\mu\text{m}$

### Applications

- Spectrometers, etc.

### Improved etaloning characteristics

Etaloning is an interference phenomenon that occurs when the light incident on a CCD repeatedly reflects between the front and back surfaces of the CCD while being attenuated, and causes alternately high and low sensitivity. When long-wavelength light enters a back-thinned CCD, etaloning occurs due to the relationship between the silicon substrate thickness and the absorption length. The back-thinned CCDs [S11850/S11851 series (-01)] have achieved a significant improvement in etaloning by using a unique structure that is unlikely to cause interference.

### Etaloning characteristics (typical example)

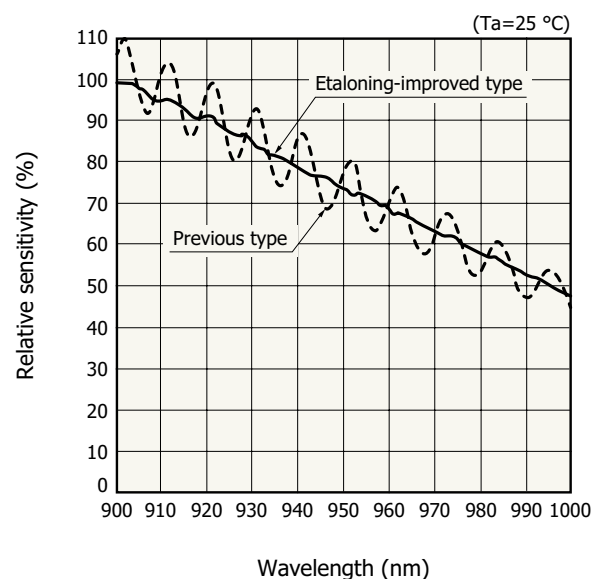

KMPDB0284EB

**Selection guide**

Type no.	Total number of pixels	Number of effective pixels	Image size [mm (H) × mm (V)]	Readout speed max. (MHz)	Suitable driver circuit
S11850-1006-01	1044 × 70	1024 × 64	14.336 × 0.896	0.5	C11860
S11850-1106-01	2068 × 70	2048 × 64	28.672 × 0.896	0.5	C11860
S11851-1106-01				10	-

**Structure**

Parameter	S11850-1006-01 S11850-1106-01	S11851-1106-01
Pixel size (H × V)	14 × 14 μm	
Vertical clock phase	2-phase	
Horizontal clock phase	4-phase	
Output circuit	One-stage MOSFET source follower	Two-stage MOSFET source follower
Package	28-pin ceramic DIP	
Window	Quartz glass*1	

\*1: Hermetic sealing

**Absolute maximum ratings (Ta=25 °C, unless otherwise noted)**

Parameter	Symbol	Condition	Min.	Typ.	Max.	Unit
Operating temperature*2	Topr		-50	-	+50	°C
Storage temperature	Tstg		-50	-	+70	°C
Output transistor drain voltage	VOD	S11850-1006-01 S11850-1106-01	-0.5	-	+30	V
		S11851-1106-01	-0.5	-	+25	V
Reset drain voltage		VRD		-0.5	-	+18
Output amplifier return voltage	Vret		-0.5	-	+18	V
Overflow drain voltage	VOFD		-0.5	-	+18	V
Vertical input source voltage	VISV		-0.5	-	+18	V
Horizontal input source voltage	VISH		-0.5	-	+18	V
Overflow gate voltage	VOFG		-10	-	+15	V
Vertical input gate voltage	VIG1V, VIG2V		-10	-	+15	V
Horizontal input gate voltage	VIG1H, VIG2H		-10	-	+15	V
Summing gate voltage	VSG		-10	-	+15	V
Output gate voltage	VOG		-10	-	+15	V
Reset gate voltage	VRG		-10	-	+15	V
Transfer gate voltage	VTG		-10	-	+15	V
Vertical shift register clock voltage	VP1V, VP2V		-10	-	+15	V
Horizontal shift register clock voltage	VP1H, VP2H VP3H, VP4H		-10	-	+15	V
TE-cooler maximum current*3 *4	Imax	Tc*5=Th*6=25 °C	-	1.8	-	A
TE-cooler maximum voltage	Vmax	Tc*5=Th*6=25 °C	-	3.5	-	V
Thermistor power dissipation	Pd_th		-	-	100	mW

\*2: Chip temperature

\*3: If the current greater than this value flows into the thermoelectric cooler, the heat absorption begins to decrease due to the Joule heat. It should be noted that this value is not the damage threshold value. To protect the thermoelectric cooler and maintain stable operation, the supply current should be less than 60% of this maximum current.

\*4: To ensure stable temperature control, ΔT (temperature difference between Th and Tc) should be less than 30 °C. If ΔT exceeds 30 °C, product characteristics such as the dark current uniformity may deteriorate.

\*5: Temperature of the cooling side of thermoelectric cooler

\*6: Temperature of the heat radiating side of thermoelectric cooler

Note: Exceeding the absolute maximum ratings even momentarily may cause a drop in product quality. Always be sure to use the product within the absolute maximum ratings.

▣ Operating conditions (MPP mode, Ta=25 °C)

Parameter	Symbol	S11850-1006-01 S11850-1106-01			S11851-1106-01			Unit	
		Min.	Typ.	Max.	Min.	Typ.	Max.		
Output transistor drain voltage	VOD	23	24	25	12	15	18	V	
Reset drain voltage	VRD	11	12	13	14	15	16	V	
Output amplifier return voltage*7	Vret				-	1	2	V	
Overflow drain voltage	VOFD	11	12	13	11	12	13	V	
Test point	Input source	VISV, VISH	-	VRD	-	-	VRD	-	V
	Vertical input gate	VIG1V, VIG2V	-9	-8	-	-9	-8	-	V
	Horizontal input gate	VIG1H, VIG2H	-9	-8	-	-9	-8	-	V
Overflow gate voltage	VOFG	0	12	13	0	13	14	V	
Summing gate voltage	High	VSGH	4	6	8	4	6	8	V
	Low	VSGL	-6	-5	-4	-6	-5	-4	
Output gate voltage	VOG	4	5	6	4	5	6	V	
Reset gate voltage	High	VRGH	4	6	8	4	6	8	V
	Low	VRGL	-6	-5	-4	-6	-5	-4	
Transfer gate voltage	High	VTGH	4	6	8	4	6	8	V
	Low	VTGL	-9	-8	-7	-9	-8	-7	
Vertical shift register clock voltage	High	VP1VH, VP2VH	4	6	8	4	6	8	V
	Low	VP1VL, VP2VL	-9	-8	-7	-9	-8	-7	
Horizontal shift register clock voltage	High	VP1HH, VP2HH VP3HH, VP4HH	4	6	8	4	6	8	V
	Low	VP1HL, VP2HL VP3HL, VP4HL	-6	-5	-4	-6	-5	-4	
Substrate voltage	VSS	-	0	-	-	0	-	V	
External load resistance	RL	90	100	110	2.0	2.2	2.4	kΩ	

\*7: Output amplifier return voltage is a positive voltage with respect to substrate voltage, but the current flows in the direction of flow out of the sensor.

▣ Electrical characteristics (Ta=25 °C)

Parameter	Symbol	S11850-1006-01			S11850-1106-01			S11851-1106-01			Unit
		Min.	Typ.	Max.	Min.	Typ.	Max.	Min.	Typ.	Max.	
Signal output frequency*8	fc	-	0.25	0.5	-	0.25	0.5	-	5	10	MHz
Vertical shift register capacitance	CP1V, CP2V	-	600	-	-	1200	-	-	1200	-	pF
Horizontal shift register capacitance	CP1H, CP2H CP3H, CP4H	-	80	-	-	160	-	-	160	-	pF
Summing gate capacitance	CSG	-	10	-	-	10	-	-	10	-	pF
Reset gate capacitance	CRG	-	10	-	-	10	-	-	10	-	pF
Transfer gate capacitance	CTG	-	30	-	-	60	-	-	60	-	pF
Charge transfer efficiency*9	CTE	0.99995	0.99999	-	0.99995	0.99999	-	0.99995	0.99999	-	-
DC output level*8	Vout	16	17	18	16	17	18	7	8	9	V
Output impedance*8	Zo	-	10	-	-	10	-	-	0.3	-	kΩ
Power consumption*8 *10	P	-	4	-	-	4	-	-	75	-	mW

\*8: The values depend on the load resistance.

VOD=24 V, RL=100 kΩ (S11850-1006-01, S11850-1106-01), VOD=15 V, RL=2.2 kΩ(S11851-1106-01)

\*9: Charge transfer efficiency per pixel, measured at half of the full well capacity

\*10: Power consumption of the on-chip amplifier plus load resistance

**Electrical and optical characteristics (Ta=25 °C, unless otherwise noted)**

Parameter	Symbol	S11850-1006-01 S11850-1106-01			S11851-1106-01			Unit
		Min.	Typ.	Max.	Min.	Typ.	Max.	
Saturation output voltage	Vsat	-	Fw × CE	-	-	Fw × CE	-	V
Full well capacity	Vertical	Fw	50	60	-	50	60	ke <sup>-</sup>
	Horizontal		250	300	-	150	200	
Conversion efficiency*11	CE	5.5	6.5	7.5	7	8	9	μV/e <sup>-</sup>
Dark current (MPP mode)*12	DS	-	50	500	-	50	500	e <sup>-</sup> /pixel/s
Readout noise*13	Nread	-	6	15	-	23	28	e <sup>-</sup> rms
Dynamic range*14	Line binning	Drange	16600	50000	-	5350	8700	-
Spectral response range	λ	-	200 to 1100	-	-	200 to 1100	-	nm
Photoresponse nonuniformity*15	PRNU	-	±3	±10	-	±3	±10	%

\*11: The values depend on the load resistance.

(S11850-1006-01, S11850-1106-01: V<sub>OD</sub>=24 V, R<sub>L</sub>=100 kΩ, S11851-1106-01: V<sub>OD</sub>=15 V, R<sub>L</sub>=2.2 kΩ)

\*12: Dark current is reduced to half for every 5 to 7 °C decrease in temperature.

\*13: T<sub>chip</sub>=-40 °C, f<sub>c</sub>=20 kHz (S11850-1006-01, S11850-1106-01), T<sub>chip</sub>=25 °C, f<sub>c</sub>=2 MHz (S11851-1106-01)

\*14: Dynamic range = Full well capacity / Readout noise

\*15: Measured at one-half of the saturation output (full well capacity) using LED light (peak emission wavelength: 470 nm)

$$\text{Photoresponse nonuniformity} = \frac{\text{Fixed pattern noise (peak to peak)}}{\text{Signal}} \times 100 [\%]$$

**Spectral response (without window)\*16**

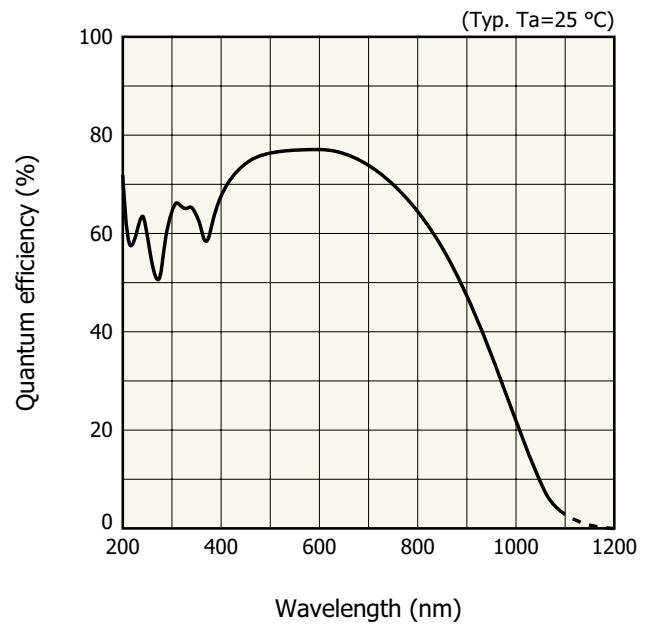
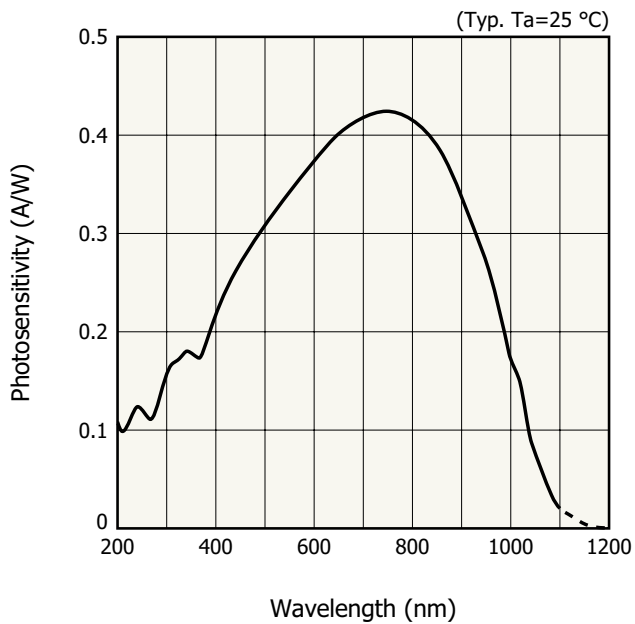

\*16: Spectral response with quartz glass is decreased according to the spectral transmittance characteristics of window material.

▣ Spectral transmittance characteristics of window material

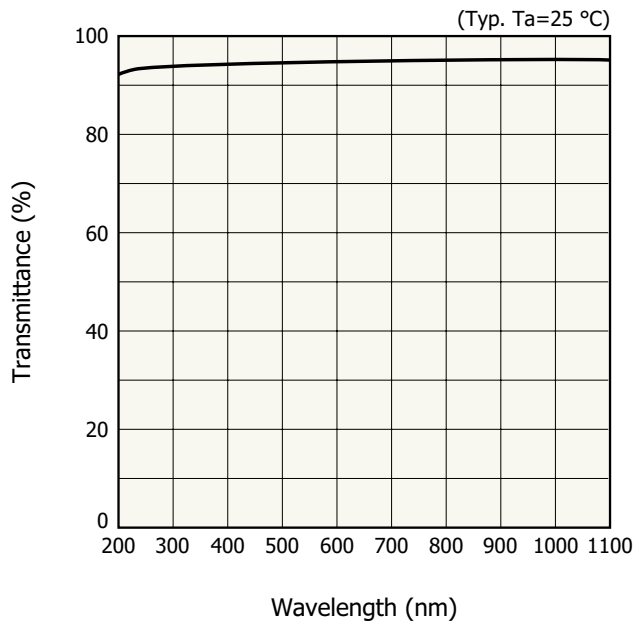

KMPDB0303EB

▣ Dark current vs. temperature

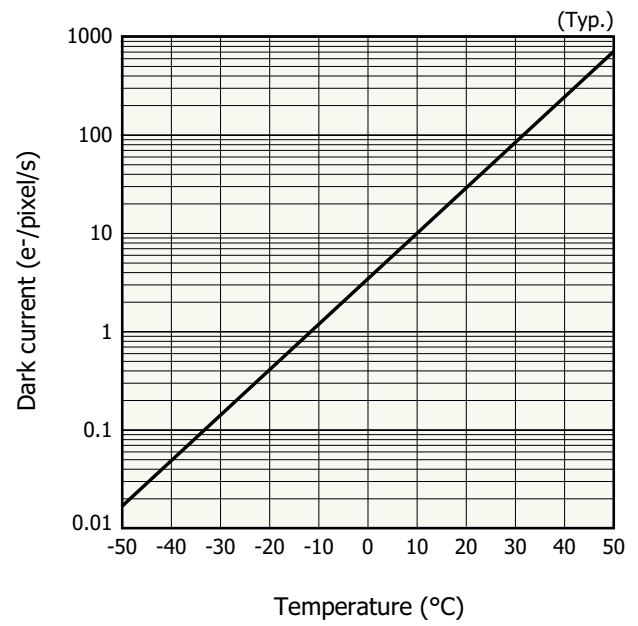

KMPDB0304EB

**Device structure (conceptual drawing of top view in dimensional outline)**

S11850-1006-01, S11850-1106-01

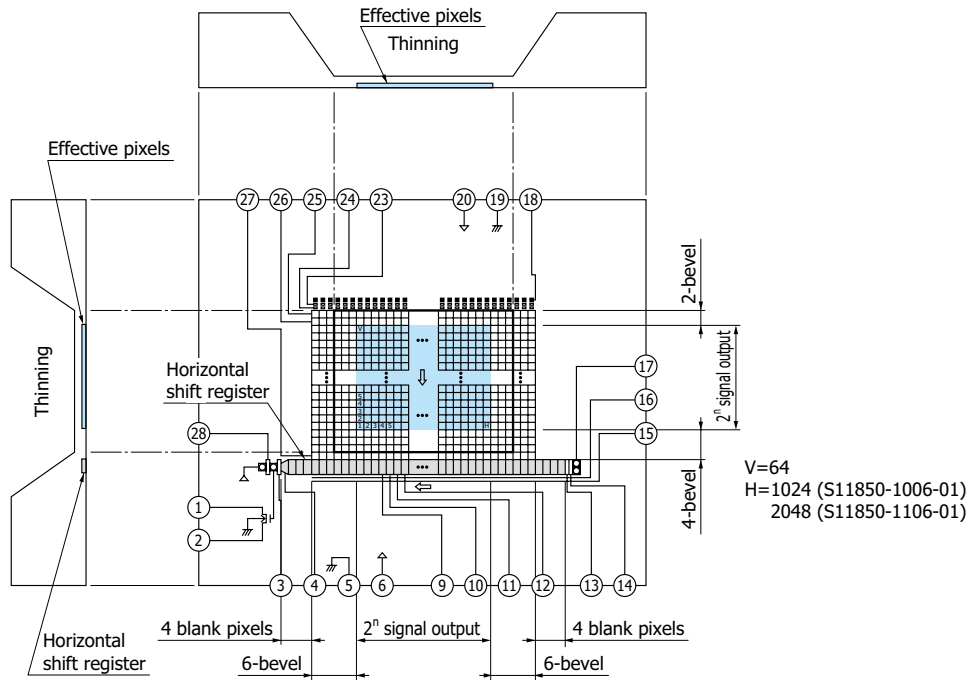

Note: When viewed from the direction of the incident light, the horizontal shift register is covered with a thick silicon layer (dead layer). However, long-wavelength light passes through the silicon dead layer and may possibly be detected by the horizontal shift register. To prevent this, provide light shield on that area as needed.

KMPDC0945EA

S11851-1106-01

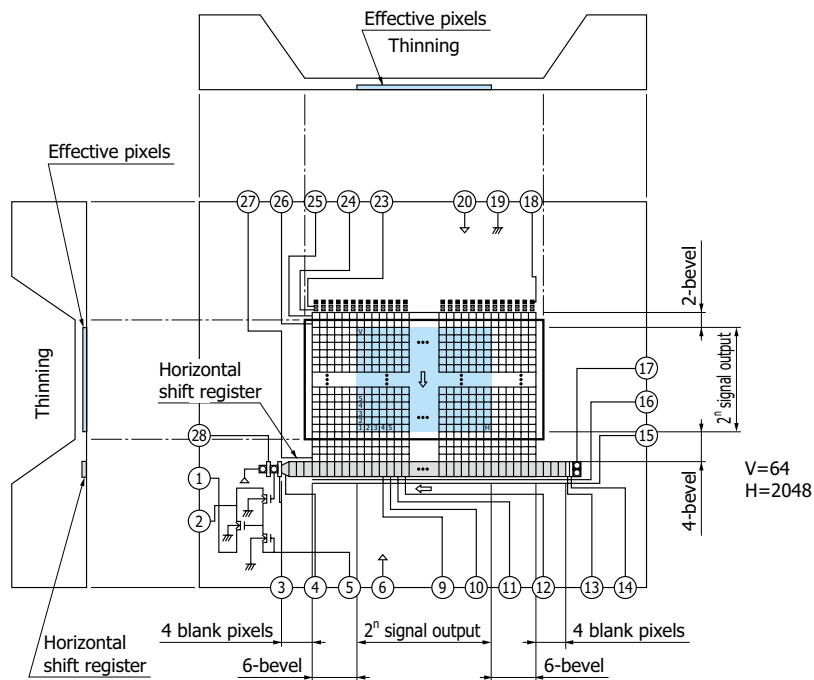

Note: When viewed from the direction of the incident light, the horizontal shift register is covered with a thick silicon layer (dead layer). However, long-wavelength light passes through the silicon dead layer and may possibly be detected by the horizontal shift register. To prevent this, provide light shield on that area as needed.

KMPDC0403EC



**Dimensional outline (unit: mm)**

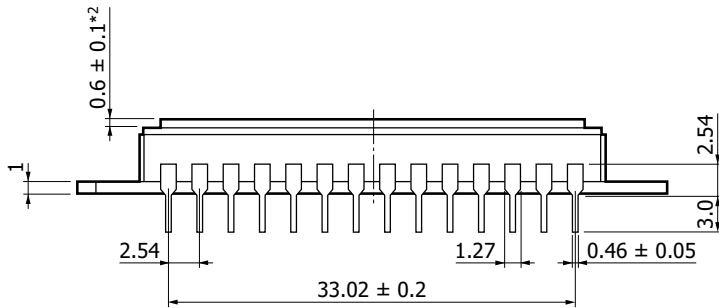
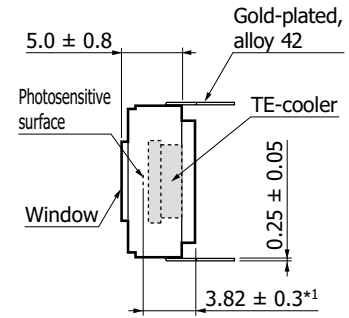
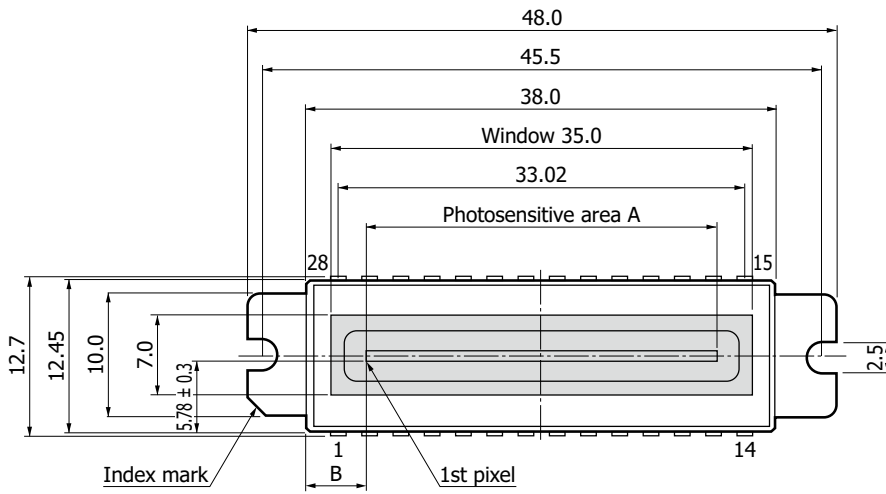

Tolerance unless otherwise noted:  $\pm 0.15$

Weight: 9 g

\*1: Distance from package bottom to photosensitive surface

\*2: Glass thickness (reflective index  $\approx 1.5$ )

Type no.	A	B
S11850-1006-01	14.336 × 0.896	11.83 ± 0.3
S11850-1106-01	28.672 × 0.896	4.66 ± 0.3
S11851-1106-01		

KMPDA0369EB



**Pin connections**

S11850-1006-01, S11850-1106-01			
Pin no.	Symbol	Function	Remark (standard operation)
1	OS	Output transistor source	RL=100 kΩ
2	OD	Output transistor drain	+24 V
3	OG	Output gate	+5 V
4	SG	Summing gate	Same pulse as P4H
5	SS	Substrate	GND
6	RD	Reset drain	+12 V
7	Th1	Thermistor	
8	P-	TE-cooler-	
9	P4H	CCD horizontal register clock-4	
10	P3H	CCD horizontal register clock-3	
11	P2H	CCD horizontal register clock-2	
12	P1H	CCD horizontal register clock-1	
13	IG2H	Test point (horizontal input gate-2)	-8 V
14	IG1H	Test point (horizontal input gate-1)	-8 V
15	OFG	Overflow gate	+12 V
16	OFD	Overflow drain	+12 V
17	ISH	Test point (horizontal input source)	Connect to RD
18	ISV	Test point (vertical input source)	Connect to RD
19	SS	Substrate	GND
20	RD	Reset drain	+12 V
21	P+	TE-cooler+	
22	Th2	Thermistor	
23	IG2V	Test point (vertical input gate-2)	-8 V
24	IG1V	Test point (vertical input gate-1)	-8 V
25	P2V	CCD vertical register clock-2	
26	P1V	CCD vertical register clock-1	
27	TG	Transfer gate	Same pulse as P2V
28	RG	Reset gate	

S11851-1106-01

Pin no.	Symbol	Function	Remark (standard operation)
1	OS	Output transistor source	RL=2.2 kΩ
2	OD	Output transistor drain	+15 V
3	OG	Output gate	+5 V
4	SG	Summing gate	Same pulse as P4H
5	Vret	Output amplifier return	+1 V
6	RD	Reset drain	+15 V
7	Th1	Thermistor	
8	P-	TE-cooler-	
9	P4H	CCD horizontal register clock-4	
10	P3H	CCD horizontal register clock-3	
11	P2H	CCD horizontal register clock-2	
12	P1H	CCD horizontal register clock-1	
13	IG2H	Test point (horizontal input gate-2)	-8 V
14	IG1H	Test point (horizontal input gate-1)	-8 V
15	OFG	Overflow gate	+13 V
16	OFD	Overflow drain	+12 V
17	ISH	Test point (horizontal input source)	Connect to RD
18	ISV	Test point (vertical input source)	Connect to RD
19	SS	Substrate	GND
20	RD	Reset drain	+15 V
21	P+	TE-cooler+	
22	Th2	Thermistor	
23	IG2V	Test point (vertical input gate-2)	-8 V
24	IG1V	Test point (vertical input gate-1)	-8 V
25	P2V	CCD vertical register clock-2	
26	P1V	CCD vertical register clock-1	
27	TG	Transfer gate	Same pulse as P2V
28	RG	Reset gate	

**OS output waveform examples**

S11850-1006-01, S11850-1106-01

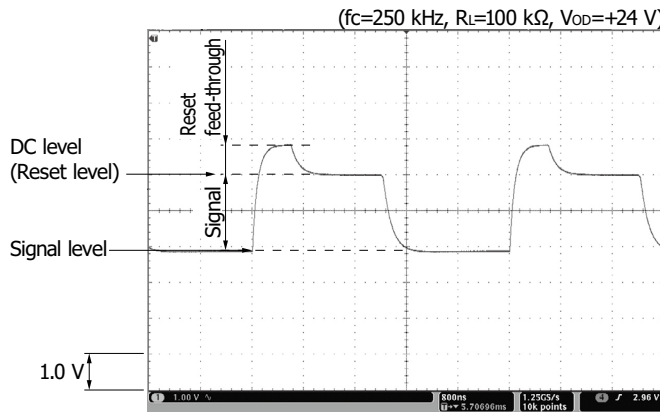

S11851-1106-01

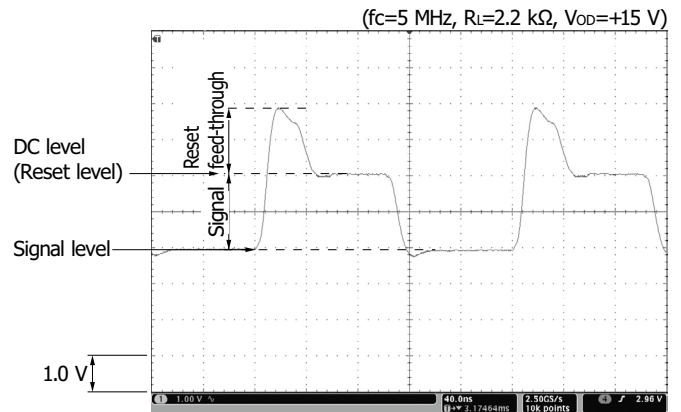

**Specifications of built-in TE-cooler (Typ., vacuum condition)**

Parameter	Symbol	Condition	Specification	Unit
Internal resistance	Rint	Ta=25 °C	1.6	Ω
Maximum heat absorption*18	Qmax		4.0	W

\*18: This is a theoretical heat absorption level to correct the temperature difference in the thermoelectric cooler when the maximum current is supplied to the sensor.

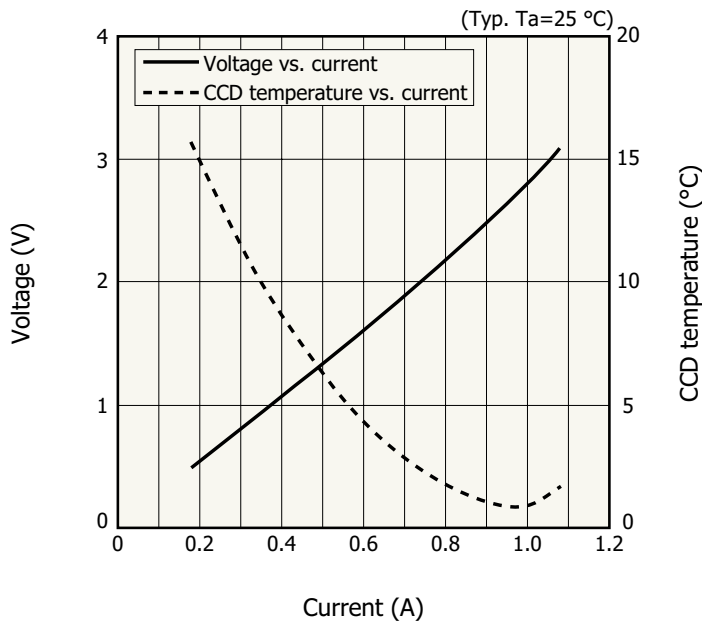

KMPDB0469EA

**Specifications of built-in temperature sensor**

A thermistor chip is built in the same package with a CCD chip, and the CCD chip temperature can be monitored with it. A relation between the thermistor resistance and absolute temperature is expressed by the following equation.

$$R_{T1} = R_{T2} \times \exp \left( B_{T1/T2} \left( \frac{1}{T1} - \frac{1}{T2} \right) \right)$$

R<sub>T1</sub>: Resistance at absolute temperature T1 [K]

R<sub>T2</sub>: Resistance at absolute temperature T2 [K]

B<sub>T1/T2</sub>: B constant [K]

The characteristics of the thermistor used are as follows.

R<sub>298</sub>=10 kΩ

B<sub>298/323</sub>=3900 K

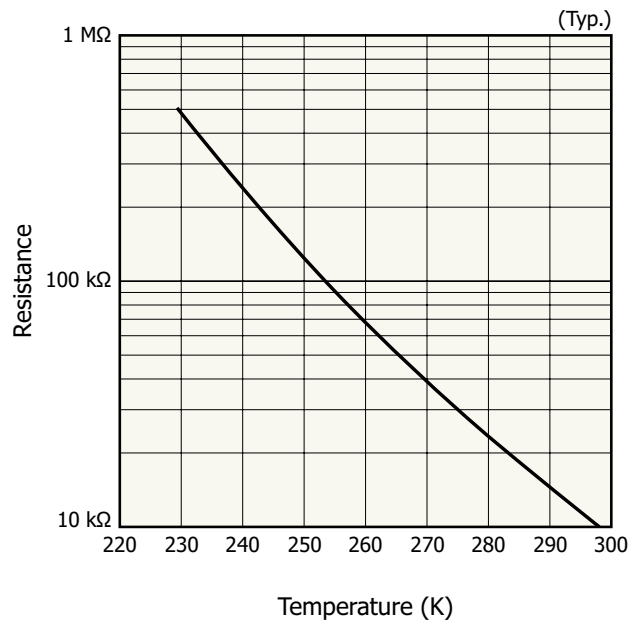

KMPD800470EA

**Recommended soldering conditions**

Parameter	Specification	Remark
Solder temperature	260 °C max. (once, less than 5 s)	At least 1.8 mm away from lead roots

**Precautions**

- If the thermoelectric cooler does not radiate away sufficient heat, then the product temperature will rise and cause physical damage or deterioration to the product. Make sure there is sufficient heat dissipation during cooling. As a heat dissipation measure, we recommend applying a high heat-conductivity material (silicone grease, etc.) over the entire area between the product and the heat-sink (metallic block, etc.), and screwing and securing the product to a heatsink.
- Handle these sensors with bare hands or wearing cotton gloves. In addition, wear anti-static clothing or use a wrist band with an earth ring, in order to prevent electrostatic damage due to electrical charges from friction.
- Avoid directly placing these sensors on a work-desk or work-bench that may carry an electrostatic charge.
- Provide ground lines or ground connection with the work-floor, work-desk and work-bench to allow static electricity to discharge.
- Ground the tools used to handle these sensors, such as tweezers and soldering irons.

It is not always necessary to provide all the electrostatic measures stated above. Implement these measures according to the amount of damage that occurs.

**Related information**

[www.hamamatsu.com/sp/ssd/doc\\_en.html](http://www.hamamatsu.com/sp/ssd/doc_en.html)

- Precautions
  - Disclaimer
  - Image sensors

- Technical information
  - CCD area image sensors

Driver circuit C11860 (sold separately) for CCD image sensor [S11850 series (-01), S14651 series]

The C11860 is a driver circuit developed for the Hamamatsu CCD image sensor S11850 series (-01) or S14651 series.

## Features

- **Built-in 16-bit A/D converter**
- **The sensor circuit board and interface circuit board are connected using a flexible cable.**
- **Interface: USB 2.0**
- **External synchronization capable**
- **Single power supply: DC +5 V**
- **Sensor cooling control (approx. +5 °C)**



Information described in this material is current as of February 2023.

Product specifications are subject to change without prior notice due to improvements or other reasons. This document has been carefully prepared and the information contained is believed to be accurate. In rare cases, however, there may be inaccuracies such as text errors. Before using these products, always contact us for the delivery specification sheet to check the latest specifications.

The product warranty is valid for one year after delivery and is limited to product repair or replacement for defects discovered and reported to us within that one year period. However, even if within the warranty period we accept absolutely no liability for any loss caused by natural disasters or improper product use. Copying or reprinting the contents described in this material in whole or in part is prohibited without our prior permission.

# HAMAMATSU

[www.hamamatsu.com](http://www.hamamatsu.com)

HAMAMATSU PHOTONICS K.K., Solid State Division

1126-1 Ichino-cho, Higashi-ku, Hamamatsu City, 435-8558 Japan, Telephone: (81)53-434-3311, Fax: (81)53-434-5184

U.S.A.: HAMAMATSU CORPORATION: 360 Foothill Road, Bridgewater, NJ 08807, U.S.A., Telephone: (1)908-231-0960, Fax: (1)908-231-1218

Germany: HAMAMATSU PHOTONICS DEUTSCHLAND GMBH: Arzbergerstr. 10, 82211 Herrsching am Ammersee, Germany, Telephone: (49)8152-375-0, Fax: (49)8152-265-8 E-mail: [info@hamamatsu.de](mailto:info@hamamatsu.de)

France: HAMAMATSU PHOTONICS FRANCE S.A.R.L.: 19 Rue du Saule Trapu, Parc du Moulin de Massy, 91882 Massy Cedex, France, Telephone: (33)1 69 53 71 00, Fax: (33)1 69 53 71 10 E-mail: [infos@hamamatsu.fr](mailto:infos@hamamatsu.fr)

United Kingdom: HAMAMATSU PHOTONICS UK LIMITED: 2 Howard Court, 10 Tewin Road, Welwyn Garden City, Hertfordshire, AL7 1BW, UK, Telephone: (44)1707-294888, Fax: (44)1707-325777 E-mail: [info@hamamatsu.co.uk](mailto:info@hamamatsu.co.uk)

North Europe: HAMAMATSU PHOTONICS NORDEN AB: Torshamnsgatan 35, 16440 Kista, Sweden, Telephone: (46)8-509-031-00, Fax: (46)8-509-031-01 E-mail: [info@hamamatsu.se](mailto:info@hamamatsu.se)

Italy: HAMAMATSU PHOTONICS ITALIA S.R.L.: Strada della Moia, 1 int. 6 20044 Arese (Milano), Italy, Telephone: (39)02-93 58 17 33, Fax: (39)02-93 58 17 41 E-mail: [info@hamamatsu.it](mailto:info@hamamatsu.it)

China: HAMAMATSU PHOTONICS (CHINA) CO., LTD.: 1201, Tower B, Jiaming Center, 27 Dongsanhuan Beilu, Chaoyang District, 100020 Beijing, P.R. China, Telephone: (86)10-6586-6006, Fax: (86)10-6586-2866 E-mail: [hpc@hamamatsu.com.cn](mailto:hpc@hamamatsu.com.cn)

Taiwan: HAMAMATSU PHOTONICS TAIWAN CO., LTD.: 8F-3, No.158, Section 2, Gongdao 5th Road, East District, Hsinchu, 300, Taiwan R.O.C. Telephone: (886)3-659-0080, Fax: (886)3-659-0081 E-mail: [info@hamamatsu.com.tw](mailto:info@hamamatsu.com.tw)