

HAMAMATSU

PHOTON IS OUR BUSINESS

DISCHARGE / FLAME SENSOR UVTRON[®]

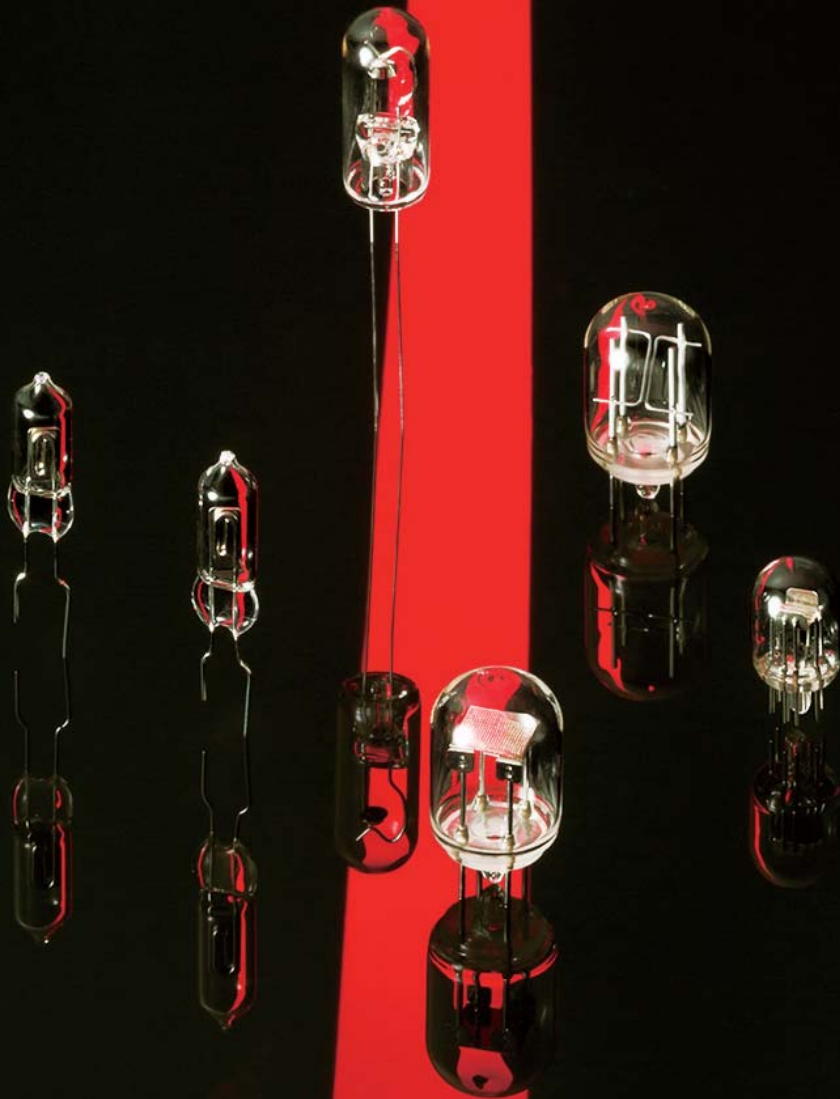

HAMAMATSU PHOTONICS K.K.

Features

What is the UVTRON®?

The UVTRON is an ultraviolet ON/OFF sensor that uses the photoelectric effect of metal and gas multiplication effect.

As the UVTRON detects the light (ultraviolet radiation) in a flame, it provides outstanding high sensitivity and high-speed response compared to other methods such as smoke detection and heat detection.

High sensitivity

The UVTRON responds to faint ultraviolet emissions from flames, so it can accurately detect even small ignitions. Its high sensitivity allows reliable operation even in wide open space such as gymnasiums and other large composite facilities.

Sensitivity and distance from fire

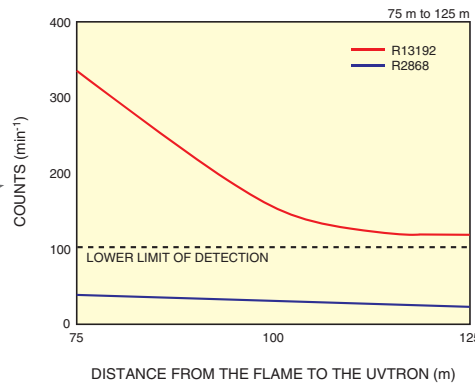
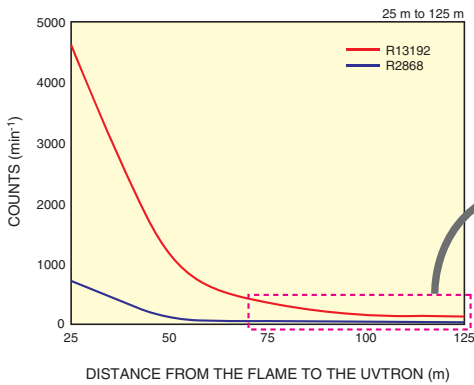

○ Measurement condition

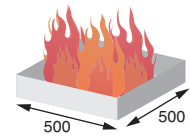

Fire tray size:
500 mm × 500 mm
Fuel: Alcohol

TPT B0052EB

High speed response

As the UVTRON detects ultraviolet light, detection is possible immediately after an ignition or discharge. High-speed response in few milliseconds makes it possible to take prompt action in the event of a fire or other emergency situation.

Compact / Light weight

Its compact size and lightweight enable the UVTRON to be employed even in compact detectors. Further, the best type of UVTRON can be selected according to the application or location from a product lineup that includes several shapes.

Solar blind

UVTRON has an extremely narrow spectral response range from 185 nm to 300 nm and is insensitive to visible light. And the Ni electrode does not respond to ultraviolet radiation in sunlight.

Spectral response

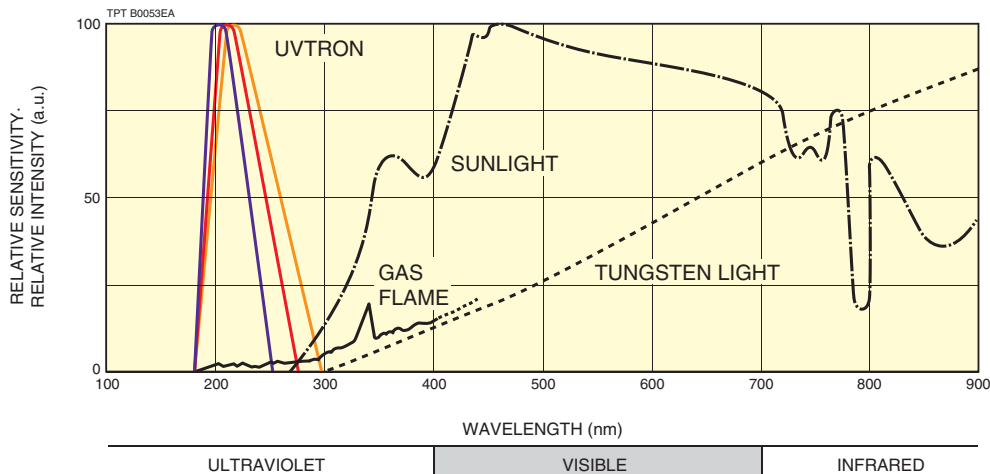

Applications



Flame detection

Used in a location without flames. Flames are detected immediately when an ignition occurs.



Combustion monitoring

Constantly monitors flames and detects abnormality such as flames going out.



Discharge detection

Mainly used near electrical contacts. In the event of a discharge, it is immediately detected.

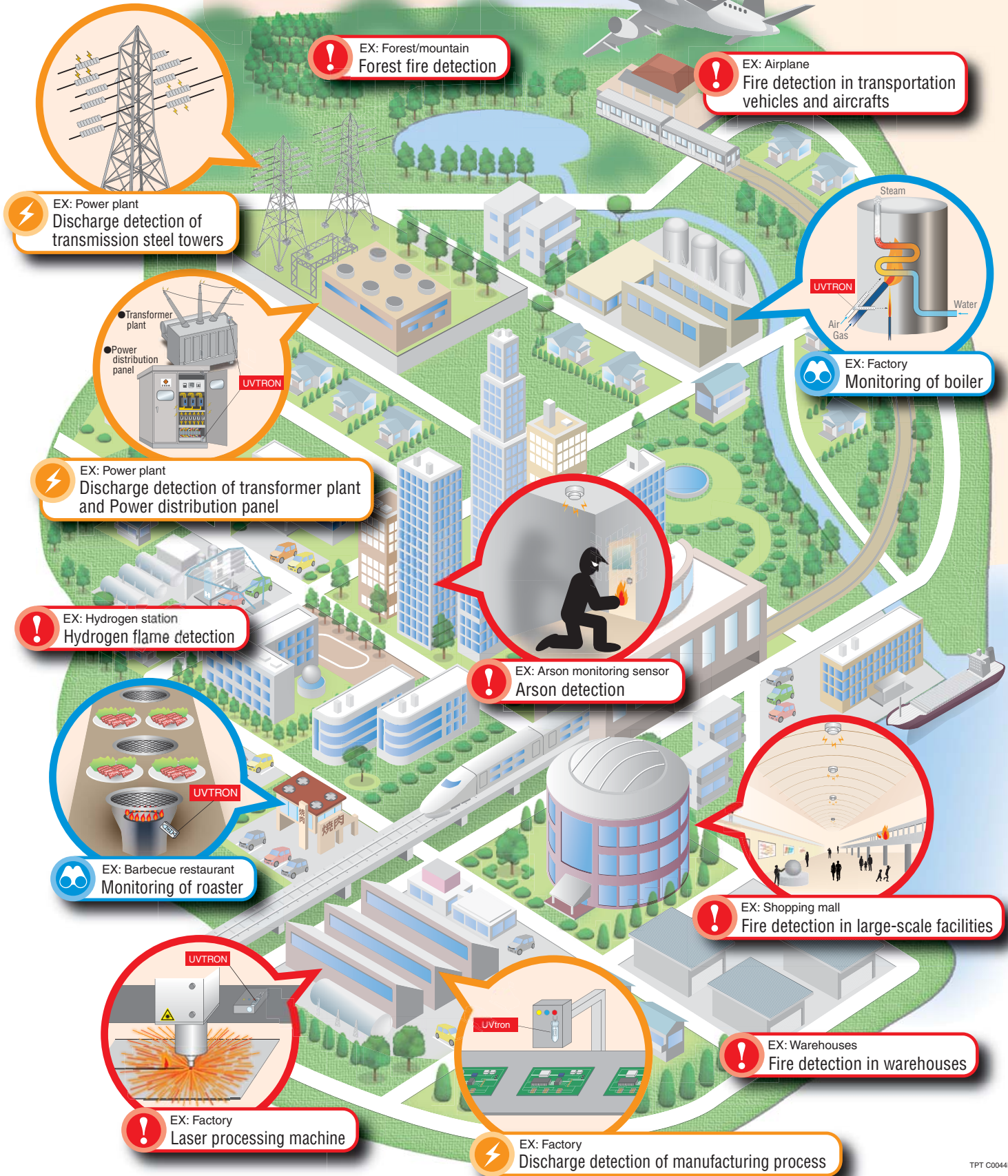

EX: Forest/mountain
Forest fire detection

EX: Airplane
Fire detection in transportation vehicles and aircrafts

EX: Power plant
Discharge detection of transmission steel towers

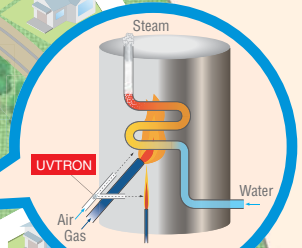

EX: Factory
Monitoring of boiler

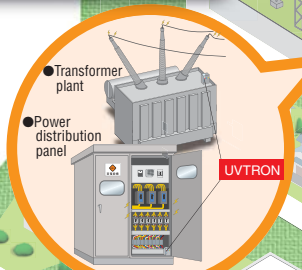

EX: Power plant
Discharge detection of transformer plant and Power distribution panel



EX: Arson monitoring sensor
Arson detection

EX: Hydrogen station
Hydrogen flame detection



EX: Barbecue restaurant
Monitoring of roaster



EX: Shopping mall
Fire detection in large-scale facilities

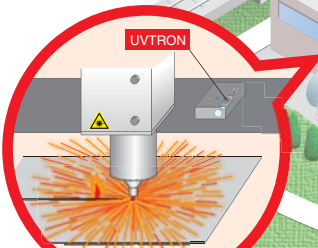

EX: Factory
Laser processing machine

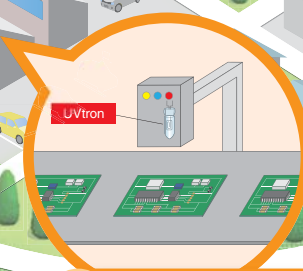

EX: Factory
Discharge detection of manufacturing process

EX: Warehouses
Fire detection in warehouses

Specifications

Parameter		R13192	R9454	R2868	R9533	R244	R14388	R12257	Unit	
Dimensional outline		①	②	③	④	⑤	⑥	⑦	—	
Electrode material		Ni						Mo	—	
Spectral response range		185 to 260						185 to 300	nm	
Maximum ratings	Supply voltage (DC)	420	500	400	400	575	420	425	V	
	Average discharge current ^(A)	3		1		3		10	mA	
	Peak current ^(B)	50		30		50		200	mA	
	Operation ambient temperature	-40 / +125							°C	
Characteristics (at 25 °C)	Discharge starting voltage (DC) Max.	260	360	280	280	440	260	240	V	
	Discharge sustaining voltage (DC) Typ.	185	300	240	230	330	185	170	V	
	Sensitivity ^(C) Typ.	15000	4000	5000	10000	480	10000	1200	min ⁻¹ ^(G)	
	Background ^(D) Max.	5		10		5		10	min ⁻¹ ^(G)	
	Estimated life ^(E)	25000						10000	h	
Recommended operating parameters	Supply voltage (DC)	325 ± 25	400 ± 25	325 ± 25	350 ± 25	500 ± 50	325 ± 25	310 ± 25	V	
	Average discharge current	0.3							2	mA
	Quenching time ^(F) Min.	2	2	2	1	3	2	1	ms	
Weight		5.2	1.5	1.5	2.5	3	5.3	5	g	
Suitable socket (Sold separately)		E678-9C	—	—	E678-8F	—	E678-9C		—	

^(A) Even at these current values, the electrodes are not consumed immediately, but the service life is noticeably reduced. Use the tube within the recommended current values.

^(B) This is the maximum momentary current that can be handled if its full width at half maximum is less than 10 μs.

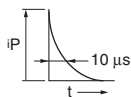

^(C) These are representative values for a wavelength of 200 nm and a light input of 10 pW/cm². Think of these values as relative sensitivity values. In actual use, the sensitivity will vary with the wavelength of the ultraviolet radiation and the driver circuitry employed.

^(D) Measured under room illuminations (approximately 500 lux) and recommended operating conditions. Note that these values may increase slightly when used outdoors due to external disturbance or the like.

^(E) The service life varies depending on the driver circuit and ambient temperature. These values are for when the UVTRON is used at normal discharge under recommended operating conditions. Since high ambient temperature reduces the service life, when high temperature is expected such as in a burner monitor application, consider taking cooling measures such as air-cooling. The UVTRON is covered by warranty for one year after delivery.

^(F) When configuring the tube with an external quenching circuit, use circuit constants so that the quenching time becomes longer than these values listed. When using a pulse driven circuit using CR, if the applied voltage is in the recommended range, the quenching time \$t_q\$ can be calculated with the following formula. (Refer to the diagram of the recommended operating circuit.)

$$t_q \approx 0.5 \times C_1 \cdot R_1$$

^(G) min⁻¹ indicates a counts/min.

Dimensional outline (Unit: mm) / Angular sensitivity

① R13192

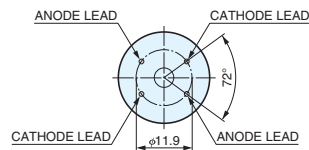
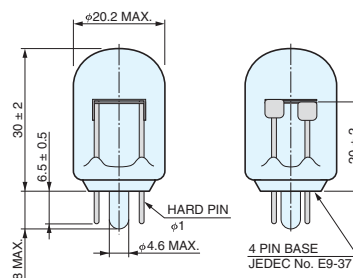
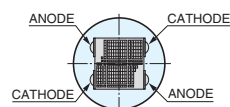

TPT A0055EB

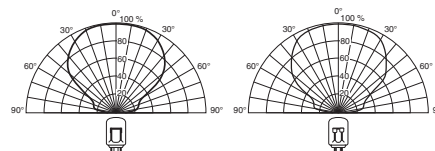

TPT B0054EA

Dimensional outline (Unit: mm) / Angular sensitivity

② R9454

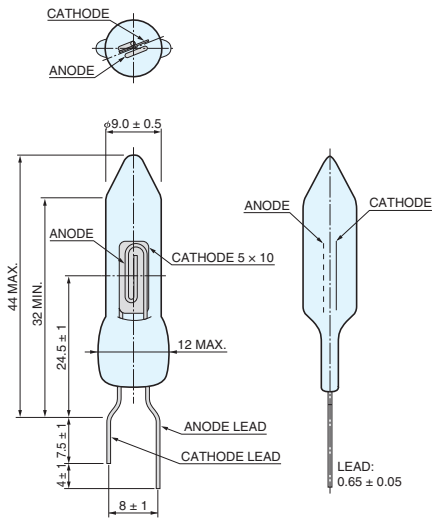

TPT A0036ED

③ R2868

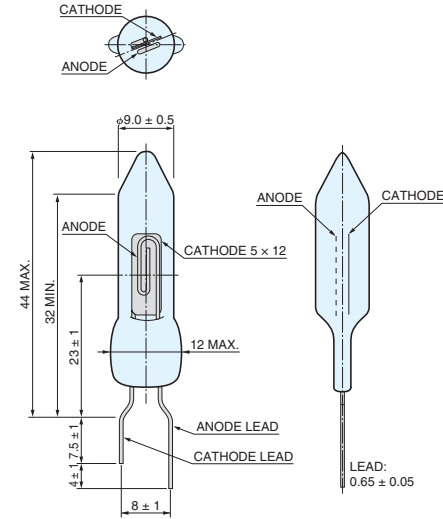

TPT A0056ED

④ R9533

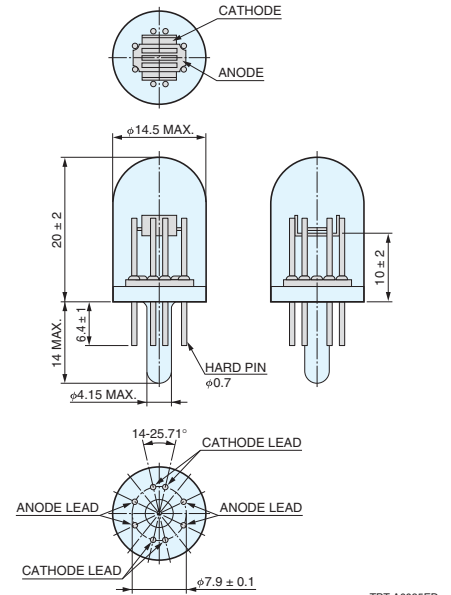

TPT A0035ED

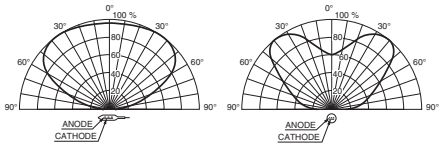

TPT B0033EB

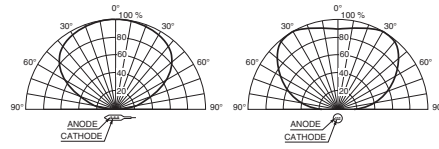

TPT B0010EB

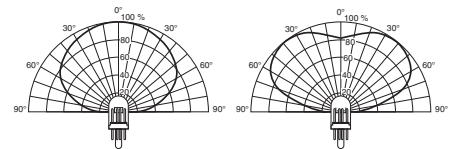

TPT B0032EB

⑤ R244

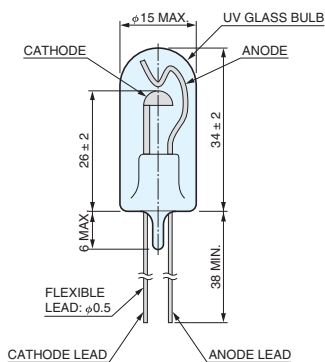

TPT A0038EB

⑥ R14388

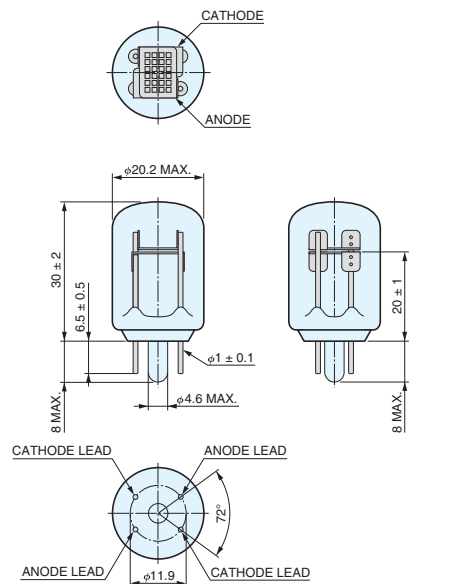

TPT A0059EA

⑦ R12257

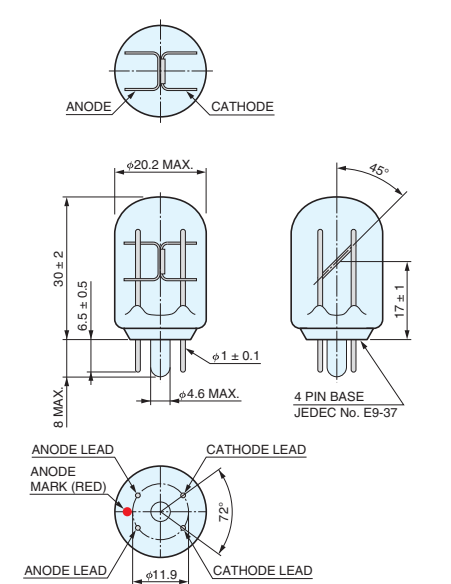

TPT A0057EB

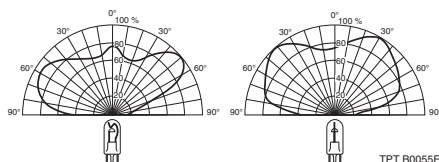

TPT B0055EA

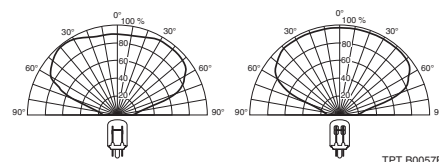

TPT B0057EA

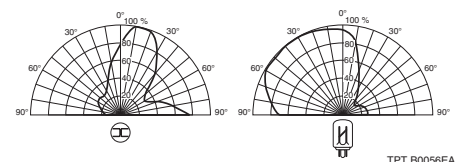

TPT B0056EA

Driver circuits

Recommended circuit

This circuit is suitable for creating a high voltage DC power supply by converting low DC voltage of dry cells or the like with a DC-DC converter (oscillating voltage booster circuit) and can be operated reliably with minute current. As the voltage supplied to the UVTRON is DC, there is no dead time. As such, it can be applied to fire detection circuit with high-speed response.

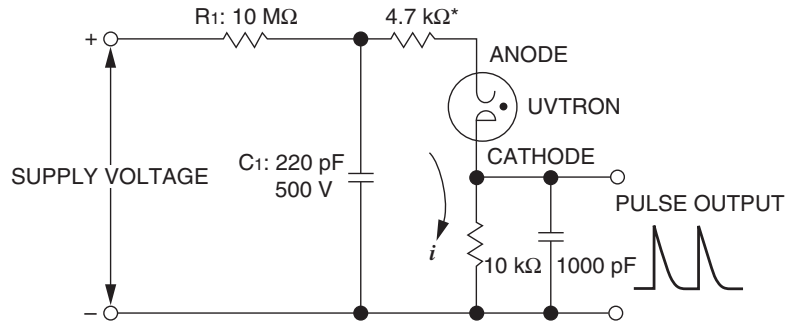

* To reduce the effect of lead wire's stray capacitance, connect the 4.7 kΩ resistor within 2.5 cm of the tip of the UVTRON anode lead.

TPT C0016EA

Related products

Driver circuit for UVTRON

This is a compact high-voltage power supply and signal processing circuit for driving the UVTRON. Operation is possible by connecting a UVTRON and applying low voltage. Since the signal processing circuit cancels the UVTRON's sporadic background noise (cosmic rays, unexpected ultraviolet light, etc.), there is little false detection, and the signal output can be used as-is.

The circuit is available in two types: a high-volume production type with a fixed supply voltage and a variable-voltage experiment/evaluation type with a supply voltage selector DIP switch.



▲C10807 / C10423



▲C12944

Parameter		Description / Value			Unit
Type No.		C10807	C10423	C12944	
Type of supply voltage		Voltage clamp		Voltage variable	—
UVTRON supply voltage (DC) [Ⓐ]		350	400	Variable (310 / 325 / 350 / 400 / 500) [Ⓑ]	V
Signal output		Open collector output		Open collector output	—
	Output voltage	Max.	50 or less	40 or less	V
	Output current	Max.	80 or less	50 or less	mA
	Output pulse time width		10	10	ms
	Quenching time		Approx. 25	Approx. 18	ms
	Supply voltage (DC)		12 to 24	12 to 24	V
	Current consumption		4	6	mA
	Operating temperature range	Max.	-10 to +50	-10 to +100	°C
	Operating humidity range		Below 80 % (no condensation)	Below 80 % (no condensation)	—
	Dimensions (W × H × D)		50 × 12 × 36	45 × 9.8 × 33	mm

NOTE: [Ⓐ]Since the power impedance of the power supply is very high, the supply voltage cannot be measured with an ordinary voltmeter. A measuring instrument with a 10 GΩ or higher input impedance is necessary to measure high voltage.

[Ⓑ]The UVTRON supply voltage can be selected to match the UVTRON being used.

Related products

Suitable sockets (Unit: mm)

E678-9C

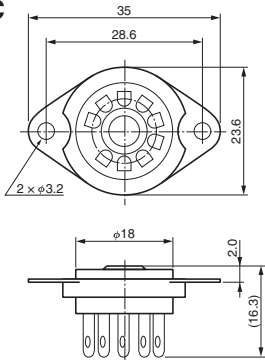

TACCA0283EA

E678-8F

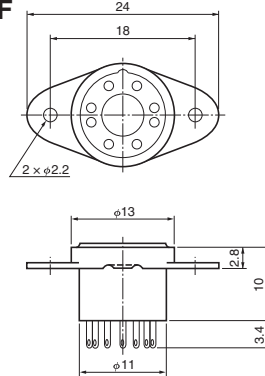

TACCA0289EA



▲(Left) E678-9C, (Right) E678-8F

Checker lamp for UVTRON UV source L9657-03

This is a lamp for checking the UVTRON operation. It has an appropriate spectrum for checking the UVTRON operation and can be incorporated with the UVTRON. Checking the UVTRON operation increases the reliability of security equipment.



▲L9657-03

Spectral distribution

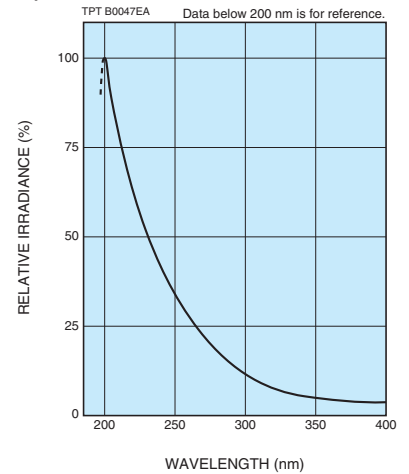

Parameter		Description / Value	Unit
Spectral distribution		185 to 400	nm
Window material		UV glass	—
Weight		Approx. 1	g
Maximum ratings	Supply voltage (DC)	600	V
	Peak current ①	200	μA
	Operating temperature range	-40 / +125	°C
	Storage temperature range	-20 / +60	°C
Recommended operating conditions and characteristics (at 25 °C)	Discharge starting voltage (DC) Max.	260	V
	Recommended supply voltage (DC)	300	V
	Recommended discharge current	150	μA
	Guaranteed life ②	1000	h

NOTE:

- ① Operating at a current higher than this value may drastically shorten the operating life.
- ② Life end is defined as the time that the radiant intensity falls to 50 % of its initial value.
- * Use in a dark environment may cause an operation delay longer than 0.5 seconds after a lamp-on command signal is received.

Checker lamp driver circuit C13428

This is a driver circuit for the UVTRON operation check light source (UV source L9657 series). The UV source can be turned on at a constant current of approximately 150 μA by applying a voltage between 5.5 V to 12 VDC. In addition, an LED lights momentarily when the lamp lights to help the UV source to turn on. When the lamp lights, the LED turns off.

GENERAL

Parameter	Description / Value	Unit
Supply voltage	+5.5 to +12	V
Current consumption	40	mA
Operating temperature range	-10 to +50	°C
Operating humidity range	80 or less	%
Storage temperature range	-10 to +50	°C
Lamp current	150 (Can be adjusted on the trimmer)	μA
Lamp not lit	LED lighting	—
Lamp lit	LED extinction	—
Dimensions (W × H × D)	45 × 4.5 × 33	mm



▲C13428

Precautions

■PRECAUTIONS

●About background

When a voltage is applied to the UVTRON, discharge may occasionally occur in the UVTRON even with no incidence of ultraviolet radiation. This phenomena is called background. Major causes of background are as follows:

①Radiations such as cosmic rays

Discharge may take place due to gas ionization inside the UVTRON which is caused by incident radiations such as alpha-rays, beta-rays, and gamma rays.

②Static electricity

If objects charged with static electricity are moved close to the UVTRON or touch it, the gas inside the UVTRON may become ionized by the high electric field, resulting in a discharge.

To prevent faulty operation caused by background, a properly designed signal processing circuit is required. For further details, refer to our technical publication or contact our sales office.

●About UV radiations in living environments

The UVTRON may operate by mistake when extraneous ultraviolet radiations enter it. There are many different ultraviolet radiation sources even in a daily life. The following list provides examples of ultraviolet sources that may be found in common circumstances.

①Sparks from arc welding (These emit very high ultraviolet radiations.)

②Electrical sparks (such as those by pantographs of an electric train and by a motor.)

③Sterilization lamps (such as low-pressure mercury lamps)

④Halogen lamps (such as display spotlights)

⑤Lamps with high color rendering properties such as xenon lamps and metal halide lamps

CAUTION: Since the UVTRON has very high sensitivity it, can detect even weak ultraviolet radiations leaking from unexpected sources. Therefore, sufficient care must be taken to eliminate extraneous ultraviolet radiations from the area where the UVTRON is installed.

●Humidity

Humidity around the leads for the UVTRON generates leak current, dropping the anode voltage, and stopping the tube from operating. In particular, if dirt, dust etc. get on the leads, that makes it easier for humidity to be absorbed, so keep the area around the leads clean.

●Protect the window of the UVTRON from stains

Contamination of the light input surface (window) with stains and dirt causes a reduction in the ultraviolet transmittance and a decrease in sensitivity. In handling the UVTRON, wear gloves to keep stains such as oil from your hands away from the window. After the UVTRON is installed into a unit, periodic cleaning of the window with gauze dipped in alcohol is suggested.

●Avoid heating the leads of the UVTRON

If leads of the UVTRON are heated to a high temperature, the glass bulb may crack or the electrodes may be adversely influenced, becoming the cause of faulty operation. For UVTRONS with hard pin leads, the use of special making sockets available from Hamamatsu is recommended. When soldering the UVTRON directly on a printed circuit board, it is recommended to use a pair of heat sink to pinch the root of the lead in order to avoid heat conduction to leads. The soldering process must be conducted below 350 °C within 5 seconds. Avoid using a solder tank for flow soldering, etc. After soldering, be sure to wipe off the soldering flux completely with alcohol, etc.

●Vibration and shock

The UVtron and the various driver circuits have passed the tests shown in the following table. But, if they are dropped or otherwise exposed to strong shock, the glass may break, the internal electrodes may deform, or the electrical characteristics may degrade. So handle them with great care. Further, if the lead wires are cut with a nipper or processed in other ways, the internal electrodes may be subject to vibration or shock exceeding the values in the following table. This may degrade the electrical characteristics in the same manner as when the UVtron is dropped.

		Vibration test (sine wave) IEC 60068-2-6	Shock test IEC 60068-2-27
UVTRON	R9454, R9533	3.0 mm peak to peak, 200 m/s ² , 10 Hz to 2000 Hz	10000 m/s ² , 1 ms
	Other	1.5 mm peak to peak, 100 m/s ² , 10 Hz to 500 Hz	1000 m/s ² , 11 ms
Driving circuit		0.7 mm peak to peak, 10 Hz to 55 Hz	1000 m/s ² , 11 ms

●Avoid connecting the UVTRON with reverse polarity

The UVTRON has an electrical polarity, an anode and a cathode. If the connection of these electrodes is reversed by mistake, it causes faulty operation. Be sure to connect these electrodes correctly, as indicated in the technical data sheet, etc.

●Avoid bending the leads of the UVTRON unnecessarily

Leads of the UVTRON are likely to break at the roots (the lead-to-glass sealing portions) due to oxidation at the time of glass sealing. When bending the leads, hold the roots with such as a pair of long-nose pliers and bend the forward portion. The leads may be bent (and bent back again) one time only.

●Operate the UVTRON within the optimum supply voltage range

The optimum supply voltage ranges are specified for each type of UVTRON. Operation at a supply voltage outside the optimum range may result in faulty operation. Be sure to operate the UVTRON within the optimum range of supply voltage, as specified in the technical data sheet.

■WARRANTY

The Hamamatsu UVTRONS are warranted to the original purchaser against defects in materials or workmanship for a period of one year following the date of delivery. This warranty is limited to replacement of defective products. This warranty shall not apply to faults or malfunctions in cases in which the product has been misused with regard to the precautions above or damaged by natural disaster.

* UVTRON is registered trademarks of HAMAMATSU PHOTONICS K.K..

Subject to local technical requirements and regulations, availability of products included in this promotional material may vary. Please consult with our sales office. Information furnished by HAMAMATSU is believed to be reliable. However, no responsibility is assumed for possible inaccuracies or omissions. Specifications are subject to change without notice. No patent rights are granted to any of the circuits described herein. ©2020 Hamamatsu Photonics K.K.

HAMAMATSU PHOTONICS K.K. www.hamamatsu.com

Electron Tube Division

314-5, Shimokanzo, Iwata City, Shizuoka Pref., 438-0193, Japan, Telephone: (81)539/62-5248, Fax: (81)539/62-2205

U.S.A.: Hamamatsu Corporation; 360 Foothill Road, Bridgewater, NJ 08807, U.S.A., Telephone: (1)908-231-0960, Fax: (1)908-231-1218 E-mail: usa@hamamatsu.com

Germany: Hamamatsu Photonics Deutschland GmbH; Arzbergerstr. 10, D-82211 Herrsching am Ammersee, Germany, Telephone: (49)8152-375-0, Fax: (49)8152-265-8 E-mail: info@hamamatsu.de

France: Hamamatsu Photonics France S.A.R.L.; 19, Rue du Saule Trapu, Parc du Moulin de Massy, 91882 Massy Cedex, France, Telephone: (33)1 69 53 71 00, Fax: (33)1 69 53 71 10 E-mail: infos@hamamatsu.fr

United Kingdom: Hamamatsu Photonics UK Limited; 2 Howard Court, 10 Tewin Road, Welwyn Garden City, Hertfordshire AL7 1BW, UK, Telephone: (44)1707-294888, Fax: (44)1707-325777 E-mail: info@hamamatsu.co.uk

North Europe: Hamamatsu Photonics Norden AB; Torshamnsgatan 35 16440 Kista, Sweden, Telephone: (46)8-509 031 00, Fax: (46)8-509 031 01 E-mail: info@hamamatsu.se

Italy: Hamamatsu Photonics Italia S.r.l.; Strada della Moia, 1 int. 6, 20020 Arese (Milano), Italy, Telephone: (39)02-93 58 17 33, Fax: (39)02-93 58 17 41 E-mail: info@hamamatsu.it

China: Hamamatsu Photonics (China) Co., Ltd.; 1201 Tower B, Jianning Center, 27 Dongsanhuang Beilu, Chaoyang District, 100020 Beijing, P.R. China, Telephone: (86)10-6586-6006, Fax: (86)10-6586-2866 E-mail: hpc@hamamatsu.com.cn

Taiwan: Hamamatsu Photonics Taiwan Co., Ltd.; 8F-3, No.158, Section 2, Gongdao 5th Road, East District, Hsinchu, 300, Taiwan R.O.C. Telephone: (886)3-659-0080, Fax: (886)3-659-0081 E-mail: info@hamamatsu.com.tw

TPT 1034E06
AUG. 2020 IP