



# Signal Analyzer MS2830A

3.6 GHz Signal Analyzer MS2830A-040

6 GHz Signal Analyzer MS2830A-041

13.5 GHz Signal Analyzer MS2830A-043

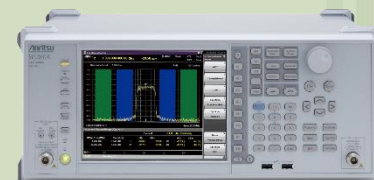

Refer to the dedicated product introduction materials for the 26.5 GHz Signal Analyzer MS2830A-044 and 44.5 GHz Signal Analyzer MS2830A-045.

Version 17.0

The MS2830A is a high-speed, high-performance, cost-effective Spectrum Analyzer/Signal Analyzer. Not only can it capture wideband signals but FFT technology supports multifunction vector signal analyses (VSA) in both the time and frequency domains. Behavior in the time domain that cannot be handled by a sweep type spectrum analyzer can be checked in the frequency domain. A wide frequency can be analyzed using sweep type spectrum analysis functions while detailed signal analysis of a specific frequency band is supported too.

Moreover, the built-in vector signal generator (VSG) function outputs both continuous wave (CW) and modulated signals for use as a reference signal source when testing Tx characteristics of parts and as a signal source for evaluating Rx characteristics.

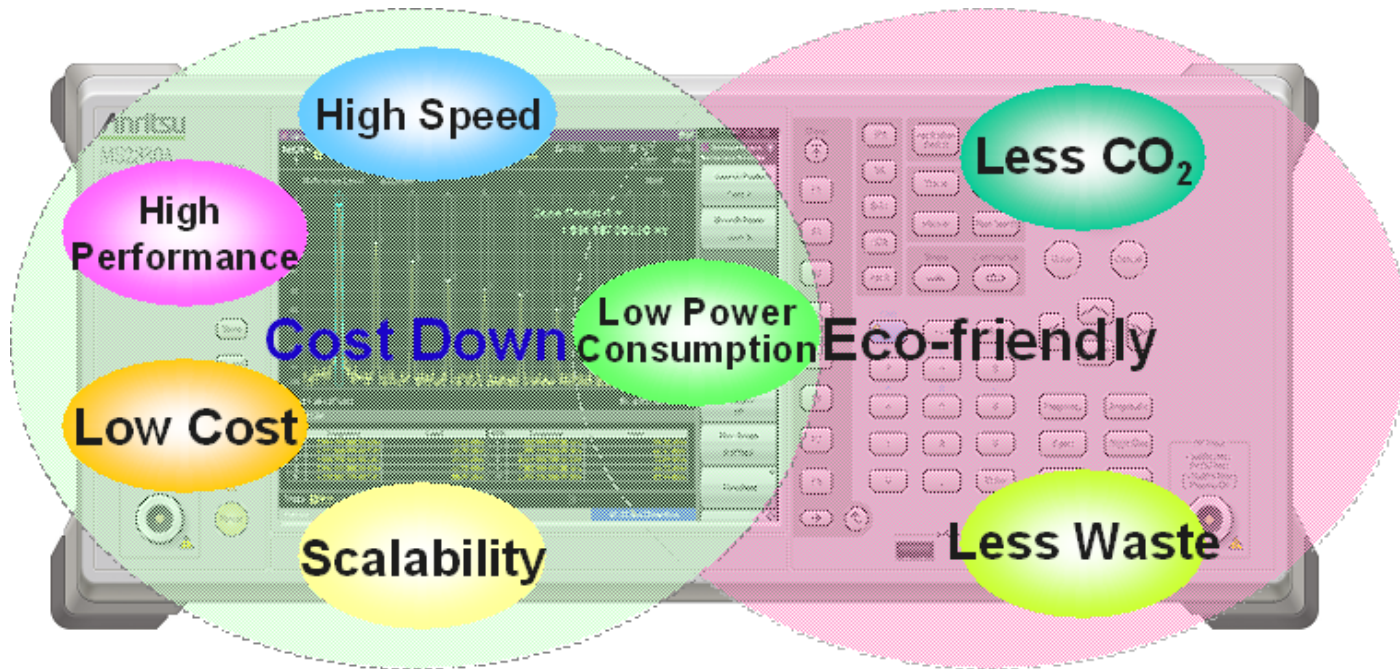

# Key Signal Analyzer MS2830A Features

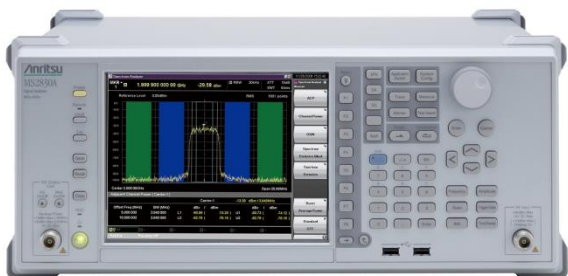

MS2830A-040: 9 kHz to 3.6 GHz  
MS2830A-041: 9 kHz to 6.0 GHz  
MS2830A-043: 9 kHz to 13.5 GHz

## 10 Times Faster

- ◆ Local measurement and display update : 2.1 ms (SWT:1ms)  
: 0.7 ms (SWT:100us)
- ◆ Remote measurement and LAN transfer : 4.0 ms
- ◆ Marker peak search: 1.5 ms
- ◆ Center frequency tune + sweep + sweep data transfer: 12ms (RF/Micro band)

## High RF Performance

- ◆ Displayed Avg. Noise Level: -153 dBm/Hz (30 MHz to 1 GHz)
- ◆ TOI : +15 dBm (300 MHz to 3.5 GHz)
- ◆ Total Level Accuracy:  $\pm 0.3$  dB typ. (300 kHz to 4.0 GHz)

## Low Cost Plus High Performance

- ◆ High-end RF performance at low-end price
- ◆ All-in-one spectrum analyzer and signal generator cuts costs by 30%

## Low Power Consumption

110 VA (nominal) for 3.6/6 GHz SPA configuration

## Excellent Expandability Options

Flexible configuration from basic spectrum analyzer to TRx all-in-one solution using options

### -Analysis Bandwidth Option-

- MS2830A-005: Analysis Bandwidth Extension to 31.25 MHz
- MS2830A-006: Analysis Bandwidth 10 MHz
- MS2830A-077: Analysis Bandwidth Extension to 62.5 MHz\*
- MS2830A-078: Analysis Bandwidth Extension to 125 MHz\*

\*Note) MS2830A-077/078: An image response is received when setting the bandwidth to more than 31.25 MHz. This can be used when not inputting a signal frequency outside the MS2830A analysis bandwidth (125 MHz max.). The Signal Analyzer MS2690A is recommended for other measurement purposes.

### -Low Phase Noise Performance Option-

- MS2830A-066: Low Phase Noise Performance

### -Signal Generator Option-

- MS2830A-020: 3.6 GHz Vector Signal Generator
- MS2830A-021: 6 GHz Vector Signal Generator
- MS2830A-088: 3.6GHz Analog Signal Generator
- MS2830A-052: Internal Signal Generator Control Function

### -Noise Figure Measurement Option-

- MS2830A-017: Noise Figure Measurement Function

### -Audio Analyzer Option-

- MS2830A-018: Audio Analyzer

### -BER Measurement Function Option-

- MS2830A-026: BER Measurement Function

The Signal Analyzer MS2830A supports very high-speed spectrum analyzer functions, such as sweeping and frequency switching time. Using the VSA mode with advanced DSP and FFT technologies cuts in-band and out-of-band spurious measurement times by 90% (cf previous Anritsu instruments) to greatly improve manufacturing and adjustment throughput.

## Cuts tact time and improves adjustment efficiency

### Best-of-class measurement speed (SPA Mode)

- ◆ Local measurement and display update : 2.1 ms (SWT: 1 ms)  
: 0.7 ms (SWT: 100 us)
- ◆ Remote measurement and LAN transfer : 4.0 ms
- ◆ Marker peak search: 1.5 ms
- ◆ Center frequency tune + sweep + sweep data transfer: 12ms  
(RF/Micro band)

The above times are for real measurements based on Anritsu measurement conditions. They are not guaranteed specifications.  
Actual measurement times vary with the PC and measurement conditions.



### Faster speed (VSA Mode)

High-speed, in-band  
measurements up to  
125 MHz bandwidth

The MS2830A performs in-band measurements, such as ACP, OBW and Channel Power, many times faster than sweep spectrum analyzers by using FFT batch capture and analysis over a 125 MHz bandwidth and measurement interval.

# Level calibration performance

High  
Performance

The MS2830A use built-in calibrator offers excellent total level accuracy of  $\pm 0.3$  dB (typ.) at 300 kHz to 4 GHz.

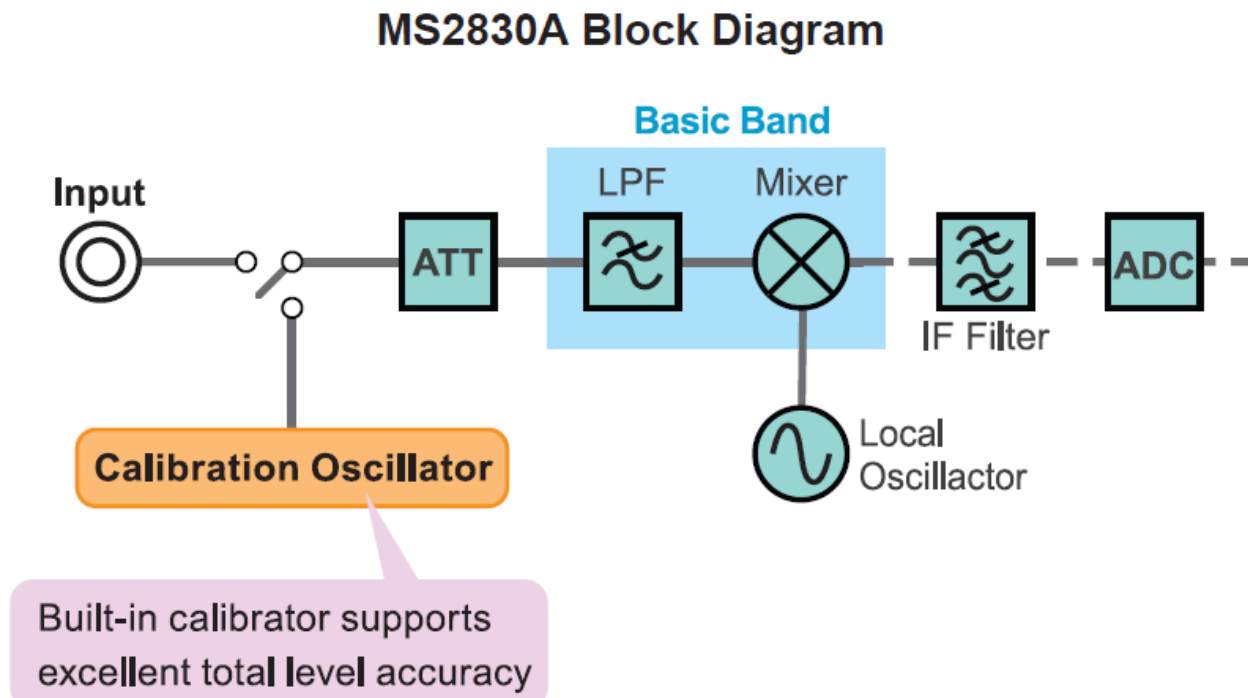

# High RF Performance Improves Yield

High Performance

Excellent  $\pm 0.3$  dB (typ.) absolute level accuracy and high 168 dB dynamic range improve yield by eliminating false-negative evaluation errors at distortion and spurious measurements.

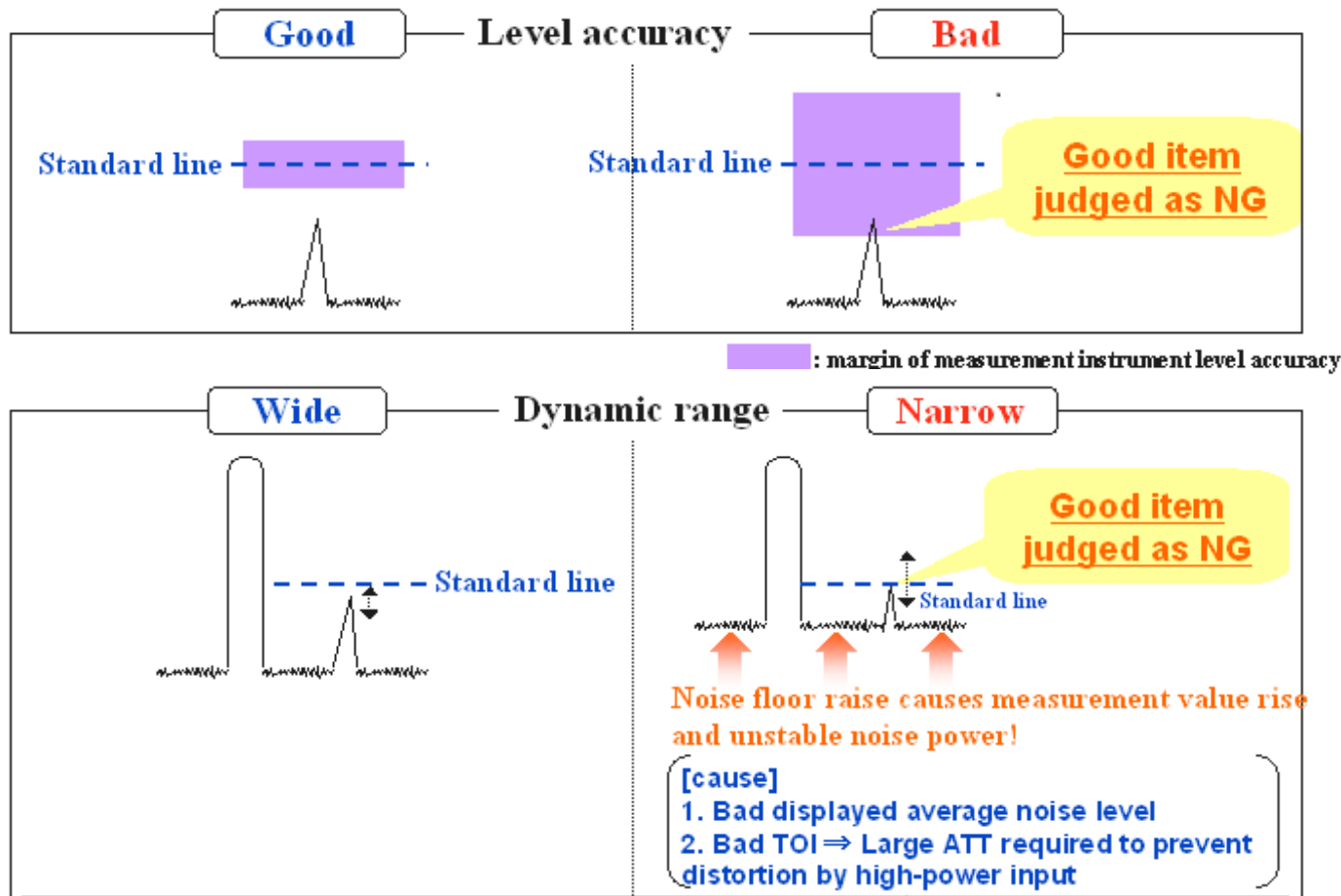

# Low-Cost Plus High-Performance

Low Cost

The all-in-one SA + SG configuration costs 30% less than combining a standalone SA and SG.

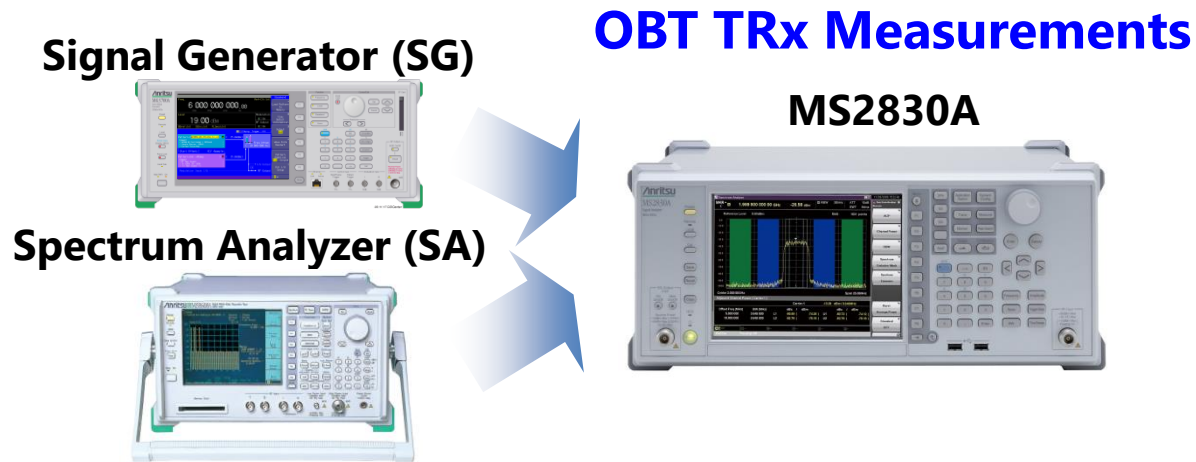

**30% Lower Cost**

Supports easy configuration of measurement systems and saves bench space, initial investment, and running costs (calibration and power consumption)



# Optimum Current and Future Capital Investment

Scalability

The MS2830A has various options to support continuously evolving wireless systems. It supports expansion from the base configuration with the spectrum analyzer to an all-in-one TRx tester as needed. Functions required now and sometime in the future are supported at minimum cost.

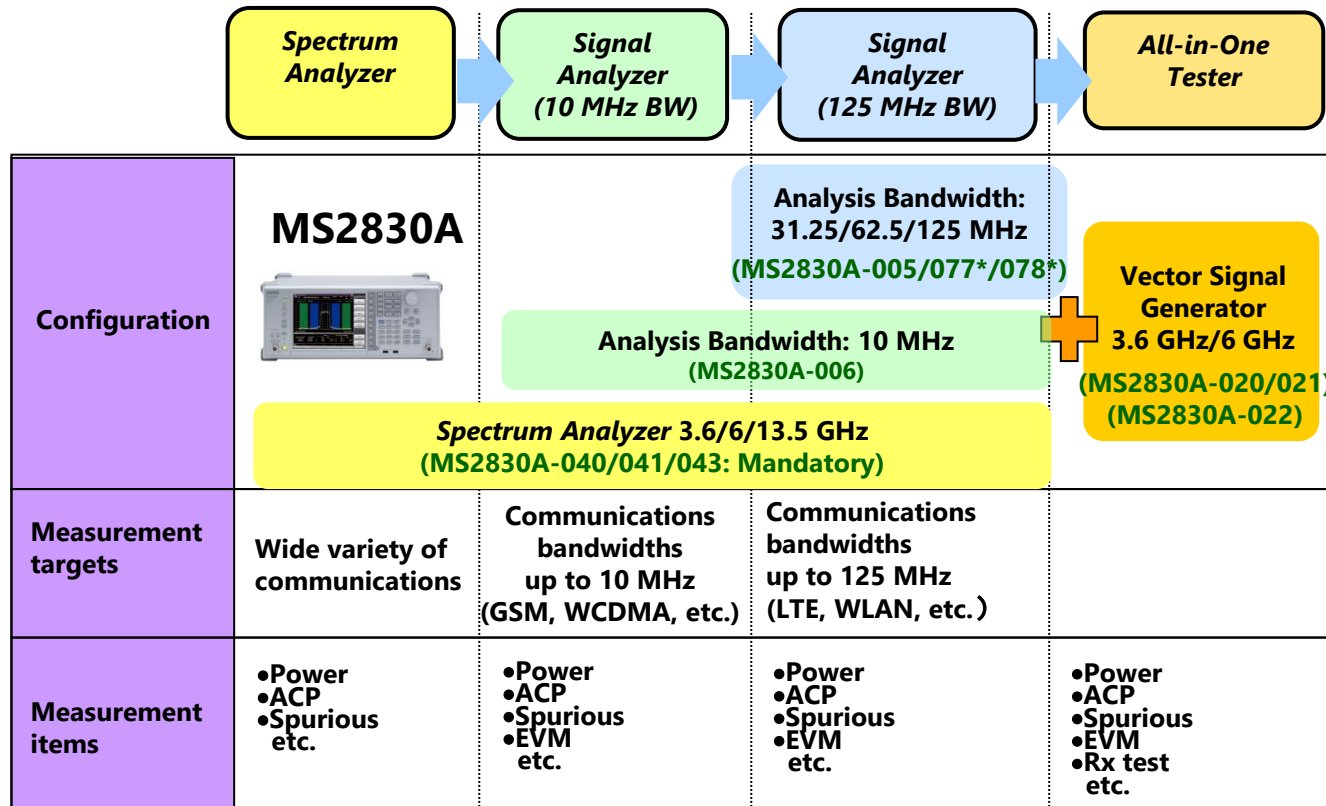

\*Note) MS2830A-077/078:

An image response is received when setting the bandwidth to more than 31.25 MHz. This can be used when not inputting a signal frequency outside the MS2830A analysis bandwidth (125 MHz max.). The Signal Analyzer MS2690A is recommended for other measurement purposes.



### ◆ MS2830A-066 Low Phase Noise Performance Option

Phase noise performance is increasingly important at carrier offsets of 1 kHz to 100 kHz. Spectrum analyzer phase noise performance affects ACLR/MASK measurements at narrowband communications. (Channel bandwidth : <100 kHz)  
**Add MS2830A-066 when required by the specifications.**

#### Frequency Range:

9 kHz to 3.7 GHz

(Frequency band mode:\* Normal)

9 kHz to 3.5 GHz

(Frequency band mode:\* Spurious)

\*: Requires MS2830A-041/043 for setting.

#### Span:

300 Hz to 1 MHz (Spectrum Analyzer)

1 kHz to 31.25 MHz (Signal Analyzer)

MS2830A-066 cannot be retrofitted

MS2830A-066 sometimes cannot be installed depending on options.

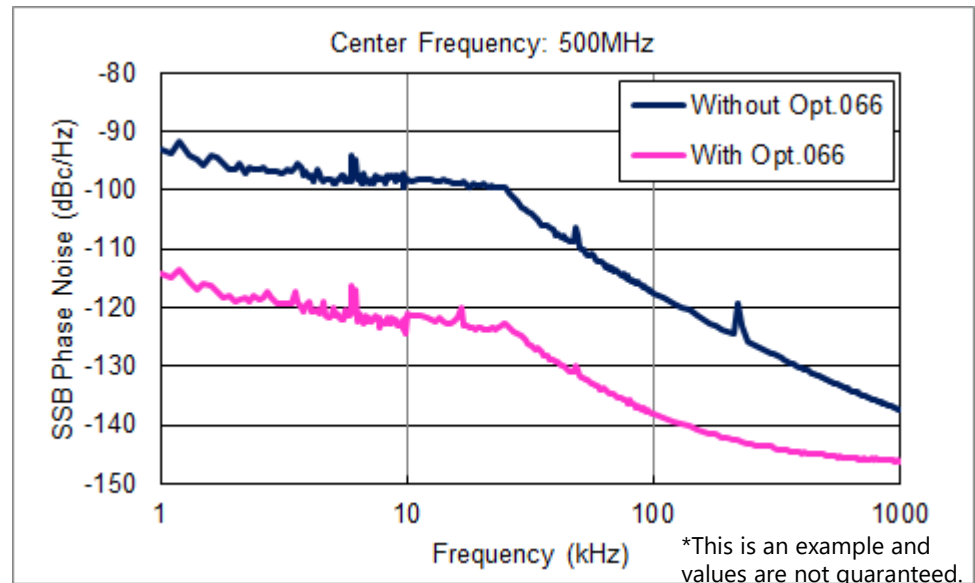

Model	Case 1	Case2	Case 3
MS2830A-020/021	Yes	Yes	No
MS2830A-043	Yes	No	Yes
MS2830A-066	No	Yes	Yes

# Low Power Consumption

Low Power Consumption

The MS2830A consumes just  $\leq 110$  W, cutting power by 45% compared to current models and reducing electricity consumption directly and indirectly through lower air conditioning costs. CO<sub>2</sub> emissions are reduced too.

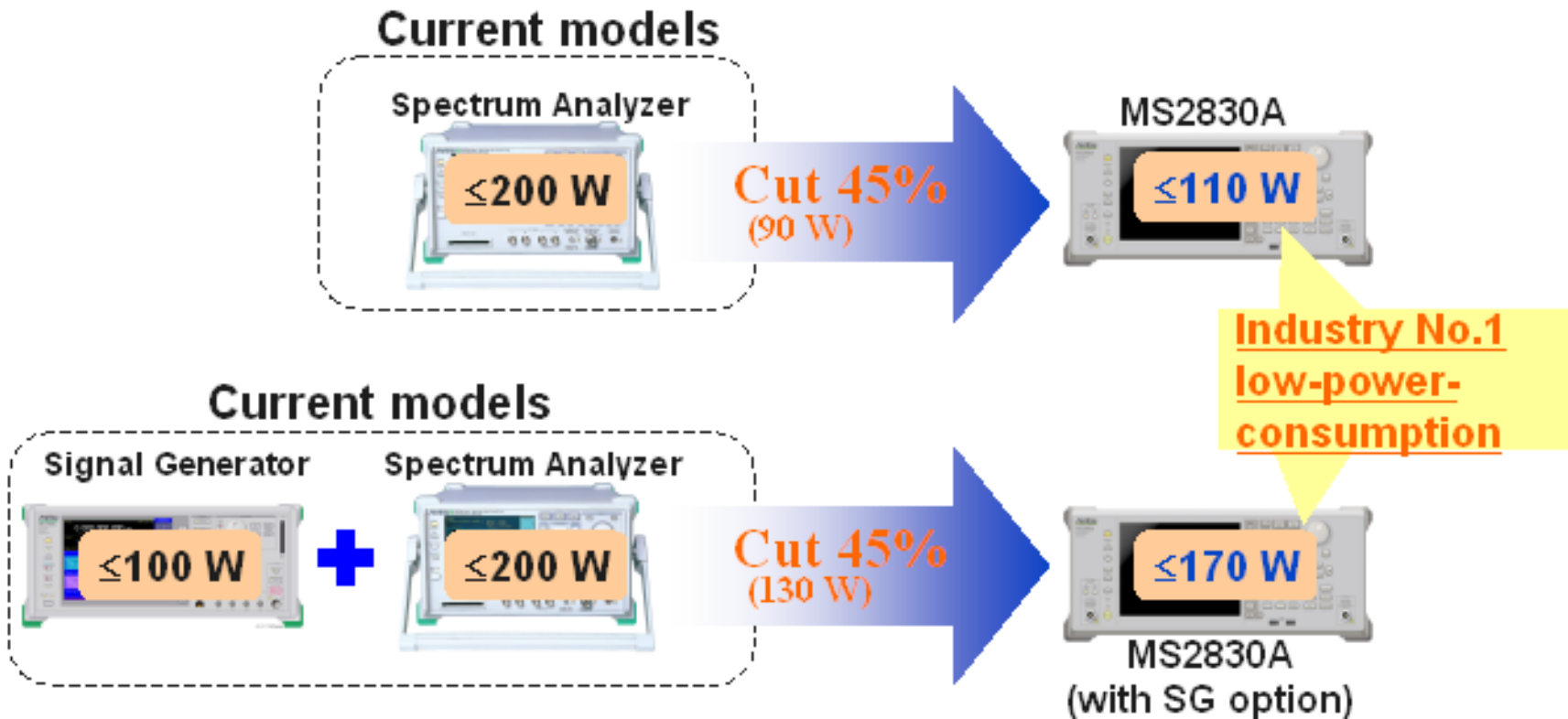

# Various Measurement Functions and Software

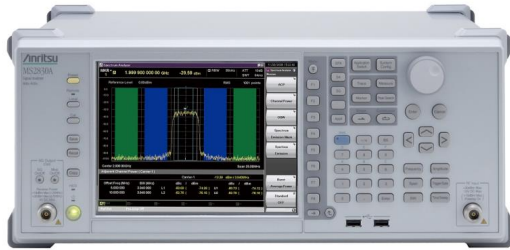

## Digitize function

**(MS2830A-005/006/077/078)**

Saves and input signals as IQ data files for re-analysis with VSA function

## VSA function

**(MS2830A-005/006/077/078)**

Seamless signal capture and analysis in multiple domains

## Measurement

**software (MX2690xxA)**

Covers modulation analysis of various communication systems from cellular systems, such as GSM, WCDMA, and LTE to GP analysis software.

## Options

### **-Analysis Bandwidth Option-**

**MS2830A-005 Analysis Bandwidth Extension to 31.25 MHz**

**MS2830A-006 Analysis Bandwidth 10 MHz**

**MS2830A-077 Analysis Bandwidth Extension to 62.5 MHz\***

**MS2830A-078 Analysis Bandwidth Extension to 125 MHz\***

\*Note) MS2830A-077/078: An image response is received when setting the bandwidth to more than 31.25 MHz. This can be used when not inputting a signal frequency outside the MS2830A analysis bandwidth (125 MHz max.). The Signal Analyzer MS2690A is recommended for other measurement purposes.

### **-Signal Generator Option-**

**MS2830A-020 3.6 GHz Vector Signal Generator**

**MS2830A-021 6 GHz Vector Signal Generator**

**MS2830A-088 3.6GHz Analog Signal Generator**

## Vector Signal Generator (MS2830A-020/021 and others)

Covers frequency range from 250 kHz to 3.6 GHz/

6 GHz with 120-MHz wideband vector modulation bandwidth.

## Other useful functions

◆ Measure function

(SPA as standard, VSA function via MS2830A-005/006/077/078)

◆ Phase Noise Measurement function (MS2830A-010)

◆ Noise Figure Measurement function (MS2830A-017)

◆ Audio Analyzer function (MS2830A-018)

◆ BER Measurement function (MS2830A-026)

◆ Internal Signal Generator Control Function (MS2830A-052)

# Digitize: Wideband and High Accuracy Waveform Capture

## Captures wideband waveforms up to 125 MHz with accuracy of $\pm 0.3$ dB

Based on the excellent level accuracy and wide dynamic range of the MS2830A, a signal with an FFT analysis bandwidth of up to 125 MHz can be captured with a level accuracy of  $\pm 0.3$  dB typ.

Max. Capture Time: 0.5 s to 2000 s  
 Max. Number of Samples: 100 Msamples

Span*	Sampling Rate	Capture Time	Max. Sampling Data
1 kHz	2 kHz	2000 s	4M
2.5 kHz	5 kHz	2000 s	10M
5 kHz	10 kHz	2000 s	20M
10 kHz	20 kHz	2000 s	40M
25 kHz	50 kHz	2000 s	100M
50 kHz	100 kHz	1000 s	100M
100 kHz	200 kHz	500 s	100M
250 kHz	500 kHz	200 s	100M
500 kHz	1 MHz	100 s	100M
1 MHz	2 MHz	50 s	100M
2.5 MHz	5 MHz	20 s	100M
5 MHz	10 MHz	10 s	100M
10 MHz	20 MHz	5 s	100M
25 MHz	50 MHz	2 s	100M
31.25 MHz	50 MHz	2 s	100M
50 MHz	100 MHz	500 ms	50M
62.5 MHz	100 MHz	500 ms	50M
100 MHz	200 MHz	500 ms	100M
125 MHz	200 MHz	500 ms	100M

\*: With MS2830A-006: 1 kHz to 10 MHz  
 With MS2830A-005/006: 1 kHz to 31.25 MHz  
 With MS2830A-005/006/077: 1 kHz to 62.5 MHz  
 With MS2830A-005/006/077/078: 1 kHz to 125 MHz

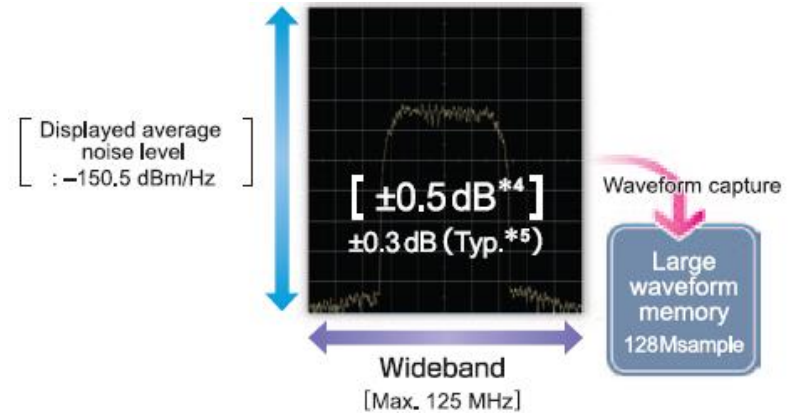

MS2830A-006: 10 MHz max.  
 (20 MHz max. sampling rate = 50 ns resolution, ADC resolution 16 bits)  
 MS2830A-005\*1: 31.25 MHz max.  
 (50 MHz max. sampling rate = 20 ns resolution, ADC resolution 16 bits)  
 MS2830A-077\*2: 62.5 MHz max.  
 (100 MHz max. sampling rate = 10 ns resolution, ADC resolution 14 bits)  
 MS2830A-078\*3: 125 MHz max.  
 (200 MHz max. sampling rate = 5 ns resolution, ADC resolution 14 bits)  
 Note) MS2830A--077/078: An image response is received when setting the bandwidth to more than 31.25 MHz. This can be used when not inputting a signal frequency outside the MS2830A analysis bandwidth (125 MHz max.). The Signal Analyzer MS2690A is recommended for other measurement purposes.

\*1: Requires MS2830A-006.  
 \*2: Requires MS2830A-005 and 006.  
 \*3: Requires MS2830A-005, 006 and 077.  
 \*4:  $300 \text{ kHz} \leq f < 4 \text{ GHz}$ , Frequency band mode Normal.  
 \*5: Excluding Guard Band.

# Digitize: Calibration-Free Waveform Capture

## No need for calibration block at analysis tool side

The MS2830A has built-in **amplitude/phase calibration circuits** to automatically calibrate **internal errors**.

Captured waveform data are saved to the built-in hard disk and can be output to an external PC via 1000BASE-T.

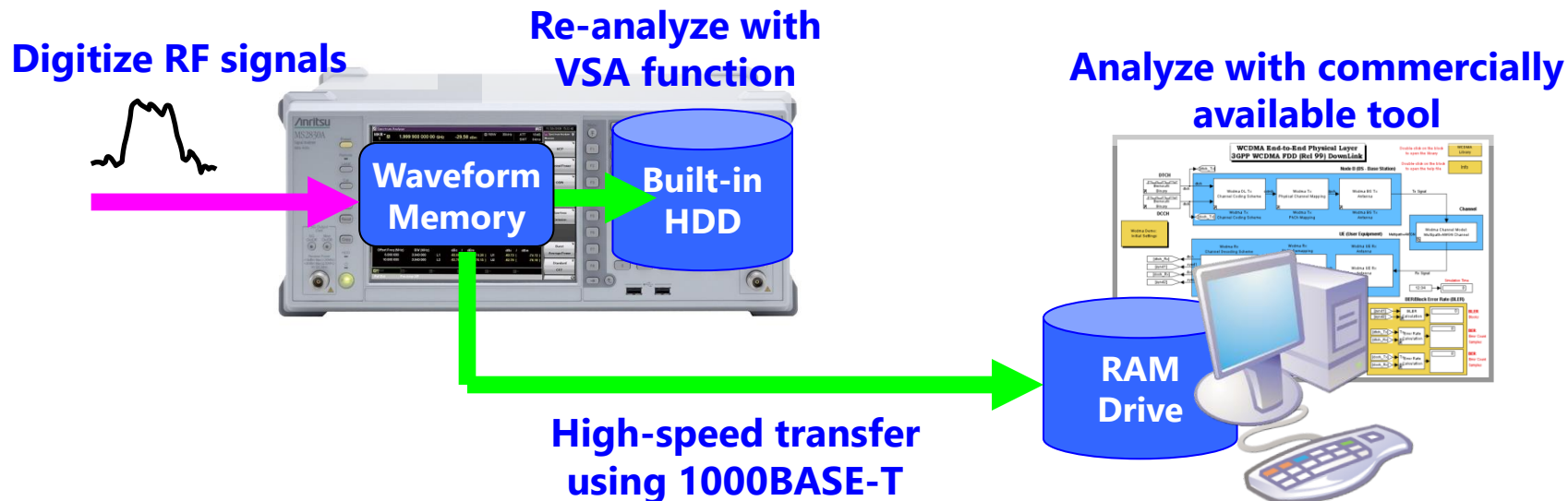

# VSA: Multi-domain Analysis of Captured Signals

## Display captured waveforms in various domains

### Frequency vs. Time

Measures FSK and GMSK modulation wave frequency variation, and VCO frequency switching time

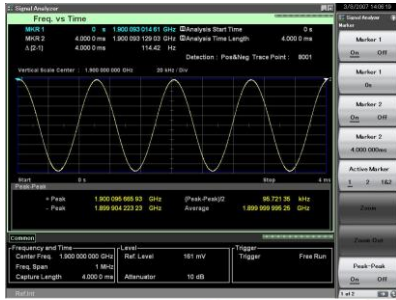

### Phase vs. Time

Monitors time fluctuations of phase to check sudden phase shift

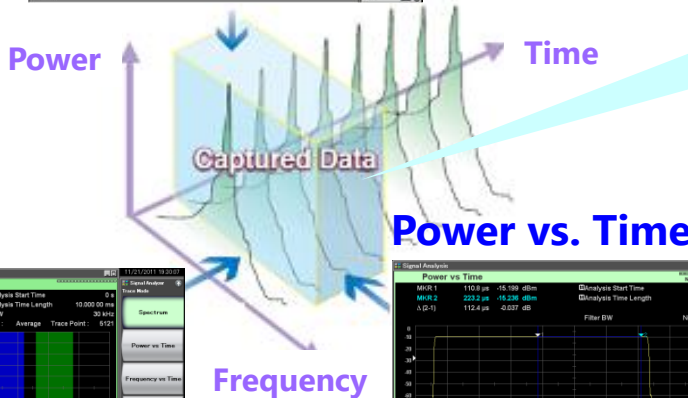
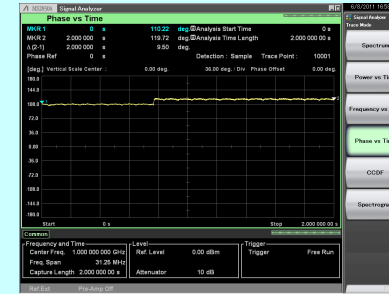

### Spectrum



Displays waveform of wideband SPAN up to 125 MHz without interruption

### Power vs. Time

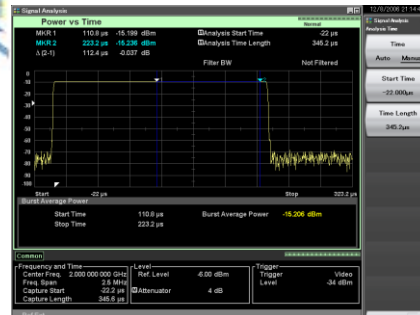

Supports wideband CCDF analysis up to 31.25 MHz; useful for evaluating power amplifiers in wideband communications systems

### Spectrogram

Displays spectrum variations with time; useful for understanding waveform transients because supports visual monitoring of frequency and level time variations



### CCDF/APD

Supports wideband CCDF analysis up to 125 MHz and ideal for evaluating power amps for wideband communication systems

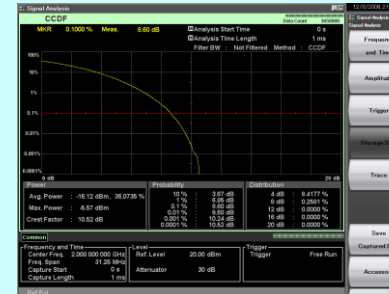



# VSA: Intuitive Split-Screen Display

Various VSA analyses can be performed on the main trace by specifying analysis segments on the sub-trace. Intuitive analysis focusing on signal-on/rising/falling, etc., parts is made easy by observing signal distributions on the sub-trace.

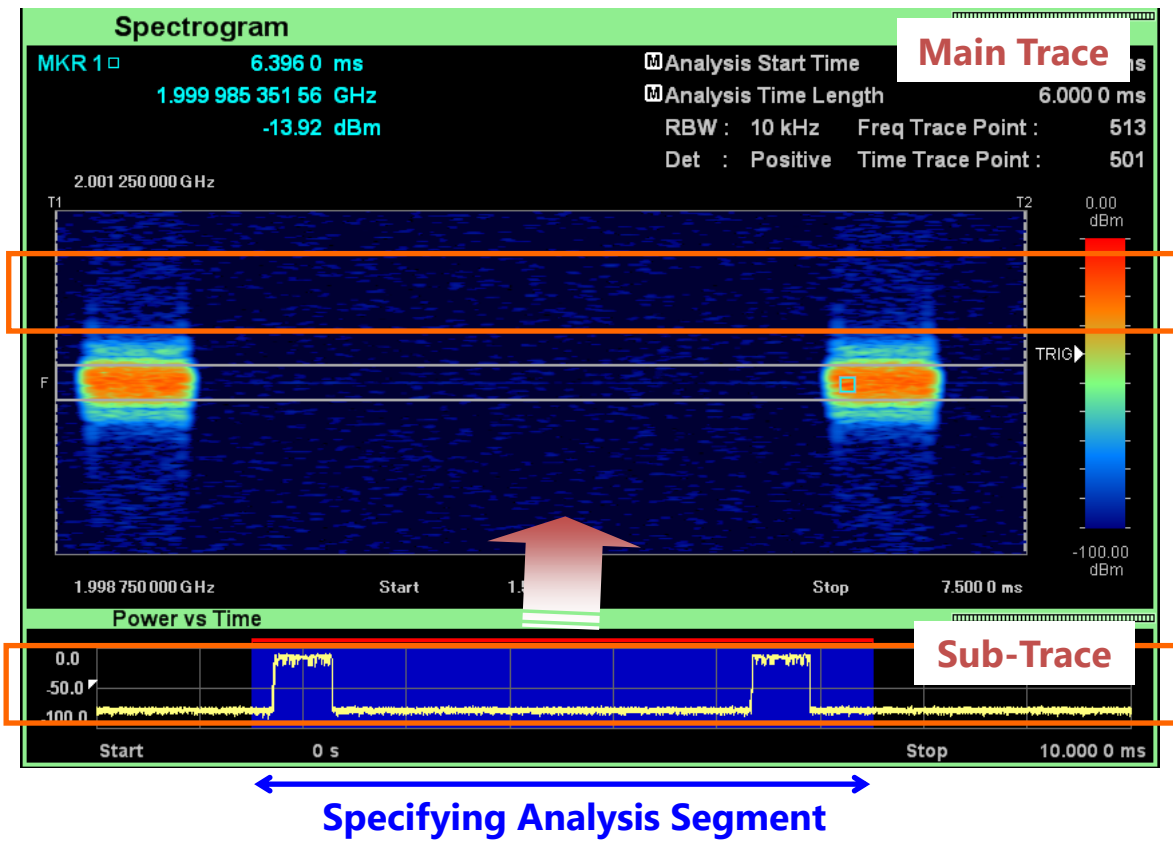

## Main Trace

- ◆ Spectrum
- ◆ Power vs. Time
- ◆ Frequency vs. Time
- ◆ Phase vs. time
- ◆ CCDF/APD
- ◆ Spectrogram

## Sub-trace

- ◆ Power vs. Time
- ◆ Spectrogram



# VSA: One-Step Observation of Rising/Falling Signals

Changing the analysis segment at the sub-trace permits frame-by-frame replay of the spectrum at the main trace.

This function supports troubleshooting by frame-by-frame replay of transient burst responses and generation of unwanted spurious in captured RF signals.

Changing the analysis section supports frame-by-frame replay of the rising signal.

## Sub-Trace (Spectrogram)

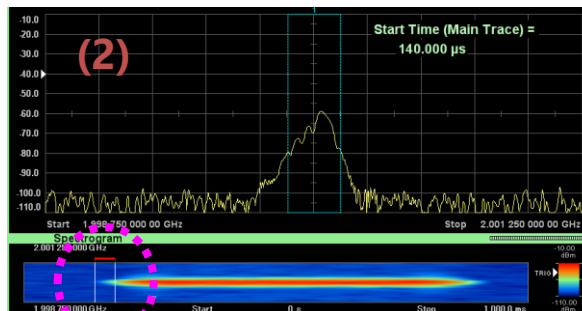
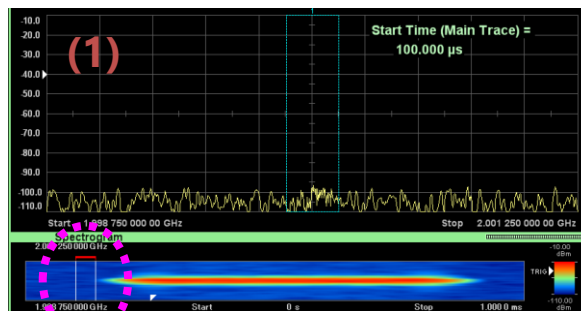
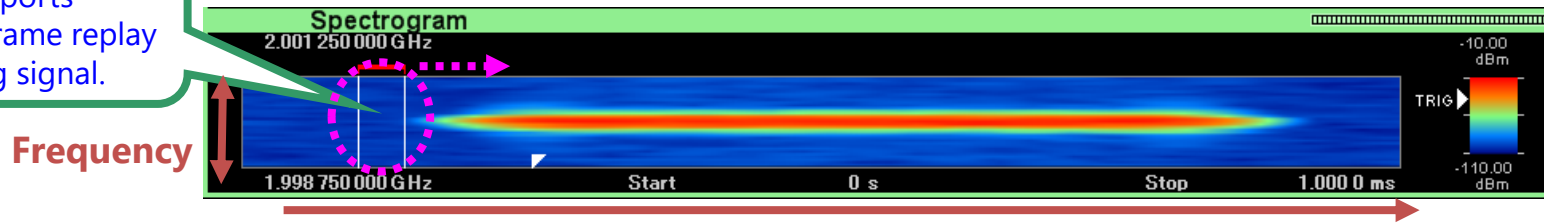

# VSA: Useful Replay Function for Comparative Verification

Captured waveforms can be replayed again by using the VSA function to read saved digitize data. This is convenient for comparing performance of each DUT test phase using digitized data as well as for troubleshooting post- shipment product faults

## Digitize Data File Selection Screen

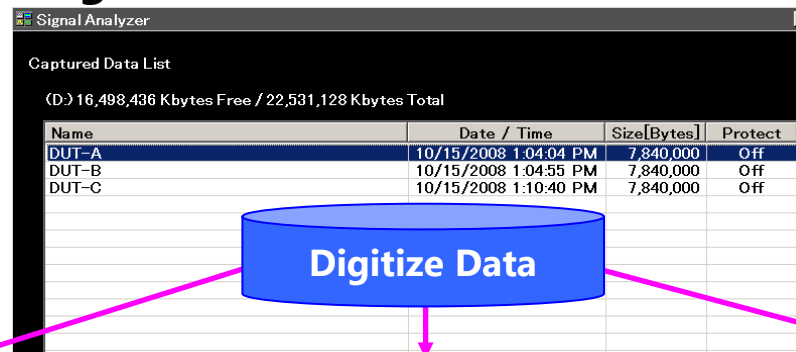

DUT (A)

DUT (B)

DUT (C)

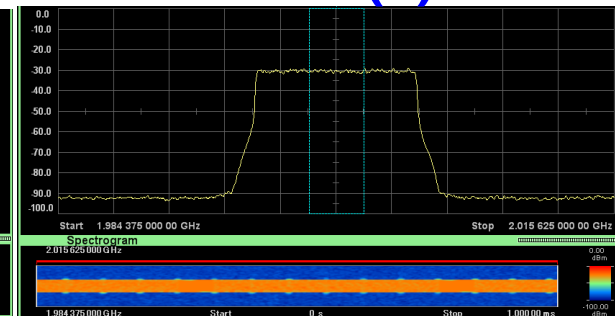
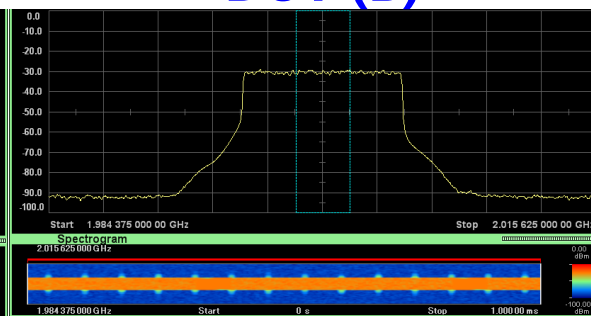
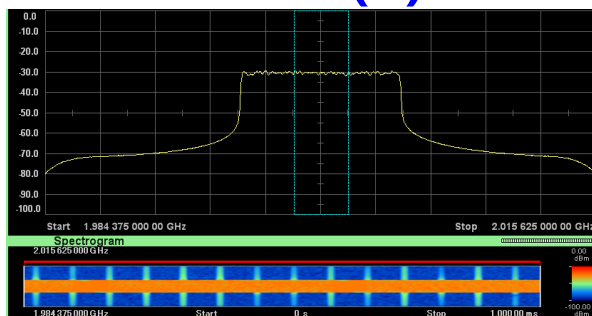

# VSA: Flexible File Save Function

Captured data can be saved to a file by specifying the Analysis Time range (display range of main trace) or any time. The amount of saved data and later workload are cut because only required segments are captured and saved to a file.

**Example: Capture 20 ms and save only one burst (600  $\mu$ s) of GSM signal to file.**

**Save required segment to file.**

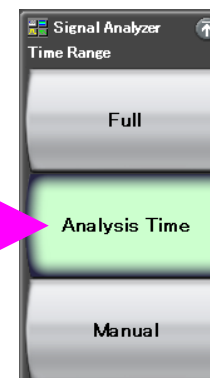
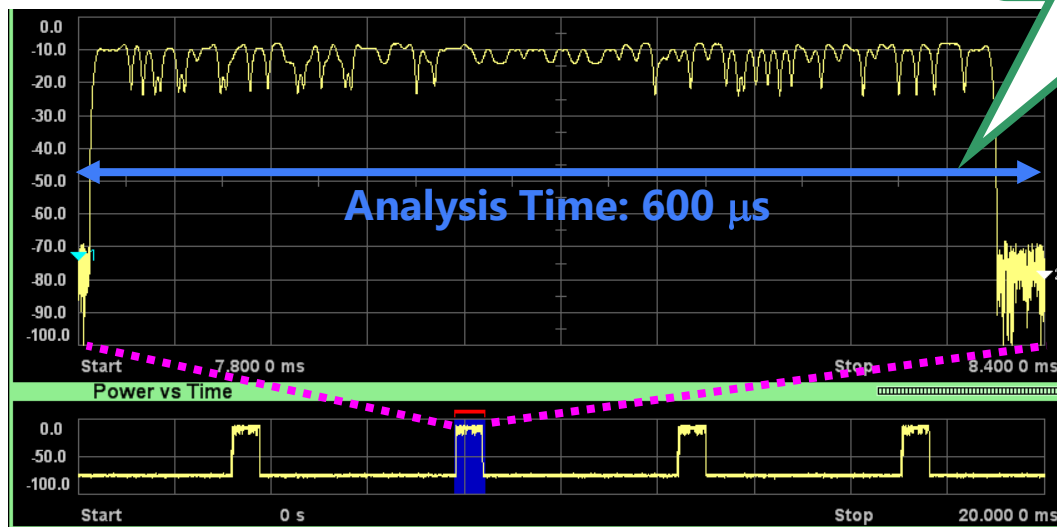

**Save total capture time.**

**Save data specified by Analysis Time.**

**Save time-specified data.**

**Analysis Time: 600  $\mu$ s**

**Capture time: 20 ms**

# VSA: FFT Analysis for Ultra-High-Speed Advantage

Supports measurements many times faster than a sweep spectrum analyzer by using the signal analyzer mode, which performs FFT analysis.

## Spectrum Analyzer

SPAN 25 MHz  
RBW 30 kHz

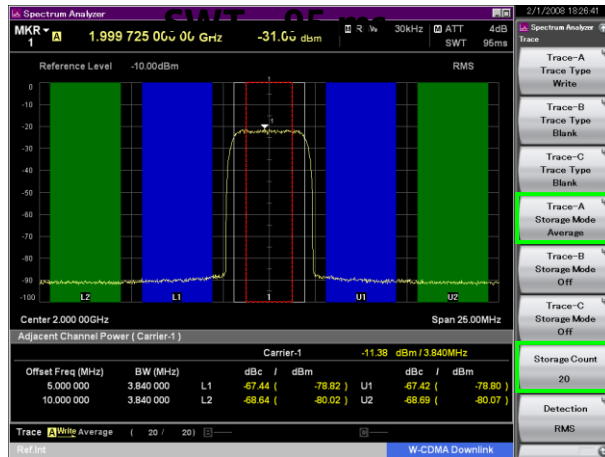

20 Averagings

Measurement Time 2.6 s\*

## Signal Analyzer

SPAN 25 MHz  
RBW 30 kHz  
Analysis Length 95  $\mu$ s



20 Averagings

Measurement Time 0.3 s

SPAN 25 MHz  
RBW 30 kHz  
Analysis Length 1900  $\mu$ s



Batch Capture 20 Times

Measurement Time 0.04 s

8 Times Faster

65 Times Ultra Fast

\*: Spectrum Analyzer measurement times measured with the MS269xA.

# VSA Function: No Trace Mode

No Trace mode does not execute signal analysis. Therefore, “IQ data output” and “IQ data readout using remote commands” can be executed quickly without the need to wait for completion of analysis.

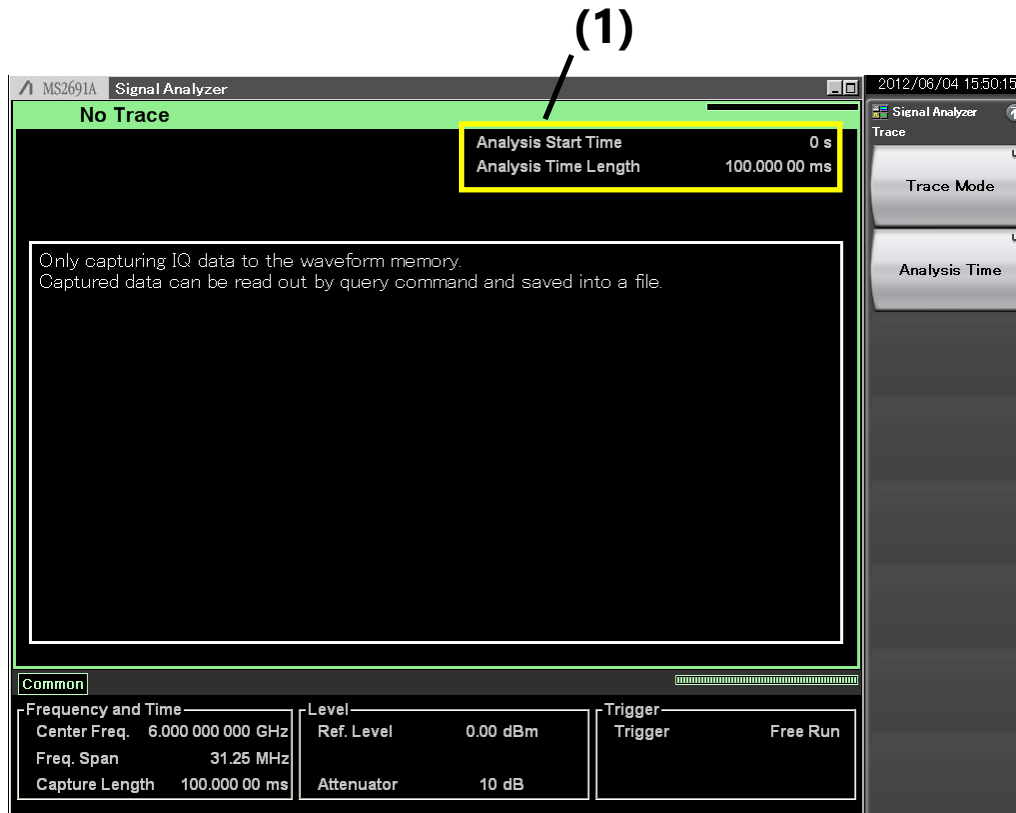

	Analysis Start Time Analysis Time Length
(1)	Displays “Analysis Start Time” and “Analysis Time Length”.

\*: As analysis is not executed, Save Waveform function for saving waveform data cannot be used.

# Measurement Software: Various Communications Systems

## Measurement Software

**Modulation analysis of various communication systems from cellular system, such as GSM, WCDMA, and LTE to GP analysis software is all supported.** See each measurement software catalog for more details.

Communications Systems	Model	Name	Addition to Main frame (✓: Can be installed, No: Cannot be installed)		Analysis Bandwidth Extension Option (✓: Required, ✓+: Function expansion, Space (no symbol): No specification)			
			Opt. 040/041/043	Opt. 044/045	Opt. 006	Opt. 005/009	Opt. 077	Opt. 078
LTE/LTE-Advanced (FDD)	MX269020A	LTE Downlink Measurement Software	✓	✓	✓	✓		
	MX269020A-001	LTE-Advanced FDD Downlink Measurement Software	✓	✓	✓	✓	✓+	✓+
	MX269021A	LTE Uplink Measurement Software	✓	✓	✓	✓		
	MX269021A-001	LTE-Advanced FDD Uplink Measurement Software	✓	✓	✓	✓	✓+	✓+
LTE/LTE-Advanced (TDD)	MX269022A	LTE TDD Downlink Measurement Software	✓	✓	✓	✓		
	MX269022A-001	LTE-Advanced TDD Downlink Measurement Software	✓	✓	✓	✓	✓+	✓+
	MX269023A	LTE TDD Uplink Measurement Software	✓	✓	✓	✓		
	MX269023A-001	LTE-Advanced TDD Uplink Measurement Software	✓	✓	✓	✓	✓+	✓+
W-CDMA/HSPA/ HSPA Evolution	MX269011A	W-CDMA/HSPA Downlink Measurement Software	✓	✓	✓			
	MX269012A	W-CDMA/HSPA Uplink Measurement Software	✓	✓	✓			
W-CDMA/HSPA (Downlink)	MX269030A	W-CDMA BS Measurement Software	✓	✓	✓			
TD-SCDMA	MX269015A	TD-SCDMA Measurement Software	✓	✓	✓			
CDMA2000	MX269024A	CDMA2000 Forward Link Measurement Software	✓	✓	✓			
	MX269024A-001	All Measure Function	✓	✓	✓			
1xEV-DO	MX269026A	EV-DO Forward Link Measurement Software	✓	✓	✓			
	MX269026A-001	All Measure Function	✓	✓	✓			
GSM/EDGE	MX269013A	GSM/EDGE Measurement Software	✓	✓	✓			
EDGE Evolution	MX269013A-001	EDGE Evolution Measurement Software	✓	✓	✓			
World Digital Wireless Standards	MX269017A	Vector Modulation Analysis Software	✓	✓	✓	✓+	✓+	✓+
Analog (FM/ΦM/AM)	MX269018A	Analog Measurement Software	✓	No				
WLAN IEEE 802.11a/b/g/n/j/p	MX269028A	WLAN (802.11) Measurement Software (Supports IEEE 802.11n/11a/11b/11g/11j/11p)	✓	✓	✓	✓		
WLAN IEEE 802.11ac (80 MHz)	MX269028A-001	802.11ac (80 MHz) Measurement Software	✓	✓	✓	✓	✓	✓

# SG: Vector Signal Generator

The MS2830A incorporates a Vector Signal Generator option with frequency range from 250 kHz to 3.6 GHz/6.0 GHz, and a 120 MHz vector modulation band. Due to the excellent level accuracy and ACLR performance, it is ideal for using with the spectrum analyzer and signal generator functions to measure amplifiers, filters, and antennas.

## Features

- ◆ Frequency range
  - 250 kHz to 3.6 GHz (MS2830A-020)
  - 250 kHz to 6.0 GHz (MS2830A-021)
- ◆ Output level range
  - 40 to +20 dBm (Standard)
  - 136 to +15 dBm (MS2830A-022)
- ◆ Vector modulation band: 120 MHz
- ◆ Waveform memory
  - 64 Msa (Standard), 256 Msa (MS2830A-027)
- ◆ High level accuracy
  - Absolute Level Accuracy:  $\pm 0.5$  dB, Linearity:  $\pm 0.2$  dB (typ.)
- ◆ Excellent ACLR performance
  - $\leq -64$  dBc @ 5 MHz offset
  - $\leq -67$  dBc @ 10 MHz offset
- ◆ AWGN function (MS2830A-028)

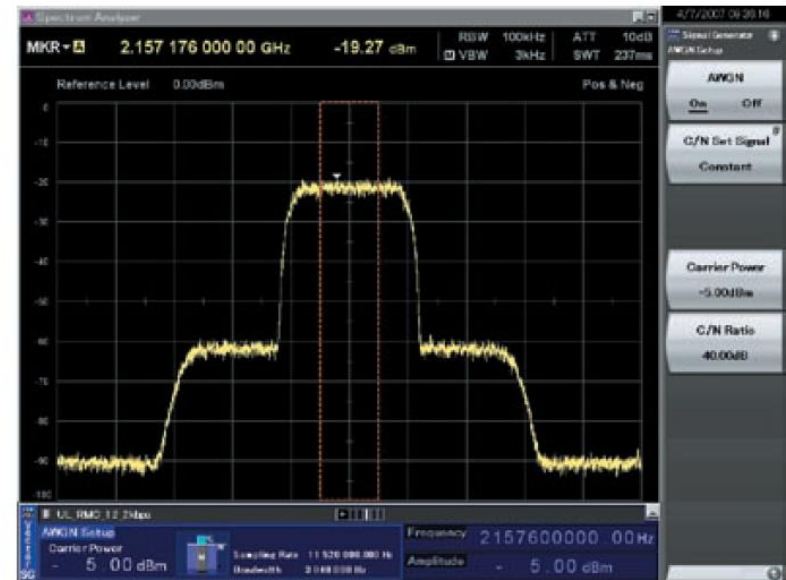

Wanted Signal + AWGN Output Waveform

-Vector Signal Generator Option-  
MS2830A-020 3.6 GHz Vector Signal Generator  
MS2830A-021 6 GHz Vector Signal Generator



# SG: Communication System Line Up

The pre-installed standard waveform patterns are bundled free-of-charge. Moreover, optional PC software (IQproducer) generates waveform patterns with any parameter settings.

In addition, any waveform pattern can be created using IQ data output from simulation tools.

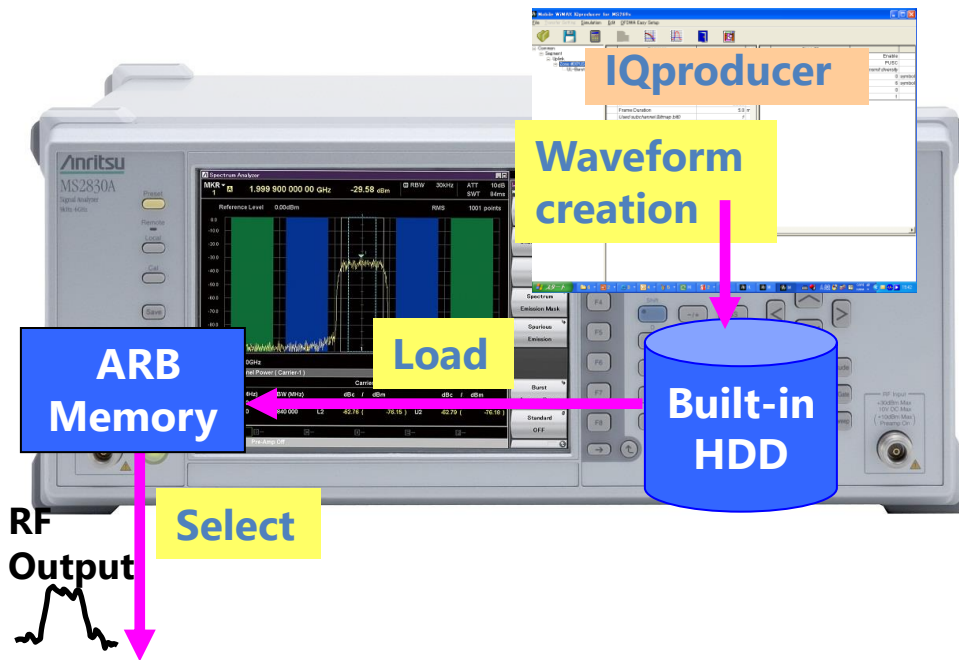

## ◆ Versatile communication system

### Built-in waveform patterns

- W-CDMA - HSDPA - CDMA2000
- CDMA2000 1xEV-DO - GSM/EDGE
- Digital Broadcast (ISDB-T/BS/CS/CATV)
- WLAN (IEEE802.11a/11b/11g) - *Bluetooth*<sup>®</sup>

### Option waveform patterns

- AWGN (Requires MS2830A-028)
- CDMA2000 1xEV-DO (Reverse Link)

### IQproducer (waveform creation software)

- LTE (FDD)\* / LTE-Advanced (FDD)\*
  - LTE (TDD)\* / LTE-Advanced (TDD)\*
  - HSDPA/HSUPA\*
  - W-CDMA
  - TDMA (Digital LMR/PMR, PHS, etc.)\*
  - Multi-carrier\*
  - WLAN (11a/b/g/n/j/p)\* / WLAN 11ac\*
  - TD-SCDMA\*
- \*:option

### Arbitrary waveform creation

Outputs ASCII IQ data from EDA tool converted to waveform pattern for MS2830A-020/021

See each IQproducer catalog for more details.

# SG: Frequency Range and Modulation Band (Vector SG)

This all-in-one hardware SG has the performance (6 GHz frequency, 120 MHz modulation band) to output signals for main communication systems.

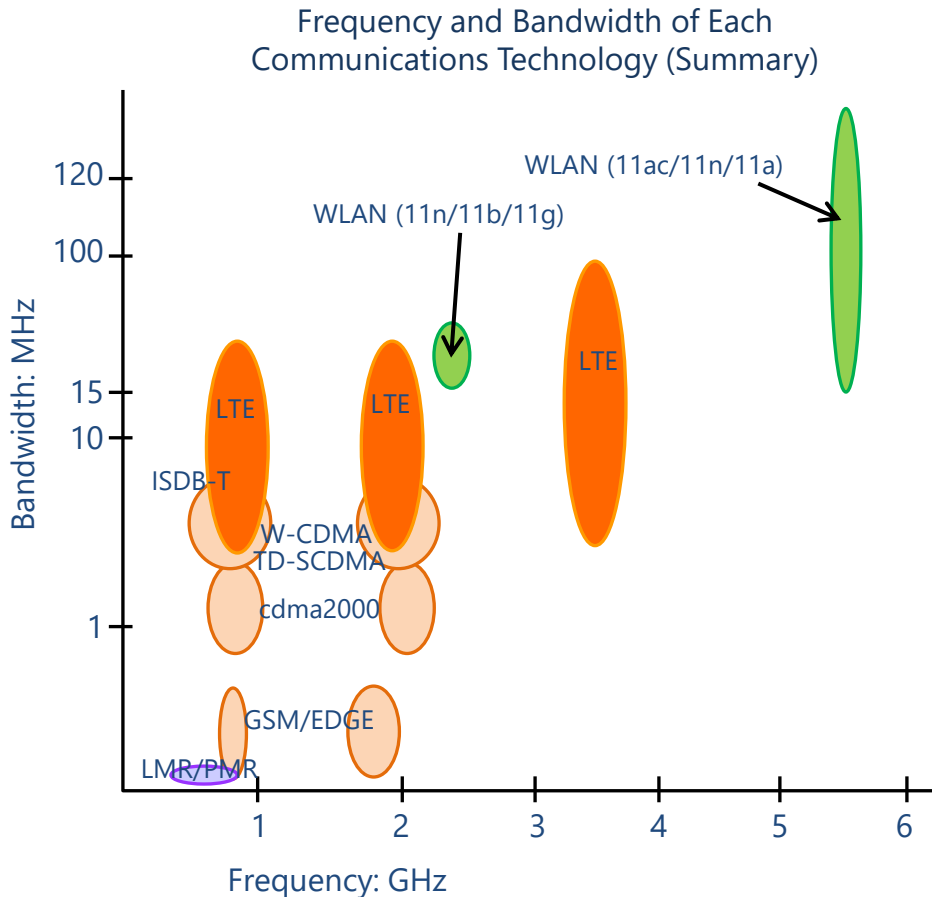

- ◆ **Frequency range up to 6 GHz**  
The frequency range covers 250kHz to 3.6GHz/6.0GHz and 5 GHz band wireless LAN and 4G.
- ◆ **120 MHz Vector modulation band**  
The wideband 120 MHz vector modulation is achieved using a built-in baseband signal generator.

# SG: Output Level Range (Vector SG)

The Vector Signal Generator standard option supports high outputs of +20 dBm max. Installing the MS2830A-022 Low Power Extension for Vector Signal Generator supports low-power outputs up to -136 dBm. It is ideal for Rx sensitivity tests.

- ◆ Output level range (Standard)  
-40 to +20 dBm

All-in-one instrument for amplifier tests

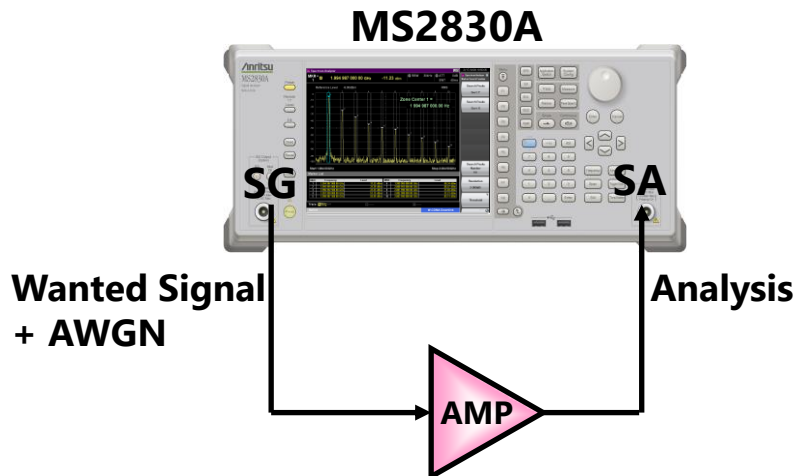

- ◆ Output level range (MS2830A-022)  
-136 to +15 dBm

Supports simple design of Tx/Rx test system

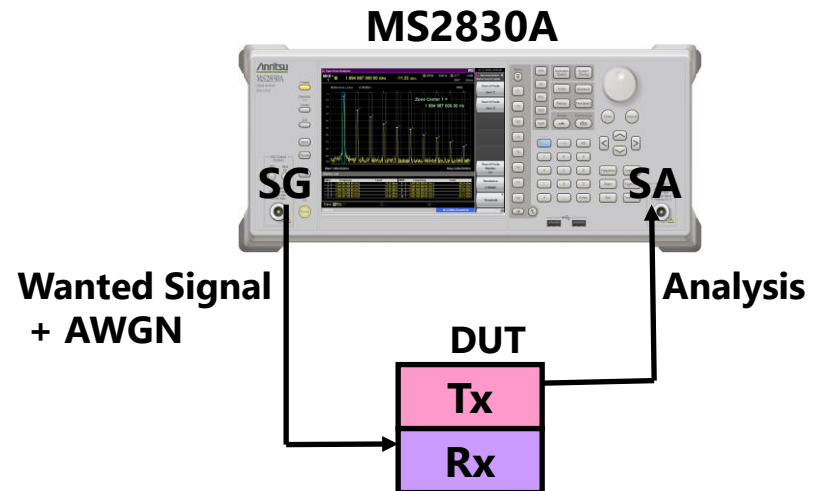

# SG: ACLR Performance (Vector SG)

## ◆ Superior ACLR Performance

The superior ACLR performance is useful for device Tx tests of amplifiers, etc. The MX269904A Multi-Carrier IQproducer software generates multiple carrier waveform patterns.

ACLR (measured value)

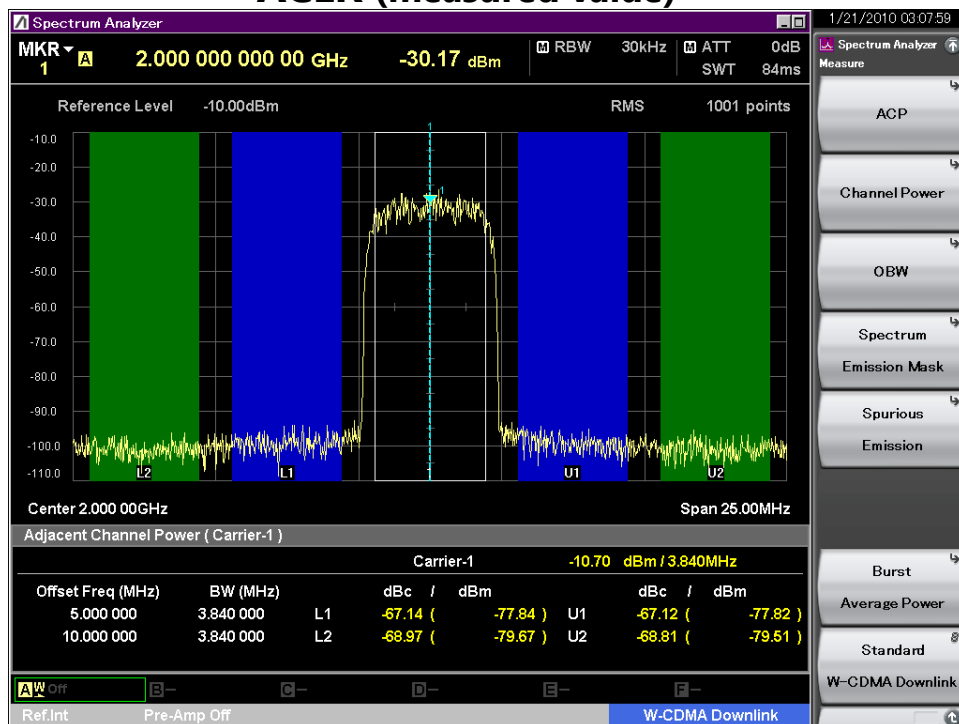

5 MHz -67.14 dBc\*  
10 MHz -68.97 dBc\*

(W-CDMA, TestModel1 64DPCH, 2 GHz, SG output -10 dBm)

\*: Value only data selected at random, and not guaranteed performance

## ◆ Built-in AWGN Generator for Dynamic Range Tests

This can add AWGN (Additive White Gaussian Noise) to the wanted wave in the arbitrary waveform memory. It is useful for Tx dynamic range tests.

- | AWGN band set automatically to sampling clock of wanted signal
- | Example: Wanted signal conditions
  - WCDMA
  - Bandwidth = 3.84 MHz
  - Oversampling = 4 times

AWGN bandwidth  
= 3.84 MHz x 4  
= 15.36 MHz

MS2830A-020/021  
Vector Signal Generator

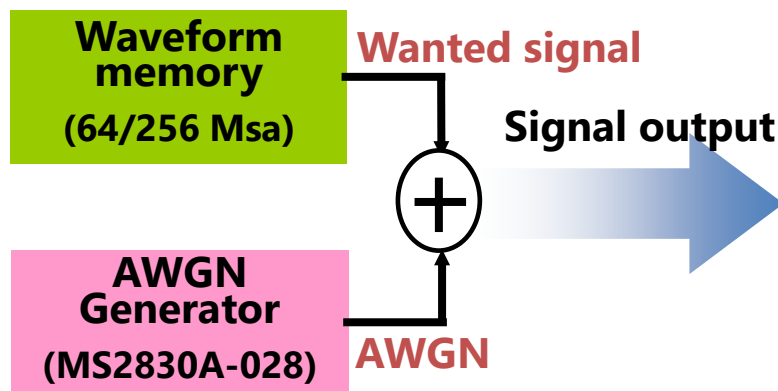

## Digitizer Function + Vector SG Option

Captured waveforms are converted to Vector SG waveform patterns using the built-in PC software. These patterns are read by the Vector SG to replay the signal.

The field environment is easily reproduced at the bench top to use captured device signals with a stable golden DUT for debugging and higher reliability testing.

### Reproduce captured waveforms from SG

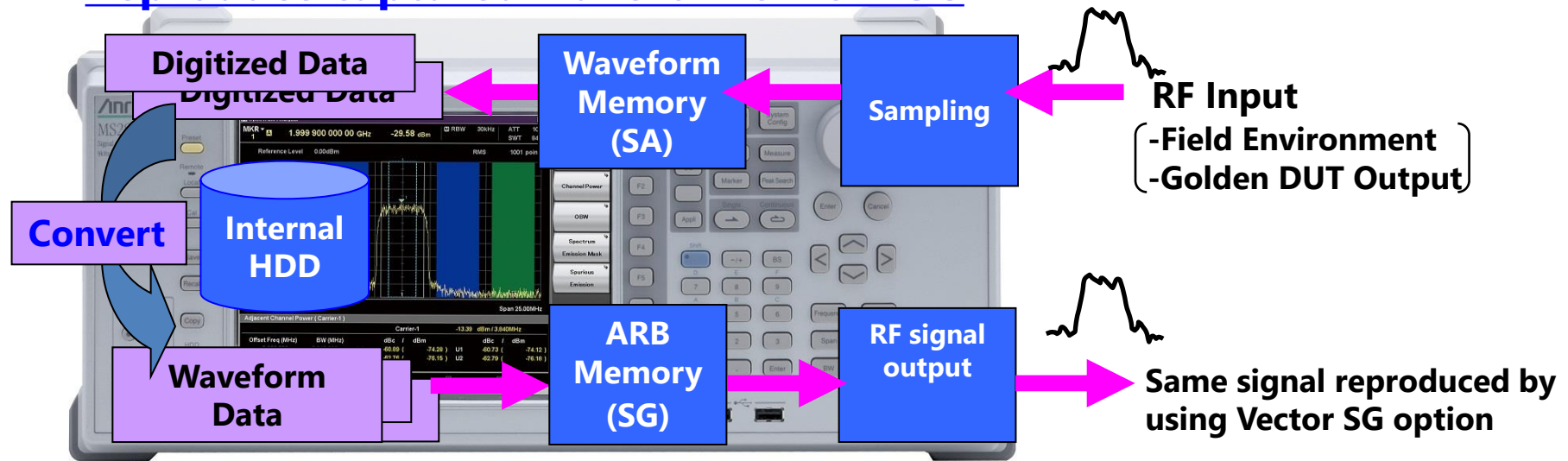

## Digitizer Function + Vector SG Option

### Capture & Playback Function

The MS2830A provides *Capture & Playback* functionality that enables laboratory-grade testing of transceiver systems using real world signals. Using the optional integrated Vector Signal Analyzer and Vector Signal Generator of the MS2830A, *Capture & Playback* allows users to conveniently capture up to 100 MHz of spectrum and play it back at any designated frequency and amplitude, making it easy to determine device performance margins.

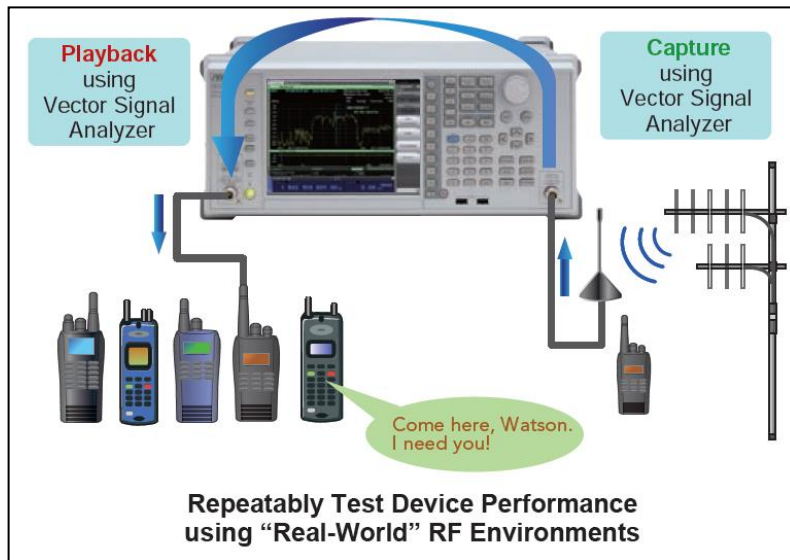

- Bandwidth and Time Limits

Minimum 10 kHz Bandwidth (2000 s maximum duration)\*

Maximum 100 MHz Bandwidth (500 ms maximum duration)\*

\*: Maximum bandwidth depends upon vector signal analyzer options installed (MS2830A-006/005/077/078). Maximum playback duration depends upon whether vector signal generator memory upgrade (MS2830A-027) is installed.

- Captured signal may be freely tuned to any output frequency and amplitude supported by the vector signal generator.

- Any section of the captured waveform record may be selected and played back.

- ✓ Enables user to isolate and reproduce specific signal bursts

- ✓ Enables user to change duty cycle of pulsed waveforms



## Internal Signal Generator Control Function Option (MS2830A-052)

The Internal signal generator control function operates in conjunction with the spectrum analyzer (SPA) function and built-in signal generator (SG) option to measure the transmission characteristics of filters, amplifiers, etc.

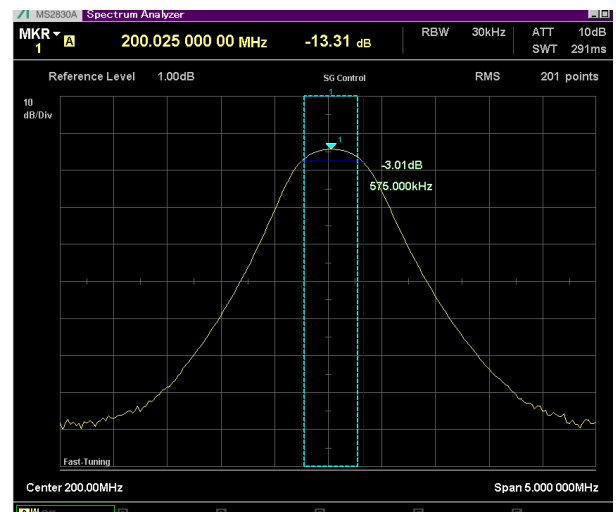
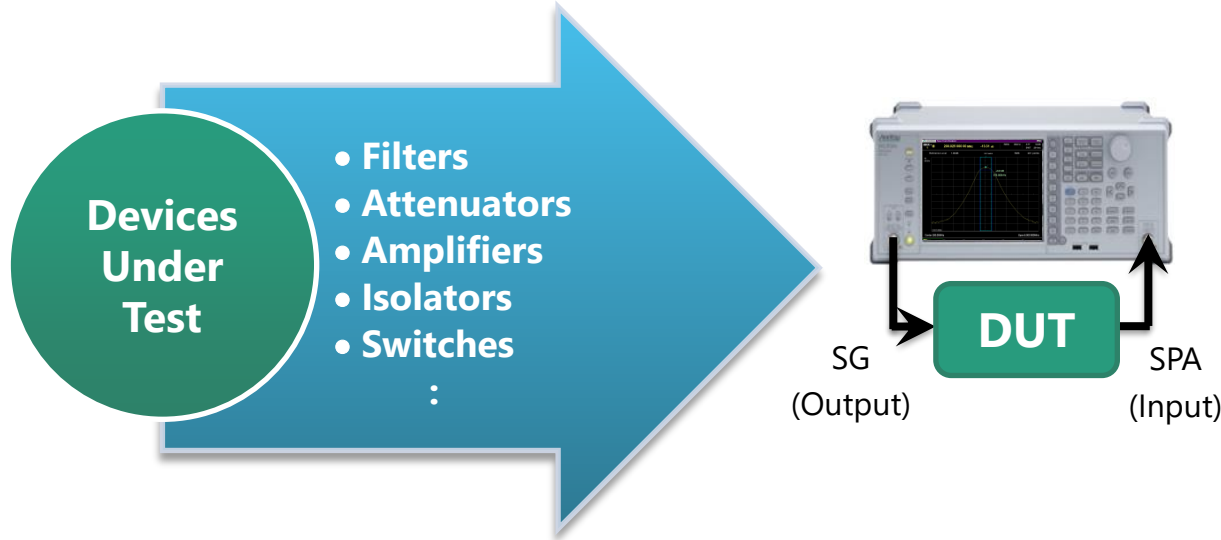

**N dB Bandwidth Measurement Function**

✓ **Measure Both Passive and Active Devices**

The DUT input signal source has a frequency range of 100 kHz to 6 GHz, an output level range of -136 to +15 dBm, a step resolution of 0.01 dB, and a level accuracy of ±0.5 dB to measure both passive and active devices using the built-in high-performance SG.

✓ **Accurate Frequency Characteristics**

The SPA function displays the measured frequency characteristics results with an excellent linearity error of just ±0.07 dB to display the frequency characteristics of bandpass filters, etc., accurately.

# Useful Measurement Functions for Evaluating Tx Characteristics (1/21)

The MS2830A has all the versatile built-in measurement functions needed for evaluating Tx characteristics. Using functions matching measurements supports simple tests according to specifications.

Measure Function	SPA <sup>*1</sup>	VSA <sup>*2</sup>
Channel Power	✓	✓
Occupied Bandwidth	✓	✓
Adjacent Channel Leakage Power	✓	✓
Spectrum Emission Mask	✓	
Burst Average Power	✓	✓
Spurious Emission	✓	
AM Depth		✓
FM Deviation		✓
Multi-marker & Marker List	✓	✓
Highest 10 Markers	✓	✓
Limit Line	✓	
Frequency Counter	✓	
2-tone 3rd-order Intermodulation Distortion	✓	
Annotation Display (On/Off)	✓	
Power Meter	Independent function <sup>*3</sup>	
Phase Noise	MS2830A-010	
Noise Figure	MS2830A-017 <sup>*4</sup>	

\*1: SPA (Spectrum Analyzer)

\*2: VSA (Vector Signal Analyzer), Requires MS2830A-005/006/077/078

\*3: Use USB Power Sensors

\*4: Use Noise Sources (Noisecom, NC346 series)

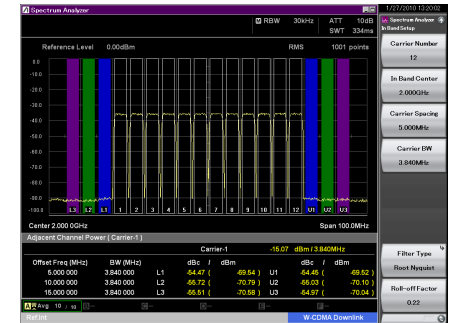

Adjacent Channel Leakage Power

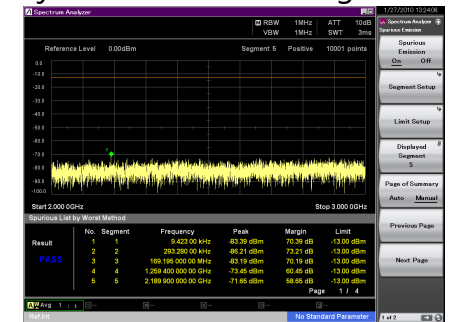

Spurious Emission

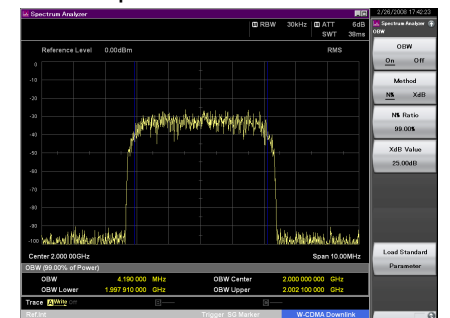

Occupied Bandwidth

## Channel Power

Channel power measurement using three types of filter (Rectangular, Nyquist, Root Nyquist) is supported.

### Channel Power Measurement

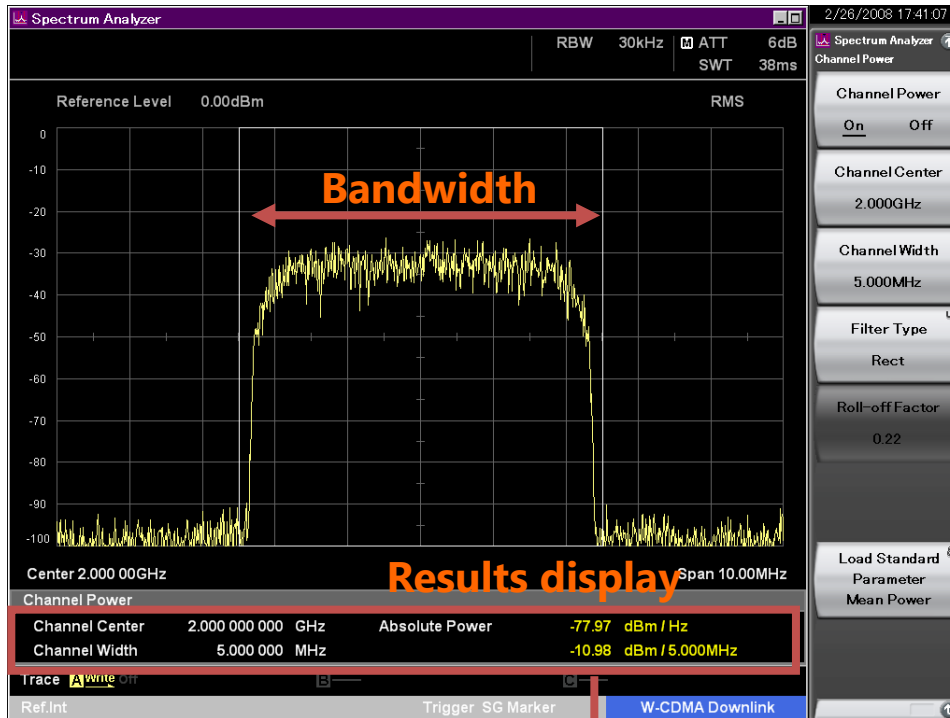

Measurement function ON/OFF

Channel center frequency

Channel bandwidth

**Filter:**  
Rectangular, Nyquist, Root Nyquist

Channel Center: Set value for channel center frequency  
Channel Width: Set value for channel bandwidth

Absolute Power: Power per Hz (Density)  
In-zone power (Integration)

## Occupied Bandwidth

Occupied bandwidth is measured in two modes—N% and X dB.

### Occupied Bandwidth Measurement

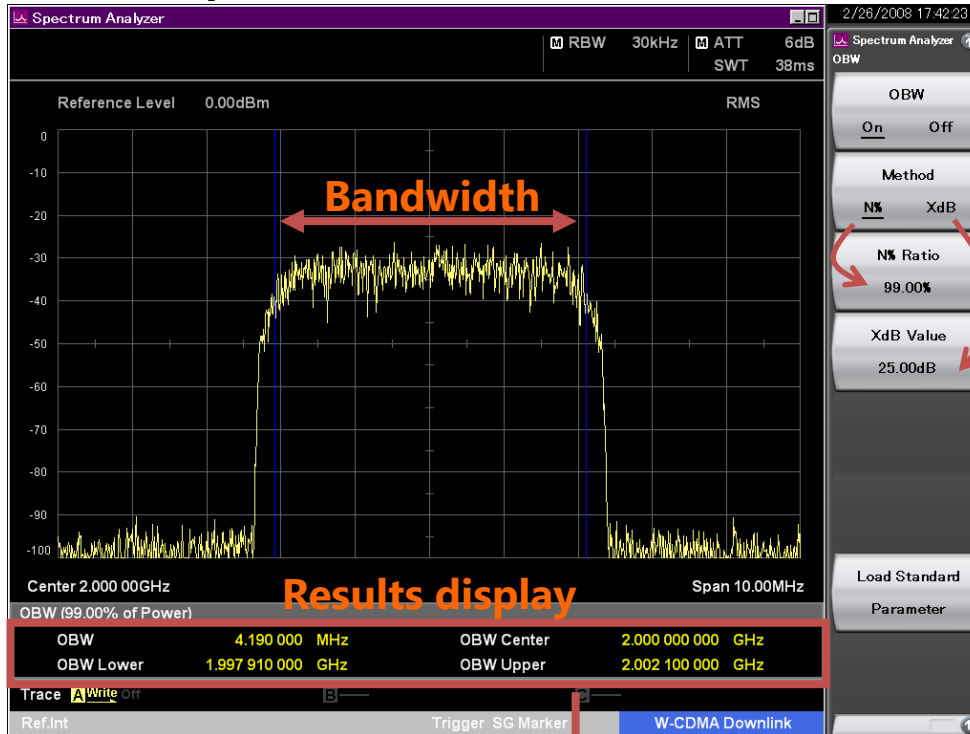

Measurement function ON/OFF

Measurement mode selection: (See below)

% setting for <N%> mode

Power setting for <X dB> mode

#### N% mode:

Bandwidth containing N% power with total power in display as 100%

#### X dB mode:

Bandwidth X dB down from peak value

OBW: Occupied bandwidth

OBW Center: Center frequency of occupied bandwidth

OBW Lower: Occupied bandwidth left-side frequency

OBW Upper: Occupied bandwidth right-side frequency

## Adjacent Channel Leakage Power (ACLR)

This function measures adjacent channel leakage power.

### Adjacent Channel Leakage Power Measurement



Measurement function ON/OFF

Reference Power setting: (See below)

In-band setting

Offset Channel setting

Result display switching

Carrier: In-band, Ofs: Offset Channel, All: Both In-band and Offset Channel

Noise cancellation function ON/OFF

(subtracts main-frame noise from measurement result)

Relative power for Offset 1 to 3 [dBc] vs. reference power selected with ACP Reference  
( ) indicates absolute power [dBm].

#### Reference power setting:

- SPAN TOTAL: Integral power for overall display
- Carrier Total: Total of all carrier power
- Both Sides of Carriers: Out-of-band carrier power
- Carrier Select: Specified carrier power

## Adjacent Channel Leakage Power (ACLR)

In Band can be set from 1 to 12 carriers and switched instantaneously on the screen. Moreover, true ACLR performance is measured using the noise cancellation function to subtract main-frame noise from the measurement result.

ACLR Measurement (12 carriers)

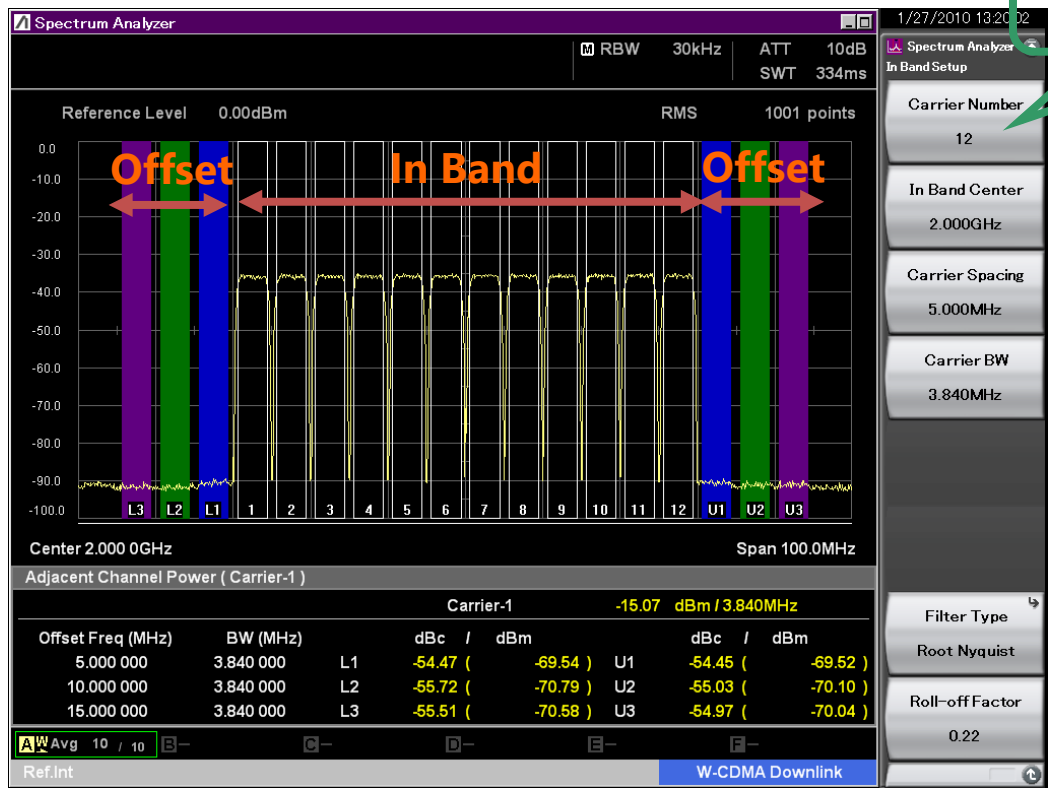

Carrier number switched instantaneously!



## Adjacent Channel Leakage Power (ACLR)

Offset channel can be set from 1 to 8 and switched instantaneously on the screen.

ACLR Measurement (12 carriers / 8 offsets)

Offset number switched instantaneously!

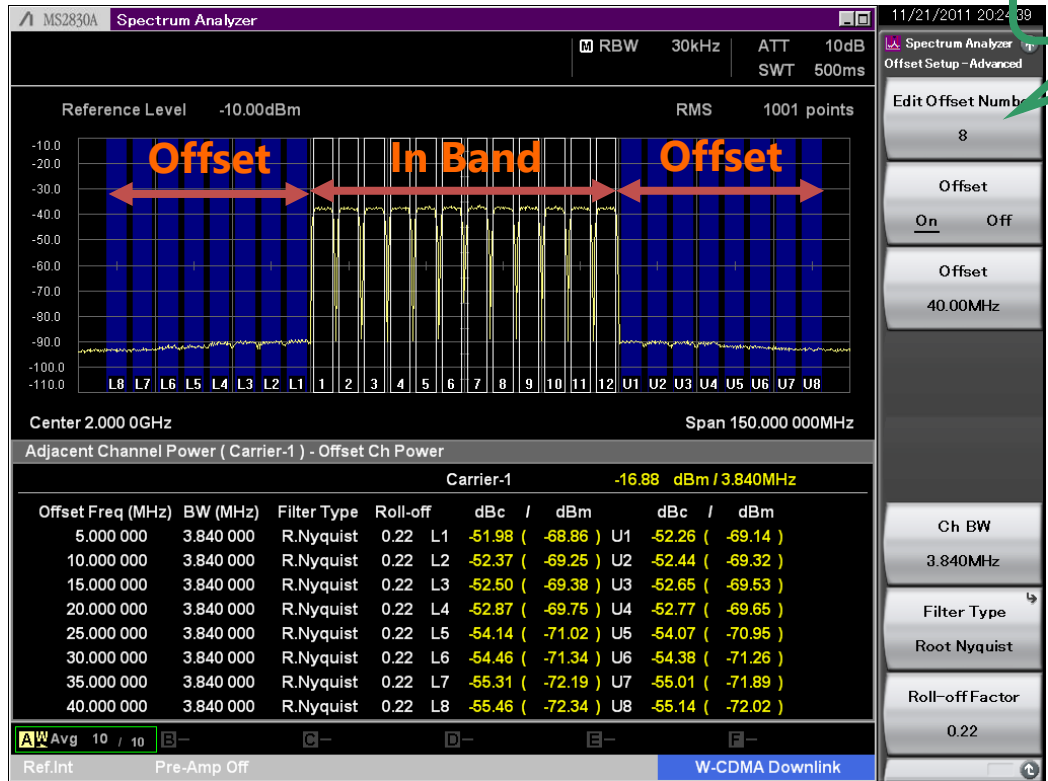





## Spectrum Emission Mask (SEM)

Offset limit lines can be set for up to 12 segments. The peak frequency and level in each segment are displayed and parts exceeding the limit line are indicated in red. Also, when a limit line is exceeded at just one part, Fail is displayed in red at the Result displays at the bottom left of the screen.

### Spectrum Emission Mask Measurement

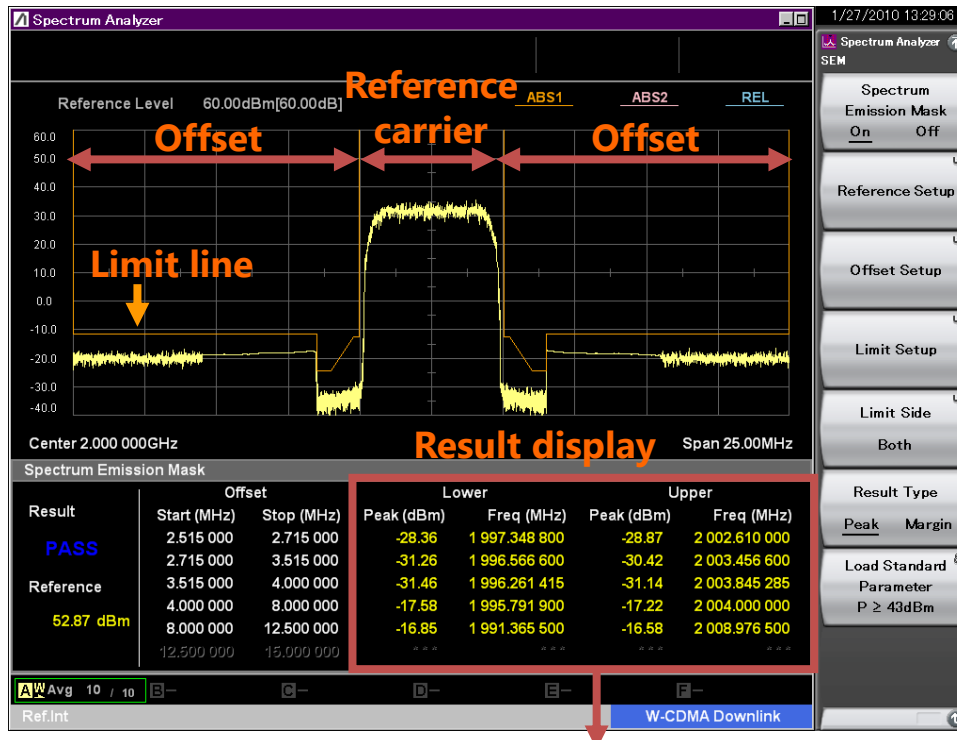

Level (Peak/Margin) and frequency of point closest to limit line per offset.

- Measurement function ON/OFF
- Reference carrier bandwidth and sweeping method setting
- Offset position and sweeping method setting
- Limit line setting (orange line)
- Measurement target setting: (See below)
- Result display switching
  - Peak: Absolute power
  - Margin: Margin for limit line

**Measurement Target Setting**

- Both: Measures both Lower and Upper
- Lower: Measures Lower
- Upper: Measures Upper



## Limit Lines

Up to six types of Limit line can be set on the spectrum display (frequency domain). In addition to setting the frequency and level of crossover points manually in sequence from the low frequency, after creating the right half of a line, the left half can be created by reversing and copying the right half, to set a symmetric limit line. Additionally, a Limit line that traces the measured waveform can be created using the Limit Envelope function. A margin can be set on the Limit line in the amplitude direction.

When the waveform is above or below the Limit line, it is evaluated automatically as PASS or FAIL. Evaluation is also possible with an added margin. The target evaluation line can be chosen from any of six types.

When the waveform matches the evaluation conditions (Event), it can be saved automatically as a csv format file. Any one of the following five Event types can be selected. (Save on Event Function)

- (1) Limit Fail: Saves waveform file when evaluation result is Fail
- (2) Limit Pass: Saves waveform file when evaluation result is Pass
- (3) Margin Fail: Saves waveform file when evaluation result including Margin is Fail
- (4) Margin Pass: Saves waveform file when evaluation result including Margin is Pass
- (5) Sweep Complete: Saves waveform file at every measurement regardless of evaluation result

Line: Limit 1, Limit 2, Limit 3, Limit 4, Limit 5, Limit 6  
Evaluation Type: Upper Limit, Lower Limit  
Crossover (Point): 1 to 100  
Margin: Set Margin line for each Limit 1, 2, 3, 4, 5, 6  
Evaluation Result: PASS, FAIL  
Result Save: Auto-save as csv format file. (Save on Event Function)

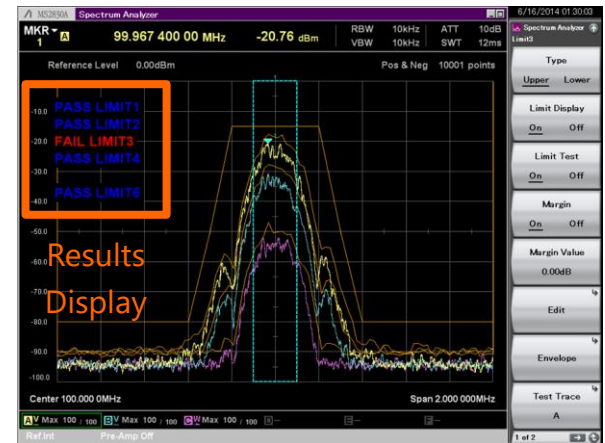

PASS/FAIL evaluation is performed by changing the input signal level. The evaluation results for the five line types can be displayed simultaneously on one screen.

## Average In-burst Power Measurement

The average power of specified burst segments is displayed in the time domain. Measurement only requires setting the measurement start and end positions on the screen.

### Average In-burst Power Measurement

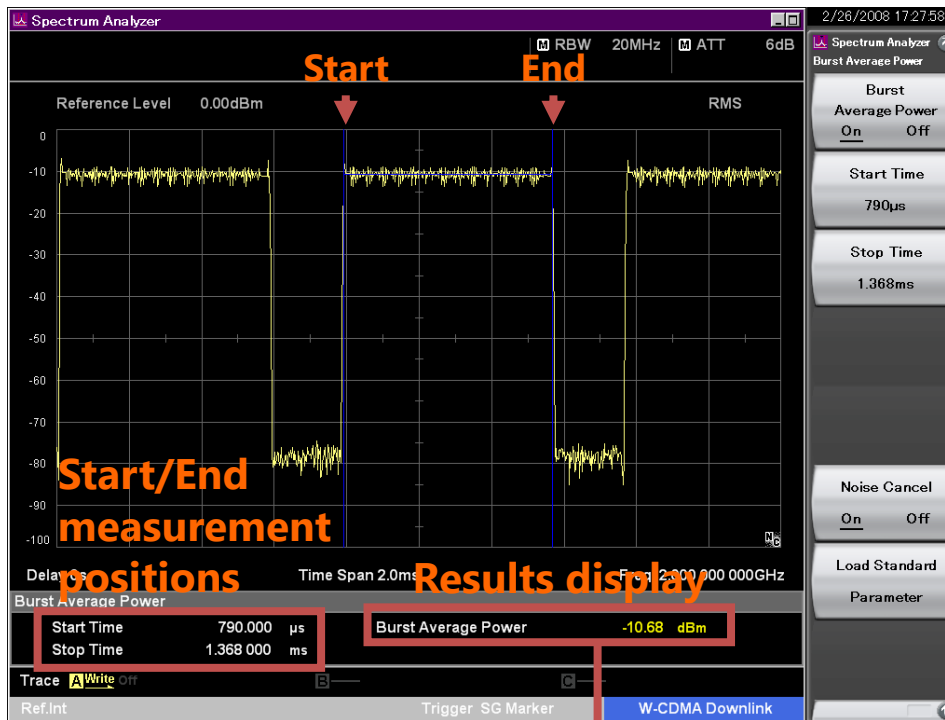

Measurement function ON/OFF

Measurement start position

Measurement stop position

Noise cancellation function ON/OFF  
(Subtracts main-frame noise from measurement result)

Displays average power between Start Time and Stop Time



## Spurious Emission

The peak frequency and level in each segment and the standard margin are displayed; parts exceeding the limit line are indicated in red. Also, Fail is displayed in red at the bottom left of the Results display even when the limit line is exceeded at only one part. A maximum of 20 segments can be set.

### Spurious Emission Measurement

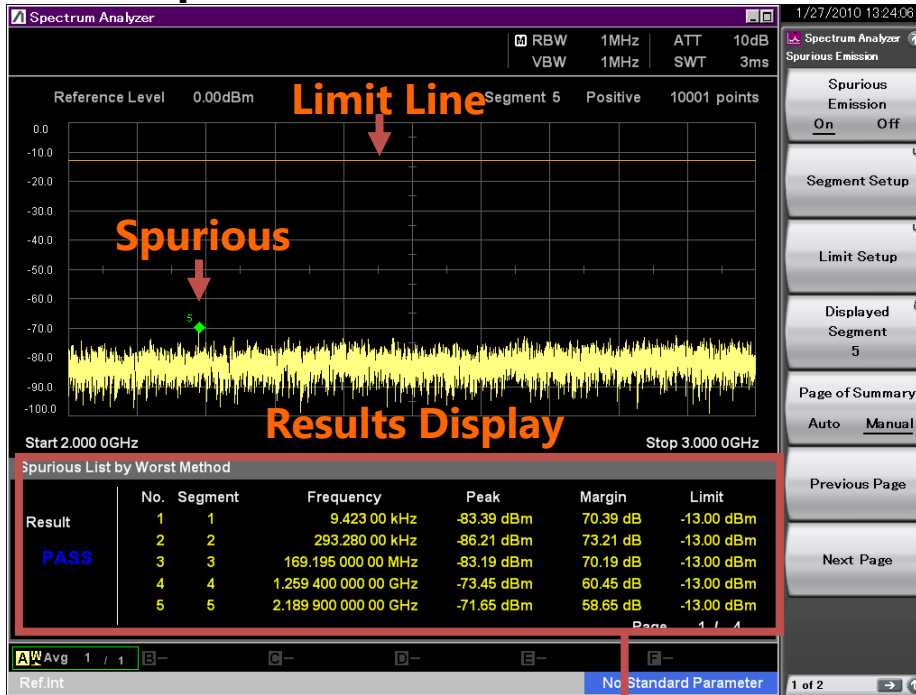

- Time Domain Measurement:**
- Spurious can be swept (detected) for up to 20 segments using the Zero Span measurement function.
- Different parameters (RBW/VBW) from segment sweeping can be set.
- Time domain measurements can be switched ON/OFF.

Detected spurious: Segment number, frequency, level (Peak/Margin), limit line

## AM: Power vs. Time



This function measures the amplitude modulation.

## FM Shift Measurement Function: Frequency vs. Time



This function measures frequency shift.

### AM Measurement



+ Peak, -Peak, (Peak-Peak)/2, average voltage between marker 1 and 2

### FM Shift Measurement

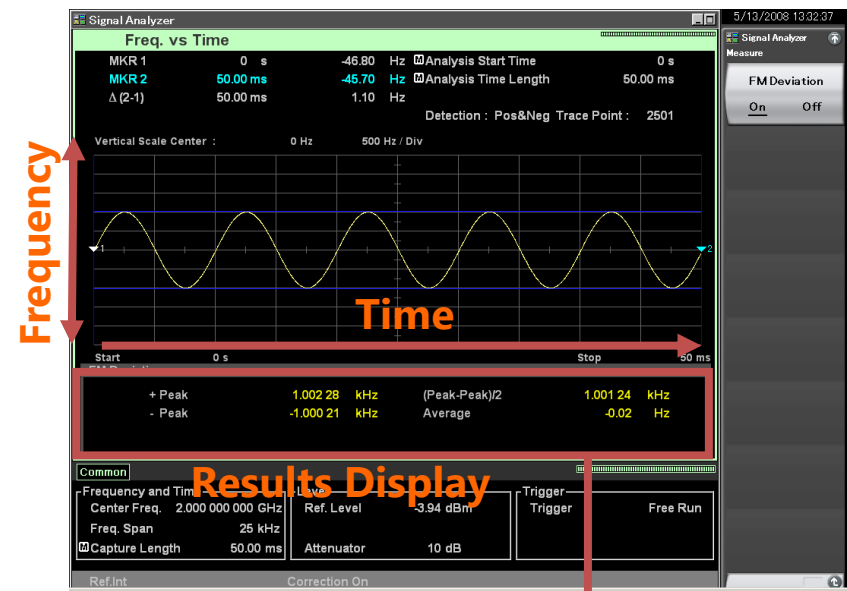

+ Peak, -Peak, (Peak-Peak)/2, average frequency between marker 1 and 2

## Phase Fluctuation Display Function: Phase vs. Time

VSA

This function displays phase time fluctuations.

### Phase Fluctuation Display



#### Phase Fluctuation:

Phenomena that are hard to spot using a spectrum analyzer, such as phase drift due to switching and transients, can be evaluated.

SPA VSA

## Zone Marker Function

This displays the Peak value within the specified range. It is useful for measuring unstable signals with fluctuating frequency and noise.

SPA VSA

## Multi-Marker/Highest 10 Function

This automatically searches for the ten highest peaks sorted from highest level (Sort Y) or lowest frequency (Sort X).

In addition, setting a threshold eliminates unnecessary searching.

This can be used for IM and harmonic, etc., measurements.

### IM Measurement

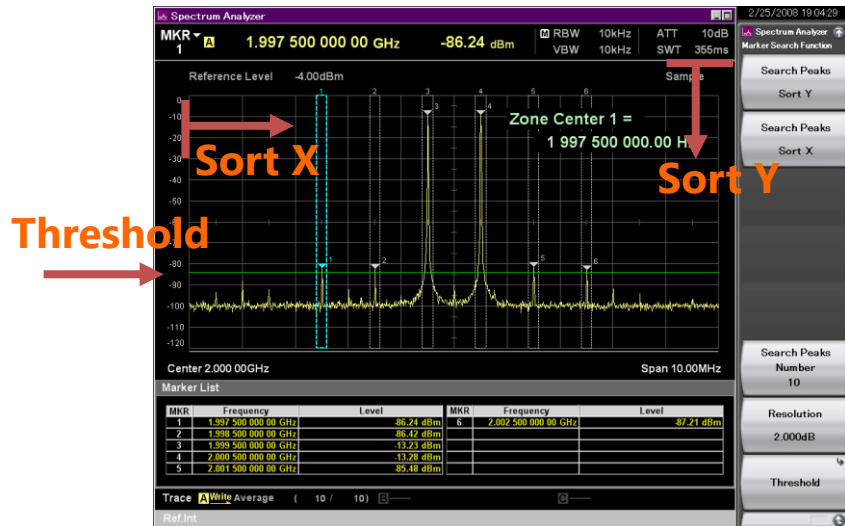

### Harmonic Measurement

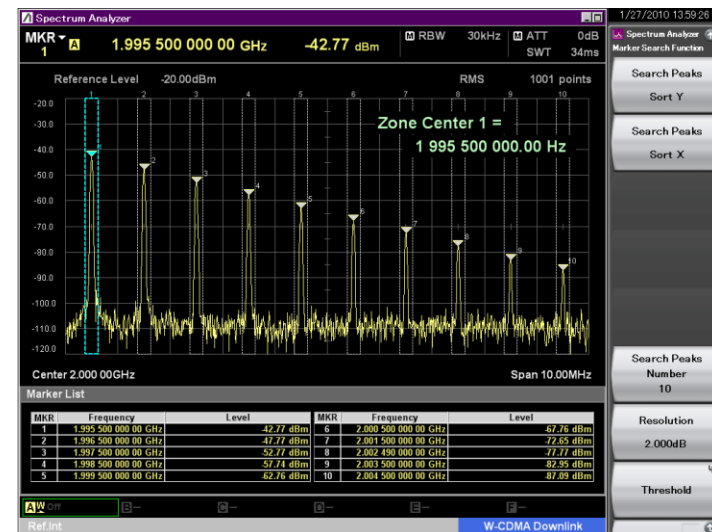





## 2-tone 3rd-order Intermodulation Distortion



By inputting two different frequency CW signals (desired waves), two-tone third order intermodulation distortion is generated close to the desired waves according to non-linear characteristics of DUT. Then, TOI (Third Order Intercept) is calculated from the two-tone third order intermodulation distortion.

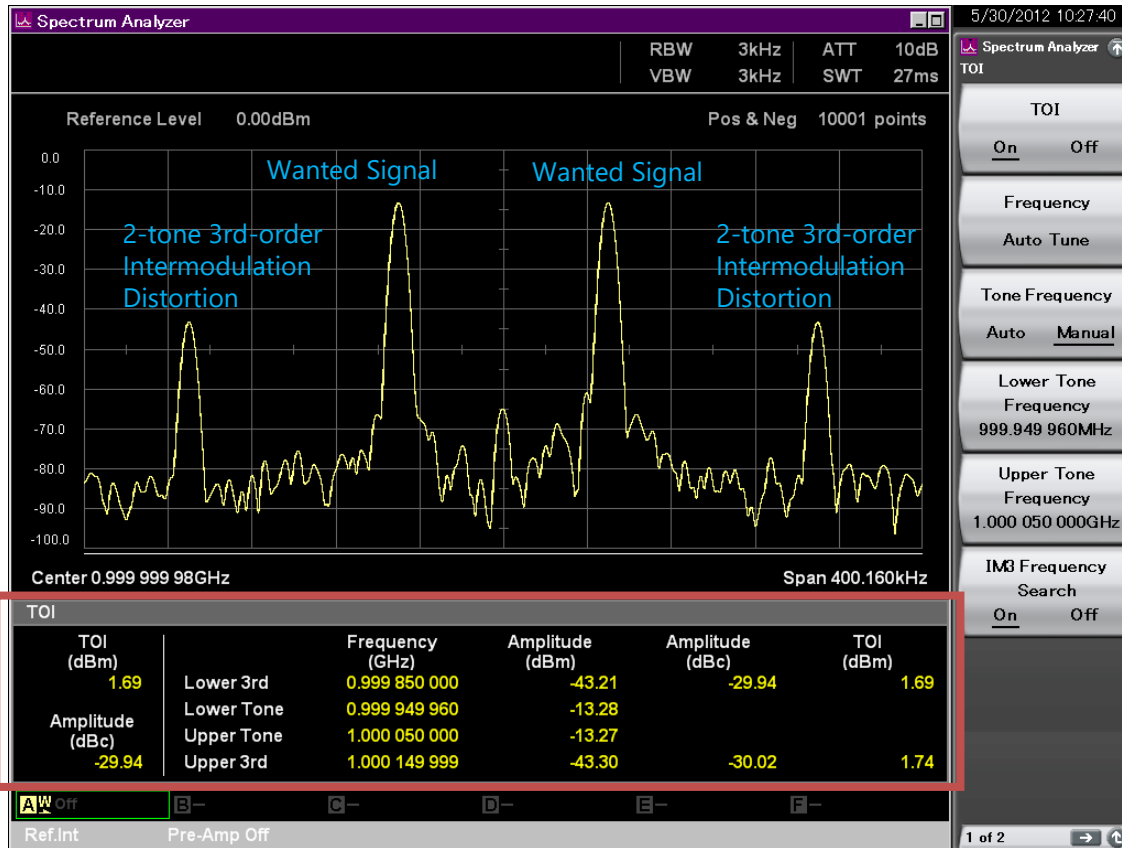

### Results Display

Item	Description
TOI (dBm)	Displays the calculated TOI. The Worst value (lower) between two calculated values (lower and upper) is displayed.
Amplitude (dBc)	Displays the level ratio of two-tone third-order intermodulation distortion to the desired wave. The Worst value (larger) between two calculated values (lower and upper) is displayed.
Lower 3rd	Two-tone third-order intermodulation distortion that occurs at the lower frequency of the desired wave. Frequency, signal level, level ratio to the desired wave, and calculated TOI are displayed.
Lower Tone	Desired wave that includes the lower frequency component. Frequency and signal level are displayed.
Upper Tone	Desired wave that includes the upper frequency component. Frequency and signal level are displayed.
Upper 3rd	Two-tone third-order intermodulation distortion that occurs at the upper frequency of the desired wave. Frequency, signal level, level ratio to the desired wave, and calculated TOI are displayed.

## Annotation Display (On/Off)

Screen annotations can be set to On or Off. Annotations about frequency, amplitude, etc., are not displayed at the Off setting.

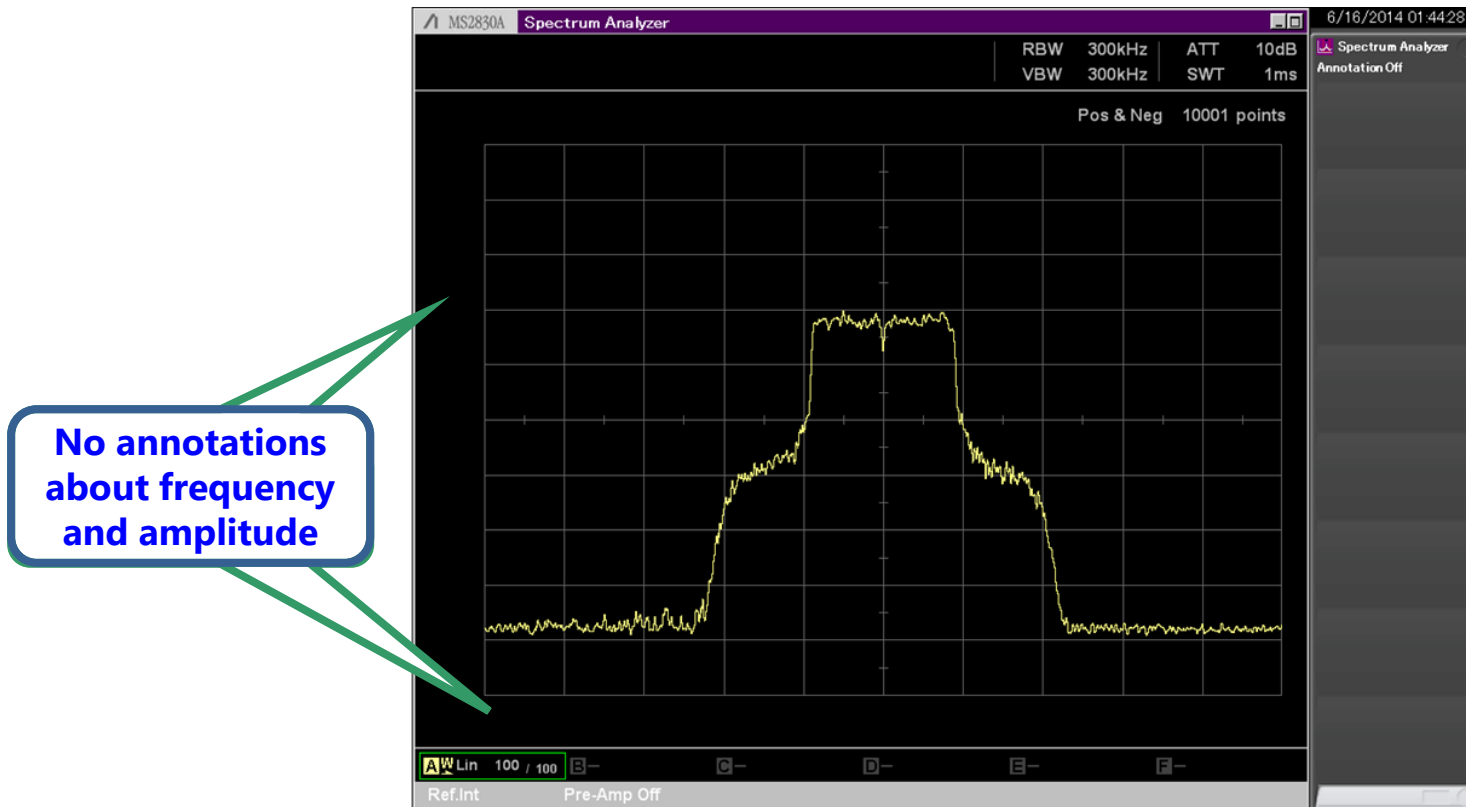

## Power Meter Function

Power meter function can connect a USB power sensor to the MS269xA and read the measurement values.

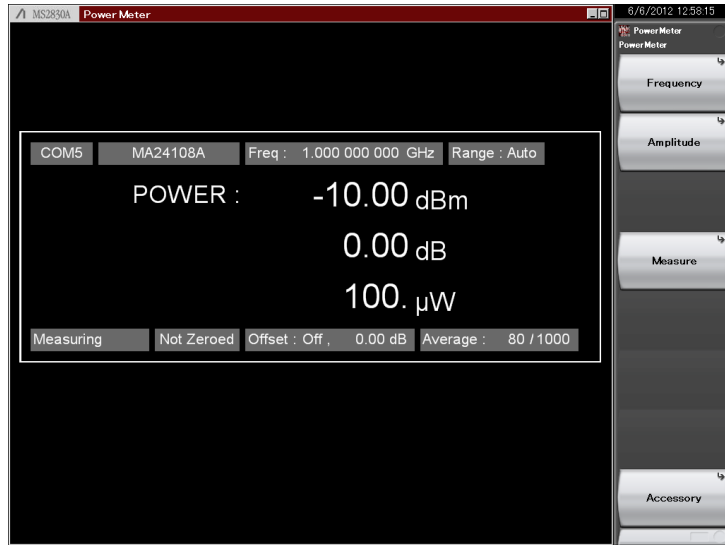

### Measurement Results

- Power: [dBm], [W]
- Relative power: [dB]

### Compatible USB power sensors

Model	Frequency	Dynamic Range
MA24104A*	600 MHz to 4 GHz	+3 to +51.76 dBm
MA24105A	350 MHz to 4GHz	+3 to +51.76 dBm
MA24106A	50 MHz to 6 GHz	-40 to +23 dBm
MA24108A	10 MHz to 8 GHz	-40 to +20 dBm
MA24118A	10 MHz to 18 GHz	-40 to +20 dBm
MA24126A	10 MHz to 26 GHz	-40 to +20 dBm

\*: MA24104A has been discontinued.

### ■ Installing the Anritsu PowerXpert™

Installing the Anritsu PowerXpert™ PC application software for the Anritsu USB Power Sensor in the MS2830A supports various measurement functions offered by Anritsu PowerXpert™, as well as use of other USB power sensors by the MS2830A.

Anritsu PowerXpert™ for the MS2830A can be downloaded from the MS2830A and MS2830A Microwave product pages at the Anritsu website. When using the Anritsu PowerXpert™ software with a PC, download the latest version from the USB Power Sensor product page at the Anritsu website.

## Phase Noise Measurement Function [MS2830A-010]

This function measures the phase noise over a frequency offset range of 10 Hz to 10 MHz.



### **Normal:**

Normal marker. Displays phase noise level at specified frequency offset.

### **Integral Noise:**

Calculates Integral Noise for specified integrated bandwidth

### **RMS Noise:**

Calculates RMS Noise for specified integrated bandwidth

### **Jitter:**

Calculates Jitter for specified integrated bandwidth

### **Residual FM:**

Calculates Residual FM for specified integrated bandwidth

### **Carrier Frequency:**

- 10 MHz to main frame upper limit
- Start Offset (lower limit frequency): 10 Hz to 1 kHz
- Stop Offset (upper limit frequency): 100 kHz to 10 MHz

### **Log Scale Line(10/16):**

- Sets number of Log scale lines to 10 or 16
- Reference Value: Sets upper limit of vertical axis
  - 140 to -50 dBc/Hz (Log Scale Line: 10)
  - 170 to -20 dBc/Hz (Log Scale Line: 16)

## Noise Figure Measurement Function [MS2830A-017]

Noise Figure is measured with the measurement method of Y-factor method which uses a Noise Source.

**Frequency Mode: Fixed/List/Sweep**

**DUT Mode: Amplifier**

**Screen Layout: Graph/Table**

**Measurement Results Display**

■ **Graph/List/Spot**

Displays measurement results for each trace (Trace 1/Trace 2).

- ◆ Noise Figure (NF) [dB]
- ◆ Noise Factor (F) [Linear]
- ◆ Gain
- ◆ Y-Factor: Power ratio when Noise Source is turned ON/OFF
- ◆ T effective: Effective noise temperature
- ◆ P Hot: Power measured when Noise Source is On.
- ◆ P Cold: Power measured when Noise Source is Off.



Measurement Result: Example of Graph display (Frequency Mode: Sweep, Screen Layout: Graph)

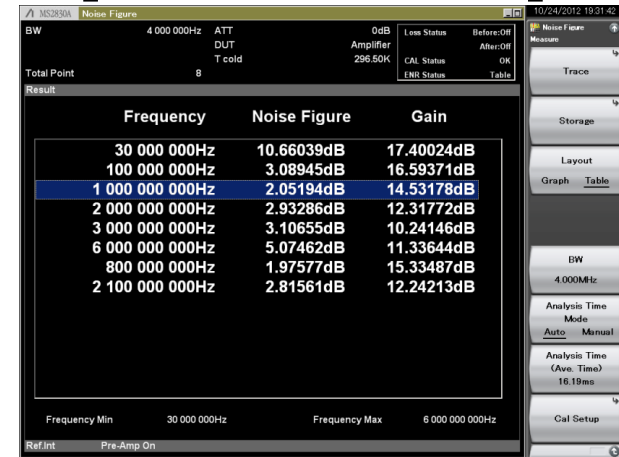

Measurement Result: Example of List display (Frequency Mode: List, Screen Layout: List)

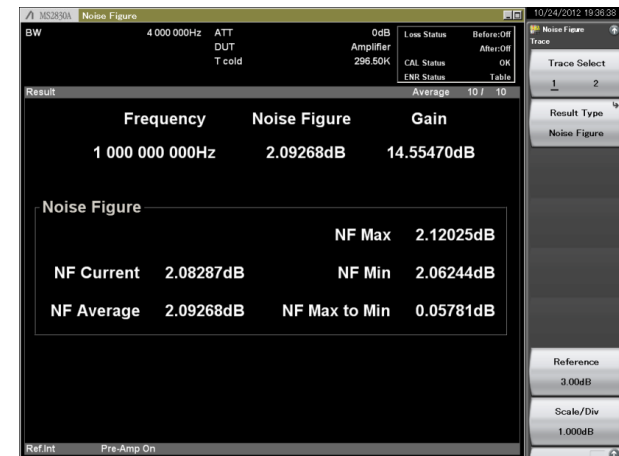

Measurement Result: Example of Spot display (Frequency Mode: Fixed)

## Noise Figure Measurement Function [MS2830A-017]

### Noise Source

Supports noise sources from Noisecom NC346 series. NC346 series models and summary specifications are listed below. See the NC346 series catalog and datasheet for detailed specifications.

### NC346 series summary specifications

Model	RF Connector	Frequency [GHz]	Output ENR [dB]	VSWR (maximum @ on/off) [GHz]				DC Offset	DC Block
				0.01 to 5	5 to 18	18 to 26.5	26.5 to 40		
NC346A	SMA (M)	0.01 to 18.0	5 to 7	1.15: 1	1.25: 1	—	—	No	Not required
NC346A Precision	APC3.5 (M)	0.01 to 18.0	5 to 7	1.15: 1	1.25: 1	—	—	No	Not required
NC346A Option 1	N (M)	0.01 to 18.0	5 to 7	1.15: 1	1.25: 1	—	—	No	Not required
NC346A Option 2	APC7	0.01 to 18.0	5 to 7	1.15: 1	1.25: 1	—	—	No	Not required
NC346A Option 4	N (F)	0.01 to 18.0	5 to 7	1.15: 1	1.25: 1	—	—	No	Not required
NC346B	SMA (M)	0.01 to 18.0	14 to 16	1.15: 1	1.25: 1	—	—	No	Not required
NC346B Precision	APC3.5 (M)	0.01 to 18.0	14 to 16	1.15: 1	1.25: 1	—	—	No	Not required
NC346B Option 1	N (M)	0.01 to 18.0	14 to 16	1.15: 1	1.35: 1	—	—	No	Not required
NC346B Option 2	APC7	0.01 to 18.0	14 to 16	1.15: 1	1.25: 1	—	—	No	Not required
NC346B Option 4	N (F)	0.01 to 18.0	14 to 16	1.15: 1	1.35: 1	—	—	No	Not required
NC346D	SMA (M)	0.01 to 18.0	19 to 25 <sup>*1</sup>	1.50: 1	1.50: 1	—	—	No	Not required
NC346D Precision	APC3.5 (M)	0.01 to 18.0	19 to 25 <sup>*1</sup>	1.50: 1	1.50: 1	—	—	No	Not required
NC346D Option 1	N (M)	0.01 to 18.0	19 to 25 <sup>*1</sup>	1.50: 1	1.75: 1	—	—	No	Not required
NC346D Option 2	APC7	0.01 to 18.0	19 to 25 <sup>*1</sup>	1.50: 1	1.50: 1	—	—	No	Not required
NC346D Option 3	N (F)	0.01 to 18.0	19 to 25 <sup>*1</sup>	1.50: 1	1.75: 1	—	—	No	Not required
NC346C	APC3.5 (M)	0.01 to 26.5	13 to 17	1.15: 1	1.25: 1	1.35: 1	—	Yes <sup>*3</sup>	Required <sup>*3</sup>
NC346E	APC3.5 (M)	0.01 to 26.5	19 to 25 <sup>*1</sup>	1.50: 1	1.50: 1	1.50: 1	—	Yes <sup>*3</sup>	Required <sup>*3</sup>
NC346Ka	K (M) <sup>*2</sup>	0.10 to 40.0	10 to 17	1.25: 1	1.30: 1	1.40: 1	1.50: 1	Yes <sup>*3</sup>	Required <sup>*3</sup>

\*1: Flatness better than  $\pm 2$  dB

\*2: Compatible with SMA and APC3.5

\*3: When using noise sources output by DC, always use in combination with a DC block.



## Noise Figure Measurement Function [MS2830A-017]

### Specifications outlines of recommended DC Blocks and Adapters

	Ordering		RF Connector	Frequency Range
	Model	Name		
DC Block	J0805	DC Block, N type (MODEL 7003)	N (M)-N (F)	10 kHz to 18 GHz
	J1555A	DC Block, SMA type (MODEL 7006-1)	SMA (M)-SMA (F)	9 kHz to 20 GHz
	K261	DC Block	K (M)-K (F)	10 kHz to 40 GHz
Adapter	J0004	Coaxial Adapter	N (M)-SMA (F)	DC to 12.4 GHz
	J1398A	N-SMA Adapter	N (M)-SMA (F)	DC to 26.5 GHz

### Recommended DC blocks/Adaptor combinations for MS2830A/MS269xA series signal analyzer

	Model	Frequency Range	RF connector	Recommended DC Block Order Name	Recommended Adapter Order Name
MS2830A series	MS2830A-040	9 kHz to 3.6 GHz	N (F)	Not required	Not required
	MS2830A-041	9 kHz to 6 GHz	N (F)	Not required	Not required
	MS2830A-043	9 kHz to 13.5 GHz	N (F)	Not required	Not required
	MS2830A-044	9 kHz to 26.5 GHz	N (F)	J1555A (9 kHz to 20 GHz)	J1398A
	MS2830A-045	9 kHz to 43 GHz	K (F)	K261	Not required
MS269xA series	MS2690A	50 Hz to 6 GHz	N (F)	J1555A (from 9 kHz)	J0004
	MS2691A	50 Hz to 13.5 GHz	N (F)	J1555A (from 9 kHz)	J1398A
	MS2692A	50 Hz to 26.5 GHz	N (F)	J1555A (9 kHz to 20 GHz)	J1398A

## BER Measurement Function [MS2830A-026]

### Returns Data/Clock/Enable demodulated by DUT to MS2830A BER function

- ◆ Input Bit Rate: 100 bps to 10 Mbps
- ◆ Input Signal: Data, Clock, Enable  
(Polarity reversal supported)
- ◆ Input Level: TTL 3.3V
- ◆ Measured Patterns:  
PN9/11/15/20/23, ALL1, ALL0,  
Alternate(0101...), User Data(4,096 bit Max.),  
PN9fix/11fix/15fix/20fix/23fix
- ◆ Count Mode:  
Data: Measures until specified Data count  
Error: Measures until specified Error count
- ◆ Measurable Bit Count: 1000 to  $2^{32}-1$   
(4,294,967,295 bit)
- ◆ Measurable Error Bit Count: 1 to  $2^{31}-1$   
(2,147,483,647 bit)
- ◆ Count Mode:  
Single: Measures specified measurement bit count once  
Continuous: Repeats Single measurement  
Endless: Continues measurement to upper limit of measurement bits

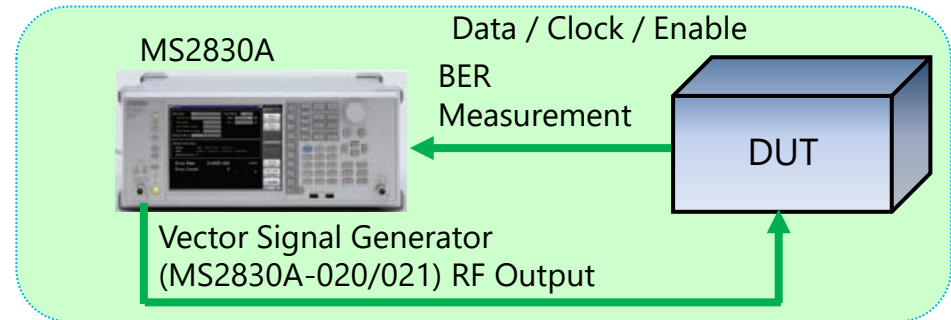

BER Measurement Setup Example (with MS2830A-020/021 installed)

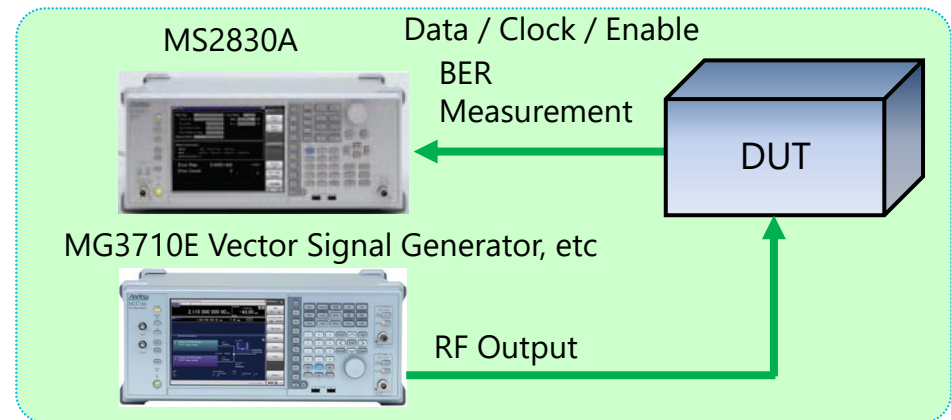

BER Measurement Setup Example  
(using external vector signal generator)

**This option installs a BER measurement function for measuring error rates between 100 bps and 10 Mbps using the DUT demodulated Data/Clock/Enable signals. The results are displayed on the MS2830A screen.**

## BER Measurement Function [MS2830A-026]

The screenshot displays the MS2830A BER Test interface. The main window is titled 'BER Test' and shows the following settings and results:

- Data Type:** PN9
- Count Mode:** Data (with a value of 10000 Bit)
- Measure Mode:** Single
- Measure Information:** Status is 'Measuring'. Error types include BitError, SyncLoss, ClockError, and EnableError. SyncLoss Count is 0.
- Results:** Error Rate is 1.008E-002 (1.008%), Error Count is 97 / 9620.

Annotations on the right side of the interface include:

- BER Test Start or Stop:** Points to the 'Measure Start' and 'Measure Stop' buttons.
- Clears measurement result:** Points to the 'Count Clear' button.
- Data Type:** Points to the 'Data Type' dropdown menu.
- Measure Mode:** Points to the 'Measure Mode' dropdown menu.
- Count Mode:** Points to the 'Count Mode' dropdown menu.
- Measured Bit:** Points to the 'Error Count' display.

**BER Measurement Example**

### Measure Mode

Single: Measures selected data patterns until result reaches specified number of bits or specified number of error bits

Continuous: Repeats single measurements (default)

Endless: Measures data until result reaches upper limit of measurement count bit

### Count Mode

Data: Specifies number of measurement bits (default)

Error: Specifies number of measurement error bits

## BER Measurement Function [MS2830A-026]

### [PN Fix pattern]

At BER measurement, special PN patterns called PN\_Fix patterns can be used. A PN Fix pattern consists of repeated parts of PN patterns, and PN patterns with a shorter length than 1 cycle.

Even when the PN data part of the waveform pattern output from vector signal generator has no periodicity, BER measurement is supported by selecting PN Fix at the BER measurement function.

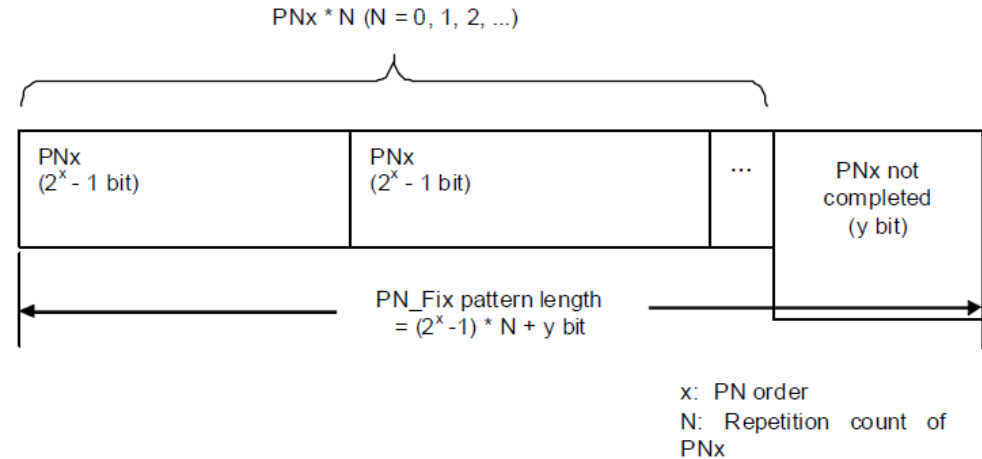

### Initial Pattern

Data Type	Initial Pattern Setting Range		Resolution	Default
	Binary	Hex		
PN9Fix	000000000 to 111111111 (9 bits)	000 to 1FF	1	1FF
PN11Fix	00000000000 to 11111111111 (11 bits)	000 to 7FF	1	7FF
PN15Fix	000000000000000 to 111111111111111 (15 bits)	0000 to 7FFF	1	7FFF
PN20Fix	0000000000000000000 to 1111111111111111111 (20 bits)	00000 to FFFFF	1	FFFFF
PN23Fix	000000000000000000000 to 111111111111111111111 (23 bits)	000000 to 7FFFFFF	1	7FFFFFF

### Pattern Length

Setting Range:

96 to 134217728 bit (0 x 8000000)

Resolution: 1 bit

## BER Measurement Function [MS2830A-026]

### [User Defined Pattern]

The BER measurement can use a user-defined pattern, which is an arbitrary binary string that is 8 to 4096 bits long and consists of a data bit string to determine whether synchronization is established plus a data bit string used as measurement data. A PC can be used to create a user-defined pattern in text file format. Load the file from USB memory or MS2830A internal hard disk.

Length: 8 to 4096 (Binary)

Extension: \*\*\*\*\*.bpn

Saved Folder: the root directory of the USB memory or internal hard disk (Example: D:¥)

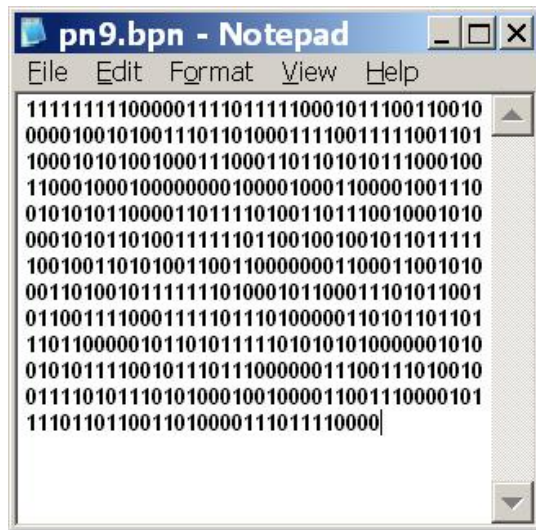

Example of User-Defined Pattern

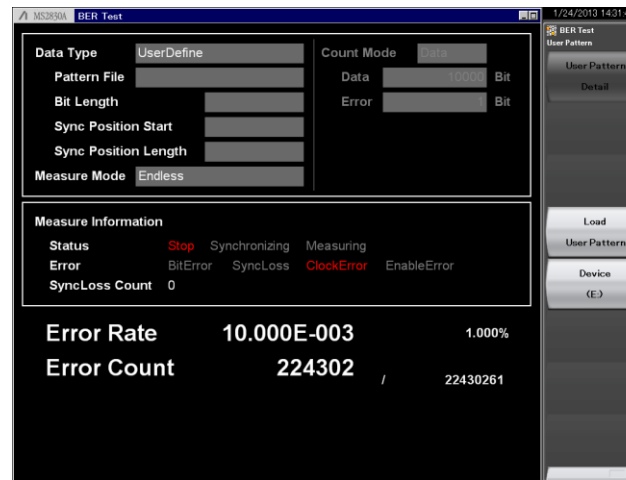

User-Defined Pattern function menu

Loads user-defined patterns from the USB memory or the internal hard disk of the MS2830A.

Selects the media among the USB memory and internal hard disk from which user-defined patterns are to be loaded.

# Useful Measurement Functions for Analog Radio (FM, $\Phi$ M, AM)

Combining the 3.6 GHz Analog Signal Generator MS2830A-088, MS2830A-018 Audio Analyzer MS2830A-018 and Analog Measurement Software MX269018A options in the all-in-one MS2830A main frame supports the simultaneous RF and AF signals required for implementing key TRx tests of analog(FM,  $\Phi$ M,AM) radio equipment.

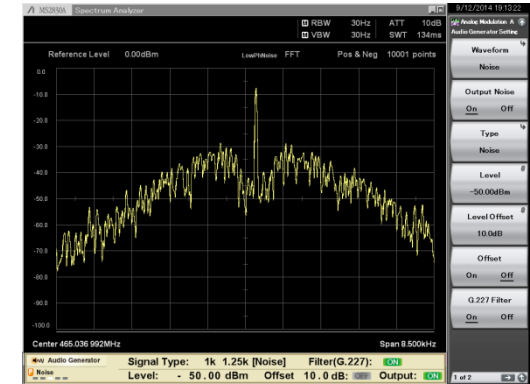
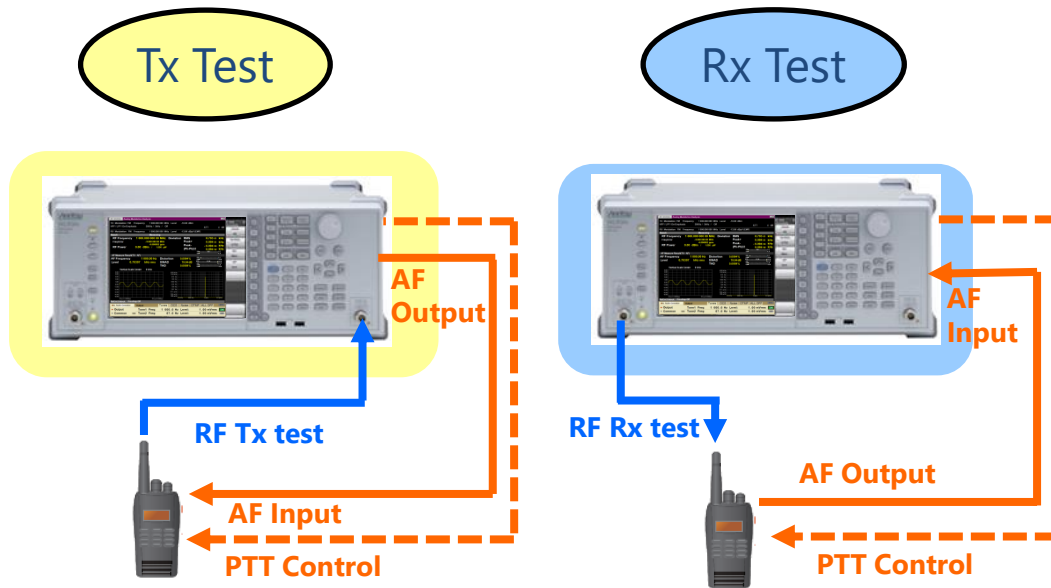

By using the spectrum analyzer display it is possible to measure the spurious and occupied bandwidth (OBW) while outputting an AF signal such as white noise (ITU-T G.227) from the Audio Analyzer option.

## Key Measurement Test Items (FM Radio Equipment)

Tx Test : Tx Power, Tx Frequency, FM Deviation, Microphone input sensitivity, Modulation frequency characteristics, Distortion, S/N, Tone frequency, Occupied bandwidth (OBW)/Spurious emission or Unwanted emission strength (White noise (ITU-T G.227) output supported)

Rx Test : Receiving sensitivity (SINAD and NQ method), Bandwidth, AF level, Demodulation frequency characteristics, Distortion, S/N, Squelch sensitivity

See MX269018A Product Introduction for more details.

# Software Download Service

## Software download service

This service, which provides updated versions of firmware and software for downloading by product customers, is available on Anritsu's website.

Download software list

Firmware / Software	Contents	Available version
<b>MS2830A Software Installer</b>	<b>MX269000A Standard Software</b> This software is installed as standard when shipping the main frame. Spectrum Analyzer function, Signal Analyzer function, etc. <b>MX2690xxA series Measurement Software</b> Measurement software for various communication systems.	The latest version is available on the website.
<b>MX370100A IQproducer Installer</b>	<b>MX2699xxA series IQproducer</b> PC application software used for generating waveform pattern for various communication systems	The latest version is available on the website.
<b>Standard waveform patterns</b>	<b>MX269099A Standard waveform pattern</b> This waveform pattern is installed as standard when shipping the MS2830A-020/021 or MS2830A-189. The latest version is installed when shipping.	Only the updated waveform pattern is available on the website.

User registration is required for using the software download service.

User registration can be performed on the Anritsu website:

<https://login.anritsu.com/signin>



The Anritsu logo is displayed in a bold, teal, sans-serif font. Below it, the tagline "Advancing beyond" is written in a smaller, black, sans-serif font. The background features a light green gradient with several curved, parallel lines in shades of green and yellow on the right side.

# Anritsu

Advancing beyond