

MP1800A Series

Signal Quality Analyzer

32 Gbit/s Signal Integrity Test Solution



Welcome to a 32-Gbit/s



Computer Server

- 100GbE (25Gx4): 100GBASE-CR4, KR4, SR4, KP4
- Infiniband FDR (14G)/EDR (26G)
- 32G Fibre Channel
- CEI-28G, CEI-56G, PAM4 for Back Plane
- Active Optical Cable (AOC)
- PCI Express, USB, Thunderbolt

For R&D in High-speed Interconnects and 100 GbE/400 GbE Devices

The growing demands of cloud computing and high-definition video streaming are driving increases in server and storage transmission speeds as well as in the transmission capacity of core networks. To meet these needs, the transmission speeds of physical-layer devices and modules are increasing, making signal integrity analysis ever more important in assuring quality. Installing the 28/32G Multi-Channel PPG and ED Module supports PCBs with high-speed interconnects up to 32.1 Gbit/s, BER measurements for device R&D, and simultaneous measurement of crosstalk between multi-channels, for more accurate signal integrity analysis.

- 400GbE (25Gx16)
- 100GbE (25Gx4) / OTU4 (28Gx4)
- DP-QPSK, 16QAM, 64QAM
- CEI-25G, CEI-28G-VSR
- CDFP, CFP/CFP2/CFP4, QSFP/QSFP28 Module

Optical Module Network Equipment

Module Configurations for Multi-channel BER and Jitter Measurements

MP1800A Signal Quality Analyzer is a modular BERT with plug-in modules;

- Pulse Pattern Generator (PPG) supporting high quality output and high amplitude signals
- Error Detector (ED) with high input sensitivity and internal Clock Recovery supporting signal analysis, such as Bathtub and Eye Diagram measurements
- Jitter Modulation Source for generating various types of jitter, such as SJ/RJ/BUJ/SSC, and supporting Jitter Tolerance tests

32.1
Gbit/s

Wideband bit rates
from up to 32.1 Gbit/s

High Sensitivity
10 mV

High sensitivity
ED 10 mV (typ.)
(Single-ended, Eye Height)

Up to
8 ch

Multi-channel synchronized
pattern generation and
simultaneous BER analysis

CDR

Clock Recovery
2.4 Gbit/s to 28.1 Gbit/s
25.5 Gbit/s to 32.1 Gbit/s

PAM

PAM4/PAM8 signal generation
PAM4 BER measurement

Jitter

Jitter Tolerance test
Bathtub Jitter measurement

**Emphasis
Equalizer**

4Tap Emphasis
Passive equalizer



MP1800A

Versatile signal integrity measurement functions

- ▶ TJ/DJ/RJ/J2/J9/Bathtub Jitter, Eye Diagram, Eye Margin auto-measurements
- ▶ 32.1 Gbit/s Jitter Tolerance tests
SJ = 1 UI (fm: 250 MHz)
(using MU181500B, supports RJ/SJ/BUJ/SSC generation)
- ▶ Half Period Jitter (F/2 Jitter) Generation
- ▶ 4Tap Emphasis signal generation up to 32.1 Gbit/s (using MP1825B)
- ▶ Crosstalk testing with independent variable data skew per channel
- ▶ Internal Clock Recovery up to 32.1 Gbit/s

Excellent signal quality and Rx sensitivity

- ▶ 10 mV high input sensitivity Error Detector (ED)
- ▶ Low-jitter, High-quality waveforms
- ▶ Up to 3.5 Vp-p output amplitude enables direct-drive EML
- ▶ PAM4/PAM8 Signal Generation
(using MZ1834A/MZ1838A)
- ▶ PAM4 BER Measurement

Data patterns for various applications

- ▶ DQPSK, DP-QPSK Pre-coding
- ▶ Burst Signal tests
- ▶ Programmable data patterns up to 256 Mbit/channel
CJTPAT, CJPAT, K28.5, etc.
- ▶ PAM4 PRBS
- ▶ PCI Express, USB, Thunderbolt Compliance Test

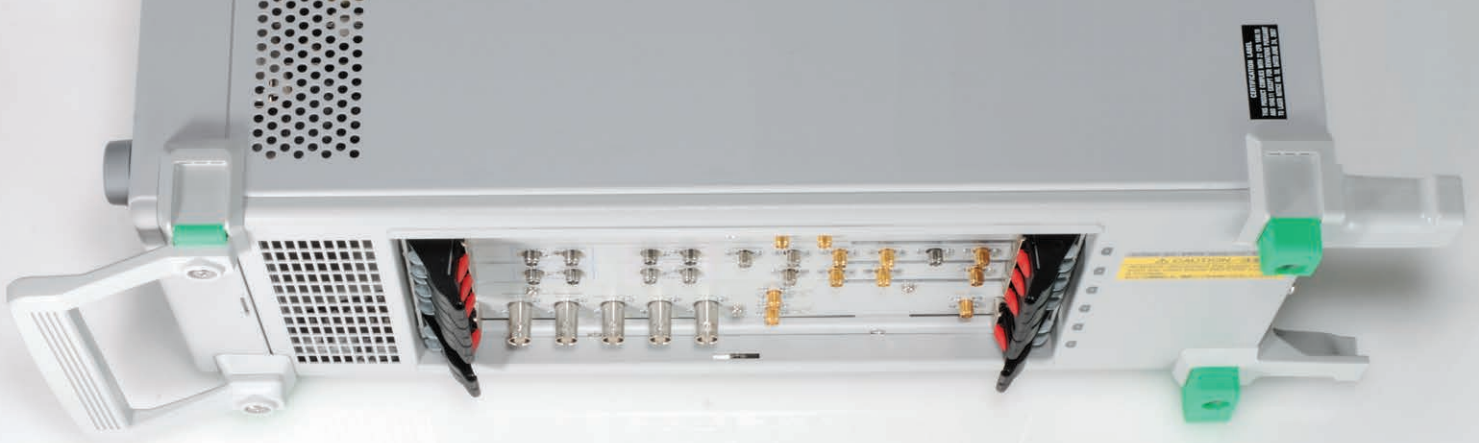

Covers Wide Range of Bandwidths and Channels

Anritsu Signal Integrity Test Solution for Every Need

Adding the 32 Gbit/s module to the MP1800A Signal Quality Analyzer supports evaluation of the physical layer for optical modules and high-speed interconnects up to 32.1 Gbit/s. Combined installation with the synthesizer and Jitter modules supports a test environment without external signal generator. Moreover, powerful signal integrity tests at up to 32.1 Gbit/s are supported by linked operation with the MP1825B 4Tap Emphasis, MZ1834A/B 4PAM Converter, MZ1838A 8PAM Converter, G0374A 64Gbaud PAM4 DAC, G0375A 32Gbaud Power PAM4 Converter and G0376A 32Gbaud PAM4 Decoder with CTLE. In addition, bit rates are supported down to 0.1 Gbit/s by changing modules as well as up to 64 Gbit/s by connecting an external MUX/DEMUX (MP1861A/MP1862A).

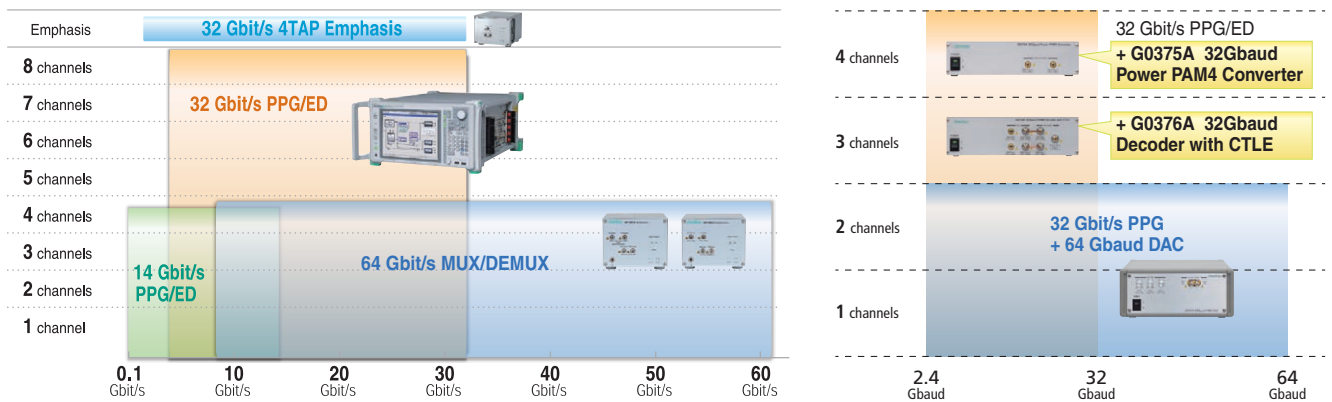

POINT

1 Supports up to NRZ 8 channels and PAM4 4 channels in 32Gbaud Band

The 4ch PPG and 4ch ED synthesizer configuration supports all-in-one evaluation of 4ch TRX devices, cutting total costs and saving space.



2 Signal Integrity Analysis using Jitter, Clock Recovery, Data Delay and 4Tap Emphasis

Jitter generation, Crosstalk tests using Data Delay, and Emphasis generation are essential tools at signal integrity analysis of high-speed interconnects. As the ideal solution, the all-in-one MP1800A supports a 2ch PPG and 2ch ED configuration with Jitter modulator, synthesizer, and individual variable delay functions, while linked operation with the compact MP1825B 4Tap Emphasis gets as close as possible to the DUT.

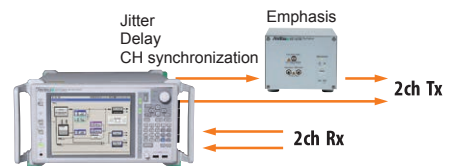

Features

Synchronization up to 8ch

Due to the modular platform design, the PPG/ED modules can be configured with various other modules to configure custom systems. The number of channels per 28G/32G PPG/ED module can be selected from 1, 2, or 4 and PPG/ED modules can be installed to support up to 8ch. Moreover, since each channel pattern can be synchronized, D/A converters, MUX/DEMUX, crosstalk, and skew tolerance can be evaluated.

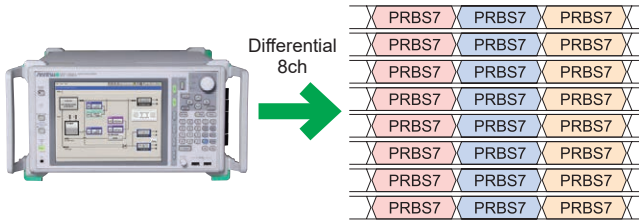

*: For details about possible module combinations, see the Option Selection Guide for the MP1800A series.

High Sensitivity Error Detector (ED)

MU183040B/MU183041B 28 G/32 Gbit/s High Sensitivity ED extends the performance of the earlier A-type ED to offer world's best Rx sensitivity* with the world's fastest Auto Adjust* (auto-align of threshold level and phase points).

The MU183040B/41B supports simultaneous multichannel measurements of low-amplitude, low Eye Opening DUTs such as High Speed Backplane devices and Active Optical Cable (AOC) to achieve more-accurate, ideal signal quality analysis.

- Eye Amplitude Sensitivity:
 - 15 mVp-p (typ.) (28.1 Gbit/s, Single-end)
 - ≤25 mVp-p (28.1 Gbit/s, Single-end)
- Eye Height Sensitivity:
 - 10 mVp-p (typ.) (28.1 Gbit/s, Single-end)

*As of September, 2013

Passive Equalizer

In high speed serial transmission such as 28 Gbit/s, transmission losses of printed-circuits boards causes the Eye Opening to become narrower.

The J1621A and J1622A Passive Linear Equalizers can be connected to the ED to compensate for PCB trace losses and improve the Eye Opening. Combination with the MU183040B/ MU183041B High Sensitivity ED supports Jitter Tolerance tests of PHY devices with a narrow Eye Opening.

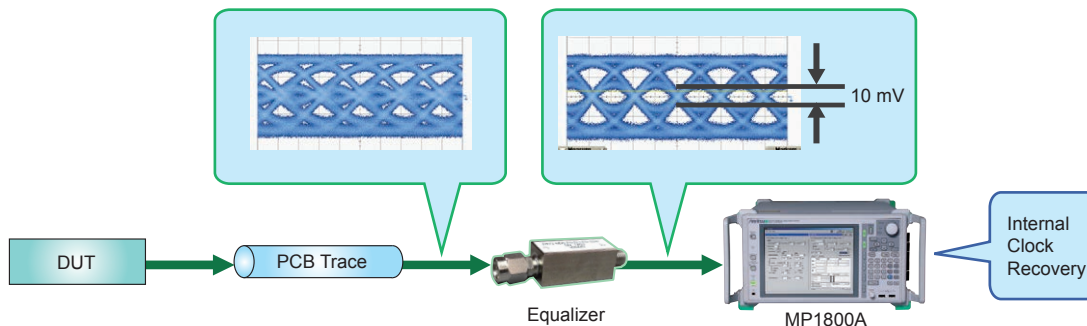

Low-jitter, High-quality Waveform

The PPG module supports low-jitter and high-quality waveforms. The output amplitude can be customized to application needs.

Low-jitter: RJ 300 fs rms (typ.)

Total RMS Jitter 700 fs rms (typ.)

High amplitude: 0.5 Vp-p to 3.5 Vp-p

[MU183020A-013/023, MU183021A-013]

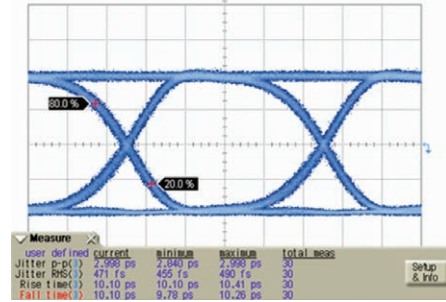

Output Waveform at 28 Gbit/s, 3.5 Vp-p (MU183020A-013) using Sampling oscilloscope with 70 GHz bandwidth

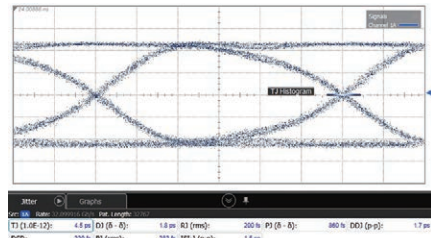

28 Gbit/s, PPG Intrinsic TJ (1E-12) = 4.5 psp-p, RJ rms = 200 fs Nominal measured data. Using Sampling Oscilloscope with 50 GHz bandwidth and <100 fs rms intrinsic jitter.

Clock Recovery

Internal Clock Recovery option can be installed in to MU183040B/41B. Physical layer (PHY) devices, such as SERDES, sometimes have different Tx and Rx Clock systems and Clock Recovery is required at the Error Detector for jitter tolerance tests. Additionally, since transmission using Multi-Mode Fiber (MMF) causes generation of jitter and wander components in the Rx module, Clock Recovery at the Error Detector is similarly required.

Installing this Clock Recovery option supports stress jitter tolerance tests of PHY devices with different Tx and Rx clocks, BER measurements of AOC devices, and simultaneous multichannel measurements, offering even more accurate and ideal signal integrity analyses.

SJ, RJ, BUJ, SSC and Half Period Jitter (F/2 Jitter) Generation

The MU181500B Jitter Modulation Source generates wide-amplitude SJ up to 1 UI at a Jitter Frequency of 250 MHz and a maximum 2000 UI, ensuring sufficient margin for receiver Jitter Tolerance tests. Additionally, the Intrinsic Jitter of 275 fs rms (nom.)* is extremely low, not only when Jitter modulation is OFF but also when 0 UI is set at Jitter modulation ON, ensuring accurate measurements even at low Jitter amplitudes. The combination of low intrinsic jitter waveform with excellent jitter transparency supports high-accuracy Jitter Tolerance tests. Moreover, simultaneous injection of RJ, BUJ and SSC as well as dual SJ for two-tone supports various Jitter Tolerance tests. Additionally, the MX183000A High-Speed Serial Data Test Software supports multi-mask tables as well as easy mask editing to support next-generation standards.

*: Phase noise measurement with using Spectrum Analyzer and 1010...repetition signal.

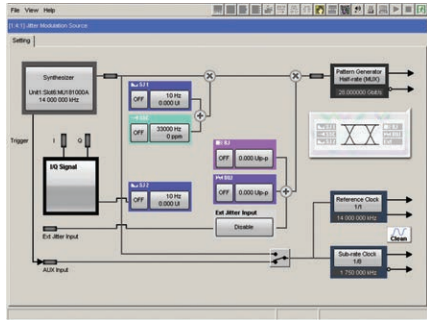

MU181500B Jitter Modulation Source Setting Screen

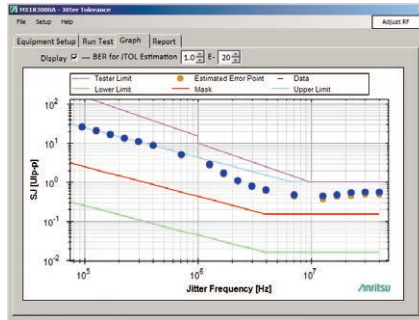

MX183000A High-Speed Serial Data Test Software Measurement Screen

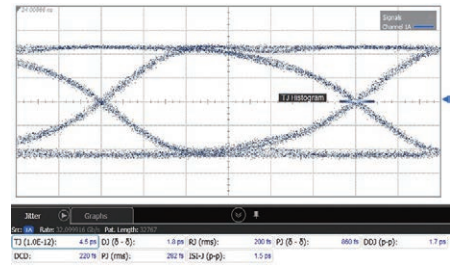

28 Gbit/s, PPG Intrinsic RJ rms Using Sampling oscilloscope with 50 GHz bandwidth and <100 fs rms intrinsic jitter

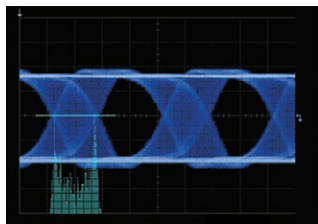

Sinusoidal Jitter (SJ)

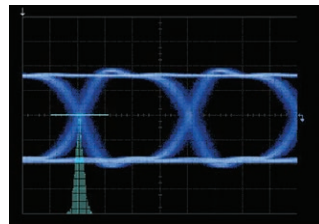

Random Jitter (RJ)

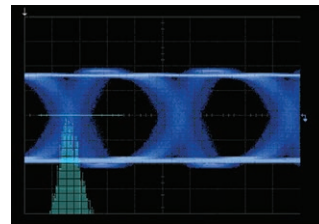

Bounded Uncorrelated Jitter (BUJ)

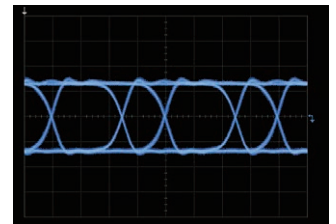

Half Period Jitter (F/2 Jitter)

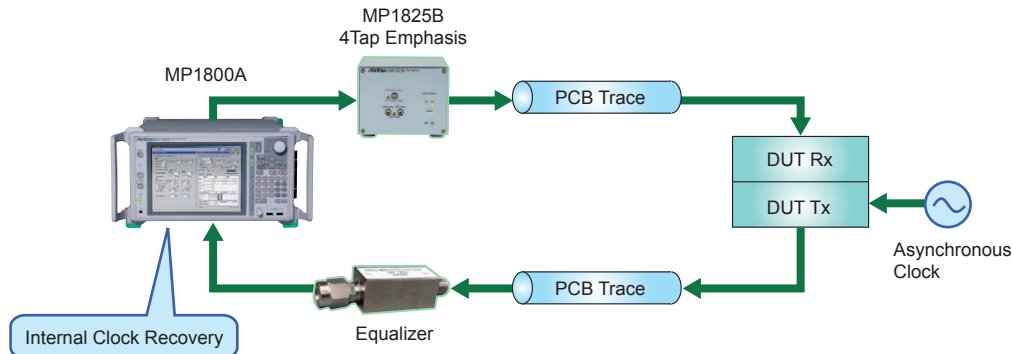

PAM4/PAM8 Signal Generation

Combining the Anritsu MZ1834A/B 4PAM Converter, MZ1838A 8PAM Converter and G0375A 32Gbaud Power PAM4 Converter with the MP1800A Signal Quality Analyzer supports generation of both PAM4 and PAM8 signals for R&D High Speed Backplane and 400 GbE R&D. The MP1800A high-quality NRZ waveform and wideband passive PAM converter generate high-quality PAM signals with assured S/N.

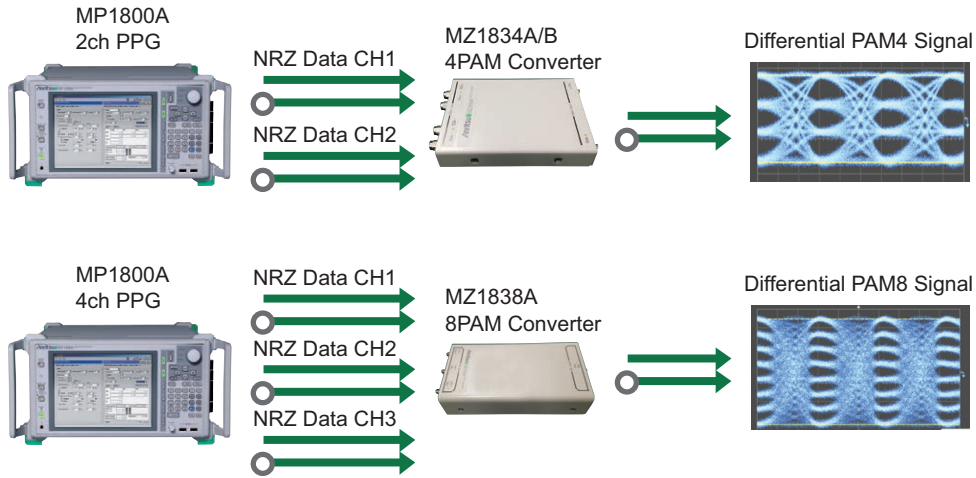

In addition, combining the MP1800A and 32Gbaud Power PAM4 Converter G0375A supports output of high-amplitude PAM4 signals and independent 3 Eye level control.

- High-amplitude PAM 4ch output
- Wideband 32.1-Gbaud rate
- High quality and low Jitter
- PAM4 Linearity control



True BER Measurement of 32Gbaud PAM4 Signal

BER measurement of PAM4 signals requires accurate measurement of bit error rates in each of three Eye patterns using a 3-ch Error Detector (ED). However, each Eye data pattern must be a programmable pattern due to differences in regular PRBS. Moreover, since 2-bit data is split between three Eye patterns, errors may be counted twice by mistake at simple error measurements for each Eye, so the true BER cannot be measured.

The BER of the three Eye patterns of a PAM4 data signal can be measured simultaneously by combining the K240C Power Divider and K241C Power Splitter with the MU18304xB High-Sensitivity ED. Additionally, the True BER of PAM4 signals can be measured using both the MP1800A long-memory programmable pattern function and the error mask function for removing unwanted errors.

In addition, the standard built-in functions support separate BER measurements for each of the Top/Middle/Bottom Eye parts, repeated Auto Search and BER measurements using ED 1ch, and calculation and display of PAM4 total BER results from measured results.

Moreover, versatile automatic measurement functions* enable easy and efficient testing.

- Auto Search function automatically detects each decision point (both the amplitude and phase) of Upper, Middle and Lower Eye.
- Simultaneous Bathtub Jitter measurement for PAM 3Eyes
- Eye Margin, Eye Diagram and Q-value measurement

*: MP1800A Software Version 7.9 or later.

Eye Height >50 mV at the input of ED is required for PAM4 automatic measurement function.

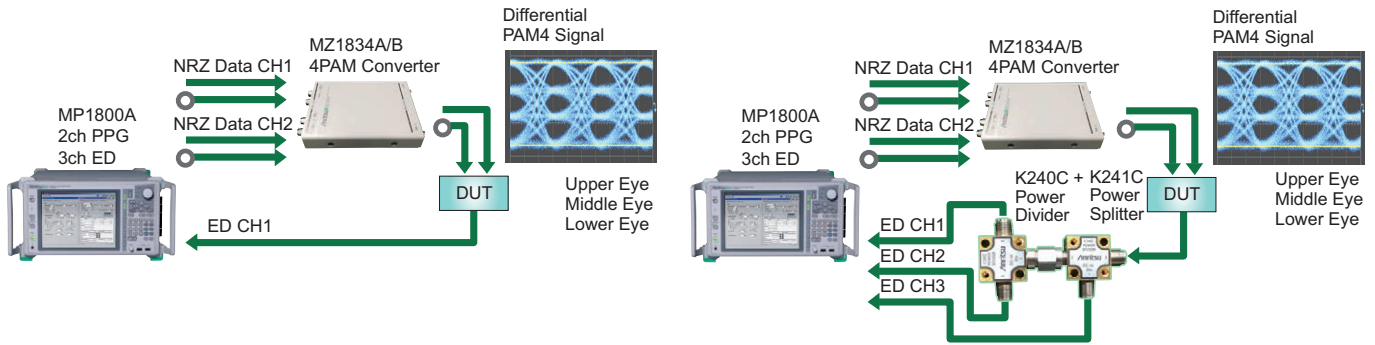

PAM4 Total BER Measurement

True BER Measurement at PAM4 signal

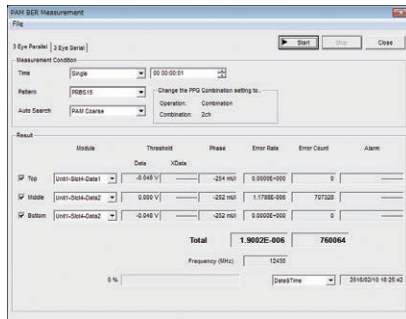

PAM4 Total BER Measurement Screen

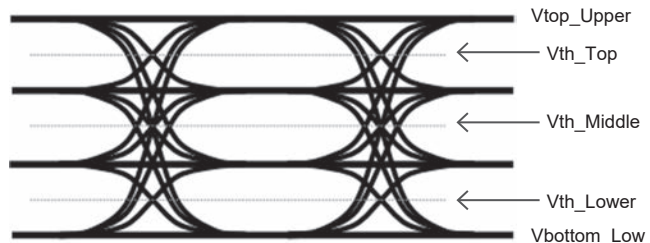

Sampling Measurement of PAM4 Signal at 1ch ED

Moreover, the MSB and LSB can be measured separately, and the BER can be measured in real-time using the high input sensitivity of the 32Gbaud PAM4 Decoder with CTLE G0376A and PAM4 Decode function.

- Baud Rate of 10 to 32.1 Gbaud
- High Input Sensitivity of 40 mV typ. (per Eye, Single-end, G0376A Data input)
- Continuously Variable CTLE Gain of -12 to 0 dB for PAM4 BER Measurement after Adjustment of Eye Opening
- Real-time PAM4 BER Measurement using PAM4 Decoder + 2ch Error Detector
- CDR function (with MU183040B-022)
- Compact Remote Head for Close DUT Measurement (Remote Control between G0376A and MP1800A)

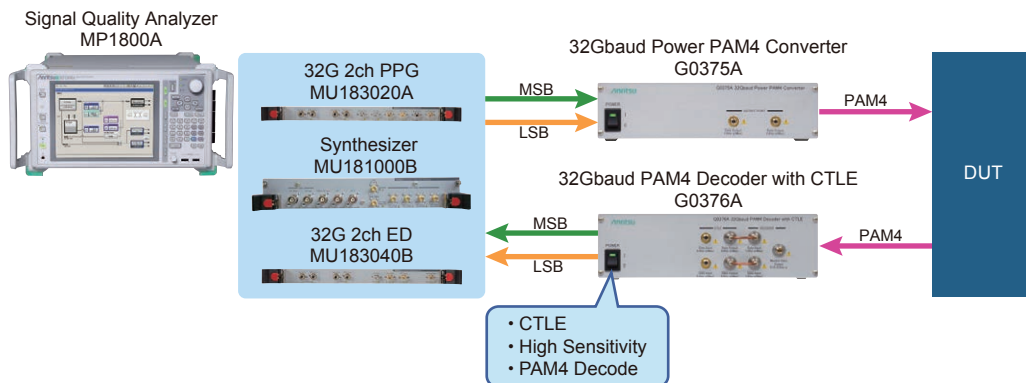

64Gbaud PAM4 BER Measurements

The G0374A 64Gbaud PAM4 DAC has two built-in 64G 2:1 multiplexers for generating 64-Gbaud PAM4 signals simply by using a 32-Gbit/s NRZ signal source (PPG). The compact, all-in-one G0374A connects to the DUT using a Remote Head with short cable to minimize loss and provide high-quality waveform PAM4 signals. Moreover, BER measurements of PAM4 signals up to 56Gbaud are supported by combining the 56G/64G bit/s DEMUX MP1862A and 32G ED.

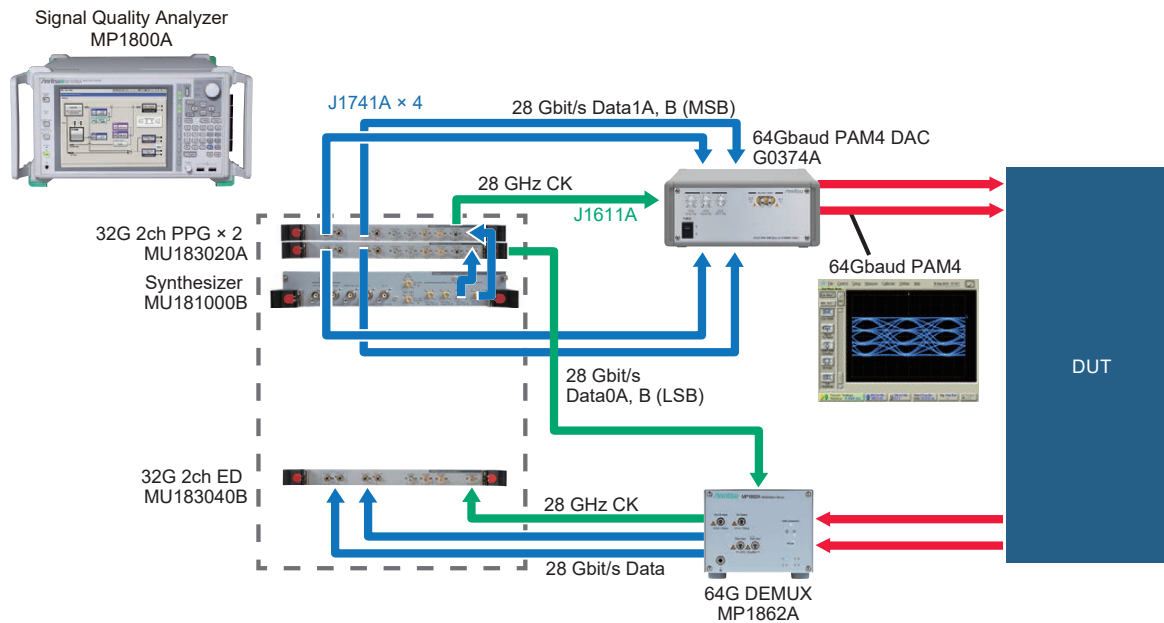

4Tap Emphasis

Combined use with the MP1825B 4Tap Emphasis supports generation of pre-emphasis 2- and 3-tap signals for standards up to 32.1 Gbit/s as well as 4-tap signals. The effect of pre-emphasis and de-emphasis can be confirmed accurately because each tap can be changed independently.

Since the MP1825B can be installed as a remote head for the MP1800A close to the Device Under Test (DUT), the shorter cables keeping signal quality high. Accurate Jitter Tolerance tests corrected using pre-emphasis signals are supported by the transparent input data and clock jitter.



MP1825B

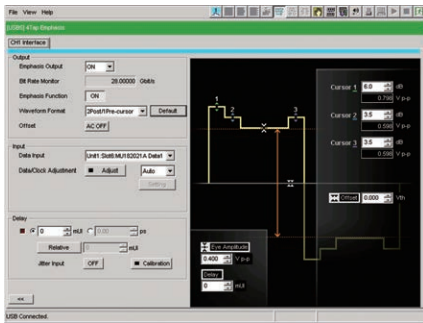

MP1825B 4Tap Emphasis Setting Screen

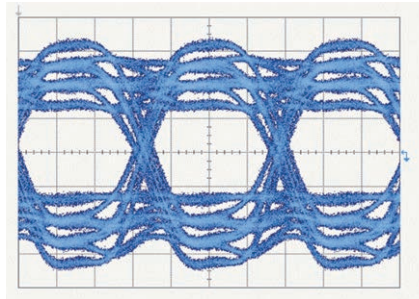

Waveform with PRBS31 Test Pattern

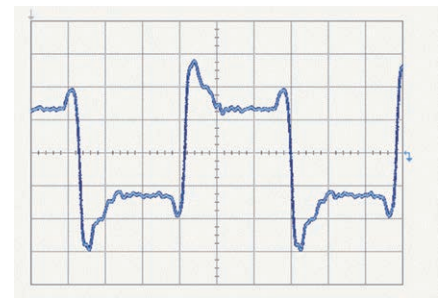

Waveform with FF00 Test Pattern

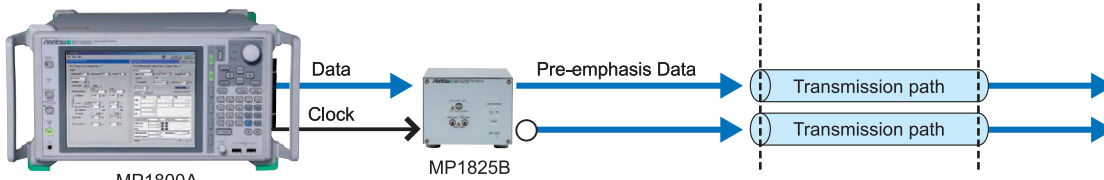
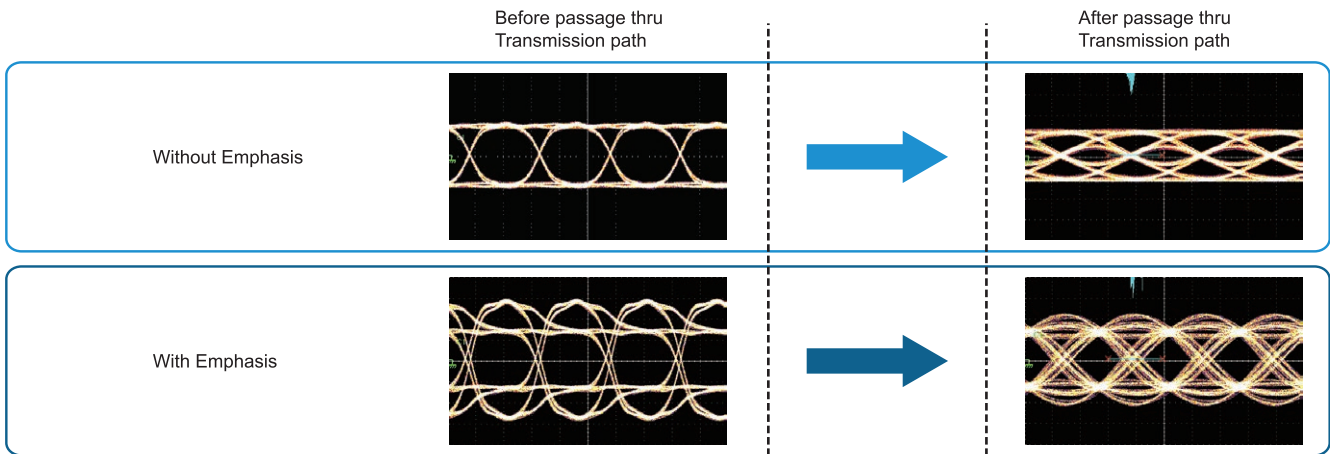

Optimizing Pre-emphasis/De-emphasis Effect

Bathtub Jitter

Measures optimum bit error rate based on changes in bit error rate relative to phase margin and performs jitter analysis (TJ, DJ, RJ).

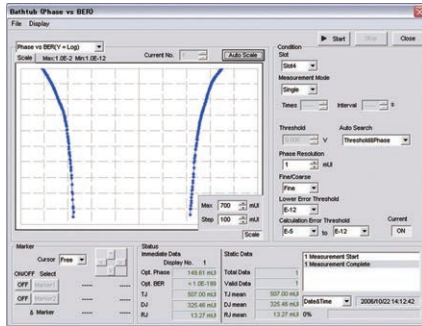

Eye Contour Function

Contours can be estimated quickly up to BER 1E-20 based on the Bathtub estimate. Any of the Upper/Middle/Lower part of the Eye of either NRZ or PAM4 signals can be specified and measured.

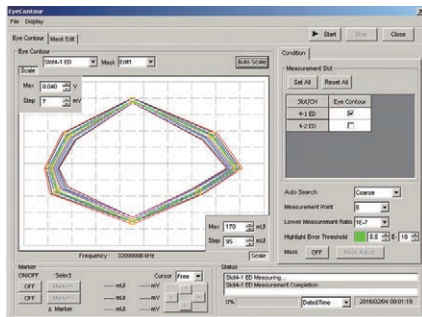

Eye Margin

Confirms Data threshold and phase margins.

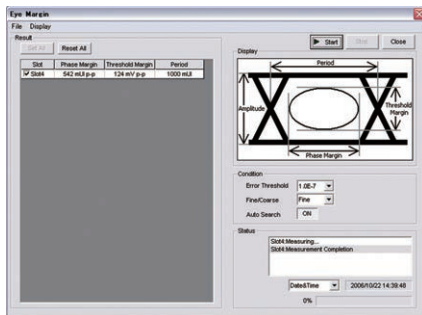

Q Measurement

Calculates Q-value from bit error rate using change in threshold value. Can be used to check change in Q-value for clock phase.

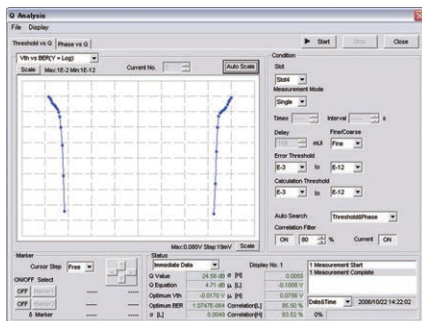

Crosstalk Test

Independently controls phase for each channel using built-in PPG Data Delay option to examine DUT crosstalk characteristics with excellent accuracy in 1-mUI steps.

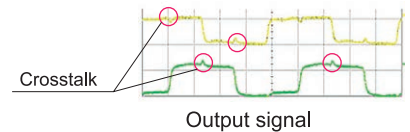
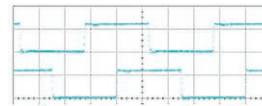

Versatile Pattern Generation

• Pseudorandom Patterns (PRBS)

All PRBS patterns required by standards are supported up to PRBS $2^{31} - 1$.

$$2^n - 1 \quad (n = 7, 9, 10, 11, 15, 20, 23, 31)$$

• Zero Substitution Pattern

Consecutive 0 s and 1 s patterns can be added to PRBS patterns for Clock Data Recovery (CDR) tolerance tests.

$$2^n, 2^n - 1 \quad (n = 7, 9, 10, 11, 15, 20, 23)$$

• Data Pattern

Patterns required by each application, such as CJTPAT, CJPAT, K28.5 and PAM4 PRBS can be created flexibly.

256 Mbits/ch max. (Steps: 1 bit)

• Mixed Pattern

A mixed data and PRBS pattern can be output. At creation of SONET/SDH frames, adding a PRBS $2^{31} - 1$, etc., pattern to the payload supports setting of a continuous pattern across frames.

• Pre-code

The DQPSK and DP-QPSK pre-code signal generation are supported. Hardware-based generation of modulation signals produces pure PRBS31 signals without pattern length restrictions.

• Burst Signals

Application evaluation using burst signals, such as optical loop test and transmission test using quantum noise technology are supported.

• PAM4 Pattern

J03A, J03B, Linearity test pattern, SSPR, PRQS 10, 13, PRBS 13Q, Gray PRBS 13Q.

Application

30 Gbit/s Band Ultrafast Interconnect Evaluation

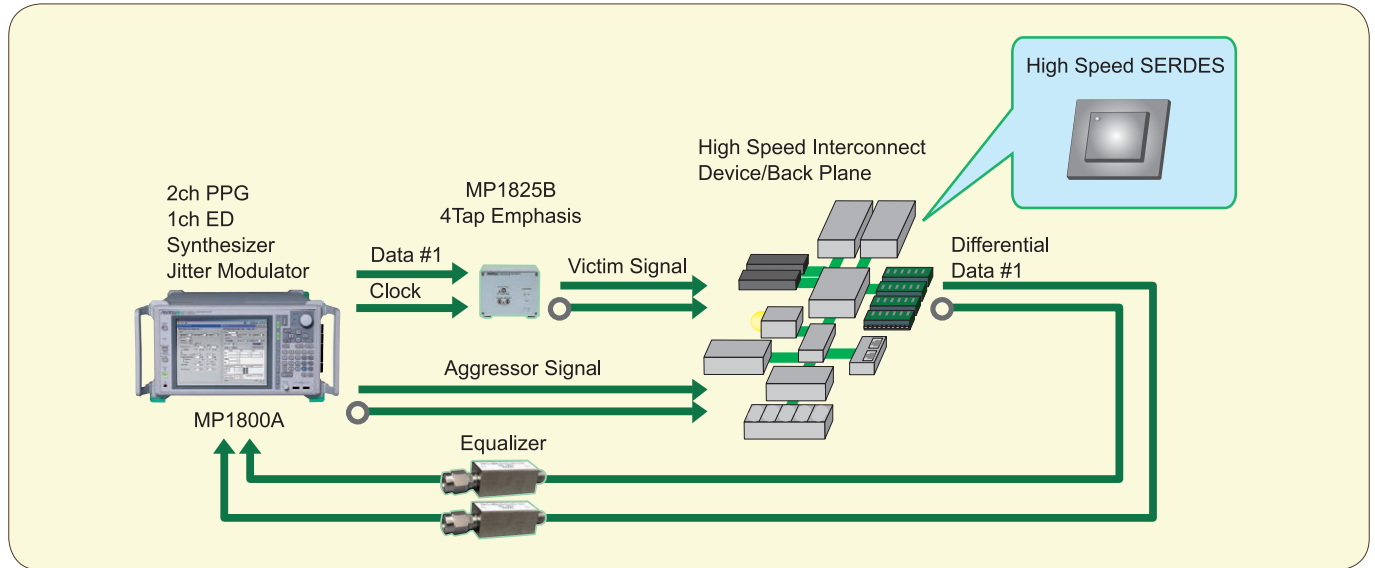

Required Test Items

- 32.1 Gbit/s Multi-channel signal generation
- Jitter Tolerance test
- Emphasis efficiency check
- Crosstalk test

Multi-channel

Along with support for multi-channels, the bit rate of devices such as backplanes of high-performance servers is becoming increasingly faster. The MP1800A supports generating both the Victim signal with controlling Emphasis and the Aggressor signal for crosstalk testing simultaneously. The MP1800A offers multi-channel measurements for TRx devices such as Transceiver, SERDES and Clock Data Recovery (CDR).

Skew and Crosstalk Effect Check

Processing high speed digital signals requires both logic tests and actual equipment tests. The MP1800A supports both pattern synchronization and phase adjustment functions, permitting easy tests of Rx device skew tolerance and crosstalk effects.

Jitter Tolerance Test

The MU181500B Jitter Modulation Source supports jitter tolerance tests of various standards because it can add SJ (dual tone), RJ, BUJ, and SSC simultaneously at up to 32.1 Gbit/s. The Eye opening of signals passing through the backplane is degraded by loss in the board traces. Due to its high input sensitivity, the MU183040B High Sensitivity Error Detector (ED) can receive data signals with low amplitude and a closed Eye-opening. Moreover, installing the Clock Recovery option supports jitter tolerance measurements of SERDES with different Tx and Rx clocks.

Verifying Emphasis Effect

The MP1825B 4Tap Emphasis is a 4 taps pre-emphasis converter for bit rates up to 32.1 Gbit/s; it supports easy changes to the pre-emphasis waveform amplitude, offset, amplitude of each taps, etc., for effective evaluation of the characteristics of high-speed interfaces below 10 Gbit/s, such as PCIe, USB, and Backplane Ethernet requiring pre-emphasis signals, as well as InfiniBand 26G-IB-EDR, CEI-28G-VSR, 32G FC, etc., in the 30 Gbit/s band.

InfiniBand FDR (14G)/EDR (26G) AOC Evaluation

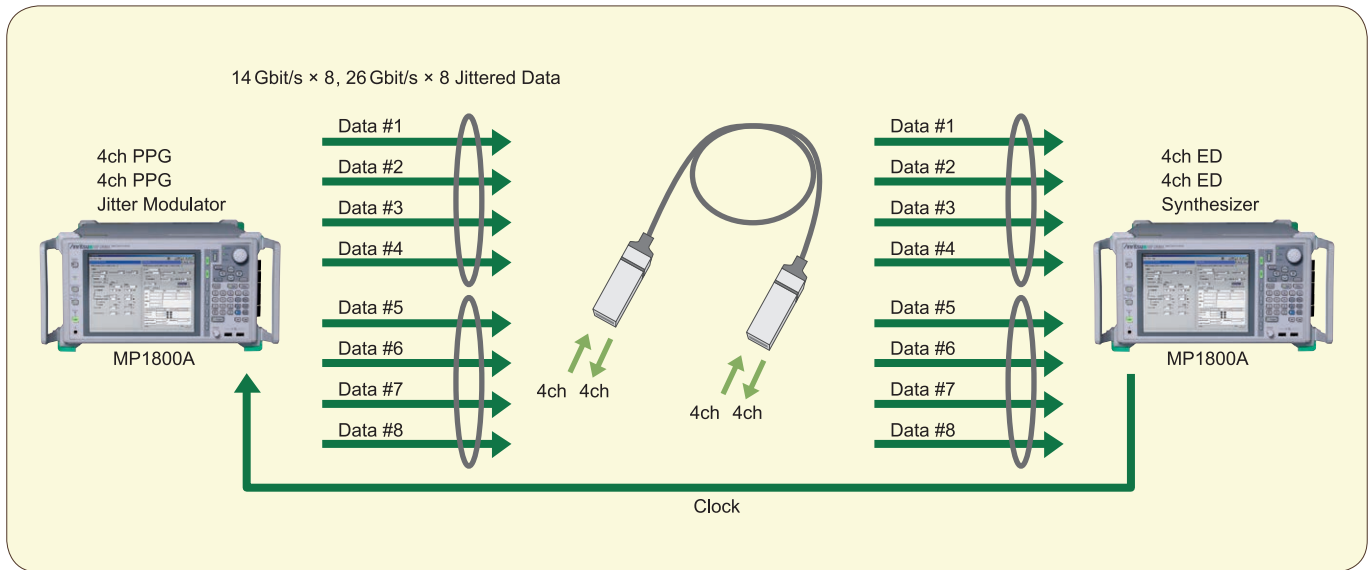

Required Test Items

- Simultaneous 8ch (2 × 4ch end-to-end) BER measurement
- Crosstalk test
- Jitter Tolerance test
- Bathtub Jitter, Eye Diagram analysis



Anritsu MP1800A is recognized to test equipment for IBTA Integrators' List.

8ch (2 × 4ch End-to-End) Simultaneous Measurement

InfiniBand QSFP-type active optical cables (AOC) support simultaneous transmission for up to 8 channels using 2 × 4ch end-to-end transmission. One MP1800A unit supports up to 8ch (with PPG 8ch, ED 8ch, or PPG 4ch + ED 4ch installed) and all channels can be measured simultaneously using two MP1800A units for fast measurement with high performance.

Jitter Tolerance Test

The MU181500B Jitter Modulation Source supports Jitter Tolerance tests of various standards because it can add SJ (two types), RJ, BUJ, and SSC simultaneously at up to 32.1 Gbit/s. AOC are being used more commonly in data centers due to the need to reduce power consumption as well as decreases in I/O amplitudes. Due to its high input sensitivity, the MU183040B High Sensitivity ED can receive low-amplitude, closed Eye-opening data signals to help cut measurement times to less than 1 second using the Auto Adjust function. In addition, adding the Clock Recovery option simplifies the measurement system and supports easy jitter tolerance tests.

Crosstalk Effect Check

Processing high-speed digital signals requires both logic tests and actual equipment tests. The MP1800A supports both pattern synchronization and phase adjustment for each channel, permitting easy testing of AOC crosstalk effects.

Bathtub Jitter and Eye Diagram Analysis

The built-in ED Clock Delay function supports Bathtub Jitter (TJ, RJ, DJ) analysis. Low bit error rates of 1E-12, 1E-15, etc., can be estimated quickly from transitions in bit error rate versus phase.

100 GbE/400 GbE Devices CFP2/CFP4/CDFP Evaluation

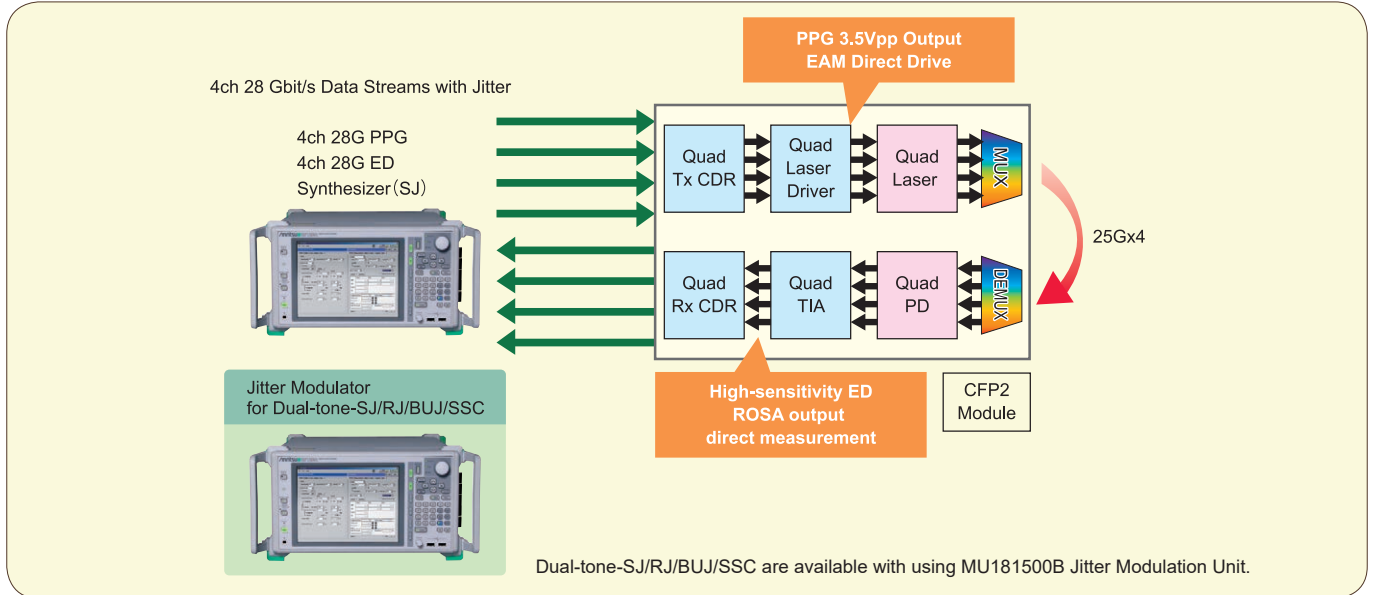

Required Test Items

- Simultaneous 4ch BER measurement
- Optical output waveform optimization using cross-point adjustment
- Inter-lane timing and skew control
- Jitter Tolerance test
- High-quality and high-amplitude waveform ideal for EML module evaluation (3.5 Vp-p option)

100 GbE, 25G × 4λ Evaluation

The MP1800A can evaluate EML devices and optical modulators for 100-GbE standardized by IEEE802.3ba using PPG/ED modules supporting bit rates up to 32.1 Gbit/s. 4ch EML devices can be driven independently and simultaneously for accurate evaluation with excellent cost performance.

Optimum Signal Quality for EML Evaluation

EML devices can be direct-driven by the Variable Data Output Function at up to 3.5 Vp-p. The amplitude and crosspoint are easily adjusted on-screen, shortening evaluation times and offering high-reliability evaluation.

Skew and Crosstalk Effect Check

Applications using high-speed digital signals require both logic tests and actual equipment tests. The MP1800A supports both pattern synchronization and phase adjustment functions, permitting easy tests of Rx device skew tolerance and crosstalk effects.

Jitter Tolerance Test

Installing Option-001 Jitter Modulation in the MU181000B 12.5 GHz 4 port Synthesizer supports SJ generation for jitter tolerance tests of CFP2/4 modules.

Furthermore, adding the Clock Recovery option simplifies the measurement system for easy jitter tolerance tests.

100 Gbit/s Band DP-QPSK and 40 Gbit/s Band DQPSK Evaluation

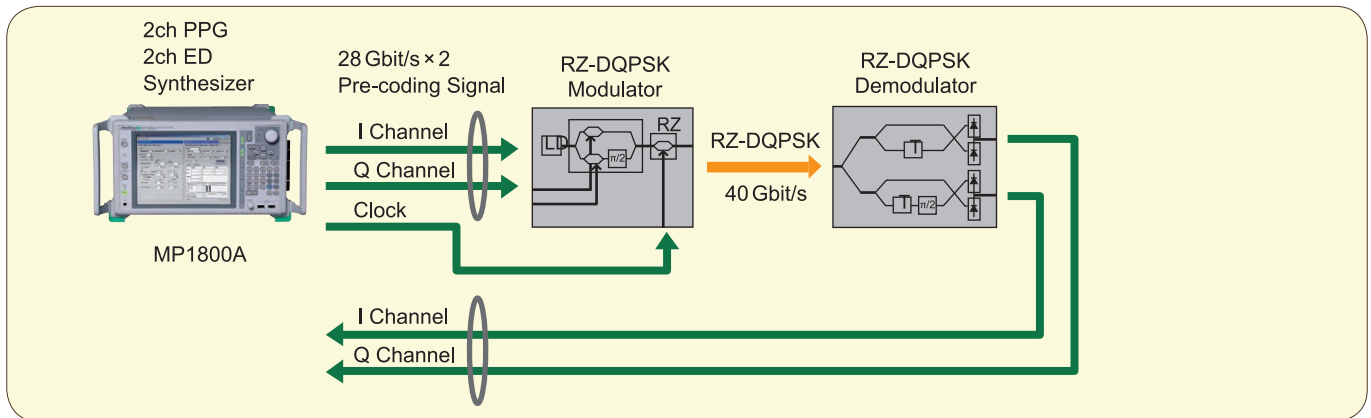
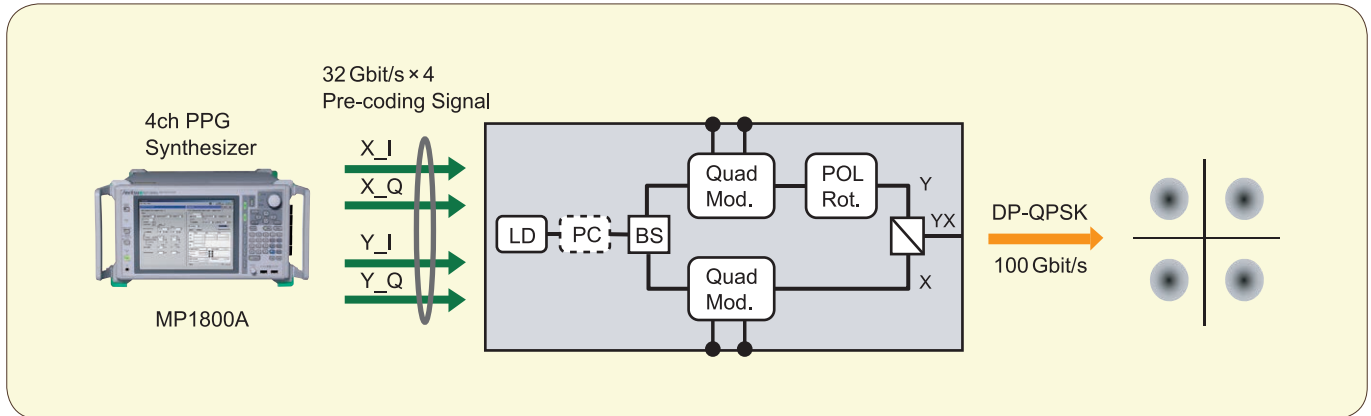

Required Test Items

- Pre-coding signal generator synchronized between channels
- Optical output waveform optimization using cross-point adjustment
- Timing control and skew control between channels
- Modulator input level tolerance

2ch/4ch Synchronization Pre-code Signal Generation

The Pre-code function automatically generates 100G DP-QPSK and 40G DQPSK modulation signals for evaluating optical modulators. Hardware-based generation of modulation signals produces pure PRBS31 signals without pattern length restrictions, resulting in high-reliability evaluations using high-load pseudo-random patterns closely approximating real signals.

Skew Effect Check

Processing high-speed digital signals requires both logic tests and actual equipment tests. The MP1800A supports both pattern synchronization and phase adjustment functions, permitting easy tests of Rx device skew tolerance and crosstalk effects.

Optimum High-quality Waveform for MZ-Modulator Evaluation

MZ-Modulator can be direct-driven by the Variable Data Output function at up to 3.5 Vp-p. The amplitude and crosspoint are easily adjusted on-screen, shortening evaluation times and offering high-reliability evaluation.

PCI Express Device Evaluation Setup

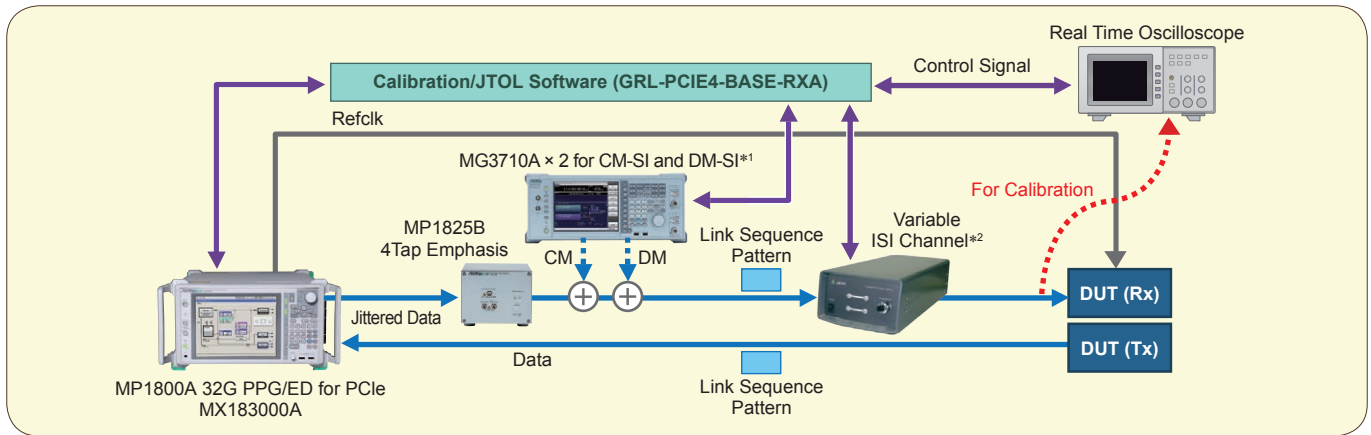

*1: The MG3710A is used at common mode noise and differential mode noise loads.
 *2: The Variable ISI Channel is used at the ISI (Inter Symbol Interference) load test.

Required Functions

- Loopback State Setting Function
- Jitter Tolerance Function
- Automatic Receiver Test Function

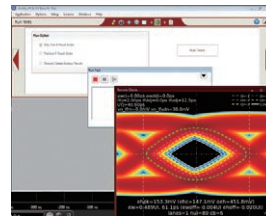

Automated Stressed Rx Eye Calibration with Seasim

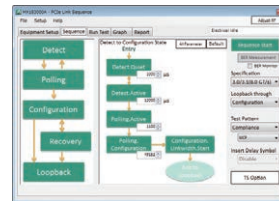

PCIe Link Sequence Generate Screen

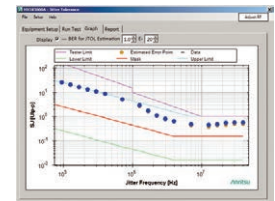

Measurement Item	Supported Software
Stressed Signal Calibration	GRL-PCIE4-BASE-RXA(PCI Express 4.0 Rx Base Spec)
Transition to Loopback State	MX183000A (Option PL011)
Jitter Tolerance Test	MX183000A (Option PL011, Jitter Tolerance Margin Measurement) GRL-PCIE4-BASE-RXA (Pass/Fail Evaluation)

Supported Standards: PCI Express (1.x/2.0/3.x/4.0)

DUT	Link Sequence Generation	Jitter Tolerance Test
When both Common Clock Architecture and DUT Loopback data SSC OFF	Supported	Supported
When both Common Clock Architecture and DUT Loopback data not SSC OFF	Not supported	Not supported

Link Sequence Generation

The Link status required for measurement can be configured automatically using the MX183000A and options.

- Controls status of PCI Express Rev 1.x/2.0/3.x/4.0 devices and evaluates Logical Sub Block

Jitter Tolerance Tests

- SJ/RJ required for evaluating PCI Express 4.0 devices can be impressed to support PHY device jitter tolerance tests.
- Device margins can be verified using low-rate BER estimates.
- Measurement results can be saved as HTML or CSV format reports.

Receiver Test

Calibration and the Jitter Tolerance test can both be automated using the GRL-PCIE4-BASE-RXA software. Automation helps cut design verification times.

* The GRL-PCIE4-BASE-RXA software is a Granite River Labs product.

USB Device Evaluation Setup

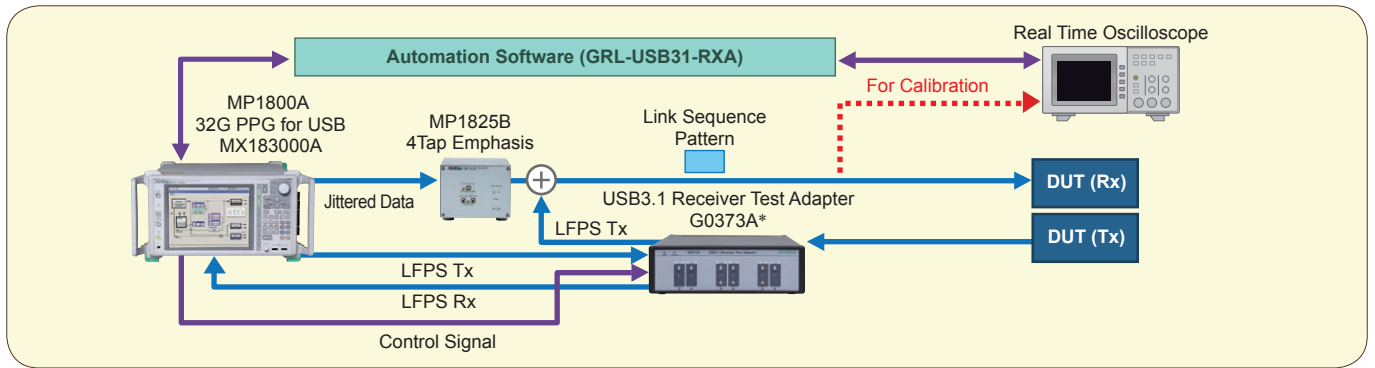

*: G0373A is used for LFPS (Low Frequency Periodic Signal) generation and BER measurement.

Required Functions

- Loopback State Setting Function
- Jitter Tolerance Function
- Automatic Receiver Test Function

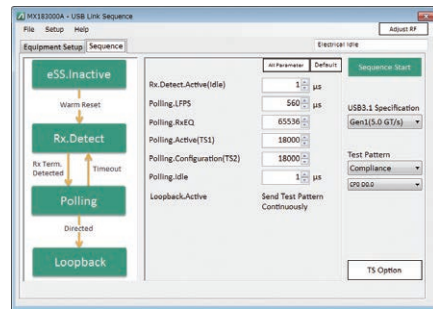

USB Link Sequence Setting Screen

Measurement Item	Supported Software
Stressed Signal Calibration	GRL-USB31-RXA
Transition to Loopback State	MX183000A (Option PL012)
Jitter Tolerance Test	MX183000A (Option PL012), GRL-USB31-RXA

Supported Standards: USB (3.0/3.1 Gen1 and Gen2)

DUT	Link Sequence Generation	Jitter Tolerance Test
Host Device	Supported	Supported

Link Sequence Generation

The Link status required for measurement can be configured automatically using the MX183000A and options.

- The test mode can be transitioned to the Loopback mode required for evaluating USB3.1 Gen1 and Gen2 devices. (MX183000A-PL012)

BER Measurements

The BER of USB3.1 Gen1 and Gen2 devices can be measured from the Link status probability.

Receiver Test

Calibration and the Jitter Tolerance test can both be automated using the GRL-USB31-RXA. Automation helps cut design verification times.

Thunderbolt Device Evaluation Setup

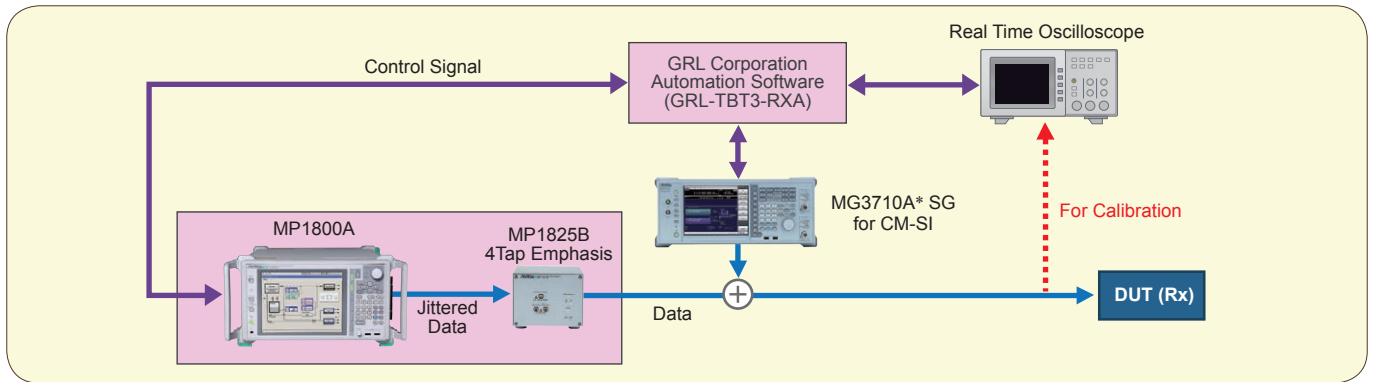

*: The MG3710A is used at common mode noise loads.

Thunderbolt Cable Evaluation Setup

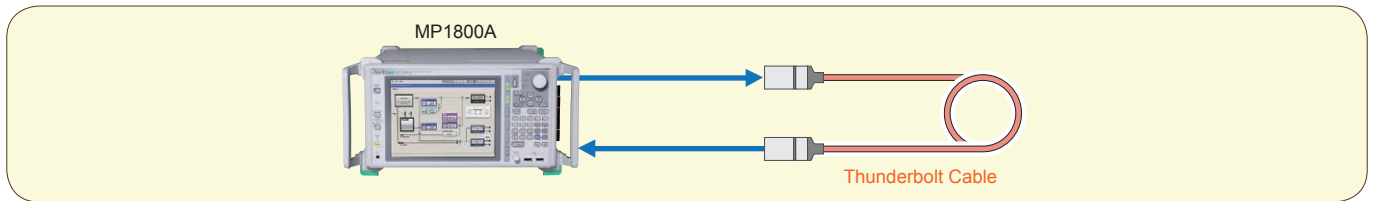

Required Functions

- 20 Gbit/s PPG
- Stressed Signal Calibration Function
- Jitter Tolerance Function



Anritsu MP1800A is recognized to recommended test equipment for Thunderbolt Compliance Test.

Measurement Item	Supported Software
Stressed Signal Calibration	GRL-TBT3-RXA (Thunderbolt 3)
Jitter Tolerance Test	GRL-TBT3-RXA (Pass/Fail) Evaluation

Supported Standards: Thunderbolt (2/3)

DUT	Jitter Tolerance Test
Host Device	Supported

Supports Thunderbolt 3

Supports Thunderbolt 3 specified bit rates (20G)

Stressed Signal Calibration

GRL Automation Software supports automatic stressed signal calibration as specified by Thunderbolt 3 (USB Type-C Thunderbolt Alternate Mode Electrical Host/Device Compliance Test Specification).

Stressed Signal Input Test

- Supports Rx BER measurements required by Host/Device compliance test
- Supports automatic Rx test using Tenlira scripts
- Supports automatic Pass/Fail measurement for Rx stressed signal tests

Receiver Test

Calibration and the Jitter Tolerance test can both be automated using the GRL-TBT3-RXA software. Automation helps cut design verification times.

* The GRL-PCIE4-BASE-RXA and GRL-TBT3-RXA software are Granite River Labs products.

25G/100 Gbit/s PON OLT Module Evaluation

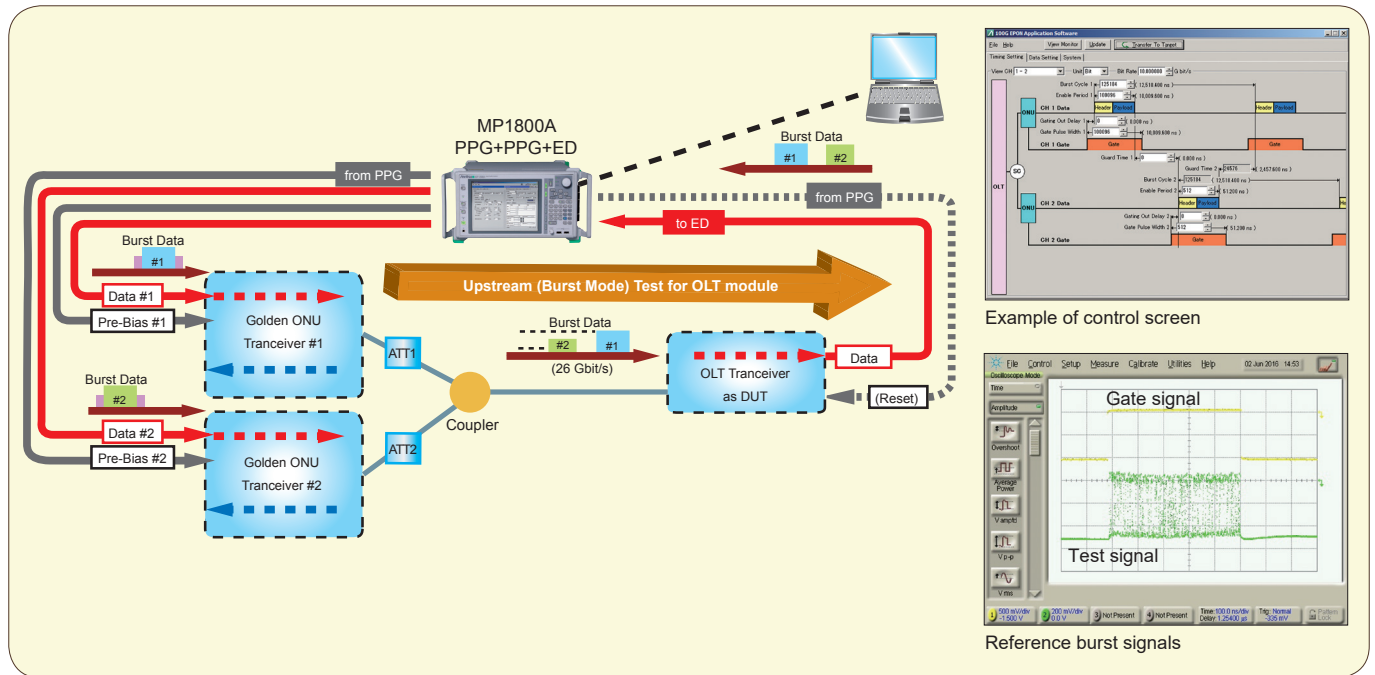

The PON OLT Upstream test can be performed using one MP1800A and MX180014A 100G EPON Application Software

Required Functions

- 100G-EPON OLT/ONU BER measurement
- Multichannel synchronization and skew adjustment
- High-reproducibility BER measurement
- Setting 2ch test signal pattern length and timing
- Background pattern editing (pattern insertion into non-burst signal part)

Module Panel Layout

• MU183020A 28G/32G bit/s PPG (1ch or 2ch)

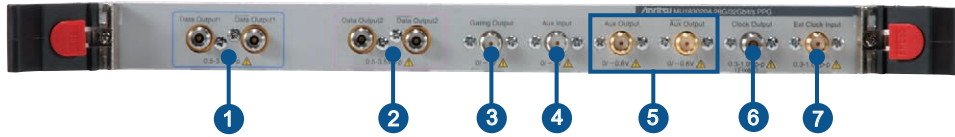

1	Data1/XData1 Output*1	Output for 1ch differential data signal	5	Aux/XAux Output	Output for differential auxiliary signal
2	Data2/XData2 Output*2	Output for 2ch differential data signal	6	Clock Output	Output for clock signal
3	Gating Output	Output for burst timing signal	7	Ext Clock Input	Input for external clock signal
4	Aux Input	Input for auxiliary signal			

• MU183021A 28G/32G bit/s 4ch PPG

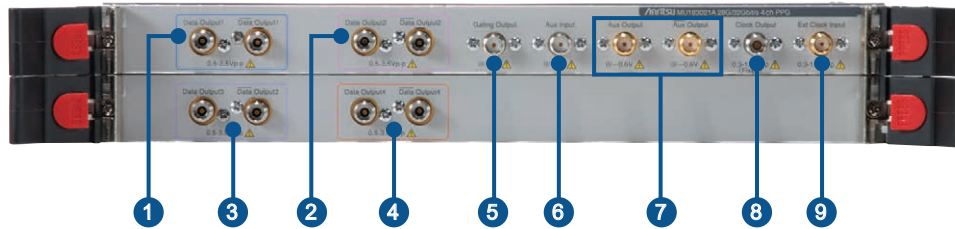

1	Data1/XData1 Output	Output for 1ch differential data signal	6	Aux Input	Input for auxiliary signal
2	Data2/XData2 Output	Output for 2ch differential data signal	7	Aux/XAux Output	Output for differential auxiliary signal
3	Data3/XData3 Output	Output for 3ch differential data signal	8	Clock Output	Output for clock signal
4	Data4/XData4 Output	Output for 4ch differential data signal	9	Ext Clock Input	Input for external clock signal
5	Gating Output	Output for burst timing signal			

• MU183040B 28G/32G bit/s High Sensitivity ED (1ch or 2ch)



1	Data1/XData1 Input*1	Input for 1ch differential data signal	4	Aux/XAux Output	Output for differential auxiliary signal
2	Data2/XData2 Input*2	Input for 2ch differential data signal	5	Ext Clock Input	Input for external clock signal
3	Aux Input	Input for auxiliary signal			

• MU183041B 28G/32G bit/s 4ch High Sensitivity ED

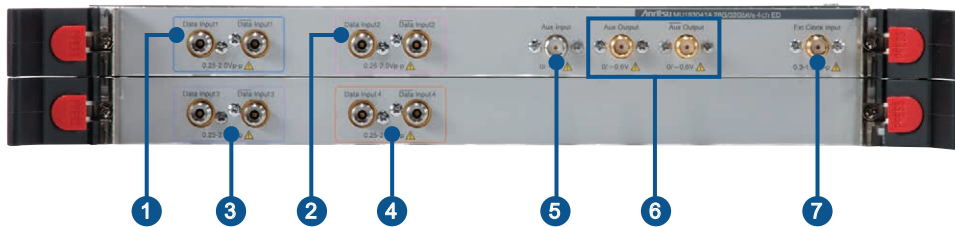

1	Data1/XData1 Input	Input for 1ch differential data signal	5	Aux Input	Input for auxiliary signal
2	Data2/XData2 Input	Input for 2ch differential data signal	6	Aux/XAux Output	Output for differential auxiliary signal
3	Data3/XData3 Input	Input for 3ch differential data signal	7	Ext Clock Input	Input for external clock signal
4	Data4/XData4 Input	Input for 4ch differential data signal			

*1: Data/XData when 1ch option was selected.
 *2: Not implemented when 1ch option was selected.

• **MU181000B 12.5 GHz 4port Synthesizer**

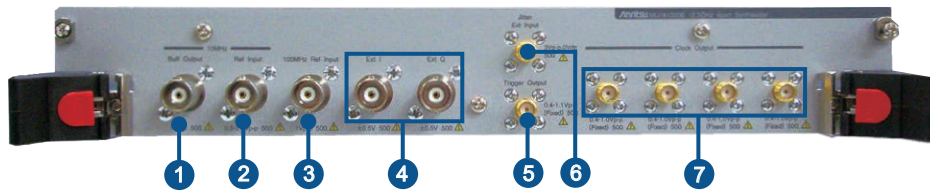

1	10 MHz Buff Output	Output for 10 MHz reference clock	5	Trigger Output*3	Output for 1/64 clock or 1/1 clock
2	10 MHz Ref Input	Input for 10 MHz reference clock	6	Jitter Ext Input*3	Input for jitter modulation signal
3	100 MHz Ref Input*3	Input for 100 MHz reference clock	7	Clock Output 1 to 4	Clock output 1 to 4
4	Ext I, Q*3	Input for I, Q signal			

*3: Only enabled when Jitter Modulation option (MU181000B-001) installed

• **MU181500B Jitter Modulation Source**

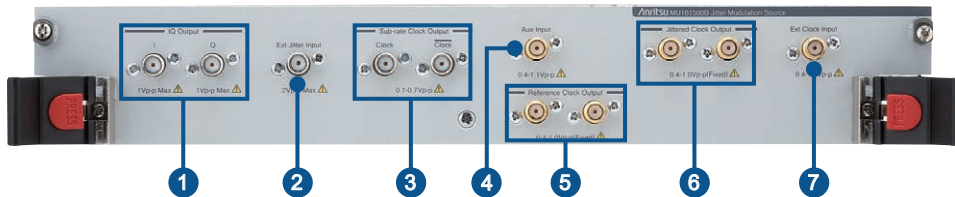

1	IQ Output	Outputs IQ signals	5	Reference Clock Output	Outputs two 1/1, 1/2, or 1/4 frequency-divided clocks based on either of following inputs: • Ext Clock Input • Aux Input
2	Ext Jitter Input	Input for modulation signal source	6	Jittered Clock Output	Outputs two jitter-modulated clock signals
3	Sub-rate Clock Output	Outputs frequency-divided clock (1/8 to 1/256) based on either of following inputs: • Ext Clock Input • Aux Input	7	Ext Clock Input	Input for external clock
4	Aux Input	Input clock signals			

Selection Guide

Category	Model Number	Model Name	28G 1ch Basic	High-speed Interconnects 32G 2ch + Jitter + Emphasis	InfiniBand QSFP 28G 8ch + Jitter	100 GbE/ Silicon Photonics 28G 4ch	DP-QPSK 32G 4ch PPG	PAM4	PAM8
Main Frame	MP1800A	Signal Quality Analyzer	1	1	2	1	1	1	1
	MP1800A-015	4-slot for PPG and/or ED	1	1	2	1	1	1	1
	MP1800A-032	32 Gbit/s PPG and/or ED Support	1	1	2	1	1	1	1
Synthesizer (Sinusoidal Jitter)	MU181000B	12.5 GHz 4port Synthesizer	1	1	1	1	1	1	1
	MU181000B-001	Jitter Modulation		1	1				
Jitter Modulator SJ (2-tone)/RJ/ BUJ	MU181500B	Jitter Modulation Source		1	1				
28G/32G PPG 1ch/2ch	MU183020A	28G/32G bit/s PPG	1	1				1	
	MU183020A-001	32G bit/s Extension		1				1	
	MU183020A-012	1ch 2 V Data Output	1*						
	MU183020A-013	1ch 3.5 V Data Output							
	MU183020A-022	2ch 2 V Data Output		1*				1*	
	MU183020A-023	2ch 3.5 V Data Output							
	MU183020A-030	1ch Data Delay							
MU183020A-031	2ch Data Delay		1				1		
28G/32G PPG 4ch	MU183021A	28G/32G bit/s 4ch PPG			2	1	1		1
	MU183021A-001	32G bit/s Extension					1		1
	MU183021A-012	4ch 2 V Data Output			2*	1*	1*		1*
	MU183021A-013	4ch 3.5 V Data Output							
	MU183021A-030	4ch Data Delay			2	1	1		1
28G/32G ED 1ch/2ch	MU183040B	28G/32G bit/s ED	1	1					
	MU183040B-001	32G bit/s Extension		1					
	MU183040B-010	1ch ED	1	1					
	MU183040B-020	2ch ED							
	MU183040B-022	2.4G to 28.1G bit/s Clock Recovery		1*					
MU183040B-023	25.5G to 32.1G bit/s Clock Recovery								
28G/32G ED 4ch	MU183041B	28G/32G bit/s 4ch ED			2	1			
	MU183041B-001	32G bit/s Extension							
	MU183041B-022	2.4G to 28.1G bit/s Clock Recovery			1	1			
	MU183041B-023	25.5G to 32.1G bit/s Clock Recovery							
Emphasis	MP1825B	4Tap Emphasis		1					
	MP1825B-001	14 Gbit/s Operation							
	MP1825B-002	28 Gbit/s Operation		1					
	MP1825B-003	14 Gbit/s Variable Data Delay							
	MP1825B-004	28 Gbit/s Variable Data Delay							
	MP1825B-005	14.1 Gbit/s Extension							
MP1825B-006	32.1 Gbit/s Extension		1						
Software	MX181500A	Jitter/Noise Tolerance Test Software		1	1				
	MX183000A	High-Speed Serial Data Test Software		1	1				
	MX183000A-PL001	Jitter Tolerance Test		1	1				
PAM Signal Generation	MZ1834A/B	4PAM Converter						1	
	MZ1838A	8PAM Converter							1
	G0375A	32Gbaud Power PAM4 Converter						1	
PAM Signal Measurement	G0376A	32Gbaud PAM4 Decoder with CTLE						1	
Equalizer	J1621A	Passive Equalizer 3 dB		2*					
	J1622A	Passive Equalizer 6 dB							

*: Select any one

Specifications

• MU183020A 28G/32G bit/s PPG, MU183021A 28G/32G bit/s 4ch PPG

Bit Rate	Operational Bit-rate Range: 2.4 Gbit/s to 28.1 Gbit/s 2.4 Gbit/s to 32.1 Gbit/s (with Option-x01)																																				
Bit-rate Setting Range (MU181000B synchronized operation)	<p>This item is specified when MU181000B is installed into the same main frame.</p> <p>When Full Rate Clock Output is selected: 2.400 000 Gbit/s to 12.500 000 Gbit/s, 0.000 001 Gbit/s step 12.500 002 Gbit/s to 25.000 000 Gbit/s, 0.000 002 Gbit/s step 25.000 004 Gbit/s to 28.100 000 Gbit/s, 0.000 004 Gbit/s step 25.000 004 Gbit/s to 32.100 000 Gbit/s, 0.000 004 Gbit/s step (with Option-x01) Offset: -1000 ppm to +1000 ppm, 1 ppm step (Offset setting range is changed depends on Bit-rate. Offset range is -1000 ppm to 0 ppm with following Bit-rate range. Full Rate: 12.500 000 Gbit/s, 25.000 000 Gbit/s, Half Rate: 25.000 000 Gbit/s)</p> <p>When Half Rate Clock Output is selected: 2.400 000 Gbit/s to 25.000 000 Gbit/s, 0.000 002 Gbit/s step 25.000 004 Gbit/s to 28.100 000 Gbit/s, 0.000 004 Gbit/s step 25.000 004 Gbit/s to 32.100 000 Gbit/s, 0.000 004 Gbit/s step (with Option-x01) Offset: -1000 ppm to +1000 ppm, 1 ppm step (Offset setting range is changed depends on Bit-rate. Offset range is -1000 ppm to 0 ppm with following Bit-rate range. Full Rate: 12.500 000 Gbit/s, 25.000 000 Gbit/s, Half Rate: 25.000 000 Gbit/s)</p>																																				
Bit-rate Setting Range (MU181000B and MU181500B synchronized operation)	<p>This item is specified when MU181000B and MU181500B are installed to the same main frame.</p> <p>When Full Rate Clock Output is selected: 2.400 000 Gbit/s to 3.125 000 Gbit/s, 0.000 001 Gbit/s step 3.200 001 Gbit/s to 6.250 000 Gbit/s, 0.000 001 Gbit/s step 6.400 001 Gbit/s to 12.500 000 Gbit/s, 0.000 001 Gbit/s step 12.800 002 Gbit/s to 25.000 000 Gbit/s, 0.000 002 Gbit/s step 25.600 004 Gbit/s to 28.100 000 Gbit/s, 0.000 004 Gbit/s step 25.600 004 Gbit/s to 32.100 000 Gbit/s, 0.000 004 Gbit/s step (with Option-x01) Offset: -1000 ppm to +1000 ppm, 1 ppm step (Offset setting range is changed depends on Bit-rate. Offset range is -1000 ppm to 0 ppm with following Bit-rate range. Full Rate: 12.500 000 Gbit/s, 25.000 000 Gbit/s, Half Rate: 25.000 000 Gbit/s)</p> <p>When Half Rate Clock Output is selected: 2.400 000 Gbit/s to 3.125 000 Gbit/s, 0.000 002 Gbit/s step 3.200 002 Gbit/s to 6.250 000 Gbit/s, 0.000 002 Gbit/s step 6.400 002 Gbit/s to 12.500 000 Gbit/s, 0.000 002 Gbit/s step 12.800 002 Gbit/s to 25.000 000 Gbit/s, 0.000 002 Gbit/s step 25.600 004 Gbit/s to 28.100 000 Gbit/s, 0.000 004 Gbit/s step 25.600 004 Gbit/s to 32.100 000 Gbit/s, 0.000 004 Gbit/s step (with Option-x01) Offset: -1000 ppm to +1000 ppm, 1 ppm step (Offset setting range is changed depends on Bit-rate. Offset range is -1000 ppm to 0 ppm with following Bit-rate range. Full Rate: 12.500 000 Gbit/s, 25.000 000 Gbit/s, Half Rate: 25.000 000 Gbit/s)</p>																																				
Bit-rate Setting Range (with external clock source)	<p>This item is specified when external clock source is used.</p> <p>When Full Rate Clock Output is selected:</p> <table border="1" data-bbox="448 1203 1268 1367"> <thead> <tr> <th>Operating Bit-rate Range</th> <th>Input Clock Frequency</th> <th>Bit-rate/Clock Divide Ratio</th> </tr> </thead> <tbody> <tr> <td>2.4 Gbit/s to 16.0 Gbit/s</td> <td>2.4 GHz to 16.0 GHz</td> <td>1/1 Clock</td> </tr> <tr> <td>16.0 Gbit/s to 20.4 Gbit/s</td> <td>8.0 GHz to 10.2 GHz</td> <td>1/2 Clock</td> </tr> <tr> <td>20.0 Gbit/s to 28.1 Gbit/s*1</td> <td>10.0 GHz to 14.05 GHz</td> <td>1/2 Clock</td> </tr> <tr> <td>20.0 Gbit/s to 32.1 Gbit/s*2</td> <td>10.0 GHz to 16.05 GHz</td> <td>1/2 Clock</td> </tr> <tr> <td>25.0 Gbit/s to 28.1 Gbit/s*1</td> <td>6.25 GHz to 7.025 GHz</td> <td>1/4 Clock</td> </tr> <tr> <td>25.0 Gbit/s to 32.1 Gbit/s*2</td> <td>6.25 GHz to 8.025 GHz</td> <td>1/4 Clock</td> </tr> </tbody> </table> <p>When Half Rate Clock Output is selected:</p> <table border="1" data-bbox="448 1402 1268 1520"> <thead> <tr> <th>Operating Bit-rate Range</th> <th>Input Clock Frequency</th> <th>Bit-rate/Clock Divide Ratio</th> </tr> </thead> <tbody> <tr> <td>2.4 Gbit/s to 28.1 Gbit/s*1</td> <td>1.2 GHz to 14.05 GHz</td> <td>1/2 Clock</td> </tr> <tr> <td>2.4 Gbit/s to 32.1 Gbit/s*2</td> <td>1.2 GHz to 16.05 GHz</td> <td>1/2 Clock</td> </tr> <tr> <td>25.0 Gbit/s to 28.1 Gbit/s*1</td> <td>6.25 GHz to 7.025 GHz</td> <td>1/4 Clock</td> </tr> <tr> <td>25.0 Gbit/s to 32.1 Gbit/s*2</td> <td>6.25 GHz to 8.025 GHz</td> <td>1/4 Clock</td> </tr> </tbody> </table> <p>*1: Up to 28.1 Gbit/s when Option-x01 is not installed. *2: Option-x01 must be installed.</p>	Operating Bit-rate Range	Input Clock Frequency	Bit-rate/Clock Divide Ratio	2.4 Gbit/s to 16.0 Gbit/s	2.4 GHz to 16.0 GHz	1/1 Clock	16.0 Gbit/s to 20.4 Gbit/s	8.0 GHz to 10.2 GHz	1/2 Clock	20.0 Gbit/s to 28.1 Gbit/s*1	10.0 GHz to 14.05 GHz	1/2 Clock	20.0 Gbit/s to 32.1 Gbit/s*2	10.0 GHz to 16.05 GHz	1/2 Clock	25.0 Gbit/s to 28.1 Gbit/s*1	6.25 GHz to 7.025 GHz	1/4 Clock	25.0 Gbit/s to 32.1 Gbit/s*2	6.25 GHz to 8.025 GHz	1/4 Clock	Operating Bit-rate Range	Input Clock Frequency	Bit-rate/Clock Divide Ratio	2.4 Gbit/s to 28.1 Gbit/s*1	1.2 GHz to 14.05 GHz	1/2 Clock	2.4 Gbit/s to 32.1 Gbit/s*2	1.2 GHz to 16.05 GHz	1/2 Clock	25.0 Gbit/s to 28.1 Gbit/s*1	6.25 GHz to 7.025 GHz	1/4 Clock	25.0 Gbit/s to 32.1 Gbit/s*2	6.25 GHz to 8.025 GHz	1/4 Clock
Operating Bit-rate Range	Input Clock Frequency	Bit-rate/Clock Divide Ratio																																			
2.4 Gbit/s to 16.0 Gbit/s	2.4 GHz to 16.0 GHz	1/1 Clock																																			
16.0 Gbit/s to 20.4 Gbit/s	8.0 GHz to 10.2 GHz	1/2 Clock																																			
20.0 Gbit/s to 28.1 Gbit/s*1	10.0 GHz to 14.05 GHz	1/2 Clock																																			
20.0 Gbit/s to 32.1 Gbit/s*2	10.0 GHz to 16.05 GHz	1/2 Clock																																			
25.0 Gbit/s to 28.1 Gbit/s*1	6.25 GHz to 7.025 GHz	1/4 Clock																																			
25.0 Gbit/s to 32.1 Gbit/s*2	6.25 GHz to 8.025 GHz	1/4 Clock																																			
Operating Bit-rate Range	Input Clock Frequency	Bit-rate/Clock Divide Ratio																																			
2.4 Gbit/s to 28.1 Gbit/s*1	1.2 GHz to 14.05 GHz	1/2 Clock																																			
2.4 Gbit/s to 32.1 Gbit/s*2	1.2 GHz to 16.05 GHz	1/2 Clock																																			
25.0 Gbit/s to 28.1 Gbit/s*1	6.25 GHz to 7.025 GHz	1/4 Clock																																			
25.0 Gbit/s to 32.1 Gbit/s*2	6.25 GHz to 8.025 GHz	1/4 Clock																																			
Bit-rate Setting Range (MU181500B synchronized operation with external clock source)	<p>This item is specified when MU181000B is installed into the same mainframe and external clock source is used.</p> <p>When Full Rate Clock Output is selected:</p> <table border="1" data-bbox="448 1623 1268 1766"> <thead> <tr> <th>Operating Bit-rate Range</th> <th>Input Clock Frequency</th> <th>Bit-rate/Clock Divide Ratio</th> </tr> </thead> <tbody> <tr> <td>2.4 Gbit/s to 15.0 Gbit/s</td> <td>2.4 GHz to 15.0 GHz</td> <td>1/1 Clock</td> </tr> <tr> <td>15.0 Gbit/s to 20.0 Gbit/s</td> <td>7.5 GHz to 10.0 GHz</td> <td>1/2 Clock</td> </tr> <tr> <td>20.0 Gbit/s to 28.1 Gbit/s*1</td> <td>10.0 GHz to 14.05 GHz</td> <td>1/2 Clock</td> </tr> <tr> <td>20.0 Gbit/s to 30.0 Gbit/s*2</td> <td>10.0 GHz to 16.05 GHz</td> <td>1/2 Clock</td> </tr> <tr> <td>30.0 Gbit/s to 32.1 Gbit/s*2</td> <td>7.5 GHz to 8.025 GHz</td> <td>1/4 Clock</td> </tr> </tbody> </table> <p>When Half Rate Clock Output is selected:</p> <table border="1" data-bbox="448 1801 1268 1898"> <thead> <tr> <th>Operating Bit-rate Range</th> <th>Input Clock Frequency</th> <th>Bit-rate/Clock Divide Ratio</th> </tr> </thead> <tbody> <tr> <td>2.4 Gbit/s to 28.1 Gbit/s*1</td> <td>1.2 GHz to 14.05 GHz</td> <td>1/2 Clock</td> </tr> <tr> <td>2.4 Gbit/s to 30.0 Gbit/s*2</td> <td>1.2 GHz to 15.0 GHz</td> <td>1/2 Clock</td> </tr> <tr> <td>30.0 Gbit/s to 32.1 Gbit/s*2</td> <td>7.5 GHz to 8.025 GHz</td> <td>1/4 Clock</td> </tr> </tbody> </table> <p>*1: Up to 28.1 Gbit/s when Option-x01 is not installed. *2: Option-x01 must be installed.</p>	Operating Bit-rate Range	Input Clock Frequency	Bit-rate/Clock Divide Ratio	2.4 Gbit/s to 15.0 Gbit/s	2.4 GHz to 15.0 GHz	1/1 Clock	15.0 Gbit/s to 20.0 Gbit/s	7.5 GHz to 10.0 GHz	1/2 Clock	20.0 Gbit/s to 28.1 Gbit/s*1	10.0 GHz to 14.05 GHz	1/2 Clock	20.0 Gbit/s to 30.0 Gbit/s*2	10.0 GHz to 16.05 GHz	1/2 Clock	30.0 Gbit/s to 32.1 Gbit/s*2	7.5 GHz to 8.025 GHz	1/4 Clock	Operating Bit-rate Range	Input Clock Frequency	Bit-rate/Clock Divide Ratio	2.4 Gbit/s to 28.1 Gbit/s*1	1.2 GHz to 14.05 GHz	1/2 Clock	2.4 Gbit/s to 30.0 Gbit/s*2	1.2 GHz to 15.0 GHz	1/2 Clock	30.0 Gbit/s to 32.1 Gbit/s*2	7.5 GHz to 8.025 GHz	1/4 Clock						
Operating Bit-rate Range	Input Clock Frequency	Bit-rate/Clock Divide Ratio																																			
2.4 Gbit/s to 15.0 Gbit/s	2.4 GHz to 15.0 GHz	1/1 Clock																																			
15.0 Gbit/s to 20.0 Gbit/s	7.5 GHz to 10.0 GHz	1/2 Clock																																			
20.0 Gbit/s to 28.1 Gbit/s*1	10.0 GHz to 14.05 GHz	1/2 Clock																																			
20.0 Gbit/s to 30.0 Gbit/s*2	10.0 GHz to 16.05 GHz	1/2 Clock																																			
30.0 Gbit/s to 32.1 Gbit/s*2	7.5 GHz to 8.025 GHz	1/4 Clock																																			
Operating Bit-rate Range	Input Clock Frequency	Bit-rate/Clock Divide Ratio																																			
2.4 Gbit/s to 28.1 Gbit/s*1	1.2 GHz to 14.05 GHz	1/2 Clock																																			
2.4 Gbit/s to 30.0 Gbit/s*2	1.2 GHz to 15.0 GHz	1/2 Clock																																			
30.0 Gbit/s to 32.1 Gbit/s*2	7.5 GHz to 8.025 GHz	1/4 Clock																																			

External Clock Input	<p>Number of Input: 1 (Single end) Frequency: 1.2 GHz to 16.05 GHz* Amplitude: 0.3 Vp-p to 1.0 Vp-p (-6.5 to +4.0 dBm) Termination: 50Ω/AC Coupling Connector: SMA (f.)</p>
Aux Input	<p>Number of Input: 1 (Single end) Signal Type: Error Injection, Burst Minimum Pulse Width: 1/128 Input level: 0/-1 V (H: -0.25 V to 0.05 V, L: -1.1 V to -0.8 V) Termination: 50Ω/GND Connector: SMA (f.)</p>
Aux Output	<p>Number of Output: 2 (Differential) Signal Type: 1/n Clock (n = 4, 6, 8, 10 · · · 510, 512), Pattern Sync, Burst Out2 Output level: 0/-0.6 V (H: -0.25 V to 0.05 V, L: -0.80 V to -0.45 V) Termination: 50Ω/GND Connector: SMA (f.)</p>
Gating Output	<p>Burst, Repeat Timing Signal Output level: 0/-1 V (H: -0.25 V to 0.05 V, L: -1.25 V to -0.8 V) Termination: 50Ω/GND Connector: SMA (f.)</p>
Pattern Generation	<p>PRBS Pattern length: $2^n - 1$ (n = 7, 9, 10, 11, 15, 20, 23, 31) Mark ratio: 1/2 (1/2INV is supported by a logic inversion) Zero-Substitution: Pattern with continuous 0 s appended to M-sequence signal + 1 bit Pattern: 2^n or $2^n - 1$ (n = 7, 9, 10, 11, 15, 20, 23) 0 continuous substitution count: 1 to (pattern length - 1) bits 0 at next bit after 0 substitution changed to 1 Data Data length: 2 bits to 268 435 456 bits, 1 bit step Mixed Pattern Pattern: PRBS, Data - 1 to Data - 511 Mixed Row Length (Data + PRBS Length): 1 536 to 2 415 919 104, 256 bits step Data length: 1 024 bits to 268 435 456 bits, 1 bit step PRBS length/Mark Ratio: Same as PRBS PRBS Sequence: Restart, Consecutive</p>
Pattern Sequence	<p>Repeat: Continuous Pattern Burst Burst Cycle: 25 600 bits to 2 147 483 648 bits, 256 bits step Enable period Internal: 12 800 bits to 2 147 483 392 bits, 256 bits step Ext Trigger, Enable: 12 800 bits to 2 147 483 648 bits, 256 bits step</p>
Pre-code	<p>Pre-code function: ON and OFF Type: DQPSK (MU183020A, MU183021A) DP-QPSK (MU183021A) Initial Data: 0 or 1 selectable</p>
Error addition	<p>Timing: Internal, external trigger Error event: Repeat, Single Error rate: $a \times 10^{-b}$ (a = 1 to 9, b = 3 to 12), Upper limit: 5E-3</p>

*: The clock frequency from external clock source shall be changed depends on the Bit-rate setting. Please see Bit-rate setting range.

	MU183020A-x12	MU183020A-x13	MU183021A-x22	MU183021A-x23
	Number of Outputs: 2: Data, XData (Independent)		4: Data1, XData1, Data2, XData2 (Independent)	
	Output Amplitude: 0.5 Vp-p to 2.0 Vp-p 2 mV step	0.5 Vp-p to 3.5 Vp-p 2 mV step	0.5 Vp-p to 2.0 Vp-p 2 mV step	0.5 Vp-p to 3.5 Vp-p 2 mV step
	MU183021A-x12	MU183021A-x13		
	Number of Outputs: 8: Data, XData (Independent)			
	Output Amplitude: 0.5 Vp-p to 2.0 Vp-p 2 mV step	0.5 Vp-p to 3.5 Vp-p 2 mV step		
Data Output*1	<p>Output amplitude setting error: ± 50 mV $\pm 17\%$ of setting amplitude*2 Offset: -2.0 Voh to $+3.3$ Voh, 1 mV step Current limitation: Sourcing 50 mA, Sinking 80 mA Cross point setting range: 20 to 80%/0.1% step: at 1.0 Vp-p to upper limit of output amplitude setting 30 to 70%/0.1% step: at 0.5 Vp-p to 0.998 Vp-p Tr/Tf 12 ps (20 to 80%)*3, *4, *5 Jitter (p-p): 8 ps p-p*3, *4, *5, *6, *10 Jitter (RMS): 700 fs*3, *4, *5, *6 RJ (RMS): 300 fs*3, *4, *5, *6, *11 Waveform Distortion (0-peak): ± 25 mV $\pm 15\%$*3, *4, *5, *12 Output: On/Off selectable Inter channel skew: ± 0.25 UI*6, *7, *8 Termination: AC/DC 50Ω Connector: K (f.)</p>			
Clock Output*9	<p>Number of output: 1 Full Rate : Clock frequency is same as bit-rate when Full Rate Clock Output is selected. 2.4 GHz to 28.1 GHz 2.4 GHz to 32.1 GHz (Option-x01) Half Rate: Clock frequency is half of bit-rate when Half Rate Clock Output is selected. 1.2 GHz to 14.05 GHz 1.2 GHz to 16.05 GHz (Option-x01) Amplitude: 0.3 Vp-p to 1.0 Vp-p Output: On/Off selectable Termination: 50Ω/AC Coupling Connector: K (f.)</p>			
Delay (MU183020A-x30, x31 MU183021A-x30)	<p>Phase variable range: $-1\ 000$ mUI to $+1\ 000$ mUI, 2 mUI step Phase setting error: ± 50 mUIp-p*5, *6 (Bit rate ≤ 28.1 Gbit/s), ± 75 mUIp-p*5, *6 (Bit rate > 28.1 Gbit/s)</p>			

- *1: Unless otherwise specified, these are defined with PRBS $2^{31} - 1$, Mark Ratio 1/2, Cross-point 50%, using an optional accessories (J1439A coaxial cable, 0.8 m, K connector) and a sampling oscilloscope which has 70 GHz bandwidth.
- *2: This value is assured when Cross point is set to 50% or within the range of 30 to 80% and Bit rate is set to 25 or 28.1 Gbit/s.
- *3: Without Option-x01: at 28.1 Gbit/s
With Option-x01: at 32.1 Gbit/s
- *4: With Option-x12 or x22: at amplitude 2.0 Vp-p,
With Option-x13 or x23: at amplitude 3.5 Vp-p
- *5: Typical value
- *6: Using oscilloscope with intrinsic jitter of less than 200 fs (RMS).
- *7: With MU183020A-x22 or MU183020A-x23. Or, when MU183021A is used.
- *8: With Option-x30 or x31.
- *9: These values are monitored using an applicable part (J1439A coaxial cable, 0.8 m, K connector) at a sampling oscilloscope bandwidth of 70 GHz.
- *10: This value is the peak-to-peak jitter of the crossing point on Eye pattern measured at 1k Jitter total samples and 30 counts, and is not the estimated TJ at BER $1E-12$ using DR/RJ decomposition.
- *11: Calculated by following formula with using 1010 repetition signal

$$RJ (rms) = \sqrt{RJ_{meas}^2 - RJ_{scope}^2}$$
where RJ_{meas} is measured RJ and RJ_{scope} is intrinsic RJ of Sampling Scope
- *12: Sometimes, performance may exceed the standards for undescribed settings, such as burst lengths of >1 μ s (reference value), and contiguous patterns of 0 s (or 1 s).

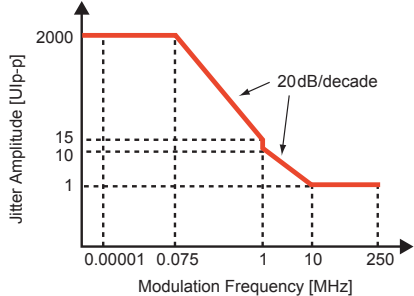
<p>Jitter Tolerance*7</p>	<p>Bit-rate: 16 Gbit/s, 28.1 Gbit/s*1 16 Gbit/s, 28.1 Gbit/s, 32.1 Gbit/s*2 Test Pattern: PRBS $2^{31} - 1$</p> 
<p>Multi-Channel Operation</p>	<p>MU183020A Combination*1, *2: 2ch (Bit shifted test pattern as 56 Gbit/s, 64 Gbit/s band signal source) CH Sync.: 2 to 4ch*3, *6 Phase variable range*5: -64 000 mUI to +64 000 mUI, Steps: 2 mUI</p> <p>MU183021A Combination*2: 2ch (Bit shifted test pattern as 56G/64 Gbit/s band signal source) 4ch (Bit shifted test pattern as 112G/128 Gbit/s band signal source) CH Sync.: 2 to 8ch*3, *4 Phase variable range*5: -64 000 mUI to +64 000 mUI, Steps: 2 mUI</p>
<p>Operating Temperature</p>	<p>15° to 35°C</p>

- *1: Option-x31 is required for target channels.
- *2: Combination extending over multiple slots cannot be set.
- *3: When target channels are installed successively from Slot 1.
- *4: Option-x30 is required for target channels.
- *5: A separate value can be set for each channel. This value is common to both Channel Combination and Channel Synchronization.
- *6: Option-x30 or x31 is required for target channels.
- *7: Combined operation with MU181500B and MU181000B. SJ applied. Looped back with MU183040B.

• MU183040B 28G/32G bit/s High Sensitivity ED, MU183041B 28G/32G bit/s 4ch High Sensitivity ED

Bit-rate	Operational Bit-rate Range: 2.4 Gbit/s to 28.1 Gbit/s 2.4 Gbit/s to 32.1 Gbit/s (with Option-x01)																																
Data Input	<p>Number of Input MU183040B-010 . . . 2 (Data , XData) MU183040B-020 . . . 4 (Data1 to Data2, XData1 to XData2) MU183041B . . . 8 (Data1 to Data4, XData1 to XData4)</p> <p>Amplifier: Single-ended 50Ω, Differential 50Ω, Differential 100Ω can be set. Data, XData can be set. Tracking, Independent, Alternate can be set. (Data-XData or XData-Data can be set when Alternate is selected. *1)</p> <p>Format: NRZ</p> <table border="1"> <thead> <tr> <th colspan="2"></th> <th>MU183040B/MU183041B</th> </tr> </thead> <tbody> <tr> <td colspan="2">Input Amplitude*8</td> <td>0.05 Vp-p to 1.0 Vp-p</td> </tr> <tr> <td rowspan="2">Sensitivity*8</td> <td>Eye Amplitude</td> <td>15 mVp-p*2, *3, *4</td> </tr> <tr> <td>Eye Height</td> <td>≤25 mVp-p*4</td> </tr> <tr> <td></td> <td></td> <td>10 mVp-p*2, *3, *4, *9</td> </tr> </tbody> </table> <p>Note: Be careful about the maximum input amplitude. 2 Vp-p Max. for A-type, and 1 Vp-p Max. for B-type.</p> <p>Threshold voltage: -3.5 V to +3.3 V, 1 mV step (Can be set individually for Data and XData.) Absolute value of difference between Data and XData Threshold values shall be 3 V or less.</p> <p>Phase Margin: 20 ps*2, *4, *5, *7 28 ps*4, *5, *6, *7</p> <p>Termination: GND/50Ω, Variable/50Ω Termination voltage: -2.5 V to +3.5 V, 10 mV step (When termination variable is selected) Connector: K (f.)</p>			MU183040B/MU183041B	Input Amplitude*8		0.05 Vp-p to 1.0 Vp-p	Sensitivity*8	Eye Amplitude	15 mVp-p*2, *3, *4	Eye Height	≤25 mVp-p*4			10 mVp-p*2, *3, *4, *9																		
		MU183040B/MU183041B																															
Input Amplitude*8		0.05 Vp-p to 1.0 Vp-p																															
Sensitivity*8	Eye Amplitude	15 mVp-p*2, *3, *4																															
	Eye Height	≤25 mVp-p*4																															
		10 mVp-p*2, *3, *4, *9																															
Clock Input	<p>Number of Input: 1 (Single-end) Frequency: 1.2 GHz to 16.05 GHz Amplitude: 0.3 Vp-p to 1.0 Vp-p (-6.5 to +4.0 dBm) Termination: 50Ω/AC Coupling Connector: SMA (f.)</p>																																
Clock Recovery	Clock Recovery from 1ch Data input, internal distribution to each channel*10																																
Operating Bit-rate	2.4 Gbit/s to 28.1 Gbit/s, 1 kbit/s step (Option-x22) 25.5 Gbit/s to 32.1 Gbit/s*11, 1 kbit/s step (Option-x23)																																
Maximum Number of Consecutive Zeros*12	72 bit (Zero Substitution 2 ¹⁵)																																
Lock Range for Clock Data Recovery*12	±200 ppm (Option-x22) ±100 ppm (Option-x23)																																
Target Loop Band	<p>Available options are Bit rate/1667, Bit rate/2578, Jitter Tolerance*13 and Variable (Option-x22) If the Variable option is selected, the following settings are available:</p> <table border="1"> <thead> <tr> <th>Bit rate [Gbit/s]</th> <th>Setting Range [MHz]/Step [MHz]</th> </tr> </thead> <tbody> <tr><td>2.400 000 to 5.500 000</td><td>3/-</td></tr> <tr><td>5.500 001 to 7.500 000</td><td>3 to 4/1</td></tr> <tr><td>7.500 001 to 9.500 000</td><td>3 to 5/1</td></tr> <tr><td>9.500 001 to 10.500 000</td><td>3 to 6/1</td></tr> <tr><td>10.500 001 to 12.500 000</td><td>3 to 7/1</td></tr> <tr><td>12.500 001 to 14.500 000</td><td>3 to 8/1</td></tr> <tr><td>14.500 001 to 15.500 000</td><td>3 to 9/1</td></tr> <tr><td>15.500 001 to 17.500 000</td><td>3 to 10/1</td></tr> <tr><td>17.500 001 to 19.500 000</td><td>3 to 11/1</td></tr> <tr><td>19.500 001 to 20.500 000</td><td>3 to 12/1</td></tr> <tr><td>20.500 001 to 22.500 000</td><td>3 to 13/1</td></tr> <tr><td>22.500 001 to 24.500 000</td><td>3 to 14/1</td></tr> <tr><td>24.500 001 to 25.500 000</td><td>3 to 15/1</td></tr> <tr><td>25.500 001 to 27.500 000</td><td>3 to 16/1</td></tr> <tr><td>27.500 001 to 28.100 000</td><td>3 to 17/1</td></tr> </tbody> </table> <p>Available options are Bit rate/1667, Bit rate/2578 and Jitter Tolerance*13 (Option-x23)</p>	Bit rate [Gbit/s]	Setting Range [MHz]/Step [MHz]	2.400 000 to 5.500 000	3/-	5.500 001 to 7.500 000	3 to 4/1	7.500 001 to 9.500 000	3 to 5/1	9.500 001 to 10.500 000	3 to 6/1	10.500 001 to 12.500 000	3 to 7/1	12.500 001 to 14.500 000	3 to 8/1	14.500 001 to 15.500 000	3 to 9/1	15.500 001 to 17.500 000	3 to 10/1	17.500 001 to 19.500 000	3 to 11/1	19.500 001 to 20.500 000	3 to 12/1	20.500 001 to 22.500 000	3 to 13/1	22.500 001 to 24.500 000	3 to 14/1	24.500 001 to 25.500 000	3 to 15/1	25.500 001 to 27.500 000	3 to 16/1	27.500 001 to 28.100 000	3 to 17/1
Bit rate [Gbit/s]	Setting Range [MHz]/Step [MHz]																																
2.400 000 to 5.500 000	3/-																																
5.500 001 to 7.500 000	3 to 4/1																																
7.500 001 to 9.500 000	3 to 5/1																																
9.500 001 to 10.500 000	3 to 6/1																																
10.500 001 to 12.500 000	3 to 7/1																																
12.500 001 to 14.500 000	3 to 8/1																																
14.500 001 to 15.500 000	3 to 9/1																																
15.500 001 to 17.500 000	3 to 10/1																																
17.500 001 to 19.500 000	3 to 11/1																																
19.500 001 to 20.500 000	3 to 12/1																																
20.500 001 to 22.500 000	3 to 13/1																																
22.500 001 to 24.500 000	3 to 14/1																																
24.500 001 to 25.500 000	3 to 15/1																																
25.500 001 to 27.500 000	3 to 16/1																																
27.500 001 to 28.100 000	3 to 17/1																																
Jitter Tolerance	Comply 16G FC, 32G FC, 100 GbE (25.78x4), InfiniBand FDR, Jitter Tolerance Mask (Option-x22) Comply 32G FC, 100 GbE (25.78x4), Jitter Tolerance Mask (Option-x23)																																
Aux Input	<p>Number of Input: 1 (Single-end) Input Signal: External Mask, Burst Minimum Pulse Width: 1/128 of Bit-rate Input Level: 0/-1 V (H: -0.25 V to 0.05 V, L: -1.1 V to -0.8 V) Termination: GND/50Ω Connector: SMA (f.)</p>																																

Aux Output	Number of Output: 2 (Differential) Input Signal: 1/n Clock (n = 4, 6, 8, 10 ··· 510, 512), Pattern Sync, Error, Sync. gain Pattern Sync. PRBS, PRGM: Position: (Least common multiple of 1 to Pattern Length and 128) – 135, 8 step Mixed Data: Block No. setting: 1 to the Block No. specified for Mixed Data, in single steps Row No. setting: 1 to the Row No. specified for Mixed Data, in single steps Output Level: 0/–0.6 V (H: –0.25 V to 0.05 V, L: –0.80 V to –0.45 V) Termination: GND/50Ω Connector: SMA (f.)
Pattern Detection	PRBS Pattern length: $2^n - 1$ (n = 7, 9, 10, 11, 15, 20, 23, 31) Mark ratio: 1/2 (1/2INV is supported by a logic inversion) Zero-Substitution: Pattern with continuous 0 s appended to M-sequence signal + 1 bit Pattern: 2^n or $2^n - 1$ (n = 7, 9, 10, 11, 15, 20, 23) 0 continuous substitution count: 1 to (pattern length – 1) bits 0 at next bit after 0 substitution changed to 1 Data Data length: 2 bits to 268 435 456 bits, 1 bit step Mixed Pattern Pattern: PRBS, Data – 1 to Data – 511 Mixed Row Length (Data + PRBS Length): 1 536 to 2 415 919 104, 256 bits step Data length: 1 024 bits to 268 435 456 bits, 1 bit step PRBS length/Mark Ratio: Same as PRBS PRBS Sequence: Restart, Consecutive
Pattern Sequence	Repeat: Continuous Pattern Burst Burst Cycle: 25 600 bits to 2 147 483 648 bits, 256 bits step Enable period Internal: 12 800 bits to 2 147 483 392 bits, 256 bits step Ext Trigger, Enable: 12 800 bits to 2 147 483 648 bits, 256 bits step
Measurement Type	Error Rate, Error Count, Error Interval, Error Free Interval (%), Frequency Clock Count, Sync Loss Interval, Clock Loss Interval
Error Detection Mode	Total error, Insertion Error, Omission Error, Transition Error, Non Transition Error
Error Analysis	Eye Margin, Eye Diagram, Bathtub Jitter, Auto Adjust, Auto Search, Capture, Eye Contour, PAM BER Measurement
Burst Measurement Signal	Burst Trigger: Internal, External
Variable Clock Delay	Phase variable range: –1 000 mUI to +1 000 mUI, 2 mUI step Phase setting error: ± 50 mUIp-p*1, *4 mUI - ps selectable
Multi-channel Operation	MU183040B (with Option-x20): 2ch combination (Combination extending over multiple slots cannot be set) MU183041B (4ch): 2ch or 4ch combination (Combination extending over multiple slots cannot be set)
Operating Temperature	15° to 35°C

- *1: Absolute value of difference between Data and XData Threshold values shall be 1.5 V or less.
- *2: 28.1 Gbit/s
- *3: PRBS 31, Single-ended, Mark Ratio 1/2, 20° to 30°C
- *4: Typical value
- *5: 0.5 Vp-p Input
- *6: 25 Gbit/s
- *7: PRBS31, Single-ended, Mark ratio 1/2
- *8: Input amplitude is a range where Auto Adjust function operates. Input sensitivity is the minimum input amplitude which becomes error-free.
- *9: Sensitivity of eye height. Eye Height is the internal amplitude of Eye when the output amplitude of the MU183020A/21A + ATT is set to 15 mV with the measurement system as the figure below (A sampling oscilloscope with the bandwidth of 70 GHz or more is used.).
The number of samples with Sampling Oscilloscope is equivalent to BER 1E–9 or less at this internal amplitude.

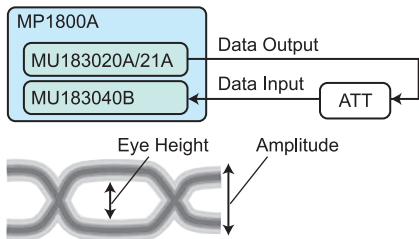

- *10: MU183041B-023 recovers Clock from 1ch Data input and distributes to 1ch and 2ch. Also recovers Clock from 3ch Data input and distributes to 3ch and 4ch.
- *11: MU183040B/41B-001 must be installed.
- *12: When the MU183040B/MU183041B-x22 option is installed: The target loop band is specified by the maximum setting value of each bit rate.
When the MU183040B/MU183041B-x23 option is installed: The target loop band is specified by (Bit rate/1667) and (Bit rate/2578).
- *13: The Jitter Tolerance option makes the loop band wider than the other options and enables the Jitter Tolerance measurement.

• **MU181000B 12.5 GHz 4port Synthesizer**

Clock Output	Number of Output: 4 Frequency Range: 0.1 GHz to 12.5 GHz, Steps: 1 kHz/1 MHz Offset from Set Frequency: -1000 ppm to +1000 ppm, Steps: 1 ppm, 1 Hz (Min) Level: 0.4 Vp-p to 1 Vp-p (AC) SSB Phase Noise: ≤ -80 dBc/Hz (10 kHz offset) Intrinsic Jitter: ≤ 20 ps p-p ≤ 20 ps p-p ($f_c > 400$ MHz) Waveform: Square wave (<1 GHz), Square wave or Sine wave (≥ 1 GHz) Duty: $50 \pm 10\%$ Inter-channel Skew: ≤ 10 ps (12.5 GHz) Connector: SMA(f.), Termination: 50Ω/GND
10 MHz Input	Frequency: 10 MHz ± 10 ppm Level: 0.5 Vp-p to 2.0 Vp-p Waveform: Square wave or Sine wave Duty: $50 \pm 10\%$ Connector: BNC, Termination: 50Ω/GND
10 MHz Output	Level: 1.0 Vp-p $\pm 30\%$ (AC) Waveform: Square wave Duty: $50 \pm 10\%$ Connector: BNC, Termination: 50Ω/GND

• **MU181000B-001 Jitter Modulation**

External Modulation Input	Frequency Range: 9 Hz to 1 GHz Level Range: 3 Vp-p, 0 V(dc) (Max.) Waveform: Sine wave Connector: SMA(f.), Termination: 50Ω/GND																																
External I, Q Input	Frequency Range: DC to 320 MHz (-3 dB) Bandwidth Limit: 5 MHz ($0.1 \text{ GHz} \leq f_c \leq 0.4 \text{ GHz}$), 10 MHz ($0.4 \text{ GHz} < f_c \leq 0.65 \text{ GHz}$), 20 MHz ($0.65 \text{ GHz} < f_c \leq 1.4 \text{ GHz}$), 100 MHz ($1.4 \text{ GHz} < f_c \leq 2.4 \text{ GHz}$), 320 MHz ($2.4 \text{ GHz} < f_c \leq 4.0 \text{ GHz}$) Level Range: ± 0.5 V Connector: BNC, Termination: 50Ω/GND																																
100 MHz Reference Signal Input (SSC)	Output Center Frequency is $\times 25$ or $\times 50$ of Reference Input Frequency Modulation Frequency: 30 kHz to 33 kHz Frequency Deviation: 50 kHz Level: 1.0 Vp-p $\pm 30\%$ (AC) Waveform: Square wave or Sine wave Duty: $50 \pm 10\%$ Connector: BNC, Termination: 50Ω/GND																																
Trigger Output	Available from 800 MHz to 12.5 GHz of center frequency (f_c) Frequency: 1/64 ($800 \text{ MHz} < f_c \leq 6.4 \text{ GHz}$), 1/1 or 1/64 selectable ($6.4 \text{ GHz} < f_c \leq 12.5 \text{ GHz}$) Level: 0.4 Vp-p to 1.1 Vp-p (AC) Connector: SMA(f.), Termination: 50Ω/GND																																
Internal Jitter Function	Modulation Frequency Range <table border="1" style="margin-left: 20px;"> <thead> <tr> <th>Center Frequency (fc)</th> <th>fm1</th> <th>fm2</th> <th>fm3</th> </tr> </thead> <tbody> <tr> <td>0.1 GHz to 0.8 GHz</td> <td>13.75 Hz</td> <td>250 kHz</td> <td>5 MHz</td> </tr> <tr> <td>0.8 GHz to 1.6 GHz</td> <td>27.5 Hz</td> <td>500 kHz</td> <td>10 MHz</td> </tr> <tr> <td>1.6 GHz to 3.2 GHz</td> <td>55 Hz</td> <td>1 MHz</td> <td>20 MHz</td> </tr> <tr> <td>3.2 GHz to 6.4 GHz</td> <td>110 Hz</td> <td>2 MHz</td> <td>40 MHz</td> </tr> <tr> <td>6.4 GHz to 12.5 GHz</td> <td>220 Hz</td> <td>4 MHz</td> <td>80 MHz</td> </tr> </tbody> </table> <p>Modulation Frequency Accuracy: ± 100 ppm Jitter Amplitude Accuracy*1: ± 0.01 UI $\pm Q\%$ (0.001 UIp-p to 2.19 UIp-p, $f_c < 1$ GHz) ± 0.02 UI $\pm Q\%$ (0.001 UIp-p to 2.19 UIp-p, $f_c \geq 1$ GHz) ± 0.2 UI $\pm Q\%$ (2.2 UIp-p to 21.99 UIp-p) ± 2 UI $\pm Q\%$ (22 UIp-p to 4000 UIp-p)</p> <table border="1" style="margin-left: 20px;"> <thead> <tr> <th>FM</th> <th>Q</th> </tr> </thead> <tbody> <tr> <td>9 Hz $\leq f_m \leq 500$ kHz</td> <td>7</td> </tr> <tr> <td>500 kHz $< f_m \leq 2$ MHz</td> <td>12</td> </tr> <tr> <td>2 MHz $< f_m \leq 80$ MHz</td> <td>15</td> </tr> </tbody> </table>	Center Frequency (fc)	fm1	fm2	fm3	0.1 GHz to 0.8 GHz	13.75 Hz	250 kHz	5 MHz	0.8 GHz to 1.6 GHz	27.5 Hz	500 kHz	10 MHz	1.6 GHz to 3.2 GHz	55 Hz	1 MHz	20 MHz	3.2 GHz to 6.4 GHz	110 Hz	2 MHz	40 MHz	6.4 GHz to 12.5 GHz	220 Hz	4 MHz	80 MHz	FM	Q	9 Hz $\leq f_m \leq 500$ kHz	7	500 kHz $< f_m \leq 2$ MHz	12	2 MHz $< f_m \leq 80$ MHz	15
Center Frequency (fc)	fm1	fm2	fm3																														
0.1 GHz to 0.8 GHz	13.75 Hz	250 kHz	5 MHz																														
0.8 GHz to 1.6 GHz	27.5 Hz	500 kHz	10 MHz																														
1.6 GHz to 3.2 GHz	55 Hz	1 MHz	20 MHz																														
3.2 GHz to 6.4 GHz	110 Hz	2 MHz	40 MHz																														
6.4 GHz to 12.5 GHz	220 Hz	4 MHz	80 MHz																														
FM	Q																																
9 Hz $\leq f_m \leq 500$ kHz	7																																
500 kHz $< f_m \leq 2$ MHz	12																																
2 MHz $< f_m \leq 80$ MHz	15																																

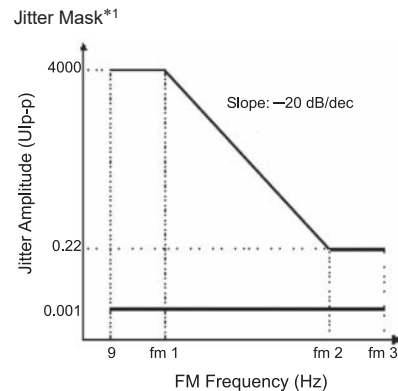

External Jitter Function

Modulation Frequency Range:
 9 Hz to 5 MHz (0.1 GHz \leq fc \leq 0.4 GHz)
 9 Hz to 10 MHz (0.4 GHz $<$ fc \leq 0.65 GHz)
 9 Hz to 20 MHz (0.65 GHz $<$ fc \leq 1.4 GHz)
 9 Hz to 100 MHz (1.4 GHz $<$ fc \leq 2.4 GHz)
 9 Hz to 500 MHz (2.4 GHz $<$ fc \leq 4.0 GHz)
 9 Hz to 1 GHz (4.0 GHz $<$ fc \leq 12.5 GHz)
 UI Range: 0.22, 2.0, 20, 200, 4000 UI

Modulation Frequency Range*1

Center Frequency	Input Frequency	Jitter Amplitude
1.4 GHz to 2.4 GHz	80 MHz to 100 MHz	Max. 0.22 UI
2.4 GHz to 4.0 GHz	80 MHz to 500 MHz	
4.0 GHz to 8.0 GHz	80 MHz to 1 GHz	
8.0 GHz to 8.5 GHz	80 MHz to 500 MHz	Max. 0.10 UI
	500 MHz to 1 GHz	
8.5 GHz to 11.3 GHz	80 MHz to 1 GHz	Max. 0.22 UI
11.3 GHz to 12.5 GHz	80 MHz to 250 MHz	Max. 0.22 UI
	250 MHz to 1 GHz	Max. 0.10 UI

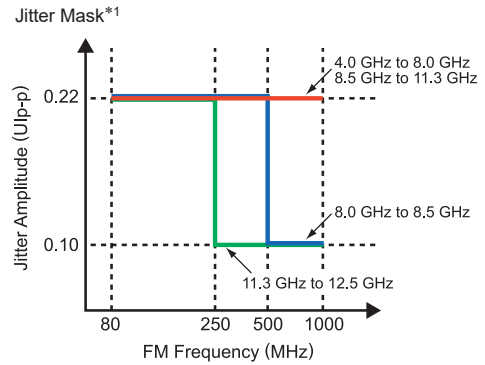

Modulation Sensitivity: 0.22 UI Range, Input level: 0.5 Vp-p

Output Clock Frequency	FM Frequency	Input Frequency	Jitter Amplitude
0.1 GHz \leq fc \leq 12.5 GHz	4 MHz	9 Hz to 4 MHz	0.1 UIp-p \pm 0.03 UI
	80 MHz	4 MHz to 80 MHz	
	500 MHz	80 MHz to 500 MHz	
2.4 GHz $<$ fc \leq 12.5 GHz	1 GHz	500 MHz to 1 GHz	

External Jitter Function

Modulation Sensitivity: 2, 20, 200, 4000 UI Range, Input level: 0.5 Vp-p

Clock Frequency: 0.1 GHz \leq fc \leq 0.8 GHz

Jitter Amplitude	FM Frequency	Input Frequency	Jitter Amplitude
2 UI	250 kHz	27.5 kHz	1 UIp-p \pm 0.3 UI
20 UI	27.5 kHz	2.75 kHz	10 UIp-p \pm 3 UI
200 UI	2.75 kHz	275 Hz	100 UIp-p \pm 30 UI
4000 UI	275 Hz	13.75 Hz	1000 UIp-p \pm 300 UI

Clock Frequency: 0.8 GHz $<$ fc \leq 1.6 GHz

Jitter Amplitude	FM Frequency	Input Frequency	Jitter Amplitude
2 UI	500 kHz	55 kHz	1 UIp-p \pm 0.3 UI
20 UI	55 kHz	5.5 kHz	10 UIp-p \pm 3 UI
200 UI	5.5 kHz	550 Hz	100 UIp-p \pm 30 UI
4000 UI	550 Hz	27.5 Hz	1000 UIp-p \pm 300 UI

Clock Frequency: 1.6 GHz $<$ fc \leq 3.2 GHz

Jitter Amplitude	FM Frequency	Input Frequency	Jitter Amplitude
2 UI	1 MHz	110 kHz	1 UIp-p \pm 0.3 UI
20 UI	110 kHz	11 kHz	10 UIp-p \pm 3 UI
200 UI	11 kHz	1.1 kHz	100 UIp-p \pm 30 UI
4000 UI	1.1 kHz	55 Hz	1000 UIp-p \pm 300 UI

Clock Frequency: 3.2 GHz $<$ fc \leq 6.4 GHz

Jitter Amplitude	FM Frequency	Input Frequency	Jitter Amplitude
2 UI	2 MHz	220 kHz	1 UIp-p \pm 0.3 UI
20 UI	220 kHz	22 kHz	10 UIp-p \pm 3 UI
200 UI	22 kHz	2.2 kHz	100 UIp-p \pm 30 UI
4000 UI	2.2 kHz	110 Hz	1000 UIp-p \pm 300 UI

Clock Frequency: 6.4 GHz $<$ fc \leq 12.5 GHz

Jitter Amplitude	FM Frequency	Input Frequency	Jitter Amplitude
2 UI	4 MHz	440 kHz	1 UIp-p \pm 0.3 UI
20 UI	440 kHz	44 kHz	10 UIp-p \pm 3 UI
200 UI	44 kHz	4.4 kHz	100 UIp-p \pm 30 UI
4000 UI	4.4 kHz	220 Hz	1000 UIp-p \pm 300 UI

Triangle Wave Modulation

PCIe-Gen I (2.5 GHz) or PCIe-Gen II (5 GHz)
 Clock Output Frequency Setting: Spread Method Center/Spread Method Down selectable
 Frequency Offset: -1000 ppm to +1000 ppm, Steps: 1 ppm
 Modulation Frequency Accuracy: 31.25 kHz \pm 1000 ppm
 Frequency Deviation: \pm 6.25 MHz (PCIe-Gen I, 2.5 GHz), \pm 12.5 MHz (PCIe-Gen II, 5 GHz)
 Deviation Accuracy: \pm 10%

*1: The maximum jitter amplitude is limited according to the jitter tolerance of PPG or ED modules. Refer to the jitter tolerance specification of PPG/ED modules.

• **MU181500B Jitter Modulation Source**

External Clock Input	<p>Number of Input: 1 Frequency Range: 6.400 001 GHz to 12.500 000 GHz (MU181000B, Combination: On) 0.800 000 GHz to 15.000 000 GHz (MU181000B, Combination: Off, or External synthesizer) Amplitude: 0.4 Vp-p to 1.0 Vp-p Connector: SMA(f.), Termination: 50Ω/AC Coupling</p>
External Jitter Input	<p>Number of Input: 1 Frequency Range: 10 kHz to 1 GHz Amplitude: 0 to 2.0 Vp-p Connector: SMA(f.), Termination: 50Ω/GND</p>
Jittered Clock Output	<p>Number of Output: 2 Frequency Range: 0.800 001 GHz to 1.562 500 GHz (MU181000B, Combination: On), Steps: 0.000 001 GHz 1.600 001 GHz to 3.125 000 GHz (MU181000B, Combination: On), Steps: 0.000 001 GHz 3.200 001 GHz to 6.250 000 GHz (MU181000B, Combination: On), Steps: 0.000 001 GHz 6.400 001 GHz to 12.500 000 GHz (MU181000B, Combination: On), Steps: 0.000 001 GHz 12.800 002 GHz to 15.000 000 GHz (MU181000B, Combination: On), Steps: 0.000 002 GHz 0.8 GHz to 15 GHz (MU181000B, Combination: Off, or External synthesizer) Frequency Offset: -1000 ppm to +1000 ppm (MU181000B, Combination: On), Steps: 1 ppm None (MU181000B, Combination: Off, or External synthesizer) Amplitude: 0.4 Vp-p (Min.), 1.0 Vp-p (Max.) Intrinsic Jitter: ≤350 fs (4.25, 7.0125, 10, 12.5, 14, 15 GHz) Connector: SMA(f.), Termination: 50Ω/AC Coupling</p>
IQ Output	<p>Number of Output: 2 (I, Q) Amplitude: 1 Vp-p (Max.) Connector: SMA(f.), Termination: 50Ω/GND</p>
AUX Input	<p>Number of Input: 1 Frequency Range: Same frequency with External Clock Input Amplitude: 0.4 Vp-p (Min.), 1.1 Vp-p (Max.) Connector: SMA(f.), Termination: 50Ω/AC Coupling</p>
Reference Clock Output	<p>Number of Output: 2 Reference Clock: External Clock Input or AUX Input (MU181000B, Combination: On) External Clock Input (MU181000B, Combination: Off, or External synthesizer) Frequency Range: 1/N of Jittered Clock Output Frequency (N: 1, 2, or 4) Amplitude: 0.4 Vp-p (Min.), 1.0 Vp-p (Max.) (Jittered Clock Output Frequency: ≥4 GHz) 0.4 Vp-p (Min.), 1.2 Vp-p (Max.) (Jittered Clock Output Frequency: <4 GHz) Connector: SMA(f.), Termination: 50Ω/AC Coupling</p>
Sub-rate Clock Output	<p>Number of Output: 2 (Differential) Frequency Range: 1/N of Jittered Clock Output Frequency (N: 8 to 256, Steps: 1) Amplitude: 0.1 Vp-p to 0.7 Vp-p, Steps: 10 mV Accuracy: ±70 mV ±20% of Amplitude (N: 8) Connector: SMA(f.), Termination: 50Ω/AC Coupling</p>

Internal Sinusoidal Jitter (SJ1)

Jitter Setting Mask*1

Jittered Clock Output Frequency: 8.500 001 GHz to 15 GHz

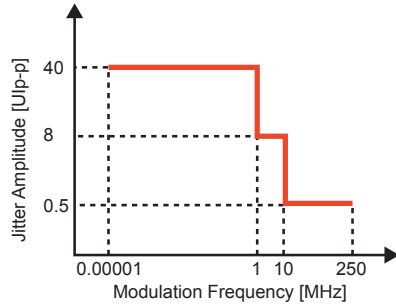

Jittered Clock Output Frequency: 4.000 001 GHz to 8.5 GHz

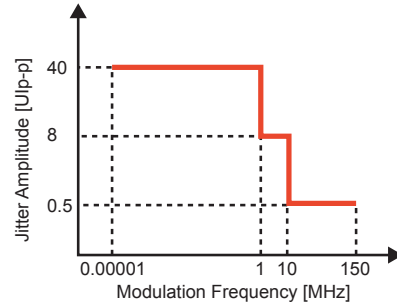

Jittered Clock Output Frequency: 1.200 001 GHz to 4 GHz

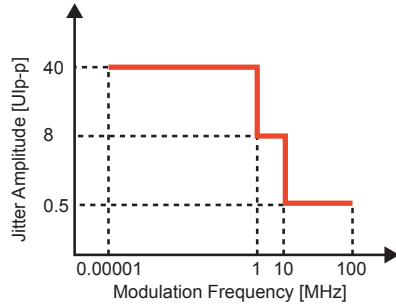

Jittered Clock Output Frequency: 0.800 001 GHz to 1.2 GHz

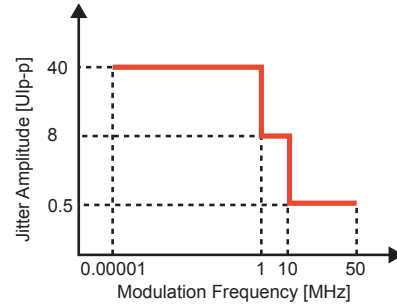

Modulation Frequency (FM): 10 Hz to 10 kHz, Steps: 1 Hz
 10 kHz to 100 kHz, Steps: 10 Hz
 100 kHz to 1 MHz, Steps: 100 Hz
 1 MHz to 10 MHz, Steps: 1 kHz
 10 MHz to 100 MHz, Steps: 10 kHz
 100 MHz to 250 MHz, Steps: 100 kHz

Accuracy: ± 100 ppm

Amplitude*1:

Jittered Clock Output Frequency: 8.500 001 GHz to 15 GHz

- 0 to 40 Ulp-p (FM: 10 Hz to 1 MHz), Steps: 0.01 UI
- 0 to 8 Ulp-p (FM: 1.001 MHz to 10 MHz), Steps: 0.01 UI
- 0 to 0.5 Ulp-p (FM: 10.01 MHz to 250 MHz), Steps: 0.001 UI

Jittered Clock Output Frequency: 4.000 001 GHz to 8.5 GHz

- 0 to 40 Ulp-p (FM: 10 Hz to 1 MHz), Steps: 0.01 UI
- 0 to 8 Ulp-p (FM: 1.001 MHz to 10 MHz), Steps: 0.01 UI
- 0 to 0.5 Ulp-p (FM: 10.01 MHz to 150 MHz), Steps: 0.001 UI

Jittered Clock Output Frequency: 1.200 001 GHz to 4 GHz

- 0 to 40 Ulp-p (FM: 10 Hz to 1 MHz), Steps: 0.01 UI
- 0 to 8 Ulp-p (FM: 1.001 MHz to 10 MHz), Steps: 0.01 UI
- 0 to 0.5 Ulp-p (FM: 10.01 MHz to 100 MHz), Steps: 0.001 UI

Jittered Clock Output Frequency: 1.800 001 GHz to 1.2 GHz

- 0 to 40 Ulp-p (FM: 10 Hz to 1 MHz), Steps: 0.01 UI
- 0 to 8 Ulp-p (FM: 1.001 MHz to 10 MHz), Steps: 0.01 UI
- 0 to 0.5 Ulp-p (FM: 10.01 MHz to 50 MHz), Steps: 0.001 UI

Accuracy: ± 0.03 UI $\pm Q\%$ (Amplitude: 0.002 Ulp-p to 2.19 Ulp-p)

± 0.2 UI $\pm Q\%$ (Amplitude: 2.2 Ulp-p to 21.9 Ulp-p)

± 2 UI $\pm Q\%$ (Amplitude: 22 Ulp-p to 50 Ulp-p)

FM	Q
10 Hz \leq fm \leq 500 kHz	7
500 kHz $<$ fm \leq 2 MHz	10
2 MHz $<$ fm \leq 80 MHz	13
80 MHz $<$ fm \leq 250 MHz	15

On/Off Function: Supported

External Sinusoidal Jitter (SJ1)
[using MU183020A/21A]

32G PPG

Full rate Clock Out setting, Bit-rate: 15 Gbit/s to 32.1 Gbit/s
Half rate Clock Out setting, Bit-rate: 2.4 Gbit/s to 32.1 Gbit/s

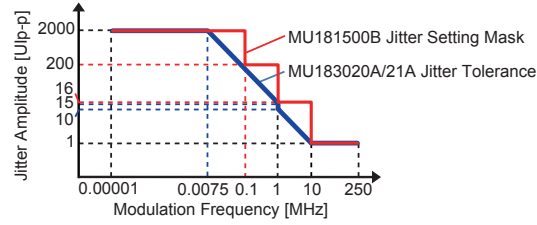

Full rate Clock Out setting, Bit-rate: 4 Gbit/s to 15 Gbit/s

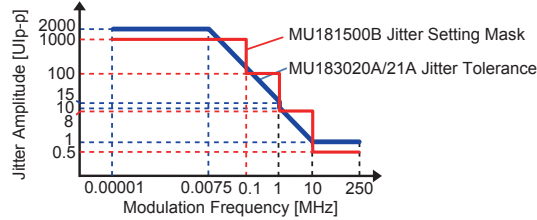

Full rate Clock Out setting, Bit-rate: 2.4 Gbit/s to 4 Gbit/s

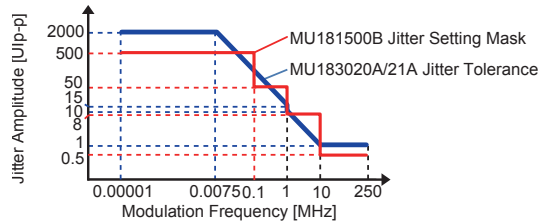

32G PPG (Full rate Clock Out, Bit-rate: 4 Gbit/s to 15 Gbit/s)
0 to 1000 Ulp-p (FM: 10 Hz to 100 kHz), Steps: 0.001 UI
0 to 100 Ulp-p (FM: 100.1 kHz to 1 MHz), Steps: 0.001 UI
0 to 8 Ulp-p (FM: 1.001 MHz to 10 MHz), Steps: 0.001 UI
0 to 0.5 Ulp-p (FM: 10.01 MHz to 250 MHz), Steps: 0.001 UI

32G PPG (Full rate Clock Out, Bit-rate: 2.4 Gbit/s to 4 Gbit/s)
0 to 500 Ulp-p (FM: 10 Hz to 100 kHz), Steps: 0.001 UI
0 to 50 Ulp-p (FM: 100.1 kHz to 1 MHz), Steps: 0.001 UI
0 to 8 Ulp-p (FM: 1.001 MHz to 10 MHz), Steps: 0.001 UI
0 to 0.5 Ulp-p (FM: 10.01 MHz to 250 MHz), Steps: 0.001 UI

32G PPG (Full rate Clock Out, Bit-rate: 15 Gbit/s to 30 Gbit/s, Half rate Clock Out, Bit-rate: 2.4 Gbit/s to 30 Gbit/s)
0 to 2000 Ulp-p (FM: 10 Hz to 100 kHz), Steps: 0.002 UI
0 to 50 Ulp-p (FM: 100.1 kHz to 1 MHz), Steps: 0.002 UI
0 to 8 Ulp-p (FM: 1.001 MHz to 10 MHz), Steps: 0.002 UI
0 to 0.5 Ulp-p (FM: 10.01 MHz to 250 MHz), Steps: 0.002 UI

32G PPG (Full rate Clock Out, Half rate Clock Out, Bit-rate: 30 Gbit/s to 32.1 Gbit/s)
0 to 2000 Ulp-p (FM: 10 Hz to 100 kHz), Steps: 0.004 UI
0 to 200 Ulp-p (FM: 100.1 kHz to 1 MHz), Steps: 0.004 UI
0 to 16 Ulp-p (FM: 1.001 MHz to 10 MHz), Steps: 0.004 UI
0 to 1 Ulp-p (FM: 10.01 MHz to 250 MHz), Steps: 0.004 UI

Accuracy: ± 0.03 UI $\pm Q\%$ (Amplitude: 0.001 to 2.199 Ulp-p)
 ± 0.2 UI $\pm Q\%$ (Amplitude: 2.2 to 21.999 Ulp-p)
 ± 2 UI $\pm Q\%$ (Amplitude: 22 to 219.999 Ulp-p)
 ± 20 UI $\pm Q\%$ (Amplitude: 220 to 2000 Ulp-p)

FW	Q
10 Hz to 500 kHz	7
500.1k Hz to 2 MHz	10
2.01 MHz to 80 MHz	13
80.01 MHz to 250 MHz	15

On/Off Function: supported

External Sinusoidal Jitter (SJ2)
[MU181000B-001]

Jitter Setting Mask*1

Jittered Clock Output Frequency: 6.400 001 GHz to 15 GHz
Full Rate Mode*2

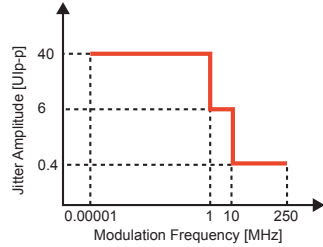

Jittered Clock Output Frequency: 3.200 001 GHz to 6.25 GHz
Full Rate Mode*2

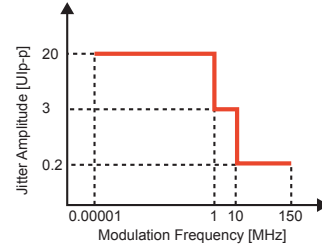

Jittered Clock Output Frequency: 1.800 001 GHz to 3.125 GHz
Full Rate Mode*2

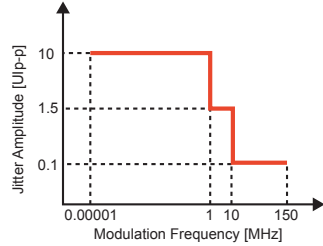

Jittered Clock Output Frequency: 1.600 001 GHz to 1.8 GHz
Full Rate Mode*2

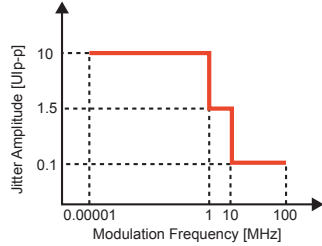

Jittered Clock Output Frequency: 0.800 001 GHz to 1.562 5 GHz
Full Rate Mode*2

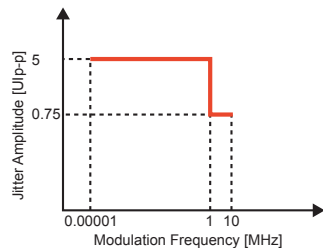

Modulation Frequency (FM): 10 Hz to 10 kHz, Steps: 1 Hz
10 kHz to 100 kHz, Steps: 10 Hz
100 kHz to 1 MHz, Steps: 100 Hz
1 MHz to 10 MHz, Steps: 1 kHz
10 MHz to 100 MHz, Steps: 10 kHz
100 MHz to 250 MHz, Steps: 100 kHz

Accuracy: ± 100 ppm

Amplitude*1:

Full Rate Mode*2

Jittered Clock Output Frequency: 6.400 001 GHz to 15 GHz
0 to 40 Ulp-p (FM: 10 Hz to 1 MHz), Steps: 0.01 UI
0 to 6 Ulp-p (FM: 1.001 MHz to 10 MHz), Steps: 0.01 UI
0 to 0.4 Ulp-p (FM: 10.01 MHz to 250 MHz), Steps: 0.001 UI

Jittered Clock Output Frequency: 3.200 001 GHz to 6.25 GHz
0 to 20 Ulp-p (FM: 10 Hz to 1 MHz), Steps: 0.01 UI
0 to 3 Ulp-p (FM: 1.001 MHz to 10 MHz), Steps: 0.01 UI
0 to 0.2 Ulp-p (FM: 10.01 MHz to 150 MHz), Steps: 0.001 UI

Jittered Clock Output Frequency: 1.800 001 GHz to 3.125 GHz
0 to 10 Ulp-p (FM: 10 Hz to 1 MHz), Steps: 0.01 UI
0 to 1.5 Ulp-p (FM: 1.001 MHz to 10 MHz), Steps: 0.01 UI
0 to 0.1 Ulp-p (FM: 10.01 MHz to 150 MHz), Steps: 0.001 UI

Jittered Clock Output Frequency: 1.600 001 GHz to 1.8 GHz
0 to 10 Ulp-p (FM: 10 Hz to 1 MHz), Steps: 0.01 UI
0 to 1.5 Ulp-p (FM: 1.001 MHz to 10 MHz), Steps: 0.01 UI
0 to 0.1 Ulp-p (FM: 10.01 MHz to 100 MHz), Steps: 0.001 UI

Jittered Clock Output Frequency: 0.800 001 GHz to 1.562 5 GHz
0 to 5 Ulp-p (FM: 10 Hz to 1 MHz), Steps: 0.01 UI
0 to 0.75 Ulp-p (FM: 1.001 MHz to 10 MHz), Steps: 0.01 UI

Accuracy: ± 0.03 UI $\pm Q\%$ (Amplitude: 0.002 Ulp-p to 2.19 Ulp-p)

± 0.2 UI $\pm Q\%$ (Amplitude: 2.2 Ulp-p to 21.9 Ulp-p)

± 2 UI $\pm Q\%$ (Amplitude: 22 Ulp-p to 50 Ulp-p)

FM	Q
10 Hz \leq fm \leq 500 kHz	10
500 kHz $<$ fm \leq 2 MHz	13
2 MHz $<$ fm \leq 80 MHz	15
80 MHz $<$ fm \leq 250 MHz	18

On/Off Function: Supported

External Sinusoidal Jitter (SJ2)
[using MU181000B-001
MU181020B]

Jitter Setting Mask*1

Jittered Clock Output Frequency: 6.400 001 GHz to 15 GHz

Full Rate Mode*2
Bit-rate: 6.400 001 Gbit/s to 15 Gbit/s

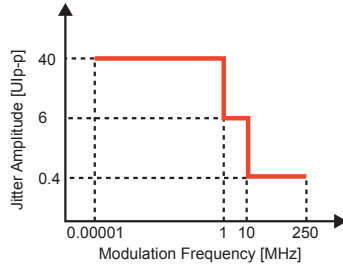

Half Rate Mode*2

Bit-rate: 12.800 001 Gbit/s to 30 Gbit/s

Quarter Rate Mode

Bit-rate: 25.600 004 Gbit/s to 32.1 Gbit/s

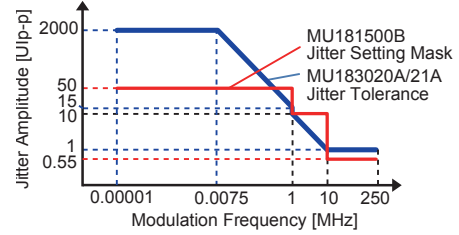

Jittered Clock Output Frequency: 3.200 001 GHz to 6.25 GHz

Full Rate Mode*2
Bit-rate: 3.200 001 Gbit/s to 6.25 Gbit/s

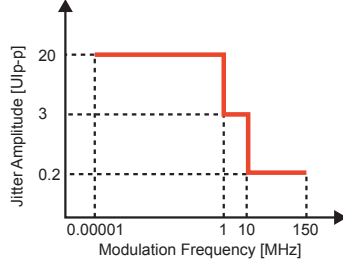

Half Rate Mode*2

Bit-rate: 8 Gbit/s to 12.5 Gbit/s

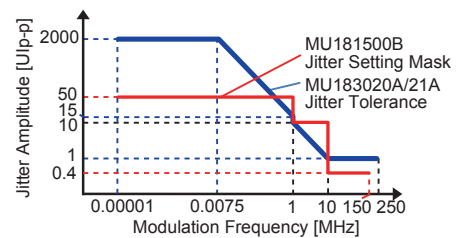

Jittered Clock Output Frequency: 1.800 001 GHz to 3.125 GHz

Full Rate Mode*2
Bit-rate: 1.800 001 Gbit/s to 3.125 Gbit/s

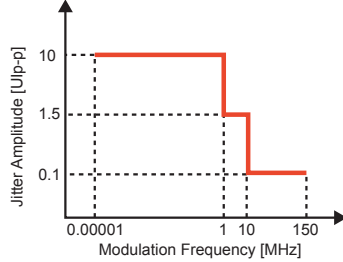

Half Rate Mode*2

Bit-rate: 3.600 002 Gbit/s to 6.25 Gbit/s

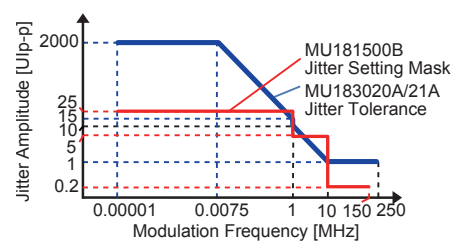

Jittered Clock Output Frequency: 1.600 001 GHz to 1.8 GHz

Full Rate Mode*2
Bit-rate: 1.600 001 Gbit/s to 1.8 Gbit/s

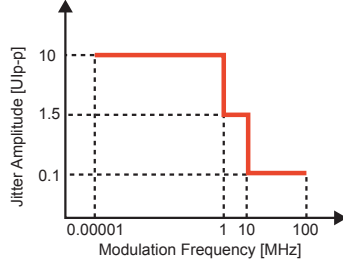

Half Rate Mode*2

Bit-rate: 3.200 002 Gbit/s to 3.6 Gbit/s

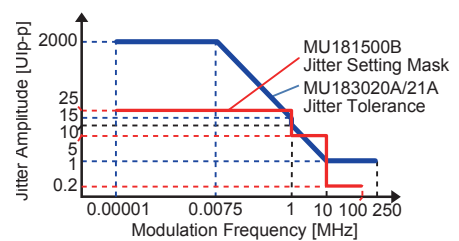

Jittered Clock Output Frequency: 0.800 001 GHz to 1.562 5 GHz

Full Rate Mode*2
Bit-rate: 0.800 001 Gbit/s to 1.562 5 Gbit/s

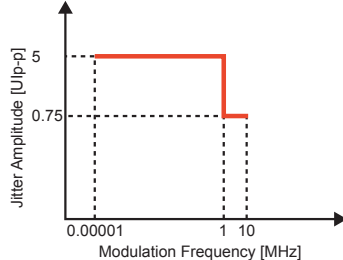

Half Rate Mode*2

Bit-rate: 1.600 002 Gbit/s to 3.125 Gbit/s

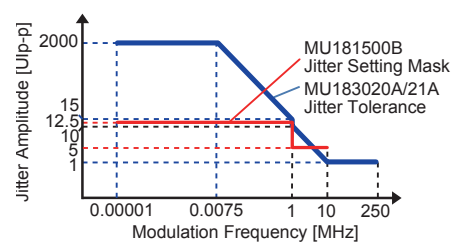

External Sinusoidal Jitter (SJ2)
[using MU181000B-001
MU181020B]

Modulation Frequency (FM): 10 Hz to 10 kHz, Steps: 1 Hz
10 kHz to 100 kHz, Steps: 10 Hz
100 kHz to 1 MHz, Steps: 100 Hz
1 MHz to 10 MHz, Steps: 1 kHz
10 MHz to 100 MHz, Steps: 10 kHz
100 MHz to 250 MHz, Steps: 100 kHz

Accuracy: ± 100 ppm

Amplitude*1:

Full Rate Mode*2

Bit-rate: 6.400 001 Gbit/s to 15 Gbit/s

0 to 40 Ulp-p (FM: 10 Hz to 1 MHz), Steps: 0.001 UI

0 to 6 Ulp-p (FM: 1.001 MHz to 10 MHz), Steps: 0.001 UI

0 to 0.4 Ulp-p (FM: 10.01 MHz to 250 MHz), Steps: 0.001 UI

Bit-rate: 3.200 001 Gbit/s to 6.25 Gbit/s

0 to 20 Ulp-p (FM: 10 Hz to 1 MHz), Steps: 0.001 UI

0 to 3 Ulp-p (FM: 1.001 MHz to 10 MHz), Steps: 0.001 UI

0 to 0.2 Ulp-p (FM: 10.01 MHz to 150 MHz), Steps: 0.001 UI

Bit-rate: 1.800 001 Gbit/s to 3.125 Gbit/s

0 to 10 Ulp-p (FM: 10 Hz to 1 MHz), Steps: 0.001 UI

0 to 1.5 Ulp-p (FM: 1.001 MHz to 10 MHz), Steps: 0.001 UI

0 to 0.1 Ulp-p (FM: 10.01 MHz to 150 MHz), Steps: 0.001 UI

Bit-rate: 1.600 001 Gbit/s to 1.8 Gbit/s

0 to 10 Ulp-p (FM: 10 Hz to 1 MHz), Steps: 0.001 UI

0 to 1.5 Ulp-p (FM: 1.001 MHz to 10 MHz), Steps: 0.001 UI

0 to 0.1 Ulp-p (FM: 10.01 MHz to 100 MHz), Steps: 0.001 UI

Bit-rate: 0.800 001 Gbit/s to 1.562 5 Gbit/s

0 to 5 Ulp-p (FM: 10 Hz to 1 MHz), Steps: 0.001 UI

0 to 0.75 Ulp-p (FM: 1.001 MHz to 10 MHz), Steps: 0.001 UI

Half Rate Mode*2

Bit-rate: 12.800 001 Gbit/s to 30 Gbit/s

0 to 50 Ulp-p (FM: 10 Hz to 1 MHz), Steps: 0.2 UI

0 to 10 Ulp-p (FM: 1.001 MHz to 10 MHz), Steps: 0.02 UI

0 to 0.55 Ulp-p (FM: 10.01 MHz to 250 MHz), Steps: 0.002 UI

Bit-rate: 8 Gbit/s to 12.5 Gbit/s

0 to 50 Ulp-p (FM: 10 Hz to 1 MHz), Steps: 0.2 UI

0 to 10 Ulp-p (FM: 1.001 MHz to 10 MHz), Steps: 0.02 UI

0 to 0.4 Ulp-p (FM: 10.01 MHz to 150 MHz), Steps: 0.002 UI

Bit-rate: 3.600 002 Gbit/s to 6.25 Gbit/s

0 to 25 Ulp-p (FM: 10 Hz to 1 MHz), Steps: 0.2 UI

0 to 5 Ulp-p (FM: 1.001 MHz to 10 MHz), Steps: 0.02 UI

0 to 0.2 Ulp-p (FM: 10.01 MHz to 150 MHz), Steps: 0.002 UI

Bit-rate: 3.200 002 Gbit/s to 3.6 Gbit/s

0 to 25 Ulp-p (FM: 10 Hz to 1 MHz), Steps: 0.2 UI

0 to 5 Ulp-p (FM: 1.001 MHz to 10 MHz), Steps: 0.02 UI

0 to 0.2 Ulp-p (FM: 10.01 MHz to 100 MHz), Steps: 0.002 UI

Bit-rate: 1.600 002 Gbit/s to 3.125 Gbit/s

0 to 12.5 Ulp-p (FM: 10 Hz to 1 MHz), Steps: 0.2 UI

0 to 2.5 Ulp-p (FM: 1.001 MHz to 10 MHz), Steps: 0.02 UI

Quarter Rate Mode*2

Bit-rate: 25.600 004 Gbit/s to 32.1 Gbit/s

0 to 50 Ulp-p (FM: 10 Hz to 1 MHz), Steps: 0.004 UI

0 to 10 Ulp-p (FM: 1.001 MHz to 10 MHz), Steps: 0.004 UI

0 to 0.548 Ulp-p (FM: 10.01 MHz to 250 MHz), Steps: 0.004 UI

Accuracy: ± 0.03 UI $\pm Q\%$ (Amplitude: 0.002 Ulp-p to 2.19 Ulp-p)

± 0.2 UI $\pm Q\%$ (Amplitude: 2.2 Ulp-p to 21.9 Ulp-p)

± 2 UI $\pm Q\%$ (Amplitude: 22 Ulp-p to 50 Ulp-p)

FM	Q
10 Hz \leq fm \leq 500 kHz	10
500 kHz $<$ fm \leq 2 MHz	13
2 MHz $<$ fm \leq 80 MHz	15
80 MHz $<$ fm \leq 250 MHz	18

On/Off Function: Supported

Spread Spectrum Clocking (SSC)

Type: Down-Spread, Center-Spread, Up-Spread

Modulation Frequency: 28 kHz to 34 kHz, Steps: 1 Hz

Accuracy: ± 100 ppm

Deviation: 0 to 5300 ppm, Steps: 1 ppm

On/Off Function: Supported

<p>Random Jitter (RJ)</p>	<p>Bandwidth: 10 kHz to 1 GHz Crest Factor: 16 dB</p> <p>Filter Type User Filter Filter: 10 MHz, 20 MHz, Through (HPF 3 dB bandwidth) 100 MHz, Through (LPF 3 dB bandwidth)</p> <p>Amplitude*1 Full Rate Mode*2</p> <table border="1"> <thead> <tr> <th>Jittered Clock Output Frequency [GHz]</th> <th>Setting Range [UIp-p]</th> <th>Steps [mUI]</th> </tr> </thead> <tbody> <tr> <td>≥2.5</td> <td>0 to 0.5</td> <td>2</td> </tr> <tr> <td><2.5</td> <td>0 to 0.2f</td> <td>2</td> </tr> </tbody> </table> <p>Half Rate Mode*3</p> <table border="1"> <thead> <tr> <th>Jittered Clock Output Frequency [GHz]</th> <th>Setting Range [UIp-p]</th> <th>Steps [mUI]</th> </tr> </thead> <tbody> <tr> <td>≥2.5</td> <td>0 to 0.5</td> <td>4</td> </tr> <tr> <td><2.5</td> <td>0 to 0.2f</td> <td>4</td> </tr> </tbody> </table> <p>Quarter Rate Mode</p> <table border="1"> <thead> <tr> <th>Jittered Clock Output Frequency [GHz]</th> <th>Setting Range [UIp-p]</th> <th>Steps [mUI]</th> </tr> </thead> <tbody> <tr> <td>≥2.5</td> <td>0 to 0.496</td> <td>4</td> </tr> <tr> <td><2.5</td> <td>0 to 0.2f</td> <td>4</td> </tr> </tbody> </table> <p>f: Jittered Clock Output Frequency [GHz] Accuracy: ±4.9 ps ±15% (Jittered Clock Output Frequency: ≥4 GHz) ±7.0 ps ±15% (Jittered Clock Output Frequency: <4 GHz)</p> <p>PCIe (Data clocked) or PCIe (Common Ref. clock) Filter Filter: LF (10 kHz to 1.5 MHz) or HF (1.5 MHz to 100 MHz) for PCIe</p> <p>Amplitude*1 Full Rate Mode*2</p> <table border="1"> <thead> <tr> <th>Jittered Clock Output Frequency [GHz]</th> <th>LF and HF Setting Range [ps rms]</th> <th>Steps [ps rms]</th> </tr> </thead> <tbody> <tr> <td>≥4</td> <td>0 to 8.8</td> <td>0.1</td> </tr> </tbody> </table> <p>Half Rate Mode*2</p> <table border="1"> <thead> <tr> <th>Jittered Clock Output Frequency [GHz]</th> <th>LF and HF Setting Range [ps rms]</th> <th>Steps [ps rms]</th> </tr> </thead> <tbody> <tr> <td>≥4</td> <td>0 to 8.8</td> <td>0.2</td> </tr> </tbody> </table> <p>Quarter Rate Mode</p> <table border="1"> <thead> <tr> <th>Jittered Clock Output Frequency [GHz]</th> <th>LF and HF Setting Range [ps rms]</th> <th>Steps [ps rms]</th> </tr> </thead> <tbody> <tr> <td>≥4</td> <td>0 to 8.8</td> <td>0.4</td> </tr> </tbody> </table> <p>LF Amplitude ≥ HF Amplitude Accuracy: ±0.6 ps ±10% On/Off Function: Supported</p>	Jittered Clock Output Frequency [GHz]	Setting Range [UIp-p]	Steps [mUI]	≥2.5	0 to 0.5	2	<2.5	0 to 0.2f	2	Jittered Clock Output Frequency [GHz]	Setting Range [UIp-p]	Steps [mUI]	≥2.5	0 to 0.5	4	<2.5	0 to 0.2f	4	Jittered Clock Output Frequency [GHz]	Setting Range [UIp-p]	Steps [mUI]	≥2.5	0 to 0.496	4	<2.5	0 to 0.2f	4	Jittered Clock Output Frequency [GHz]	LF and HF Setting Range [ps rms]	Steps [ps rms]	≥4	0 to 8.8	0.1	Jittered Clock Output Frequency [GHz]	LF and HF Setting Range [ps rms]	Steps [ps rms]	≥4	0 to 8.8	0.2	Jittered Clock Output Frequency [GHz]	LF and HF Setting Range [ps rms]	Steps [ps rms]	≥4	0 to 8.8	0.4
Jittered Clock Output Frequency [GHz]	Setting Range [UIp-p]	Steps [mUI]																																												
≥2.5	0 to 0.5	2																																												
<2.5	0 to 0.2f	2																																												
Jittered Clock Output Frequency [GHz]	Setting Range [UIp-p]	Steps [mUI]																																												
≥2.5	0 to 0.5	4																																												
<2.5	0 to 0.2f	4																																												
Jittered Clock Output Frequency [GHz]	Setting Range [UIp-p]	Steps [mUI]																																												
≥2.5	0 to 0.496	4																																												
<2.5	0 to 0.2f	4																																												
Jittered Clock Output Frequency [GHz]	LF and HF Setting Range [ps rms]	Steps [ps rms]																																												
≥4	0 to 8.8	0.1																																												
Jittered Clock Output Frequency [GHz]	LF and HF Setting Range [ps rms]	Steps [ps rms]																																												
≥4	0 to 8.8	0.2																																												
Jittered Clock Output Frequency [GHz]	LF and HF Setting Range [ps rms]	Steps [ps rms]																																												
≥4	0 to 8.8	0.4																																												
<p>Bounded Uncorrelated Jitter (BUJ)</p>	<p>PRBS Pattern Length: 2ⁿ - 1 (n = 7, 9, 11, 15, 23, or 31) BUJ Rate: 0.1 Gbit/s to 3.2 Gbit/s, Steps: 1 kbit/s 4.9 Gbit/s to 6.25 Gbit/s, Steps: 1 kbit/s (Jittered Clock Output Frequency: >4 GHz) 9.8 Gbit/s to 12.5 Gbit/s, Steps: 1 kbit/s (Jittered Clock Output Frequency: >4 GHz)</p> <p>Filter Type (LPF 3 dB Bandwidth): 50, 100, 200, 300, 500 MHz, Through (Jittered Clock Output Frequency: >4 GHz) 50, 100, 200, 300 MHz, Through (Jittered Clock Output Frequency: ≤4 GHz)</p> <p>Amplitude*1: Full Rate Mode*2</p> <table border="1"> <thead> <tr> <th>Jittered Clock Output Frequency [GHz]</th> <th>Setting Range [UIp-p]</th> <th>Steps [mUI]</th> </tr> </thead> <tbody> <tr> <td>≥2.5</td> <td>0 to 0.5</td> <td>2</td> </tr> <tr> <td><2.5</td> <td>0 to 0.2f</td> <td>2</td> </tr> </tbody> </table> <p>Half Rate Mode*2</p> <table border="1"> <thead> <tr> <th>Jittered Clock Output Frequency [GHz]</th> <th>Setting Range [UIp-p]</th> <th>Steps [mUI]</th> </tr> </thead> <tbody> <tr> <td>≥2.5</td> <td>0 to 0.5</td> <td>4</td> </tr> <tr> <td><2.5</td> <td>0 to 0.2f</td> <td>4</td> </tr> </tbody> </table> <p>f: Jittered Clock Output Frequency [GHz] Accuracy: ±4.9 ps ±15% (Jittered Clock Output Frequency: ≥4 GHz) ±7.0 ps ±15% (Jittered Clock Output Frequency: <4 GHz)</p> <p>PRBS Pattern Length: 2ⁿ - 1 (n = 7, 9) BUJ Rate: 6, 5.5, 4.9 Gbit/s, LPF 500 MHz BUJ Rate: 3.2 Gbit/s, 3 Gbit/s, LPF 300 MHz BUJ Rate: 3.2 Gbit/s, 2 Gbit/s, LPF 200 MHz BUJ Rate: 2 Gbit/s, 1.1 Gbit/s, LPF 100 MHz</p> <p>On/Off Function: Supported</p>	Jittered Clock Output Frequency [GHz]	Setting Range [UIp-p]	Steps [mUI]	≥2.5	0 to 0.5	2	<2.5	0 to 0.2f	2	Jittered Clock Output Frequency [GHz]	Setting Range [UIp-p]	Steps [mUI]	≥2.5	0 to 0.5	4	<2.5	0 to 0.2f	4																											
Jittered Clock Output Frequency [GHz]	Setting Range [UIp-p]	Steps [mUI]																																												
≥2.5	0 to 0.5	2																																												
<2.5	0 to 0.2f	2																																												
Jittered Clock Output Frequency [GHz]	Setting Range [UIp-p]	Steps [mUI]																																												
≥2.5	0 to 0.5	4																																												
<2.5	0 to 0.2f	4																																												
<p>External Jitter</p>	<p>Bandwidth: 10 kHz to 1 GHz Accuracy*3: 0.5 UI ±10% (2 Vp-p) Linearity*3: ±6 ps ±10% On/Off Function: Supported</p>																																													

*1: The maximum jitter amplitude is limited according to the jitter tolerance of PPG or ED modules. Refer to the jitter tolerance specification of PPG/ED modules.

*2: Full Rate Mode: MU181020B PPG

*3: Jittered Clock Output Frequency: Specified as 5 GHz, Modulation Frequency: 0.5 GHz, Sinusoidal Jitter

• **MP1825B 4Tap Emphasis**

Bit Rate	<p>1 Gbit/s to 14.05 Gbit/s [MP1825B-001] 1 Gbit/s to 14.1 Gbit/s [MP1825B-001, 005] 1 Gbit/s to 28.1 Gbit/s [MP1825B-002, when not using Doubler Input/Output] 1 Gbit/s to 32.1 Gbit/s [MP1825B-002, 006, when not using Doubler Input/Output] 8 Gbit/s to 28.1 Gbit/s [MP1825B-002, when using Doubler Input/Output]</p>
Data Output*1	<p>Number of Output: 2 (Data/xData) Emphasis Setting: Selectable from pre-emphasis or de-emphasis*2 a) 2post-cursor, 1pre-cursor b) 3post-cursor c) 1post-cursor, 1pre-cursor d) 2post-cursor e) 1post-cursor f) Rev. 3post-cursor g) 1post-cursor, 2pre-cursor Peak Voltage: 100 mVp-p to 1.5 Vp-p (Single-ended) Eye Amplitude: 100 mVp-p to 1.0 Vp-p (Single-ended), Steps: 2 mVp-p Offset: -1.0 Vth to +1.0 Vth, Steps: 1 mV Total Jitter*3: 8 ps p-p (typ.) Tr/Tf*4: 20 ps (typ.), ≤25 ps (20 to 80%) [MP1825B-001] 12 ps (typ.), ≤16 ps (20 to 80%) [MP1825B-002] Cursor1 Emphasis: -20 to +20 dB, 20log (Eye Amplitude/Cursor1), Steps: 0.1 dB Cursor2 Emphasis: -20 to +20 dB, 20log (Eye Amplitude/Cursor2), Steps: 0.1 dB Cursor3 Emphasis: -20 to +20 dB, 20log (Eye Amplitude/Cursor3), Steps: 0.1 dB On/Off Function: Supported Connector: K (f.), Termination: 50Ω/AC Coupling</p>
Data Input	<p>Amplitude: 0.4 Vp-p to 1.2 Vp-p Connector: SMA (f.) [MP1825B-001], K (f.) [MP1825B-002], Termination: 50Ω/GND</p>
Clock Input	<p>Frequency Range: 1 GHz to 14.05 GHz [MP1825B-001] 1 GHz to 14.1 GHz [MP1825B-001, 005] 1 GHz to 28.1 GHz [MP1825B-002] 1 GHz to 32.1 GHz [MP1825B-002, 006] Amplitude: 0.25 Vp-p to 1.0 Vp-p Connector: SMA (f.) [MP1825B-001], K (f.) [MP1825B-002], Termination: 50Ω/AC Coupling</p>
Clock Buffer Output	<p>Frequency Range: 1 GHz to 14.05 GHz [MP1825B-001] 1 GHz to 14.1 GHz [MP1825B-001, 005] 4 GHz to 14.05 GHz [MP1825B-002] Amplitude: 0.4 Vp-p (Min.), 1.0 Vp-p (Max.) (Fixed) Connector: SMA (f.), Termination: 50Ω/AC Coupling</p>
Doubler Input [MP1825B-002]	<p>Frequency Range: 4 GHz to 14.05 GHz Amplitude: 0.25 Vp-p to 1.2 Vp-p Connector: SMA (f.), Termination: 50Ω/AC Coupling</p>
Doubler Output [MP1825B-002]	<p>Amplitude: 0.4 Vp-p (Min.), 1.0 Vp-p (Max.) (Fixed) Connector: K (f.), Termination: 50Ω/AC Coupling</p>
Variable Data Delay [MP1825B-003 or MP1825B-004]	<p>Phase Variable Range: -1000 mUI to +1000 mUI Accuracy: 50 mUIp-p (typ.)</p>
General Specification	<p>Channel Switch: 1ch/2ch (Rear panel switch) Operation Interface: USB 2.0 or 1.1 Type B Power Supply: 100 V(ac) to 240 V(ac), 50 Hz/60 Hz Power Consumption: <100 W Dimensions: 120 (W) × 90.9 (H) × 140 (D) mm Mass: <5 kg Operating Temperature: 15° to 35°C EMC: 2014/30/EU, EN61326-1, EN61000-3-2 LVD: 2014/35/EU, EN61010-1</p>

*1: Measured at PRBS 2³¹ - 1, Mark Ratio 1/2 with 50 GHz sampling oscilloscope

*2: Only c) 1post-cursor, 1pre-cursor can be set when de-emphasis is selected

*3: Measured at 14.05 Gbit/s or 28.1 Gbit/s (with MP1825B-002) with the sampling oscilloscope, intrinsic jitter should be less than 200 fs (rms)

*4: Emphasis Function: Off

• **MZ1834A 4PAM Converter**

Data Output	Number of Outputs: 2 (Data, xData) Modulation Format: PAM4 Output Amplitude*1: 0.238 Vp-p to 0.475 Vp-p (nom.) (with using MU183020A-022 or MU183021A-012) 0.238 Vp-p to 0.832 Vp-p (nom.) (with using MU183020A-023 or MU183021A-013) Tr/Tf: 12 ps (typ.) (20 to 80%, with using MU18302xA) Connector: K (f.)
Data Input	Number of Inputs: 4 (Data1, xData1, Data2, xData2) Input Amplitude: 0.5 Vp-p to 3.5 Vp-p Connector: K (m.)
Insertion Loss	-16 dB (nom.)*2
General	Temperature: +15° to +35°C (Operating), -20° to +60°C (Storage) Mass: 2 kg max. Dimensions: 92.2 (W) × 20.4 (H) × 121.7 (D) mm*3

- *1: 0 to 3 Level
- *2: Data_n input to Data output
- *3: Excluding protrusions

• **MZ1834B 4PAM Converter**

Data Output	Number of Outputs: 2 (Data, xData) Modulation Format: PAM4 Output Amplitude*1: 0.376 Vp-p to 0.753 Vp-p (nom.) (with using MU183020A-022 or MU183021A-012) 0.756 Vp-p to 1.318 Vp-p (nom.) (with using MU183020A-023 or MU183021A-013) Tr/Tf: 12 ps (typ.) (20 to 80%, with using MU18302xA) Connector: K (f.)
Data Input	Number of Inputs: 4 (Data1, xData1, Data2, xData2) Input Amplitude: 0.5 Vp-p to 3.5 Vp-p Connector: K (m.)
Insertion Loss	-12 dB (nom.)*2
General	Temperature: +15° to +35°C (Operating), -20° to +60°C (Storage) Mass: 2 kg max. Dimensions: 92.2 (W) × 20.4 (H) × 121.7 (D) mm*3

- *1: 0 to 3 Level
- *2: Data_n input to Data output
- *3: Excluding protrusions

• **MZ1838A 8PAM Converter**

Data Output	Number of Outputs: 2 (Data, xData) Modulation Format: PAM8 Output Amplitude*2: 0.139 Vp-p to 0.441 Vp-p (nom.) (with using MU183021A-012) 0.139 Vp-p to 0.772 Vp-p (nom.) (with using MU183021A-013) Tr/Tf: 12 ps (typ.) (20 to 80%, with using MU18302xA) Connector: K (f.)
Data Input	Number of Inputs: 6 (Data1, xData1, Data2, xData2, Data3, xData3) Input Amplitude: 0.5 Vp-p to 3.5 Vp-p Connector: K (m.)
Insertion Loss	Data1: -16 dB, Data2: -24 dB, Data3: -28 dB (nom.)*2
General	Temperature: +15° to +35°C (Operating), -20° to +60°C (Storage) Mass: 3 kg max. Dimensions: 96.8 (W) × 40 (H) × 181.2 (D) mm*3

- *1: 0 to 7 Level
- *2: Data_n input to Data output
- *3: Excluding protrusions

• **J1621A Passive Equalizer 3 dB, J1622A Passive Equalizer 6 dB**

Frequency Range	DC to 14.0 GHz (25 Gbit/s to 28 Gbit/s)
Slope	3.0 ±0.5 dB (J1621A) 6.0 ±0.5 dB (J1622A)
Insertion Loss	At 14 GHz ≤1.2 dB (J1621A) ≤1.4 dB (J1622A)
Return Loss	12 dB (min.)
General	Connectors: SMA Impedance: 50Ω (nom.) Dimension: 44(W) × 12 (H) × 11(D) mm

• **G0361A 64Gbaud 2-bit DAC with MUX**

Operating baud-rate	DC to 64Gbaud
Data Output	Number of Outputs: 2 (Data, xData) Output Amplitude: 0.7 Vp-p (Typ. Single-end), 1.4 Vp-p (Typ. Differential) Connector: V (f.)
Data Input	Number of Inputs: 4 (D0A, D0B, D1A, D1B) Input Amplitude: 0.5 Vp-p (Typ.) Connector: K (f.)
Clock Input	Number of Inputs: 1 Input Amplitude: 0.5 Vp-p (Typ.) Connector: K (f.)
Power Supply	VEE: -3.7 V, 2.1 W (Typ.) Vamp1, 2: -3.4 V (Typ.) for Amplitude Control CLKref: Clock Reference Voltage, Dref: Data Input Reference Voltage

• **G0373A USB3.1 Receiver Test Adapter**

Bit Rate	5G (USB3.1G1), 10G (USB3.1G2)
Data Output	LFPS Rx Amplitude: -1 V to +0.5 V LFPS Tx Amplitude: 3 Vp-p (typ., Differential)
Data Input	Rx Amplitude: 0.8 V to 1.2 V AUX Amplitude: -1 V to +0.5 V Gating Amplitude: -1.25 V to +0.8 V External Frequency: 4 GHz Connector: SMA (f.)
Power Supply	100 V(ac) to 120 V(ac)/200 V(ac) to 240 V(ac) [auto-switching between 100 V(ac)/200 V(ac)], 50 Hz to 60 Hz

• **G0374A 64Gbaud PAM4 DAC**

Baud Rate	DC to 64Gbaud
Data Output	Number of Outputs: 2 (Data, xData) Output Amplitude: 0.7 Vp-p (typ. Single-end), 1.4 Vp-p (typ. Differential) Connector: V (f.)
Data Input	Number of Inputs: 4 (D0A, D0B, D1A, D1B) Input Amplitude: 1 Vp-p (typ.) Connector: K (f.)
Clock Input	Number of Inputs: 1 Input Amplitude: 0.5 Vp-p (typ.) Connector: K (f.)
Power Supply	100 V(ac) to 120 V(ac)/200 V(ac) to 240 V(ac) [auto-switching between 100 V(ac)/200 V(ac)], 50 Hz to 60 Hz

• **G0375A 32Gbaud Power PAM4 Converter**

Number of Outputs	2 (Data, xData)
Baud Rate	10 to 32.1 Gbaud
Output Amplitude	2.2 Vp-p (Single-end, maximum) 4.4 Vp-p (Differential, maximum)
Amplitude Gain Control	-6 to 0 dB
RJ (rms)	200 fs (typ.)
Tr/Tf (20 - 80%)	12 ps (typ.)
Number of Inputs	4 (Data1, xData1, Data2, xData2) Uses J1735A at PAM4 Linearity control
In/Out Connector	K (f.)

• **G0376A 32 Gbaud PAM4 Decoder with CTLE**

Number of Data inputs	5 (CTLE Input (diff.), Decoder Input (diff.), Clock Input)
Number of Data outputs	5 (CTLE Output (diff.), Decoder Data Output1, 2, Monitor Output)
PAM4 Decoder Baud-rate	10 to 32.1 Gbaud (DFF On) 10 to 28 Gbaud (DFF Off)
Input Amplitude	0.4 V (CTLE input, max.) 0.5 V (Decoder input, max.)
Decoder Input Sensitivity	40 mV (typ.) Eye Height, Single-end
Decoder Output Amplitude	0.3 Vp-p (typ.)
CTLE gain	-12 to 0 dB, adjustable
CTLE peak Frequency	14 GHz
In/Out Connector	K (f.)

Ordering Information

Please specify the model/order number, name and quantity when ordering.
The names listed in the chart below are Order Names. The actual name of the item may differ from the Order Name.

• MU183020A

Model/Order No.	Name
Unit/Module	
MU183020A	28G/32G bit/s PPG
Standard Accessories	
J1137	Terminator: 3 pcs
J1359A	Coaxial Adaptor (K-P, K-J, SMA): 1 pc
J1341A	Open: 1 pc
J0541E	6 dB Fixed Attenuator: 1 pc
Z0897A	MP1800A Manual CD: 1 pc
Z0918A	MX180000A Software CD: 1 pc
Options	
MU183020A-001	32G bit/s Extension
MU183020A-012	1ch 2 V Data Output
MU183020A-013	1ch 3.5 V Data Output
MU183020A-022	2ch 2 V Data Output
MU183020A-023	2ch 3.5 V Data Output
MU183020A-030	1ch Data Delay
MU183020A-031	2ch Data Delay
Retrofit Options	
MU183020A-101	32G bit/s Extension Retrofit
MU183020A-112	1ch 2 V Data Output Retrofit
MU183020A-113	1ch 3.5 V Data Output Retrofit
MU183020A-122	2ch 2 V Data Output Retrofit
MU183020A-123	2ch 3.5 V Data Output Retrofit
MU183020A-130	1ch Data Delay Retrofit
MU183020A-131	2ch Data Delay Retrofit
Standard Accessories for MU183020A-x12, x13	
J1137	Terminator: 2 pcs
J1359A	Coaxial Adaptor (K-P, K-J, SMA): 2 pcs
Standard Accessories for MU183020A-x22, x23	
J1137	Terminator: 4 pcs
J1359A	Coaxial Adaptor (K-P, K-J, SMA): 4 pcs
Maintenance Service	
MU183020A-ES310	Three Years Extended Warranty Service
MU183020A-ES510	Five Years Extended Warranty Service

• MU183040B

Model/Order No.	Name
Unit/Module	
MU183040B	28G/32G bit/s High Sensitivity ED
Standard Accessories	
J1137	Terminator: 2 pcs
J1341A	Open: 1 pc
Z0897A	MP1800A Manual CD: 1 pc
Z0918A	MX180000A Software CD: 1 pc
Options	
MU183040B-001	32 Gbit/s Extension
MU183040B-010	1ch ED
MU183040B-020	2ch ED
MU183040B-022	2.4G to 28.1G bit/s Clock Recovery
MU183040B-023	25.5G to 32.1G bit/s Clock Recovery
Retrofit Options	
MU183040B-101	32 Gbit/s Extension Retrofit
MU183040B-110	1ch ED Retrofit
MU183040B-120	2ch ED Retrofit
MU183040B-122	2.4G to 28.1G bit/s Clock Recover Retrofit
MU183040B-123	25.5G to 32.1G bit/s Clock Recovery Retrofit
Standard Accessories for MU183040B-x10	
J1341A	Open: 2 pcs
J1359A	Coaxial Adaptor (K-P, K-J, SMA): 2 pcs
41KC-6	Precision Fixed Attenuator 6 dB: 2 pcs
Standard Accessories for MU183040B-x20	
J1341A	Open: 4 pcs
J1359A	Coaxial Adaptor (K-P, K-J, SMA): 4 pcs
41KC-6	Precision Fixed Attenuator 6 dB: 4 pcs
Maintenance Service	
MU183040B-ES310	Three Years Extended Warranty Service
MU183040B-ES510	Five Years Extended Warranty Service

• MU183021A

Model/Order No.	Name
Unit/Module	
MU183021A	28G/32G bit/s 4ch PPG
Standard Accessories	
J1137	Terminator: 3 pcs
J1359A	Coaxial Adaptor (K-P, K-J, SMA): 1 pc
J1341A	Open: 1 pc
J0541E	6 dB Fixed Attenuator: 1 pc
Z0897A	MP1800A Manual CD: 1 pc
Z0918A	MX180000A Software CD: 1 pc
Options	
MU183021A-001	32G bit/s Extension
MU183021A-012	4ch 2.0 V Data Output
MU183021A-013	4ch 3.5 V Data Output
MU183021A-030	4ch Data Delay
Retrofit Options	
MU183021A-101	32G bit/s Extension Retrofit
MU183021A-112	4ch 2.0 V Data Output Retrofit
MU183021A-113	4ch 3.5 V Data Output Retrofit
MU183021A-130	4ch Data Delay Retrofit
Standard Accessories for MU183021A-x12, x13	
J1137	Terminator: 8 pcs
J1359A	Coaxial Adaptor (K-P, K-J, SMA): 8 pcs
Maintenance Service	
MU183021A-ES310	Three Years Extended Warranty Service
MU183021A-ES510	Five Years Extended Warranty Service

• MU183041B

Model/Order No.	Name
Unit/Module	
MU183041B	28G/32G bit/s 4ch High Sensitivity ED
Standard Accessories	
J1137	Terminator: 3 pcs
J1341A	Open: 9 pcs
J1359A	Coaxial Adaptor (K-P, K-J, SMA): 8 pcs
41KC-6	Precision Fixed Attenuator 6 dB: 8 pcs
Z0897A	MP1800A Manual CD: 1 pc
Z0918A	MX180000A Software CD: 1 pc
Options	
MU183041B-001	32 Gbit/s Extension
MU183041B-022	2.4G to 28.1G bit/s Clock Recovery
MU183041B-023	25.5G to 32.1G bit/s Clock Recovery
Retrofit Options	
MU183041B-101	32 Gbit/s Extension Retrofit
MU183041B-122	2.4G to 28.1G bit/s Clock Recovery Retrofit
MU183041B-123	25.5G to 32.1G bit/s Clock Recovery Retrofit
Maintenance Service	
MU183041B-ES310	Three Years Extended Warranty Service
MU183041B-ES510	Five Years Extended Warranty Service

• MP1825B

Model/Order No.	Name
Main Frame	
MP1825B*1	4Tap Emphasis
Standard Accessories	
J1137	Terminator: 3 pcs
J1341A	Open: 2 pcs
J1359A*2	Coaxial Adaptor (K-P, K-J, SMA compatible): 2 pcs/3 pcs
J1507A*3	Semirigid Cable: 1 pc
J1475A	USB Cable: 1 pc
Z1312A	AC Adaptor: 1 pc
	Power Cord: 1 pc
Z0897A	MP1800A Manual CD: 1 pc
Z0918A	MX180000A Software CD: 1 pc
Options	
MP1825B-001	14 Gbit/s Operation
MP1825B-002	28 Gbit/s Operation
MP1825B-003	14 Gbit/s Variable Data Delay
MP1825B-004	28 Gbit/s Variable Data Delay
MP1825B-005	14.1 Gbit/s Extension
MP1825B-006	32.1 Gbit/s Extension
Retrofit Options	
MP1825B-103	14 Gbit/s Variable Data Delay Retrofit
MP1825B-104	28 Gbit/s Variable Data Delay Retrofit
MP1825B-105	14.1 Gbit/s Extension Retrofit
MP1825B-106	32.1 Gbit/s Extension Retrofit

*1: MP1825B is not RoHS compliant.

*2: MP1825B-001: 2 pcs, MP1825B-002: 3 pcs

*3: Select MP1825B-002

• **MZ1834A**

Model/Order No.	Name	
Main Frame		
MZ1834A	4PAM Converter	
Standard Accessories		
J1359A	Coaxial Adaptor (K-P, K-J, SMA):	2 pcs
Z0897A	MP1800A Manual CD:	1 pc

• **MZ1834B**

Model/Order No.	Name	
Main Frame		
MZ1834B	4PAM Converter	
Standard Accessories		
J1359A	Coaxial Adaptor (K-P, K-J, SMA):	2 pcs
Z0897A	MP1800A Manual CD:	1 pc

• **MZ1838A**

Model/Order No.	Name	
Main Frame		
MZ1838A	8PAM Converter	
Standard Accessories		
J1359A	Coaxial Adaptor (K-P, K-J, SMA):	2 pcs
Z0897A	MP1800A Manual CD:	1 pc

• **G0373A***4

Model/Order No.	Name	
Main Frame		
G0373A	USB3.1 Receiver Test Adapter	

• **G0374A***4

Model/Order No.	Name	
Main Frame		
G0374A	64Gbaud PAM4 DAC	
Standard Accessories		
J1611A	Coaxial Cable (1.3 m, K connector):	1 pc
J1612A	Electrical Length Specified Coaxial Cable (0.8 m, K Connector):	4 pc
V210	Coaxial Terminator:	1 pc
J0017F	POWER CORD, 2.6M:	1 pc
G0342A	ESD DISCHARGER:	1 pc

• **G0375A***4

Model/Order No.	Name	
Main Frame		
G0375A	32 Gbaud Power PAM4 Converter	
Standard Accessories		
J1741A	Electrical Length Specified Coaxial Cable (0.8 m, K Connector):	4 pc
J1475A	USB Cable:	1 pc

• **G0376A***4

Model/Order No.	Name	
Main Frame		
G0376A	32 Gbaud PAM4 Decoder with CTLE	
Standard Accessories		
J1728A	Electrical Length Specified Coaxial Cable (0.4 m, K connector):	2 pc
J1475A	USB Cable:	1 pc

• **Software**

Model/Order No.	Name
MX180014A*5	100G EPON Application Software
MX181500A	Jitter/Noise Tolerance Test Software
MX183000A*5, *6	High-Speed Serial Data Test Software
MX183000A-PL001*5	Jitter Tolerance Test
MX183000A-PL011*5	PCIe Link Sequence
MX183000A-PL012*5	USB Link Sequence

*5: Supports Windows 7 OS Only

*6: MP1800A is shipped with MX183000A installed

• **Before Using VISA***7

For Those Who Use MP1800A

To use the MX183000A High-Speed Serial Data Test Software (hereafter MX183000A), you are required to install National Instruments™ (hereafter NI™) NI-VISA™*8 on the PC controller. We recommend using NI-VISA™ provided in the USB memory stick that contains MX183000A. You are allowed to use NI-VISA™ contained in the USB memory stick only for the purpose of using it for MX183000A. Use of NI-VISA™ for any other product or purpose is prohibited. When uninstalling MX183000A from the PC controller, uninstall NI-VISA™ that was installed from the USB memory stick as well.

*7: Virtual Instrument Software Architecture I/O software specification for remote control of measuring instruments using interfaces such as GPIB, Ethernet, USB, etc.

*8: World de facto standard I/O software interface developed by NI and standardized by the VXI Plug&Play Alliance.

National Instruments™, NI™, NI-VISA™ and National Instruments Corporation are all trademarks of National Instruments Corporation.

• **Optional Accessories**

Model/Order No.	Name	Remarks
J1621A	Passive Equalizer 3 dB	
J1622A	Passive Equalizer 6 dB	
J1627A	GND Connection Cable	
G0342A	ESD DISCHARGER	
J1449A	Measurement Kit	J1439A: 2 pcs, J1342A: 2 pcs, J1625A: 1 pc
J1625A	Coaxial Cable 1 m (SMA connector)	DC to 18 GHz
J1342A	Coaxial Cable 0.8 m	APC3.5, DC to 27.5 GHz
J1439A	Coaxial Cable (0.8 m, K connector)	K, DC to 40 GHz
J1620A	Coaxial Cable (0.9 m, K connector)	
J1550A	Coaxial Skew Match Pair Cable (0.8 m, APC3.5)	APC3.5, DC to 27.5 GHz, Skew <3 ps, pair cable
J1551A	Coaxial Skew Match Pair Cable (0.8 m, K Connector)	K, DC to 40 GHz, Skew <3 ps, pair cable
J1611A	Coaxial Cable (1.3 m, K connector)	K, DC to 40 GHz
J1615A	Coaxial Cable Set (PPG-Emphasis)	For jitter tolerance measurement, 2 pcs
J1618A	Coaxial Cable Set (Jitter-2chPPG-2chEmphasis)	For jitter tolerance measurement, 6 pcs
J1678A	ESD Protection Adapter-K	
Z0306A	Wrist Strap	
J1137	Coaxial Terminator	
J1359A	Coaxial Adaptor (K-P, K-J, SMA)	
W3594AE	MU183020A/MU183021A Operation Manual	Printed version
W3595AE	MU183040A/MU183041A/ MU183040B/MU183041B Operation Manual	Printed version
M-W3864AE	MX180014A Operation Manual	Printed version
W3813AE	MX183000A Operation Manual	Printed version
41KC-3	Precision Fixed Attenuator 3 dB	
41KC-6	Precision Fixed Attenuator 6 dB	
41KC-10	Precision Fixed Attenuator 10 dB	
41KC-20	Precision Fixed Attenuator 20 dB	
K240C	Precision Power Divider	
K241C	Precision Power Splitter	
G0361A*4	64Gbaud 2-bit DAC with MUX	
J1398A	N-SMA ADAPTOR	
J1508A	BNC-SMA Connector Cable (30 cm)	
J1510A	Pick OFF Tee	
J1627A	GND Connection Cable	
J1624A	Coaxial Cable 0.3 m (SMA Connector)	
J1625A	Coaxial Cable 1 m (SMA Connector)	
J1632A	Terminator (SMA)	
J1715A	Coaxial Skew Match Cable (0.1M, SMP-J,SMA-J)	
K220B	Coaxial Adapter	
K261	DC Block	
K250	Bias T	
Z1927A	USB Measurement Kit	
J1721A	USB Measurement Component Set	
J1722A	PCIe Measurement Component Set	
J1723A	TBT Measurement Component Set	
J1724A	Compliance Test Component Set	
J1735A	Combiner	
J1728A	Electrical Length Specified Coaxial Cable (0.4 m, K connector)	
J1741A	Electrical Length Specified Coaxial Cable (0.8 m, K Connector)	
J1742A	Electrical Length Specified Coaxial Cable (0.84 m, K Connector)	

* MU181020B is not RoHS compliant.

* MU181040B is not RoHS compliant.

*4: The warranty period shall be 1 year under normal use.

Repair by exchange for new during the warranty period shall be limited to one instance.

Repair using new spare parts shall be charged after the warranty period has expired.

Moreover, Anritsu Corporation will deem this warranty void when:

- When new spare parts can no longer be easily obtained when more than 5 years have elapsed after manufacture.

● **United States**

Anritsu Americas Sales Company

450 Century Parkway, Suite 190, Allen,
TX 75013 U.S.A.

Phone: +1-800-Anritsu (1-800-267-4878)

● **Canada**

Anritsu Electronics Ltd.

700 Silver Seven Road, Suite 120, Kanata,
Ontario K2V 1C3, Canada

Phone: +1-613-591-2003

Fax: +1-613-591-1006

● **Brazil**

Anritsu Eletronica Ltda.

Praça Amadeu Amaral, 27 - 1 Andar
01327-010 - Bela Vista - Sao Paulo - SP
Brazil

Phone: +55-11-3283-2511

Fax: +55-11-3288-6940

● **Mexico**

Anritsu Company, S.A. de C.V.

Bldv Miguel de Cervantes Saavedra #169 Piso 1, Col. Granada
Mexico, Ciudad de Mexico, 11520, MEXICO

Phone: +52-55-4169-7104

● **United Kingdom**

Anritsu EMEA Ltd.

200 Capability Green, Luton, Bedfordshire, LU1 3LU, U.K.

Phone: +44-1582-433200

Fax: +44-1582-731303

● **France**

Anritsu S.A.

12 avenue du Québec, Bâtiment Iris 1- Silic 612,
91140 VILLEBON SUR YVETTE, France

Phone: +33-1-60-92-15-50

Fax: +33-1-64-46-10-65

● **Germany**

Anritsu GmbH

Nemetschek Haus, Konrad-Zuse-Platz 1
81829 München, Germany

Phone: +49-89-442308-0

Fax: +49-89-442308-55

● **Italy**

Anritsu S.r.l.

Via Elio Vittorini 129, 00144 Roma, Italy

Phone: +39-6-509-9711

Fax: +39-6-502-2425

● **Sweden**

Anritsu AB

Isaffjordsgatan 32C, 164 40 KISTA, Sweden

Phone: +46-8-534-707-00

● **Finland**

Anritsu AB

Teknobulevardi 3-5, FI-01530 VANTAA, Finland

Phone: +358-20-741-8100

Fax: +358-20-741-8111

● **Denmark**

Anritsu A/S

Torveporten 2, 2500 Valby, Denmark

Phone: +45-7211-2200

Fax: +45-7211-2210

● **Russia**

Anritsu EMEA Ltd.

Representation Office in Russia

Tverskaya str. 16/2, bld. 1, 7th floor.

Moscow, 125009, Russia

Phone: +7-495-363-1694

Fax: +7-495-935-8962

● **Spain**

Anritsu EMEA Ltd.

Representation Office in Spain

Edificio Cuzco IV, Po. de la Castellana, 141, Pta. 5

28046, Madrid, Spain

Phone: +34-915-726-761

Fax: +34-915-726-621

● **United Arab Emirates**

Anritsu EMEA Ltd.

Dubai Liaison Office

902, Aurora Tower,
P O Box: 500311- Dubai Internet City

Dubai, United Arab Emirates

Phone: +971-4-3758479

Fax: +971-4-4249036

● **India**

Anritsu India Private Limited

6th Floor, Indiqube ETA, No.38/4, Adjacent to EMC2,

Doddanekundi, Outer Ring Road, Bengaluru – 560048, India

Phone: +91-80-6728-1300

Fax: +91-80-6728-1301

● **Singapore**

Anritsu Pte. Ltd.

11 Chang Charn Road, #04-01, Shriro House
Singapore 159640

Phone: +65-6282-2400

Fax: +65-6282-2533

● **P.R. China (Shanghai)**

Anritsu (China) Co., Ltd.

Room 2701-2705, Tower A,

New Caohejing International Business Center

No. 391 Gui Ping Road Shanghai, 200233, P.R. China

Phone: +86-21-6237-0898

Fax: +86-21-6237-0899

● **P.R. China (Hong Kong)**

Anritsu Company Ltd.

Unit 1006-7, 10/F., Greenfield Tower, Concordia Plaza,

No. 1 Science Museum Road, Tsim Sha Tsui East,

Kowloon, Hong Kong, P.R. China

Phone: +852-2301-4980

Fax: +852-2301-3545

● **Japan**

Anritsu Corporation

8-5, Tamura-cho, Atsugi-shi, Kanagawa, 243-0016 Japan

Phone: +81-46-296-6509

Fax: +81-46-225-8352

● **Korea**

Anritsu Corporation, Ltd.

5FL, 235 Pangyoyeok-ro, Bundang-gu, Seongnam-si,

Gyeonggi-do, 13494 Korea

Phone: +82-31-696-7750

Fax: +82-31-696-7751

● **Australia**

Anritsu Pty. Ltd.

Unit 20, 21-35 Ricketts Road,

Mount Waverley, Victoria 3149, Australia

Phone: +61-3-9558-8177

Fax: +61-3-9558-8255

● **Taiwan**

Anritsu Company Inc.

7F, No. 316, Sec. 1, NeiHu Rd., Taipei 114, Taiwan

Phone: +886-2-8751-1816

Fax: +886-2-8751-1817

Please Contact: