

Pharmaceutical Metal Detector

for tablets and capsules

M6

Anritsu Pharmaceutical Metal Detector with Three Leading-Edge Technologies Offers Advanced Quality Control.



Pharmaceutical Metal Detector
for tablets and capsules

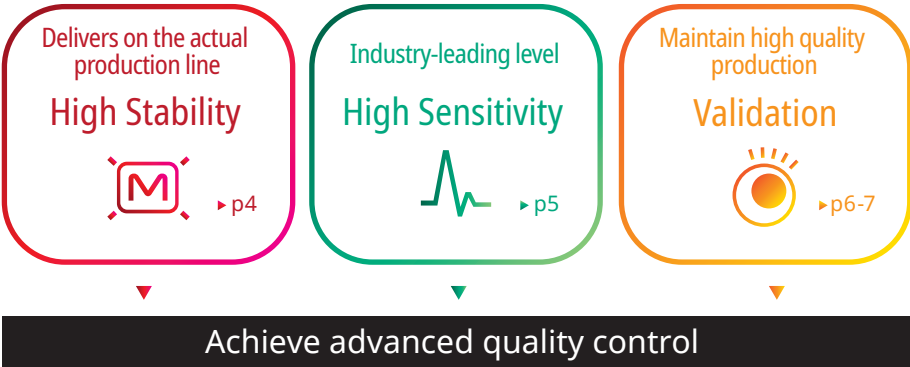



High Stability Supports Efficient Detection of Contaminants

The major causes of lower stability in metal detection are vibration, static electricity, and electrical noise from peripheral devices that destabilize the magnetic fields in detection heads. Anritsu Pharmaceutical Metal Detector enhances resistance to these negative factors, achieving stable and accurate detection of contaminants.

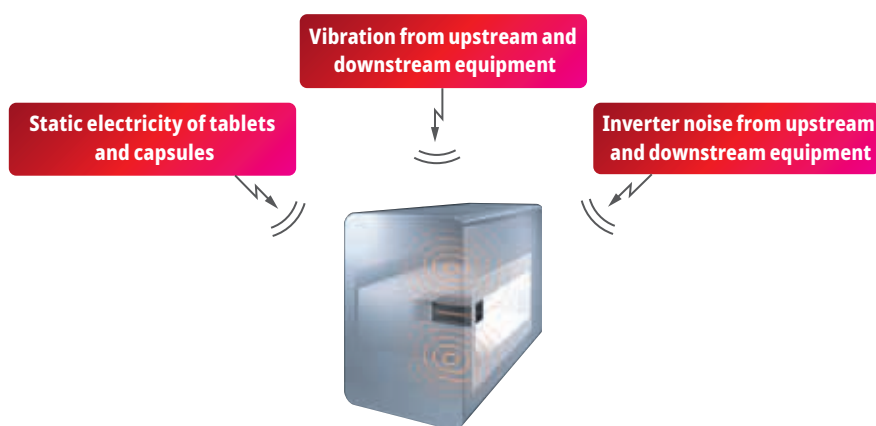

M Vibration Resistant

Vibration from upstream and downstream equipment such as tablet machine, capsule filling machine, and powder removing machine can cause false rejection. Digital signal processing is equipped to minimize vibration noise, enhancing stability against vibration.

M Measures for Static Electricity

Static electricity of tablets and capsules can cause false rejection. Anti-static chute (optional) reduces amplification of static electricity, minimizing incorrect operation.

M Resistance to Noise from Peripheral Devices

Inverter noise from upstream and downstream equipment can lower stability of metal detector. Enhanced signal processing increases resistance to inverter noise from upstream/downstream devices, providing stable detection sensitivity on your production line. Our metal detector is equipped with a unique function capable of avoiding noise by an operator.



Industry Leading Level* High Sensitivity Inspection

Detection head and signal processing specialized for the inspection of pharmaceutical products significantly reduce product effect, providing high sensitivity detection. For most tablets and capsules, no setting using sample products before the inspection is required. No complicated adjustments are required for achieving high detection sensitivity. Even those tablets and capsules containing hard-to-inspect ingredients such as iron content can be adjusted to optimum sensitivity by feeding a product only once.

*According to an in-house research

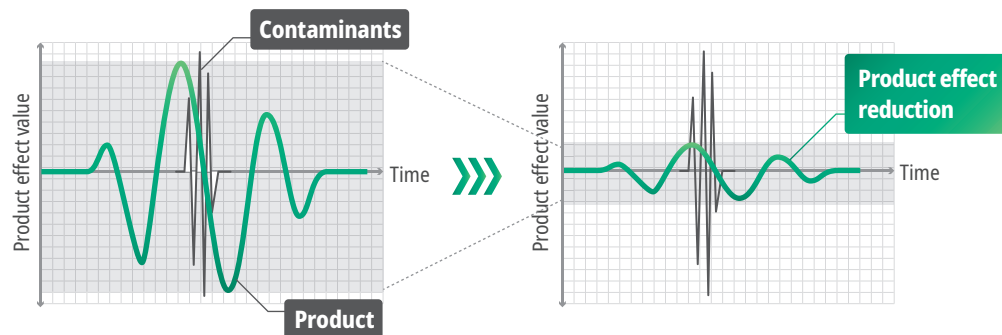

Instantly analyze magnetic and non-magnetic materials in metal contaminants.



Anritsu Pharmaceutical Metal Detector can look at whether the contaminant is magnetic material or non-magnetic material without breaking tablets and capsules. In a conventional method, a special inspection device is used to conduct the breaking test and identification of contaminants. However, it takes time to obtain the result with this method. This function helps the operator to check the property of contaminants before conducting the breaking test.

*Since it is not a stringent function performed by a calibration, analytical accuracy cannot be guaranteed.



Validation Provides Advanced Quality Control

M Built-In Monitoring Function Verifies Correct Operation of Metal Detector.

Continuous monitoring for internal machine

The built-in automatic monitoring function constantly monitors the internal machine during the production and gives an error notice instantly to alert the operator of a problem when it occurs.

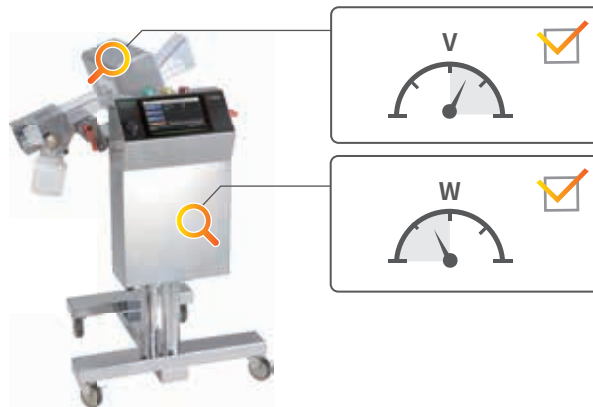

Self-diagnosis of detection performance (patented)

This diagnostic function allows the operator to check if the machine maintains the same performance level as was initially installed in the facility.

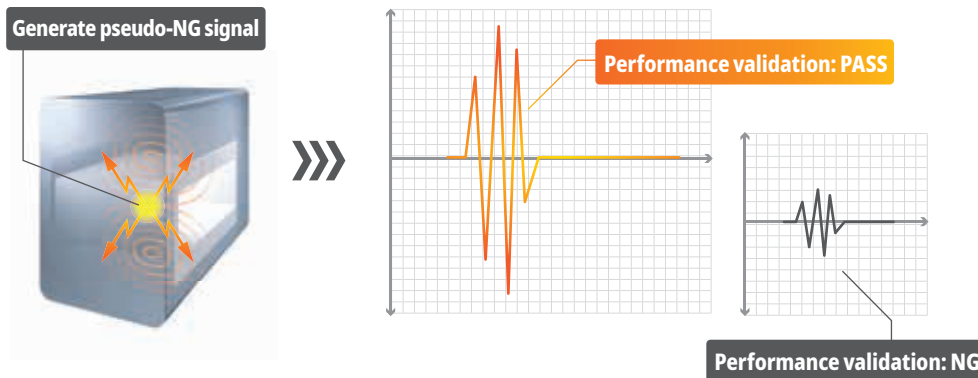

Duplex monitoring system for rejection gate operation

A rejection unit is equipped with a position sensor on both PASS and NG sides to perform position check at the time of starting the machine and detecting contaminants. The failsafe design enables the rejection unit to hold at the NG direction at the time of non electric conduction and occurrence of abnormality, preventing false rejection of faulty products as well as any product that does not satisfy the evaluation criteria to the PASS direction.

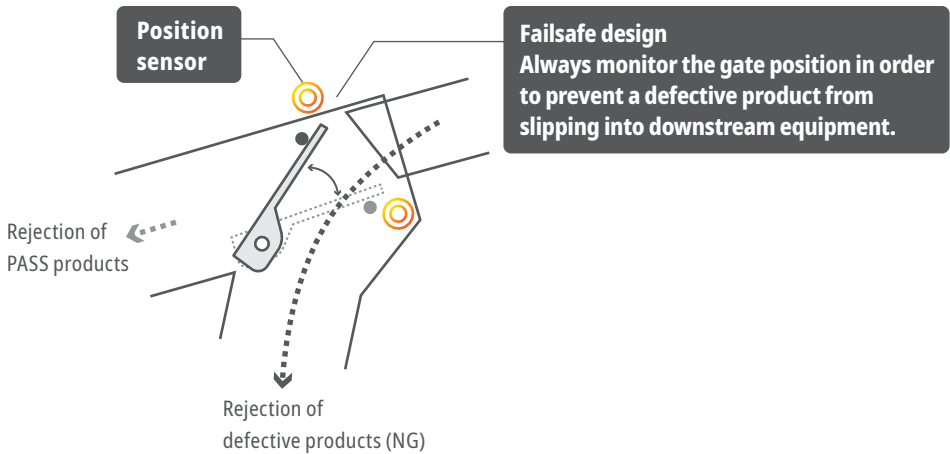

M Support Functions for Validation Process Such as IQ/OQ

Support functions allow the operator to verify the operation check for rejection gates, and the proper setting of sensors on a screen for IQ and OQ process. With these functions, the operator can output required information for creating a document of verification results.

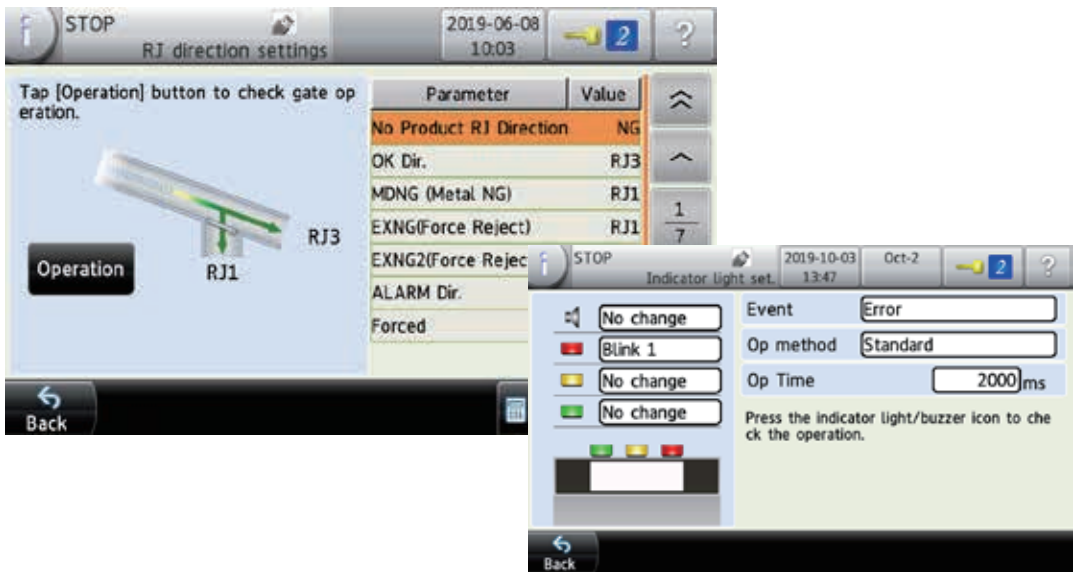



Supporting FDA 21 CFR Part 11

It is vital for pharmaceutical metal detectors to manage and record production and inspection data, not to speak of performing high precision inspection. Anritsu Pharmaceutical Metal Detector complies with FDA 21 CFR Part 11, including eligibility user authentication, audit trails, and data encryption/decryption.

Eligibility authentication (User management)

Authentication with user code and password is required for operating the metal detector. Access level can be individually set for each user to prevent unauthorized operations.



Audit trail

The history of operations and actions related to production and results of operation check are internally recorded. The data can be used to monitor fraudulent activity or incorrect operation and analyze the cause of such activity.



Data encryption and decryption

Various data can be easily transmitted, including audit trail statistics and parameters.

SOP (Standard Operating Procedure)

Smart Guide allows the operator to follow the correct operation procedure, supporting proper execution of SOP.



Tool Free Part Removal

Easy clean design

Parts that are in direct contact with pharmaceutical products such as feeding chute, rejection box, and NG bottle can be easily removed and attached without tools.

Simple adjustment

Chute angle and swing angle can be adjusted effortlessly without tools.



External Dimensions

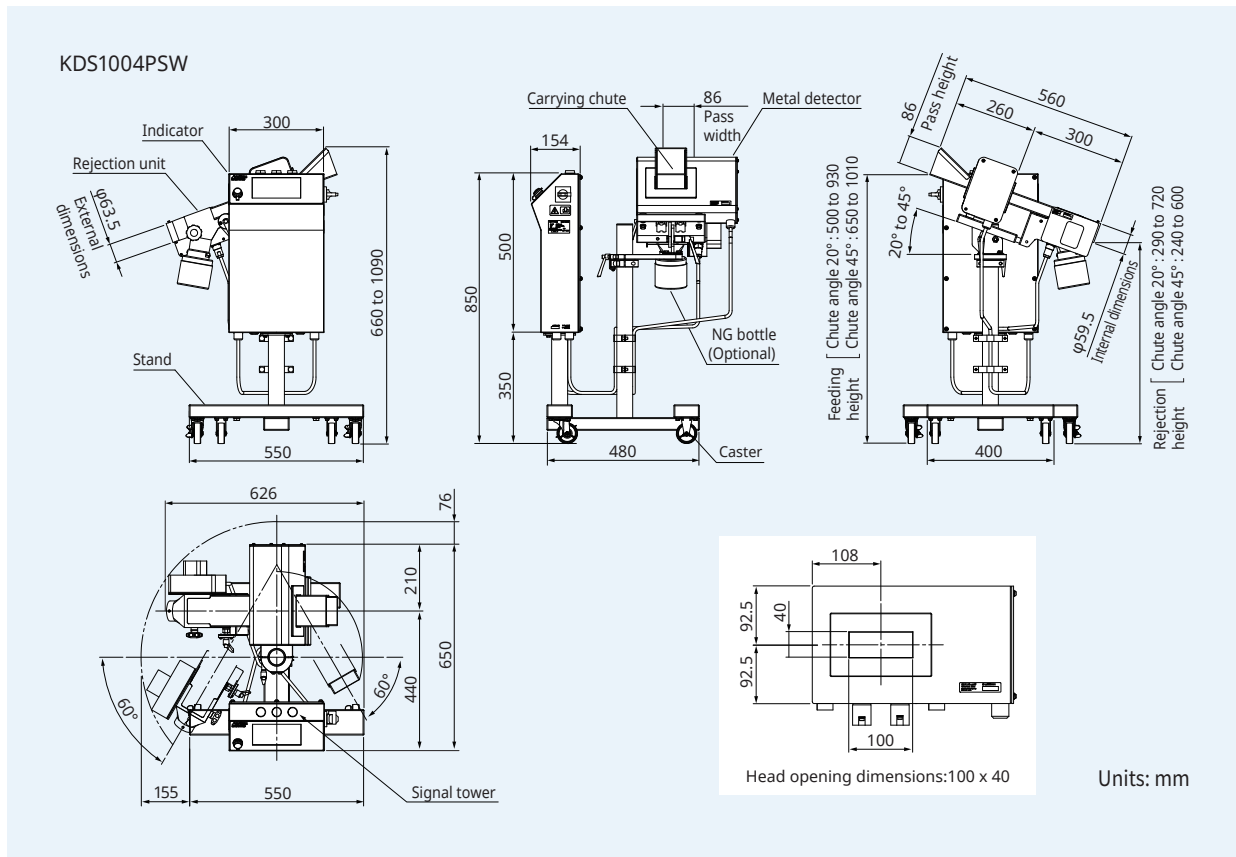

Specifications



Model	KDS1004PSW	
Opening inner diameter	100 mm × 40 mm	
Chute inner diameter	86 mm × 32 mm	
Detection sensitivity ¹	Fe	$\phi 0.25$ mm
	Non-Fe	$\phi 0.30$ mm
	SUS316	$\phi 0.40$ mm
Display	7-inch color TFT LCD	
Operation method	Touch panel	
Preset memory	Maximum 200	
Product	Tablets, soft capsules: thickness of 3 mm or more Hard capsules: capsule No. 000 to 5	
Maximum processing capacity ²	1,800,000 capsules/hour (30,000 capsules/min)	
Metal detection	Rejection	
Power supply	100 to 240 Vac +10% -15%, single phase, 50/60 Hz	
Power consumption	120 VA, rush current 50A (typ.) (20 ms or less)	
Mass	60 kg	
Environmental conditions	0°C to 40°C (variation within $\pm 5^\circ\text{C}$ in the range of 0°C to 40°C), relative humidity 30% to 85%, non-condensing	
Protection class	IP65	
Exterior	Indicator, stand, detection head, and rejection unit: stainless steel (SUS304) Contact part: SUS316L (buff#400 and electro-polishing), FDA-enabled resin	
Data output	USB port as standard equipment Ethernet interface (100BASE-TX as optional)	

1: Maximum detection sensitivity within detection area. Detection sensitivity for actual use may vary depending on the type of contaminants, the physical property of product (temperature of goods, content, and shape) and the environmental conditions.

2: Depends on the product size.

Note: The noise level of the metal detector does not exceed 70 dB (A).

Pharmaceutical Quality Assurance based on GMP

We offer a wide range of inspection solutions including weight check, contaminant and shape detection for the pharmaceutical manufacturing and packaging process.

Filling control/Weight check

Seal check/Missing tablet check



Tablets



Capsules



Sachets / Sticks



Tubes



Bottles / Cans

Pharmaceutical Metal Detector



Capsule Checkweigher



Built-In Multi-Lane Weighing System



Multi-Lane Checkweigher



Aerosol Inhaler Checkweigher



Small Bottle Checkweigher



*Non-conforming to CE marking



Pharmaceutical X-ray Inspection System



*Non-conforming to CE marking

*Non-conforming to CE marking

Supporting CSV guidelines :
Validation support

Anritsu also provides IQ/OQ checklists and on-site support during PQ process.

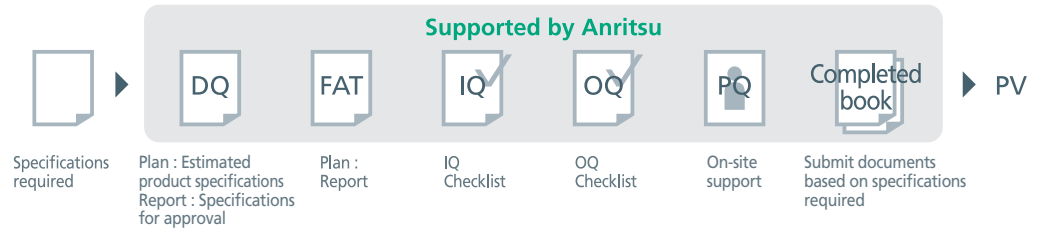

Missing blister pack check



SSV-h Series Checkweigher conforming to CFR 21 Part 11



*MID approval

Missing insert check (magnetic ink)



M Series Metal Detector



*Non-conforming to CE marking

Missing pack check



SSV-h Series Checkweigher



*MID approval

Missing carton check



Case Checkweigher



*Non-conforming to CE marking

Quicca Pharma

Overall Quality Management and Control System for Pharmaceutical

Support making good use of data by various CFR 21 Part 11 complied functions.

Delivering Data Integrity as specified by CFR 21 Part 11 by utilizing the data from the machine connected to the network.

- **Eligibility Authentication (User Management)**
All user access is managed centrally.
- **Audit Trail**
The history of operations and actions related to production and results of operation check are recorded and displayed in list-view style for easy and quick view.
- **Production Analysis**
Production progress monitor and Overall Equipment Effectiveness (OEE) can be viewed in real time.
- **Data for Quality**
Statistic data and individual data are recorded via Ethernet.

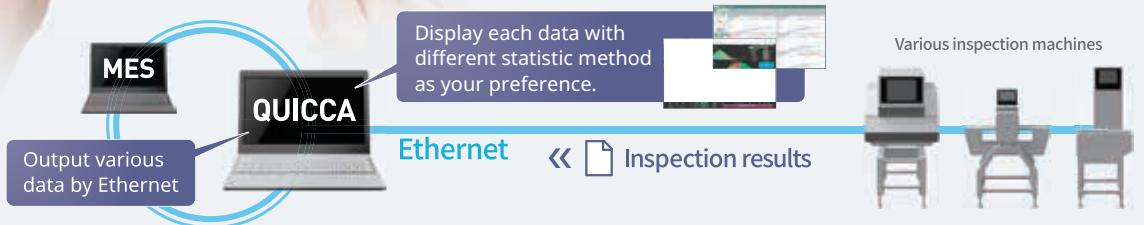



ANRITSU INFIVIS CO., LTD.

International Sales Department

5-1-1 Onna, Atsugi-shi, Kanagawa-Prf., 243-0032, JAPAN
TEL: +81-46-296-6699 FAX: +81-46-296-6786
<https://www.anritsu.com/infivis>

Anritsu Industrial Solutions (Shanghai) Co., Ltd.

3F, No.55, Lane 1505, Zuchongzhi Road, Zhangjiang Hi-tech Park, Pudong New Area, Shanghai 201203, P.R.China
TEL: +86-21-5046-3066 FAX: +86-21-5046-3068

ANRITSU INFIVIS (THAILAND) CO., LTD.

700/678-679 Moo1, Amata City Chonburi Industrial Estate, Tambol Panthong, Amphur Panthong, Chonburi 20160 Thailand
TEL: +66 38-447180 FAX: +66 38-447182

ANRITSU INFIVIS LTD.

Unit 3, Scott Road, Luton, LU3 3BF, United Kingdom
TEL: +44 (0)845 539 9729

ANRITSU INFIVIS INC.

1001 Cambridge Drive, Elk Grove Village, IL 60007-2453, U.S.A.
TEL: +1-847-419-9729 FAX: +1-847-537-8266

© ANRITSU INFIVIS CO., LTD. 2019

ISO14001 CERTIFICATE No.JQA-EM0210
ISO 9001 CERTIFICATE No.JQA-0316

- Some products shown in this catalog may not be available in your country or region. Contact our sales representatives for details.
- To ensure proper operation, read the Operation Manual before using the machine.
- In addition to daily inspection, a full maintenance inspection should be completed annually.

Specifications are subject to change without notice.
No part of this catalog may be reproduced without our permission.