



Real Time Line Monitoring,  
Complete Product Traceability and HACCP Compliance —

Discover What's Possible in terms of Quality Control

Overall quality management and control system

**QUICCA**

**KX9002 SERIES**

 Barcode tracking  Video monitoring



# Overall quality management and control system

## QUICCA KX9002 series



Real-time production, system and event monitoring for complete line optimization.

### Record production data automatically

Data recorded includes operational history, in chronological order, of all inspection systems in one centralized location. Eliminate the inaccuracies and effort of manual data sampling.

Automatic recording

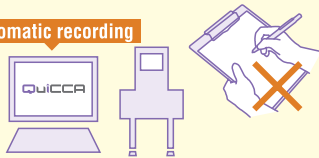

### Monitor production lines in real-time

Current production line status is easily viewable ensuring line efficiencies are met. Remote line changes enable the user to quickly adjust basic settings without physically having to go to the lines. Error messages can be sent to the user's mobile phone for instant notification.



### Analyze production performance

Generate and view production status reports. Production trending and variances are available for analysis.

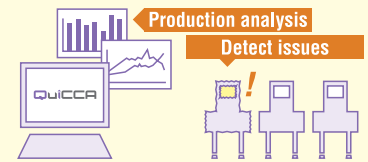

## Line Monitoring

Real-time production line monitoring and analysis



- Check production status
- Control systems remotely
- Display inspection history
- View production statistics
- Output production status reports
- Record and view video feeds (optional)

● Example

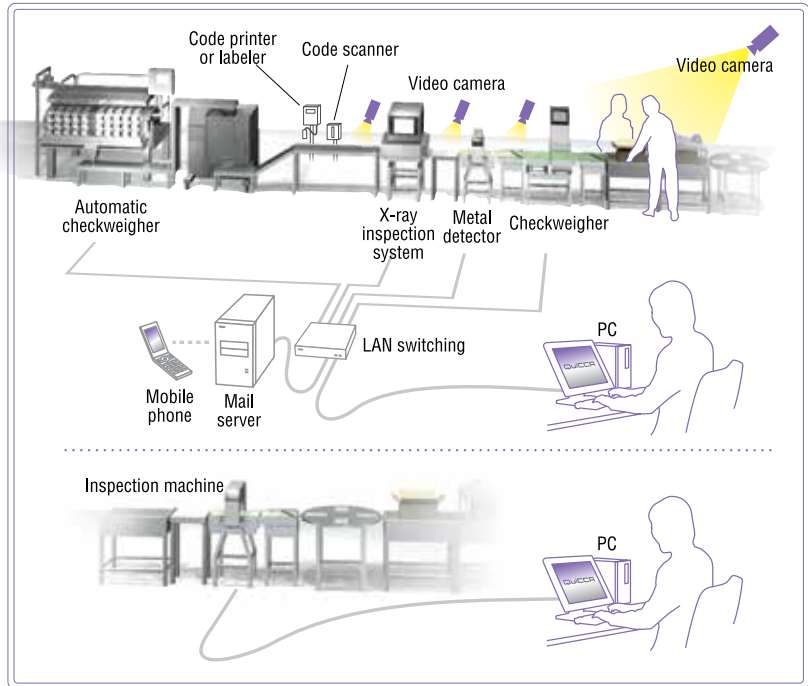

**Product identification & Video recording**

Each individual pack can be tracked by its unique bar or 2D code. Video recording, optional, can also be associated to each unique package providing a complete inspection record of each product.

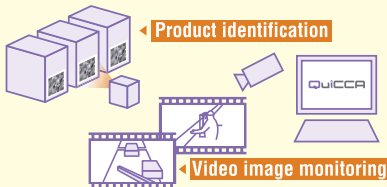

# Traceability

# HACCP Compliance

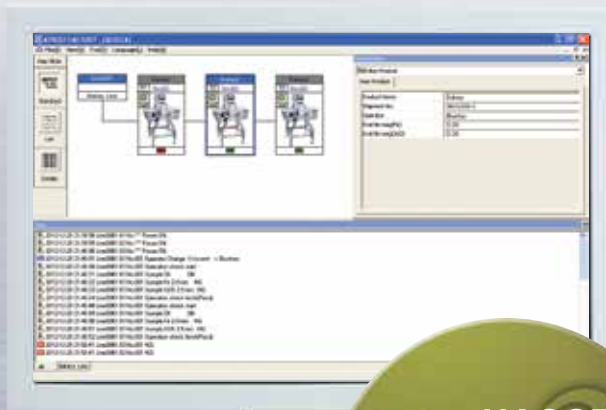

- Lot number and time/date traceability
- Quickly search inspection data by scanning the product's bar or 2D codes
- View the complete product " history" including its inspection by ALL Anritsu X-ray, Checkweighing, Metal detection and video recording systems on the line
- Greatly streamline product traceability!

- Create CCP monitoring reports
- Provide product inspection certification
- Minimize the potential for human error
- Record operator ID to each event
- Quickly search inspection data via production date, shipment number or lot number





# Real-Time Production Line Monitoring and Analysis

An overview of the production line allows you to detect areas of improvement.

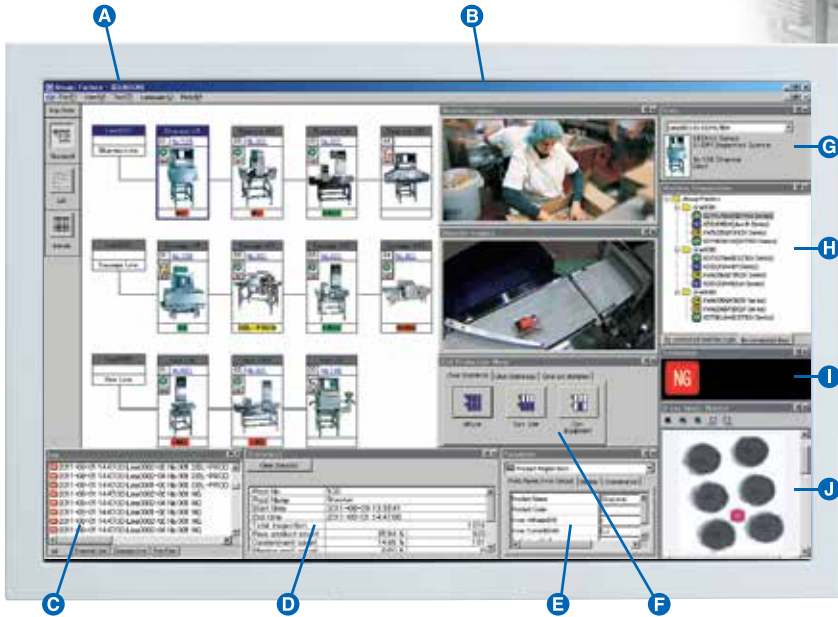
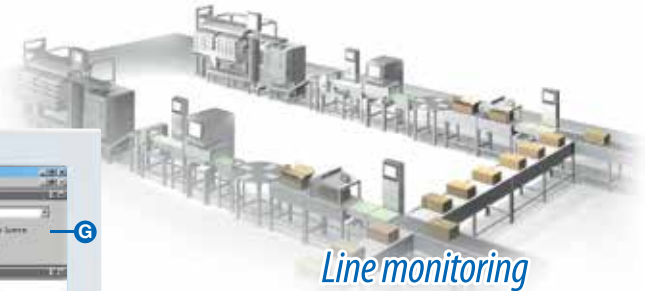

- Check production status
- Record and view video feeds (optional)
- Display inspection history
- View production statistics
- Output production status reports
- Control systems remotely

Delivered by KX9002A, KX9002D and KX9002T

## Monitoring and control — Centralized control facilitates efficient line management

- A** Main window: View the current status of each inspection equipment including evaluation results and operation errors
- B** Video image: View live video feeds (optional)
- C** History: Display the inspection history including inspection, error and alarm results
- D** Statistics: View the total number of products inspected, number and percentage of OK/NG products, average product weight (X-bar) and standard deviation
- E** Parameter: Show the current settings of each inspection equipment
- F** End production menu: Reset the statistics for all or the selected equipment
- G** Data: Display basic information such as lines and models
- H** Line composition: Display equipment of each line as a tree view
- I** Evaluation: Show evaluation results
- J** X-ray image monitor: Display an X-ray image in real time

### Remote monitoring via mobile phone:

Inspection equipment status, current statistics and error messages are automatically sent to your mobile phone. Remote real time adjustment of inspection settings is possible.

```

inbox:                               To: 1
Date: 2008/08/29 09:54:44
From: X074178W X-Ray Inspection System
Sub: 0001-04 Error generated
Error generated
Error generated
Line: 0001-04
Prod. No.: 001
Prod. Name: Snack
2008-08-29 09:54:44
[None]
0052 Emergency stop
[Description]
Emergency switch pressed. Pull and
turn clockwise to release. If error
frequent call SE.
[Solution]
Problem:
Emergency stop switch pressed or
Example of text message
    
```

Statistics display

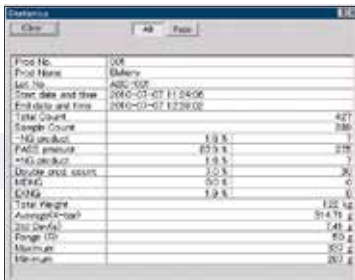

X-bar (average weight) graph display

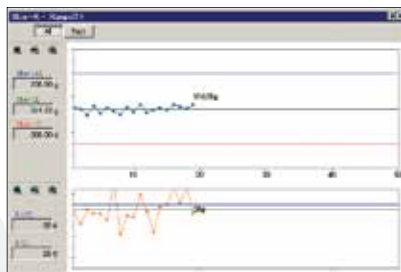

Histogram display

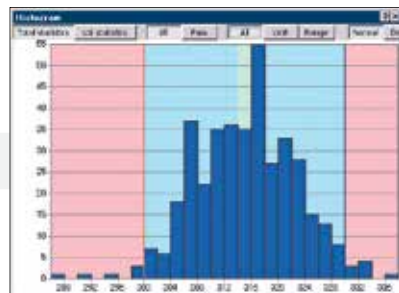

**Production analysis — Optimize line productivity**

Average weight (X-bar) and standard deviation are shown both numerically and graphically, allowing quick detection and correction of anomalies within the production process. A histogram is also viewable for providing production trending information.

©Advanced analysis:  
Statistical data and graphs can be compiled into a comprehensive report. The printable report can be provided to retailers for daily operation analysis.

Report examples

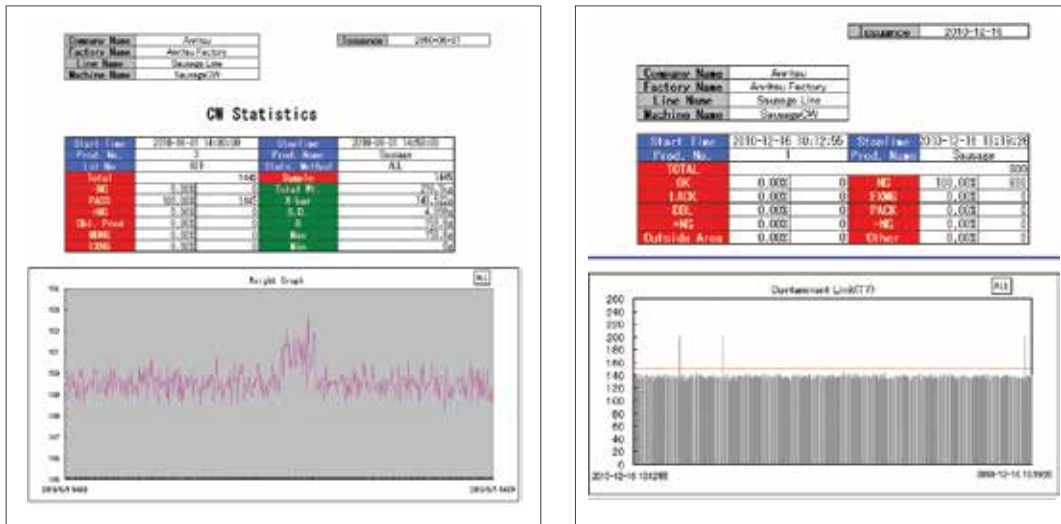

**Monitor and record production line events — quickly troubleshoot line issues**

Advanced production control

(Optional)



Video camera (line monitoring)



● Identify the cause of the events

Video cameras installed at critical locations within the production line, such as upstream and downstream of the inspection system, continuously record the production line. When a line event occurs, as example an unusually high number of rejected (NG) products, the video feeds are recorded and can be examined to determine if there were any abnormalities in the production line. By eliminating the cause of the event, unnecessary rejection will be avoided and productivity will be increased.



# Complete Product Traceability

Ensure fast and reliable response to product quality complaints



## Traceability

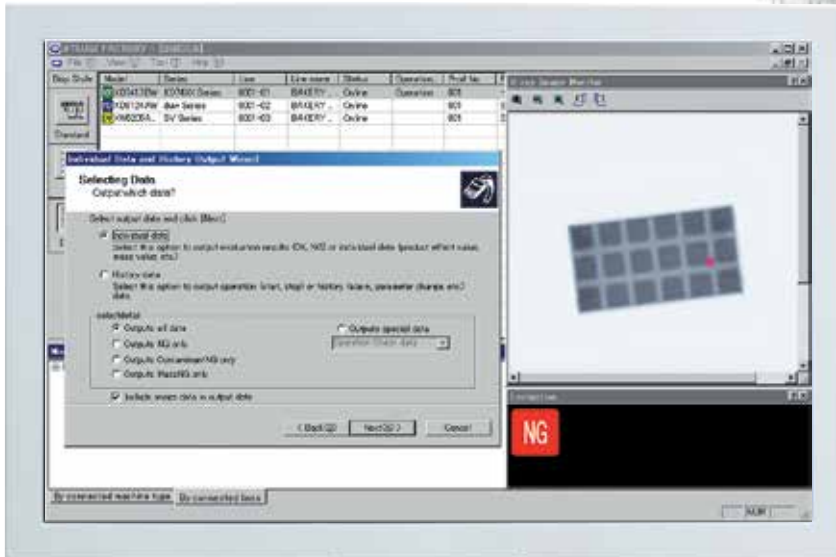

- Lot number and time/date traceability
- Quickly search inspection data by scanning the product's bar or 2D codes (KX9002T only)
- View the complete product "history" including its inspection by ALL Anritsu X-ray, Checkweighing, Metal detection and video recording system on the line
- Greatly streamline product traceability!



Delivered by KX9002A, KX9002D and KX9002T

### Quick and efficient data access

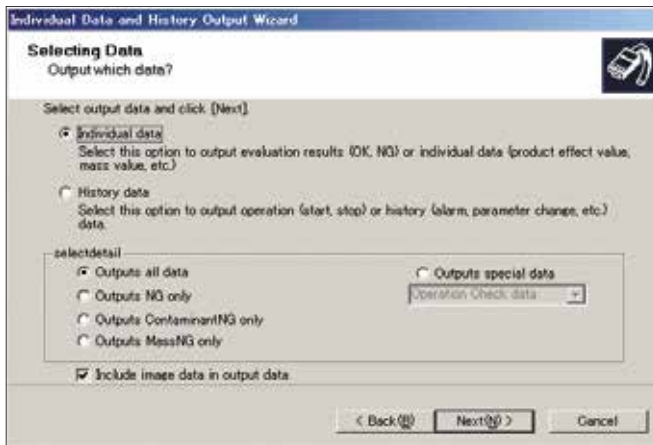
The inspection data and operational history of all inspection systems are automatically recorded, in chronological order, in one centralized location. When receiving complaints from consumers or retailers, the desired inspection data can be extracted via the data output wizard to confirm there were no process problems.

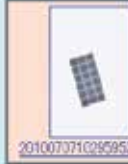

Data output wizard extracts inspection records  
 Individual data: Extract product-related data such as OK / NG result  
 History data: Extract data from operational status history such as start/stop and alarm

XR Evaluation Result				
Number of Data = 93				
	Date	2010-07-07	Time	10:29:58 325
	Prod. No.	001	Evaluation	OK
	Stats. Total			
	Date	2010-07-07	Time	10:30:00 541
	Prod. No.	001	Evaluation	Contam.NG
	Stats. Total			
	Date	2010-07-07	Time	10:30:01 463
	Prod. No.	001	Evaluation	OK
	Stats. Total			

Example of the data output — Inspection data can be referenced promptly

### Establishing traceability by tracking individual products with 2D and bar codes

### Advanced traceability via barcode referencing

KX9002T

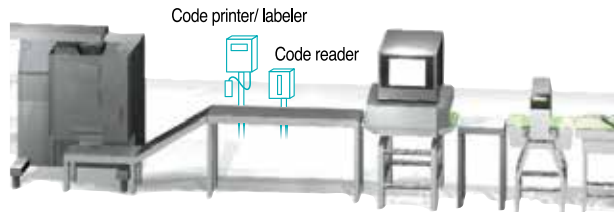
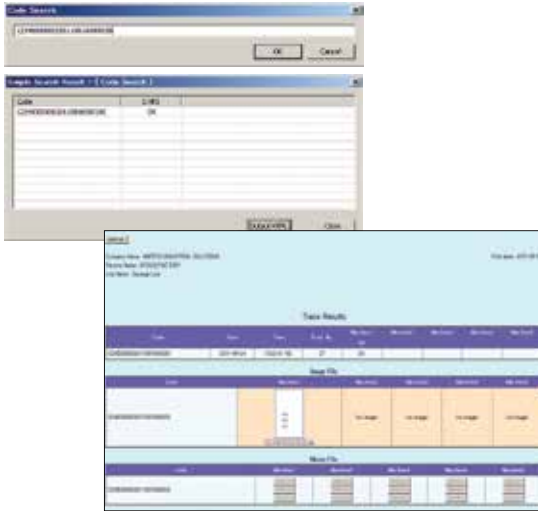

#### Complete inspection records available

Connected to a code reader via an X-ray inspection system, QUICCA associates product information and lot numbers with inspection data, providing a complete inspection record of each product.

Even a metal detector and/or checkweigher without a code reader can take advantage of the time logs for associating inspection data with each product if the system is located near an X-ray system.

#### Quickly view each product's inspection history

All inspection data can be referenced by the product's unique 2D/bar code. This allows the inspection history to be found accurately and reliably compared to referencing the date and time of production. As example, if a consumer complaints occurs — the 2D/bar code can be provided and entered to provide a complete inspection history of that product.

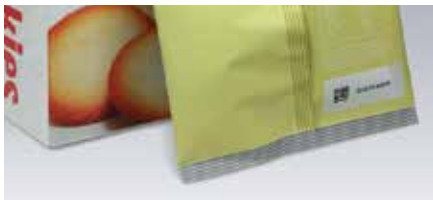

### Verifies rejection operation with video feeds (Optional)

### Advanced traceability via video recording

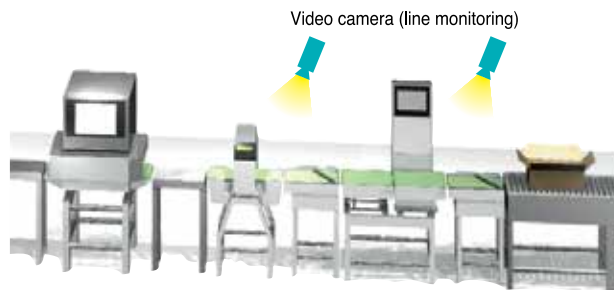
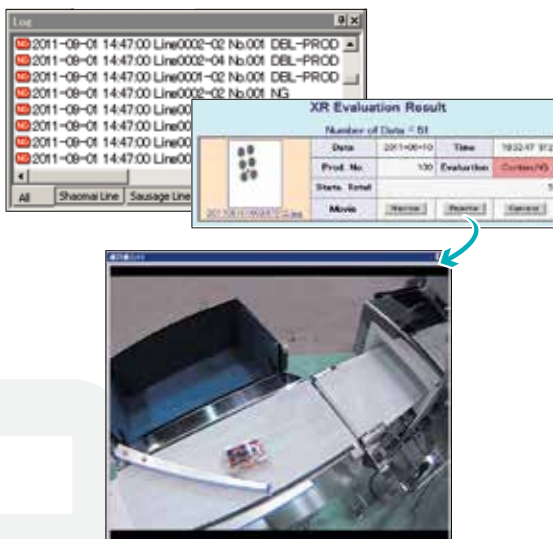

Recorded video can be used for verifying a defective product was properly rejected. Combined with the bar/2D code tracking features, this is a valuable tool in analyzing consumer complaints.





# HACCP Compliance

Simplify CCP monitoring and compliance reporting

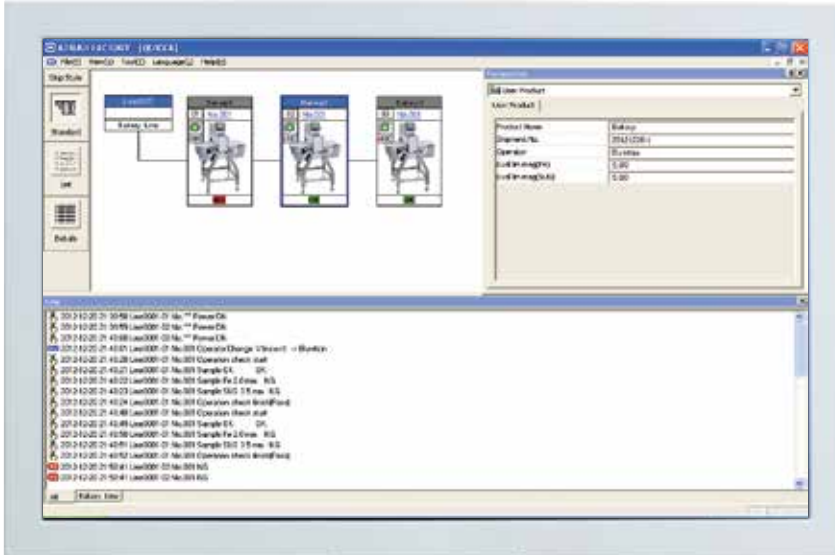

*HACCP ready!*

- Create CCP monitoring report
- Provide product inspection certification
- Minimize the potential for human error
- Record operator ID to each event
- Quickly search inspection data via production date, shipment number or lot number

Delivered by KX9002D and KX9002T

## Daily operation checks become more reliable

CCP compliance requires verifying the operation of the inspection equipment on a regular basis. QUICCA automatically records these operation checks and the associated product name, time/date and the operator ID who performed the check. If any step is omitted or performed incorrectly, QUICCA halts system operation thereby ensuring operation is only allowed if the checks are completed. The automatic data collection also eliminates possible recording omissions or recording errors (possible with manual data collection).

Data No.	Time	Product No.	Log
1	2010-04-04 15:02:57	000	Machine started
2	2010-04-04 15:02:57	000	Barcode reader connected
3	2010-04-04 15:03:57	000	Operator change XXXX->YYYY
4	2010-04-04 15:05:29	000	Operation Check started
5	2010-04-04 15:05:45	000	OK product OK
6	2010-04-04 15:05:46	000	NG product (Fe) Dia.2.0 OK
7	2010-04-04 15:05:47	000	Operation Check Fault
8	2010-04-04 15:05:47	000	Operation Check finished (Abnormal)
9	2010-04-04 15:06:40	000	Operation Check started
10	2010-04-04 15:06:56	000	OK product OK
11	2010-04-04 15:06:58	000	NG product (Fe) Dia.2.0 NG
12	2010-04-04 15:07:01	000	NG product (SUS) Dia.3.5 NG
13	2010-04-04 15:07:01	000	Operation Check finished (Normal)

Operation check records can be stored and/or printed.



Production data can be searched via Operator ID or their unique barcode ensure operator traceability.



Daily inspection report, including production records, can be stored and/or printed.

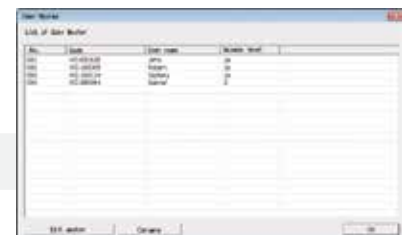

Example of setting display



Provide product inspection certification

Certificate of Inspection	
(To Company Name)	No.
(To Name)	2011-12-21 (Sign)
The following lot product, certify that the foreign substance does not contain.	
Lot No.:	
Product Name:	Bakery
Product Type:	111
Product Date:	2011-12-21 12:25:11 to 2011-12-21 12:25:05
Contamination:	No contamination
Test Place	
Before:	Fe: 2.0 mm 50.0% 3.5 mm
Last:	Fe: 2.0 mm 50.0% 3.5 mm
Information of detector	
K1004201F	
ANRITSU INDUSTRIAL SOLUTIONS	

The system provides certification, to HACCP requirements, that a product has been inspected with a fully compliant inspection system. You can show your clients that your manufacturing process uses and follows stringent quality control processes and can increase your company's credibility. The format can be customized however the inspection records cannot be modified.

\*Anritsu is not responsible for the inspection results by this documentation.

Video records operation check process  
(Optional)

High security

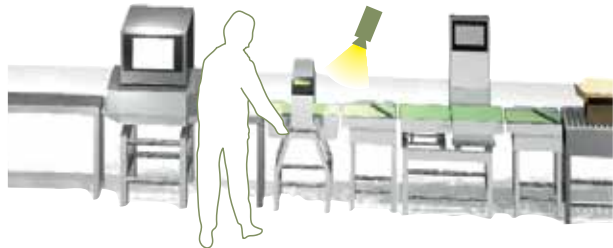
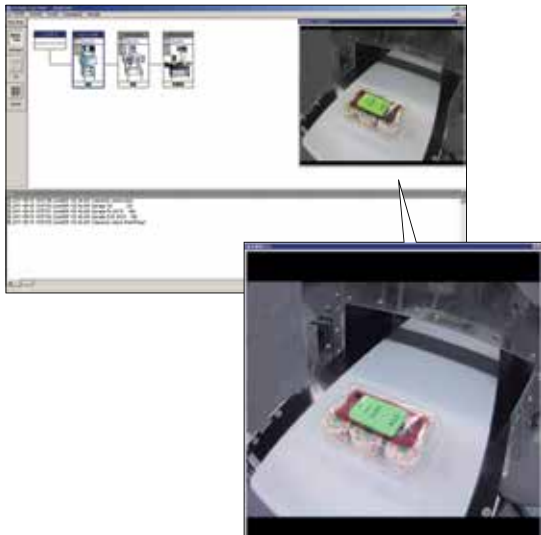

Example, through video recording the discharge of a metal detector, you can check the proper sample products and test cards were used and the check was performed properly. The function also aids in the prevention of operators skipping the required verification procedures.

Point HACCP and CCP

HACCP is a food management system that originated during the space program to ensure the safety of food transported into space. It features identifying and analyzing potential food safety hazards and continuously monitoring and recording critical points within the process. If problems occur, procedures are specified for immediate corrective action so that defective products are prevented from entering the market.

CCP (Critical Control Point) is a point, step or procedure at which control can be applied and is essential to prevent or eliminate a food safety hazard. In a HACCP plan, continuous monitoring and recording of operational steps determined as CCP are required. In some industries, CCP usage and requirements are specified, as example metal detection down to a certain millimeter size.



# Function chart

Model		KX9002A	KX9002D	KX9002T	Remarks
Connectable machine	Video camera	Option	Option	Option	Vide recording option
	XR75 series X-ray inspection system	√	√	√	
	KD74 series X-ray inspection system	√	√	√	
	M5 Series Metal detector	√	√	√	
	duw/duw-h series Metal detector	√	√	√	
	KD82xx M series Metal detector	√	√*1	√*1	*1 : CCP monitoring function is not available
	KD81xx duw series Metal detector	√	√	√	
	SSV series Checkweigher	√	√	√	
	SV series Checkweigher	√	√	√	
	Automatic combination weigher	√	√*1	√*1	*1 : CCP monitoring function is not available
Code reader	Scan individual product number			√	
	Scan operator number		√	√	CCP monitoring function
	Scan shipment information (production date and shipment number)		√	√	CCP monitoring function
Maintenance	Hard disk failure recovery	√	√	√	
	Network failure recovery	√	√	√	
	Time synchronization	√	√	√	
	Automatic data backup	√	√	√	
	Automatic data deletion	√	√	√	
	Failure notification	√	√	√	
	Data deletion	√	√	√	
	Data protection	√	√	√	
Recordable data	Video image	Option	Option	Option	
	Evaluation result	√	√	√	
	Evaluation details (mass value and product effect value)	√	√	√	
	Evaluation limit value	√	√	√	
	Statistics data	√	√	√	
	Batch statistical data	√	√	√	
	Lot statistics data	√	√	√	
	X-ray image	√	√	√	
	Equipment history	√	√	√	
Control	Product change	√	√	√	
	Parameter change	(*2)	(*2)	(*2)	*2 : Certain parameters only
Output method	Data association between equipment			√	
	Search by individual product number			√	
	Search by production date or shipment number		√	√	
	Search by lot number	√	√	√	
	Search by time and date	√	√	√	
Output format	Product inspection certification		√	√	CCP monitoring function, EXCEL format *3
	CCP monitoring report		√	√	CCP monitoring function, HTML format
	Video data	Option	Option	Option	AVI format
	Individual data	√	√	√	CSV, HTML format
	Image data	√	√	√	JPG, TIFF, PNG format
	Statistics data	√	√	√	CSV, HTML format
Analysis	History data	√	√	√	CSV, HTML format
	Advanced analysis	√	√	√	EXCEL format *3
	Xbar-s/R graph	√	√	√	
	Histogram	√	√	√	

\*3 : Microsoft Office Excel 2000, 2002, 2003, 2007, 2010, 2013 or 2016 is required.

## Point New enhancements provide data safeguards

### ● Data loss prevention

QUICCA's new capabilities protect your inspection data against errors or unexpected events.

#### Against hard disk failure and capacity shortage

- ▶ When several hard disks are registered, the data storage space is automatically switched to available disk drives.

\*Data base cannot be switched automatically. For hard disk drives, set up RAID configurations to protect against disk failures .

#### Against network shutdown and reboot after Windows automatic update

- ▶ A certain amount of data is stored in the equipment. After network recovery, the data is retransmitted to the database.

### ● Data management

#### Automatic data backup

Automatically keep your data and QUICCA settings backed up on other hard disks.

#### Automatic data deletion

Automatically delete stored data according to the set conditions such as elapsed days.



# QUICCA Operation Environment

## 1 License and Ethernet unit

- **QUICCA license:** Required for each PC on which QUICCA installed.
- **Connection license:** Required for each machine connected to QUICCA.
- **Ethernet unit:** Required according to the device connected, such as a code reader. No additional Ethernet unit is required for models with a built-in Ethernet port.
- **Camera connection license:** Required for each camera connected to QUICCA.

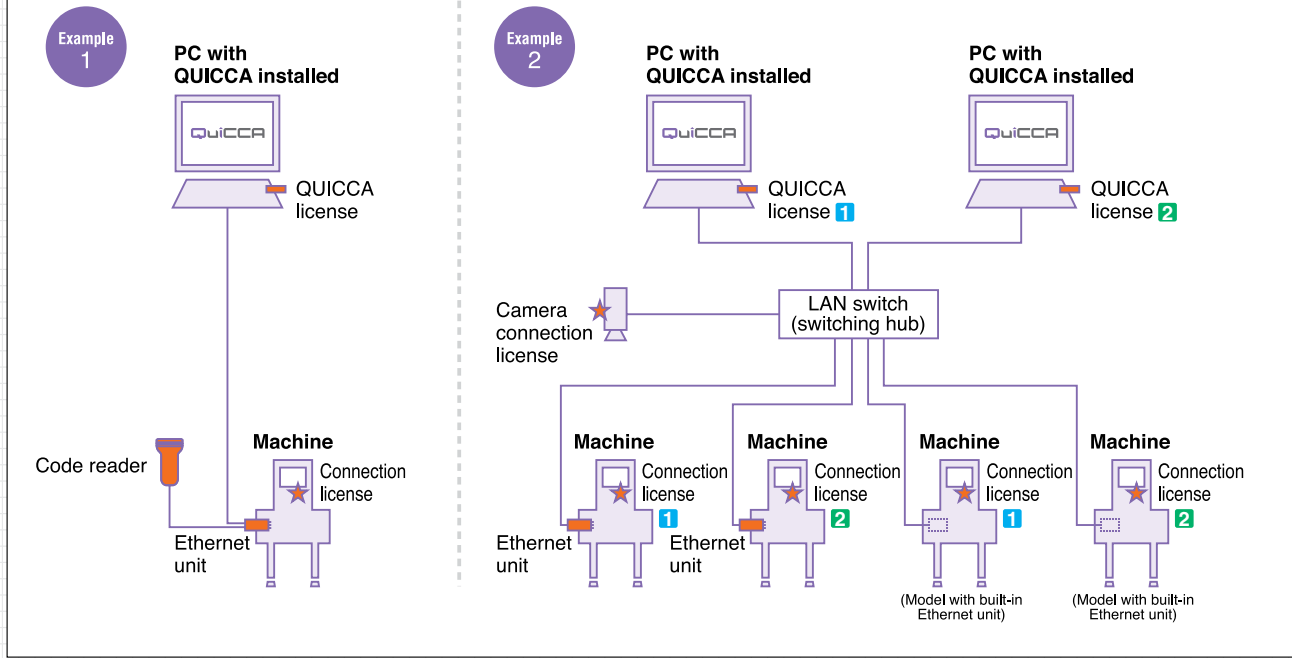

\* Network devices such as PCs or switches, or machines are not included in QUICCA.

## 2 System requirements

Item	Remark	Supply
PC (computer and server)	PC to install QUICCA	Supplied by user
LAN cable	Category 5e or higher. Must support Gigabit Ethernet for video recording.	
LAN switch (switching hub)	Required for networking multiple units. Must support Gigabit Ethernet for video recording.	
Cable piping and wiring	Required to connect computer and LAN switch, etc.	
HDD for backups (NAS,USB-HDD)	For data backups.	
External HDD for expansion	Required if PC does not have enough disk space. USB3.0 is required for continuous recording of video image.	
Video camera	IP network camera is required for video recording.	Supplied by Anritsu *1
Code reader	For scanning individual product number. Connected to machines.	
Handheld code reader	For searching data based on individual product number. Connected to PC.	
KX9002A/D/T QUICCA	Includes QUICCA license. Connection license is required for each machine.	Supplied by Anritsu
KX9002ZC Image recording option	Camera connection license is required for each camera.	
Ethernet unit	Required according to the type of connected machine. For full function of CCP monitoring, Ethernet unit with code reader is required. *2	
Equipment	X-ray inspection system/Metal detector/Checkweigher/Automatic combination weigher	

\*1 : You can also use your own video camera and code reader. \*2 : Ask sales representatives for details.



# Specifications

## ■ QUICCA (KX9002A/D/T)

Maximum number of connectable machines *1	99
Maximum recording capacity *1	2000 products/min (all lines) 1000 products/min (when X-ray images recorded)
Maximum number of recordable data	Depends on free disk space on PC. Maximum 4 mil. data/day 1 to 4 mil.data/1GB (Individual data, Statistics data, History data) 10,000 to 30,000 data/1GB (image data) Data can be saved on multiple hard drives such as NAS

## ■ Video recording option (KX9002ZC)

Maximum number of connectable video cameras *1	64
Maximum recording capacity *1	16 (all lines total) 10 (when X-ray images recorded) When camera settings are as follows: Screen size: 640x480, Number of frames: 30 frames/sec, Format: MPEG4
Maximum number of recordable data	Depends on free disk space on PC. Maximum 4 mil. data/day 10 to 40 data/1GB (video data) Data can be saved on multiple hard drives such as NAS

\*1 : The maximum number of connectable machines and video cameras, and maximum recording capacity vary depending on specifications of PC and network configuration.

- Video images are recorded continuously for 24 hours a day. When a rejection or an alarm occurs, images of before, during, and after the event are saved automatically.
- Images recorded by continuous recording will be deleted after a specified time period.

## ■ System requirements

OS	Windows XP Professional SP2/SP3 Windows Server 2003 SP2/R2 SP2 Windows Vista SP2 (Business/Ultimate/Enterprise) (32bit) Windows Server 2008 SP2/R2/R2 SP1 (Standard/Enterprise/Datacenter/Foundation) (32bit/64bit) Windows 7/SP1 (Professional/Ultimate/Enterprise) (32bit/64bit) Windows 8 (Pro/Enterprise) (32bit/64bit) Windows 8.1 (Pro/Enterprise) (32bit/64bit) Windows Server 2012/R2 (Standard/Datacenter/Essentials/Foundation) (32bit/64bit) Windows 10 (Pro/Enterprise) (32 bit/64 bit)
CPU	Intel® Core™2 Duo processor 1.50 GHz or higher Intel® Pentium® 4 processor 2.00 GHz or higher For optional video recording, Intel® Core i5 • Core i7 • Xeon processor 2.40 GHz or higher recommended
Memory	1GB or higher (Windows XP, Windows Server 2003) 2GB or higher (Windows Vista, Windows Server 2008, Windows 7, Windows 8, Windows 8.1, Windows Server 2012) For optional video recording, 4GB or higher recommended
HDD	50MB or more free disk space for installation in addition to that required for data saving For optional video recording: 150MB or more free hard disk space for installation, and 40GB or more per camera for continuous video recording USB3.0 HDD is recommended for continuous recording
Display	1024 × 768 or higher
LAN	Ethernet (100BASE-TX,1000BASE-T) For optional video recording, Gigabit Ethernet (1000BASE-T) recommended
Software *2	Advanced analysis: Microsoft Office Excel 2000/2002/2003/2007/2010/2013/2016 Barcode creation: Microsoft Office Access 2000/2002/2003/2007/2010/2013/2016

● Above are minimum system requirements. Higher performance may be required for comfort of use.

\*2 : Video recording option (KX9002ZC) supports the following operating systems: Windows 7/SP1 (Professional/Ultimate/Enterprise)(64bit)  
Windows 8 (Pro/Enterprise)(64 bit)  
Windows Server 2012 (Standard/Enterprise/Datacenter/Foundation)(64 bit)

For the latest supported operating systems, please visit our website at <http://www.anritsu-infivis.com/en/>

Intel, Intel Core, Pentium, and Xeon are trademarks of Intel Corporation in the U.S. and/or other countries.

Microsoft, Windows and Windows Server, Windows Vista, Access and Excel are registered trademarks or trademarks of Microsoft Corporation in the United States and/or other countries.  
Other company names, product names, and service names are the trademarks or registered trademarks of their respective companies.



ANRITSU INFIVIS INC. <http://www.detectionperfection.com>

1001 Cambridge Drive Elk Grove Village, IL 60007-2453  
Phone (847) 419-XRAY (9729) Fax (847) 537-8266

© ANRITSU INFIVIS CO., LTD. 2012

ISO14001 CERTIFICATE No.JQA-EM0210  
ISO 9001 CERTIFICATE No.JQA-0316

- Some products shown in this catalog may not be available in your country or region. Contact our sales representatives for details.
- To ensure proper operation, read the Operation Manual before using the machine.
- In addition to daily inspection, a full maintenance inspection should be completed annually.

Specifications are subject to change without notice.  
No part of this catalog may be reproduced without our permission.

Printed on Recycled Paper