

**Network Master Series
MT9090A Mainframe
MU909060A Series
Gigabit Ethernet Module
Operation Manual**

14th Edition

**For safety and warning information, please read this manual before attempting to use the equipment.
Keep this manual with the equipment.**

ANRITSU CORPORATION

Safety Symbols

To prevent the risk of personal injury or loss related to equipment malfunction, Anritsu Corporation uses the following safety symbols to indicate safety-related information. Ensure that you clearly understand the meanings of the symbols BEFORE using the equipment. Some or all of the following symbols may be used on all Anritsu equipment. In addition, there may be other labels attached to products that are not shown in the diagrams in this manual.

Symbols used in manual



DANGER

This indicates a very dangerous procedure that could result in serious injury or death if not performed properly.



WARNING

This indicates a hazardous procedure that could result in serious injury or death if not performed properly.



CAUTION

This indicates a hazardous procedure or danger that could result in light-to-severe injury, or loss related to equipment malfunction, if proper precautions are not taken.

Safety Symbols Used on Equipment and in Manual

The following safety symbols are used inside or on the equipment near operation locations to provide information about safety items and operation precautions. Ensure that you clearly understand the meanings of the symbols and take the necessary precautions BEFORE using the equipment.



This indicates a prohibited operation. The prohibited operation is indicated symbolically in or near the barred circle.



This indicates an obligatory safety precaution. The obligatory operation is indicated symbolically in or near the circle.



This indicates a warning or caution. The contents are indicated symbolically in or near the triangle.



This indicates a note. The contents are described in the box.



These indicate that the marked part should be recycled.

Network Master Series
MT9090A Mainframe
MU909060A Series Gigabit Ethernet Module
Operation Manual
24 March 2009 (First Edition)
6 December 2013 (14th Edition)

Copyright © 2009-2013, ANRITSU CORPORATION.

All rights reserved. No part of this manual may be reproduced without the prior written permission of the publisher.

The contents of this manual may be changed without prior notice.

Printed in Japan

For Safety

WARNING



- ALWAYS refer to the operation manual when working near locations at which the alert mark shown on the left is attached. If the advice in the operation manual is not followed, there is a risk of personal injury or reduced equipment performance. The alert mark shown on the left may also be used with other marks and descriptions to indicate other dangers.
- Overvoltage Category
This equipment complies with overvoltage category II defined in IEC 61010. DO NOT connect this equipment to the power supply of overvoltage category III or IV.
- Laser radiation warning
 - NEVER look directly into the cable connector on the equipment nor into the end of a cable connected to the equipment. There is a risk of injury if laser radiation enters the eye.
 - The Laser Safety label is attached to the equipment for safety use as indicated in "Laser Safety" later in this section.
- Only qualified service personnel with a knowledge of electrical fire and shock hazards should service this equipment. This equipment cannot be repaired by the operator. DO NOT attempt to remove the equipment covers or unit covers or to disassemble internal components. In addition, there is a risk of damage to precision components.
- The performance-guarantee seal verifies the integrity of the equipment. To ensure the continued integrity of the equipment, only Anritsu service personnel, or service personnel of an Anritsu sales representative, should break this seal to repair or calibrate the equipment. Be careful not to break the seal by opening the equipment or unit covers. If the performance-guarantee seal is broken by you or a third party, the performance of the equipment cannot be guaranteed.

Repair

WARNING 

Calibration



For Safety

WARNING

Replacing Battery



- When replacing the battery, use the specified battery and insert it with the correct polarity. If the wrong battery is used, or if the battery is inserted with reversed polarity, there is a risk of explosion causing severe injury or death.

Battery Fluid

- DO NOT short the battery terminals and never attempt to disassemble the battery or dispose of it in a fire. If the battery is damaged by any of these actions, the battery fluid may leak. This fluid is poisonous. DO NOT touch the battery fluid, ingest it, or get in your eyes. If it is accidentally ingested, spit it out immediately, rinse your mouth with water and seek medical help. If it enters your eyes accidentally, do not rub your eyes, rinse them with clean running water and seek medical help. If the liquid gets on your skin or clothes, wash it off carefully and thoroughly.

Battery Disposal

- DO NOT expose batteries to heat or fire. Do not expose batteries to fire. This is dangerous and can result in explosions or fire. Heating batteries may cause them to leak or explode.

LCD

- This equipment uses a Liquid Crystal Display (LCD). DO NOT subject the equipment to excessive force or drop it. If the LCD is subjected to strong mechanical shock, it may break and liquid may leak. This liquid is very caustic and poisonous. DO NOT touch it, ingest it, or get in your eyes. If it is ingested accidentally, spit it out immediately, rinse your mouth with water and seek medical help. If it enters your eyes accidentally, do not rub your eyes, rinse them with clean running water and seek medical help. If the liquid gets on your skin or clothes, wash it off carefully and thoroughly .
-

For Safety

CAUTION

Check Terminal



-
- Never input a signal of more than the indicated value between the measured terminal and ground. Input of an excessive signal may damage the equipment.
-

For Safety

Class 1 indicate the danger degree of the laser radiation specified below according to IEC 60825-1:2007.

Class 1: Lasers that are safe under reasonably foreseeable conditions of operation, including the use of optical instruments for intrabeam viewing.

 **CAUTION**

Use of controls or adjustments or performance of procedures other than those specified herein may result in hazardous radiation exposure.

The use of optical instruments with this product will increase eye hazard.

For Safety

WARNING

Laser Safety

The laser in the plug-in unit provided for this equipment is classified as Class 1 according to the IEC 60825-1:2007 standard.

Table 1 Laser Safety Classifications Based on IEC 60825-1:2007

SFP Type	Class	Max. Optical Output Power (W)*	Pulse Width (s)/ Repetition Rate	Emitted Wavelength (nm)	Beam Divergence (deg)	Incorporated Laser Specification (refer to Table 2)	Laser Aperture
LX and FX	1	0.0156	CW	1310	11.5	a)	Figure 1, [1],[2]
ZX	1	0.01	CW	1550	11.5	b)	Figure 1, [1],[2]
SX	1	0.000709	CW	850	36.9	c)	Figure 1, [1],[2]

*: Indicates the possible optical output power when each and every reasonably foreseeable single-fault condition is included.

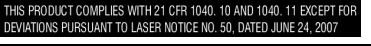
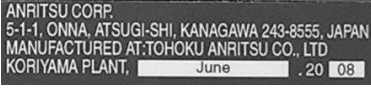

Table 2 Incorporated Laser Specification

Incorporated Laser	Max. Optical Output Power (W)*	Pulse Width (s)/ Repetition Rate	Emitted Wavelength (nm)	Beam Divergence (deg)
a)	0.0156	CW	1310	11.5
b)	0.01	CW	1550	11.5
c)	0.000709	CW	850	36.9

*: Maximum output power is the estimated value when something breaks down.

For Safety

Table 3 Indication Labels on Product

	Type	Sample	Affixed to:	Model Name
1	Explanation		Figure 1, C	All
2	Certification		Figure 1, B	All
3	Identification		Figure 1, A	All
4	Warning		Figure 1, D	All

For Safety

Laser Radiation Markings

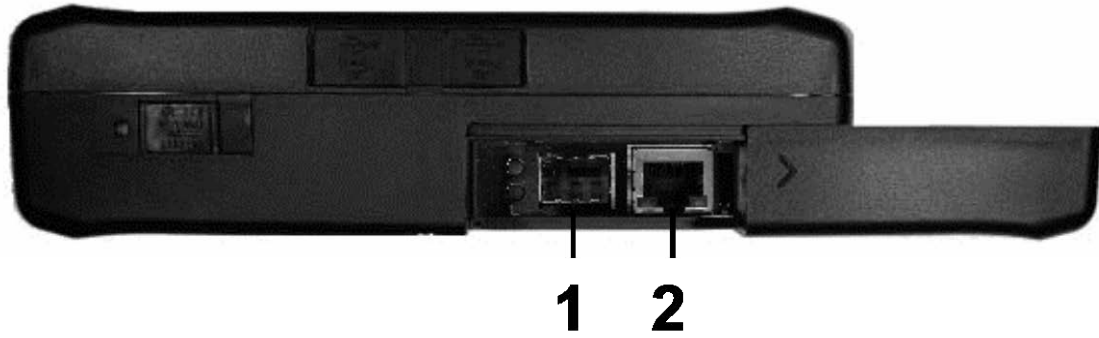

Figure 1 Locations of Laser Beam Apertures and Affixed Labels

For Safety

FOR EU & EFTA CUSTOMERS

Please Recycle.



Ni-MH



Read the following when using products to which the mark shown on the above is attached.

The product that you have purchased contains a rechargeable battery. The battery is recyclable. At the end of its useful life, under various state and local laws, it may be illegal to dispose of this battery into the municipal waste. Check with your local solid-waste disposal officials for details of recycling options or proper disposal in your area.

Before disposing of this product, discharge the battery and mail it to your Anritsu Service or Sales office.

1. Disconnect the AC adapter, if used.
2. Turn the power switch to on.
3. Leave the product on until the power indicator goes off; the battery is now discharged.
4. Remove the battery.
5. Insulate the battery terminals with adhesive tape.
6. Please recycle in accordance with your national or regional legislation.

Nach gebrauch der Verkaufsstelle zurückgeben.

Après usage à rapporter au point de vente.

For Safety

CAUTION

External Storage Media

This equipment uses USB flash drives as external storage media for storing data and programs.

If this media is mishandled or becomes faulty, important data may be lost. To prevent this chance occurrence, all important data and programs should be backed-up.

Anritsu will not be held responsible for lost data.

Pay careful attention to the following points.

- Never remove the USB flash drive from the instrument while it is being accessed.
- The USB flash drive may be damaged by static electric charges.

Use in a residential environment

This instrument is designed for an industrial environment. In a residential environment this instrument may cause radio interference in which case the user may be required to take adequate measures.

Use in Corrosive Atmospheres

Exposure to corrosive gases such as hydrogen sulfide, sulfurous acid, and hydrogen chloride will cause faults and failures. Note that some organic solvents release corrosive gases.

Equipment Certificate

Anritsu Corporation certifies that this equipment was tested before shipment using calibrated measuring instruments with direct traceability to public testing organizations recognized by national research laboratories, including the National Institute of Advanced Industrial Science and Technology, and the National Institute of Information and Communications Technology, and was found to meet the published specifications.

Anritsu Warranty

Anritsu Corporation will repair this equipment free-of-charge if a malfunction occurs within one year after shipment due to a manufacturing fault. However, software fixes will be made in accordance with the separate Software End-User License Agreement. Moreover, Anritsu Corporation will deem this warranty void when:

- The fault is outside the scope of the warranty conditions separately described in the operation manual.
- The fault is due to mishandling, misuse, or unauthorized modification or repair of the equipment by the customer.
- The fault is due to severe usage clearly exceeding normal usage.
- The fault is due to improper or insufficient maintenance by the customer.
- The fault is due to natural disaster, including fire, wind, flooding, earthquake, lightning strike, or volcanic ash, etc.
- The fault is due to damage caused by acts of destruction, including civil disturbance, riot, or war, etc.
- The fault is due to explosion, accident, or breakdown of any other machinery, facility, or plant, etc.
- The fault is due to use of non-specified peripheral or applied equipment or parts, or consumables, etc.
- The fault is due to use of a non-specified power supply or in a non-specified installation location.
- The fault is due to use in unusual environments^(Note).
- The fault is due to activities or ingress of living organisms, such as insects, spiders, fungus, pollen, or seeds.

In addition, this warranty is valid only for the original equipment purchaser. It is not transferable if the equipment is resold.

Anritsu Corporation shall assume no liability for injury or financial loss of the customer due to the use of or a failure to be able to use this equipment.

Note:

For the purpose of this Warranty, "unusual environments" means use:

- In places of direct sunlight
- In dusty places
- In liquids, such as water, oil, or organic solvents, and medical fluids, or places where these liquids may adhere
- In salty air or in place chemically active gases (sulfur dioxide, hydrogen sulfide, chlorine, ammonia, nitrogen oxide, or hydrogen chloride etc.) are present
- In places where high-intensity static electric charges or electromagnetic fields are present
- In places where abnormal power voltages (high or low) or instantaneous power failures occur
- In places where condensation occurs
- In the presence of lubricating oil mists
- In places at an altitude of more than 2,000 m
- In the presence of frequent vibration or mechanical shock, such as in cars, ships, or airplanes

Anritsu Corporation Contact

In the event that this equipment malfunctions, contact an Anritsu Service and Sales office. Contact information can be found on the last page of the printed version of this manual, and is available in a separate file on the CD version.

Notes On Export Management

This product and its manuals may require an Export License/Approval by the Government of the product's country of origin for re-export from your country.

Before re-exporting the product or manuals, please contact us to confirm whether they are export-controlled items or not.

When you dispose of export-controlled items, the products/manuals need to be broken/shredded so as not to be unlawfully used for military purpose.

Reuse parts

Anritsu group promotes recycling activities in order to reuse available resources and save energy. This product may use recycled parts (mechanical components) that conform to Anritsu's quality standards.

FOR CALIFORNIA USA ONLY

This product contains a CR Coin Lithium Battery which contains Perchlorate Material – special handling may apply; See www.dtsc.ca.gov/hazardouswaste/perchlorate

Crossed-out Wheeled Bin Symbol

Equipment marked with the Crossed-out Wheeled Bin Symbol complies with council directive 2002/96/EC (the “WEEE Directive”) in European Union.



For Products placed on the EU market after August 13, 2005, please contact your local Anritsu representative at the end of the product's useful life to arrange disposal in accordance with your initial contract and the local law.

Software End-User License Agreement (EULA)

Please read this Software End-User License Agreement (hereafter this EULA) carefully before using (includes executing, copying, registering, etc.) this software (includes programs, databases, scenarios, etc., used to operate, set, etc., Anritsu electronic equipment). By reading this EULA and using this software, you are agreeing to be bound by the terms of its contents and Anritsu Corporation (hereafter Anritsu) hereby grants you the right to use this Software with the Anritsu-specified equipment (hereafter Equipment) for the purposes set out in this EULA.

1. Grant of License and Limitations

1. Regardless of whether this Software was purchased from or provided free-of-charge by Anritsu, you agree not to rent, lease, lend, or otherwise distribute this Software to third parties and further agree not to disassemble, recompile, reverse engineer, modify, or create derivative works of this Software.
2. You may make one copy of this Software for backup purposes only.
3. You are not permitted to reverse engineer this software.
4. This EULA allows you to install one copy of this Software on one piece of Equipment.

2. Disclaimers

To the extent not prohibited by law, in no event shall Anritsu be liable for personal injury, or any incidental, special, indirect or consequential damages whatsoever, including, without limitation, damages for loss of profits, loss of data, business interruption or any other commercial damages or losses, arising out of or related to your use or inability to use this Software.

3. Limitation of Liability

- a. If a fault (bug) is discovered in this Software, preventing operation as described in the operation manual or specifications whether or not the customer uses this software as described in the manual, Anritsu shall at its own discretion, fix the bug, or exchange the software, or suggest a workaround, free-of-charge. However, notwithstanding the above, the following items shall be excluded from repair and warranty.
 - i) If this Software is deemed to be used for purposes not described in the operation manual or specifications.
 - ii) If this Software is used in conjunction with other non-Anritsu-approved software.
 - iii) Recovery of lost or damaged data.
 - iv) If this Software or the Equipment has been modified, repaired, or otherwise altered without Anritsu's prior approval.
 - v) For any other reasons out of Anritsu's direct control and responsibility, such as but not limited to, natural disasters, software virus infections, etc.
- b. Expenses incurred for transport, hotel, daily allowance, etc., for on-site repairs by Anritsu engineers necessitated by the above faults shall be borne by you.
- c. The warranty period for faults listed in article 3a above covered by this EULA shall be either 6 months from the date of purchase of this Software or 30 days after the date of repair, whichever is longer.

4. Export Restrictions

You may not use or otherwise export or re-export directly or indirectly this Software except as authorized by Japanese and United States law. In particular, this software may not be exported or re-exported (a) into any Japanese or US embargoed countries or (b) to anyone on the Japanese or US Treasury Department's list of Specially Designated Nationals or the US Department of Commerce Denied Persons List or Entity List. By using this Software, you warrant that you are not located in any such country or on any such list. You also agree that you will not use this Software for any purposes prohibited by Japanese and US law, including, without limitation, the development, design and manufacture or production of missiles or nuclear, chemical or biological weapons of mass destruction.

5. Termination

Anritsu shall deem this EULA terminated if you violate any conditions described herein. This EULA shall also be terminated if the conditions herein cannot be continued for any good reason, such as violation of copyrights, patents, or other laws and ordinances.

6. Reparations

If Anritsu suffers any loss, financial or otherwise, due to your violation of the terms of this EULA, Anritsu shall have the right to seek proportional damages from you.

7. Responsibility after Termination

Upon termination of this EULA in accordance with item 5, you shall cease all use of this Software immediately and shall as directed by Anritsu either destroy or return this Software and any backup copies, full or partial, to Anritsu.

8. Dispute Resolution

If matters of dispute or items not covered by this EULA arise, they shall be resolved by negotiations in good faith between you and Anritsu.

9. Court of Jurisdiction

This EULA shall be interpreted in accordance with Japanese law and any disputes that cannot be resolved by negotiation described in Article 8 shall be settled by the Japanese courts.

Notice

The following actions are strictly prohibited for all of the software installed in this product or otherwise provided by Anritsu:

1. Copying, except for archival purposes.
2. Transferring to a third party separately from this product.
3. Analyzing the incorporated software including but not limited to modifying, decompiling, disassembling, and reverse engineering.

Cautions against computer virus infection

- Copying files and data
Only files that have been provided directly from Anritsu or generated using Anritsu equipment should be copied to the instrument.
All other required files should be transferred by means of USB or CompactFlash media after undergoing a thorough virus check.
- Adding software
Do not download or install software that has not been specifically recommended or licensed by Anritsu.
- Network connections
Ensure that the network has sufficient anti-virus security protection in place.

CE Conformity Marking

Anritsu affixes the CE conformity marking on the following product(s) in accordance with the Council Directive 93/68/EEC to indicate that they conform to the EMC directive of the European Union (EU).

CE marking



1. Product Model

Model: MT9090A Mainframe
MU909060A1 Gigabit Ethernet Module RJ45 SFP
MU909060A2 Gigabit Ethernet Module RJ45 RJ45
MU909060A3 Gigabit Ethernet Module SFP SFP

2. Applied Directive

EMC: Directive 2004/108/EC

3. Applied Standards

- EMC: Emission: EN 61326-1: 2006 (Class A)
Immunity: EN 61326-1: 2006 (Table 2)

	Performance Criteria*
IEC 61000-4-2 (ESD)	B
IEC 61000-4-3 (EMF)	A
IEC 61000-4-4 (Burst)	B
IEC 61000-4-5 (Surge)	B
IEC 61000-4-6 (CRF)	A
IEC 61000-4-11 (V dip/short)	B, C

*: Performance Criteria

- A: During testing, normal performance within the specification limits.
- B: During testing, temporary degradation, or loss of function or performance which is self-recovering.
- C: During testing, temporary degradation, or loss of function or performance which requires operator intervention or system reset occurs.

Harmonic current emissions:

EN 61000-3-2: 2006 +A1:2009 A2:2009

(Class A equipment)

: No limits apply for this equipment with an active input power under 75 W.

- LVD: EN 61010-1: 2010 (Pollution Degree 2)

4. Authorized representative

Name: Murray Coleman
Head of Customer Service EMEA
ANRITSU EMEA Ltd.
Address, city: 200 Capability Green, Luton
Bedfordshire, LU1 3LU
Country: United Kingdom

C-Tick Conformity Marking

Anritsu affixes the C-Tick mark on the following product(s) in accordance with the regulation to indicate that they conform to the EMC framework of Australia/New Zealand.

C-Tick mark



1. Product Model

Model:	MT9090A Mainframe
	MU909060A1 Gigabit Ethernet Module RJ45 SFP
	MU909060A2 Gigabit Ethernet Module RJ45 RJ45
	MU909060A3 Gigabit Ethernet Module SFP SFP

2. Applied Standards

EMC: Emission: EN 61326-1: 2006 (Class A equipment)

About This Manual

The purpose of this operation manual is to explain how to set up the MU909060A Series Gigabit Ethernet Module and how to use the various features and modes. This manual is designed to appeal to professionals with the technical background to use this type of instrument.

Descriptions in this manual assume a knowledge of Ethernet and IP technology.

Table of Contents

For Safety	iii
About This Manual.....	I
Chapter 1 Overview.....	1-1
1.1 Configuration.....	1-2
1.2 Front Panel	1-6
1.3 Back Panel.....	1-10
1.4 Bottom Panel	1-15
1.5 Top Connector Panel.....	1-16
1.6 Changing Test Module.....	1-29
1.7 Basic Usage Notes	1-31
Chapter 2 General Operation	2-1
2.1 Power Up/Power Down.....	2-3
2.2 General Functions.....	2-5
2.3 Mass Storage.....	2-13
2.4 Print Screen	2-20
2.5 Status Screen	2-21
2.6 Result Screens.....	2-27
2.7 Save and Load.....	2-33
2.8 Setup.....	2-40
2.9 Test Reports	2-42
Chapter 3 Ethernet Application.....	3-1
3.1 Application Ethernet Status	3-3
3.2 Application Ethernet Setup	3-4
3.3 Generator Test.....	3-35
3.4 BER Test.....	3-63
3.5 Stimuli	3-66
3.6 Ping Test.....	3-70
3.7 Cable Test.....	3-75
3.8 RFC2544 Tests.....	3-78
3.9 HTTP/FTP Download Test.....	3-100
3.10 Trace Route Test	3-107
3.11 Y.1564 Suite	3-111
3.12 Address Wizard.....	3-205

3.13 OAM Loopback Application 3-215

Chapter 4 Application Reflector..... 4-1

4.1 Status 4-2

4.2 Setup Interface..... 4-3

4.3 Result 4-7

Chapter 5 Pass Through..... 5-1

5.1 Status 5-2

5.2 Setup Interface..... 5-3

5.3 Testing 5-5

5.4 Result..... 5-6

Chapter 6 Updating Firmware 6-1

6.1 Updating Firmware..... 6-2

Chapter 7 Service Information 7-1

7.1 Self Diagnostics 7-2

7.2 Maintenance 7-6

7.3 Disposal 7-7

Appendix A Specifications A-1

Appendix B Remote Control..... B-1

Appendix C PC Application Manual..... C-1

Appendix D Software Licenses D-1

Index Index-1

1
2
3
4
5
6
7
Appendix
Index

Chapter 1 Overview

It is important to know the layout, use, and functions of the front panel, back panel, and top connector panel of the Network Master.

1

Overview

1.1	Configuration.....	1-2
1.1.1	Standard Configuration.....	1-2
1.1.2	Option	1-3
1.2	Front Panel	1-6
1.2.1	LCD.....	1-7
1.2.2	Panel Keys	1-8
1.3	Back Panel.....	1-10
1.3.1	Power and Batteries	1-11
1.3.2	Installing Ni-MH Battery Pack.....	1-12
1.3.3	Battery Replacement – Ni-MH Pack To AA Ni-MH.....	1-14
1.4	Bottom Panel	1-15
1.5	Top Connector Panel	1-16
1.5.1	AC Charger/Adapter	1-17
1.5.2	Battery Status LED	1-20
1.5.3	RJ45 Port.....	1-21
1.5.4	SFP Port	1-22
1.5.5	Connecting Peripheral Devices	1-24
1.5.6	Cautions on Handling Optical Fiber Cables ...	1-27
1.6	Changing Test Module.....	1-29
1.7	Basic Usage Notes	1-31

1.1 Configuration

1.1.1 Standard Configuration

The table below lists the standard configuration of the Network Master series Gigabit Ethernet Module.

If you find any missing or broken components, immediately contact Anritsu or our sales dealer.

Table 1.1.1-1 Standard configuration

Item	Model or order No.	Name	Qty.	Remarks
Body	MT9090A	Mainframe	1	
Module	MU909060A1	Gigabit Ethernet Module	1*	One RJ-45, One SFP
	MU909060A2	Gigabit Ethernet Module	1*	Two RJ-45
	MU909060A3	Gigabit Ethernet Module	1*	Two SFP
Accessory	W3173AE	Gigabit Ethernet Module Quick guide	1	
	Z1234A	Network Master Gigabit Ethernet Tester CD	1	
	G0203A	AC charger/adapter	1	
	G0202A	Ni-MH battery pack	1	
	B0601B	Standard Soft Case	1	
	Z1023A	Strap	1	

*: Exclusive

1.1.2 Option

Below Options are available for Gigabit Ethernet Module.

Table 1.1.2-1 Option

Model	Name	Remark
MU909060A1-001	RFC2544 test	Software Option
MU909060A1-002	Multistream	Software Option
MU909060A1-003	Stacked VLAN	Software Option
MU909060A1-004	MPLS	Software Option
MU909060A1-005	Remote GUI	Software Option
MU909060A1-006	Channel Stats	Software Option
MU909060A1-007	Y.1564 Suite	Software Option
MU909060A2-001	RFC2544 test	Software Option
MU909060A2-002	Multistream	Software Option
MU909060A2-003	Stacked VLAN	Software Option
MU909060A2-004	MPLS	Software Option
MU909060A2-005	Remote GUI	Software Option
MU909060A2-006	Channel Stats	Software Option
MU909060A2-007	Y.1564 Suite	Software Option
MU909060A3-001	RFC2544 test	Software Option
MU909060A3-002	Multistream	Software Option
MU909060A3-003	Stacked VLAN	Software Option
MU909060A3-004	MPLS	Software Option
MU909060A3-005	Remote GUI	Software Option
MU909060A3-006	Channel Stats	Software Option
MU909060A3-007	Y.1564 Suite	Software Option

RFC2544 test

This option enables RFC 2544 testing described in Section 3.8 “RFC2544 Tests”.

Multistream

This option generates Multistream described in Section 3.3 “Generator Test”.

Stacked VLAN

This option enables the VLAN stacking functions, described in Section 3.3 “Generator Test”.

MPLS

This option enables the MPLS stacking functions, described in Section 3.3 “Generator Test”.

Remote GUI

This option enables the Remote Control feature, described in Section 3.3 “Generator Test”.

Channel Stats

This option enables the Channel Statistics feature, described in Section 3.3 “Generator Test”.

Y.1564 Suite

This option enables the Y.1564 Suite feature, described in Section 3.11 “Y.1564 Suite”.

To check the installed options on a unit, power-on the unit and wait for the **Top Menu** display, as shown in Figure 1.1.2-1 below. Use the **Up/Down/Left/Right**-arrow keys to move the highlight over the **Self Diagnostics** application button.

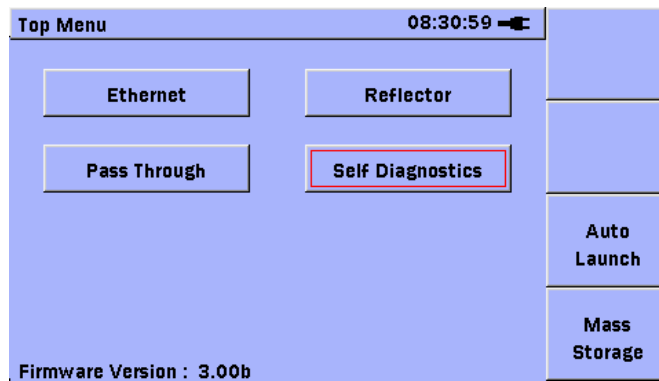

Figure 1.1.2-1 Top Menu

Press the **Set** key. The Self Diagnostics application will start. Press the **Menu** key. The context menu for the application will be displayed as shown in Figure 1.1.2-2 below.

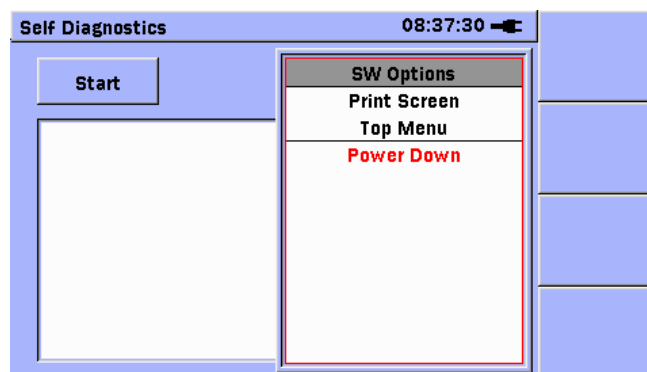

Figure 1.1.2-2 Context Menu

Use the **Up/Down**-arrow keys to move the highlight over the SW options item. Press the **Set** key to complete the selection. The SW Options will be displayed as shown in Figure 1.1.2-3 below.

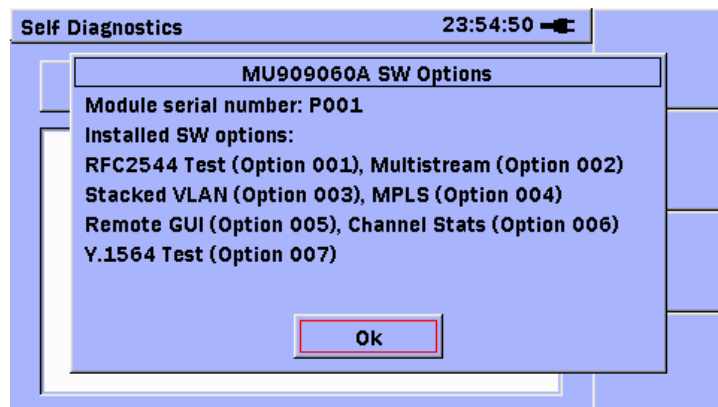

Figure 1.1.2-3 SW Options Window

Review the SW Options and press the **Set** key to release the window when finished.

Press the **Menu** key. Use the **Up/Down**-arrow keys to move the highlight over the **Top Menu** item. Press the **Set** key to complete the selection and return to the **Top Menu**.

1.2 Front Panel

The front panel contains the operation controls and LCD display.

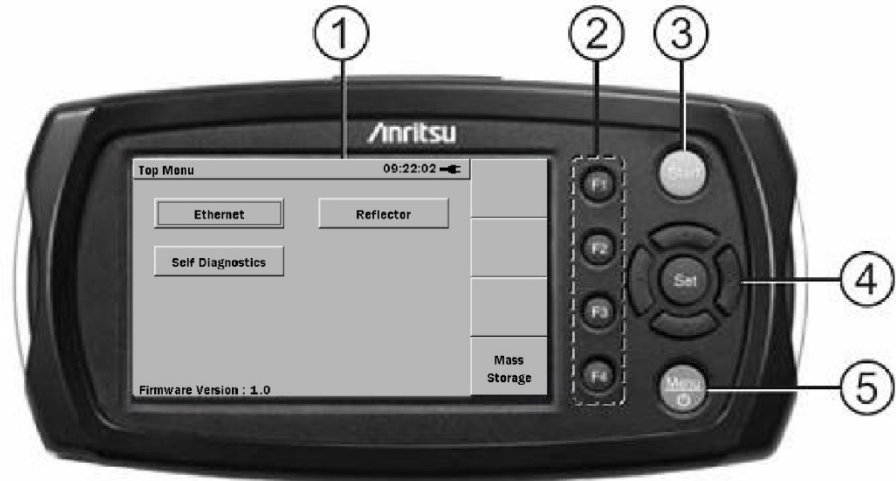
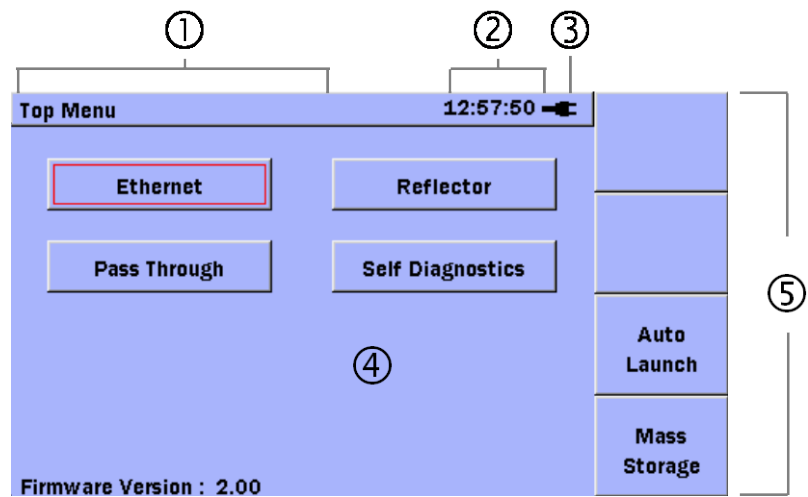

Figure 1.2-1 Front Panel Layout

- ① LCD
- ② Soft keys
- ③ Start key
- ④ Arrow keys and Set key
- ⑤ Menu/Power key

1.2.1 LCD

The graphical user interface varies with the selected mode but each screen shares common elements as shown in the figure below.



- | | | |
|---|-----------------------------|---|
| ① | Screen title | Displays title of current screen |
| ② | Time display | Displays current time in 24-hour format (hh:mm:ss) |
| ③ | Battery or plug icon | Shows unit connected to external power supply (plug icon) or operating on battery power (battery icon) with graphic illustrating remaining charge |
| ④ | Presentation field | Changes with screen display |
| ⑤ | Soft keys | Display on-screen details |

1.2.2 Panel Keys

Soft keys



The unit has four soft keys (**F1** thru **F4**) on the right hand side of the LCD. The function of each key is determined by the current operation mode and is displayed on the screen to the left of the key.

Start key



Press to start or stop the test.

Note:

When Running a Generator test under certain conditions, this key may be used to re-set the statistics counters.

Arrow keys and Set key



The arrow keys (**Left/Right/Up/Down**) have the following functions:

Left arrow key	Moves cursor/highlight to left
Right arrow key	Moves cursor/highlight to right
Up arrow key	Moves cursor/highlight up
Down arrow key	Moves cursor/highlight down
Set key	Selects highlighted item

Menu/Power key



When unit is off:

- Press the **Menu/Power** key to power up.

When unit is on:

- Press the **Menu/Power** key to display the pop-up menu.
Power Down can be selected from the pop-up menu.

1.3 Back Panel

The back panel contains the battery compartment and a fastener to secure the test module to the Network Master main unit. There are also various compliance and warning labels as well as the model/serial number (item 3 in Figure 1.3-1).



Figure 1.3-1 Back Panel

- ① Battery compartment
- ② Fastener
- ③ Module model/serial label
- ④ Compliance and warning labels

1.3.1 Power and Batteries

The unit can be powered in three ways.

- **External AC charger/adaptor:**

Use this adapter to provide power from an AC source or to charge the Ni-MH (nickel-metal hydride) battery pack. For details see “1.5.1 AC Charger/Adapter”.

- **External car plug cord/adaptor (optional):**

Use this adapter to provide power from a car to charge the Ni-MH battery pack.

- **Ni-MH rechargeable battery pack:**

When installed, this battery powers the unit.

Note:

Only use the Anritsu Ni-MH battery pack. Anritsu does not guarantee the safety and function of other battery packs.

- **Replaceable batteries:**

If no AC charger/adaptor or Ni-MH battery is available, the unit can be powered by four AA Ni-MH batteries.

 **WARNING**

ALWAYS power down the Network Master before removing the Ni-MH battery pack.

The battery pack and/or Network Master may be damaged if the power is on while the pack is removed.

 **WARNING**

Before storing the Network Master for a long time (1 to 2 months), remove the Ni-MH battery pack to avoid damage to the battery pack and/or Network Master.

If storing the Network Master with the Ni-MH battery pack installed, always recharge the battery pack periodically (every 1 to 2 months).

1.3.3 Battery Replacement – Ni-MH Pack To AA Ni-MH

Replace the Ni-MH battery pack with AA Ni-MH batteries as described below:

1. Power down the unit. Open the battery compartment (Figure 1.3.2-1 for location) by pulling the latch while lifting the battery compartment cover.
2. Using the battery release pull (red ribbon), lift out the Ni-MH Battery Pack and unplug it from its socket next to the module release latch (white plastic latch).
3. Insert four new AA Ni-MH batteries in the compartment according to the battery polarity symbols (+ and –) next to the battery contacts.
4. Close the battery compartment cover.

 **WARNING**

ALWAYS power down the unit before removing old AA Ni-MH batteries.

If the batteries are removed while the power is on, settings and data files may be lost.

 **WARNING**

Remove AA Ni-MH batteries from the Network Master when storing it for a long period of time (1 to 2 months).

Storing the Network Master for a long period of time with AA Ni-MH batteries installed will decrease the discharge capacity of the batteries.

1.4 Bottom Panel

The bottom panel has a label with the main unit model/serial number.



Figure 1.4-1 Bottom Panel

1.5 Top Connector Panel

The top connector panel contains the measurement ports used to connect optical fibers or RJ45 cables to the network under test plus USB ports for uploading and downloading files. The 9 V DC Power Connector and Battery Status LED are also on the top panel.

Figure 1.5-1 shows a typical top panel.

Note:

The top panel configuration differs with the installed optics and options.

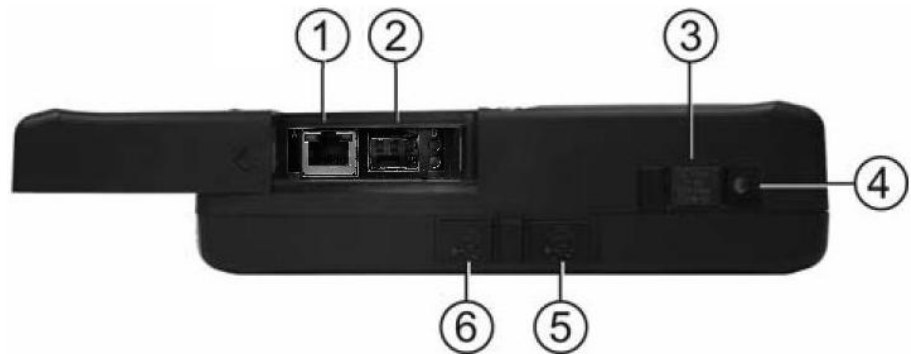

Figure 1.5-1 MU909060A1 Top Panel with Open Measurement Ports Cover

- ① Measurement Port A
- ② Measurement Port B
- ③ 9 V DC Power Connector
- ④ Battery Status LED
- ⑤ USB (Type A) port
- ⑥ USB (Type B) port

Table 1.5-1 Models Names and Measurement Ports

Model Name	Measurement Port A	Measurement Port B
MU909060A1	RJ45	SFP
MU909060A2	RJ45	RJ45
MU909060A3	SFP	SFP

1.5.1 AC Charger/Adapter

The unit includes an AC Charger/Adapter. The Ni-MH Battery Pack requires 3 hours to charge fully. The Network Master will not recharge the Ni-MH Battery Pack while it is operating.

The AC Charger/Adapter has four interchangeable plugs. Use the correct plug.



Figure 1.5.1-1 AC Charger/Adapter with Guard

- ① Guard
- ② Release

To prepare the AC Charger/Adapter:

1. Pull the Release and remove the Guard if it is in place (Figure 1.5.1-1).
2. Select the required plug from the AC Charger/Adapter kit. See the following figure.



3. Hold the Release down and insert the plug adapter, making sure that the tab on the plug adapter is seated in the slot on the top of the AC Charger/Adapter.
4. Release the Release, making sure that the tab on the Release is seated in the slot on the base of the plug adapter.

AC Power Operation

Operate the Network Master on AC power as described below.

To use the AC Charger/Adapter:

1. Open the cover on the Network Master 9 V DC Connector on the top connector panel (Figure 1.5-1) and plug in the jack from the AC Charger/Adapter.
2. Plug the AC Charger/Adapter into an AC outlet.

Note:

Ensure that the AC Charger/Adapter has the correct plug.

3. Press the **Menu/Power** key  to start the Network Master.

 **CAUTION**

Use the Network Master only with the Anritsu AC Charger/Adapter.

Anritsu does not guarantee the safety and functionality of other AC charger/adapters.

To charge the Ni-MH Battery Pack:

1. Power down the unit.
2. Open the cover on the Network Master 9 V DC Connector on the top connector panel (Figure 1.5-1) and plug in the jack from the AC Charger/Adapter.
3. Plug the AC Charger/Adapter into an AC outlet.

Note:

Ensure that the AC Charger/Adapter has the correct plug.

4. When the battery pack is fully charged, the Battery Status LED is lit green. See “Battery Status LED” for details. A full charge takes about 3 hours.

Note:

The Network Master will not charge the battery pack while it is being operated.

1.5.2 Battery Status LED

The Battery Status LED displays the current status of the Ni-MH Battery Pack:

Red:

The battery pack is not charging for one of the following reasons:

- When starting to charge, the temperature of the battery pack is lower than 5°C or higher than 45°C. In this situation, disconnect the AC adapter from the Network Master and wait until the temperature of the battery pack is within the 5° to 45°C range.
- While charging, the temperature of the battery pack becomes lower than 5°C or higher than 60°C. In this situation, charging resumes automatically as soon as the temperature of the battery pack is within the 5° to 45°C range.
- Charging has not finished within about 3 hours it normally takes to charge the battery pack fully. To avoid overcharging, the unit stops charging after about 3 hours.

If the Battery Status LED is always red, there is a problem with the battery pack. Please contact the Anritsu Technical Support Center or your local Anritsu representative (see Anritsu Corporation Contact).

Orange

- The AC Charger/Adapter is plugged in and the battery pack is charging.

Green

- The AC Charger/Adapter is plugged in and the battery pack is fully charged or the Network Master is operating. The battery pack will continue charging in maintenance charge mode.

Note:

Charging or discharging can be started at any time with minimum battery memory issues. The battery pack can be left in maintenance charge indefinitely.

1.5.3 RJ45 Port

The RJ45 port (item 1 in Figure 1.5-1) offers access to the optional RJ45 test port. This port has an RJ45 connector that accepts standard RJ45 cables.

Note:

See Table 1.5-1 for details on which models have the RJ45 option.

Connecting Cable to RJ45 port

1. Open the cover on the port (Figure 1.5-1).
2. Plug the RJ45 cable into the port

1.5.4 SFP Port

The SFP ports (item 2 in Figure 1.5-1) are located on the top panel of the Network Master and are accessed by opening the sliding cover (Figure 1.5-1). The modules can be either optical or electrical. The optical modules have LC connectors and the electrical modules have an RJ45 connector.

Cleaning Optical Connectors

Cleaning the optical connectors as described below.

1. Open the port cover.
2. Blow clean, dry compressed air on the tip of the ferrule.
3. Wipe the ferrule tip clean with a precision cleaning tissue or a lint free (foam) swab moistened with isopropyl alcohol.
4. Dry the ferrule tip with clean, dry compressed air.

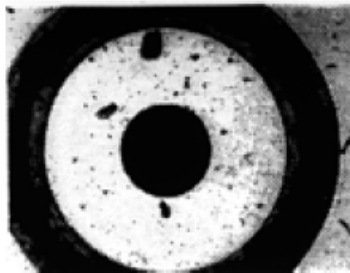

Dirty Ferrule Tip

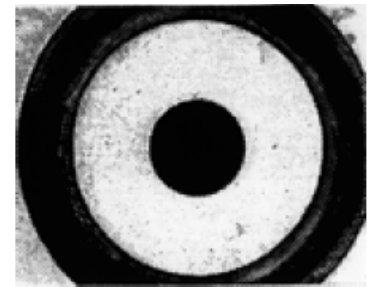

Clean Ferrule Tip

Figure 1.5.4-1 Magnified Ferrule Tip

5. Option: With the Network Master powered down, inspect the ferrule using a hand-held microscope or magnifier. It should look like the clean ferrule tip in Figure 1.5.4-1.

Connecting Fiber to Optical SFP modules

The optical SFP modules are used to connect optical fiber for optical test applications.

To connect a fiber to the SFP module:

1. Open the cover on the port (Figure 1.5-1).
2. Connect the test fiber to the measurement port.

 **WARNING**

Never force the connector ferrule or insert it at an angle into the adapter.

Optical fibers suffer loss caused by microbends or other stress. Position the patch cord to minimize mechanical strain.

1.5.5 Connecting Peripheral Devices

The unit has two USB ports for connecting a USB device or PC.

USB (Type A) port

The USB (Type A) port is used to connect a USB memory stick (version 1.1) to the unit. Some USB memory sticks are not supported by this port.



Figure 1.5.5-1 USB (Type A) Port

The following message is displayed when the unit detects that a USB device has been connected.



Figure 1.5.5-2 USB Storage Device Detected Dialog

Press the **Set** key to close the dialog and set the USB device as the default storage.

When the USB device is removed the following message is displayed (Figure 1.5.5-2).



Figure 1.5.5-3 USB Storage Device Removed Dialog

Press the **Set** key to close the dialog so the internal drive is set as the default storage drive.

 **WARNING**

Do not remove USB memory while it is being accessed or the memory or data may be damaged.

USB (Type B) port

The internal memory of the Network Master can be accessed directly from a PC by connecting a PC to the USB (Type B) using a USB A to USB B cable.



Figure 1.5.5-4 USB (Type B) Port

 **WARNING**

Before disconnecting the USB cable between the Network Master and PC always press Safely Remove Hardware in the Notification area in Microsoft Windows®, otherwise the internal memory on the Network Master may be damaged.

1.5.6 Cautions on Handling Optical Fiber Cables

Optical fiber cables may degrade in performance or be damaged if handled improperly.

Note the following points when handling them.

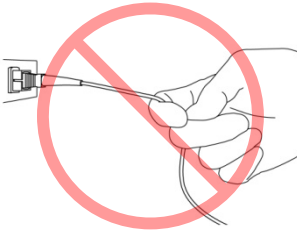

CAUTION

Do not pull the cable when removing the connector.

Doing so may break the optical fiber inside the cable, or remove the cable sheath from the optical connector.

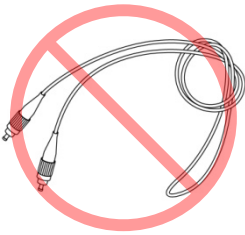

CAUTION

Do not excessively bend, fold, or pinch an optical fiber cable.

Doing so may break the optical fiber inside the cable. Keep the bend radius of an optical fiber cable at 30 mm or more. If the radius is less, optical fiber cable loss will increase.

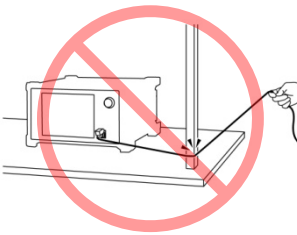



⚠ CAUTION

Do not excessively pull on or twist an optical fiber cable.

Also, do not hang anything by using a cable. Doing so may break the optical fiber inside the cable.

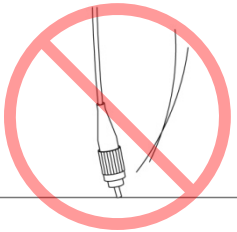

⚠ CAUTION

Be careful not to hit the end of an optical connector against anything hard such as the floor or a desk by dropping the optical fiber cable.

Doing so may damage the connector end and increase connection loss.

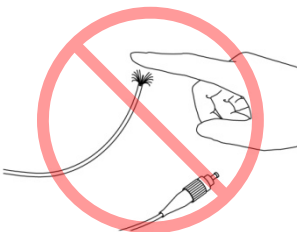

⚠ WARNING

Do not touch the end of a broken optical fiber cable.

The broken optical fiber may pierce the skin, causing injury.

⚠ CAUTION

Do not disassemble optical connectors.

Doing so may cause part to break or the performance to degrade.

1.6 Changing Test Module

Remove the installed test module from the Network Master and install the new test module as described below.

To change the test module:

1. Power down the unit.
2. Disconnect the AC Charger/Adapter, if connected.
3. Loosen the Captive Fastener on the back panel (item 2 in Figure 1.3-1). When loose, the fastener slips free but remains attached to the test module.
4. Open the battery compartment (Figure 1.3-1) and remove the battery pack or AA Ni-MH batteries.
5. Hold down the module release latch (white plastic latch in battery compartment – item 2 in Figure 1.3.2-1) while pulling on the Network Master to separate it from the test module.

Release the module Release latch after the Network Master and test module have been separated.

WARNING

The Network Master and test module are a close fit. Be careful when separating the two.

6. To install the new test module, align the two tabs on the back of the Network Master (end opposite 100-pin connector) with the two slots on the new test module (Figure 1.6-1).



Figure 1.6-1 Alignment Tabs and Slots

- ① Alignment tabs on Network Master main unit
 - ② Alignment slots on module
7. Applying firm but gentle pressure, place the Network Master main unit on the test module. **DO NOT** force the two sections together.
 8. Tighten the Captive Fastener.
 9. Replace any removed battery pack or AA Ni-MH batteries.
 10. Replace the battery compartment cover.

1.7 Basic Usage Notes

WARNING

Measurement port cover

The cover prevents dust and other contaminants collecting in the measurement port. Keep this cover closed except when a cable is connected.

Condensation

Condensation may occur in the Network Master when it is taken into a warm room after use outdoors, etc. In this case, allow the Network Master to dry out thoroughly before powering up.

Temperature range

Use the unit within the operating temperature range (0° to +40°C) and store it within the storage temperature range (-20° to +60°C). If the unit is left in a car or other enclosed space for a long time during summer, the ambient temperature may exceed the specified range, resulting in malfunction.

Safety

Only use the Anritsu AC Charger/Adapter or Ni-MH Battery Pack, otherwise the unit may be damaged.

Laser

NEVER look directly into the Network Master optical connector or end of a connected cable, otherwise laser light may enter the eye and cause injury. In addition, some SFP modules output high-power optical signals. To prevent damage to connected equipment, check that any connected photo-receiver will not be saturated. Anritsu accepts no responsibility for damage caused to connected communications devices.

Maintenance

Anritsu recommends annual inspections (charged) of the Network Master by an Anritsu Customer Service Center.

For other usage notes, read the safety-related information in this manual thoroughly before use.

Chapter 2 General Operation

This chapter describes the general system operation and setup.

2.1	Power Up/Power Down.....	2-3
2.1.1	Power Up.....	2-3
2.1.2	Power Down	2-3
2.1.3	Temperature Monitoring	2-4
2.2	General Functions	2-5
2.2.1	Top Menu	2-5
2.2.2	Auto Launch Pop-up.....	2-5
2.2.3	Mass Storage Menu	2-5
2.2.4	Launching Applications	2-5
2.2.5	General Functions Pop-Up Menu.....	2-6
2.2.6	Setup	2-8
2.2.7	Help Function	2-10
2.2.8	About Function	2-11
2.2.9	Set to Defaults	2-11
2.3	Mass Storage.....	2-13
2.3.1	Creating New Folder.....	2-14
2.3.2	Deleting File.....	2-15
2.3.3	Deleting Multiple Files	2-16
2.3.4	Copying File.....	2-17
2.3.5	Copying Multiple Files	2-18
2.3.6	Renaming File or Folder	2-19
2.4	Print Screen	2-20
2.5	Status Screen	2-21
2.5.1	Basic.....	2-22
2.5.2	ETH.....	2-23
2.5.3	IP	2-24
2.5.4	SFP.....	2-25
2.5.5	Top Bar.....	2-25
2.6	Result Screens.....	2-27
2.6.1	Result overview	2-27
2.6.2	Summary	2-29
2.6.3	Event Log	2-30
2.6.4	Statistics	2-31
2.7	Save and Load.....	2-33
2.7.1	Save Setup	2-33
2.7.2	Load Setup	2-34
2.7.3	Save Results	2-36
2.7.4	Load Results.....	2-39
2.8	Setup.....	2-40
2.8.1	Intelligent Setup.....	2-40

2.9	Test Reports	2-42
2.9.1	Setup	2-43
2.9.2	Generating a report	2-46

2.1 Power Up/Power Down

2.1.1 Power Up

Press the **Menu/Power** key. The Network Master performs a brief self-test during which the Anritsu splash screen is displayed before changing to the Top Menu screen.

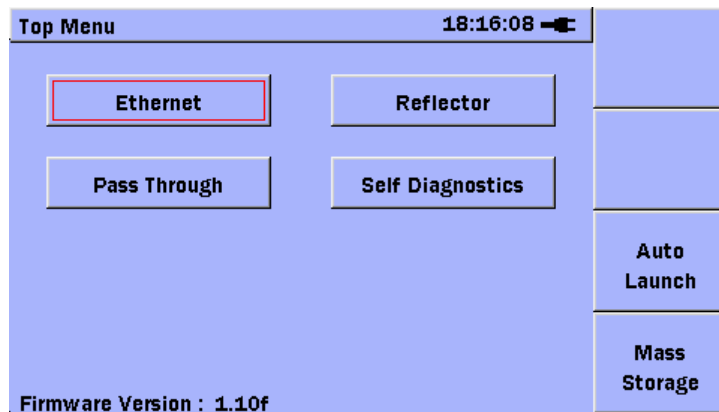

Figure 2.1.1-1 Top Menu Screen



CAUTION

If a screen similar to the one shown above is not displayed after power up, the Network Master may have failed the self-test. Switch the unit off and on (power down/power up) again. If the problem persists, contact the Anritsu Technical Support Center or your local Anritsu representative.

2.1.2 Power Down

1. Press the **Menu/Power** key to display a pop-up menu.
2. Use the **Down** arrow key to highlight **Power Down** in the menu.
3. Press the **Set** key to accept the highlighted menu selection. The following message appears: "Are you sure you want to Power Down?"
4. Highlight **Yes** and press the **Set** key.

Forcibly Power Down at any time by pressing the **Menu/Power** key for 10 s.

2.1.3 Temperature Monitoring

The temperatures of the instrument and any connected SFP modules are monitored.

Note:

The temperature of the SFP module is only monitored if the module complies with the SFP Transceiver MultiSource Agreement and has integrated digital diagnostic monitoring functions.

If the temperature of the instrument or one of the SFP modules reaches its maximum specified value, the instrument will automatically power down. Before this happens a pop-up temperature alarm dialog is displayed to notify that a power down is imminent (Figure 2.1.3-1).

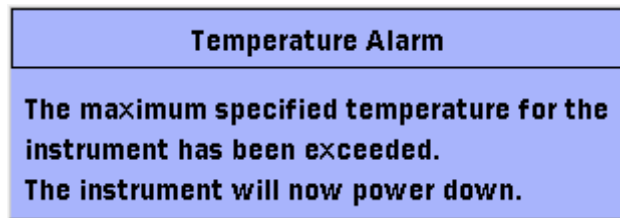

Figure 2.1.3-1 Temperature Alarm Pop-up Dialog

The pop-up dialog indicates whether the instrument or one of the SFP modules has reached the maximum temperature.

Note:

There is a 4-second delay from displaying the pop-up dialog until power down is started.

2.2 General Functions

2.2.1 Top Menu

The Top Menu provides access to:

- The Ethernet application
- The Reflector application
- The Self Diagnostics application
- The Pass Through application
- The Auto Launch pop-up by pressing the **F3** key
- The Mass Storage menu by pressing the **F4** key
- The General Functions pop-up menu by pressing the **Menu/Power** key

2.2.2 Auto Launch Pop-up

At the Top Menu, press **Auto Launch (F3)**. The Auto Launch screen is displayed. From this screen the Auto Launch feature can be enabled and an application can be selected that will launch automatically upon power-up.

2.2.3 Mass Storage Menu

At the Top Menu, press **Mass Storage (F4)**. The Mass Storage screen is displayed in the File Operations mode, to copy, delete, or rename files, as well as to create new folders.

2.2.4 Launching Applications

1. At the Top Menu, use the **Left/Right/Up/Down** arrow keys to highlight the application to launch and press the **Set** key.
2. The Top Menu screen closes and the selected application is launched.

2.2.5 General Functions Pop-Up Menu

Press the **Menu/Power** key to display the General Functions pop-up menu.

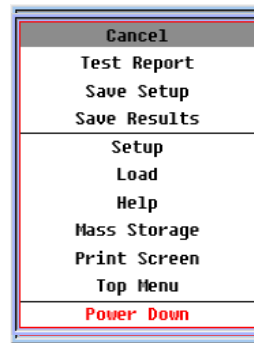

Figure 2.2.5-1 General Functions Pop-up Menu

This menu provides access to the following:

Some items will not be displayed according to the usage conditions.

- | | |
|---------------------|--|
| Test Report | Generates a report file of the results that are currently in memory. Available on the Result overview and on the specific result screens. CSV and PDF formats are available. |
| Save Setup | Opens Mass Storage screen in Save mode to save setup file
Only visible when test not running and not from Top Menu
Refer to 2.7.1 “Save Setup” for further details. |
| Save Results | Opens Mass Storage screen in Save mode to save results file
Only visible when test not running and not from Top Menu
Refer to 2.7.3 “Save Results” for further details. |
| Setup | Accesses general setup for the Network Master
Only visible from Top Menu |
| Load | Opens Mass Storage screen in Load mode to load setup or result file
Only visible when test not running and not from Top Menu
Refer to 2.7.2 “Load Setup” and 2.7.4 “Load Results” for further details. |
| Help | Displays help for current screen |

Mass Storage	Opens Mass Storage screen in File Operations mode, to copy, delete, or rename files, as well as to create new folders
Print Screen	Captures current screen as an image file (in the currently selected image format) to internal memory
Top Menu	Closes currently running application and opens Top Menu screen
Power Down	Starts power down

2.2.6 Setup

Use the following procedure to access the Setup screen

1. With the Network Master powered up, press the **Menu/Power** key at the Top Menu. The General Functions pop-up menu is displayed with **Setup** highlighted.
2. Press the **Set** key. The Basic Tab of the Setup screen is displayed.

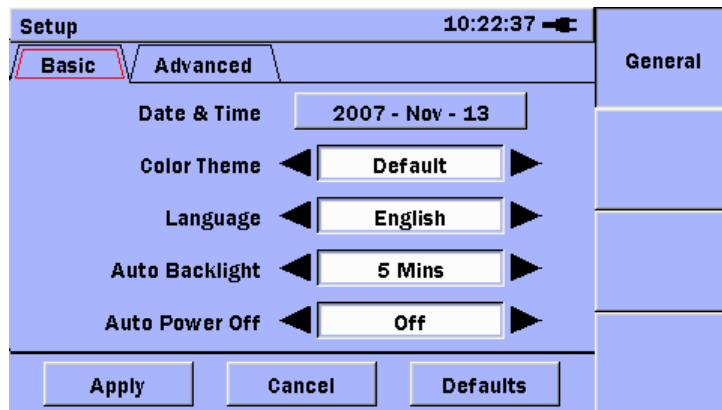

Figure 2.2.6-1 Setup screen, Basic Tab

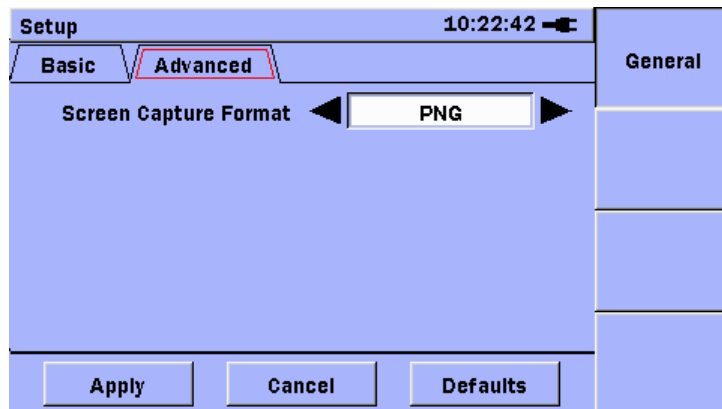

Figure 2.2.6-2 Setup screen, Advanced Tab

3. Use the **Up** and **Down** arrow keys to highlight **Date & Time**.
 - (a) Press the **Set** key. The Date and Time dialog box is displayed. Use the **Left** and **Right** arrow keys to highlight the required selection.
 - (b) Use the **Up** and **Down** arrow keys to scroll to the desired setting.
 - (c) Repeat steps 3(a) and 3(b) until the required date and time are displayed in the dialog box.
 - (d) Press **OK (F1)** to accept the new date and time setting.
4. Highlight **Color Theme** and use the **Left** and **Right** arrow keys to scroll to the required color theme.
5. Highlight **Language** and use the **Left** and **Right** arrow keys to scroll to the required language.
6. Highlight **Auto Backlight** and use the **Left** and **Right** arrow keys to scroll to the required time interval to turn off the backlight automatically when no keys have been pressed. Press any key to restore the backlight. This function is active only when the instrument is battery powered.
7. Highlight **Auto Power Off** and then use the **Left** and **Right** arrow keys to scroll to the desired time interval to automatically power down the Network Master when no keys have been pressed. This function is active only when the instrument is battery powered.
8. Highlight **Apply** and press the **Set** key to apply the displayed general settings.
9. Use the **Up**, **Down**, **Left** and **Right** arrow keys to highlight the **Advanced** tab.
10. Highlight **Screen Capture Format** and use the **Left** and **Right** arrow keys to scroll to the desired format.
11. Highlight **Apply** and press the **Set** key to apply the displayed setting.

2.2.7 Help Function

Basic help information is available in the Setup screens and the Top Menu.

To access Help:

1. Press the **Menu/Power** key in any of the Setup screens or the Top Menu screen.
2. Highlight **Help** in the pop-up menu.
3. Press the **Set** key. The bottom half of the screen displays a dialog containing the help.
4. Press the **Set** key again to close the dialog box.

2.2.8 About Function

The About Function accesses the Version/Serial Number Information window listing the framework and test application software version levels, as well as the serial numbers of the Controller and Module.

To access the Version/Serial number information:

1. Press the **Menu/Power** key in the Setup screens.
2. Select **About** from the pop-up menu and press the **Set** key.
3. The Version/Serial number info window is displayed.
4. Review the information in the window and then
 - (a) With **OK** highlighted, press the **Set** key to close the windowOr
 - (b) Highlight **Save** and press the **Set** key. The version information is saved to a text file in the Data folder and the window closes.

2.2.9 Set to Defaults

Use the following procedure to return to the factory default settings.

To reset the General Setup defaults from the Top Menu:

1. Press the **Menu/Power** key.
2. Highlight **Setup** at the pop-up menu and press the **Set** key. The General Setup appears.
3. Highlight **Defaults** and press the **Set** key.
4. Highlight **Apply** and press the **Set** key. The Setup defaults are now set and the Top Menu screen is re-displayed.

Note:

The application-specific setup remains unchanged.

Note:

As of the current software release, the **Auto Backlight** and **Auto Power Off** parameters are the only **General Setup** parameters re-set via the **Defaults** button.

To set the application-specific setups to factory default from the Top Menu:

1. Highlight the application to be reset.
2. Press the **Set** key to start the application.
3. Press the **Menu/Power** key.
4. Highlight Load at the pop-up menu and press the **Set** key.
5. Set **Device** to **Internal** and **Folder** to /data/
6. Highlight **factory_default.cfg**.
7. Press **LOAD SETUP** (F1).

Note:

Only the currently active application is reset to factory default any other application remain unchanged.

2.3 Mass Storage

The Mass Storage selection accesses to the following file operations:

- Creating new folder
- Deleting files
- Copying files
- Renaming files

To access the Mass Storage file operations from an application:

1. Press the **Menu/Power** key. The General Functions pop-up menu is displayed.
2. Highlight **Mass Storage** and press the **Set** key. The Mass Storage File Operations screen is displayed.

To access the Mass Storage file operations from the Top Menu:

1. Press **Mass Storage (F4)**.

Mass Storage		15:44:14	File Operations
Device :	◀ Internal ▶		
Folder:	/Data/		
Files		Date	Multi-Select
[..]			Off
7-7-2007@17-56-58.bmp		2007-7-7	
9-14-2007@15-3-58.bmp		2007-9-14	
Versions.txt		2007-7-5	
drift0.drtt		2007-7-16	
drift001.drtt		2007-9-14	
factory.options		2007-7-24	Exit

Figure 2.3-1 Mass Storage – In File Operations Mode

2.3.1 Creating New Folder

Use the following procedure to create a new folder at the Mass Storage File Operations screen.

1. Access the Mass Storage screen in the File Operations mode.
2. With the **Device** field highlighted, use the **Left and Right** arrow keys to select the mass storage device: **Internal** or **USB**.

If no USB device is connected to the Network Master, the selection is set automatically to **Internal**.

3. Select the location for the new folder.
4. Press **File Operations (F1)**. The File Operations pop-up menu is displayed with the **New Folder** selection highlighted.
5. Press the **Set** key. The pop-up menu closes and a folder named "newFolder" is added to the current directory.

2.3.2 Deleting File

Use the following procedure to delete a file at the Mass Storage File Operations screen.

1. Access the Mass Storage File Operations screen.
2. With the **Device** field highlighted, use the **Left and Right** arrow keys to select the mass storage device: **Internal** or **USB**.

If no USB device is connected to the Network Master, the selection is set automatically to **Internal**.

3. Navigate to and highlight the required file.
4. Press **File Operations (F1)**. The File Operations pop-up menu is displayed.
5. Highlight **Delete** and press the **Set** key.
6. The Confirm Delete dialog box is displayed. Select **Yes** and press the **Set** key.

The dialog box closes and the file is deleted from the currently displayed directory.

2.3.3 Deleting Multiple Files

Use the following procedure to delete multiple files at the Mass Storage File Operations screen.

1. Access the Mass Storage File Operations screen.
2. With the **Device** field highlighted, use the **Left** and **Right** arrow keys to select the mass storage device: **Internal** or **USB**.

If no USB device is connected to the Network Master, the device selection is set automatically to **Internal**.

3. Navigate to the required directory/folder.
4. Press **Multi-Select Off (F2)**. The red label on the soft key changes to **On** and an empty check box is displayed before each file name in the current directory/folder.
5. Highlight the first file to delete and press the **Set** key. A check mark is displayed in the check box for the highlighted file. Repeat until all the required files are selected and continue to step 6.

Or –

To select all the files in the current folder, press **File Operations (F1)**, highlight **Select All**, press the **Set** key, and continue from step 6.

6. Press **File Operations (F1)** and then highlight **Delete** in the pop-up menu.
7. Press the **Set** key. The Confirm Delete dialog box is displayed.
8. Select **Yes** and press the **Set** key. The selected files are deleted.
9. Press **Exit (F4)** to close the Mass Storage screen.

2.3.4 Copying File

Use the following procedure to copy a file at the Mass Storage File Operations screen.

1. Access the Mass Storage File Operations screen.
2. With the **Device** field highlighted, use the **Left** and **Right** arrow keys to select the mass storage device: **Internal** or **USB**.

If no USB device is connected to the Network Master, the device selection is set automatically to **Internal**.

3. Navigate to and highlight the required file.
4. Press **File Operations (F1)**. The File Operations pop-up menu is displayed.
5. Highlight **Copy** and press the **Set** key. The Destination window is displayed in front of the Mass Storage File Operations screen.

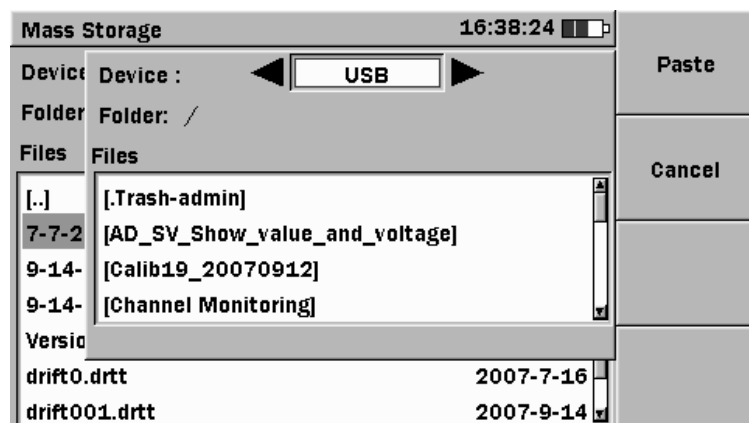

Figure 2.3.4-1 Mass Storage Screen with Destination Window

6. With the **Device** field highlighted, use the **Left** and **Right** arrow keys to select the mass storage device: **Internal** or **USB**.
- If no USB device is connected to the Network Master, the device selection is set automatically to **Internal**.
7. Navigate to the required destination.
 8. Press **Paste (F1)**. The Copied File(s) dialog is displayed. Confirm that the file has been pasted to the required location and press the **Set** key to close the dialog box and return to the Mass Storage screen.
 9. Press **Exit (F4)** to close the Mass Storage screen.

2.3.5 Copying Multiple Files

Use the following procedure to copy multiple files in the Mass Storage File Operations screen.

1. Access the Mass Storage File Operations screen.
2. With the **Device** field highlighted, use the **Left** and **Right** arrow keys to select the mass storage device: **Internal** or **USB**.

If no USB device is connected to the Network Master, the device selection is set automatically to **Internal**.

3. Navigate to the required directory/folder.
4. Press **Multi-Select Off (F2)**. The red label on the soft key changes to **On** and an empty check box is displayed before each file name in the current directory/folder.
5. Highlight the first file to copy and press the **Set** key. A check mark is displayed in the check box for the highlighted file. Repeat until all the required files are selected and continue from step 6.

Or –

To select all the files in the current folder, press **File Operations (F1)**, highlight **Select All**, press the **Set** key and then continue from step 6.

6. Press **File Operations (F1)**. The File Operations pop-up menu is displayed.
7. Highlight **Copy** and press the **Set** key. The Destination window is displayed in front of the Mass Storage File Operations screen.
8. With the **Device** field highlighted, use the **Left** and **Right** arrow keys to select the mass storage device: **Internal** or **USB**.
If no USB device is connected to the Network Master, the device selection is set automatically to **Internal**.
9. Navigate to the required destination.
10. Press **Paste (F1)**. The Copied File(s) dialog is displayed. Confirm that the files have been pasted to the required location and press the **Set** key to close the dialog and return to the Mass Storage screen.
11. Press **Exit (F4)** to close the Mass Storage screen.

WARNING

When copying a file from one folder to another folder, there is no warning message even if there is a file with the same name in the destination folder. The old file will be overwritten.

2.3.6 Renaming File or Folder

Data files and folders can be renamed by accessing the **Rename** function at the Mass Storage File Operations screen.

1. Access the Mass Storage File Operations screen.
2. With the **Device** field highlighted, use the **Left** and **Right** arrow keys to select the mass storage device: **Internal** or **USB**.

If no USB device is connected to the Network Master, the device selection is set automatically to **Internal**.

3. Navigate to and highlight the required file or folder.
4. Press **File Operations (F1)**. The File Operations pop-up menu is displayed.
5. Highlight **Rename** and press the **Set** key. The soft keyboard screen is displayed.
 - (a) Use the **BKSP soft key (F2)** to clear the entry in the name field.
 - (b) Use the **Left/Right/Up/Down** arrow keys to highlight the required letter in the character matrix.
 - (c) Press the **Set** key to add the highlighted letter to the name field.
 - (d) Repeat steps 5(b) and 5(c) to complete the file/folder name.
6. When the file/folder name is completed, press **OK (F4)**. The file/folder is saved with the new name and the unit returns to the Mass Storage screen.
7. Press **Exit (F4)** to close the Mass Storage screen.

2.4 Print Screen

Use the Print Screen function to capture the current screen (screen dump) as an image file using the currently selected format (see Section 2.2.6 “Setup”). Image files are saved in the Internal Data directory.

1. With the screen to be printed displayed, press the **Menu/Power** key. A pop-up menu is displayed.
2. Highlight **Print Screen** and press the **Set** key.
3. The Print Screen Complete dialog box is displayed in 2 or 3 seconds. Press the **Set** key to save the image file to the Data folder in internal memory.

Screen dumps are given a file name automatically with the following format:

YYYY-MM-DD@HH-MM-SS.bmp

YYYY	= Year
MM	= Month
DD	= Day
HH	= Hour, 24-hour clock
MM	= Minutes
SS	= Seconds

For example 2008-12-31@23-59-59.bmp

2.5 Status Screen

When starting the **Ethernet**, the **Reflector**, or the **Pass Through** application, the **Status** screen is displayed to give a quick overview of the current traffic and link status. The **Status** screen consists of the following tabs:

- **Basic**
- **ETH**
- **IP**
- **SFP** (only for MU909060A1 and MU909060A3)

They are explained in the following sections together with the **Top bar**. To toggle between tabs use the **Left** and **Right** arrow keys.

2.5.1 Basic

The Basic tab is the first tab (Figure 2.5.1-1) that is displayed when starting an application (either **Ethernet**, **Reflector** or **Pass Through**). This tab gives an overview of what connectors the hardware has and information about link speed, mode and time.

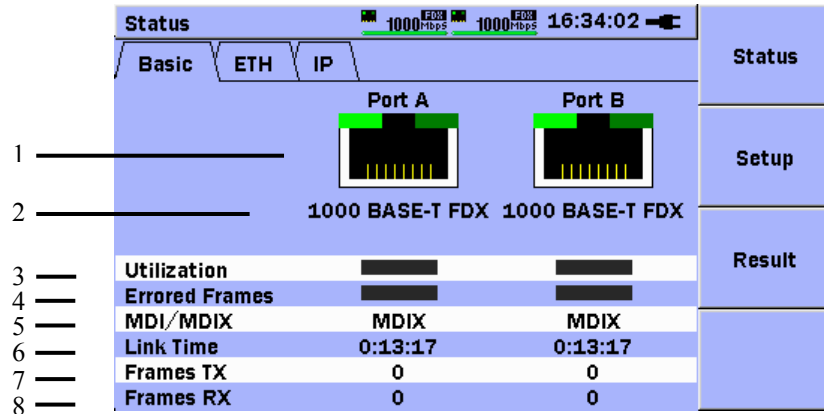

Figure 2.5.1-1 Status (Basic)

- [1] The picture shows the type of physical connector used by the Network Master; the above shows two RJ-45 connectors. The two states of the SFP connector are shown below.



SFP slot with module



SFP slot without module

- [2] This shows the link speed and half (**HDX**) or full (**FDX**) duplex link mode.
- [3] This shows the current utilization as a percentage.
- [4] This shows the percentages of incoming frames with errors.
- [5] This shows the pin/pair crossing and what standard the current link is using.
- [6] This shows the elapsed link time for the two ports.
- [7] This shows the total transmitted frames.
- [8] This shows the total received frames.

Note:

Timers/counters used in items 6, 7, and 8 above are reset when the link is lost.

2.5.2 ETH

The **ETH** tab (Figure 2.5.2-1) shows an overview of the link auto negotiation status, the capabilities of the link partners, and faults occurring during linkup if any.

Status		1000 Mbps		1000 Mbps		12:07:51	
Basic		ETH		IP		Status	
		Port A		Port B		Setup	
Link Partner abilities:						Result	
1	Auto Negotiation Complete:	●	●	●	●		
2	Pause Capable:	●	●	●	●		
3	Asymmetric Pause Request:	●	●	●	●		
4	Remote Fault:	●	●	●	●		
5	Local Clock:	Slave		Master			
6	Speed FDX:	10	100	1000	10	100	1000
7	Speed HDX:	10	100		10	100	

Figure 2.5.2-1 Status (ETH)

- [1] This display goes green when auto negotiation is completed.
- [2] This display goes green if the link partner has MAC pause implemented.
- [3] This display goes green if the link partner supports asymmetric pause.
- [4] This display goes red when an error is discovered at the link partner.
- [5] This displays whether the port is master or slave; it is supported only for 1000 Mbps.
- [6] This displays possible link speeds for full duplex (FDX).
- [7] This displays possible link speeds for half duplex (HDX).

2.5.3 IP

The **IP** tab (Figure 2.5.3-1) shows an overview of the IP and DNS status; the following information is displayed for one stream at both ports and only for IPv4:

- IP
- Gateway
- Network Mask
- DNS
- Lease time when DHCP lookup enabled

Note:

When IPv6 is enabled, only the source IP is displayed.

If the multi-stream option is installed, a stream can be selected using the Stream soft key (F4) at the bottom of the soft key menu.

Status		1000Mbps 1000Mbps 13:37:02		Status
Basic		ETH		IP
IP/DHCP Info:				
Port A (IPv4)	IP Address:	192.168.1.10		Setup
	Gateway:	192.168.1.1		
	Network Mask:	255.255.255.0		
	DNS Pri Server:	0.0.0.0		Result
	DNS Sec Server:	0.0.0.0		
	Lease Renew Time:	N/A		
Port B (IPv4)	Lease Expire Time:	N/A		Stream
	IP Address:	192.168.1.10		
	Gateway:	192.168.1.1		
	Network Mask:	255.255.255.0		
	DNS Pri Server:	0.0.0.0		
	DNS Sec Server:	0.0.0.0		
Lease Renew Time:	N/A		1	
Lease Expire Time:	N/A			

Figure 2.5.3-1 Status (IP)

2.5.4 SFP

The **SFP** tab (Figure 2.5.4-1) is only available when the Network Master has SFP slot(s). This tab displays hardware information for the supported SFP modules.

Status			1000Mbps		1000Mbps		01:23:35	
Basic	ETH	IP	SFP		Status			
			Port A	Port B	Setup			
Module present			2	2	Result			
Vendor	PHOTON		FIBERXON INC.					
Laser wavelength	850 nm		850 nm					
Bit rate (nominal)	1200 Mbps		1300 Mbps					
ETH Compliance	1000BASE-SX		1000BASE-SX					
Length, 9um SM	N/A		N/A					
Length, 50um SM	550 m		550 m					
Length, 63um SM	270 m		270 m					
Length, Copper	N/A		N/A					
Power TX	-6.1 dBm		-5.1 dBm					
Power RX	-18.7 dBm		-17.3 dBm					

Figure 2.5.4-1 Status (SFP)













2.5.5 Top Bar

The Top bar (Figure 2.5.5-1) is shared by all screens and consists of six sections.



Figure 2.5.5-1 Top Bar

- [1] This displays the title of the current screen.
- [2] A rotating star indicates that a test is running.
- [3] This indicates that incoming traffic is being filtered.
- [4] This indicates the port hardware and link for Port A and Port B. The port type is indicated by the following icons.

Link Type	RJ-45 electrical  SFP Optical 
Link Speed	 Link disabled  10Mbps  100Mbps  1000Mbps
Duplex	 Full Duplex  Half Duplex
Link Status	 Link Disabled  Signal. No alarms and no errors present.  Alarms or errors present.  Auto-negotiation failed or frame errors (bit pattern or sequence)

[5] This indicates the time using the 24-hour clock.

[6] This displays the power status.

(a) The Network Master is connected to the AC power adapter



(b) The Network Master is operating on battery .

Note:

The Network Master must be off to charge the battery.

2.6 Result Screens

2.6.1 Result overview

The **Result overview** screen is displayed automatically when a test is started by pressing the **Start** key or when test results are loaded as described in 2.7.4 “Load Results”.

The **Result overview** screen can also be accessed manually by pressing the **Result soft key (F3)** on the general soft key panel displayed on the **Status** and **Test Automator** screens.

The **Test Automator** screen can be accessed by pressing the **Setup soft key (F2)**.

If no test is running or no test has been started since the Ethernet application was selected at the **Top Menu**, the **Result overview** screen is blank.

Result overview				Status
State	Result	Test schedule	dd:hh:mm:ss	
●	PASS	Y.1564 Suite 1	00:00:00:12	Setup
				Result
				Summary

Figure 2.6.1-1 Result overview Screen with Test Schedule

The test schedule displayed on the **Result overview** screen is similar to the test schedule setup on the **Test Automator** screen. An LED at the left of each test shows the test status as follows:

- A grey (blinking) LED indicates the running test.
- A green LED indicates that the test has been completed successfully without errors.
- A red LED indicates that the test has completed, but an error occurred during the test.
- A black LED indicates that the test has not yet been executed.

If a ● red LED indication is shown, refer to Table 2.6.1-1 below for a list of possible causes.

Table 2.6.1-1 Conditions Causing a Red State LED

Condition	Description.
No ports active	The ports defined for the test to run are not enabled.
Link is down	The link for the port is down
ARP failure	The test is defined to use ARP, and the ARP cannot be resolved
RFC End to End communication failure.	The A & B units cannot successfully transmit or receive RFC communication frames.
FTP/HTTP Download	Abnormal processing message (condition). See section 3.9.2.
Test terminated	The test was stopped by the user before it finished.

To access a more detailed result screen for the individual tests in the test schedule, navigate to the required test using the **Up** and **Down** arrow keys and press the **Set** key.

The **Result overview** screen also includes a **Result** column that shows PASS/FAIL indication if thresholds are setup and enabled for the test.

PASS none of the active thresholds were violated.

FAIL at least one active threshold was violated.

---- no thresholds are enabled for the test

The elapsed time for the execution of each test is displayed under the dd:hh:mm:ss column as shown in Figure 2.6.1-1 above.

2.6.2 Summary

When the test schedule is executed, in addition to displaying the **Result overview** screen, a **Summary** screen (Figure 2.6.2-1) is displayed for viewing the event log and detailed statistics about the frames and errors received during execution of the tests in the schedule.

Time	Description
06:37:45 Mon Apr 27 2009	Test started
06:37:45	Generator test started
06:37:58	Generator test stopped
06:38:00 Mon Apr 27 2009	Test stopped

Figure 2.6.2-1 Summary Screen – Event Log Tab

To display the **Summary** screen, press the **Summary** soft key (**F4**) on the **Result overview** screen or the specific test result screens. Press the **Back** soft key (**F1**) to return to the previous screen.

Note:

The **Summary** screen is shared by all tests in the test schedule.

Use the **Left** and **Right** arrow keys to toggle between the tabs on the **Summary** screen.

2.6.3 Event Log

The event log is found at the **Event Log** tab on the **Summary** screen.

All relevant events and threshold violations occurring during execution of tests in the test schedule are recorded in the event log. Each event includes a time stamp with 1-second resolution in the format HH:MM:SS and a text description of the event.

- HH = Hour, 24-hour clock
- MM = Minutes
- SS = Seconds

Threshold violations are indicated as shown in the text below:

Timestamp:violation:threshold name:port:stream:(value that exceeded the threshold)

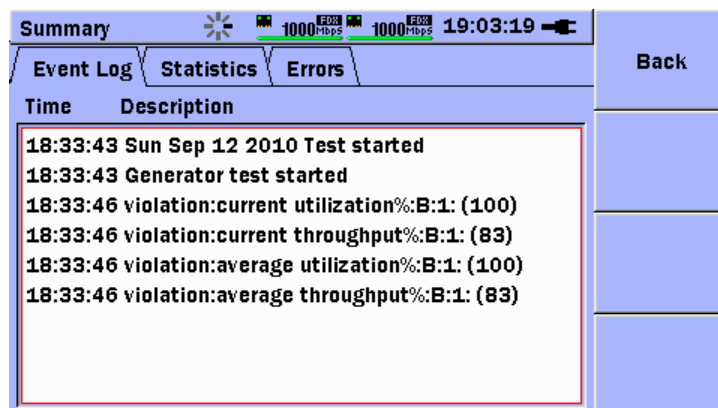

Figure 2.6.3-1 Summary Screen – Event Log/Violations

The event log is cleared at the start of execution of the test schedule and has the capacity to hold one thousand (1000) records. See section 3.2.5 (General Setup) for the setup selection that controls how error logging is processed should the event log become full during the execution of the test schedule.

2.6.4 Statistics

During execution of tests in the test schedule, detailed frame statistics are calculated and displayed at the **Statistics** tab on the **Summary** screen.

	Port A	Port B
Total	0	0
Unicast	0	0
Multicast	0	0
Broadcast	0	0
UnTagged Frames	0	0
Single VLAN Frames	0	0
Multiple VLAN Frames	0	0
UnLabeled Frames	0	0
Single MPLS Frames	0	0
Multiple MPLS Frames	0	0
Pause Frames	0	0

Figure 2.6.4-1 Summary Screen – Statistics Tab

The frame statistics for each port are as follows:

Total	Total number of frames received during test schedule
Unicast	Number of received Unicast frames
Multicast	Number of received Multicast frames
Untagged Frames	Number of received frames with no VLAN tag
Single VLAN Frames	Number of received frames with one VLAN tag
Multiple VLAN Frames	Number of received frames with more than one VLAN tag
Unlabeled Frames	Number of received frames with no MPLS label
Single MPLS Frames	Number of received frames with one MPLS label
Multiple MPLS Frames	Number of received frames with more than one MPLS label
Pause Frames	Number of received pause frames

Summary Off Off 07:45:10				
Event Log	Statistics	Errors		Back
		Part A	Part B	
FCS Errors		0	0	
Fragmented		0	0	
Oversized		0	0	
Undersized		0	0	
Collisions		0	0	
Preamble violations		0	0	
IFG violations		0	0	
Severe IFG violations		-	-	

Figure 2.6.4-2 Summary Screen – Errors Tab

- FCS Errors** Number of frames with Frame Check Sequence (FCS) errors detected during test schedule
- Fragmented** Number of received fragmented frames
- Oversized** Number of received oversized frames
- Undersized** Number of received undersized frames
- Collisions** Number of collisions detected (HDX only)
- Preamble violations** Number of detected Preamble violations
- IFG violations** Number of detected Inter Frame Gap (IFG) violations
- Severe IFG violations** Number of detected severe IFG violations

2.7 Save and Load

2.7.1 Save Setup

When saving a setup, a file containing the Interface setup and Test setup is generated with file extension .cfg. The file name can be set by the user.

To save setup:

1. Press the **Menu/Power** key. The General Functions pop-up menu is displayed.
2. Highlight **Save Setup** and press the **Set** key. The Mass Storage Save screen is displayed.

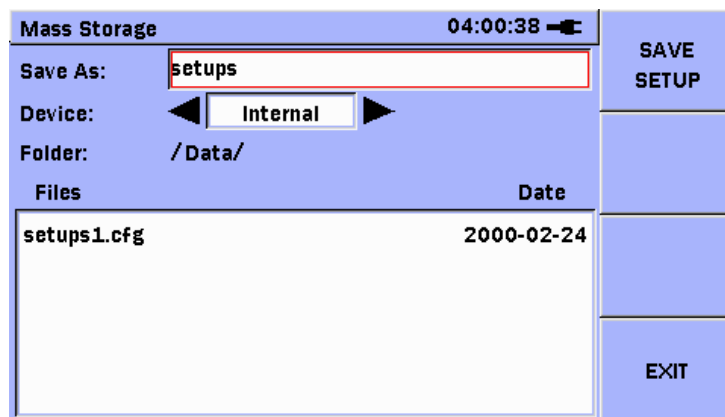

Figure 2.7.1-1 Mass Storage Save Screen

3. To create a file name similar to one that is already saved, use the **Down** arrow key to move the highlight over the saved file name. Otherwise proceed to Step 5.

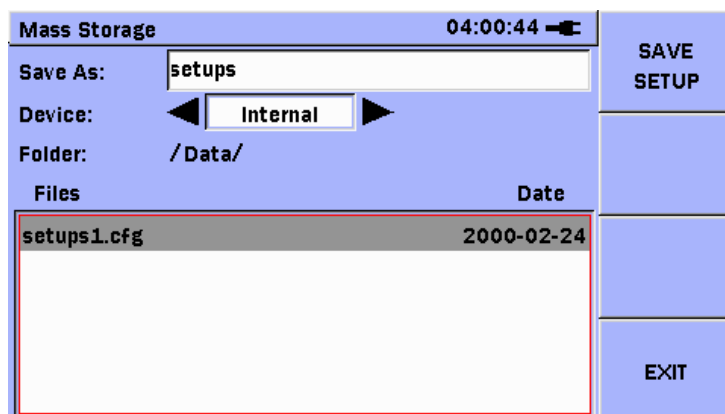

Figure 2.7.1-2 Highlight Existing File

4. Press the **Set** key to copy the highlighted file name to the **Save As** field.

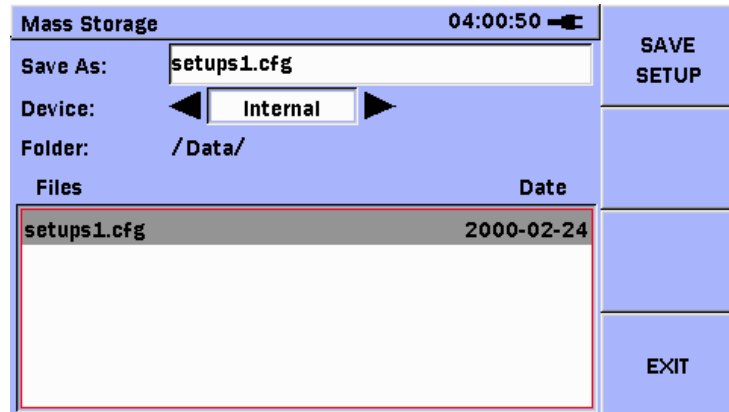

Figure 2.7.1-3 Press the Set key to Copy the File Name

5. If the file name is to be changed, move the highlight to the **Save As** field. Press the **Set** key to display the soft keyboard screen.
6. Use the **Left** and **Right** arrow keys to select the **Device**.
7. Use the **Up** and **Down** arrow keys to select the **Folder** and file.
8. Press **SAVE SETUP** to save (**F1**).

2.7.2 Load Setup

Setups can be loaded from internal memory or from a USB flash drive.

A setup file is supported only by its relevant application, i.e., a setup file created by the Reflector application can only be loaded by the Reflector application.

To load the setup file:

1. Press the **Menu/Power** key. The General Functions pop-up menu is displayed.
2. Highlight **Load** and press the **Set** key. The Mass Storage Load screen is displayed.
3. Use the **Left** and **Right** arrow keys to select the **Device**
4. Use the **Up** and **Down** arrow keys and **Set** key to select the **Folder** and file.
5. When the required file is highlighted, press **LOAD SETUP (F1)** to load it.

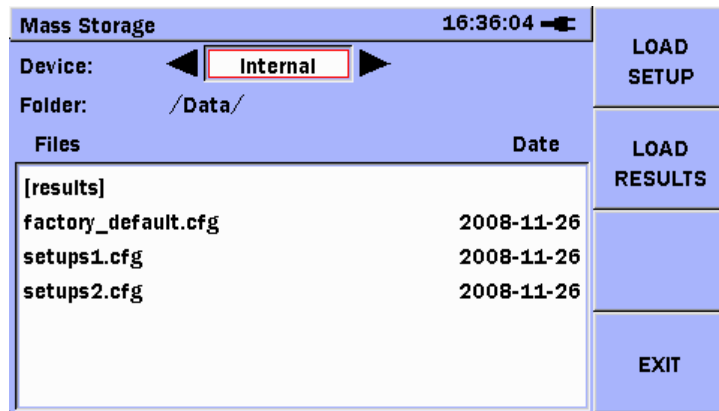

Figure 2.7.2-1 Mass Storage Load Screen

There is a file named “factory_default.cfg” in internal memory. It contains the factory defaults. The factory default file only resets the current application to the factory defaults; it does not reset any other applications.

Notes:

- A setup file can only be loaded by the same application as was used to save it. For example, a Reflector setup file can only be loaded by the Reflector application.
- Loading a setup requires the Network Master to have the same SW options installed as when the setup was first saved. If any options are missing, a pop-up window is displayed, showing the missing SW options.
- It is necessary that test is added at Test Automator after loading a setup file which is created by MU909060A Setup application. For example, since the Y.1564 test is not added on the Test Automator screen after loading the setup file, add the test and start a measurement.

2.7.3 Save Results

By default, when a test schedule is finished or stopped by the user, the results are saved automatically to internal memory.

Note:

The Ethernet application has a user option under the General Setup menu which allows the auto-save function to be disabled. Press **Setup (F2)** to display **General Setup**. If this function is disabled, results must be saved manually as described below.

The path to the results is /Data/results. The extension for saved result files is .res.

The results files are given a file name automatically with the format:

YYYY-MM-DD@HH-MM-SS.res

YYYY	= Year
MM	= Month
DD	= Day
HH	= Hour, 24-hour clock
MM	= Minutes
SS	= Seconds

An example of a file name is 2008-12-31@23-59-59.res.

The time in the file name is the time when the schedule was finished or stopped.

If the memory is full when the auto-save function attempts to save the results, an error message will be displayed as shown in Figure 2.7.3-1 below.

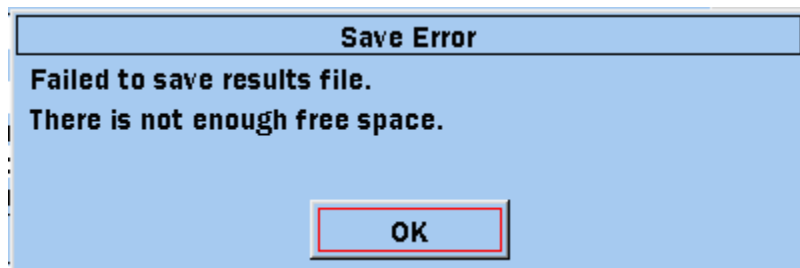

Figure 2.7.3-1 Save Error

In this case the operator can press the **Set** key to release the error message, and then use the **Mass Storage** functions as described in sections 2.3.2 “Deleting File” and 2.3.3 “Deleting Multiple Files” to create some free space on the device.

Once some free space is available, the current test results can be saved manually using the **Save Results** function.

To save results:

1. Press the **Menu/Power** key. The General Functions pop-up menu is displayed.
2. Highlight **Save Results** and press the **Set** key. The Mass Storage Save Results screen is displayed, as shown in Figure 2.7.3-2.
3. The **Save As** field will be highlighted and the filename will be pre-populated in the format described above.

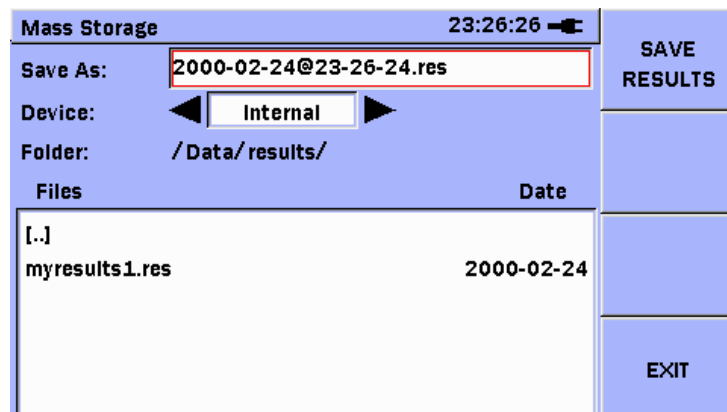

Figure 2.7.3-2 Save Results

4. To create a file name similar to one that is already saved, use the **Down** arrow key to move the highlight over the saved file name. Otherwise proceed to Step 6.

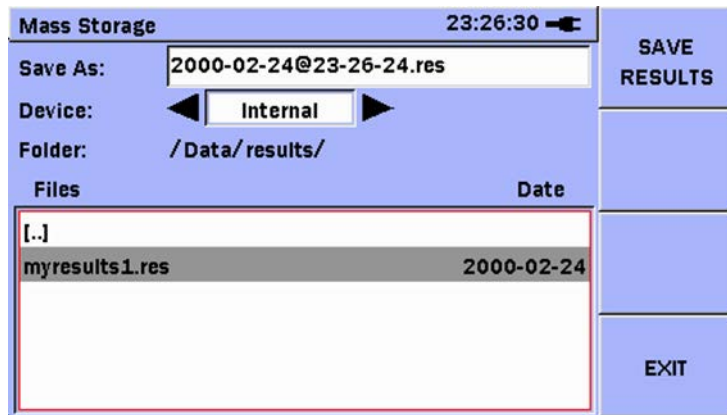

Figure 2.7.3-3 Highlight Existing File

5. Press the **Set** key to copy the highlighted file name to the **Save As** field.

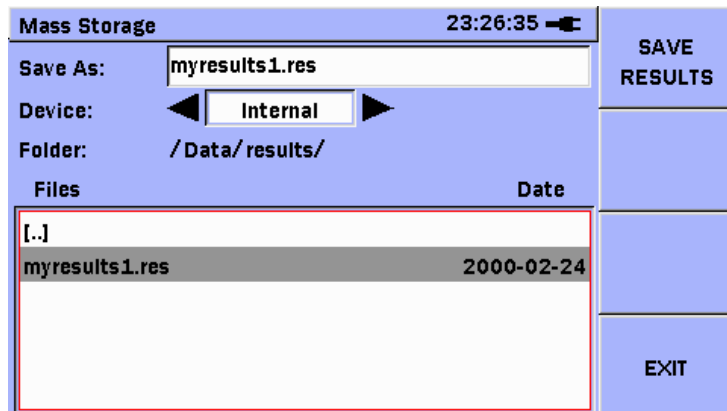

Figure 2.7.3-4 Press the Set key to Copy the File Name

6. To override the filename, move the highlight to the **Save As** field. Press the **Set** key and use the soft keyboard to enter the new filename.
7. Use the **Up** and **Down** arrow keys to access the device field.
8. Use the **Left** and **Right** arrow keys to select the **Device**
9. Press **SAVE RESULTS (F1)** to save the results.

2.7.4 Load Results

Results can be loaded from internal memory or from a USB flash drive.

Loading results reloads the contents on the result screens. Only one result file can be loaded at one time.

When a new result file is loaded, a new result window displays the file contents.

To load a Results file:

1. Press the **Menu/Power** key. The General Functions pop-up menu is displayed.
2. Highlight **Load** and press the **Set** key. The Mass Storage load screen is displayed.
3. Use the **Left** and **Right** arrow keys to select the **Device**.
4. Use the **Up** and **Down** arrow keys to select the **Folder** and file.
5. Press **LOAD RESULTS (F2)** to load the results.

The Load Results screen is the same as the Load Setup screen. See Figure 2.7.1-1.

2.8 Setup

The setup for Network Master Gigabit Ethernet module applications is comprised of several settings, and falls into two categories:

- **Interface setup**
Settings for the instruments Ethernet interfaces.
- **Test setup**
Settings for supported instrument tests.

Settings are controlled via check boxes and pop-up dialogs. The specific settings and how to change them are described in the “**Application Ethernet**” and “**Application Reflector**” sections on pages 3-1 and 4-1, respectively.

2.8.1 Intelligent Setup

Some settings depend on other settings. When these settings are changed, it may be necessary to make additional changes to comply with the required change.

The **Intelligent setup** function bridges the two setup categories. Changes to the **Interface setup** may require changes to the **Test setup** and *vice versa*.

If a setting change requires additional changes, the Dependency pop-up dialog is displayed (Figure 2.8.1-1).

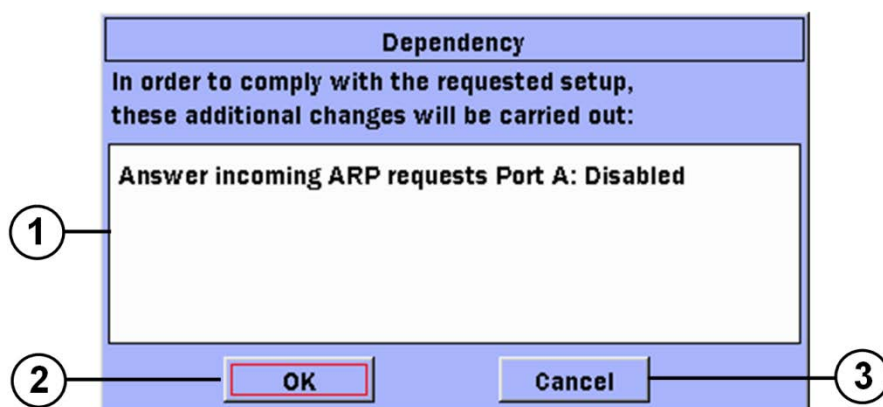

Figure 2.8.1-1 Dependency Pop-up

- [1] This lists the changes that must be enforced before the setting changes can be performed. Use the **Up and Down** arrow keys to scroll through the list.
- [2] Select the **OK** button to change the setting, including all the settings listed in item 1.
- [3] Select the **Cancel** button to cancel the new setting.

2.9 Test Reports

The Network Master is able to generate a test report with the following content:

- Test schedule, setup and results.
- Test statistics and event log.
- Instrument setup.
- User defined comments
- User defined logo (if the PDF format is selected).

The reports can be stored on an USB memory stick or on the internal memory.

To access the **Test Report** screen:

1. Navigate to either the **Result** overview, test specific or **Summary** screen.
2. Press the **Menu/Power** key.
3. Select **Test Report** from the list.

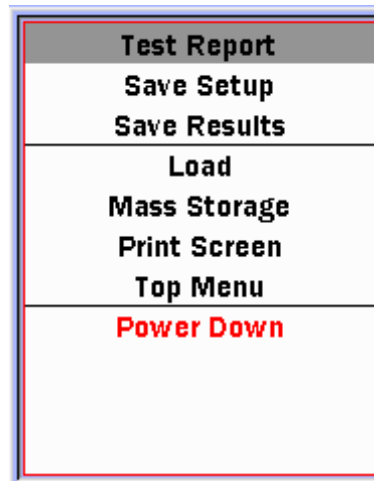

Figure 2.9-1 Menu pop-up with Test Report

Note:

Test Reports are only available in the Ethernet application.

2.9.1 Setup

The **Test Report** screen consists of three tabs:

- Basic
- Comment
- Logo

To navigate between the tabs press the **F2** soft key named **Next Tab**.

Basic

From this tab it is possible to setup what should be included in the report.

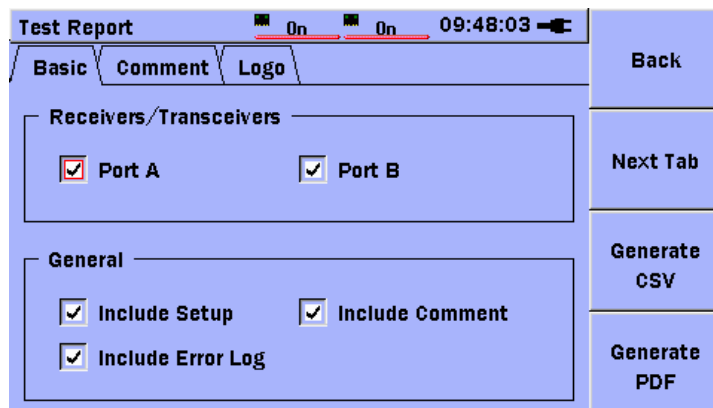

Figure 2.9.1-1 Test Report Basic screen

Receivers/Transceivers	Select which port(s) to include results and setups from.
General – Include Setup	Check if interface and test setups should be included in the report.
General – Include Comment	Check if comments should be included in the report.
General – Include Error Log	Check if the Error Log should be included in the report.

Comment

From this tab it is possible to add comments that will be included on the first page in the report. The comments will only be added if **Include Comment** is checked under the **Basic** tab.

Test Report		On	On	10:25:24
Basic	Comment	Logo	Back	
Customer:	<input type="text"/>	Next Tab		
Project/Description:	<input type="text"/>	Generate CSV		
Operator:	<input type="text"/>	Generate PDF		
Notes:	<input type="text"/>			

Figure 2.9.1-2 Test Report Comment screen

Use the **Up/Down** arrow keys to navigate between the fields and press the **Set** key to edit the content.

Logo

From this tab it is possible to add a logo to the report. The logo will appear in the top left corner of every page of a PDF report.

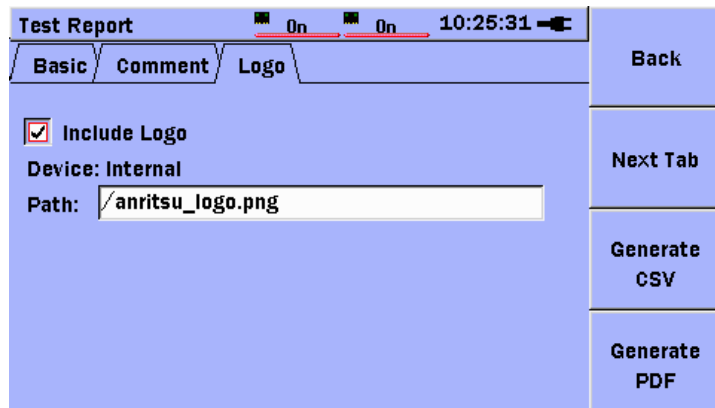

Figure 2.9.1-3 Test Report logo screen

Include Logo

If checked a logo will be included in the report.

Path

Choose a logo. This will open the **Mass Storage** screen. When the desired logo is found press the **F1** soft key to load the image.

Notes:

- The supported image formats are JPG and PNG.
- The logo is not included in the CSV formatted output file.

2.9.2 Generating a report

To generate a report:

1. Press the **Generate CSV** soft key (**F3**) to generate a report in CSV compatible output format.
2. Press the **Generate PDF** soft key (**F4**) to generate a report in PDF output format.
3. Type in the desired name for the report in the **Save As** field.
4. Select **USB** or **Internal** storage in the **Device** field.
5. Navigate to the desired folder.
6. Press the **F1** soft key, called **Save report**, to save the report.

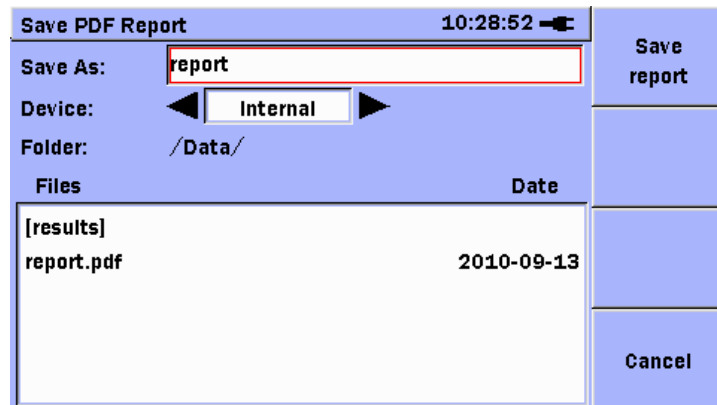

Figure 2.9.2-1 Save PDF report screen

Note:

The PDF file extension (.pdf) is added automatically when Generate PDF is selected.

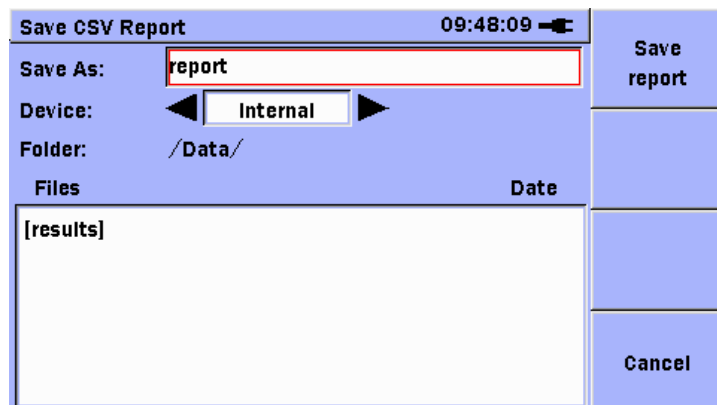

Figure 2.9.2-2 Save CSV Report screen

Note:

The CSV file extension (.csv) is added automatically when Generate CSV is selected.



: 2007-11-14 19:09:20

Generator 1 - Result

Port A	
TX results	Stream 1
TX Total Frames	12.500000 M
TX Total Bytes	1.250000 G
TX Broadcast Frames	0
TX Broadcast Bytes	0
Throughput	76.9231 %
Utilization	92.3077 %

Figure 2.9.2-3 Sample PDF Report

Generator 1 - Result	
Port A	
TX results	Stream 1
TX Total Frames	12.500000 M
TX Total Bytes	1.250000 G
TX Broadcast Frames	0
TX Broadcast Bytes	0
Throughput	76.92%
Utilization	92.31%

Figure 2.9.2-4 Sample CSV Report



Chapter 3 Ethernet Application

This chapter explains the functions of the Ethernet application.

3.1	Application Ethernet Status	3-3
3.2	Application Ethernet Setup	3-4
3.2.1	Interface General Setup	3-5
3.2.2	Interface Filter Setup	3-20
3.2.3	Advanced Setup	3-27
3.2.4	Test Automator	3-29
3.2.5	General Setup	3-33
3.3	Generator Test	3-35
3.3.1	Generator Test Setup	3-35
3.3.2	Generator Test Results	3-54
3.4	BER Test	3-63
3.4.1	BER Test Setup	3-63
3.4.2	BER Test Results	3-65
3.5	Stimuli	3-66
3.5.1	Stimuli Errors and Alarms	3-66
3.5.2	Using Stimuli	3-69
3.6	Ping Test	3-70
3.6.1	Ping Test Setup	3-70
3.6.2	Ping Test Results	3-74
3.7	Cable Test	3-75
3.7.1	Cable Test Setup	3-75
3.7.2	Cable Test Results	3-77
3.8	RFC2544 Tests	3-78
3.8.1	RFC2544 Throughput Test Setup	3-78
3.8.2	RFC2544 Latency Test Setup	3-86
3.8.3	RFC2544 Burst Test Setup	3-91
3.8.4	RFC2544 Tests Results	3-95
3.9	HTTP/FTP Download Test	3-100
3.9.1	HTTP/FTP Download Setup	3-100
3.9.2	HTTP/FTP Download Results	3-104
3.10	Trace Route Test	3-107
3.10.1	Trace Route Setup	3-108
3.10.2	Trace Route Results	3-109
3.11	Y.1564 Suite	3-111
3.11.1	Y.1564 Services	3-112
3.11.2	Y.1564 Suite – Test Configurations	3-113
3.11.3	Y.1564 Suite - Port Setup	3-115
3.11.4	Test Automator – Adding a Y.1564 Test Instance	3-116
3.11.5	Y.1564 Suite – Test Mode Setup	3-117

3.11.6	Y.1564 Suite - Services Setup	3-127
3.11.7	Y.1564 Config Setup	3-173
3.11.8	Y.1564 Perform Setup	3-177
3.11.9	Y.1564 ARP Processing	3-179
3.11.10	Y.1564 Test Flow	3-179
3.11.11	Y.1564 Test Processing	3-180
3.11.12	Y.1564 Suite Global Results	3-187
3.11.13	Y.1564 Config Results	3-190
3.11.14	Y.1564 Perform Results	3-197
3.11.15	Y.1564 Reports	3-202
3.12	Address Wizard	3-205
3.13	OAM Loopback Application	3-215

3.1 Application Ethernet Status

The **Status** screen is the first screen displayed when starting the Ethernet application.

It gives an overview of the current hardware and Ethernet status. For details about the **Status screen** tabs, refer to Section 2.5.

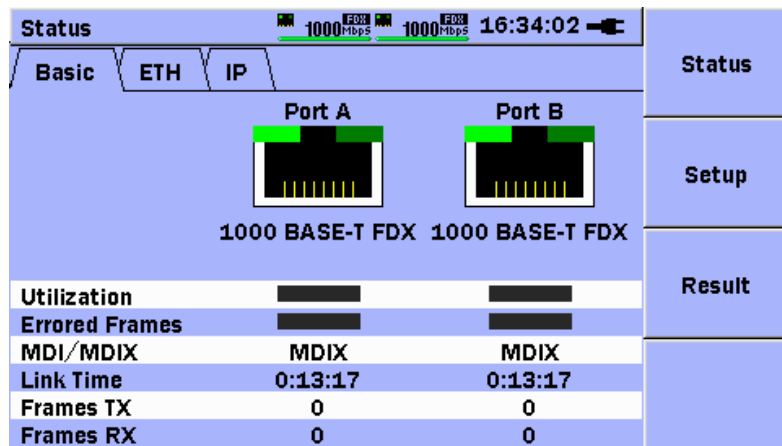

Figure 3.1-1 Status Screen

The three buttons on the right are controlled by the **F1** to **F3** soft keys.

Status	F1	Displays Status screen See Figure 3.1-1.
Setup	F2	Displays /hides Setup selector See 3.2 “Application Ethernet Setup”.
Result	F3	Displays Result overview screen See Section 2.6.1.

3.2 Application Ethernet Setup

There are three different types of setup for the Ethernet application.

- Interface
- Test Automator
- General Setup

Pressing the **F2** soft key displays a selector to select between these three types of setup.

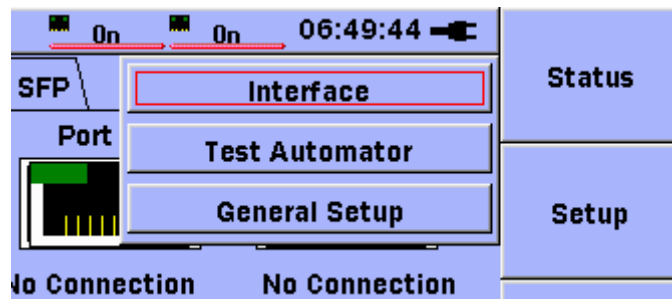

Figure 3.2-1 Setup Selector

The interface setup is where the common setup for all tests are done.

Navigation throughout the interface setup screens are done with the **Up**, **Down**, **Left** and **Right** arrow keys. The red frame in Figure 3.2-1 shows the current selected item. The selection is set by pressing the **Set** key.

3.2.1 Interface General Setup

Preface

Interface setup soft keys

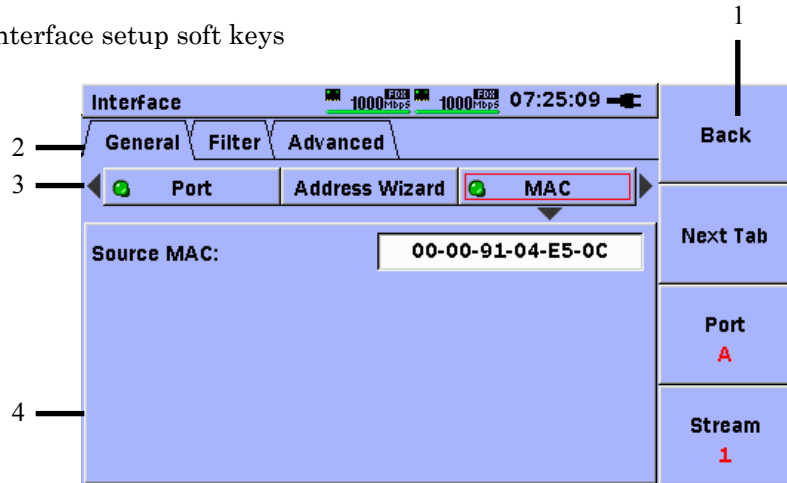



Figure 3.2.1-1 Interface Setup Screen, MAC Setup Pane

[1] Soft keys on **Interface Setup** screen

- Back** Returns to previous screen
- Next Tab** Switches between General, Filter and Advanced setup
- Port A/B** Displays current port and changes port when pressed
- Stream 1 - 8** When the Multistream option is installed, this soft key displays the current stream and selects the stream when pressed.

[2] Tabs for **General**, **Filter** and **Advanced** setup

[3] Sets and displays status of headers in transmitted frames

-  Green indicates that the transmitted frames contains header
-  Black indicates that the transmitted frames will not contain header

Pressing the **Set** key while a header is selected toggles the header on/off.

[4] Pane showing content of configured header or information about header

Port setup pane

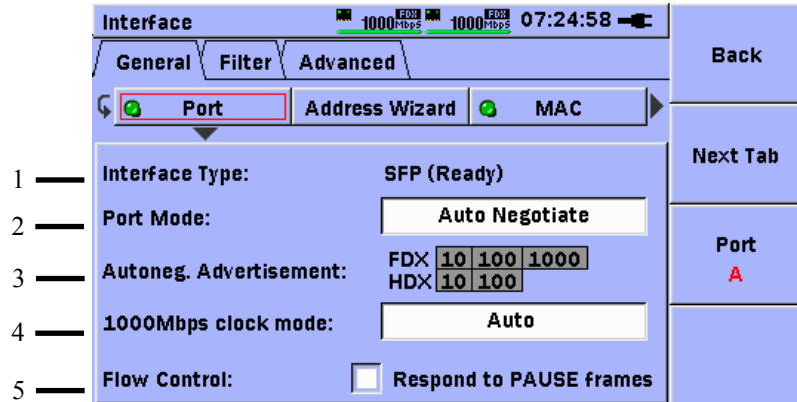

Figure 3.2.1-2 Interface Setup Screen, Port Setup Pane

- [1] Indicates whether port interface is **RJ-45** or **SFP**
- [2] Displays pop-up to select between **Auto Negotiation** and **Forced**
- [3] Displays pop-up to select advertised line speeds and duplexing method during auto negotiation
- [4] Displays pop-up to select required clock mode during 1000 Mbps auto negotiation
- [5] Enables/disables physical layer **Flow Control**

Address Wizard pane

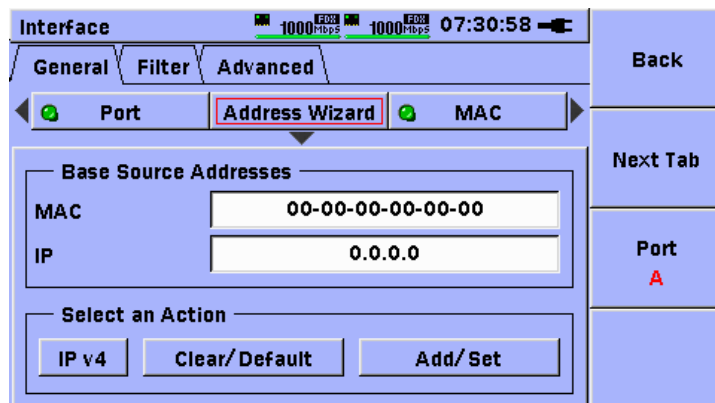

Figure 3.2.1-3 Interface Setup Screen, Address Wizard Pane

The Address Wizard function is available to make the generation of MAC and IP addresses for multiple streams and multiple ports easier. See section 3.12 of this document for a complete description of the Address Wizard function.

MAC setup pane

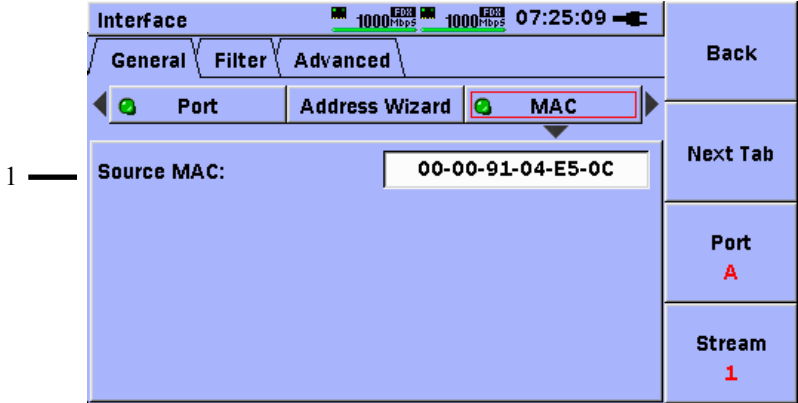

Figure 3.2.1-4 Interface Setup Screen, MAC Setup Pane

- [1] Sets Source MAC address
When the factory defaults are loaded, the Source MAC address is set to the factory-assigned port-specific MAC address. Refer to Section 2.7.2.

Note: Each port has one unique MAC address. When the Multistream option is installed, the same address is set at all streams



VLAN setup pane



Figure 3.2.1-5 Interface Setup Screen, VLAN Setup Pane

- [1] The red frame in Figure 3.2.1-5 shows a [+] symbol which indicates that the fields are currently disabled (LED on the VLAN button is black).

Press the **Set** key to change the symbol to [-] and enable editing the fields, as shown in Figure 3.2.1-6.

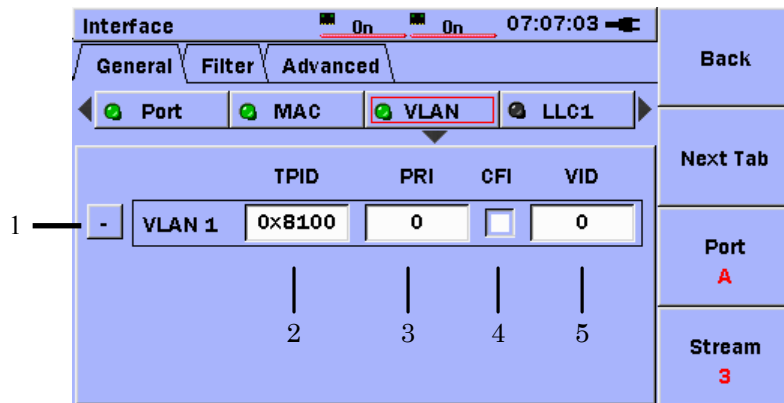

Figure 3.2.1-6 Interface Setup Screen, VLAN Setup Pane

- [1] [-] symbol indicates that VLAN is enabled (LED on the VLAN button is green) and the individual header fields can be selected.
- [2] Sets **VLAN TPID**. Highlight this field and press the **Set** key to see the list of choices.
- [3] Sets **VLAN Priority** Highlight this field and press the **Set** key to edit the value.
- [4] Sets **CFI** (Canonical Format Indicator) **Flag**. Highlight this field and press the **Set** key. If the box is selected, the CFI bit will be set in the VLAN tag.
- [5] Sets **VID** (VLAN ID) value. Highlight this field and press the **Set** key to change the value. Use the **Left/Right** arrow keys to move the cursor over the digits. Use the **Up/Down**-arrow keys to change the digits, as shown in Figure 3.2.1-7 below.

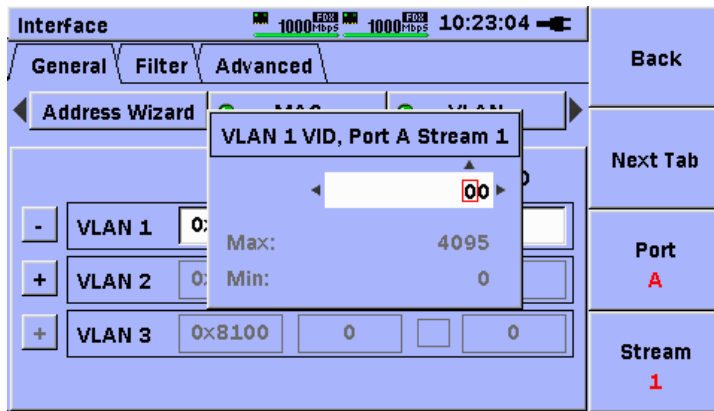

Figure 3.2.1-7 VID Editor

If option MU909060/A1/A2/A3-003 (Stacked VLAN) is installed on the unit, it is possible to define up to three (3) VLAN tags in the same manner as described above. In this case, the VLAN setup pane will appear as shown in Figure 3.2.1-8 below.

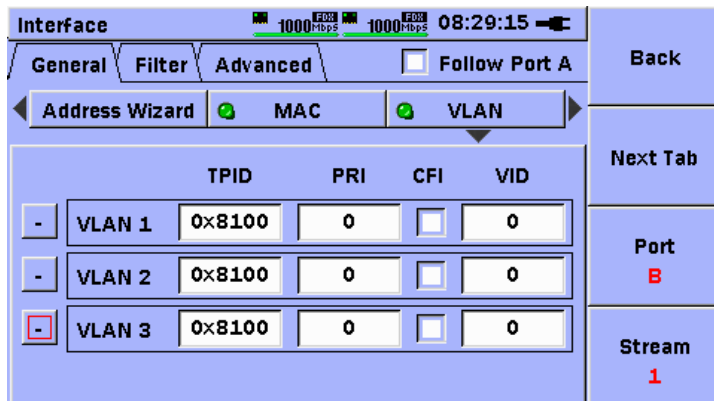

Figure 3.2.1-8 VLAN Setup Pane, Stacked VLAN Option

The VLAN tags will be defined in order 1,2,3, where the higher numbers are the outer most tags (closest to the MAC address in the frame structure) and VLAN 1 is the inner most tag. The tags must be defined in sequence; VLAN 2 cannot be defined before VLAN 1, VLAN 3 cannot be defined before VLAN 2.

Notes:

- The MU909060/A1/A2/A3 supports three (3) frame encapsulations, as shown in the table below. Selection of a frame encapsulation is accomplished by enabling the LLC1/SNAP header combination that corresponds to the encapsulation.

Table 3.2.1-1 Ethernet Frame Encapsulations

Encapsulation	LLC1	SNAP
EtherType II (DIX v.2)	OFF	OFF
IEEE 802.3 with 802.2(LLC1)	ON	OFF
IEEE 802.3 with SNAP	ON	ON

- Setting the SNAP header ON automatically sets the LLC1 header ON. When the SNAP header is ON, setting the LLC1 header to OFF automatically sets the SNAP header to OFF.

LLC1 setup pane

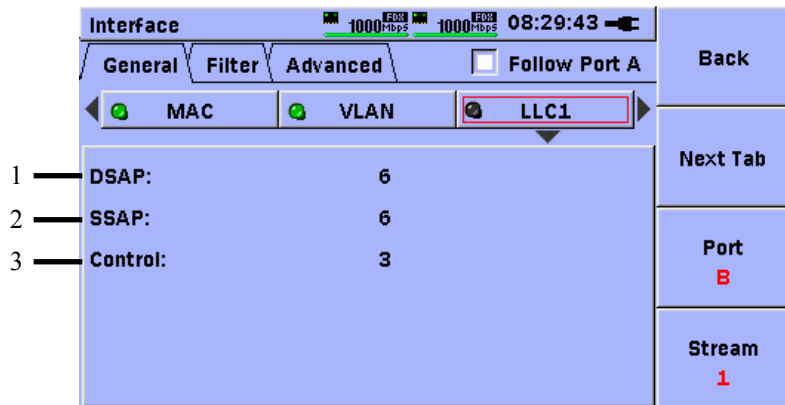

Figure 3.2.1-9 Interface Setup Screen, LLC1 Setup Pane

- [1] Displays value of **DSAP** (Destination Service Access Points) byte
- [2] Displays value of **SSAP** (Source Service Access Points) byte
- [3] Displays value of **Control** byte

SNAP setup pane

The SNAP header can only be inserted when the LLC1 header is present.

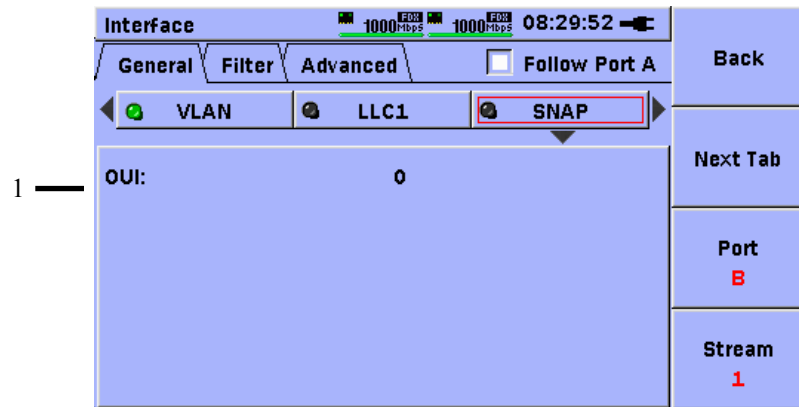

Figure 3.2.1-10 Interface Setup Screen, SNAP Setup Pane

[1] Displays value of OUI (Organization code) header field



MPLS Setup Pane (Option MU909060/A1/A2/A3-004)

If option MU909060/A1/A2/A3-004 (MPLS) is installed on the unit, it is possible to define up to three (3) MPLS labels. In this case, the MPLS setup pane will appear after the SNAP setup pane, as shown in Figure 3.2.1-11 below.

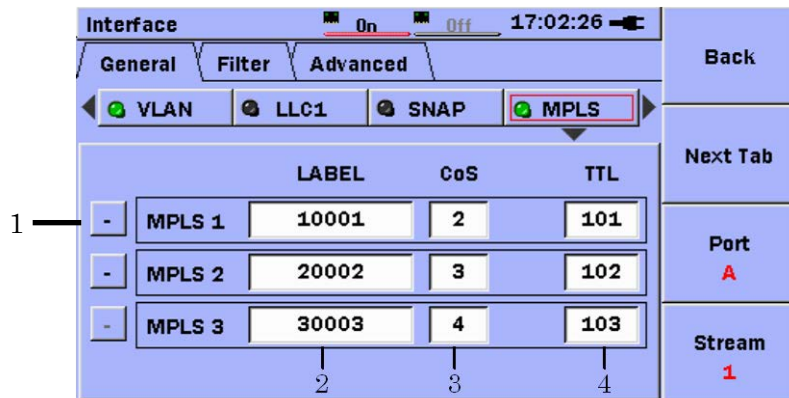

Figure 3.2.1-11 Interface Setup Screen (MPLS Option)

- [1] [-] indicates that the header fields are enabled. [+] indicates that the header fields are disabled.
- [2] Sets the value for **MPLS LABEL**
- [3] Sets the value for MPLS CoS (class of service)
- [4] Sets the value for **MPLS TTL**

Note:

The TTL value should be set to a value greater than zero (0) or the frame will not be allowed to pass beyond the first router in the network.

The MPLS labels will be defined in order 1,2,3, where the higher numbers are the outer most labels (closest to the MAC address in the frame structure) and MPLS 1 is the inner most label. The labels must be defined in sequence; MPLS 2 cannot be defined before MPLS 1, MPLS 3 cannot be defined before MPLS 2.

IPv4 setup pane

The IPv4 header cannot be selected with the IPv6 header. If the IPv4 header is selected while the IPv6 header is already selected, the IPv6 header is deselected automatically.

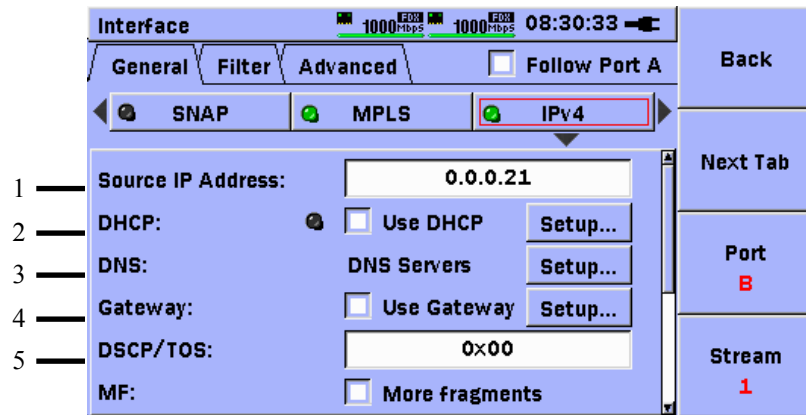

Figure 3.2.1-12 Interface Setup Screen, IPv4 Setup Pane

- [1] Sets value of **Source IP Address** or displays assigned IP address when DHCP enabled
- [2] To use DHCP, put a check mark in the **Use DHCP** check box. This makes the Network Master to send a DHCP request. The status of the request is indicated by the LED icon.
 - Black indicates DHCP not enabled
 - Green indicates DHCP enabled and DHCP request completed
 - Red indicates DHCP enabled but DHCP request not completed

Move the highlight over the **Setup...** button. Press the **Set** key. The DHCP Setup pop-up menu will be displayed, as shown in Figure 3.2.1-13 below.

To renew the DHCP lease when the link is established, enable (✓) the check-box to the left of this label.

Some networks are capable of supplying the DNS Server addresses and the Gateway address and netmask through the DHCP function. To request DHCP to retrieve the DNS Server addresses, enable (✓) the check-box to the left of the “Get DNS servers through DHCP” label. To request DHCP to retrieve the Gateway address and netmask, enable (✓) the check-box to the left of the “Get gateway setup through DHCP” label.

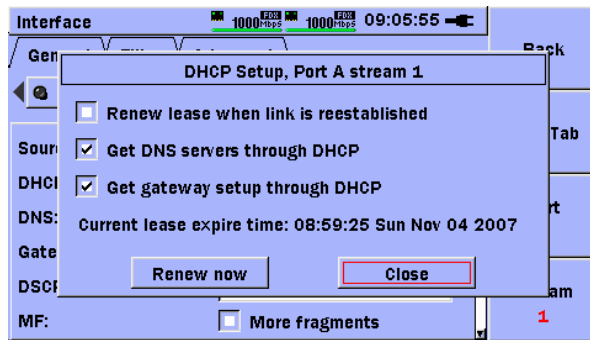

Figure 3.2.1-13 DHCP Setup Pop-Up

- [3] To set or view the DNS Server addresses, move the highlight over the **Setup...** button and press the **Set** key. The DNS Setup pop-up will be displayed, as shown in Figure 3.2.1-14 below.

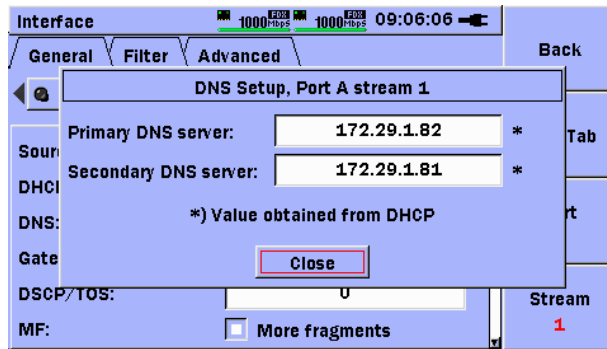

Figure 3.2.1-14 DNS Setup Pop-Up

If the DNS Server addresses were obtained using DHCP, the message “*) Values obtained from DHCP” will be shown. To set the DNS Server addresses manually, move the highlight to the **Primary DNS server** field. Press the **Set** key. Use the pop-up editor to enter the server address. Repeat this process to enter the **Secondary DNS server** address.

- [4] To use a gateway, select **Use Gateway** check box. To view or edit the gateway address and netmask, move the highlight over the **Setup...** button and press the **Set** key. The **Gateway Setup** pop-up will be displayed, as shown in Figure 3.2.1-15 below.

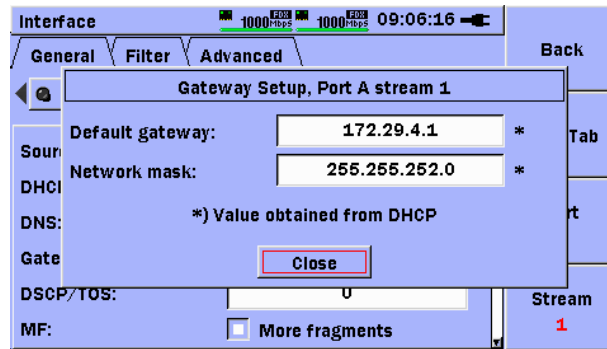

Figure 3.2.1-15 Gateway Setup Pop-Up

If the gateway address and network mask were obtained using DHCP, the message “*) Value obtained from DHCP” will be shown. To enter the gateway address manually, move the highlight over the **Default gateway** field and press the **Set** key. Use the pop-up editor to enter the address. To enter the **Network mask**, move the highlight over this field and press the **Set** key. Use the pop-up editor to enter the mask.

- [5] Sets value of **DSCP/TOS** header field

IPv4 setup pane (continued)

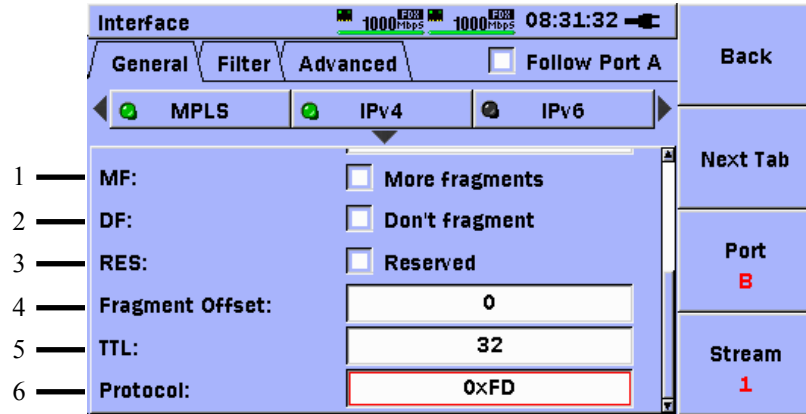

Figure 3.2.1-16 Interface Setup Screen, IPv4 Setup Pane

- [1] Putting a check mark in the **More fragments (MF)** check box sets the **More fragments** bit in the flags section of the IP header.
- [2] Putting a check mark in the **Don't fragment (DF)** check box sets the **Don't fragment** bit in the flags section of the IP header.
- [3] Putting a check mark in the **Reserved (RES)** check box sets the **Reserved** bit in the flags section of the IP header.
- [4] Sets **Fragment Offset**
- [5] Sets **TTL value**
- [6] Sets **Protocol** value

When UDP (See Figure 3.2.1-18) or TCP (See Figure 3.2.1-19) is selected at the UDP or TCP Interface Setup panes this field displays the corresponding protocol value.

IPv6 setup pane

The IPv6 header cannot be selected with the IPv4 header. If the IPv6 header is selected while the IPv4 header is already selected, the IPv4 header is deselected automatically.

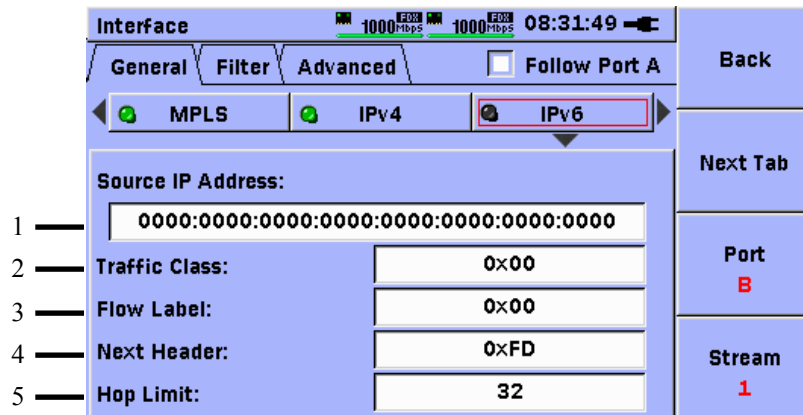

Figure 3.2.1-17 Interface Setup Screen, IPv6 Setup Pane

- [1] Sets value of **Source IP Address**
- [2] Sets value of **Traffic Class**
- [3] Sets value of **Flow Label**
- [4] Sets value of **Next Header** field
When UDP (See Figure 3.2.1-18) or TCP (See Figure 3.2.1-19) is selected at the UDP or TCP setup pane, this field displays the corresponding protocol value.
- [5] Sets value of **Hop Limit**

UDP setup pane

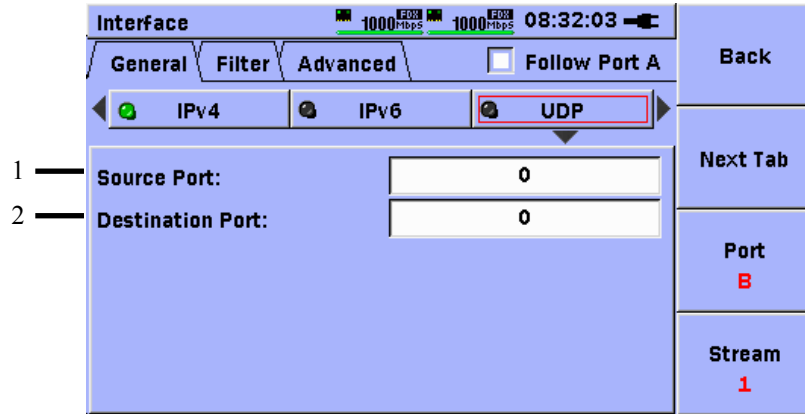

Figure 3.2.1-18 Interface Setup Screen, UDP Setup Pane

- [1] Sets Source Port
- [2] Sets Destination Port

TCP setup pane

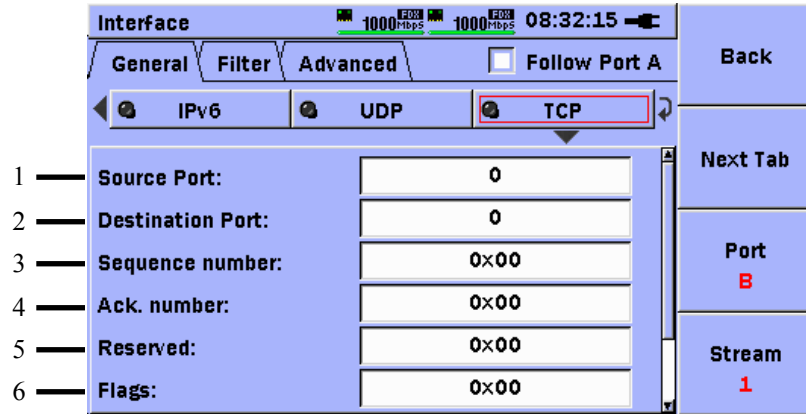

Figure 3.2.1-19 Interface Setup Screen, TCP Setup Pane

- [1] Sets **Source Port**
- [2] Sets **Destination Port**
- [3] Sets **Sequence number**
- [4] Sets **Ack. number** (acknowledge number)
- [5] Sets **Reserved** field
- [6] Sets **Flags** field

TCP setup pane (continued)

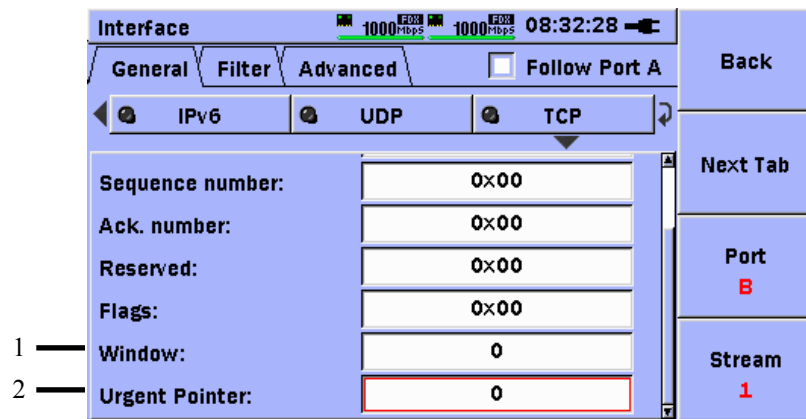

Figure 3.2.1-20 Interface Setup Screen, TCP Setup Pane

- [1] Sets **Window** value
- [2] Sets **Urgent Pointer** value

3.2.2 Interface Filter Setup

From the Interface Filter Setup it is possible to setup filtering of incoming frames. The user interface is similar to the Interface Setup so it is easy to navigate and setup

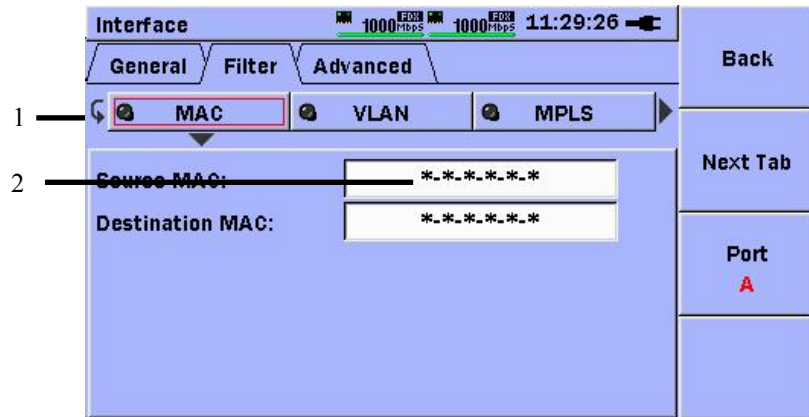



Figure 3.2.2-1 Interface Setup Screen, Filter Tab

- [1] Set and display status of filters for incoming frames

-  Filter applied to incoming frames
-  Filter not applied to incoming frames

Pressing the **Set** key while a filter is selected toggles the filter on/off.

- [2] * This symbol indicates a wildcard meaning “Don't care” indicating that whatever it is replacing is not part of the filter. A filter expression for a MAC address with the format 11:22:33:44:55: * means all frames where the first 5 bytes are 11:22:33:44:55 pass the filter regardless of the value of the last byte.

MAC filter setup pane

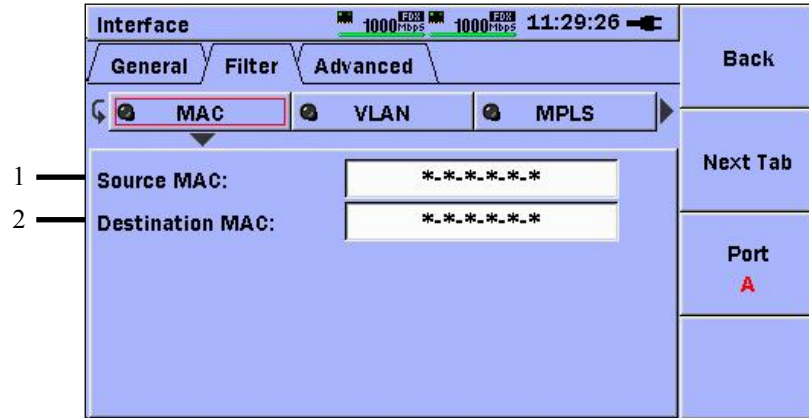

Figure 3.2.2-2 Interface Filter Setup Screen, MAC Filter Pane

- [1] Sets filter value for **Source MAC** address
- [2] Sets filter value for **Destination MAC** address

VLAN filter setup pane

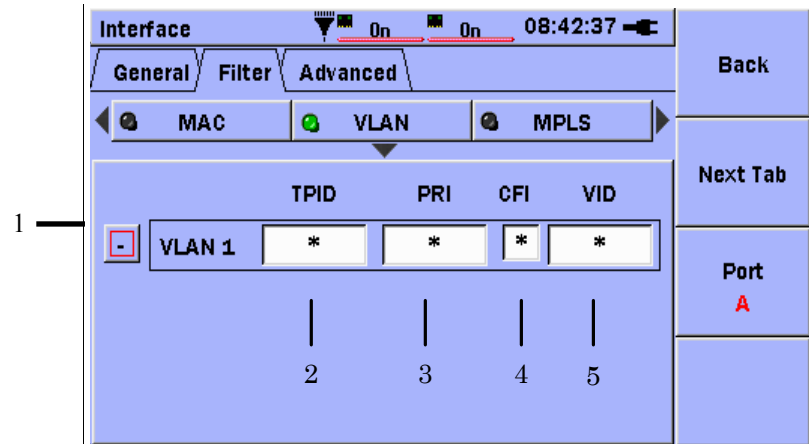

Figure 3.2.2-3 Interface Filter Setup Screen, VLAN Filter Pane

- [1] [-] indicates that the filter fields are enabled. [+] indicates that the filter fields are disabled.
- [2] Sets filter value for **TPID**
- [3] Sets filter value for **VLAN Priority**
- [4] Sets filter value for **CFI Flag**
- [5] Sets filter value for **VLAN ID**

If option MU909060/A1/A2/A3-003 (Stacked VLAN) is installed on the unit, it is possible to define up to three VLAN filters in the same manner as described above. In this case, the VLAN filter setup pane will appear as shown in Figure 3.2.2-4 below.

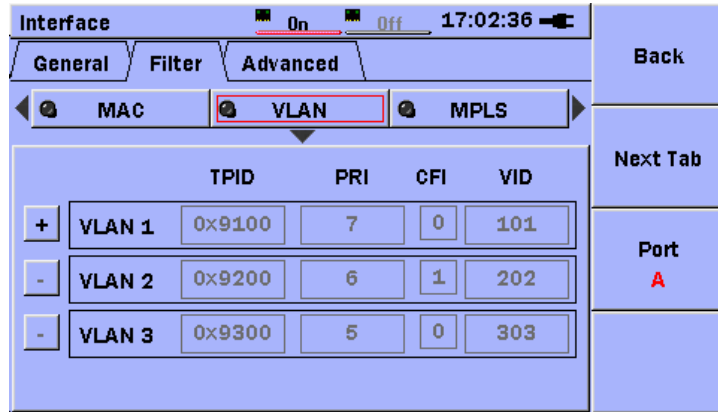

Figure 3.2.2-4 VLAN Filter Pane (Stacked VLAN Option)

MPLS filter setup pane

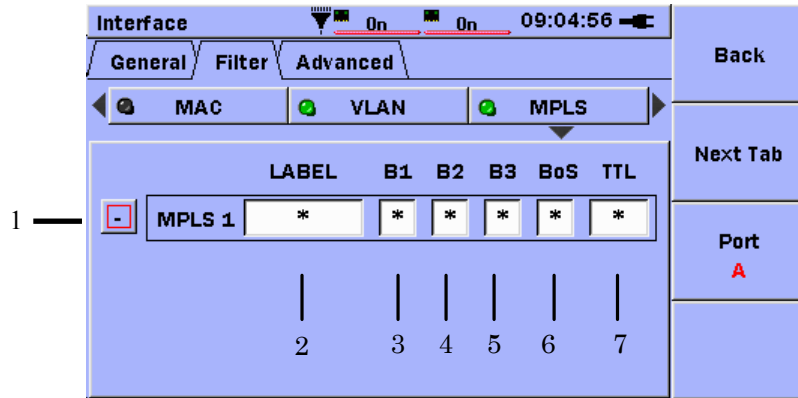

Figure 3.2.2-5 Interface Filter Setup Screen, MPLS Filter Pane

- [1] [-] indicates that the filter fields are enabled. [+] indicates that the filter fields are disabled.
- [2] Sets filter value for **MPLS LABEL**
- [3] Sets filter value for **Experimental Bit1**
- [4] Sets filter value for **Experimental Bit2**
- [5] Sets filter value for **Experimental Bit3**
- [6] Sets filter value for **Bottom of stack flag**
- [7] Sets filter value for **MPLS TTL**

If option MU909060/A1/A2/A3-004 (MPLS) is installed on the unit, it is possible to define up to three (3) MPLS filter in the same manner as described above. In this case, the MPLS filter setup pane will appear as shown in Figure 3.2.2-6 below.

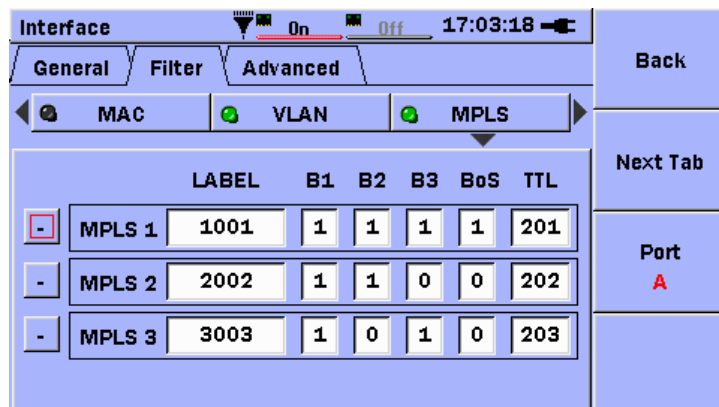

Figure 3.2.2-6 Interface Filter Setup Screen (MPLS Option)

IPv4 filter setup pane

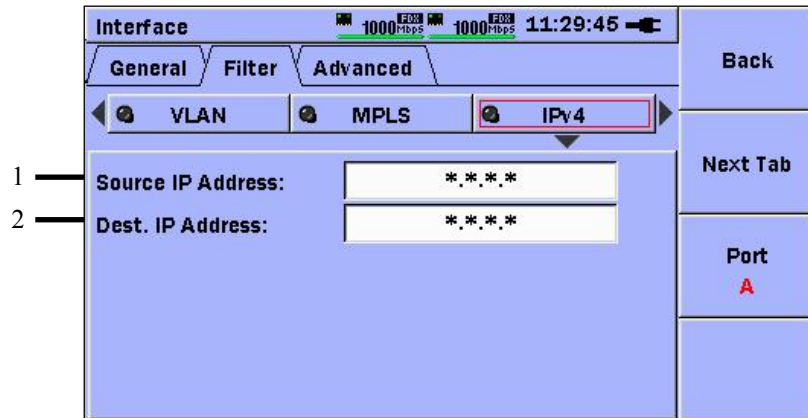

Figure 3.2.2-7 Interface Filter Setup Screen, IPv4 Filter Pane

- [1] Sets filter value for **Source IP Address**
- [2] Sets filter value for **Dest. IP Address**

IPv6 filter setup pane

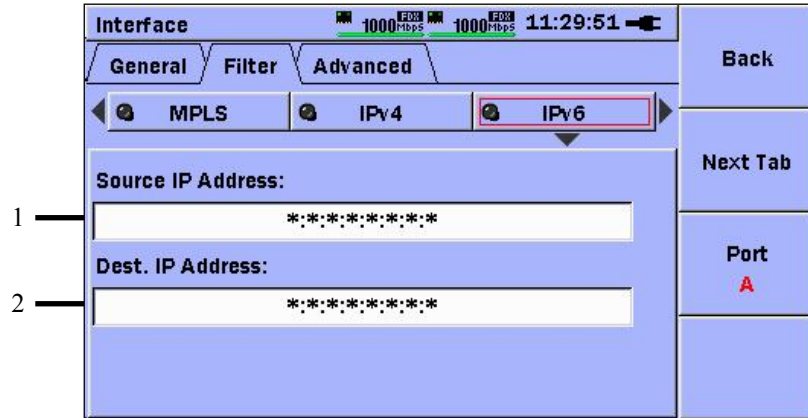

Figure 3.2.2-8 Interface Filter Setup Screen, IPv6 Filter Pane

- [1] Sets filter value for **Source IP Address**
- [2] Sets filter value for **Dest. IP Address**

UDP/TCP filter setup pane

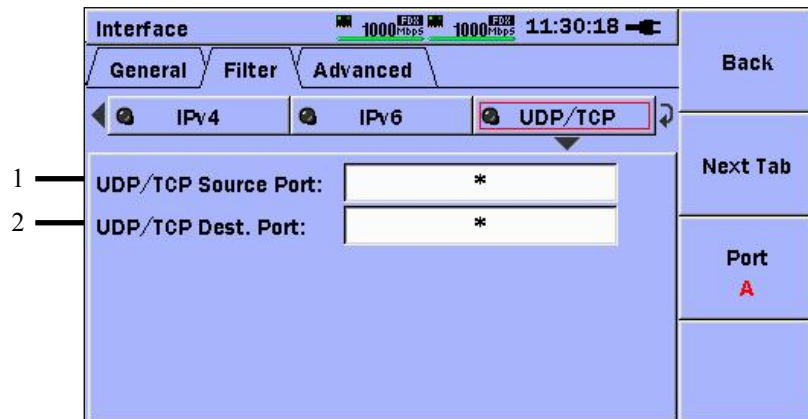

Figure 3.2.2-9 Interface Filter Setup Screen, UDP/TCP Filter Pane

- [1] Sets filter value for **UDP/TCP Source Port**
- [2] Sets filter value for **UDP/TCP Dest. Port**

Table 3.2.2-1 Filter Reference (Part I)

		FILTER SETTINGS						
		MAC DST ON	MAC SRC ON	VLAN OFF	VLAN 1 ON	VLAN 1,2 ON	VLAN 1,2,3 ON	MPLS OFF
FRAME CONTENTS	MAC DST	M						
	MAC SRC		M					
	VLAN (none)			P	F	F	F	
	VLAN 1			P	M	F	F	
	VLAN 1,2			P	F	M,M	F	
	VLAN 1,2,3			P	F	F	M,M,M	
	MPLS (none)							P
	MPLS 1							P
	MPLS 1,2							P
	MPLS 1,2,3							P

Table 3.2.2-2 Filter Reference (Part II)

		FILTER SETTINGS						
		MPLS 1 ON	MPLS 1,2 ON	MPLS 1,2,3 ON	IP DST ON	IP SRC ON	UDP/T CP DST ON	UDP/T CP SRC ON
FRAME CONTENTS	MPLS (none)	F	F	F				
	MPLS 1	M	F	F				
	MPLS 1,2	F	M,M	F				
	MPLS 1,2,3	F	F	M,M,M				
	IP DST				M			
	IP SRC					M		
	UDP/TCP DST						M	
	UDP/TCP SRC							M

M – filter setting must match the data in the frame.

P – will always pass

F – will always fail

All filter fields shown in the tables are considered together. All fields that are enabled must either match the frame data for the field (M) or always pass (P), for the frame to pass the filter.

3.2.3 Advanced Setup

From the Interface Advanced Setup it is possible to configure some advanced selections. The **Incoming Frames** panel includes configuration selections to enable the response to standard protocol frames for ARP (address resolution protocol) and Ping, and a proprietary command protocol used in RFC testing. The **RX Setup** panel includes configuration selections that control the measurement of certain framing parameters.

Incoming Frames setup pane

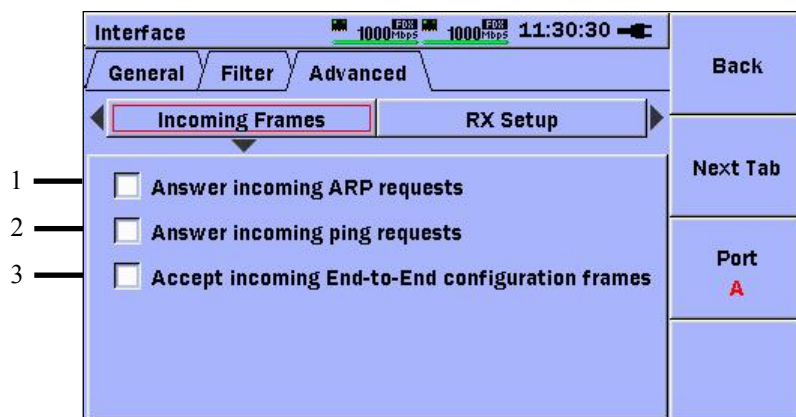

Figure 3.2.3-1 Interface Advanced Setup Screen, Incoming Frames

- [1] Answers ARP requests with MAC and IP addresses matching settings shown in Figure 3.2.1-4 and Figure 3.2.1-11 when check box is selected.
- [2] Answers pings (ICMP echo requests) with MAC and IP addresses matching settings shown in Figure 3.2.1-4 and Figure 3.2.1-11 when check box is selected.
- [3] Network Master functions as master or slave at RFC2544 or Y.1564 Suite End-to-End test when check box is selected.

RX Setup pane

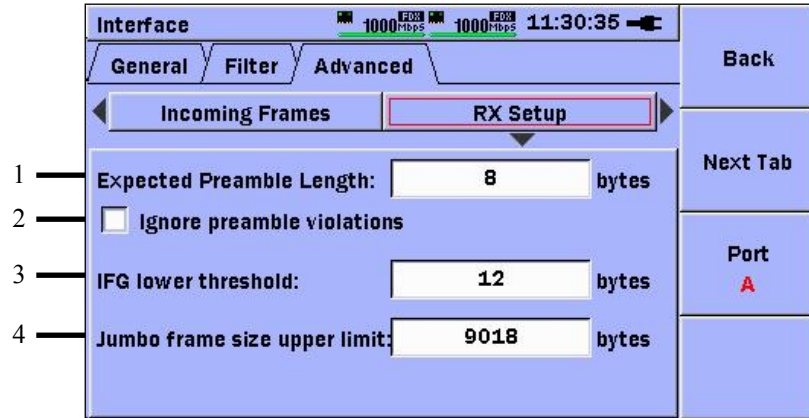

Figure 3.2.3-2 Interface Advanced Setup Screen, Rx Setup

- [1] Sets minimum number of expected bytes in Preamble
- [2] Ignore Preamble violations in results when check box is selected.
- [3] Sets limit for minimum number of bytes expected in IFG
- [4] Sets maximum number of bytes in frame before handled as oversized frame

3.2.4 Test Automator

The **Test Automator** function selects the test or series of tests to run.

This initial setup screen is displayed when **Test Automator** is selected.

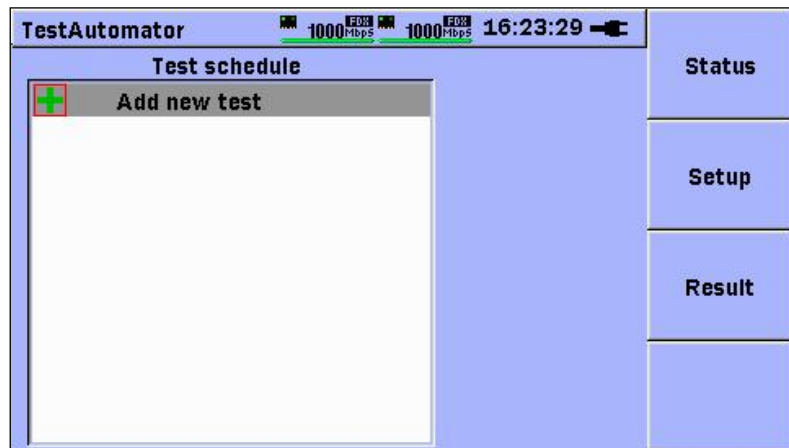

Figure 3.2.4-1 Test Automator Setup Screen

The **Test Automator** screen has the following soft keys.

- Status (F1)** Returns to status screen
- Setup (F2)** Displays setup selector shown in Figure 3.2-1.
- Result (F3)** Displays results summary

The **Test schedule** box is navigated using the **Up**, **Down**, **Left** and **Right** arrow keys. The red square shown in Figure 3.2.4-1 indicates the current selection. To set the selection, press the **Set** key.

After the required tests have been set in **Test schedule** box press the **Start** key to start.

Note:

In V3.00 and higher, when a test in the Test schedule is running, pressing the **Start** key will cause the menu below to be displayed:

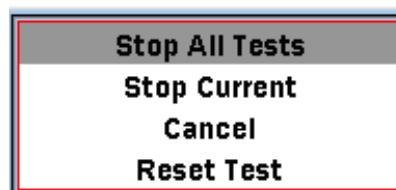

Use the **Up/Down**-arrow keys to move the highlight over the desired action, as described in the table below. Press the **Set** key to complete the selection.

Table 3.2.4-1 Start Key Actions (Test Automator Running)

Action	Description
Stop All Tests	Equivalent to the function of the Start key in V2.xx and lower. Stops all tests in the Test Automator Schedule.
Stop Current	Stops only the current test and transfers execution to the next test in the Test Automator Schedule (if any).
Cancel	No action. Provided in case the Start key was pressed unintentionally.
Reset Test	Only shown when an instance of the Generator test is running, the results mode is Cumulative, and both ports are set to Duration/Mode = Continuous. This action will re-set all of the statistics (Cumulative SDT, and Channel Stats) and re-start the collection process.

Pressing the **Set** key shown in Figure 3.2.4-1 displays the test selection pop-up shown in Figure 3.2.4-2.

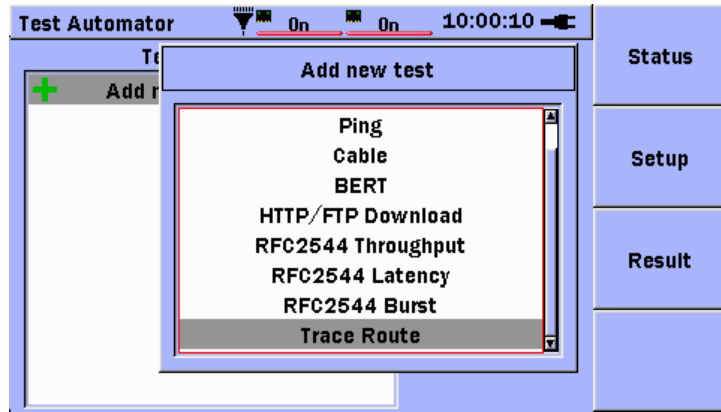

Figure 3.2.4-2 Test Selection Pop-Up

Use the **Up** and **Down** arrow keys to navigate between the tests. Press the **Set** key to select the test.

When a test is selected it is displayed in the **Test schedule** box.

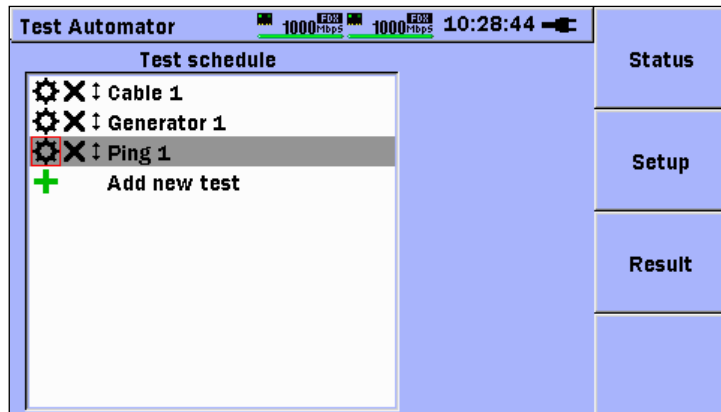

Figure 3.2.4-3 Test Automator with Tests

Use the **Up, Down, Left and Right** arrow keys to move the red frame to the following options:

⚙ Test setup: pressing **Set** while this is selected displays the test-specific setup screens. This setup is described in the sections about specific tests.

✕ Remove test: pressing **Set** while this is selected, removes the test from the **Test schedule** box.

↓ Move test: pressing **Set** while this is selected moves the test as shown:

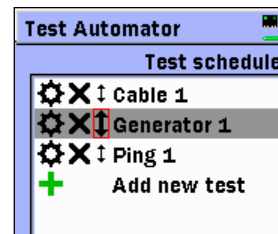

Figure 3.2.4-4 Test Schedule with Test Movement Enabled

As shown in Figure 3.2.4-4, when the arrow is in bold, use the **Up** and **Down** arrow keys to move the selected test up or down in the list.

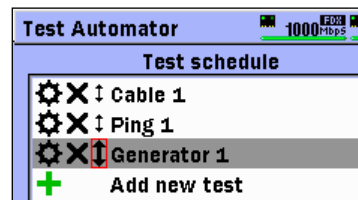

Figure 3.2.4-5 Test Schedule with Test Moved

Pressing **Set** disables movement so the **Up, Down, Left and Right** arrow keys can be used to select between the three test options again.

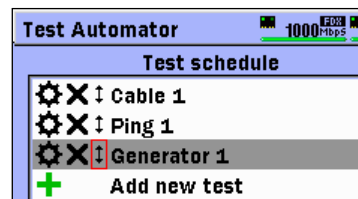

Figure 3.2.4-6 Test Schedule with Movement Disabled after Test Moved

3.2.5 General Setup

The **General Setup** function allows the user to select options that are common to all applications.

Note:

Streams are only used by the Generator application.

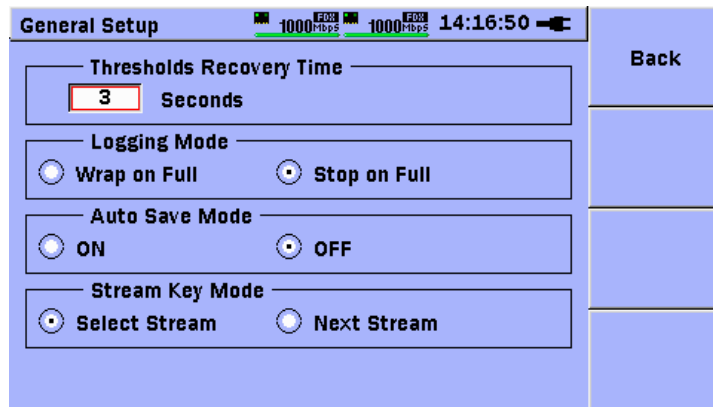

Figure 3.2.5-1 General Setup Screen

To change the General Setup options, perform the following steps:

1. Use the **Up, Down, Left, Right** arrow keys to select the option to be enabled, as indicated by the red circle.
2. The option will change to an enabled state, as indicated by the center dot in the option (radio) button.
3. Repeat step 1 until all options have been changed to the desired settings.
4. Press the **Back (F1)** soft key to return to the previous display.

The available options are listed below:

Threshold Recovery Time – if a metric has violated its threshold and has caused a (🔴) failing status indication, the metric must return to a non-violating level for a minimum amount of time, defined by this setting, before the test will show a (🟢) passing status indication.

Logging Mode – The event log can hold a maximum of one-thousand (1000) records per test schedule execution. This option determines the behavior of event logging once the event log becomes full.

- **Wrap on Full** - indicates that logging will continue, and the oldest record will be overwritten.
- **Stop on Full** - indicates that error logging will stop. The current log will be preserved but new events will be lost.

Auto Save Mode – determines the state of the Auto Save feature, which automatically saves the results at the end of the execution of the test schedule.

- **On** – results will be saved automatically at the end of the execution of the test schedule.
- **Off** – results will not be saved automatically at the end of the execution of the test schedule. The Save Results function must be used to save results manually.

Stream Key Mode

When the Multistream option (MU909060A1/A2/A3-002) is installed on the unit, a **Stream (F4)** softkey is present on many setup and result screens. For examples see Section 3.2.1 “[Interface General Setup](#)”, Figures Figure 3.2.1-1, Figure 3.2.1-3 to 3.2.1-10, 3.2.1-14 to 3.2.1-18, Section 3.3.1 “[Generator Test Setup](#)”, Figures 3.3.1-3, 3.3.1-5 to 3.3.1-8, and Section 3.3.2 “[Generator Test Results](#)”, Figures 3.3.2-1 to 3.3.2-4.

- **Select Stream** – pressing the **Stream (F4)** softkey will cause the Stream Selector dialog (see Figure 3.3.1-4) to be shown.
- **Next Stream** – each time the **Stream (F4)** softkey is pressed, it will automatically increment the stream number to the next stream (from 1 to 8 in sequence), or wrap back to stream 1 if the maximum number of streams has been reached. The Stream Selector dialog is not displayed.

3.3 Generator Test

The Generator function is used to generate traffic and monitor an Ethernet connection. It works in conjunction with **Interface Setup**.

The framing is set at the **Interface Setup** screen; the **Generator Test** setup is used to define the stream control mode, line load, frame size profile, destination address, and user thresholds.

3.3.1 Generator Test Setup

Up to eight Generator tests can be added to the **Test Automator**. Each test has separate setup parameters. To setup a Generator test, press the  icon at the **Test Automator** screen. See Section 3.2.4 “[Test Automator](#)” for further information about the **Test Automator** function.

The Generator test setup screen has seven standard panes -

- Unit
- Mode/Duration
- Line Load
- Frame Size
- Destination
- Thresholds
- SDT (Service Disruption Time)

In addition, one additional pane if option MU909060/A1/A2/A3-006 is installed on the unit:

- Channel Stats (Channel Statistics)

Note:

The Generator result screens (Current, Cumulative, Graph, and SDT) are stream specific. This means the results only include information about frames that pass stream filters which are setup automatically by the application. The **Stream ID Control** setting described below determines how the stream filters are set.

The **Unit** pane shown in Figure 3.3.1-1 includes a **Stream ID Control** field which sets the configuration for traffic generation and monitoring for the entire unit (both ports and all streams). Four different configurations can be selected:

Table 3.3.1-1 Stream ID Control Modes

Stream ID Control	Description
Any MU909060A-Any Port	This configuration will set the unit to accept traffic from any other MU909060A unit. This configuration is used to measure frame loss in a two unit (end to end) configuration using sequence number counting.
This-Unit-Same Port	This configuration will set the unit to only accept traffic into the streams on Port A/B that it generated from Port A/B. This configuration allows precise frame loss and other measurements to be made when the unit (unit A) is transmitting to a second unit (unit B), where unit B is setup to reflect traffic back to unit A on the same port.
This Unit-Opposite Port	This configuration will set the unit such that Port A will only accept traffic from Port B, and Port B will only accept traffic from Port A. This configuration allows precise frame loss and other measurements to be made in a loop (Port A to Port B) configuration.
Any Source	<p>This configuration will set the unit to accept frames from any source into the streams.</p> <p>Note:</p> <p>In this configuration the address headers (described in Interface Setup) are used as stream filters. The destination address fields and all headers of incoming frames must match those of the source address fields and all headers defined in interface setup, in structure and value, according to Table 3.3.1-2.</p>
Ver 1.x Compatibility	<p>This configuration will set the unit to operate in a mode that is compatible with V1.x software for measuring Frame Loss.</p> <p>Note:</p> <p>In this configuration the address headers (described in Interface Setup) are used as stream filters. The destination address fields and all headers of incoming frames must match those of the source address fields and all headers defined in interface setup, in structure and value, according to Table 3.3.1-2.</p>

Table 3.3.1-2 Stream Filter Reference

		INTERFACE SETUP (PER STREAM) STREAM FILTER (STREAM ID CONTROL = ANY SOURCE)						
		MAC SRC	VLAN Off	VLAN 1	VLAN 1,2	VLAN 1,2,3	IP SRC (if on)	UDP/TCP SRC PORT (if on)
FRAME CONTENTS	MAC DST	M						
	VLAN (none)		P	F	F	F		
	VLAN 1		P	M	F	F		
	VLAN 1,2		P	F	M,M	F		
	VLAN 1,2,3		P	F	F	M,M,M		
	IP DST						M	
	UDP/TCP DST							M

M – filter setting must match the data in the frame. For VLANs, only the VID is considered. The TPID, PRI and CFI fields are ignored.

P – will always pass

F – will always fail

All filter fields shown in Table 3.3.1-2 are considered together. All fields that are enabled must either match the frame data for the field (M) or always pass (P), for the frame to pass the filter.

Notes:

- Many control frames for protocols such as ARP, PING, DNS, DHCP, and RFC which are used to discover addresses and establish communications also follow the filter rules shown in Table 3.3.1-2 above. If any of these protocols are enabled in a test, then the destination address fields and headers defined in the test must match the source address fields and headers defined in interface setup according to Table 3.3.1-2, or these protocols will fail and the test will not proceed as expected. This note applies for all of Stream ID Control settings.
- V2.0x is not backwards compatible with V1.0x for multistream frame loss testing. It is recommended to upgrade all units to V2.0x to obtain the latest multistream frame loss methods. V2.0x is available as a free download from:

<http://www.anritsu.com/en-AU/Downloads/Software/Drivers-SoftwareDownloads/DWL7748.aspx>

To select a **Stream ID Control** setting:
Use the **Up, Down, Left, Right** arrow keys to navigate to the input field.
Press the **Set** key. The **Stream ID Control** pop-up menu will be shown.
Use the **Up, Down** arrow keys to highlight a selection.
Press the **Set** key to make the selection and close the pop-up menu.

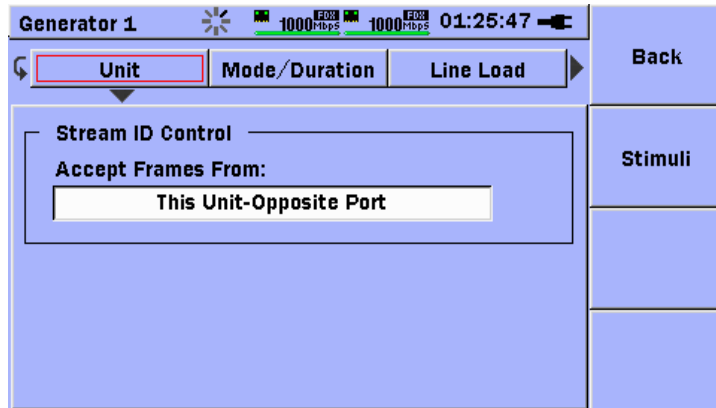

Figure 3.3.1-1 Generator Setup Screen, Unit Pane

The **Mode/Duration** pane shown in Figure 3.3.1-2 sets the port-specific traffic duration and generator modes.

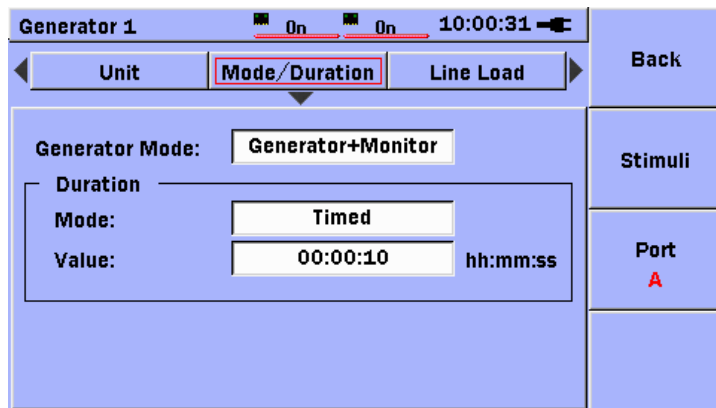
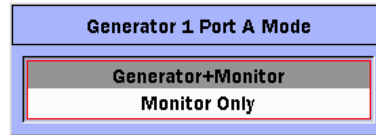

Figure 3.3.1-2 Generator Setup Screen, Mode/Duration Pane

There are two generator modes as described below:



- **Generator+Monitor**
Generates traffic with the framing that is setup at Interface Setup and at a rate specified at the Line Load pane.
- **Monitor only**
Starts Generator test without transmitting frames

There are three Duration modes:

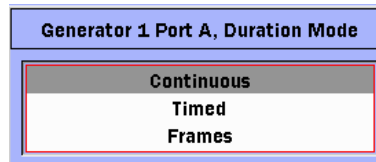

- **Continuous**
Generator test runs until stopped manually.
- **Timed**
Generator test runs for specified time period.
- **Frames**
Generator test stops after specified number of frames sent.

Note:

The receiver (Monitor) will typically remain active for one or two seconds after the transmitter (Generator) has stopped transmitting, to allow the last frames that were transmitted to reach the receiver and be counted. If relatively few frames are received during this period it may cause the average rate statistics such as Throughput (%) and Utilization (%) to decrease significantly in the last seconds, and the final values shown for these statistics may not accurately represent the rates that were observed during the main portion of the test, when the transmitter was active.

The **Line Load** setup pane defines the line load profile for the test.

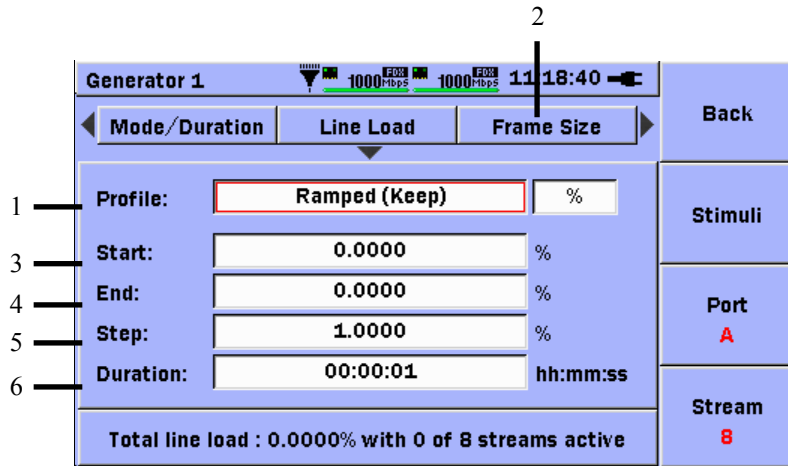

Figure 3.3.1-3 Generator Setup Screen, Line Load Pane

Note:

Multiple streams are supported only if the Multistream option is installed.

If the **Stream Key Mode** in **General Setup** is set to **Select Stream**, pressing the **Stream** soft key (**F4**) displays the Stream Selector pop-up (Figure 3.3.1-4). Green indicates an active stream and black indicates an inactive stream. (**Profile** set to **Off**.)



Figure 3.3.1-4 Generator Setup Screen, Stream Selector

- [1] Specifies the line profile to be used for the currently selected stream. The line profile can be one of the selections listed below:
- **Off** – the stream is inactive.
 - **Constant** – the stream will transmit at a constant line rate.
 - **Ramped (Keep)** – the stream will execute a ramped line load profile, and will maintain the end line rate when the ramp is complete.
 - **Ramped (Invert)** – the stream will execute a ramped line load profile. When each cycle of the ramp is complete, the stream will invert the current profile and begin a new cycle (start line rate will become the end line rate, end line rate will become the start line rate) and the ramp will repeat.
 - **Ramped (Repeat)** – the stream will execute a ramped line load profile. When execution of the ramp is complete (end line load reached), the stream will reset the line rate to the “start” value and repeat the ramp.
- [2] Line rates can be specified in % (of current interface line rate) or Mbps (megabits per second)
- [3] Start – the initial line rate.
- [4] End – the terminal line rate.
- [5] Step – the amount to increment (or decrement) the initial line rate.
- [6] (Step) Duration – the length of time to remain at each line rate (when running a ramped profile).

Total line load at the bottom of the pane shows the percentage and number of active streams. More streams cannot be activated when the total line load is 100%. Total line load is only displayed when the Multistream option is installed.

The **Frame Size** setup pane defines the frame size profile for the test.

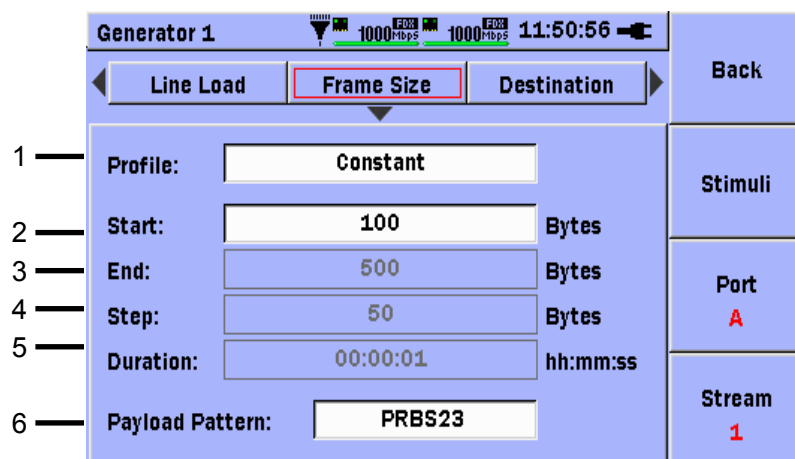

Figure 3.3.1-5 Generator Setup Screen, Frame Size Pane

[1] Defines the frame size profile.

The following profiles are available:

Constant

Profile:	Constant
Start:	100 Bytes

Frame Size does not change and constant size is specified in **Start** field

Random

Profile:	Random
Start:	100 Bytes
End:	500 Bytes

Generator sends frames of random sizes between values specified at **Start** and **End**

Stepped

Profile:	Stepped
Start:	100 Bytes
End:	500 Bytes
Step:	50 Bytes
Duration:	00:00:01 hh:mm:ss

Frame Size incremented by value specified at **Step** from **Start** to **End** for interval specified at **Duration** and repeated until test stopped

- [2] Start – the initial frame size.
- [3] End – the terminal frame size.
- [4] Step – the amount to increase (decrease) the frame size at each step.
- [5] (Step) Duration – the length of time to remain at each frame size (when running a stepped profile).
- [6] Payload Pattern defines the bit pattern that will be included in the payload area of the transmitted frames.

Note:

When **Generator Mode** is set to **Monitor Only**, all active streams are ignored.

The **Destination** setup pane is where the destination of **MAC** and **IP** are defined. The source **MAC** and **IP** are set at the **Interface Setup** screen.

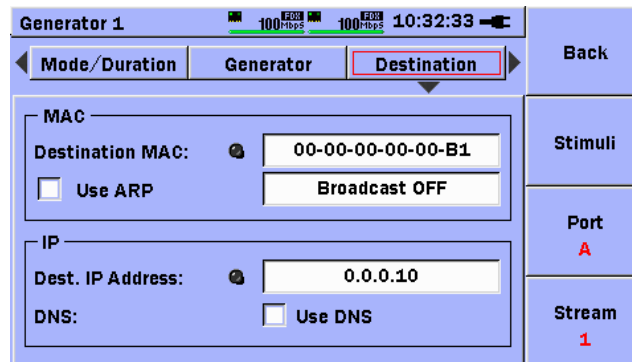

Figure 3.3.1-6 Generator Setup Screen, Destination Pane

MAC

The **Destination MAC** can be specified either manually or resolved by ARP lookup. Select the **Use ARP** check box to enable ARP lookup. A percentage of the current **Stream Line Load** can be used for sending broadcast frames.





IP

The **Dest. IP Address** can be specified either manually or resolved by DNS lookup. Select the **Use DNS** check box to enable DNS lookup and input the host name. Up to 128 characters can be entered.



Figure 3.3.1-7 Generator Setup Screen, Host Name Input Editor

The LED icon shows the lookup progress/result:

-  Black indicates Lookup not executed
-  Gray (Blinking) indicates lookup in progress
-  Green indicates Lookup succeeded
-  Red indicates Lookup failed

The **Threshold** setup pane is where user thresholds can be set. When user thresholds are enabled, the system will monitor the results of the Generator test and (optionally) log a violation message when one or more of the active thresholds are violated. Threshold violations will cause a FAIL indication to be shown on the Result Overview screen (refer to Section 2.6.1). If no thresholds are violated, a PASS indication will be shown.

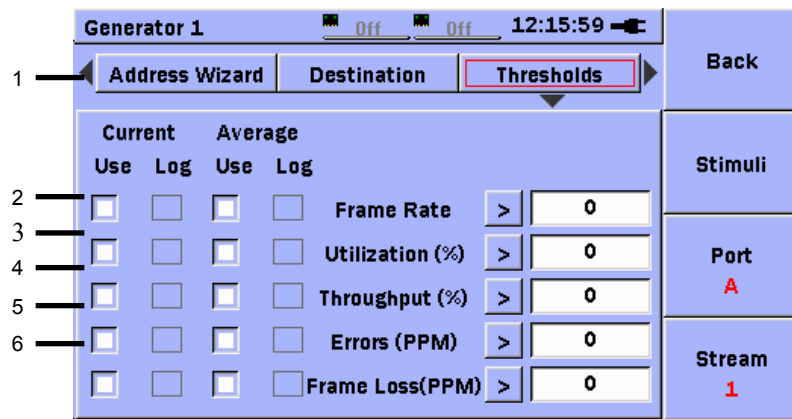

Figure 3.3.1-8 Generator Setup Screen, Threshold Pane

[1] Each **threshold** has four (4) check boxes that are used to define how the threshold is applied.

- **Current** – define the threshold for the current (per second) Generator result.
- **Average** – define the threshold for the average (cumulative) Generator result.
- **Use** – enable this threshold and use it to determine a PASS or FAIL result for the test.
- **Log** – make an entry in the event log if this threshold is violated.

Thresholds can be set on the following statistics:

- [2] Current or average Frame Rate.
- [3] Current and average Utilization %. The measurement of utilization includes all overhead bits in the frame.
- [4] Current and average Throughput %. The measurement of throughput includes only the user data in the frame.
- [5] Current and average Errors (PPM). The number of errored frames relative to the number of total frames, in PPM units.
- [6] Current and average Frame Loss (PPM). The number of frames lost relative to the number of frames that should have been received, in PPM units.

If enabled, the thresholds for Utilization %, Throughput %, and Errors % are shown above the bar graphs for each of these statistics on the Graph Tab. The thresholds are shown as a green line in the region of the graph where the statistic will PASS the threshold, and a red line in the region of the graph where the statistic will FAIL the threshold. See Figure 3.3.2-3 for an example of the Graph Tab with thresholds enabled.

The **SDT (Service Disruption Time)** setup pane is where the run-time threshold and user thresholds for the SDT test can be set.

The purpose of the SDT measurement is to provide statistics on how long and how frequently the network was un-available during normal operations, or periods when service affecting events or changes to the network topology occurred.

The SDT measurement is a function of the monitoring feature of the Generator test and is always active. The SDT measurement will collect independent statistics for each active stream on one or both ports. A basic unit has one (1) stream available on each port. Up to eight (8) streams are available on each port if the Multistream option is installed on the receiving unit.

Once a Generator test is started, for each active stream, the MU909060A unit will measure the gap between consecutive incoming frames (IFG) that pass its filters. Note that a frame must pass both the global filters (Interface setup, Filter tab) and the stream filters, which are pre set by the software (see description of the Stream ID Control feature above), to be received in a stream. The user can set a run-time threshold for each stream that defines the smallest IFG (or period of inactivity) that should be considered a service disruption for that stream. Each time the measured IFG for a stream exceeds the threshold for that stream, the measurement will be considered a service disruption and included in the SDT statistics for that stream.

The SDT measurement will filter incoming traffic to eliminate broadcast and discovery protocol traffic from adjacent NEs (i.e. traffic that did not traverse the network) that could invalidate the results. The exact nature of the filters used depends on the configuration of the test, as shown in the table below.

Table 3.3.1-3 SDT Configuration Table

Measurement	Traffic Source	Address Requirements ReceivingUnit	Number of Units
In Service	Normal Network Traffic (not generated by a MU909060A)	The destination MAC and IP addresses of the received frames must match the source MAC and IP addresses of the receiving stream(s). In addition, on the MU909060A, if a stream's source addressing (Interface setup) includes VLAN and/or TCP/UDP, then the incoming frames must include these fields and their values (such as VID for VLAN) must match exactly. Refer to Table 3.3.1-2. Set receiver's Stream ID Control to Any Source	One at each monitoring point.
In/Out Service	Generator Unit to Unit	None. Set receiver's Stream ID Control to Any MW909060A-Any Port	2
In/Out Service	Generator Port A to Port B	None. Set unit's Stream ID Control to This Unit-Opposite Port	1
In/Out Service	Generator Port to Reflector	None. Set unit's Stream ID Control to This Unit-Same Port	1

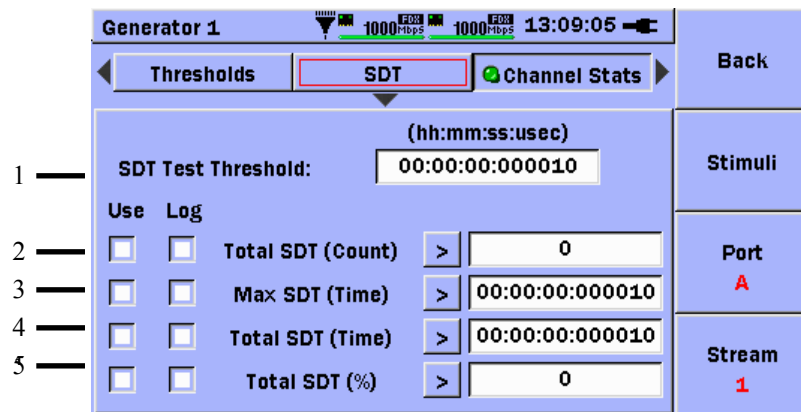

Figure 3.3.1-9 Generator Setup Screen, SDT Pane

Run Time Threshold

- [1] **SDT Test Threshold** – if the gaps between two consecutive frames (that pass all filters) exceeds this value, an SDT event will be recorded at the end of the gap (start of the next frame received).

User Thresholds

- [2] **Total SDT (Count)** - if the total number of SDTs recorded exceeds this value, a threshold violation will occur.
- [3] **Max SDT Time** – if the largest (longest) recorded SDT exceeds this value, a threshold violation will occur.
- [4] **Total SDT Time** – if the total recorded SDT time exceeds this value, a threshold violation will occur.
- [5] **Total SDT %** - if the total SDT time as a percentage of total test time exceeds this value, a threshold violation will occur.

If option MU909060/A1/A2/A3-006 (Channel Statistics) is installed on the unit, the **Channel Stats** setup pane will be displayed. The Channel Stats feature is a function of the monitoring feature of the Generator test, and can be enabled or disabled as described below. The Channel Stats feature operates on one or both ports, but it is not stream specific. All incoming frames must pass only the global filters (Interface Setup, Filter tab) to be processed by the Channel Stats feature.

The Channel Statistics option allows the user to select a combination of up to three (3) key fields that define a channel. The user can also select the operating mode, sorting mode, and main counter (statistic) to be used. Once the test is started, all incoming frames (that pass the global filters) are examined and the following actions are performed:

- **New Channel** – the data pattern in the frame's key fields has not been seen before; a new channel is created (if there is room in the table).
- **Existing Channel** – the data pattern in the frame's key fields has been seen before; it's statistics will be added to the statistics for the existing channel.
- **Table is Full** – the data pattern in the frame's key fields has not been seen before, but there is no room in the table to create a new channel; the frame's statistics will be added to the statistics of the overflow channel.

The resulting channels are presented in tabular form (see Section 3.3.2).

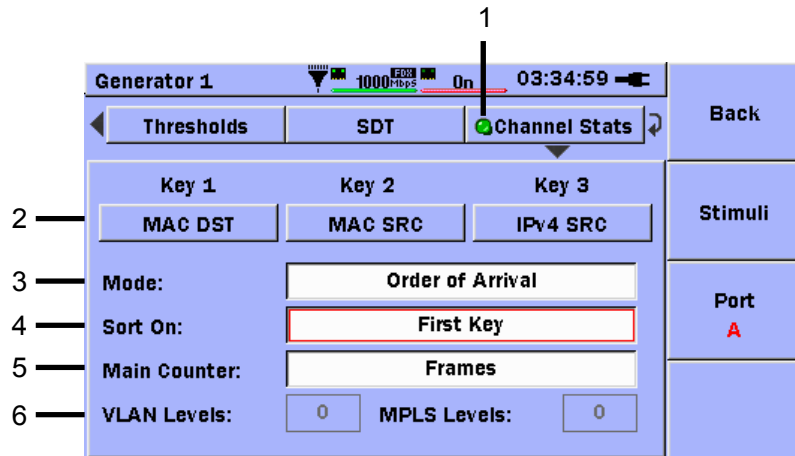

Figure 3.3.1-10 Generator Setup Screen, Channel Stats

To setup the Channel Stats feature, perform the following steps:

[1] Enable Channel Stats

To enable the Channel Stats feature, use the **Left, Right, Up, Down** arrow keys to highlight the Channel Stats button. Press the **Set** key so that the LED button turns green. To disable the feature, press the **Set** key so that the LED turns black.

[2] Key Fields

1. Use the **Up, Down, Left, Right** arrow keys to highlight the **Key 1 (or Key 2 or Key 3) button**. Press the **Set** key, the **Select Key** pop-up list will be shown (see the table below for a description of each key).
2. Use the **Up, Down** arrow keys to highlight the desired key name.
3. Press the **Set** key to select the key.

Notes:

- **Key 1** must always be defined. **Key 2** and **Key 3** are optional and can be set to the value **NONE** to indicate they will not be used.
- There is no significance to the order of **Key 1, Key 2, Key 3** other than 1) there is an option to sort on **Key 1** and 2) the data will be presented in the table columns **main counter, Key 1, (Key 2, Key 3 if used)**.

- [3] Mode
4. Use the **Up, Down, Left, Right** arrow keys to highlight the **Mode** field. Press the **Set** key, the **Select Mode** pop-up list will be shown.
 - **Order of Arrival** – the channels are discovered solely by the order in which the frames arrive at the receiver. No other consideration is given. Once the table is filled, no other channels can be discovered.
 - **Top Talker Mode** – a special algorithm is used to automatically eliminate the channels that exhibit low throughput, allowing new and potentially high throughput channels to enter the table.
 5. Use the **Up, Down** arrow keys to highlight a selection. Press the **Set** key to select the mode.
- [4] Sort On (only available when Order of Arrival mode is selected)
6. Use the **Up, Down, Left, Right** arrow keys to highlight the **Sort On** field. Press the **Set** key, the **Sort Table On** pop-up list will be shown.
 - **Channel ID** – the channels are presented in the order in which they were discovered.
 - **First Key** – the channels are sorted on the **Key 1** data field.
 - **Main Counter** – the channels are sorted on the **Main Counter** data field.
- [5] Main Counter
7. Use the **Up, Down** arrow keys to highlight a selection. Press the **Set** key to select the sort field.
 8. Use the **Up, Down, Left, Right** arrow keys to highlight the **Main Counter** field. Press the **Set** key, the **Select Counter** pop-up list will be shown.
 - **Frames** – the number of received frames for the channel is shown.
 - **Bits** – the number of received bits for the channel is shown.
 - **Errors** – the number of received errored frames for the channel is shown.

Note:

When **Top Talker** mode is selected, a frame rate (Frames/Sec), bit rate (Bits/Sec) or error rate (Errors/Sec) is shown in the Main Counter field of the table.

The following selections are only available in **Order of Arrival** mode:

- **Size [64-127]** – the number of received frames in this size range is shown.
 - **Size [128-255]** – the number of received frames in this size range is shown.
 - **Size [256-511]** – the number of received frames in this size range is shown.
 - **Size [512-1023]** – the number of received frames in this size range is shown.
 - **Size [1024-Jumbo]** – the number of received frames in this size range is shown.
 - **Size [>Jumbo]** – the number of received frames in this size range is shown.
9. Use the **Up, Down** arrow keys to highlight a selection. Press the **Set** key to select a main counter field.

[6] VLAN Levels

If any VLAN type keys are selected, it is necessary to indicate the number of VLAN tags in the structure of received frames. Received frames that do not have the exact number of VLAN tags specified by the user will not be considered for inclusion in a channel; instead the statistics for these frames will be added to the overflow channel. The diagram below indicates which VLAN tag in the frame structure will be presented in the Key column for each key.

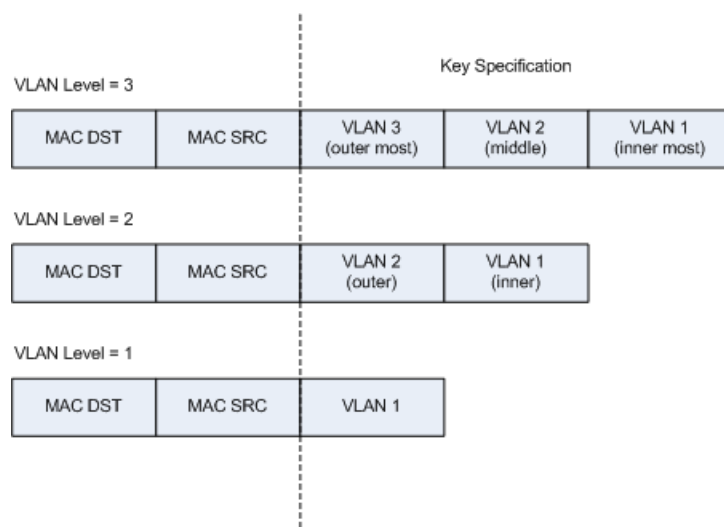

Figure 3.3.1-11 Channel Stats, VLAN Key Mapping

10. Use the **Left, Right, Up, Down** arrow keys to highlight the **VLAN Levels** field. Press the **Set** key and the **VLAN Levels** pop-up menu will be displayed. Use the **Up/Down** arrow keys to highlight a selection in the list. Press the **Set** key to make the selection and close the pop-up menu.

Note:

If no VLAN keys are selected this field will not be available for selection and the value shown for the field will have no effect on the results.

Table 3.3.1-4 VLAN Levels Selection

Highest Key Selected	VLAN Levels Available For Selection
VLAN3	3 (fixed, selection not available)
VLAN2	3, 2
VLAN1	3, 2, 1
None	0 (fixed, selection not available)

[7] MPLS Levels

If any MPLS type keys are selected, it is necessary to indicate the number of MPLS labels in the structure of received frames. Received frames that do not have the exact number of MPLS labels specified by the user will not be considered for inclusion in a channel; instead the statistics for these frames will be added to the **overflow channel**. The diagram below indicates which MPLS label in the frame structure will be presented in the Key column for each key.

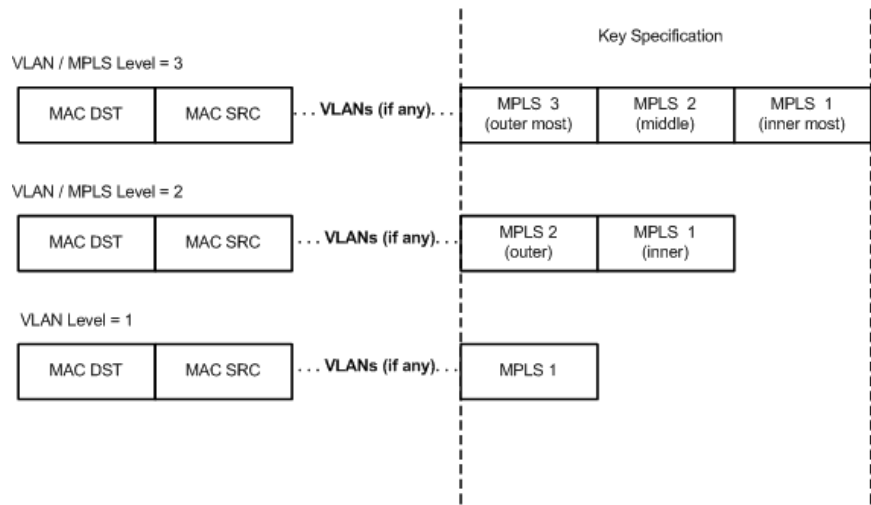

Figure 3.3.1-12 Channel Stats, MPLS Key Mapping

- Use the **Left, Right, Up, Down** arrow keys to highlight the **MPLS Levels** field. Press the **Set** key and the **MPLS Levels** pop-up menu will be displayed. Use the **Up/Down** arrow keys to highlight a selection in the list. Press the **Set** key to make the selection and close the pop-up menu.

Table 3.3.1-5 MPLS Levels Selection

Highest Key Selected	MPLS Levels Available For Selection
MPLS3	3 (fixed, selection not available)
MPLS2	3, 2
MPLS1	3, 2, 1
None	0 (fixed, selection not available)

Note:

If no MPLS keys are selected this field will not be available for selection and the value shown in the field will have no affect on the results.

Table 3.3.1-6 Channel Stats Key Selections

Key Field	Selection Name
MAC destination address	MAC DST
MAC source address	MAC SRC
IPv4 destination address	IPv4 DST
IPv4 source address	IPv4 SRC
IPv4 QoS bits and protocol	IPv4 QoS&PROT
IPv4 QoS bits	IPv4 QoS
IPv4 protocol	IPv4 PROT
TCP/UDP destination port	DST PORT
TCP/UDP source port	SRC PORT
VLAN1 - TPID+VID+Priority	VLAN1 ALL
VLAN1 - VID+Priority	VLAN1 ID & PRI
VLAN1 - VID	VLAN1 ID
VLAN1 - Priority	VLAN1 PRI
VLAN2 - TPID+VID+Priority	VLAN2 ALL
VLAN2 - VID+Priority	VLAN2 ID & PRI
VLAN2 - VID	VLAN2 ID
VLAN2 - Priority	VLAN2 PRI
VLAN3 - TPID+VID+Priority	VLAN3 ALL
VLAN3 - VID+Priority	VLAN3 ID & PRI
VLAN3 - VID	VLAN3 ID
VLAN3 - Priority	VLAN3 PRI
MPLS1 Label + CoS bits	MPLS1 LBL&CoS
MPLS1 Label	MPLS1 LBL
MPLS1 CoS bits	MPLS1 CoS
MPLS2 Label + Cos bits	MPLS2 LBL&CoS
MPLS2 Label	MPLS2 LBL
MPLS2 Cos bits	MPLS2 CoS
MPLS3 Label + Cos bits	MPLS3 LBL&CoS
MPLS3 Label	MPLS3 LBL
MPLS3 Cos bits	MPLS3 CoS
IPv6 QoS bits and next header	IPv6 QoS&HDR
IPv6 QoS bits	IPv6 QoS
IPv6 next header (protocol)	IPv6 HDR

To set up the generator, the user must consider the following:

- The Stream ID Control mode
- Whether the instrument should act only as a monitor or should generate traffic too.
- The test duration.
- The number of streams used when the Multistream option is installed.
- The Line Load Profile to use.
- The Frame Size Profile to use.
- The type of payload to use.
- Whether the destination addresses are specified.
- Whether thresholds should be applied.
- Whether the SDT results will be used or not, and whether thresholds should be applied.
- Whether the Channel Stats results will be used or not, and which keys and options are of interest.

3.3.2 Generator Test Results

Note:

In V3.00 and higher, when the Test schedule is running, pressing the **Start** key will cause the menu shown below to be displayed. In addition, if an instance of the Generator test is running, the results mode is set to Cumulative, and both ports are set to Duration/Mode of Continuous, then an additional menu item, Reset Test, is available on the menu.

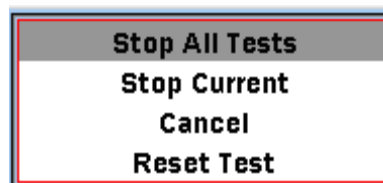

If this menu item is selected, all of the statistics (Cumulative, SDT, and Channel Stats) will be re-set, and the collection process will be re-started.

The **Generator Result** screen (Figure 3.3.2-1, Figure 3.3.2-2, Figure 3.3.2-3, Figure 3.3.2-4 and Figure 3.3.2-5) are accessed from the **Result overview** screen. They summarize traffic flow based on streams. Use the **Port (F3)** and **Stream (F4)** soft keys to select which results are displayed.

Table 3.3.2-1 Generator Test - Monitor Results

Item	Description
TX,RX Total Frames	Number of good unicast and broadcast frames transmitted by the port/stream. Number of good unicast frames received by the port/stream
Unicast Frames	Number of good unicast frames transmitted by the port/stream.
TX Broadcast Frames	Number of broadcast frames transmitted by the port/stream.
TX,RX Errored Frames	Number of frames transmitted and received with errors for the port/stream
TX,RX Total Bits	Number of good unicast and broadcast bits (excluding overhead bits) transmitted by the port/stream. Number of good unicast bits (excluding overhead bits) received by the port/stream
TX,RX Throughput (Mbps)	Number of good unicast and broadcast bits (excluding overhead bits) transmitted by the port/stream. Number of good unicast bits (excluding overhead bits) received by the port/stream. Expressed as an average rate in Mbps. See Figure 3.8.1-6.1 (Physical Layer no preamble) for a graphical depiction of the bytes that are counted in the throughput calculation.
TX,RX Utilization (%)	Number of good unicast and broadcast bits (including overhead bits) transmitted by the port/stream. Number of good unicast bits (including overhead bits) received by the port/stream. Expressed as an average rate in percentage of full capacity of the link speed.
TX,RX Throughput (%)	Number of good unicast and broadcast bits (excluding overhead bits) transmitted by the port/stream. Number of good unicast bits (excluding overhead bits) received by the port/stream. Expressed as an average rate in percentage of full capacity of the link speed. See Figure 3.8.1-6.1 (Physical Layer no preamble) for a graphical depiction of the bytes that are counted in the throughput calculation.
Frame Loss (not shown if Stream ID Control is set to Any Source)	Number of frames lost, based on the current frame loss calculation method (see Stream ID Control setting)
Frame Loss (%) (not shown if Stream ID Control is set to Any Source)	Number of frames lost as a percentage of the number of frames that should have been received, based on the current frame loss calculation method.



Generator 1  1000 Mbps  1000 Mbps 12:19:31 				Back	
Current	Cumulative	Graph	SDT		Channel Stats
		TX		RX	Stimuli
Total Frames	6.249999 M	6.249997 M			
Unicast Frames	6.249999 M	-			
Broadcast Frames	0	-			
Errored Frames	0	0			
Total Bits	4.999999 G	4.999998 G			Port A
Throughput (Mbps)	833.3332	833.3329			
Utilization (%)	100.0000	100.0000			
Throughput (%)	83.3333	83.3333			
		TX (Port B) - RX (Port A)			Stream 1
Frame Loss			2		
Frame Loss (%)			0		

Figure 3.3.2-2 Generator Results, Cumulative Tab









Generator 1  1000 Mbps  1000 Mbps 17:39:35 				Back	
Current	Cumulative	Graph	SDT		Channel Stats
TX Utilization (%)					Stimuli
TX Throughput (%)					
RX Utilization (%)					Port A
RX Throughput (%)					
Errored Frames (%)					Stream 1

Figure 3.3.2-3 Generator Results, Graph Tab



Generator 1  1000 Mbps  1000 Mbps 18:09:07 				Back
Current	Cumulative	Graph	SDT	
		(hh:mm:ss:usec)		Stimuli
SDT Threshold		00:00:00:000010		
Min		00:00:07:185667		
Max		00:00:07:185667		
Count		1		
Average		00:00:07:185667		Port A
Total		00:00:07:185667		
		(yyyy:mo:dd:hh:mm:ss)		Stream 1
Last Frame Received		2010:09:12:18:09:06		
Total Test Time		00:01:00		
Total SDT (%)		11		

Figure 3.3.2-4 Generator Results, SDT Tab

See Section 3.3.1 “Generator Test Setup” for a description of the SDT (Service Disruption Time) test.

Table 3.3.2-2 Generator Test – SDT Results

Item	Description
SDT Threshold	This is the threshold set by the user. It is shown on the display for reference.
Min	Smallest (shortest) service disruption seen so far.
Max	Largest (longest) service disruption seen so far.
Count	Count of all service disruptions (IFGs that exceeded the SDT threshold)
Average	Total / Count
Total	Accumulated time of all service disruptions (IFGs that exceeded the SDT threshold)
Last Frame Received	Timestamp of the last one second interval where at least one frame was received. Used to mark the start of a long disruption that is still in progress.
Total Test Time	Elapsed time since the test started
Total SDT (%)	Total disruption time as a percentage of total test time.

If option MU909060/A1/A2/A3-006 (Channel Statistics) is installed on the unit, the Channel Stats results screen will be displayed, as shown in Figure 3.3.2-5.

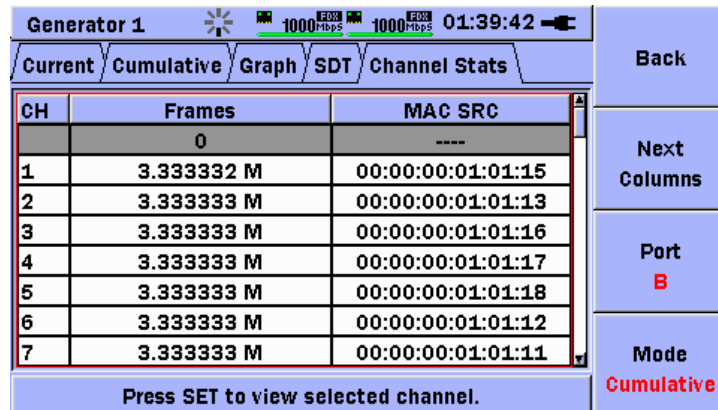

CH	Frames	MAC SRC
0		----
1	3.333332 M	00:00:00:01:01:15
2	3.333333 M	00:00:00:01:01:13
3	3.333333 M	00:00:00:01:01:16
4	3.333333 M	00:00:00:01:01:17
5	3.333333 M	00:00:00:01:01:18
6	3.333333 M	00:00:00:01:01:12
7	3.333333 M	00:00:00:01:01:11

Figure 3.3.2-5 Generator Results, Channel Stats Tab

Notes:

- The Channel Stats result tab is not stream specific, so no Stream softkey is shown.
- The Channel Stats result tab shows a maximum of sixty-four channels. There are a maximum of sixty-three auto-discovered channels and one **overflow channel**. The **overflow channel** is always shown in the first row of the table and does not contain any key values.
- The **overflow channel** will include statistics for all frames with key fields that do not match an existing channel. For normal operation, the overflow channel will not include any data unless all sixty-three auto-discovered channels are occupied.

There are two exceptions to the note above:

1. If at least one of the selected keys is of VLAN (or MPLS) type, then the **overflow channel** will include statistics for all frames that do not contain exactly the number of VLAN tags (or MPLS labels) specified in the **VLAN Levels (or MPLS Levels)** field, entered in the Channel Stats setup screen.
2. If the Mode selection on the Channel Stats setup screen is set to Top Talker, then the **overflow channel** will include statistics for all channels that were automatically removed from the table due to low throughput activity.

The Channel Stats results tab is composed of two (2) tables. The first table shows the channel number (CH), main counter and Key 1. The second table shows (CH), Keys 2 and 3 (if used). Press the **Next Columns (F2)** softkey to move between the tables.

The **Back (F1)** softkey will cause the application to return to the Test Schedule display.

The **Port (F3)** softkey will change the display between Port A and Port B. The label on the softkey describes the port being viewed. The position of the highlight bar is maintained independently for each port.

The **Mode (F4)** softkey will switch the display between Current (per second) and Cumulative results. The label on the softkey describes the type of statistics being viewed.

To see detailed statistics for a given channel, use the **Up** and **Down** arrow keys to move the highlight bar over the channel of interest. Press the **Set** key and a detailed screen for that channel will be presented, as shown in Figure 3.3.2-6.

Note:

The **Up** and **Down** arrow keys support “press and hold” to make navigation in the table faster.

Generator 1		1000 Mbps	1000 Mbps	09:11:59	Back
Current Cumulative Graph SDT Channel Stats					Back
Channel: 1 of 63					
MAC DST	00:00:00:00:00:B1				
NONE					
NONE					
Frames	3.400824 M				
Bits	29.192268 G				
Errors	0				Port B
[64-127]	46.831 k				
[128-255]	212.494 k				
[256-511]	425.467 k				
[512-1023]	851.118 k				Mode Cumulative
[1024-Jumbo]	1.864914 M				
[>Jumbo]	0				

Figure 3.3.2-6 Generator Results, Channel Detail

[1] The number of the channel being viewed is displayed on the button above the table of results. Press the **Up** arrow key to display the previous channel in the table or press the **Down** arrow key to display the next channel in the table.

To return to the full table view, press the **Set** key.

The **Back (F1)** softkey will cause the application to return to the Results Overview display.

The **Port (F3)** softkey will change the display between Port A and Port B. The label on the softkey describes the port being viewed.

The **Mode (F4)** softkey will switch the display between Current (per second) and Cumulative results. The label on the softkey describes the type of statistics being viewed.

Note:

The **Mode (F4)** softkey is not operative when the test is stopped. When the test is stopped and static data is displayed, the key will always show Cumulative mode.

Table 3.3.2-3 Generator Test / Channel Stats Detail Results

Item	Description
Key1 Label	The label for Key 1 is shown.
Key2 Label	The label for Key 2 is shown (or NONE)
Key3 Label	The label for Key 3 is shown (or NONE)
Frames	The number of frames received on the channel (current or cumulative).
Bits	The number of bits received on the channel (current or cumulative).
Errors	The number of errors received on the channel (current or cumulative).
64-127	The number of frames received on the channel (current or cumulative) that were between 64-127 bytes (inclusive) in size.
128-255	The number of frames received on the channel (current or cumulative) that were between 128-255 bytes (inclusive) in size.
256-511	The number of frames received on the channel (current or cumulative) that were between 256-511 bytes (inclusive) in size.
512-1023	The number of frames received on the channel (current or cumulative) that were between 512-1023 bytes (inclusive) in size.
1024-Jumbo	The number of frames received on the channel (current or cumulative) that were between 1024 and the “Jumbo frame size upper limit” (see section 3.2.3) bytes in size.
>Jumbo (Oversized)	The number of frames received on the channel (current or cumulative) that were greater than the “Jumbo frame size upper limit” bytes in size.

3.4 BER Test

The BER test is a quick and easy way to test a connection for bit errors. The BER test setup is similar to the Generator test setup, but the BER test can only be set for one stream. Refer to Section 3.3.1 “[Generator Test Setup](#)” for details.

3.4.1 BER Test Setup

Up to eight BER Tests can be added to the test schedule in **Test Automator**. Each test has separate set of parameters. To setup a BER test, press the  icon at the **Test Automator** screen. See Section 3.2.4 “[Test Automator](#)” for further information about **Test Automator**.

The BER test adds extra information to the transmitted frames that the receivers detect and report as errors if the information is missing.

The only panes specific for the BER test are the **BERT setup** pane and the **Thresholds** pane.

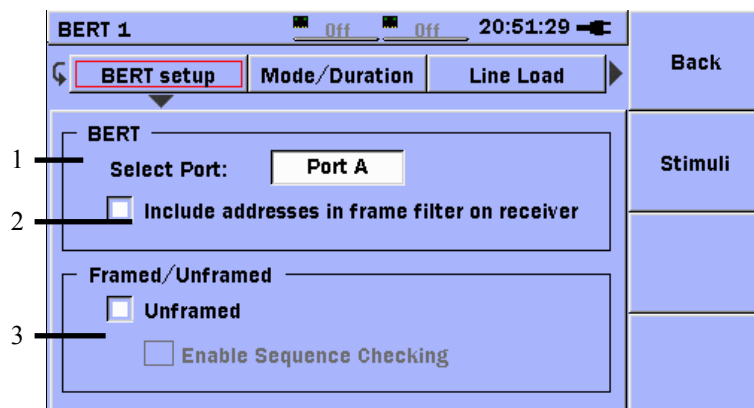
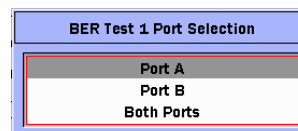

Figure 3.4.1-1 BERT Setup Pane

- [1] Select Port



Enables the test port(s).

- [2] Include address in filter on receiver

Adds extra filtering to specify what packets receiver detects

[3] Framed/Unframed

When **Unframed** is selected, the BERT generator transmits only a Preamble and payload with no headers. When using this type of transmission, it is also possible to add a sequence number to ensure data packets are received in the correct sequence.

Note:

When the **Both Ports** setting is selected at **Select Port**, a **Port** selection button is displayed at the **F3** soft key on both the **Setup** and **Results** screens.

The user may set thresholds on the BER result values shown in the table below. If one or more of the thresholds are violated, a violation will occur which will result in a FAIL indication on the Result Overview panel and an event will be logged (if the Log check box is selected for the threshold(s) that caused the violation).

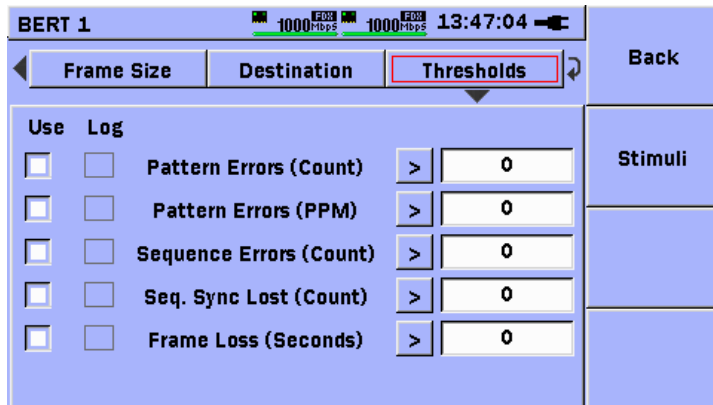

Figure 3.4.1-2 BERT Setup, Thresholds Pane

Table 3.4.1-1 BERT Threshold Selections

Item	Description
Pattern Errors	Number of received pattern bits
Pattern Errors	Pattern errors in PPM (parts per million)
Seq. Errors	Number of packages received out of sequence
Seq. Sync. Lost	Number of times sequence synchronization lost based on gap in received sequence numbers of ± 16
Frame Loss	Number of seconds with frame loss

3.4.2 BER Test Results

The **BER Test results** screen is accessed from the **Result overview** screen (see Section 2.6.1). It shows an overview of the incoming data and errors.

BERT 1		1000Mbps	1000Mbps	09:24:30	Back
Port A Results					Stimuli
Pattern Bit Count				0	
Pattern Bit Rate (Mbps)				0.00000	
Pattern Errors				0	
Pattern Errors(%)				0.00000	Port A
Seq. Errors				0	
Seq. Sync. Lost				0	
Frame Loss				0	
Frame Loss Seconds				11	Summary

Figure 3.4.2-1 BERT Results Screen

Table 3.4.2-1 BERT Test Results

Item	Description
Pattern Bit Count	Number of received pattern bits
Pattern Bit Rate (Mbps)	Number of received pattern bits as a rate in Mbps
Pattern Errors	Number of received errored pattern bits
Pattern Errors(%)	Pattern errors calculated as percentage
Seq. Errors	Number of packages received out of sequence
Seq. Sync. Lost	Number of times sequence synchronization lost based on gap in received sequence numbers of ± 16
Frame Loss	Number of lost frames when using framed BERT
Frame Loss Seconds	Number of seconds with frame loss

3.5 Stimuli

The Stimuli function is used to insert various errors, violations and alarms. It is accessed using soft keys and there are Stimuli for:

- **Generator Test** – F2 soft key
- **BER Test** – F2 soft key

Note:

Some types of errors are only supported by specific tests as explained later.

3.5.1 Stimuli Errors and Alarms

There are two main types of stimuli:

- **Alarms**
- **Error/Violations**

Alarm insertion can be enabled or disabled, whereas errors and violations can be inserted in bursts either manually or at intervals.



Figure 3.5.1-1 Stimuli Alarms pop-up

The **Alarms** pop-up which is the default Stimuli pop-up has two buttons:

- **Clear**
This button resets Stimuli settings.
- **Alarms**
This button reselects different types of alarms. When an alarm is selected, it is immediately enabled if a test is running.

To switch between **Errors/Violations** and **Alarms**, use the **Left** and **Right** arrow keys.

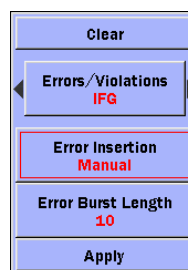

Figure 3.5.1-2 Stimuli Errors/Violations pop-up

The **Errors/Violations** pop-up has five buttons:

- **Clear**
This button resets Stimuli settings and switches the pop-up back to that the one shown in Figure 3.5.1-1.
- **Error/Violations**
This button selects the type of inserted error or violation.
- **Error Insertion**
This button defines how errors are inserted. Under normal circumstances, one of following can be inserted:
 - Off**
No Errors/Violations are inserted
 - Manual**
Sends selected error or violation each time **Apply** button pressed
 - Burst/Sec**
Sends burst every 1 s
 - Burst/10Sec**
Sends burst every 10 s
 - Burst*1E-2 to Burst*1E-7**
This Error Insertion setting is only supported by the error type PRBS Bit Error. When set the transmitted frames contains the selected ratio of PRBS bit errors.
- **Error Burst Length**
This button sets the number of errors per burst.
- **Apply**
This button applies the above settings. Changes do not take effect until this button is pressed.
The **Apply** button is only enabled during testing. Stimuli changes made during setup are applied when starting the test, unless **Manual** is chosen.

The Network Master can generate two types of alarms and 10 types of errors and violations.

Alarms:

Item	Description
No Link	Turns off current port to simulate link loss.
Remote Fault	Signals remote fault to link partner during auto negotiation.

Errors and Violations:

Item	Description
IFG	Detects Inter Frame Gap violation when two received frames are too close. The standard minimum IFG is 12 bytes.
FCS	Inserts frames with wrong Frame Check Sequence (FCS).
Preamble	Inserts Preamble 1 byte shorter than standard 8 bytes.
PAUSE frames	Used as Ethernet flow control method by sending Pause frames to stop transmitter for defined time.
IP Checksum	Generate frames with wrong IP header checksum.
Fragmented IP	Generate fragmented frames broken into smaller frames at IP layer level. This usually happens when frames are routed through a network.
Layer 4 Checksum	Inserts wrong UDP or TCP header checksum.
Error Symbol	Inserts errored symbol at PHY 10-bit coding.
PRBS Bit Error	Inserts bit error in PRBS payload.
BERT Seq. Error	Generates sequence error by changing sequence numbers of two frames used for BERT.

Note:

The **PRBS Bit Error** and **BERT Seq. Error** items are only supported at BER tests.

3.5.2 Using Stimuli

Stimuli are accessed from the test setup and results screens.

If a Stimuli setting is changed during setup, it is applied when the test is started. Manual insertion of Error/Violations are only applied when the apply button is pressed.

Errors, violations and alarms can be inserted when the test is running. Alarms are enabled immediately but errors and violations are enabled only when the **Apply** button is pressed. Use this button each time an error or violation is inserted manually.

Notes:

- Restarting the test does not clear the current Stimuli settings and they are reapplied when the insertion method is not set to **Manual** or **Off**. If not to reapply Stimuli, clear them before restarting the test.
- Each Generator test or BER test has separate Stimuli settings; if a test is removed from Test Automator and added again later, the stimuli settings will still be there.

3.6 Ping Test

The Ping test is a quick and easy way to test, troubleshoot and verify a connection and latency.

3.6.1 Ping Test Setup

Up to eight Ping tests can be added to the test schedule in **Test Automator**. Each test has its own set of parameters. To setup a Ping test, press the  icon at the **Test Automator** screen. See Section 3.2.4 “[Test Automator](#)” for more information on **Test Automator**.

The Ping setup screen consists of three panes:

- Destination
- Test Config.
- Thresholds

Destination pane

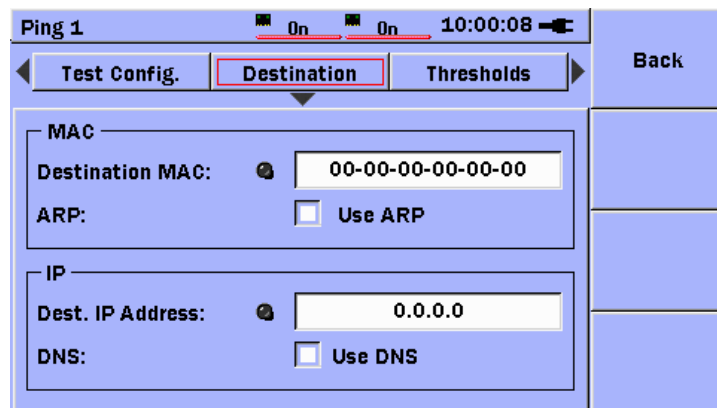

Figure 3.6.1-1 Ping Test Setup Screen, Destination Pane





MAC

The **Destination MAC** can be specified either manually or resolved by ARP lookup. Put a check mark in the **Use ARP** check box to enable ARP lookup.

IP

The **Dest. IP Address** can either be specified manually or resolved by DNS lookup. Put a check mark in the **Use DNS** check box to enable DNS lookup and input the host name.

The LED icon shows the lookup progress/result:

-  Black indicates lookup not execute.
-  Gray (Blinking) indicates lookup in progress
-  Green indicates lookup succeeded
-  Red indicates lookup failed

Test Config pane

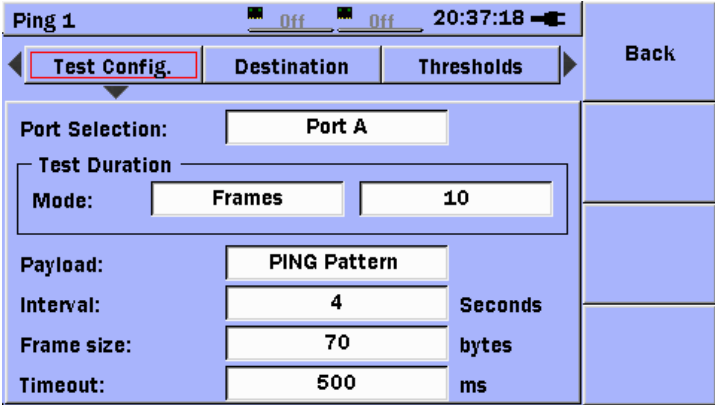

The screenshot shows a mobile application interface for configuring a ping test. At the top, it says 'Ping 1' with two 'Off' status indicators and a time of 20:37:18. Below this is a navigation bar with three tabs: 'Test Config.' (highlighted with a red box), 'Destination', and 'Thresholds'. To the right of the navigation bar is a 'Back' button. The main configuration area is divided into several sections:

- Port Selection:** A dropdown menu showing 'Part A'.
- Test Duration:** A sub-section containing a 'Mode' dropdown set to 'Frames' and a numeric input field set to '10'.
- Payload:** A dropdown menu showing 'PING Pattern'.
- Interval:** A numeric input field set to '4' with the unit 'Seconds' to its right.
- Frame size:** A numeric input field set to '70' with the unit 'bytes' to its right.
- Timeout:** A numeric input field set to '500' with the unit 'ms' to its right.

 A vertical 'Back' button is located on the right side of the screen, spanning the height of the configuration area.

Figure 3.6.1-2 Ping Test Setup Screen, Test Config. Pane

Table 3.6.1-1 Ping Test Configuration Selections

Item	Description
Port Selection	The test can run on either Port A or Port B.
Test Duration – Mode	The test can run in three different modes. Continuous when requiring continuous Ping test Seconds when time-limiting test in seconds Frames when limiting length by number of ping requests
Test Duration – Value	Frames or seconds
Payload	Select the bit pattern to be set in the payload of the Ping request frames
Interval	Number of seconds between ping requests Frames are transmitted back-to-back at 0.
Frame size	Frame size in bytes
Timeout	Timeout in ms

Notes:

- If the actual timeout period is longer than **Interval**, the **Interval** setting is overruled.
- When Continuous mode is set, the test runs until the user presses the **Start** key, which will stop the whole test schedule. All tests in the test schedule after this test are therefore never executed.

Thresholds Pane

The Threshold pane allows the user to set PASS/FAIL thresholds on two different Ping result fields:

- **Lost Responses (Count)** – if the number of lost responses is greater than the threshold, a violation will occur.
- **RTT (round trip time)** – if the maximum RTT value, extracted from the Ping response frame, exceeds the threshold, a violation will occur.

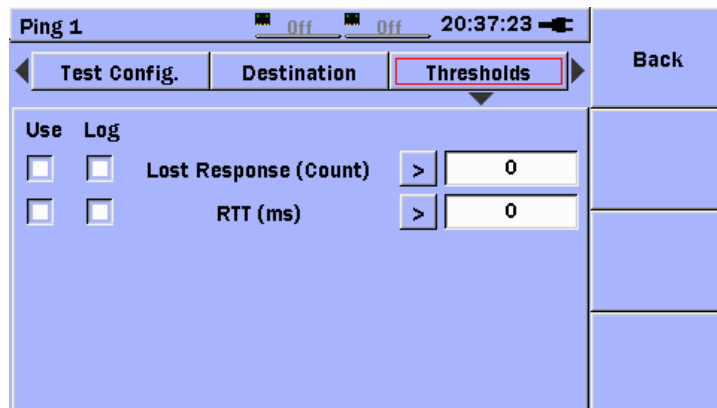

Figure 3.6.1-3 Ping Test Setup Screen, Thresholds Pane

3.6.2 Ping Test Results

The Ping results screen is divided into three parts.

- Port A/B ping results (left)
- Summary (top right)
- Round trip time (bottom right)

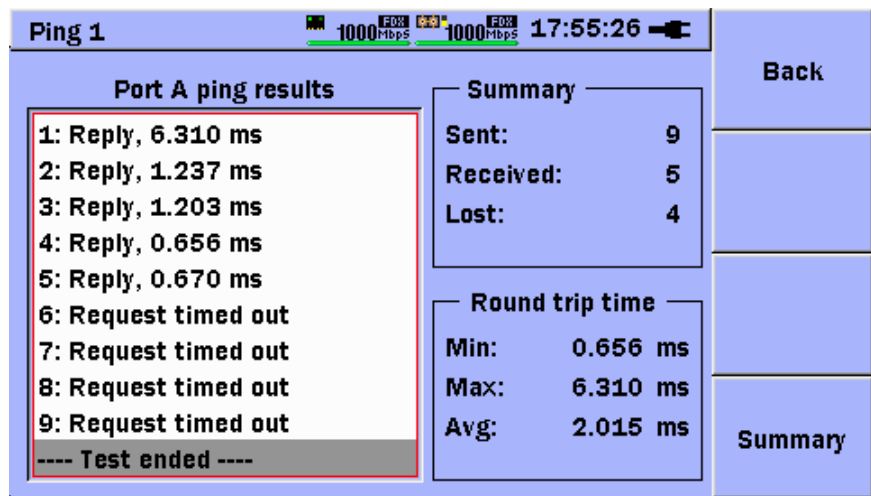

Figure 3.6.2-1 The Ping Results Screen

Table 3.6.2-1 Ping Test Results

Item	Description
Port A/B ping results	This lists the send requests. When a ping test is running, the list always contains the latest ping request. Navigate the list using the Up and Down arrow keys. Press the Set key to switch between the latest results and manually navigating the list.
Summary	This displays the number of sent requests and number of received and lost replies.
Round trip time	This displays the minimum, maximum and average round trip times.

3.7 Cable Test

The Ethernet Cable Test uses Time Domain Reflectometry (TDR) to validate and detect open and short CAT5/CAT5E cables. This test is useful for installing and troubleshooting cables.

Note:

The Ethernet Cable Test is designed to run on units equipped with built-in RJ-45 ports. The test will not operate properly when Electrical SFP devices are installed. Only the Electrical SFP identification information will be shown on the results screen.

3

Ethernet Application

3.7.1 Cable Test Setup

Up to eight Cable tests can be added to the test schedule in **Test Automator**. Each test has its own set of parameters. To setup the Cable test, press the  icon at the **Test Automator** screen. See Section 3.2.4 “[Test Automator](#)” for more information on **Test Automator**.

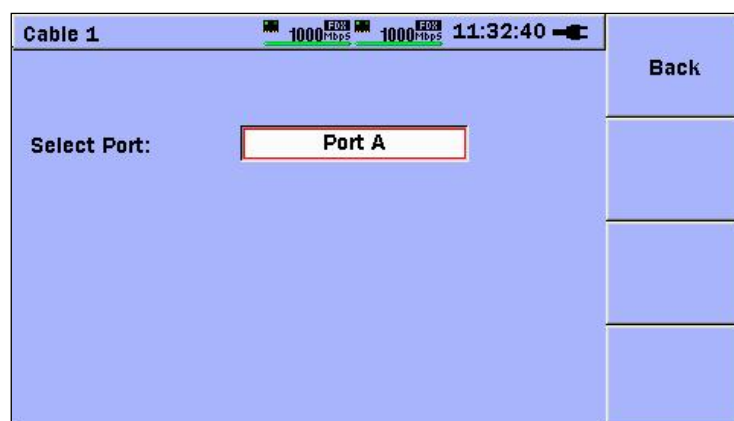

Figure 3.7.1-1 Cable Test Port Selector Screen

Press the **Set** key to display the port selector pop-up.

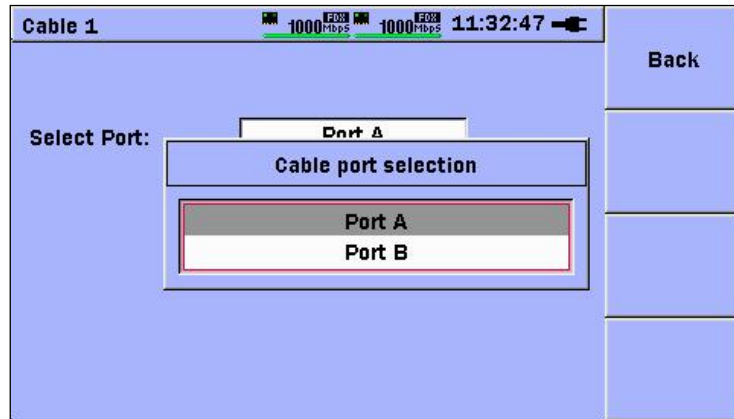

Figure 3.7.1-2 Cable Test Port Selection Pop-Up

Use the **Up** and **Down** arrow keys to select the test port and set the port using the **Set** key.

3.7.2 Cable Test Results

Pair	3	2	1	4
Pin	1/2	3/6	4/5	7/8
Status	Normal	Normal	Normal	Normal
Rx/Tx	BI_DA	BI_DB	BI_DC	BI_DD
Polarity	-	+	+	-
Length (m)	OK	OK	OK	OK
Amp	0.00	0.00	0.00	0.00
Skew (ns)	0	0	0	0

Figure 3.7.2-1 Cable Test Result Screen

- [1] Displays approximate cable length
- [2] Shows connected pin pairs
- [3] Shows status of pairs
The pair status can be:
 - Normal** – Pair neither short nor open
 - Short** – Pair has short circuit
 - Open** – Pair open
 - Fail** – Test failed
- [4] Shows whether pair Tx, Rx or bi-directional (e.g. BI DA, Bi directional Data A)
- [5] Shows pair polarity
- [6] Shows approximate length (± 1 m) to short or open circuit
OK is displayed when there is no short or open circuit.
- [7] Shows amplitude(Amp) of pair reflection ($-1V$ to $+1 V$)
- [8] Shows pair skew (± 8 ns)

3.8 RFC2544 Tests

RFC2544 is a benchmarking methodology that defines several tests for describing the performance characteristics of a network device (or complete network). The Network Master includes several setups (test modes) for covering all aspects of RFC2544 testing.

Note:

RFC2544 tests require the RFC2544 test option.

3.8.1 RFC2544 Throughput Test Setup

The **RFC2544 Throughput** test measures the highest line load at which the DUT (Device Under Test) can forward frames of specific size without lost frames. It also displays the frame loss rate for different line loads for a specific frame size.

Up to eight RFC2544 Throughput tests can be added to the test schedule in **Test Automator**. Each test has its own set of parameters. To setup a RFC2544 Throughput test, press the  icon at the **Test Automator** screen. See Section 3.2.4 “**Test Automator**” for more information on **Test Automator**.

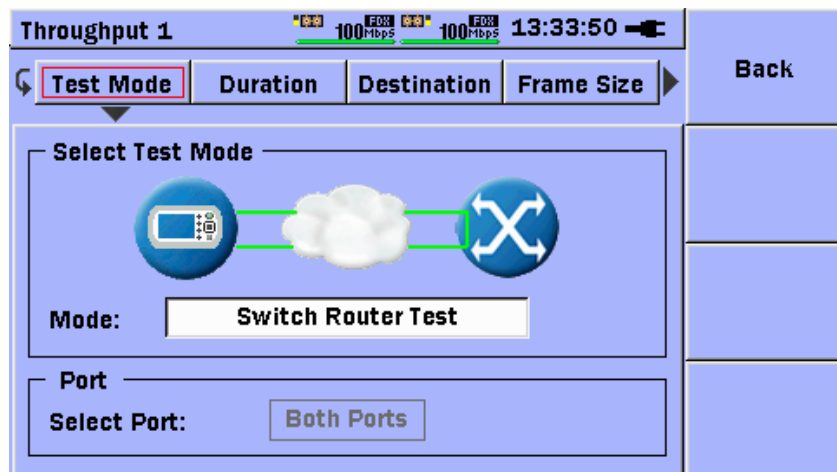

Figure 3.8.1-1 RFC2544 Throughput Setup Screen, Test Mode Pane

To return to the **Test Automator** screen, press **Back (F1)**.

Test Mode pane

The RFC2544 test mode and test port(s) are set at the **Test Mode** pane.

Note:

The RFC2544 tests run independently on two ports. If both ports are selected, the port panes display the **Port A/B** soft key. Use this soft key to select which port to set.

The RFC2544 **Throughput test** can run in three modes:

Table 3.8.1-1 RFC Throughput Configuration Selections

Mode	Description
Switch Router Test	In this mode Network Master tests the data link layer on a connected switch or router. Both ports must be active and linked. The IP and MAC addresses must be swapped, ensuring that the switch forwards frames from port A to port B and <i>vice versa</i> .
Single Ended Network Test	This test is used when testing network by reflecting traffic back to the Network Master. It requires a device to reflect the traffic back, such as a second Network Master in reflector mode.
End to End Network Test	In this test mode, two Network Master units work together performing a RFC2544 test. The unit initiating the test is the Master and the other unit is the Slave. Control data is sent from the Master on port A (or port B if only port B is used). When the test is started on the Master, the unit will try to contact the Slave on the control port using the Destination IP and MAC address (or using ARP if selected). If the slave receives the communication on a port with matching Source address, the test begins.

Note:

Apart from the Address setup, both the Master and Slave Network Master should have the **Accept incoming End-to-End configuration frames** option enabled. See Section 3.2.3 “[Advanced Setup](#)”.

The only setups at the Slave side are the source addresses and enabling of **Accept incoming End-to-End configuration frames**. The complete RFC2544 setup is transferred from the Master when the test is started.

Note:

When the test is started at the Master, a pop-up on the Slave indicates that the unit is being remotely controlled and displays a **Disconnect** key. The pop-up disappears when the test is completed or stopped at the Master.

When the test is completed, the test results are transferred from the Slave to the Master where they can be viewed by pressing the **Results Remote/Local** soft key.

End-to-End setup

When the End-to-End test mode is selected the **End to End** pane is displayed.

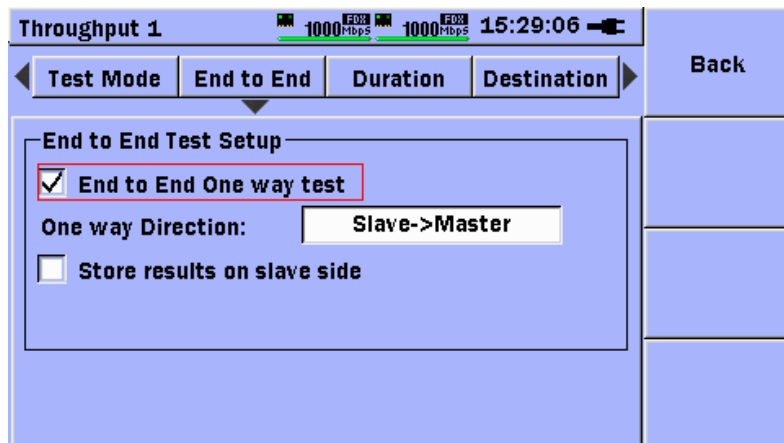

Figure 3.8.1-2 RFC2544 Throughput setup screen, End to End pane

When **End to End One way test** is selected, packets are sent only in one direction during the test. Use the **One way Direction** selection to specify the direction in which packets should be sent.

Test results can be stored on the slave if required. Select the **Store results on slave side** check box to enable this feature. Results are always stored on the Master side.

Duration pane

All RFC2544 tests are executed in steps. A step is a specific combination of a frame size and line load. During a step, frames with the specified size are transmitted at the specific line load. The number of steps run during a test depends on the selected number of frame sizes and line loads.

The **Step Duration** time can be set in number of seconds (min. 3 seconds) on the **Duration** pane. This is approximately the duration of each test step.

The **Test Repetitions** field sets the number of times the complete test will run. The possible setting range is 1 to 1000 times.

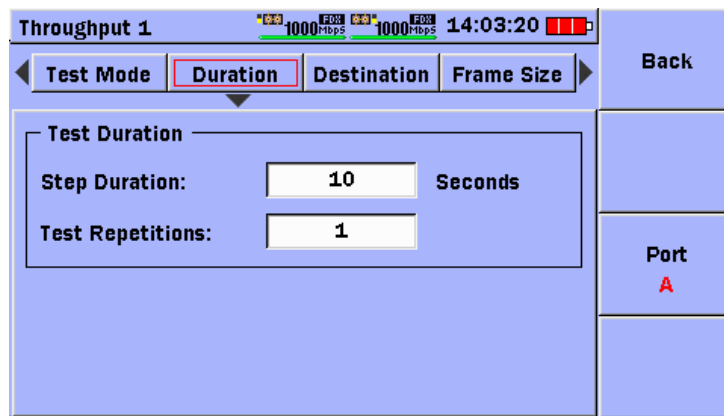

Figure 3.8.1-3 RFC2544 Throughput Setup Screen, Duration Pane

Destination pane

The destination setup is similar to that of the Ping test setup. See section 3.6.1 “[Ping Test Setup](#)” for further details.

Frame Size pane

The **Frame Size** pane has check boxes for the predefined sizes **64, 128, 256, 512, 768, 1024, 1280, 1518** and **User Defined**. The User Defined frame size can be set from 64 to 10000.

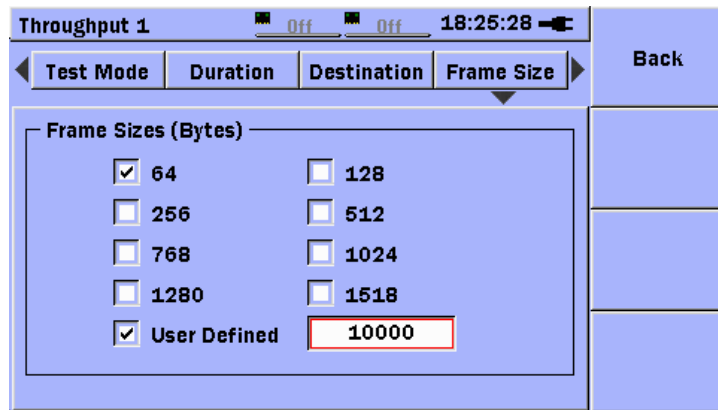

Figure 3.8.1-4 RFC2544 Throughput Setup Screen, Frame Size Pane

Note:

The RFC test cannot be started without selecting at least one frame size.

Line Load pane

The **Line Load** setting range used in the test is specified as **Min** and **Max**. The load is varied in intervals with the value specified in the **Step** field. The test always starts at **Max** and decreases until the line load is equal to **Min**. Line loads can be in either Mbps or as a percentage of the current line speed.

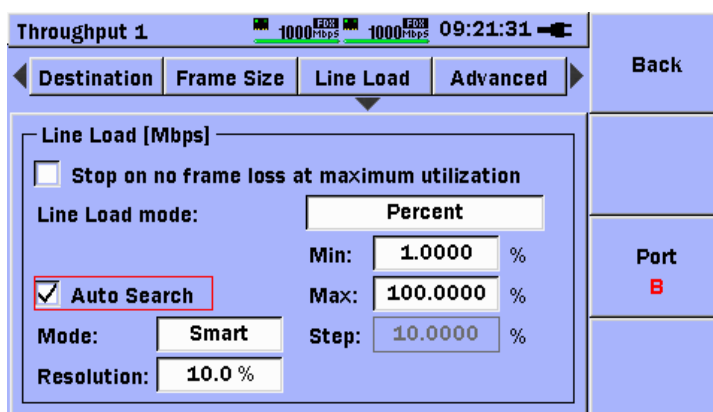

Figure 3.8.1-5 RFC2544 Throughput Setup Screen, Line Load Pane

If the **Stop on no frame loss at maximum utilization** check box is selected, the test continues to test the next frame size when the current test step at a specific line load and frame size do not have any frames lost. In other words, the test ignores the rest of the steps.

If the **Auto Search** check box is selected, the test finds the maximum line load at which no frames are lost, using the specified **Resolution** and search mode. When **Auto Search** is selected the **Step** parameter is not used.

Note:

The **Stop on no frame loss at maximum utilization** and **Auto Search** mechanisms cannot be enabled simultaneously.

Auto Search can run in two modes:

Binary	Performs binary search of specified line load interval from Max to Min
Smart	Assumes higher probability of frame loss occurring closer to Max and performs skewed binary search, searching higher line loads first

The **Resolution** field specifies the auto search precision as a percentage of the current line speed. A higher precision (lower percentage) increases the test duration. The supported precision is 0.1%, 1.0% and 10.0%.

Advanced pane

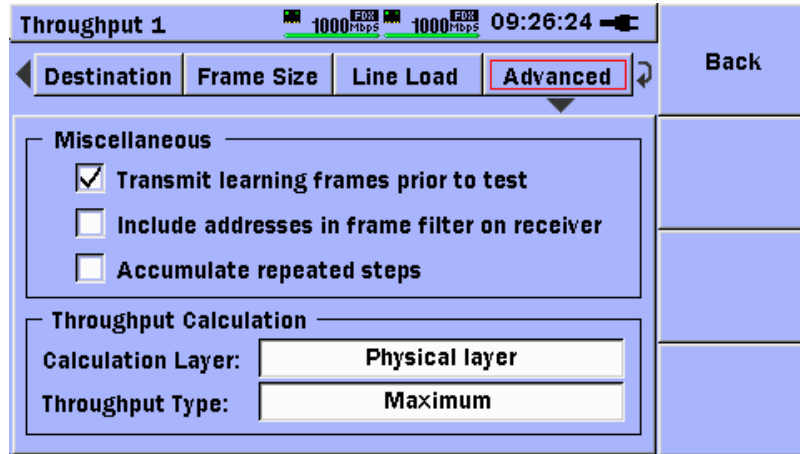

Figure 3.8.1-6 RFC2544 Throughput Setup Screen, Advanced Pane

Various test-specific settings are on the **Advanced** pane.

When the **Transmit learning frames prior to test** check box is selected, the RFC2544 test sends learning frames before the first test-step starts on each port. This is used to train the network-equipment, so initial results are more typical.

The receiver uses a filter to determine which frames should be counted in the results. When the **Include address in frame filter on receiver** check box is selected, the receiver uses the MAC and IP addresses of each incoming frame in addition to the 'filter key' used by default.

If more than one test repetition is performed (by setting **Test Repetitions** > 1 at the **Duration** pane), enabling the **Accumulate repeated steps** displays only one repetition in the result window. This repetition holds the accumulated results for all repetitions during the test.

Throughput can be calculated at different layers of the OSI model. Use the **Calculation Layer** field at the layer where throughput should be calculated, as indicated by Figure 3.8.1-6.1

Frame representation										Throughput Calculation	
IFG	Pre- amble	MAC header	VLAN (opt)	LLC (opt)	SNAP (opt)	IP head	UDP TCP	PAYLOAD	CRC	Data layer	UDP or TCP must be activated
IFG	Pre- amble	MAC header	VLAN (opt)	LLC (opt)	SNAP (opt)	IP head	UDP TCP	PAYLOAD	CRC	Network layer	
IFG	Pre- amble	MAC header	VLAN (opt)	LLC (opt)	SNAP (opt)	IP head	UDP TCP	PAYLOAD	CRC	Link layer	
IFG	Pre- amble	MAC header	VLAN (opt)	LLC (opt)	SNAP (opt)	IP head	UDP TCP	PAYLOAD	CRC	Physical Layer no preamble	
IFG	Pre- amble	MAC header	VLAN (opt)	LLC (opt)	SNAP (opt)	IP head	UDP TCP	PAYLOAD	CRC	Physical Layer	
Included in throughput calculation											

Figure 3.8.1-7 Frame Representation Table

All throughput calculations are averaged over 1-second measurement intervals. To average across the entire **Step Duration**, set the **Throughput Type** field to **Average**. Otherwise, the throughput values will be the **Maximum** obtained during the step.

Thresholds Pane

The user can set PASS/FAIL thresholds on the Frame Loss Max and Frame Loss Avg result fields, as shown in Figure 3.8.1-8. If one or more of the thresholds are enabled (Use check box is selected), then the results will be compared to the thresholds and a violation will occur if an active threshold is exceeded, which will result in a FAIL indication on the Result Overview display. If no threshold is violated a PASS indication will be shown on the Result Overview display. If both the Use and Log check boxes are selected, violations will also be recorded in the Event Log.

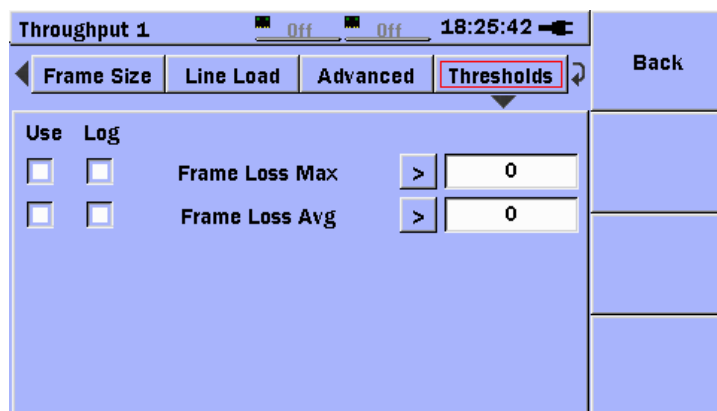

Figure 3.8.1-8 RFC2544 Throughput Setup Screen, Thresholds Pane

3.8.2 RFC2544 Latency Test Setup

The **RFC2544 Latency** test measures the latency of frames forwarded by the DUT to clarify the DUT processing overhead for forwarding forward frames. The test is performed for different line loads for a specific frame size.

Up to eight RFC2544 Latency tests can be added to the test schedule in **Test Automator**. Each test has its own set of parameters. To setup a RFC2544 Latency test, press the ⚙ icon at the **Test Automator** screen. See Section 3.2.4 “**Test Automator**” for more information on **Test Automator**.

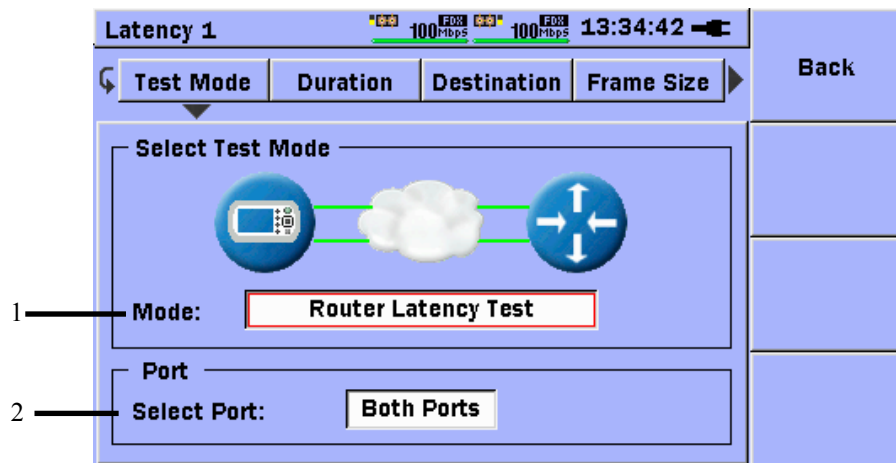

Figure 3.8.2-1 RFC2544 Latency Setup Screen, Test Mode Pane

To return to the **Test Automator** screen, press **Back (F1)**.

Test Mode pane

[1] Selects RFC2544 test mode

[2] Selects RFC2544 test port(s)

Note:

The RFC2544 tests run independently on two ports. If both ports are selected, the port specific panes display a **Port A/B** soft key. Use this soft key to select the port to setup.

The RFC2544 Latency test runs in three modes:

Router Latency Test	In this test mode, the latency-test sends ping frames to measure the response time for router equipment. The line load setup for the Router Latency Test is measured in kbps. The maximum line load for the Router Latency Test is 1000 kbps. The Network Master can respond to incoming ping frames, so it can be used to run the Router Latency Test port to port if required. The Router Latency Test supports both IPv4/ICMPv4 and IPv6/ICMPv6.
Switch Router Test	In this test mode, one Network Master can switch the data link layer of a switch or router. Both ports must be active and linked in this mode. IP and MAC addresses must be swapped, ensuring that the switch forwards frames from port A to port B and <i>vice versa</i> .
Single Ended Network Test	This test is used when testing network by reflecting traffic back to the Network Master. It requires a device to reflect the traffic back, such as a second Network Master in reflector mode.

Duration pane

All RFC2544 tests are executed in steps. A step is a specific combination of a frame size and line load. During a step, frames with the specified size are transmitted at the specific line load. The number of steps run during a test depends on the selected number of frame sizes and line loads.

The **Step Duration** time can be set in number of seconds (3 seconds) on the **Duration** pane. This is approximately the time duration of each test step.

The **Test Repetitions** field sets the number of times the complete test will run. The possible setting range is 1 to 1000 times. The Duration pane is similar to the RFC2544 Throughput Duration pane; see Figure 3.8.1-3.

Destination pane

The Destination setup is similar to that of the Ping test setup. See Section 3.6.1 “[Ping Test Setup](#)” for further details.

Frame Size pane

The **Frame Size** pane has check boxes for the predefined sizes **64, 128, 256, 512, 768, 1024, 1280, 1518** and **User Defined**. The User Defined frame size can be set from 64 to 10000. The Frame Size pane is similar to the RFC2544 Throughput Frame Size pane; see Figure 3.8.1-4.

Note:

The RFC test cannot be started without selecting at least one frame size.

Line Load pane

The line load range used in the test is specified as **Min:** and **Max:**. The load is varied in intervals using the value specified in the **Step** field. The test always starts at **Max:** and decreases until the line load is equal to **Min:**. Line loads are either in Mbps or as a percentage of the current line speed. However, in the **Router Latency** mode, line loads are presented in kbps.

Latency 1 On Off 17:38:49

Duration Destination Frame Size **Line Load** Back

Line Load (Ping Frames) [kbps]

Only run steps where preceding test passed

Line Load unit: kbps

Min: 10.000 kbps

Max: 1000.000 kbps

Step: 100.000 kbps

Port A

Figure 3.8.2-2 RFC2544 Latency Setup Screen, Line Load Pane in Router Latency Mode

The **RFC2544 Latency** test can refer the preceding **RFC2544 Throughput** test and only run passed steps. Select the **Only run steps where preceding test passed** check box to enable this feature and select a **Throughput** test in the **Reference Test** field.

Latency 1 1000Mbps 1000Mbps 13:26:37

Duration Destination Frame Size **Line Load** Back

Line Load [Mbps]

Only run steps where preceding test passed

Reference Test: RFC2544 Throughput 1

Tolerance Level (utilization multiplier): 100.0 %

Port A

Figure 3.8.2-3 RFC2544 Latency Setup Screen, Line Load Pane

Note:

The reference function requires the Throughput and Latency tests to be in the same mode. Hence, it cannot be used when the Latency test is in the **Router Latency** mode. The two tests must also use the same port(s).

Using the **Tolerance Level (utilization multiplier)** field, it is possible to tune the line loads used in the Latency test compared to the line loads used in the referenced Throughput test. If the **Tolerance Level** is 100.0%, the two tests use the same line loads; if 50.0% is set, the Latency test line loads are half the line loads of the Throughput test, etc.

Advanced pane

The advanced setup is similar to that of the RFC2544 **Throughput** test setup. See Section 3.8.1 “[RFC2544 Throughput Test Setup](#)” for further details.

Thresholds Pane

The user can set PASS/FAIL thresholds on the Jitter Max, Jitter Avg, Latency Max, and Latency Avg result fields, as shown in Figure 3.8.2-4. If one or more of the thresholds are enabled (Use check box is selected), then the results will be compared to the thresholds and a violation will occur if an active threshold is exceeded, which will result in a FAIL indication on the Result Overview display. If no threshold is violated a PASS indication will be shown on the Result Overview display. If both the Use and Log check boxes are selected, violations will also be recorded in the Event Log.

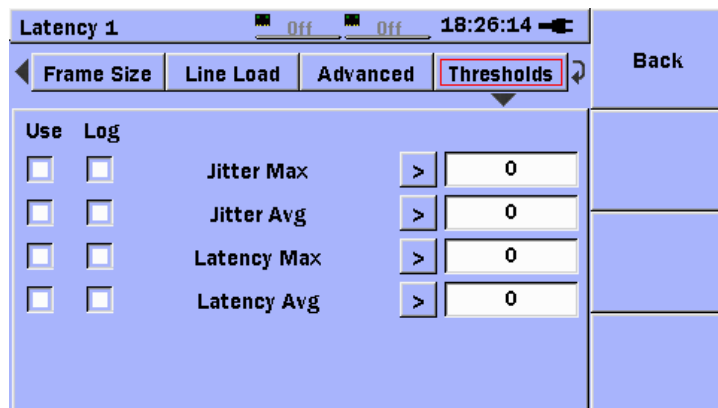



Figure 3.8.2-4 RFC2544 Latency Setup Screen, Thresholds Pane

3.8.3 RFC2544 Burst Test Setup

The **RFC2544 Burst** test is also called the burstability or back-to-back test. It determines the largest number of frames transmitted with minimum IFG (Inter Frame Gap) that the DUT can handle without frame loss.

Up to eight RFC2544 Burst tests can be added to the test schedule in **Test Automator**. Each test has its own set of parameters. To setup a **RFC2544 Burst** test press the  icon at the **Test Automator** screen. See Section 3.2.4 “Test Automator” for more information on **Test Automator**.

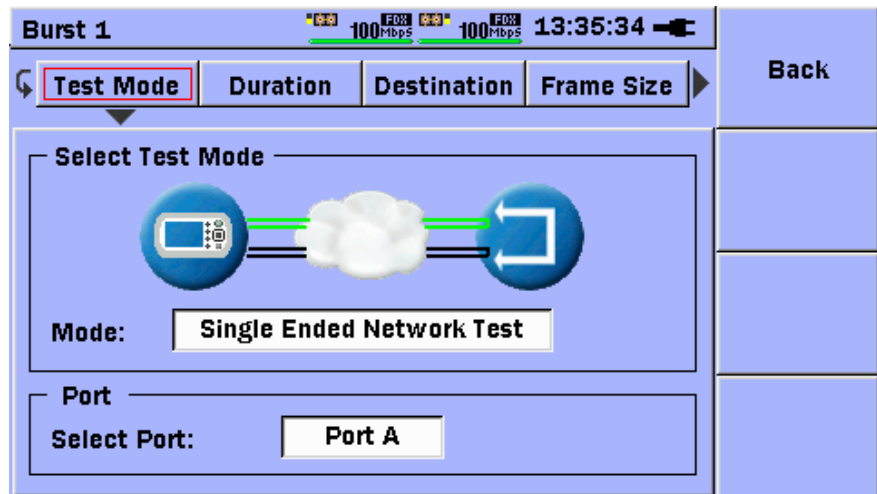

Figure 3.8.3-1 RFC2544 Burst Setup Screen, Test Mode Pane

To return to the **Test Automator** screen, press **Back (F1)**.

Test Mode pane

The **Test Mode** setup is similar to that of the **RFC2544 Throughput** test setup. See Section 3.8.1 “[RFC2544 Throughput Test Setup](#)” for further details.

Duration pane

All RFC2544 tests are executed in steps. A step is a specific combination of a frame size and burst size. During a step, a specific number of frames with a specified size are transmitted back-to-back. The number of steps run during a test depends on the selected number of frame sizes and burst sizes.

The **Step Duration** time can be set in number of seconds (3 seconds) on the **Duration** pane. This is approximately the time duration of each test step.

The **Test Repetitions** field sets the number of times the complete test will run. The possible setting range is 1 to 1000 times. The Duration pane is similar to the RFC2544 Throughput Duration pane; see Figure 3.8.1-3.

Destination pane

The Destination setup is similar to that of the Ping test setup. See 3.6.1 “[Ping Test Setup](#)” for further details.

Frame Size pane

The **Frame Size** pane has check boxes for the predefined sizes **64, 128, 256, 512, 768, 1024, 1280, 1518** and **User Defined**. The User Defined frame size can be set from 64 to 10000. The Frame Size pane is similar to the RFC2544 Throughput Frame Size pane; see Figure 3.8.1-4.

Note:

The RFC2544 test cannot be started without selecting at least one frame size.

Burst Size pane

Burst Sizes can be set in two modes: **Stepped** or **Constant**. Use the **Burst Mode** field to select the mode.

Figure 3.8.3-2 RFC2544 Burst Setup Screen, Burst Size Pane in Stepped Mode

In the **Stepped** mode, the test burst size range is specified by **Start burst size** and **End burst size**. The burst size is varied in intervals with the value specified in the **Step burst size** field.

Figure 3.8.3-3 RFC2544 Burst Setup Screen, Burst Size Pane in Constant Mode

In **Constant** mode, only one burst size is used for each frame size. The burst size is specified in the **Constant burst size** field.

Advanced pane

The advanced setup is similar to that of the **RFC2544 Throughput** test setup. See Section 3.8.1 “[RFC2544 Throughput Test Setup](#)” for further details.

Thresholds Pane

The user can set PASS/FAIL thresholds on the RX Frames Lost Max and RX Frames Lost Avg result fields, as shown in Figure 3.8.3-4. If one or more of the thresholds are enabled (Use check box is selected), then the results will be compared to the thresholds and a violation will occur if an active threshold is exceeded, which will result in a FAIL indication on the Result Overview display. If no threshold is violated a PASS indication will be shown on the Result Overview display. If both the Use and Log check boxes are selected, violations will also be recorded in the Event Log.

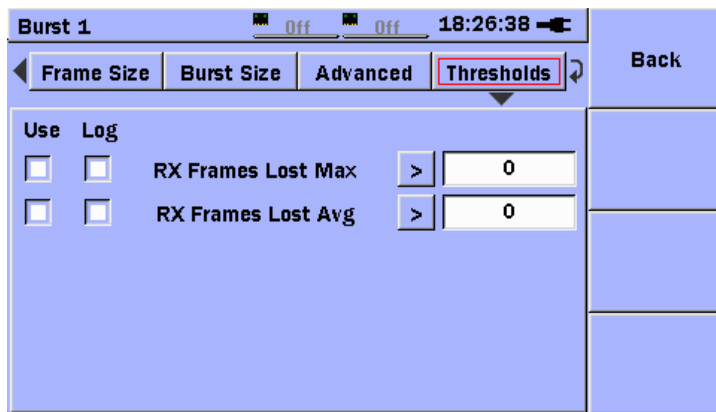

Figure 3.8.3-4 RFC2544 Burst Setup Screen, Thresholds Pane

3.8.4 RFC2544 Tests Results

The RFC2544 tests results screen is divided in two. The left side lists all currently tested steps. The steps are identified by **Repetition** and **Step** separated by a colon. During testing, the results reflect the currently running step. To navigate through previously performed steps, press the **Set** key. A gray frame is displayed around the currently shown step. Use the **Up** and **Down** arrow keys to navigate through the steps. Pressing the **Set** key again removes the gray frame and the results follow the currently running step automatically.

The right side of the screen displays results for the current step with transmission (Tx) data at the top and receive (Rx) results at the bottom.

Note:

Red numbers indicates frame loss.

RFC2544 Throughput:

Throughput 1		1000Mbps	1000Mbps	10:53:36	
Repetition:Step 1: 1 1: 2 1: 3 1: 4 1: 5 1: 6 1: 7 1: 8 1: 9 1: 10	Tx (Port A)			Back	
	Tx Utilization(Mbps)	900.0000			
	Tx Frame Size(bytes)	1.024 k			
	Tx Total Frames	323.275 k			
	Tx Frame Rate(Fps)	107.758 k		Port A	
	Rx (Port A)				
	Rx Total Frames	323.275 k			
	Rx Utilization(%)	90.0003			
	Rx Throughput(Mbps)	889.6583		Summary	
	Rx Frames Lost Min	0			
Rx Frames Lost Max	0				
Rx Frames Lost Avg	0				
Rx Loss Rate Min(%)	0.0				
Rx Loss Rate Max(%)	0.0				
Rx Loss Rate Avg(%)	0.0				

Figure 3.8.4-1 RFC2544 Throughput Results Screen, Single Ended Test Mode

Table 3.8.4-1 RFC Throughput Test Results

Item	Description
Tx Utilization(Mbps)	Transmitter use in Mbps
Tx Frame Size(bytes)	Size of transmitted frames
Tx Total Frames	Number of transmitted frames
Tx Frame Rate(Fps)	Transmitter frame rate
Rx Total Frames	Number of received frames
Rx Utilization(%)	Receiver use as percentage
Rx throughput(Mbps)	Receiver use in Mbps
Rx Frame Loss Min	Minimum frame loss for step
Rx Frame Loss Max	Maximum frame loss for step
Rx Frame Loss Avg	Average frame loss for step
Rx Loss Rate Min(%)	Lost frames divided by expected number of frames as percentage Minimum for step
Rx Loss Rate Max(%)	Lost frames divided by expected number of frames as percentage Maximum for step.
Rx Loss Rate Avg(%)	Lost frames divided by expected number of frames as percentage Average for step

RFC2544 Latency:

Latency 1		11:07:55		Back
Repetition:Step		Tx (Port A)		
1: 1	Tx Utilization(Mbps)	100.0000		
1: 2	Tx Frame Size(bytes)	1.024 k		
1: 3	Tx Total Frames	35.919 k		Port A
1: 4	Tx Frame Rate(Fps)	11.973000 k		
		Rx (Port B)		Summary
1: 5	Rx Total Frames	35.919 k		
1: 6	Rx Utilization(%)	9.9998		
1: 7	Rx Throughput(Mbps)	98.8491		
1: 8	Rx Jitter Min(us)	0.0		
1: 9	Rx Jitter Max(us)	0.2		
1: 10	Rx Jitter Avg(us)	0.0		
	Rx Latency Min(us)	1.8		
	Rx Latency Max(us)	1.9		
	Rx Latency Avg(us)	1.9		

Figure 3.8.4-2 RFC2544 Latency Results Screen, Switch Router Test Mode

Table 3.8.4-2 RFC Latency Test Results

Item	Description
Rx Jitter Min	Minimum jitter for step
Rx Jitter Max	Maximum jitter for step
Rx Jitter Avg	Average jitter for step
Rx Latency Min	Minimum latency for step
Rx Latency Max	Maximum latency for step
Rx Latency Avg	Average latency for step

Note:

When in the Router Latency Test mode, Mbps in Tx Utilization and Rx Throughput changes to kbps.

RFC2544 Burst:

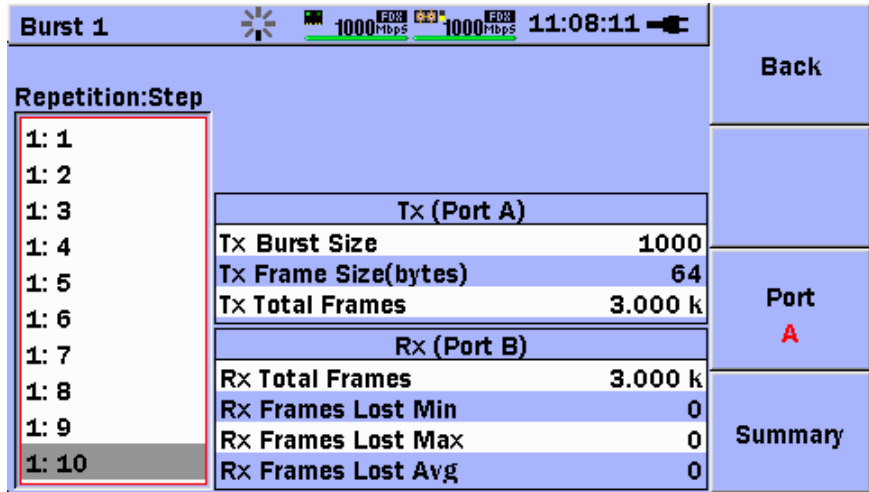

Figure 3.8.4-3 RFC2544 Burst Results Screen, Switch Router Test Mode

Table 3.8.4-3 RFC Burst Test Results

Item	Description
Tx Burst Size	Transmitter burst size
Rx Frame Loss Min	Minimum frame loss for step
Rx Frame Loss Max	Maximum frame loss for step
Rx Frame Loss Avg	Average frame loss for step

When **Accumulate repeated steps** is enabled, steps with the same **Frame Size** and **Line Load** are accumulated, meaning Min/Max/Avg is measured over all repetitions for a step.

To change the Tx port and corresponding Rx port, press the **F3** soft key.

Note:

The Tx and Rx ports vary with test mode and port relations. In the **Switch Router Test** mode, Port A transmits to Port B and *vice versa*. The Tx and Rx ports are then **Tx (Port A)** with **Rx (Port B)** and **Tx (Port B)** with **Rx (Port A)**.

When testing in the **End to End Network Test** mode, a new soft key labeled **Results** is displayed to change between local and remote results by pressing the **F2** soft key.



Figure 3.8.4-4 Results Soft Key showing Local Results (left) and Remote Results (right)

Note:

The **Results** soft key is only displayed when testing has ended.

3.9 HTTP/FTP Download Test

The HTTP/FTP download test is used to test the download throughput of a server or link by downloading a file from a remote server using HTTP or FTP protocol. The user must know the address of the server, the path where the file is located, and the name of the file. If FTP protocol is chosen, the user may also need to provide a user name and password to gain access to the FTP server.

3.9.1 HTTP/FTP Download Setup

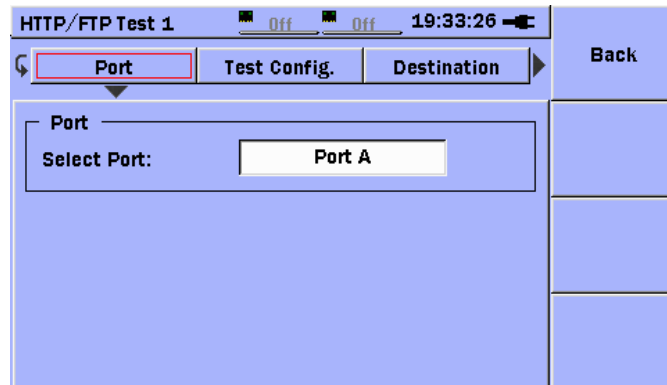

Figure 3.9.1-1 HTTP/FTP Setup, Port Pane

Navigate to the **Select Port** field and select the port on which to run the test. The HTTP/FTP download test runs on only one port at a time.

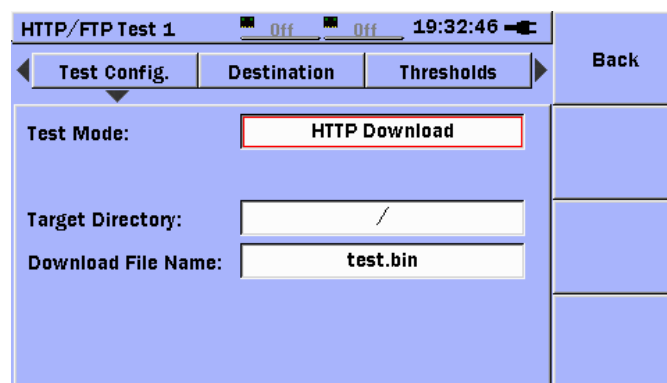

Figure 3.9.1-2 HTTP/FTP Setup, Test Config. Pane, HTTP Download Mode

Navigate to the **Test Mode** field and select the protocol to be used.

HTTP – Hypertext transfer protocol.

FTP – File transfer protocol

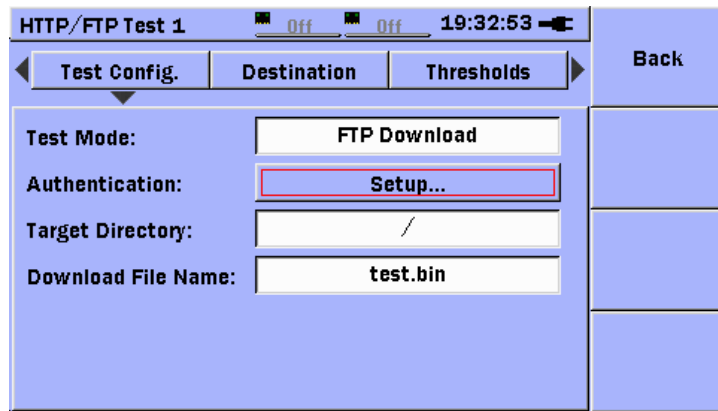

Figure 3.9.1-3 HTTP/FTP Setup, Test Config. Pane
FTP Download Mode

Navigate to the **Target Directory** field and press the **Set** key to access the input editor. Use the input editor to enter a directory name. Up to 128 characters can be entered.

Navigate to the **Download File Name** field and press the **Set** key to access the input editor. Use the input editor to enter a file name. Up to 128 characters can be entered.

Note:

The size of the file to be downloaded is limited to a maximum of 2GB.

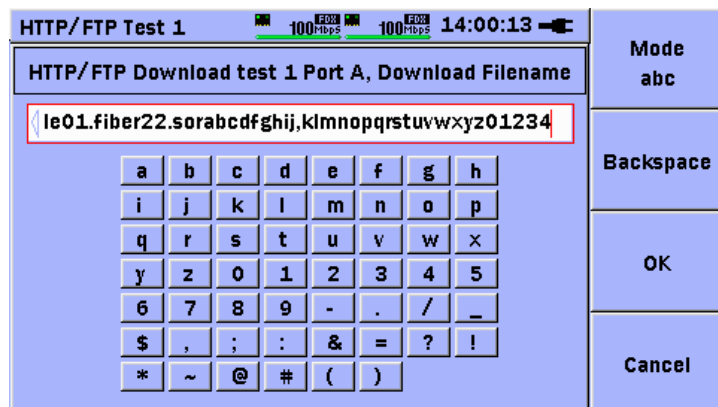

Figure 3.9.1-4 HTTP/FTP Setup, Download Filename Input Editor



Figure 3.9.1-5 HTTP/FTP Setup, Test Config. Pane, FTP Authentication Pop-Up

If FTP is selected, as shown in Figure 3.9.1-2, then authentication information must be supplied, as shown in Figure 3.9.1-3. If the user selects **Use anonymous**, then the user name and password will be sent as “anonymous” and “”, respectively. Anonymous authentication is generally only supported by servers in the public domain. The Target Directory and Download File Name and must also be supplied.

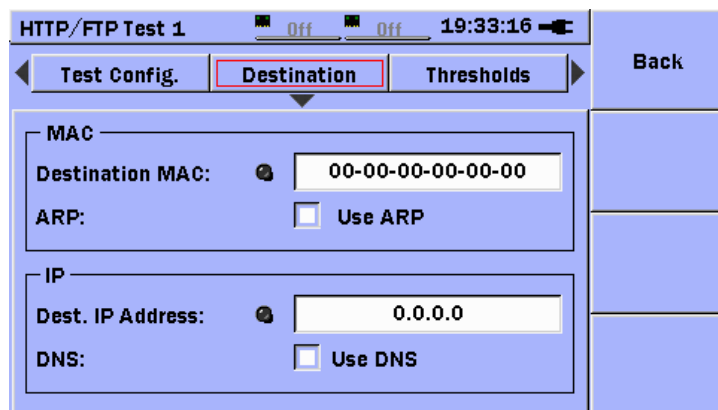

Figure 3.9.1-6 HTTP/FTP Setup, Destination Pane

This is the standard Destination panel that is used by applications on the MU909060A. Input the MAC Address and IP Address of the server to be accessed for the download test.

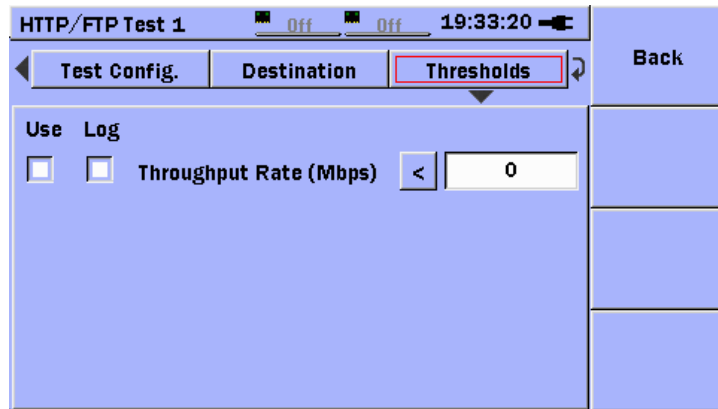

Figure 3.9.1-7 HTTP/FTP Setup, Threshold Pane

A threshold may be set on the average throughput rate. Note that the threshold can be setup to test for rates above or below a certain value. If average throughput for the test violates the threshold, a violation will occur which will result in a FAIL indication on the Result Overview display, and will cause an event to be logged if the both the Use and Log check boxes are selected.

3.9.2 HTTP/FTP Download Results

Sample results of the HTTP download test are shown in Figure 3.9.2-1 and sample results for the FTP download test are shown in Figure 3.9.2-2. The individual result fields shown on the display are described in the table below.

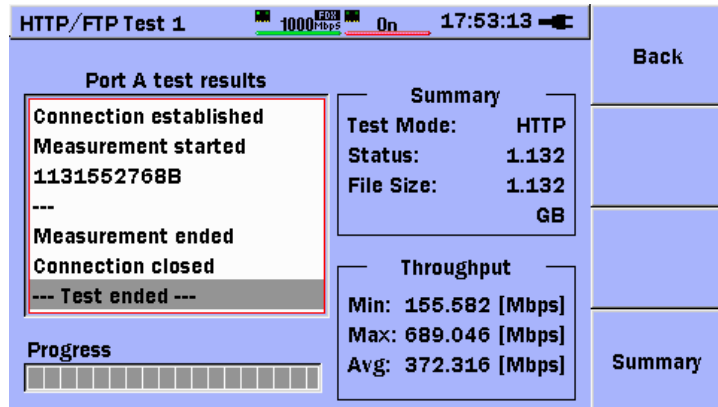

Figure 3.9.2-1 HTTP/FTP Download, HTTP Results

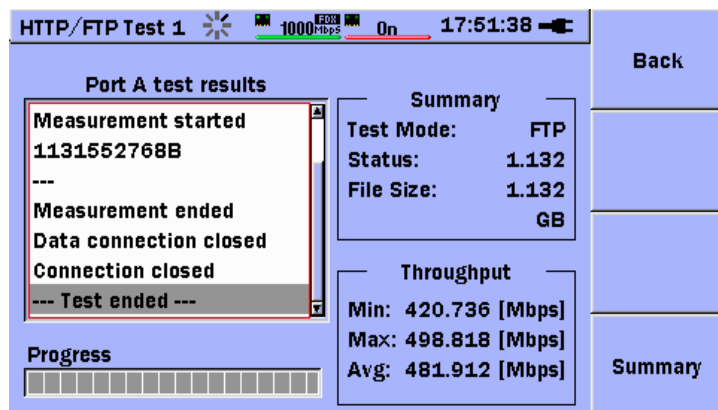

Figure 3.9.2-2 HTTP/FTP Download, FTP Results

Table 3.9.2-1 HTTP/FTP Download Test Result Panels

Section	Description
Test Results	The Test Results window shows many types of messages that indicate the status of the connection process. Once the connection is successfully established, the window shows bytes received in the current second and total bytes received.
Progress	The Progress Bar shows the progress of the test graphically.
Summary	The summary display group shows: Test Mode(protocol): HTTP or FTP Status: number of bytes received so far File Size: total size of the file being downloaded
Throughput	Minimum Throughput measured in a one second interval.
	Maximum Throughput measured in a one second interval.
	Average throughput measured since the start of the test

Note:

If the file that is downloaded is a very small size, the download may complete in less than one (1) second. In this case no value will be shown for the min, max, and average throughput. The size of the file to be downloaded is limited to a maximum of 2GB.

There are many messages that can be generated by the connection and download process. These messages are protocol specific and are separated into Normal Processing Messages and Abnormal Processing Messages. Normal messages show the progress of the interaction with the server. Abnormal messages indicate protocol errors that occurred as a result of the attempt to establish a connection and download a file. These are shown in the table below.

Table 3.9.2-2 FTP and HTTP Processing Messages

FTP Processing Messages	Description
Normal Processing Messages	
Connection established	
Data connection established	
Measurement started	
Measurement ended	
Data connection closed	
Connection closed	
--- Test ended ---	
Abnormal Processing Messages	
Can't establish	
--- Test terminated ---	
Invalid contents	Error in protocol
TCP General error	Socket read or write failed
Error [Error #]	General FTP Error with error code number
[Command name] Error [Error #]	General Command Error with error code
HTTP Processing Messages	
Normal Processing Messages	
Connection established	
Measurement started	
Measurement ended	
Connection closed	
--- Test ended ---	
Abnormal Processing Messages	
Can't establish	
--- Test terminated ---	
Invalid contents	Error in protocol
TCP General error	Socket read or write failed
HTTP error code[Error #]	General HTTP Error with error code number

3.10 Trace Route Test

The Trace Route test shows the route that packets will take to a specified destination and it collect statistics on the RTT (round trip time) from the source to each hop (router) in the path to the destination.

Trace Route works by sending a ping requests to the next hop (router or other network device) and collecting information from the responses received. The hop is specified by the TTL value of the ping request frame. The first ping requests will have a TTL value of 1 (hop 1). Each successive ping requests will have an incremented TTL value (next hop). The test will conclude when a ping reply is received or the maximum hop value, specified by the user, is reached.

As an individual ping request is moved along the network (from network device to network device) its TTL value is decremented. If the TTL value reaches zero the router will return an ICMP timeout exceeded (ICMP type 11) packet. If the ping request reaches its target, a ping reply will be received.

There are two (2) objectives for the test.

1. Create a list of IP addresses for the host devices in the path from the source to the destination.
2. Collect statistics on the RTT (round trip time) from the source to each host device in the path.

The first objective is achieved by collecting the source IP addresses from the response frames received, after a Ping is sent to the host.

The second objective is achieved by sending a batch of Ping requests to the host. For each batch of Ping requests the min, max and average response times will be calculated and each timeout will be counted. Timeouts will not affect the min, max or average response times. If all responses result in a timeout then '-' will be displayed for min, max and average response times. The '-' will indicate no valid response was received for this batch of ping requests.

The TraceRoute test is complete when ping replies are received or maximum hop is reached.

3.10.1 Trace Route Setup

The Trace Route Test Config. panel allows the selection of basic parameters that control the Trace Route test. The selections are described in Table 3.10.1-1 below.

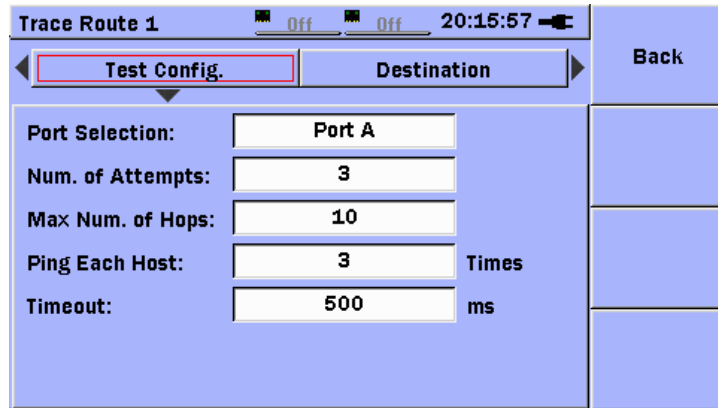

Figure 3.10.1-1 Trace Route, Test Config. Panel

Table 3.10.1-1 Trace Route Test Configuration Setup Selections

Item	Description
Port Selection	Port on which to run the test
Num. of Attempts	The number of times to ping each hop, attempting to receive a reply.
Max Num. of Hops	The maximum number of hops to pass through to reach the destination IP address.
Ping Each Host	The number of times to ping each host, to collect statistics on Min, Max, Average RTT, and Lost replies.
Timeout	Amount of time to wait for a response to a Ping request.

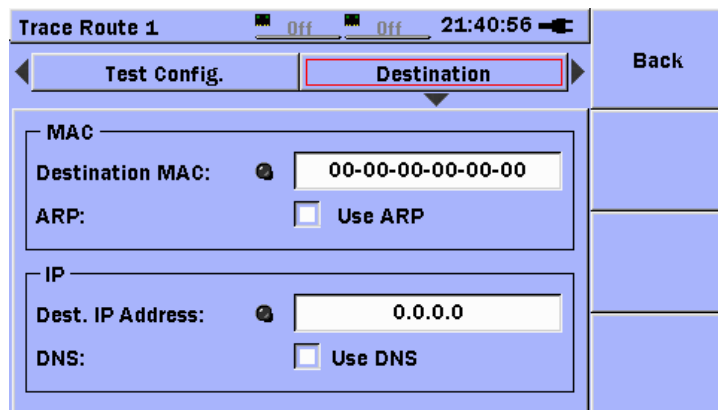

Figure 3.10.1-2 Trace Route, Destination Panel

This is the standard Destination panel that is used by applications on the MU909060A. Input the MAC Address and IP Address of the destination to be traced.

Note:

It is generally necessary to setup proper source addressing for Stream 1 in Interface Setup, including MAC, IPv4, DNS Servers (if using DNS), and Gateway.

3.10.2 Trace Route Results

The Trace Route Results panel is comprised of two pages that show the host addresses and RTT statistics collected by the Trace Route test.

Hop #	Host IP	Rcvd/Lost
4	[24.24.7.241]	3/0
5	[66.109.6.72]	3/0
6	[66.109.6.24]	3/0
7	[66.109.6.26]	3/0
8	[66.109.6.28]	3/0
9	[66.109.6.167]	3/0
10	[66.109.9.161]	3/0
11	[216.115.108.69]	3/0
12	[66.196.112.205]	3/0
13	[69.147.125.65]	3/0

Figure 3.10.2-1 Trace Route, Results Page 1 of 2

Table 3.10.2-1 Trace Route Test Host/Response Result Columns

Output	Description
Hop #	The order in which the host was reached.
Host IP	The IP address of the device that replied to the Ping request when the TTL value of the Ping request = Hop # Notes: <ul style="list-style-type: none"> If the host at a hop # did not reply to any of the initial Ping requests, it's Host IP will be shown as <timeout> in the table. If the destination is reached, this field will be shown in GREEN in the last row of the table. Otherwise it is assumed that the destination was not reached before the maximum number of hops was exceeded.
Rcvd / Lost	The number of replies / non-replies received in response to the Ping requests sent to the host at Hop #

Hop #	Min Time [ms]	Max Time [ms]	Avg Time [ms]
4	19.837	35.708	25.151
5	32.940	53.827	44.312
6	43.369	94.914	61.284
7	42.202	44.890	43.339
8	50.763	60.829	54.394
9	50.741	52.940	51.507
10	48.957	49.469	49.193
11	37.408	49.771	41.573
12	47.319	53.726	50.098
13	46.567	48.788	47.999

Figure 3.10.2-2 Trace Route, Results Page 2 of 2

Table 3.10.2-2 Trace Route Test RTT Result Columns

Output	Description
Hop #	The order in which the host was reached.
Min Time [ms]	The minimum of the RTTs extracted from the Ping replies received from the host at the hop #
Max Time [ms]	The maximum of the RTTs extracted from the Ping replies received from the host at the hop #
Avg Time [ms]	The average of the RTTs extracted from the Ping replies received from the host at the hop #

The user can change the display of the results screens from (1 of 2) to (2 of 2) or (2 of 2) to (1 of 2) by pressing the **Left** or **Right** arrow keys. The Hop # is displayed on both screens so the user can track the results for a particular hop across screens. The position of the highlight bar is also maintained across screens to make tracking the results for a particular hop easier.

3.11 Y.1564 Suite

The Y.1564 Suite application is compliant with the ITU-T Y.1564 standard for Ethernet Service Activation Test methodologies. The Y.1564 Suite includes the Y.1564 Config Test, for service configuration testing and the Y.1564 Perform Test for service performance testing, as defined in the standard.

The Y.1564 Config Test tests each defined Ethernet service to insure that the network configuration is correct. Each of the important performance parameters (IR, FTD, FDV and FLR) is tested. Use this test to efficiently check that the network configuration is correct to carry the defined services from source to destination.

The Y.1564 Config test is normally run prior to the Y.1564 Perform test and is intended to uncover the network configuration problems that might cause the Y.1564 Perform test to fail. The Y.1564 Config Test is described in section 3.11.7.

The Y.1564 Perform Test is used to efficiently validate the quality of the Ethernet services over a medium to long time duration. The Y.1564 Perform Test is described in section 3.11.8.

3.11.1 Y.1564 Services

Other tests included in the MU909060A1/2/3 Ethernet application such as Generator, Ping, BERT, HTTP/FTP, RFC 2544, and Trace Route define a Stream as the basic unit of transmission and statistics collection. The Y.1564 Suite defines a Service as the basic unit for testing. A Service has a name, source and destination addressing, an SLA (Service Level Agreement) profile, and other attributes associated with it, as shown in Table 3.11-1 below. The fields indicated in **bold print** are the minimum set of fields required to define a Service. The other fields are optional depending on the types and modes of testing required, and extended addressing requirements. Each field is described in detail in section 3.11.6 below.

Table 3.11-1 Service Definition Fields

Field	Description
SRV#	A sequential number assigned by the application.
Service Name	A name that is given to the Service by the user.
Service Profile	A selection of OFF, Voice or Video. When set to Voice or Video, other fields in the Service definition are automatically set.
CIR	Committed Information Rate. An SLA parameter.
EIR	Excess Information Rate. An SLA parameter.
SRC IP	The Source IP Address (IPv4 or IPv6)
DST IP	The Destination IP Address (IPv4 or IPv6)
SRC MAC	The Source MAC Address
DST MAC	The Destination MAC Address
Color Mode	Defines the method and configuration of color markers that may be used for adaptive rate limiting on the network.
VLANs	VLAN configuration (TPID, Priority, CFI Flag, VID) if used.
Frame Profile	Defines the frame profile to be used for testing. Selections include Fixed Size, User Defined (fixed), and EMIX (see section 3.11.6, below Figure 3.11.6-49)
Payload Pattern	The binary pattern that will be carried in the (un-used) portion of each test frame's payload area.
CBS	Committed Burst Size. An SLA parameter.
EBS	Excess Burst Size. An SLA parameter.
Max FTD	The SLA threshold on the maximum value for FTD (latency).
Max FDV	The SLA threshold on the maximum value for FDV (jitter).
Max FLR	The SLA threshold on the maximum value for FLR (frame loss ratio).
MPLSs	MPLS configuration (Label, CoS Flag, TTL) if used.
UDP	UDP port numbers if used.
TCP	TCP port numbers if used.
LLC 1	LLC 1 header if used.
SNAP	SNAP header if used.

3.11.2 Y.1564 Suite – Test Configurations

The available test configurations are listed in the table below:

Table 3.11.2-1 Y.1564 Suite Test Configurations

Configuration	Units Required	Comments
Switch Router Test	1	Both ports used. One port transmits and one port receives (port A transmits to port B and port B transmits to port A).
Single Ended Network Test	1 (or 2 if MT909060A is used as a reflector)	Data is transmitted and received on the same port. A reflector or physical loop is used to return the data to the unit.
End to End Network Test	2	Data is transmitted from Local -> Remote (single direction) and optionally Remote->Local.

Switch Router Test

In this configuration, it is assumed that the transmitted Service frames are returned to the same unit on the opposite port. The address information from the Services of the sending port will be swapped and these addresses and the frame headers will be pre-programmed into the receiving port and used as filters that exclusively accept frames from the sending port.

Single Ended Network Test

In this configuration, it is assumed that the transmitted Service frames are returned to the same unit on the same port.

End to End Network Test

In this configuration, it is assumed that the test traffic is transmitted by a local MT909060A unit and received by another, remote, MT909060A unit. The ports may be connected in a matched manner (A->A, B->B) or in a crossed manner (A->B, B->A).

The test can be setup to run on one port only (A->A or A->B or B->A or B->B) or two ports (A->A and B->B or A->B and B->A).

The test can be set up to run in one direction (Local to Remote or Remote to Local) or both directions (Local to Remote and Remote to Local).

The end to end configuration uses special communication frames to communicate between the local and remote units. The communication frames include a special header so that they can be separated from the test traffic.

As a general rule, the port receiving the communication frames must be configured with the same address structure (VLAN, MPLS, etc.) as the sending port, and the MAC and IP source and destination addresses must be reversed, relative to the sending port.

On the local unit, these address fields will be defined in Service 1 of the Services table. On the remote unit, these address fields will be defined in Stream 1 of Interface Setup.

Notes:

- The Source MAC and IP from Stream 1 (Interface Setup) of the Remote unit must be entered into the Destination MAC and IP fields of Service 1 of the Local unit. This procedure must be followed even if Service 1 (on the Local unit) is not enabled for testing.
- For the End to End configuration test, it is necessary for the Local and Remote units to establish communications and then exchange configuration information. This process may take from ten (10) to thirty (30) seconds to complete, depending on network conditions, the number of Services enabled, and the types of tests that are selected.

Once communications has been established, a message will appear on the Remote (Slave) unit, as shown in Figure 3.11.2-1 below.

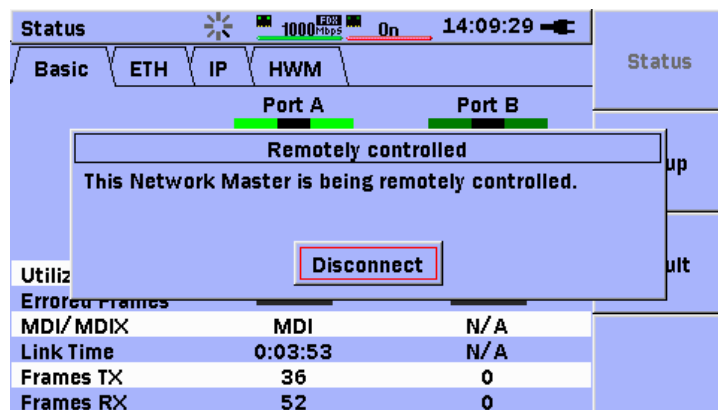

Figure 3.11.2-1 Remote Control Message on Slave Unit

The Local unit will send the complete Y.1564 configuration to the Remote unit. The Remote unit will use the address and frame header information in the Services Table to configure all of the filters needed for the test traffic to be exclusively accepted by the Remote unit. The Y.1564 Suite maintains a private copy of the information found in Interface Setup. This information will be used during the execution of the Y.1564 Suite test.

Upon completion of the test, the information from the primary copy of Interface Setup will be restored to the ports, and the message shown in Figure 3.11.2-1 will be removed.

3.11.3 Y.1564 Suite - Port Setup

Refer to the diagram at the beginning of Section 3.2 and enter the Interface Setup function. For the Y.1564 Suite, the Interface Setup function will be used *only* to setup the Ports, Filters, Advanced settings, and the Source MAC and Source IP address on the Remote (Slave) unit (in Stream 1), when the End to End Network Test mode is selected. Setup of the address fields for the Services in all other cases will be managed through the Services setup table which is described in section 3.11.6 below.

Note:

If the End to End Network Test mode is used (refer to section 3.11.5 below), two MU909060A units are required. For the Local (or Master) unit, the Setup of the address fields for the Services will be managed through the Services setup table which is described below. For the Remote (or Slave) unit, it is necessary to enter the Source MAC and Source IP address of the unit in Stream 1 of its Interface Setup, for each port that will be used. These source addresses will be used to establish a communication channel. For each port that is used, the Source MAC and Source IP from Stream 1 (Interface Setup) of the Remote (Slave) unit must be entered into the Destination MAC and Destination IP fields of Service 1 of the Local (Master) unit. This procedure must be followed even if Service 1 (on the Local unit) is not enabled for testing.

Refer to Figure 3.2.1-2 and configure the ports as required.

Refer to Section 3.2.2 to configure global filters on the **Filters** tab of Interface Setup if required.

Note:

Use caution when global filters are enabled as only frames that match the enabled filters will be processed.

Refer to section 3.2.3 to configure the advanced settings on the **Advanced** tab of Interface Setup.

Note:

Item [3] under Figure 3.2.3-1 must be enabled “(√)” if the **End to End Network Test** configuration of the Y.1564 Suite is used.

3.11.4 Test Automator – Adding a Y.1564 Test Instance

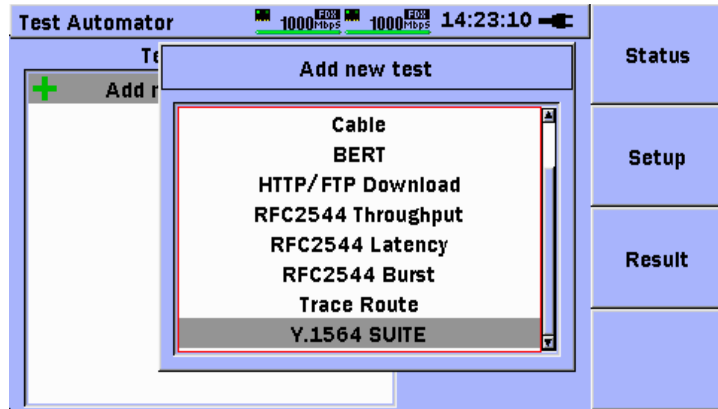

Figure 3.11.4-1 Test Automator – Adding a Y.1564 Suite Test

The Y.1564 Suite is a paid option with part number: MU909060A1/2/3-007/-307 Y.1564 test option. If the option is installed on the unit, the Y.1564 Suite will be available for selection in the “Add new test” dialog of the Test Automator function, as shown in Figure 3.11.4-1 above. Otherwise it will not be available for selection.

Note:

Only one (1) instance of the Y.1564 Suite can be added to the Test Automator list.

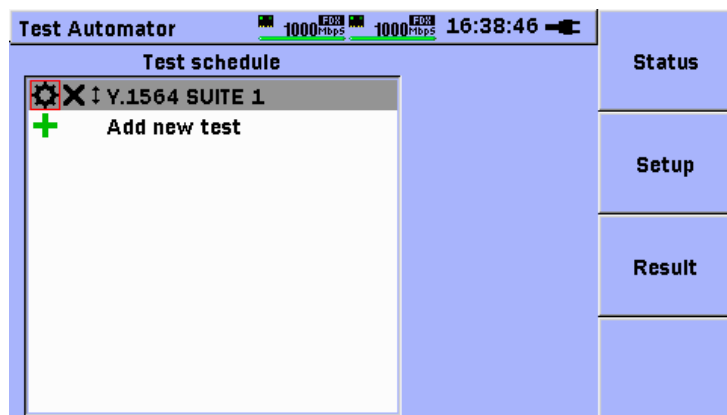

Figure 3.11.4-2 Y.1564 Suite Test Instance

Once a Y.1564 Suite instance has been added to the Test Automator, the user may highlight the Y.1564 Suite instance and press the **Set** key to enter the setup mode. The setup functions will be described in the following three (3) sections.

3.11.5 Y.1564 Suite – Test Mode Setup

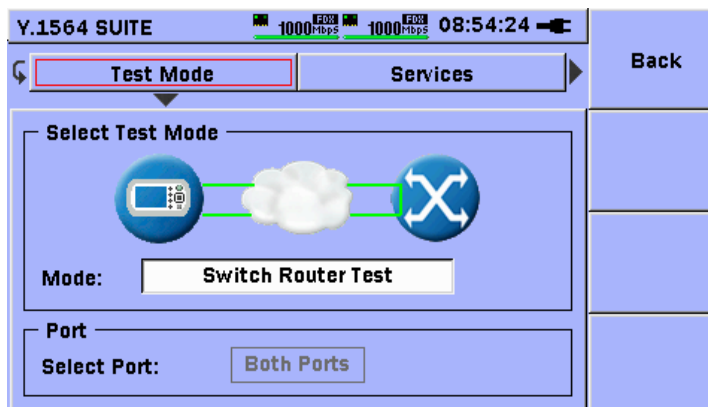

Figure 3.11.5-1 Y.1564 Test Mode Setup Screen

Refer to section 3.11.2 for a description of available test configurations. With the image shown above in Figure 3.11.5-1 on the display, press the **Down**-arrow key so the Mode: field is highlighted. Press the **Set** key and use the **Up/Down**-arrow keys to highlight the configuration to be tested. Press the **Set** key to complete the selection.

If the selected test mode has an option for port selection, the Select Port: field will be available; otherwise it will be grayed-out. If the field is available, press the **Down**-arrow key to move the highlight to the Select Port: field. Press the **Set** key to see a list of available Port selections. Use the **Up/Down**-arrow keys to highlight the desired Port configuration. Press the **Set** key to complete the selection.

If the **End to End Network Test** mode is selected, the **End to End** button will be displayed after the Test Mode button. Use the **Up/Right**-arrow keys to move the highlight to the **End to End** button as shown in Figure 3.11.5-2 below. Use the **Up/Down** arrow keys to move the highlight to the check-box to the left of the **End to End One way test** label.

Press the **Set** key to enable (√) or disable (un-√) this feature. If enabled (√), the test traffic will be transmitted in one direction only and it is necessary to select the direction. Press the **Down**-arrow key to move the highlight to the field to the right of the **One way Direction:** label. Press the **Set** key. Use the **Up/Down**-arrow keys to select the desired option:

Slave → Master – test traffic is transmitted only from the Slave(Remote) unit to the Master(Local) unit.

Master->Slave – test traffic is transmitted only from the Master(Local) unit to the Slave(Remote) unit.

Press the **Set** key to complete the selection.

Press the **Down**-arrow key to move the highlight to the check-box to the left of the “**Store results on slave side**” label. Press the **Set** key to enable (✓) or disable (un-✓) this feature. If this feature is enabled, the results of the test will be stored on the Slave(Remote) unit. If this feature is disabled, the results of the test will not be stored on the Slave(Remote) unit.

Press the **Down**-arrow key to move the highlight to the check-box to the left of the “**Show Estimated One Way FTD**” label. Press the **Set** key to enable (✓) or disable (un-✓) this feature. If this feature is enabled, an estimated value for one-way FTD (latency) will be shown in the results. The estimated value for FTD is based on a proprietary method for synchronizing the measurement clocks of the Local and Remote units. Exact clock synchronization is generally not possible without additional equipment, so this feature gives estimated results. If this feature is disabled, the value N/A will be shown in the results for FTD.

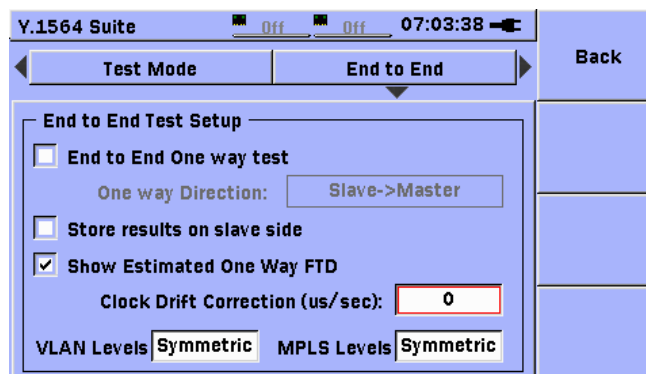

Figure 3.11.5-2 Y.1564 End to End Configuration Screen

If the End to End Network test with Estimated One Way FTD is run for a long period of time, the value for Estimated One Way FTD (as observed on the Local unit) may increase or decrease in a systematic way caused by “clock drift”. Clock drift is caused by slight variations in the clock speed of the Local and Remote units.

When the Estimated One Way FTD result is enabled, it is recommended to measure the clock drift and set the Clock Drift Correction factor before network testing is performed.

In the case where the clock on the Local unit is running faster than the clock on the Remote unit, the value for FTD Max (as observed on the Local unit) will continue to increase. In this case a **negative** Clock Drift Correction factor should be entered.

In the case where the clock on the Local unit is running slower than the clock on the Remote unit, the value for FTD Max (as observed on the Local unit) will continue to decrease and may eventually reach (and remain at) zero (0). In this case a **positive** Clock Drift Correction value should be entered.

The measured drift rate can be entered into the unit as a drift correction factor in $\mu\text{s}/\text{sec}$ units. Press the **Down**-arrow key to move the highlight to the field to the right of the “**Clock Drift Correction (us/sec):**” label. Press the Set key to display the input editor. Use the **Up/Down/Left/Right** arrow keys to enter a value. Press the Set key to accept the value and close the editor.

If no clock drift correction is desired, set the Clock Drift Correction value to zero (0) $\mu\text{s}/\text{sec}$

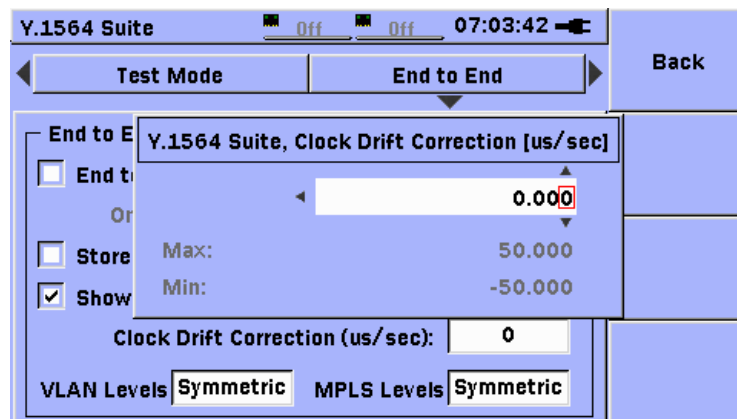

Figure 3.11.5-3 Enter Clock Drift Correction Factor

There are other factors such as operating temperature that can continue to dynamically affect clock drift. When using this feature the units should be allowed to reach a stable operating temperature before the drift rate is measured. If the operating environment is later changed (significantly) the units should again be allowed to reach a stable temperature and the drift rate should be re-measured under the new conditions.

Example of measuring clock drift:

To measure clock drift it is necessary to observe the FTD MAX value at time T and T+30sec. One method is to observe FTD Max value when the clock top bar of display is at xx: xx: 00, and again when the clock is at xx: xx: 30 (or other similar second interval)

Configure two units for an End to End Network test, using a short (1-3m) patch cord (if possible).

On the Local unit, make the following configuration:

1. Check “Show Estimated One Way FTD” (refer to Figure 3.11.5-2)
2. Set the Clock Drift Correction field to 0 μ s/sec.
3. Set up one Service with a simple CIR test
4. Set the Test/Step Time field on the Y.1564 Config Setup screen (refer to the bottom of Figure 3.11.7-1) to 60 seconds.
5. Press the Start key and go to the detail results view.(Refer to section 3.11.13 for information on the detailed results view)

Case 1:

If the FTD Max was observed to be increasing, as shown in Figure 3.11.5-4 below, then the clock on the Local unit is running faster than the clock on the Remote unit. Proceed to Test 1 below.

SRV #	FTD Min ~ (ms)	FTD Avg ~ (ms)	FTD Max ~ (ms)
1	0.016	0.078	0.146

Figure 3.11.5-4 Increasing FTD Max Value

Case 2:

If the FTD Max was observed to be decreasing (or remains at 0) as shown in Figure 3.11.5-5 below, then the clock on the Local unit is running slower than the clock on the Remote unit.

SRV #	FTD Min ~ (ms)	FTD Avg ~ (ms)	FTD Max ~ (ms)
1	0.000	0.000	0.000

Figure 3.11.5-5 Zero FTD Max Value

In this case, either:

- Reverse the roles of the units to create Case 1, and then execute Test 1.
- (or)
- Set the Clock Drift Correction field to 50 μ s/sec, and then execute Test 2.

Test 1:

When Clock Drift Correction field is set to 0 µs/sec:

1. Press the Start key
2. At a time T, record the FTD Max value.

SRV #	FTD Min ~ (ms)	FTD Avg ~ (ms)	FTD Max ~ (ms)
1	0.016	0.078	0.146

Y.1564 Results | 1000 Mbps | On | 13:15:30

Y.1564 Global | Y.1564 Config | Y.1564 Perform

Back

Port A

Summary

Press Set to view all Y.1564 Config results.

Figure 3.11.5-6 Time T Reading

3. At time T+30s, record the FTD Max value.

SRV #	FTD Min ~ (ms)	FTD Avg ~ (ms)	FTD Max ~ (ms)
1	0.016	0.138	0.260

Y.1564 Results | 1000 Mbps | On | 13:16:00

Y.1564 Global | Y.1564 Config | Y.1564 Perform

Back

Port A

Summary

Press Set to view all Y.1564 Config results.

Figure 3.11.5-7 Time T+30s Reading

Drift Correction setting = 0 µs / sec

Observed Max FTD @ time T = 0.146 ms

Observed Max FTD @ time T + 30 sec = 0.260 ms

⇒ Observed Drift = $1000 * (0.260 - 0.146) / 30 = 3.8 \mu\text{s} / \text{sec}$

- Enter **-3.8 µs / sec** into the Clock Drift Correction field.

Test 2:

When Clock Drift Correction field is set to 50 µs/sec:

1. Press the Start key
2. At a time T, record the FTD Max value.

SRV #	FTD Min ~ (ms)	FTD Avg ~ (ms)	FTD Max ~ (ms)
1	0.186	0.718	1.250

Figure 3.11.5-8 Time T Reading

3. At time T+30s, record the FTD Max value.

SRV #	FTD Min ~ (ms)	FTD Avg ~ (ms)	FTD Max ~ (ms)
1	0.186	1.415	2.645

Figure 3.11.5-9 Time T+30s Reading

Drift Correction setting = 50 µs / sec

Observed Max FTD @ time T = 1.250 ms
 Observed Max FTD @ time T + 30 sec = 2.645 ms

⇒ Observed Drift = $50 - (1000 * (2.645 - 1.250) / 30) = 3.5 \mu\text{s} / \text{sec}$

- Enter **3.5 µs / sec** into the Clock Drift Correction field.

Test 3:

1. Press the Start key
2. At time T, record the FTD Max value
3. At time T+30s, record the FTD Max value

Observed Max FTD @ time T = 0.001 ms

Observed Max FTD @ time T + 30 sec = 0.001 ms

$$\Rightarrow \text{Observed Drift} = (0.001 - 0.001) / 30 = \mathbf{0.0 \mu s / sec}$$

Test 3 shows that the clock drift has been corrected according to the calculations from Test 1 or Test 2.

Note:

The Clock Drift Correction factor may need to be adjusted up or down from the initial calculations (shown above) to stabilize the Max FTD reading. If, after initial correction, the Max FTD reading continues to increase/decrease or remains at 0ms, adjust the Clock Drift Correction factor by **0.1 μ s / sec (or smaller) increments** until the reading stabilizes.

As mentioned above, even if the procedure in the above example is followed and a suitable drift correction factor is entered into the software, there are other factors such as operating temperature that can continue to dynamically affect clock drift. The Clock Drift Correction factor should be considered an advanced feature to be used only when round-trip FTD measurements cannot be used.

Testing Asymmetric VLAN and MPLS Network Configurations

The End to End Configuration Screen shown in Figure 3.11.5-2 includes input fields for VLAN Levels and MPLS Levels. These input fields control the number of VLAN tags / MPLS labels that are used at each end of the network under test. The VLAN/MPLS levels can be the same (symmetric) or different (asymmetric). An asymmetric configuration may be needed if the network adds/drops one or more tags or labels.

Use the tables below to select the setting for the VLAN Levels and MPLS Levels respectively.

VLAN Levels Configuration		Remote Unit			
		N/A	1	2	3
Local Unit	N/A	Symmetric	None<->1	None<->2	None<->3
	1	1<->None	Symmetric	1<->2	1<->3
	2	2<->None	2<->1	Symmetric	2<->3
	3	3<->None	3<->1	3<->2	Symmetric

MPLS Levels Configuration		Remote Unit			
		N/A	1	2	3
Local Unit	N/A	Symmetric	None<->1	None<->2	None<->3
	1	1<->None	Symmetric	1<->2	1<->3
	2	2<->None	2<->1	Symmetric	2<->3
	3	3<->None	3<->1	3<->2	Symmetric

Notes:

- All VLAN tags to be used on either the Local or Remote unit are configured on the Local unit, as described starting with Figure 3.11.6-34 through Figure 3.11.6-45 below. All MPLS labels to be used on either the Local or Remote unit are configured on the Local unit, as described starting with Figure 3.11.6-65 through Figure 3.11.6-67 below.
- The Interface Setup of each unit (Local and Remote) must match the expected (VLAN, MPLS) configuration of the network, at the point where each unit is connected to the network, or the units will not be able to establish end to end communications.

To change the setting for the VLAN/MPLS Levels, use the **Up/Down/Left/Right**-arrow keys to move the highlight to the VLAN/MPLS Levels input field. Press the **Set** key to display the selection menu as shown in Figure 3.11.5-10 below:

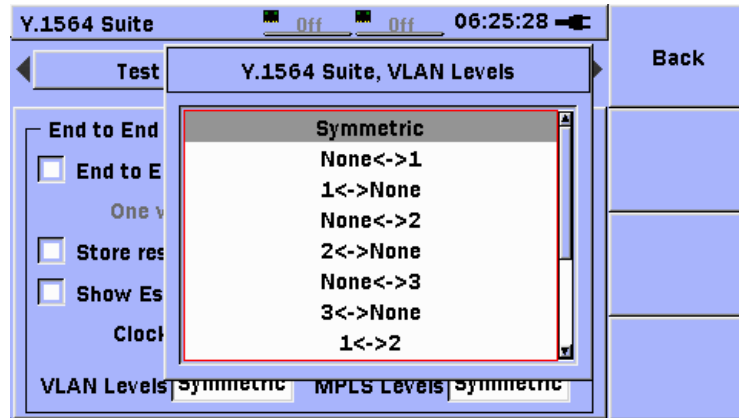

Figure 3.11.5-10 VLAN/MPLS Levels Selection Menu

Use the **Up/Down** arrow keys to move the highlight to the desired selection. Press the **Set** key to make the selection.

3.11.6 Y.1564 Suite - Services Setup

The Y.1564 Suite includes a **Services table** to make the definition and setup of Services easy. To access the Services table from the Test Mode setup screen, use the **Up/Down/Left/Right**-arrow keys to move the highlight to the Services button, as shown in Figure 3.11.6-1 below.

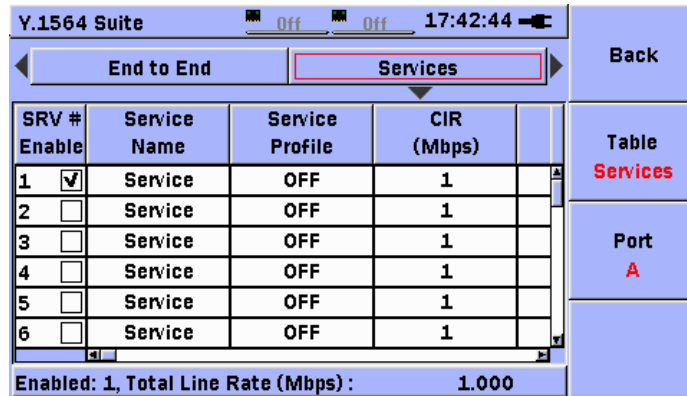

Figure 3.11.6-1 Y.1564 – Services Setup Button

Press the **Down**-arrow key to move the (RED) highlight selection to the Services table, as shown in Figure 3.11.6-2 below.

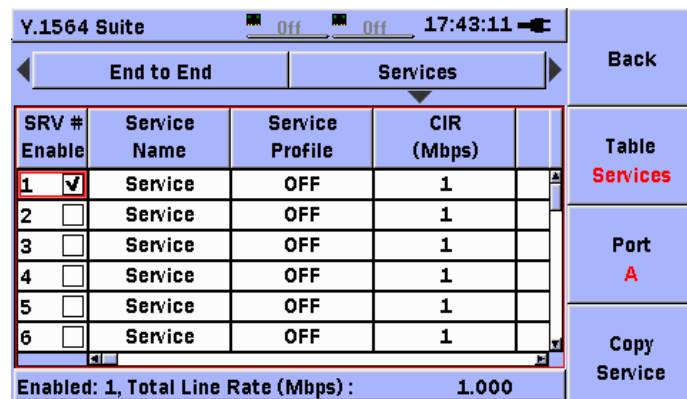

Figure 3.11.6-2 Y.1564 – Services Setup Table Selected

Notes:

- The Services setup table is designed for fast and efficient definition of Services on one (1) or two (2) ports. If many Services have similar definitions, the user can take advantage of the Copy function described below. Some recommended steps are:

Set up the first Service using the instructions provided below.

If multiple Services are required, use the Copy function to copy the first Service onto a range of Services for the same port.

If the selected test configuration will use both ports, use the Copy function to copy the Services from the current port to the opposite port.

Edit the individual fields in the Service definitions as needed to complete the setup operation.

- Many of the descriptions provided in this section for setting up the individual fields in the Services table will be familiar to users of the MU909060A Generator application. If the user is familiar with setting up Streams for the Generator application, many of the descriptions below can be skipped.
- The Services setup function supports editing of individual table values. The user may navigate to any cell in the table using the **Up/Down/Left/Right** arrow keys. The table is also divided into sections. The section currently displayed is indicated on the **F2** soft-key. The currently selected cell is indicated by a RED highlighted rectangle around the cell.
- The **F2** soft-key is available as an additional navigation aid. Press the **F2** soft-key to advance to the next section of the table. Sections wrap in a circular manner. The table sections are **Services, Addresses, Profiles, Thresholds, and Misc.** (miscellaneous).
- If a cell in the **SRV # Enable** column is highlighted, pressing the **Set** key will cause the Service to be **enabled (✓)** or **disabled (un-✓)**. For cells in any other columns, pressing the **Set** key will cause the appropriate editor for the field to be shown.
- The Services setup function includes vertical and horizontal scroll bars to make table navigation easy. The first column (**SRV #, Enable**) is locked in place so the Service numbers are always visible.
- If paid option MU909060A1-003 (Stacked VLAN) is not installed, only the VLAN 1 column will be shown. If paid option MU909060A1-004 (MPLS) is not installed, MPLS column will not be shown.

SRV# Enable Column

SRV #	Service Name	Service Profile	CIR (Mbps)
1	Service	OFF	1
2	Service	OFF	1
3	Service	OFF	1
4	Service	OFF	1
5	Service	OFF	1
6	Service	OFF	1

Enabled: 1, Total Line Rate (Mbps) : 1.000

Figure 3.11.6-3 Y.1564 – SRV# Enable Column Selected

When a cell in the **SRV # Enable** column is highlighted, the user may press the **Set** key to **enable** (✓) or **disable** (un-✓) the Service, as shown in Figure 3.11.6-3 above. If the Service is enabled (✓), it will be included when the Y.1564 Config and Y.1564 Perform tests are run.

Notes:

- The number of enabled (✓) Services is shown at the bottom of the display.
- The **SRV # Enable** column begins the **Services** section of the table. The label on the **F2 Table** soft-key will change to show **Services**.

Copy Function

The Services setup table supports a **Copy** function. Press the **F4 Copy Service** soft-key to display the Copy Service(s) Setup dialog, as shown in Figure 3.11.6-4 below.

Y.1564 SUITE 1000Mbps 1000Mbps 09:36:43

Copy Service(s) Setup

Copy Service: 4

To Service: 1

Through Service: 32

Copy Mode: The Same Port

OK

Cancel

Figure 3.11.6-4 Services Setup – Copy Service Selection



To **copy the complete contents of the current port** to the other port, use the **Up/Down/Left/Right**-arrow keys to move the highlight to the field to the right of the Copy Mode: label. Press the **Set** key to display the copy mode selection list, as shown in Figure 3.11.6-5 below.

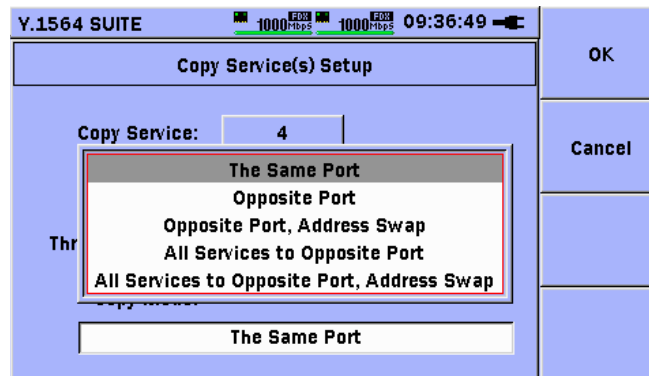

Figure 3.11.6-5 Services Setup – Copy Mode Selections

Use the **Up/Down**-arrow keys to select **All Services to Opposite Port** or **All Services to Opposite Port, Address Swap**. Press the **Set** key to complete the selection. Press the **F1 OK** soft-key to execute the copy operation, or press the **F2 Cancel** soft-key to cancel the copy operation.

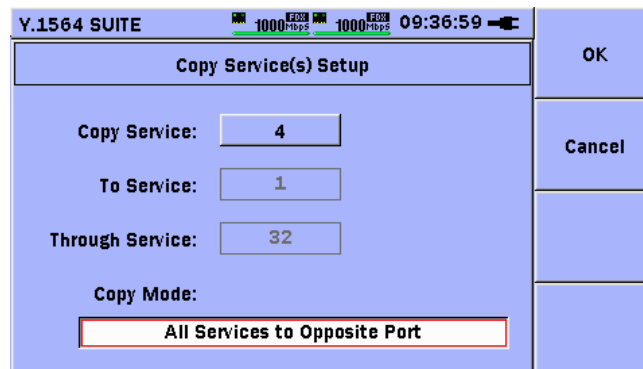

Figure 3.11.6-6 Services Setup – Copy All Services to Opposite Port

Note:

The All Services to Opposite Port mode copies the entire contents of the current port to the opposite port without address swapping. The All Services to Opposite Port, Address Swap mode copies the entire contents of the current port to the opposite port and swaps the Source and Destination MAC and IP addresses. When these modes are used, the remaining fields on the screen are disabled (grayed-out), as shown in Figure 3.11.6-6 above.

To copy one Service onto a range of multiple Services, follow the steps below.

The field to the right of the Copy Service: label is R/O, and corresponds to the Service (row) that was highlighted in the SRV # Enable column when the **F4** soft-key was pressed to enter the copy function.

Use the **Up/Down/Left/Right**-arrow keys to move the highlight to the field to the right of the To Service: label. Press the **Set** key to display the Service Number editor, as shown in Figure 3.11.6-7 below. Use the **Up/Down/Left/Right**-arrow keys to enter the starting number of the range of Services number to copy onto. Press the **Set** key to complete the editing process.

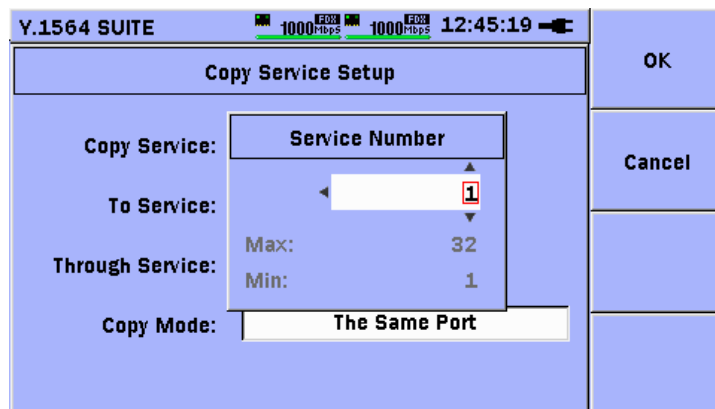

Figure 3.11.6-7 Copy Service Setup – Service Number Editor

Use the **Up/Down/Left/Right**-arrow keys to move the highlight to the field to the right of the Through Service: label. Press the **Set** key to display the Service Number editor, as shown in Figure 3.11.6-7 above. Use the **Up/Down/Left/Right**-arrow keys to enter the **ending number** of the range of Services number to copy onto. Press the **Set** key to complete the editing process.

Press the **F1 OK** soft-key to execute the copy operation, or press the **F2 Cancel** soft-key to cancel the copy operation.

Service Name Column (Optional)

Press the **Right**-arrow key to move the highlight to the **Service Name** column, as shown in Figure 3.11.6-8.

SRV #	Enable	Service Name	Service Profile	CIR (Mbps)
1	<input checked="" type="checkbox"/>	Service	OFF	1
2	<input type="checkbox"/>	Service	OFF	1
3	<input type="checkbox"/>	Service	OFF	1
4	<input type="checkbox"/>	Service	OFF	1
5	<input type="checkbox"/>	Service	OFF	1
6	<input type="checkbox"/>	Service	OFF	1

Enabled: 1, Total Line Rate (Mbps) : 1.000

Figure 3.11.6-8 Services Setup – Service Name Column

When a cell in the **Service Name** column is highlighted, pressing the **Set** key will cause the alpha-numeric input editor to be displayed, as shown in Figure 3.11.6-9. The user may enter up to eight (8) characters for the Service name, using the various keyboards provided on the editor.

Service Name, Port A Service 1

Service

a	b	c	d	e	f
g	h	i	j	k	l
m	n	o	p	q	r
s	t	u	v	w	x
y	z				

Figure 3.11.6-9 Services Setup – Service Name Editor

Service Profile Column (Optional)

Press the **Right**-arrow key to move the highlight to the Service **Profile** column, as shown in Figure 3.11.6-10 below.

SRV #	Service Name	Service Profile	CIR (Mbps)
1	Service	OFF	1
2	Service	OFF	1
3	Service	OFF	1
4	Service	OFF	1
5	Service	OFF	1
6	Service	OFF	1

Enabled: 1, Total Line Rate (Mbps) : 1.000

Figure 3.11.6-10 Services Setup – Profile Column

When a cell in the Service **Profile** column is highlighted, pressing the **Set** key will cause the Service Profile pop-up menu to be displayed, as shown in Figure 3.11.6-11 below.

Use the **Up/Down/Left/Right**-arrow keys to move the highlight to the radio button for the desired service profile. Press the **Set** key to enable the radio button (black dot appears in the center of the button).

For Voice or Video, once the radio button is enabled, use the **Right**-arrow keys to move the highlight to the Encoding field. Press the **Set** key to see the list of available encodings. Use the **Up/Down**-arrow keys to move the highlight over the desired encoding. Press the **Set** key to make the selection.

Use the **Left/Right**-arrow keys to move the highlight over the Calls/Channels field. Press the **Set** key to display the pop-up editor for the field. Use the **Up/Down/Left/Right**-arrow keys to enter the desired number of Calls/Channels. Press the **Set** key to release the pop-up editor.

Press the **F1 Back** soft-key to return to the Services setup table.

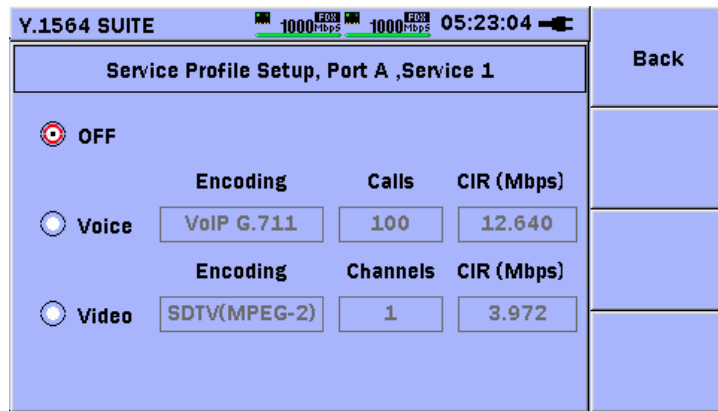

Figure 3.11.6-11 Services Profile Setup – Service Profile Selection OFF

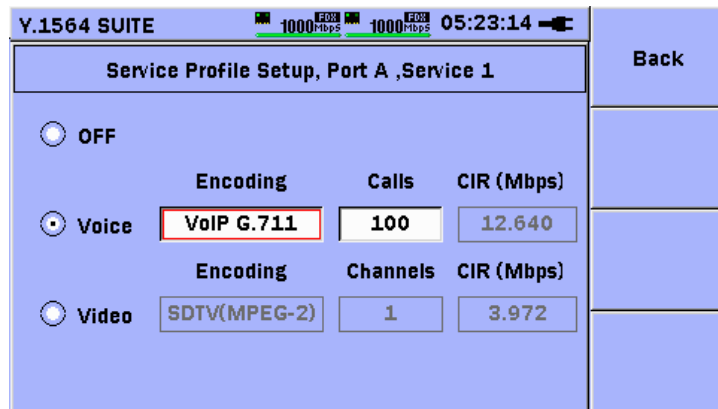

Figure 3.11.6-12 Services Profile Setup – Service Profile Selection Voice

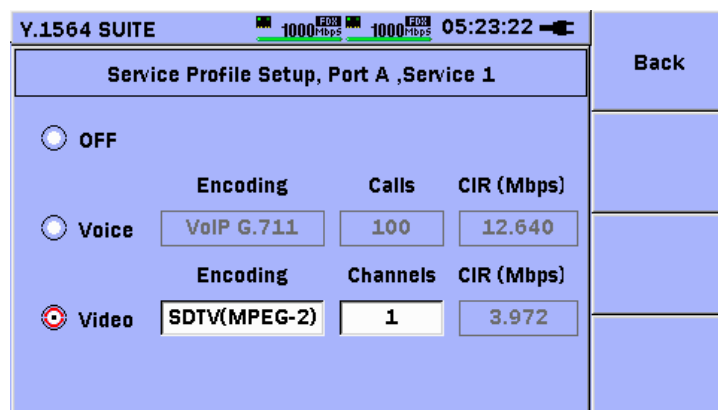

Figure 3.11.6-13 Services Profile Setup – Service Profile Selection Video

The selections available on the Service Profile pop-up are:

Table 3.11.6-1 Service Profile Setups

Selection	Description
OFF	No pre-set profile is used for the Service. The user must enter CIR, Frame Profile, and Protocol manually.
Voice	The user will select the encoding and number of calls to be used. The CIR value will be calculated and presented in the CIR column. The protocol will be set to UDP with the appropriate port numbers. The frame size will be pre-set based on the selections. Selections are shown in the table below.
Video	The user will select the encoding and number of channels to be used. The CIR value will be calculated and presented in the CIR column. The protocol will be set to UDP with the appropriate port numbers. The frame size will be pre-set based on the selections. Selections are shown in the table below.

Table 3.11.6-2 Encodings, Frame Sizes and Rates

Encoding	Frame Size	Rate per Channel/Call
VoIP G.711	138	0.126
VoIP G.723.1	82	0.027
VoIP G.729	78	0.039
SDTV (MPEG-2)	1374	3.972
HDTV (MPEG-2)	1374	20.443
HDTV (MPEG-4)	1374	10.593

Notes:

- If a Voice or Video profile is selected, UDP will be enabled and the CIR and Frame Profile columns will be filled in automatically and grayed-out. These fields cannot be edited until the Service Profile is changed to **OFF**.
- If the Service Profile is later changed from Voice or Video to OFF, the UDP header will remain on.

CIR Column (Required)

Press the **Right**-arrow key to move the highlight to the CIR column, as shown in Figure 3.11.6-14 below.

Note:

If this column is grayed-out (unavailable for selection) due to a Voice or Video profile selection, proceed to the **EIR column** instructions.

The screenshot shows a software interface for 'Services Setup'. At the top, it displays 'Y.1564 Suite', two 'Off' status indicators, and a time of '17:45:41'. Below this are navigation buttons for 'End to End' and 'Services', and a 'Back' button. The main area is a table with the following columns: 'SRV # Enable', 'Service Name', 'Service Profile', and 'CIR (Mbps)'. The 'CIR (Mbps)' column is highlighted in red. The table contains six rows, each with a service number (1-6), an 'Enable' checkbox (only row 1 is checked), 'Service' as the name, and 'OFF' as the profile. All 'CIR (Mbps)' values are set to '1'. At the bottom of the table, it says 'Enabled: 1, Total Line Rate (Mbps) : 1.000'. On the right side of the interface, there are labels for 'Table Services' and 'Port A'.

SRV # Enable	Service Name	Service Profile	CIR (Mbps)
1 <input checked="" type="checkbox"/>	Service	OFF	1
2 <input type="checkbox"/>	Service	OFF	1
3 <input type="checkbox"/>	Service	OFF	1
4 <input type="checkbox"/>	Service	OFF	1
5 <input type="checkbox"/>	Service	OFF	1
6 <input type="checkbox"/>	Service	OFF	1

Enabled: 1, Total Line Rate (Mbps) : 1.000

Figure 3.11.6-14 Services Setup – CIR Column

When a cell in the **CIR column** is highlighted, pressing the **Set** key will cause the CIR editor to be displayed.

This screenshot is similar to Figure 3.11.6-14, but with the CIR editor open for the first service. The editor window is titled 'CIR, Port A, Service 1 [Mbps]' and shows a numeric input field with the value '1.000'. Below the input field, it displays 'Max: 1000.000' and 'Min: 0.008'. The background table is partially visible, showing the same data as in Figure 3.11.6-14. The 'CIR (Mbps)' column is still highlighted in red.

SRV # Enable	Service Name	Service Profile	CIR (Mbps)
1 <input checked="" type="checkbox"/>	Service	OFF	1
2 <input type="checkbox"/>	Service	OFF	1
3 <input type="checkbox"/>	Service	OFF	1
4 <input type="checkbox"/>	Service	OFF	1
5 <input type="checkbox"/>	Service	OFF	1
6 <input type="checkbox"/>	Service	OFF	1

Enabled: 1, Total Line Rate (Mbps) : 1.000

Figure 3.11.6-15 Services Setup – CIR Editor

The CIR (Committed Information Rate) value may be set to any value between 0.008 Mbps and 1000.0 Mbps. The total of CIR values for all enabled Services is shown at the bottom of the display. The total of all CIR values is limit checked upon starting the test. If the total of all CIR values is greater than the line rate (of the current connection), a warning message will be displayed, as shown in Figure 3.11.6-16.

Note:

CIR is specified as a “utilized rate” which includes frame overhead.

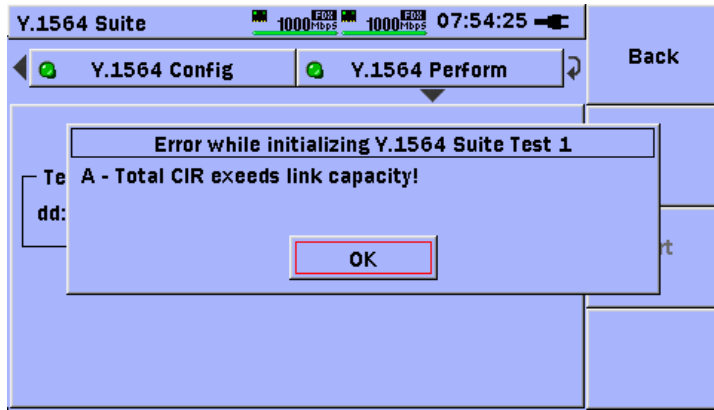

Figure 3.11.6-16 Total CIR Exceeds Line Rate Message

EIR Column (Optional)

Press the **Right**-arrow key to move the highlight to the EIR column, as shown in Figure 3.11.6-17.

The screenshot shows the 'Y.1564 Suite' configuration interface with the 'Services' tab selected. A table lists service configurations. The 'EIR (Mbps)' column for the first row is highlighted with a red border. Below the table, a summary line reads 'Enabled: 1, Total Line Rate (Mbps) : 100.000'. The interface includes 'End to End' and 'Services' tabs, a 'Back' button, and a 'Table Services' label.

SRV #	Enable	Service Profile	CIR (Mbps)	EIR (Mbps)
1	<input checked="" type="checkbox"/>	OFF	100	0
2	<input type="checkbox"/>	OFF	1	0
3	<input type="checkbox"/>	OFF	1	0
4	<input type="checkbox"/>	OFF	1	0
5	<input type="checkbox"/>	OFF	1	0
6	<input type="checkbox"/>	OFF	1	0

Enabled: 1, Total Line Rate (Mbps) : 100.000

Figure 3.11.6-17 Services Setup – EIR Column

When a cell in the EIR column is highlighted, pressing the **Set** key will cause the EIR editor to be displayed, as shown in Figure 3.11.6-18.

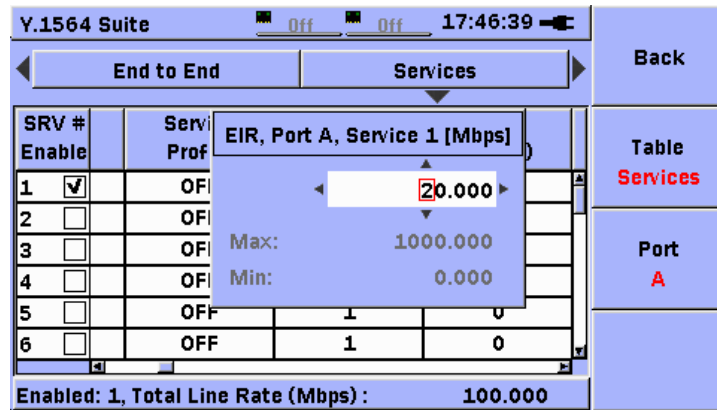

Figure 3.11.6-18 Services Setup – EIR Editor

The EIR (Excess Information Rate) value may be set to any value between 0.0 Mbps and 1000.0 Mbps. The EIR value is used by the Y.1564 Config EIR, Traffic Policing, and EBS tests. See section 3.11.11 for a description of how this value is used.

Notes:

- In some tests the EIR rate is added to the CIR rate. In other tests a multiple (such as 125%) of the EIR rate is added to the CIR rate, or another ratio of CIR and EIR is used. These conditions will be limit checked at the start of the test to insure the total line load required by the test does not exceed the line rate of the current connection.
- If EIR is set to 0.0 Mbps for a Service, then the EIR, Traffic Policing, and EBS tests will not run for that Service. This provides the user with flexibility to enable the EIR, Traffic Policing, and EBS tests globally, and then selectively disable these tests for certain Services.
- EIR is the last member of the Services section of the Services setup table.

SRC IP Column (Required)

Press the **Right**-arrow key to move the highlight to the **SRC IP column**, as shown in Figure 3.11.6-19.

Notes:

- The **SRC IP** column begins the **Addresses** section of the table. The label on the **F2 Table** soft-key will change to show **Addresses**.
- If multiple Services are defined and enabled for a test, the user may choose to make the SRC IP address for each Service unique or the same value. The test will function properly for either method of address definition (assuming the addresses are defined in a way that allows the test traffic to travel through the network from source to destination).

SRV #	Enable	EIR (Mbps)	SRC IP	DST IP
1	<input checked="" type="checkbox"/>	20	10.10.10.10	10.10.10.10
2	<input type="checkbox"/>	10	10.10.10.10	10.10.10.10
3	<input type="checkbox"/>	0	0.0.0.0	0.0.0.0
4	<input type="checkbox"/>	0	0.0.0.0	0.0.0.0
5	<input type="checkbox"/>	0	0.0.0.0	0.0.0.0
6	<input type="checkbox"/>	0	0.0.0.0	0.0.0.0

Enabled: 1, Total Line Rate: 1000 Mbps

Figure 3.11.6-19 Services Setup – SRC IP Column

When a cell in the SRC IP column is highlighted, pressing the **Set** key will cause the SRC IP screen to be displayed, as shown in Figure 3.11.6-20.

Note:

The Address Wizard function is available from the screen shown in Figure 3.11.6-20 below. Refer to section 3.12 for a description of how to use the Address Wizard function.

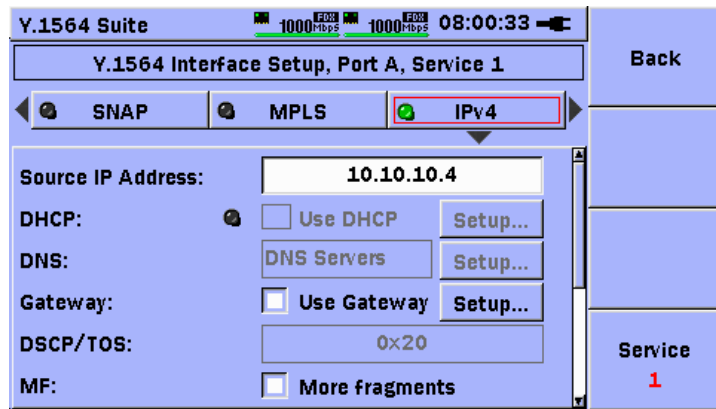

Figure 3.11.6-20 Services Setup – SRC IP Screen

The Source IP editor screen allows many functions to be selected and edited.

If the IPv4 button is highlighted, pressing the **Set** key will cause the IPv4 address header to be enabled (LED ON) or disabled (LED OFF).

Note:

If the IPv4 address header is disabled (LED OFF), then IPv6 addressing is automatically enabled.

Press the **Down**-arrow key to move the highlight selection to the Source IP Address: field. Press the **Set** key to display the IPv4 address editor. Use the **Up/Down/Left/Right**-arrow keys to set the desired IP Source address. Press the **Set** key to complete the selection and return to the previous screen.

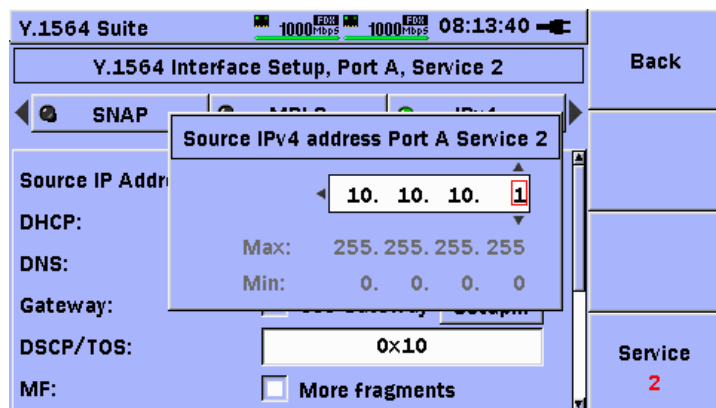

Figure 3.11.6-21 Services Setup – SRC IP Address Editor

Gateway: Use the **Up/Down/Left/Right**-arrow keys to highlight the **Setup...** button across from the Use Gateway label. Press the **Set** key to display the Gateway Setup pop-up screen, as shown in Figure 3.11.6-22. Use the **Up/Down/Left/Right**-arrow keys to move the highlight to the Default gateway: field. Press the **Set** key to display the pop-up editor. Use the **Up/Down/Left/Right**-arrow keys to input the address for the gateway. Press the **Set** key to close the pop-up editor. Repeat the procedure for the Network Mask: field.

If the End to End Network Test configuration is used, it is also necessary to configure a Gateway address and Netmask for the Remote unit. Use the procedure above to enter the Remote Default gateway address and Remote Network mask information.

Use the **Up/Down**-arrow keys to highlight the **Close** button on the pop-up dialog. Press the **Set** key to release the dialog and return to the previous screen.

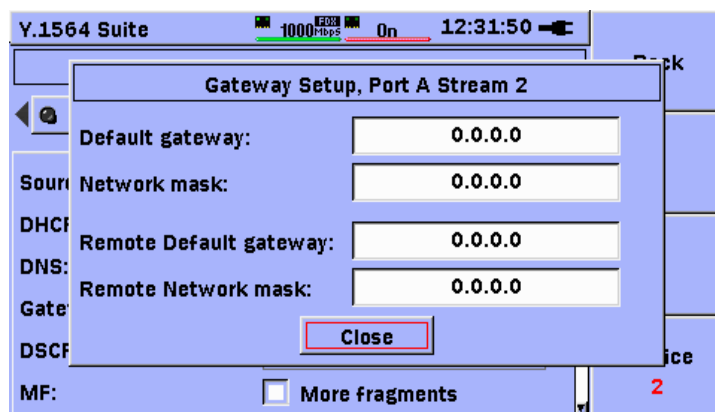

Figure 3.11.6-22 Gateway Input Fields

To enable/disable Gateway processing, press the **Left**-arrow key to move the highlight to the check-box to the left of the Use Gateway label. Press the **Set** key to enable (√) or disable (un-√) Gateway processing.

DSCP/TOS: Use the **Up/Down/Left/Right**-arrow keys to move the highlight to the DCSP/TOS field. Press the **Set** key to display the DSCP / TOS editor screen. Use the **Up/Down/Left/Right**-arrow keys to enter the desired code point value. Press the **Set** key to release the pop-up screen and return to the previous screen.

Note:

This code point value will represent the service class for non-colored frames on this Service. This value can be overridden by input values from the Color Mode editor screen, when Color Mode for the Service is set to IP DSCP. If the value is overridden from the Color Mode function, the values selected from the Color Mode function (for GREEN frames) will be copied to this value, and the DSCP / TOS field on this display will be disabled (grayed-out), as shown in Figure 3.11.6-23 below. This field also corresponds to the Traffic Class field in IPv6, as shown in Figure 3.11.6-24 below.

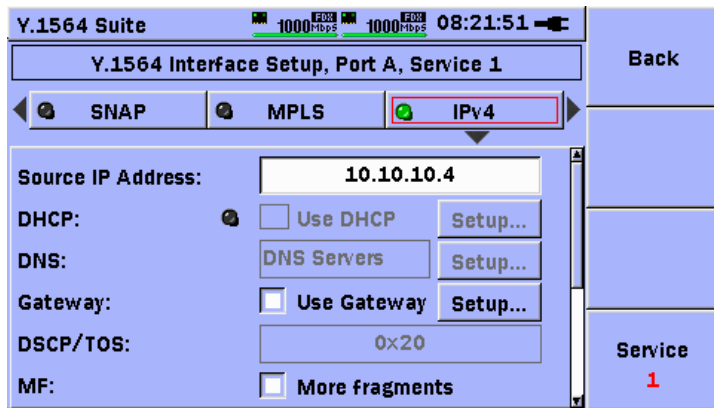

Figure 3.11.6-23 Services Setup – DSCP/TOS Field Disabled

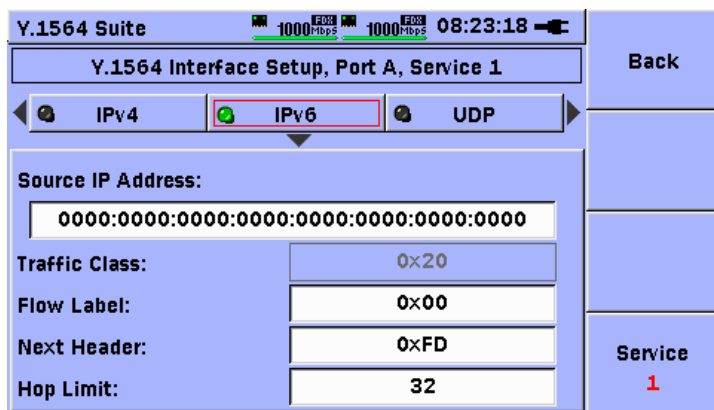

Figure 3.11.6-24 Services Setup – IPv6 Traffic Class Field Disabled

MF: Use the **Up/Down/Left/Right**-arrow keys to move the highlight to the check-box before the More Fragments label. Press the **Set** key to enable (✓) or disable (un-✓) this field.

Note:

It is possible to edit the Source IP address information for another Service by pressing the **F4 Service** soft-key, to change to another Service number. It is also possible to move to another address

header field for the current Service, by using the **Up/Down**-arrow keys to move the highlight to the row of address header buttons. Any changes that are made to other Services or address headers will be shown in the Services setup table upon return to the table.

When finished editing the Source IP information, press the **F1 Back** soft-key to return to the Services setup table.

DST IP Column (Required)

Press the **Right**-arrow key to move the highlight to the **DST IP** column, as shown in Figure 3.11.6-25.

SRV #	Enable	SRC IP	DST IP
1	<input checked="" type="checkbox"/>	10.10.10.10	10.10.10.20
2	<input type="checkbox"/>	0.0.0.0	0.0.0.0
3	<input type="checkbox"/>	0.0.0.0	0.0.0.0
4	<input type="checkbox"/>	0.0.0.0	0.0.0.0
5	<input type="checkbox"/>	0.0.0.0	0.0.0.0
6	<input type="checkbox"/>	0.0.0.0	0.0.0.0

Enabled: 1, Total Line Rate: 100 Mbps

Figure 3.11.6-25 Services Setup – DST IP Column

When a cell in the DST IP column is highlighted, pressing the **Set** key will cause the DST IP screen to be displayed, as shown in Figure 3.11.6-26.

Use the **Up/Down**-arrow keys to move the highlight to the Dest. IP Address: field, as shown in Figure 3.11.6-26.

Press the **Set** key to display the IP address editor, as shown in Figure 3.11.6-27.

Y.1564 Suite 1000Mbps 1000Mbps 08:26:53

Y.1564 Destination Setup, Port A, Service 1

Address Wizard Destination

MAC

Destination MAC: 00-00-00-00-00-12

ARP: Use ARP

IP

Dest. IP Address: 10.10.10.3

Service 1

Figure 3.11.6-26 Services Setup – DST IP Address Screen

Notes:

- The Address Wizard function is available from the screen shown in Figure 3.11.6-26 above. Refer to section 3.12 for a description of how to use the Address Wizard function.
- ARP resolution is not supported in real-time.
- If the End to End Network Test configuration is used, the Destination IP addresses become the Source IP addresses of the Remote unit.
- If multiple Services are defined and enabled for a test, the user may choose to make the DST IP address for each Service unique or the same value. The test will function properly for either method of address definition (assuming the addresses are defined in a way that allows the test traffic to travel through the network from source to destination).

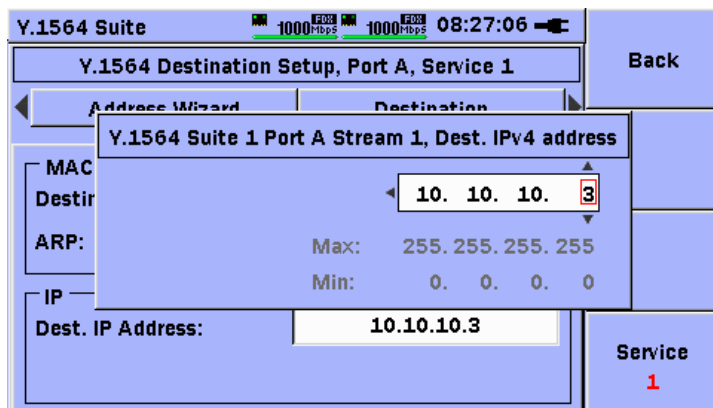

Figure 3.11.6-27 IPv4 Address Editor

Use the **Up/Down/Left/Right** arrow keys to edit the Destination IP address. When finished editing the Destination IP address, press the **F1 Back** soft-key to return to the Services setup table.

SRC MAC Column (Required)

Press the **Right** arrow key to move the highlight to the **SRC MAC column**, as shown in Figure 3.11.6-28.

SRV #	Enable	DST IP	SRC MAC
1	<input checked="" type="checkbox"/>	10.10.10.20	00-00-00-00-10-10
2	<input type="checkbox"/>	10.10.10.20	00-00-00-00-10-10
3	<input type="checkbox"/>	0.0.0.0	00-00-00-00-00-00
4	<input type="checkbox"/>	0.0.0.0	00-00-00-00-00-00
5	<input type="checkbox"/>	0.0.0.0	00-00-00-00-00-00
6	<input type="checkbox"/>	0.0.0.0	00-00-00-00-00-00

Enabled: 1, Total Line Rate: 1000 Mbps

Figure 3.11.6-28 Services Setup – SRC MAC Column

Press the **Set** key to display the SRC MAC input screen.

Note:

The MAC button is always enabled (LED ON).

Use the **Up/Down**-arrow keys to move the highlight to the Source MAC field, as shown in Figure 3.11.6-29.

Y.1564 Suite

Y.1564 Interface Setup, Port A, Service 1

Address Wizard | MAC | VLAN

Source MAC: 00-00-00-00-00-11

Service 1

Figure 3.11.6-29 Services Setup – SRC MAC Editor Screen

Press the **Set** key to display the MAC address editor, as shown in Figure 3.11.6-30.

Note:

The Address Wizard function is available from the screen shown in Figure 3.11.6-29 above. Refer to section 3.12 for a description of how to use the Address Wizard function.

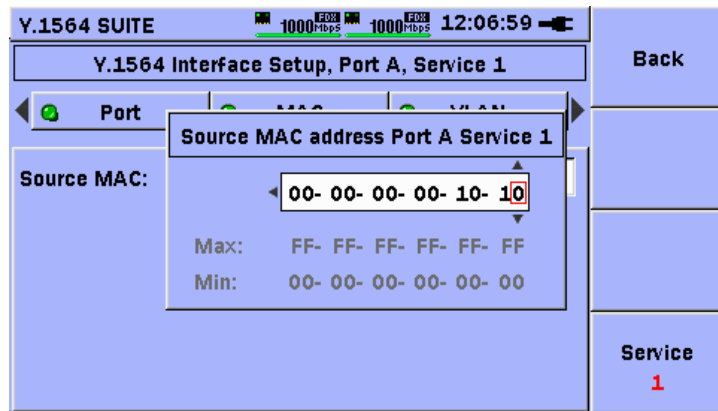

Figure 3.11.6-30 Services Setup – SRC MAC Editor

Use the **Up/Down/Left/Right** arrow keys to edit the Source MAC address. When finished editing the Source MAC address, press the **Set** key to return to the previous screen. Press the **F1 Back** soft-key to return to the Services setup table.

Note:

If multiple Services are defined and enabled for a test, the user may choose to make the SRC MAC address for each Service unique or the same value. The test will function properly for either method of address definition (assuming the addresses are defined in a way that allows the test traffic to travel through the network from source to destination).

DST MAC Column (Required)

Press the **Right**-arrow key to move the highlight to the **DST MAC** column, as shown in Figure 3.11.6-31.

SRV #	Enable	SRC MAC	DST MAC
1	<input checked="" type="checkbox"/>	00-00-00-00-10-10	00-00-00-00-10-20
2	<input type="checkbox"/>	00-00-00-00-10-10	00-00-00-00-10-20
3	<input type="checkbox"/>	00-00-00-00-00-00	00-00-00-00-00-00
4	<input type="checkbox"/>	00-00-00-00-00-00	00-00-00-00-00-00
5	<input type="checkbox"/>	00-00-00-00-00-00	00-00-00-00-00-00
6	<input type="checkbox"/>	00-00-00-00-00-00	00-00-00-00-00-00

Figure 3.11.6-31 Services Setup – DST MAC Editor

Press the **Set** key to display the **DST MAC** input screen.

Use the **Up/Down**-arrow keys to move the highlight to the Destination MAC: field, as shown in Figure 3.11.6-32.

Note:

The Address Wizard function is available from the screen shown in Figure 3.11.6-32 below. Refer to section 3.12 for a description of how to use the Address Wizard function.

Figure 3.11.6-32 Services Setup – DST MAC Editor

Press the **Set** key to display the MAC address editor, as shown in Figure 3.11.6-33.

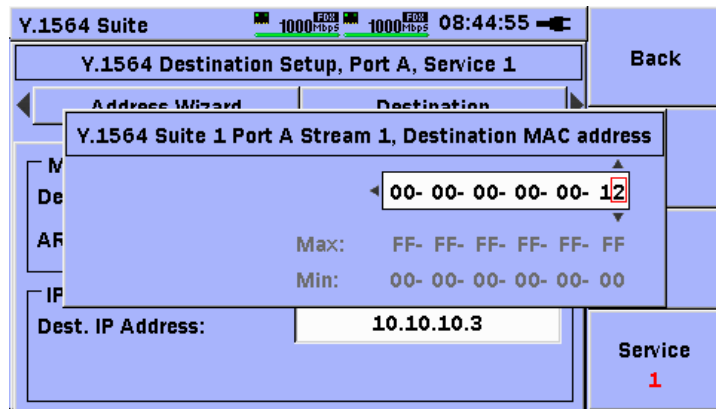

Figure 3.11.6-33 Services Setup – DST MAC Editor

Use the **Up/Down/Left/Right**-arrow keys to edit the Destination MAC address. When finished editing the Destination MAC address, press the **Set** key to return to the previous screen.

Press the **Down**-arrow key to move the highlight to the check-box to the right of the ARP: label. Press the **Set** key to enable (✓) or disable (un-✓) ARP processing.

Note:

There are some dependencies between ARP processing, Gateway processing, and the selected Test Mode. These dependencies are described in the table below:

Table 3.11.6-3 Test Mode, ARP, Gateway Dependencies

Gateway Check-box	Test Mode	ARP Check-box
Change from Disabled to Enabled	End-to-End	Disable ARP on corresponding Service.
Change from Disabled to Enabled	Switch-Router or Single Ended	Enable ARP on corresponding Service.
Enabled	Change from Switch-Router or Single Ended to End-to-End mode.	Enable ARP on corresponding Service.
Disable	Change from Switch-Router or Single Ended to End-to-End mode.	Disable ARP on corresponding Service.

Press the **F1 Back** soft-key to return to the Services setup table.

Notes:

- If multiple Services are defined and enabled for a test, the user may choose to make the DST MAC address for each Service unique or the same value. The test will function properly for either method of address definition (assuming the addresses are defined in a way that allows the test traffic to travel through the network from source to destination).
- If the End to End Network Test configuration is used, the Destination MAC addresses become the Source MAC address of the Remote unit.

Color Mode Column (Optional)

Press the **Right**-arrow key to move the highlight to the Color Mode column, as shown in Figure 3.11.6-34.

Note:

The **Color Mode** column begins the **Profiles** section of the table. The label on the **F2 Table** soft-key will change to show **Profiles**.

Color Mode defines the method of differentiating traffic streams by IP DSCP code point value or VLAN priority. For certain sub-tests under the Y.1564 Config test, each Service that has a color mode defined (other than OFF) will use two (2) individual test traffic streams. The first (known as the GREEN stream) will use the specified code point or VLAN priority defined for GREEN traffic. The second (known as the YELLOW stream) will use the specified code point or VLAN priority defined for YELLOW traffic.

SRV #	Enable	DST MAC	Color Mode
1	<input checked="" type="checkbox"/>	00-00-00-00-10-20	OFF
2	<input type="checkbox"/>	00-00-00-00-10-20	OFF
3	<input type="checkbox"/>	00-00-00-00-00-00	OFF
4	<input type="checkbox"/>	00-00-00-00-00-00	OFF
5	<input type="checkbox"/>	00-00-00-00-00-00	OFF
6	<input type="checkbox"/>	00-00-00-00-00-00	OFF

Enabled: 1, Total Line Rate: 1000 Mbps

Figure 3.11.6-34 Services Setup – Color Mode Column

When a cell in the Color Mode column is highlighted, pressing the **Set** key will cause the Color Mode Setup screen to be displayed, as shown in Figure 3.11.6-35.

Use the **Up/Down/Left/Right**-arrow keys to move the highlight to the radio button for the desired setting for Color Mode. Press the **Set** key to enable (black dot in the center of radio button) or disable (no dot in the center of radio button) the selection.

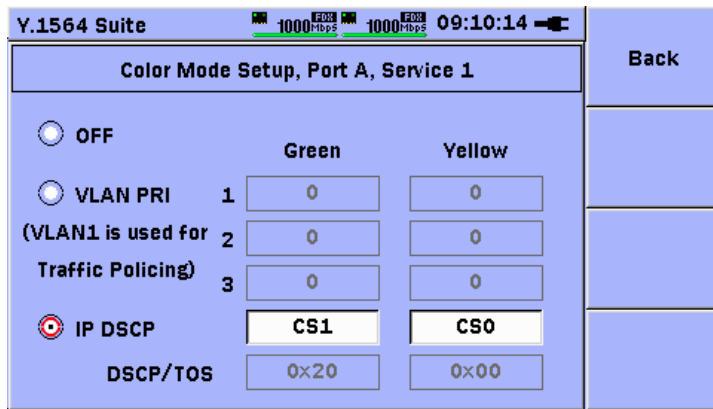

Figure 3.11.6-35 Services Setup – Color Mode Setup Screen

If VLAN PRI is enabled, use the **Up/Down/Left/Right**-arrow keys to move the highlight to the input field in the GREEN or YELLOW column, across from the level of VLAN (1 or 2 or 3) to be modified, as shown in Figure 3.11.6-35. Press the **Set** key to display the VLAN Priority pop-up editor, as shown in Figure 3.11.6-36. Use the **Up/Down**-arrow keys to set the priority.

Press the **Set** key to release the dialog and return to the previous screen. Repeat the procedure to set the priorities for all VLAN levels and colors that are required for the test.

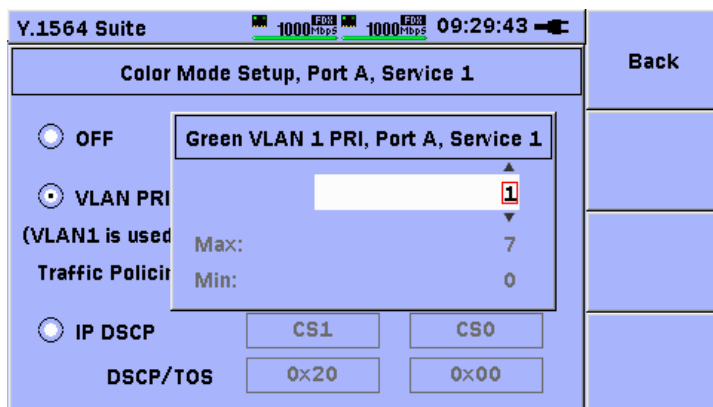

Figure 3.11.6-36 Services Setup – VLAN Priority Editor

SRV #	Enable	Color Mode	VLAN 1 (VID, PRI)
1	<input checked="" type="checkbox"/>	VLAN PRI	0, GR:1 YL:2
2	<input checked="" type="checkbox"/>	IP DSCP GR:CS4 YL:CS1	OFF
3	<input type="checkbox"/>	OFF	OFF
4	<input type="checkbox"/>	OFF	OFF
5	<input type="checkbox"/>	OFF	OFF
6	<input type="checkbox"/>	OFF	OFF

Enabled: 2, Total Line Rate (Mbps) : 1001

Figure 3.11.6-37 Services Setup – Color Mode Column w/VLAN Info

SRV #	Enable	VLAN 1 (VID, PRI)	VLAN 2 (VID, PRI)	VLAN 3 (VID, PRI)
1	<input checked="" type="checkbox"/>	0, GR:1 YL:2	0, GR:3 YL:4	0, GR:5 YL:4
2	<input checked="" type="checkbox"/>	OFF	OFF	OFF
3	<input type="checkbox"/>	OFF	OFF	OFF
4	<input type="checkbox"/>	OFF	OFF	OFF
5	<input type="checkbox"/>	OFF	OFF	OFF
6	<input type="checkbox"/>	OFF	OFF	OFF

Enabled: 2, Total Line Rate (Mbps) : 1001

Figure 3.11.6-38 Services Setup – VLAN Info

Note:

If VLAN PRI is enabled, the Color Mode column will indicate VLAN PRI. The priorities for the individual VLANs will be shown in their respective VLAN columns. If a VLAN level is disabled, its column will show OFF. Otherwise its column will show the VLAN ID, GR:x, YL:y information. The PRI (priority) field for each VLAN in (Y.1564) Interface Setup will be disabled (grayed-out).

If VLAN PRI is enabled, then VLAN 1 will be enabled automatically by the software. If VLANs 2,3 are to be used they must be enabled manually by the user.

If VLAN PRI is enabled and VLAN 1 is disabled by the user, the Color Mode setting for the Service will be automatically set to OFF.

If VLANs are defined and enabled, and the Color Mode setting is later changed to OFF, the VLANs will remain enabled, and the VLAN columns will change to show only the basic VID, PRI notation.

If IP DSCP is enabled, to use pre-defined code points, use the **Up/Down/Left/Right**-arrow keys to move the highlight to the input field in the GREEN or YELLOW column, across from the IP DSCP label, as shown in Figure 3.11.6-39. Press the **Set** key to display the IP DCSP code point pull-down list, as shown in Figure 3.11.6-40. Use the **Up/Down**-arrow keys to highlight the desired code point. Press the **Set** key to make the selection. Repeat the procedure for each column (GREEN or YELLOW) to be set.

Note:

The hexadecimal value of the selected code point will be displayed in the DSCP/TOS field below the input field. This value will also be populated in the DSCP/TOS: field on the Source IP Address screen of (Y.1564) Interface Setup.

		Green	Yellow
<input type="radio"/> OFF			
<input type="radio"/> VLAN PRI	1	0	0
<input type="radio"/> IP DSCP	2	0	0
	3	0	0
		CS4	CS1
	DSCP/TOS	0x80	0x20

Figure 3.11.6-39 Services Setup – IP DSCP Code Point Selection

To use user-defined code points, use the **Up/Down**-arrow keys to move the highlight to the User Defined selection in the list. Press the **Set** key to make the selection. Use the **Up/Down/Left/Right**-arrow keys to move the highlight to the input field in the GREEN or YELLOW column, across from the DSCP/TOS label. Press the **Set** key to display the IP DCSP code point editor, as shown in Figure 3.11.6-41. Use the **Up/Down/Left/Right**-arrow keys to enter the desired value. Press the **Set** key to release the dialog and return to the previous screen. Repeat the procedure for each column (GREEN or YELLOW) to be set.

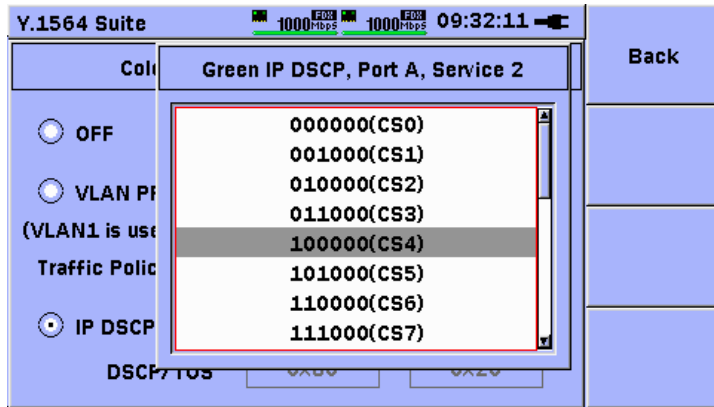

Figure 3.11.6-40 Services Setup – IP DSCP Code Point List

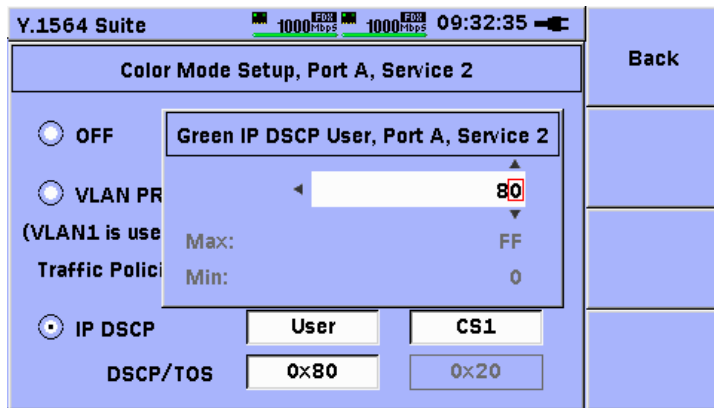

Figure 3.11.6-41 Services Setup – IP DSCP Code Point Editor

SRV #	Enable	Color Mode	VLAN 1 (VID, PRI)
1	<input checked="" type="checkbox"/>	VLAN PRI	0, GR:1 YL:2
2	<input checked="" type="checkbox"/>	IP DSCP GR:CS4 YL:CS1	OFF
3	<input type="checkbox"/>	OFF	OFF
4	<input type="checkbox"/>	OFF	OFF
5	<input type="checkbox"/>	OFF	OFF
6	<input type="checkbox"/>	OFF	OFF

Enabled: 2, Total Line Rate (Mbps) : 1001

Figure 3.11.6-42 Services Setup – IP DSCP Code Points Set

Press the **F1 Back** soft-key to return to the Services setup table.

VLAN Column(s) (Optional)

Press the **Right**-arrow key to move the highlight to the **VLAN 1** column, as shown in Figure 3.11.6-43.

When a cell in the VLAN 1 column is highlighted, pressing the **Set** key will cause the VLAN screen to be displayed, as shown in Figure 3.11.6-44.

SRV #	Enable	Color Mode	VLAN 1 (ID, PRI)	
1	<input checked="" type="checkbox"/>	0-20	OFF	1, 0
2	<input type="checkbox"/>	0-20	OFF	N/A
3	<input type="checkbox"/>	0-00	OFF	N/A
4	<input type="checkbox"/>	0-00	OFF	N/A
5	<input type="checkbox"/>	0-00	OFF	N/A
6	<input type="checkbox"/>	0-00	OFF	N/A

Enabled: 1, Total Line Rate: 1000 Mbps

Figure 3.11.6-43 Services Setup – VLAN 1 Column

	TPID	PRI	CFI	VID	
-	VLAN 1	0x8100	0	<input type="checkbox"/>	1
+	VLAN 2	0x8100	0	<input type="checkbox"/>	0
+	VLAN 3	0x8100	0	<input type="checkbox"/>	0

Figure 3.11.6-44 Services Setup – VLAN 1,2,3 Editor Screen

Use the **Up/Down/Left/Right**-arrow keys to move the highlight to the **VLAN** button, as shown in Figure 3.11.6-44. Press the **Set** key to enable (LED ON) or disable (LED OFF) the inclusion of VLAN headers in the test frames.

Assuming the VLAN feature is enabled (LED ON), use the **Up/Down/Left/Right**-arrow keys to move the highlight to the TPID field of the VLAN 1 row. Press the **Set** key to display the TPID pull-down list and make a selection. Press the **Set** key to release the list and return to the previous screen.

Move the highlight to the PRI field. Press the **Set** key to display the Priority pop-up editor. Use the **Up/Down**-arrow keys to edit the priority

number. Press the **Set** key to release the editor and return to the previous screen.

Move the highlight to the CFI field. Press the **Set** key to enable (✓) or disable (un-✓) the CFI bit.

Move the highlight to the VID field. Press the **Set** key to display the VID pop-up editor. Use the **Up/Down/Left/Right**-arrow keys to edit the VID value. Press the **Set** key to release the editor and return to the previous screen.

Notes:

- If more than one level of VLAN is required to be defined, it can be accomplished from this dialog (Figure 3.11.6-44). Use the **Up/Down/Left/Right**-arrow keys to move the highlight over the **+** field to the left of the VLAN 2 label. Press the **Set** key to enable the input fields. Repeat the procedure above to input the desired TPID, Priority, CFI, and VID settings. Once VLAN 2 is enabled then VLAN 3 can be enabled if required. Repeat the same procedure for VLAN 3.
- When a cell in the VLAN 1, VLAN 2, or VLAN 3 column (as shown in Figure 3.11.6-45) is highlighted, pressing the **Set** key will cause the VLAN screen to be displayed, as shown in Figure 3.11.6-44. All VLAN columns are processed in the same manner as described above.

SRV #	Enable	VLAN 1 (ID, PRI)	VLAN 2 (ID, PRI)	VLAN 3 (ID, PRI)
1	<input checked="" type="checkbox"/>	1, 0	N/A	N/A
2	<input type="checkbox"/>	N/A	N/A	N/A
3	<input type="checkbox"/>	N/A	N/A	N/A
4	<input type="checkbox"/>	N/A	N/A	N/A
5	<input type="checkbox"/>	N/A	N/A	N/A
6	<input type="checkbox"/>	N/A	N/A	N/A

Enabled: 1, Total Line Rate: 100 Mbps

Figure 3.11.6-45 Services Setup – VLAN 1,2,3 Columns

Frame Profile Column (Optional)

Press the **Right**-arrow key (multiple times) to move the highlight to the **Frame Profile** column, as shown in Figure 3.11.6-46.

When a cell in the Frame Profile column is highlighted, pressing the **Set** key will cause the Frame Profile Setup screen to be displayed, as shown in Figure 3.11.6-47.

SRV #	Enable	VLAN 2 (ID, PRI)	VLAN 3 (ID, PRI)	Frame Profile
1	<input checked="" type="checkbox"/>	N/A	N/A	EMIX:abu
2	<input type="checkbox"/>	N/A	N/A	EMIX:abcde
3	<input type="checkbox"/>	N/A	N/A	Fixed:512
4	<input type="checkbox"/>	N/A	N/A	Fixed:512
5	<input type="checkbox"/>	N/A	N/A	Fixed:512
6	<input type="checkbox"/>	N/A	N/A	Fixed:512

Enabled: 1, Total Line Rate: 1000 Mbps

Figure 3.11.6-46 Services Setup – Frame Profile Screen

Use the **Up/Down/Left/Right**-arrow keys to move the highlight to the radio button for the desired setting for Frame Profile. Press the **Set** key to enable (black dot in the center of radio button) or disable (no dot in the center of radio button) the selection.

If Fixed Size is enabled, use the **Up/Down/Left/Right**-arrow keys to move the highlight to the input field across from the Fixed Size: label. Press the **Set** key to display the frame size pull-down list, as shown in Figure 3.11.6-48. Use the **Up/Down**-arrow keys to highlight the desired frame size in the list. Press the **Set** key to make the selection.

Y.1564 SUITE 1000Mbps 1000Mbps 12:32:49

Back

Frame Profile Setup, Port A ,Service 1

Fixed Size 1024 (Bytes)

User Defined 1512 (Bytes)

EMIX abu

H = MTU 512 (Bytes)

U = User 512 (Bytes)

Figure 3.11.6-47 Services Setup – Frame Profile Screen

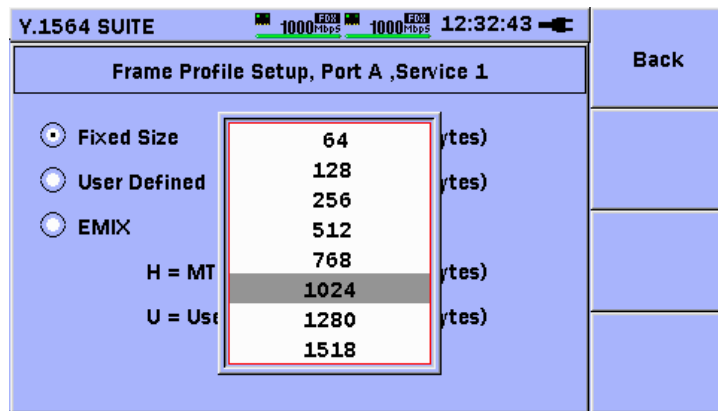

Figure 3.11.6-48 Services Setup – Fixed Frame Size Pop-up

If User Defined is enabled, use the **Up/Down/Left/Right**-arrow keys to move the highlight to the input field across from the User Defined label. Press the **Set** key to display the User Frame Size editor, as shown in Figure 3.11.6-49. Use the **Up/Down/Left/Right**-arrow keys to edit the desired frame size. Press the **Set** key to complete the selection.

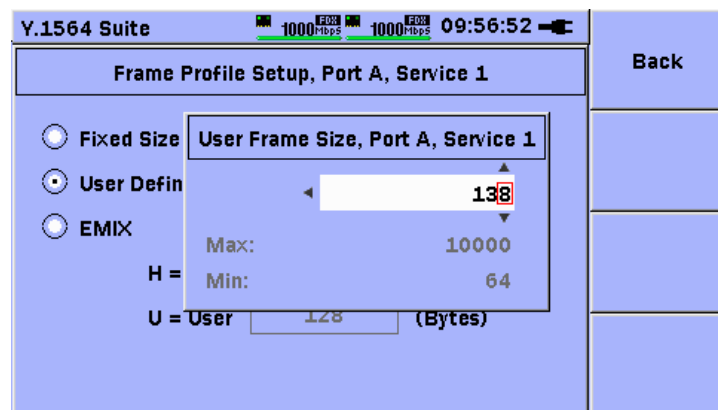

Figure 3.11.6-49 Services Setup – Fixed / User Defined Editor

If EMIX is enabled, use the **Up/Down/Left/Right**-arrow keys to move the highlight to the input field across from the EMIX label. Press the **Set** key to display the EMIX input editor, as shown in Figure 3.11.6-51. Use the **Up/Down/Left/Right**-arrow keys to move the highlight to the soft-keyboard. Press the **Set** key to select the currently highlighted character on the soft-keyboard. Use the **F2 Backspace** soft-key to make corrections if necessary. Press the **F3 OK** soft-key to accept and complete the editing session. Press the **F4 Cancel** soft-key to discard inputs and complete the editing session.

Note:

The EMIX string can be from one (1) to five (5) characters in length in any sequence. The EMIX string defines a repeating mix of frame

sizes that will be transmitted by the Service.

Use the **Up/Down/Left/Right**-arrow keys to move the highlight to the input field across from the H = MTU (Maximum Transmission Unit) label. Press the **Set** key to display the EMIX MTU input editor. Use the **Up/Down/Left/Right**-arrow keys to enter the desired frame size for the MTU setting. Press the **Set** key to complete the editing process.

Use the **Up/Down**-arrow keys to move the highlight to the input field across from the U = User label. Press the **Set** key to display the EMIX User input editor. Use the **Up/Down/Left/Right**-arrow keys to enter the desired frame size for the User setting. Press the **Set** key to complete the editing process.

Y.1564 SUITE 1000 Mbps 1000 Mbps 12:33:11

Frame Profile Setup, Port A, Service 1

Fixed Size 1024 (Bytes)
 User Defined 1512 (Bytes)
 EMIX abu

H = MTU 512 (Bytes)
U = User 512 (Bytes)

Back

Figure 3.11.6-50 Services Setup – EMIX Selection

Y.1564 SUITE 1000 Mbps 1000 Mbps 13:41:30

EMIX Profile, Port A, Service 1

aa

a b c d e f g h u

a = 64 B, b = 128 B, c = 256 B
 d = 512 B, e = 1024 B, f = 1280 B
 g = 1518 B, h = MTU, u = User

Backspace
OK
Cancel

Figure 3.11.6-51 Services Setup – EMIX Input Keyboard

Payload Pattern Column (Optional)

Press the **Right**-arrow key to move the highlight to the **Payload Pattern column**, as shown in Figure 3.11.6-52.

When a cell in the Payload Pattern column is highlighted, pressing the **Set** key will cause the Payload Profile pull-down list to be displayed, as shown in Figure 3.11.6-53.

SRV #	VLAN 3 (ID, PRI)	Frame Profile	Payload Pattern
1	<input checked="" type="checkbox"/> N/A	EMIX:abu	Fox Pattern
2	<input type="checkbox"/> N/A	EMIX:abcde	0000 Pattern
3	<input type="checkbox"/> N/A	Fixed:512	Fox Pattern
4	<input type="checkbox"/> N/A	Fixed:512	Fox Pattern
5	<input type="checkbox"/> N/A	Fixed:512	Fox Pattern
6	<input type="checkbox"/> N/A	Fixed:512	Fox Pattern

Enabled: 1, Total Line Rate: 1000 Mbps

Figure 3.11.6-52 Services Setup – Payload Pattern Column

SRV #	VLAN (ID, PRI)	Frame Profile	Payload Pattern
1	<input checked="" type="checkbox"/> N/A	EMIX:abu	Fox Pattern
2	<input type="checkbox"/> N/A	EMIX:abcde	0000 Pattern
3	<input type="checkbox"/> N/A	Fixed:512	Fox Pattern
4	<input type="checkbox"/> N/A	Fixed:512	Fox Pattern
5	<input type="checkbox"/> N/A	Fixed:512	Fox Pattern
6	<input type="checkbox"/> N/A	Fixed:512	Fox Pattern

Enabled: 1, Total Line Rate: 1000 Mbps

Pop-up List:

- Fox Pattern
- 0000 Pattern
- 1111 Pattern
- 5555 Pattern
- AAAA Pattern
- PING Pattern
- PRBS9
- PRBS11

Figure 3.11.6-53 Services Setup – Payload Pattern Pop-up List

Use the **Up/Down**-arrow keys to move the highlight over the desired Payload Pattern. Press the **Set** key to complete the selection.

Note:

The selected Payload Pattern will be placed in the (un-used) payload area of each test frame.

CBS Column (Optional)

Press the **Right**-arrow key to move the highlight to the CBS (Committed Burst Size) column, as shown in Figure 3.11.6-54.

When a cell in the CBS column is highlighted, pressing the **Set** key will cause the CBS editor to be displayed, as shown in Figure 3.11.6-55.

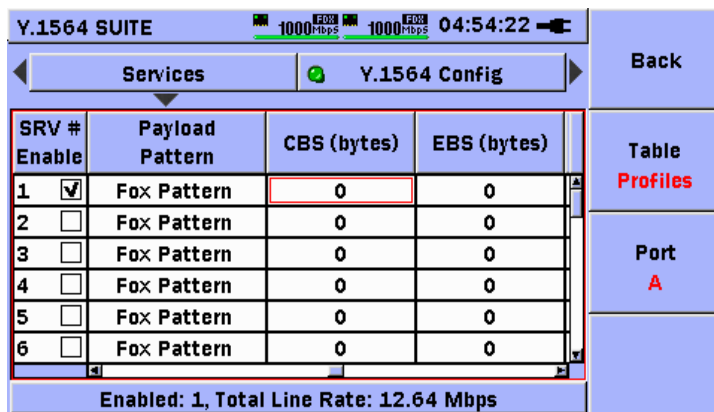

Figure 3.11.6-54 Services Setup – CBS Column

Use the **Up/Down/Left/Right**-arrow keys to enter the value for CBS bytes. Press the **Set** key to complete the editing process.

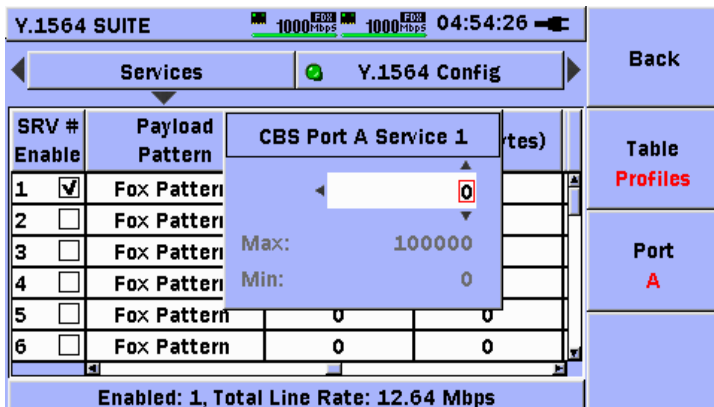

Figure 3.11.6-55 Services Setup – CBS Editor

Note:

The value entered for CBS is used by certain sub-tests of the Y.1564 Config test. If these sub-tests are enabled, the value will be limit checked by the software at test start. The minimum value for CBS depends on many factors such as the CIR and frame size settings. If the currently defined value is too small (based on the validation rules), a message similar to the one shown in Figure 3.11.6-56 will be shown. The user must then change the CBS value to be at least as large as the value shown in the message.

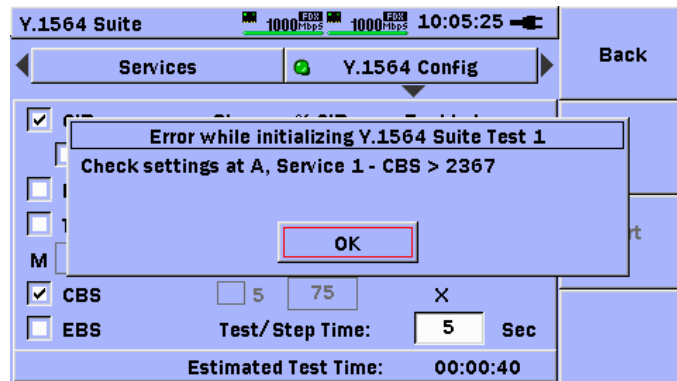

Figure 3.11.6-56 Run Time – CBS Limit Message

EBS Column (Optional)

Press the **Right**-arrow key to move the highlight to the **EBS (Excess Burst Size)** column, as shown in Figure 3.11.6-57.

When a cell in the EBS column is highlighted, pressing the **Set** key will cause the EBS editor to be displayed, as shown in Figure 3.11.6-58.

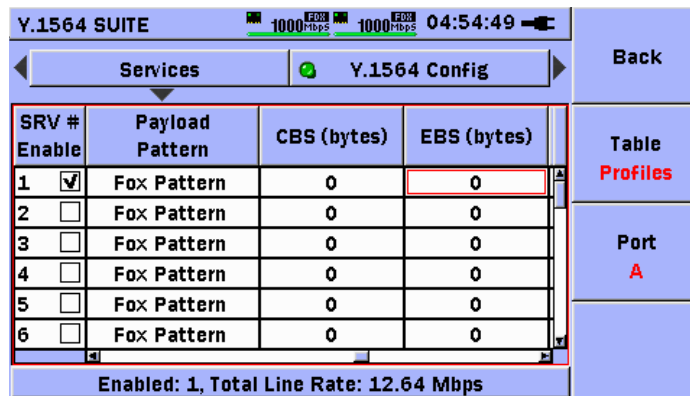

Figure 3.11.6-57 Services Setup – EBS Column

Use the **Up/Down/Left/Right**-arrow keys to enter the value for EBS bytes. Press the **Set** key to complete the editing process.

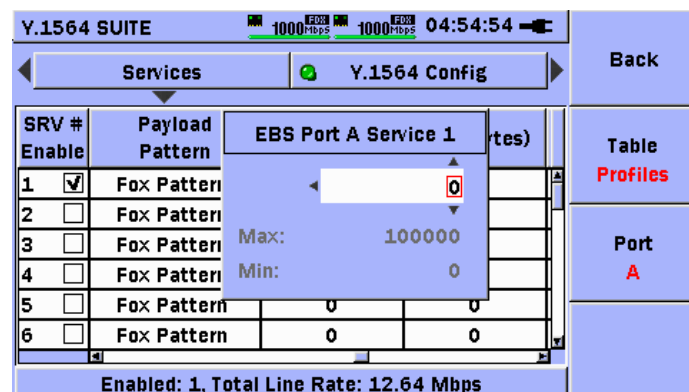

Figure 3.11.6-58 Services Setup – EBS Pop-up Editor

Max FTD Column (Required)

Press the **Right**-arrow key to move the highlight to the **Max FTD** column, as shown in Figure 3.11.6-59. The Max FTD column is used to set a threshold on the maximum value for FTD (latency).

Note:

The **Max FTD** column begins the **Thresholds** section of the table. The label on the **F2 Table** soft-key will change to show **Thresholds**.

When a cell in the Max FTD column is highlighted, pressing the **Set** key will cause the Max FTD editor to be displayed, as shown in Figure 3.11.6-60.

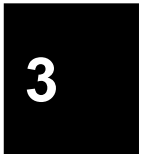

SRV #	Enable	CBS (bytes)	EBS (bytes)	Max FTD (ms)
1	<input checked="" type="checkbox"/>	0	0	0.010
2	<input type="checkbox"/>	0	0	0.010
3	<input type="checkbox"/>	0	0	0.010
4	<input type="checkbox"/>	0	0	0.010
5	<input type="checkbox"/>	0	0	0.010
6	<input type="checkbox"/>	0	0	0.010

Enabled: 1, Total Line Rate: 12.64 Mbps

Figure 3.11.6-59 Services Setup – Max FTD Column

SRV #	Enable	CBS (bytes)	Max FTD [ms]
1	<input checked="" type="checkbox"/>	10000	5.000
2	<input checked="" type="checkbox"/>	11000	5.000
3	<input type="checkbox"/>	0	5.000
4	<input type="checkbox"/>	0	5.000
5	<input type="checkbox"/>	0	5.000
6	<input type="checkbox"/>	0	5.000

Enabled: 2, Total Line Rate (Mbps): 1001

Figure 3.11.6-60 Services Setup – Max FTD Pop-up Editor

Use the **Up/Down/Left/Right**-arrow keys to enter the value for Max FTD in ms. Press the **Set** key to complete the editing process.

Max FDV Column (Required)

Press the **Right**-arrow key to move the highlight to the Max FDV column, as shown in Figure 3.11.6-61. The Max FDV column is used to set a threshold on the maximum value for FDV (jitter).

When a cell in the Max FDV column is highlighted, pressing the **Set** key will cause the Max FDV editor to be displayed, as shown in Figure 3.11.6-62.

SRV #	Enable	EBS (bytes)	Max FTD (ms)	Max FDV (ms)
1	<input checked="" type="checkbox"/>	0	0.010	0.001
2	<input type="checkbox"/>	0	0.010	0.001
3	<input type="checkbox"/>	0	0.010	0.001
4	<input type="checkbox"/>	0	0.010	0.001
5	<input type="checkbox"/>	0	0.010	0.001
6	<input type="checkbox"/>	0	0.010	0.001

Enabled: 1, Total Line Rate: 12.64 Mbps

Figure 3.11.6-61 Services Setup – Max FDV Column

Use the **Up/Down/Left/Right**-arrow keys to enter the value for Max FDV in ms. Press the **Set** key to complete the editing process.

SRV #	Enable	EBS (bytes)	Max FTD (ms)	Max FDV (ms)
1	<input checked="" type="checkbox"/>	0	5.000	5.000
2	<input checked="" type="checkbox"/>	0	5.000	5.000
3	<input type="checkbox"/>	0		
4	<input type="checkbox"/>	0		
5	<input type="checkbox"/>	0		
6	<input type="checkbox"/>	0		

Enabled: 2, Total Line Rate (Mbps): 1001

Figure 3.11.6-62 Services Setup – Max FDV Pop-up Editor

Max FLR Column (Required)

Press the **Right**-arrow key to move the highlight to the Max FLR column, as shown in Figure 3.11.6-63. The Max FLR column is used to set a threshold on the maximum value for FLR (frame loss ratio).

When a cell in the Max FLR column is highlighted, pressing the **Set** key will cause the Max FLR editor to be displayed, as shown in Figure 3.11.6-64.

The screenshot shows the 'Services' setup screen in the Y.1564 Suite. At the top, it displays 'Y.1564 Suite', signal strength indicators, and the time '07:32:47'. Below this are 'Test Mode' and 'Services' tabs. A table lists six services (SRV # 1-6) with columns for 'FTD Enables', 'Max FDV (ms)', and 'Max FLR (PPM)'. The 'Max FLR' column for service 2 is highlighted with a red border. To the right of the table are 'Table Thresholds' and 'Port A' buttons. At the bottom, it shows 'Enabled: 2, Total Line Rate (Mbps): 2.000'.

SRV #	FTD Enables	Max FDV (ms)	Max FLR (PPM)
1	<input checked="" type="checkbox"/>	5.000	10
2	<input checked="" type="checkbox"/>	5.000	10
3	<input type="checkbox"/>	5.000	10
4	<input type="checkbox"/>	5.000	10
5	<input type="checkbox"/>	5.000	10
6	<input type="checkbox"/>	5.000	10

Figure 3.11.6-63 Services Setup – Max FLR Column

Use the **Up/Down/Left/Right**-arrow keys to enter the value for Max Frame Loss ratio in PPM. Press the **Set** key to complete the editing process.

The screenshot shows the same 'Services' setup screen as Figure 3.11.6-63, but with a pop-up editor for 'Max FLR, Port A, Service 1 [PPM]'. The editor has a numeric keypad with '10' entered. It also shows 'Max: 1000000' and 'Min: 0'. The background table is dimmed.

SRV #	FTD Enables	Max FDV (ms)	Max FLR (PPM)
1	<input checked="" type="checkbox"/>	5.000	10
2	<input checked="" type="checkbox"/>	5.000	10
3	<input type="checkbox"/>	5.000	10
4	<input type="checkbox"/>	5.000	10
5	<input type="checkbox"/>	5.000	10
6	<input type="checkbox"/>	5.000	10

Figure 3.11.6-64 Services Setup – Max FLR Pop-up Editor

MPLS Column(s) (Optional)

Press the **Right**-arrow key to move the highlight to the **MPLS 1** column, as shown in Figure 3.11.6-65.

When a cell in the MPLS 1 column is highlighted, pressing the **Set** key will cause the MPLS screen to be displayed, as shown in Figure 3.11.6-66.

Note:

The **MPLS 1** column begins the **Misc.** section of the table. The label on the **F2 Table** soft-key will change to show **Misc.**

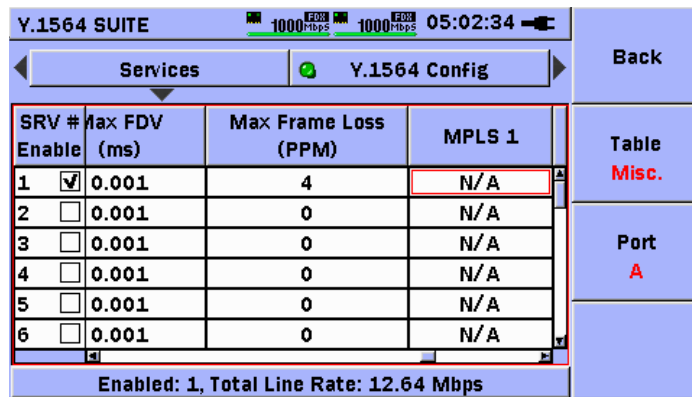

Figure 3.11.6-65 Services Setup – MPLS 1 Column

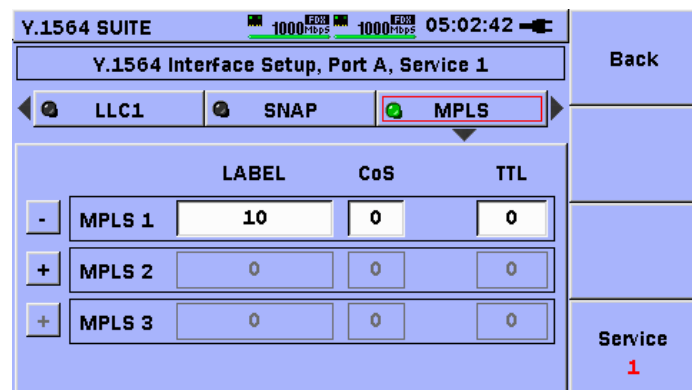

Figure 3.11.6-66 Services Setup – MPLS Enable / Input Screen

Use the **Up/Down/Left/Right**-arrow keys to move the highlight to the **MPLS** button, as shown in Figure 3.11.6-64. Press the **Set** key to enable (LED ON) or disable (LED OFF) the inclusion of MPLS headers in the test frames.

Assuming the MPLS feature is enabled (LED ON), use the **Up/Down/Left/Right**-arrow keys to move the highlight to the **LABEL** field of the **MPLS 1** row. Press the **Set** key to display the **LABEL** editor. Use

the **Up/Down/Left/Right**-arrow keys to edit the LABEL value. Press the **Set** key to release the editor and return to the previous screen.

Move the highlight to the CoS field. Press the **Set** key to display the CoS pop-up editor. Use the **Up/Down**-arrow keys to edit the CoS number. Press the **Set** key to release the editor and return to the previous screen.

Move the highlight to the TTL field. Press the **Set** key to display the TTL editor. Use the **Up/Down/Left/Right**-arrow keys to edit the TTL value. Press the **Set** key to release the editor and return to the previous screen.

Notes:

- If more than one level of MPLS is required to be defined, it can be accomplished from this dialog (Figure 3.11.6-66). Use the **Up/Down/Left/Right**-arrow keys to move the highlight over the + field to the left of the MPLS 2 label. Press the **Set** key to enable the input fields. Repeat the procedure above to input the desired LABEL, COS, and TTL settings. Once MPLS 2 is enabled then MPLS 3 can be enabled if required. Repeat the same procedure for MPLS 3.
- When a cell in the MPLS 1, MPLS 2, or MPLS 3 columns (as shown in Figure 3.11.6-67) is highlighted, pressing the **Set** key will cause the MPLS screen to be displayed, as shown in Figure 3.11.6-66. All MPLS columns are processed in the same manner as described above.

SRV #s Enable	MPLS 1	MPLS 2	MPLS 3
1 <input checked="" type="checkbox"/>	10	N/A	N/A
2 <input type="checkbox"/>	N/A	N/A	N/A
3 <input type="checkbox"/>	N/A	N/A	N/A
4 <input type="checkbox"/>	N/A	N/A	N/A
5 <input type="checkbox"/>	N/A	N/A	N/A
6 <input type="checkbox"/>	N/A	N/A	N/A

Enabled: 1, Total Line Rate: 12.64 Mbps

Figure 3.11.6-67 Services Setup – MPLS 1, 2, 3 Columns

UDP Column (Optional)

Press the **Right**-arrow key (several times) to move the highlight to the **UDP column**, as shown in Figure 3.11.6-68.

When a cell in the UDP column is highlighted, pressing the **Set** key will cause the UDP input screen to be displayed, as shown in Figure 3.11.6-69.

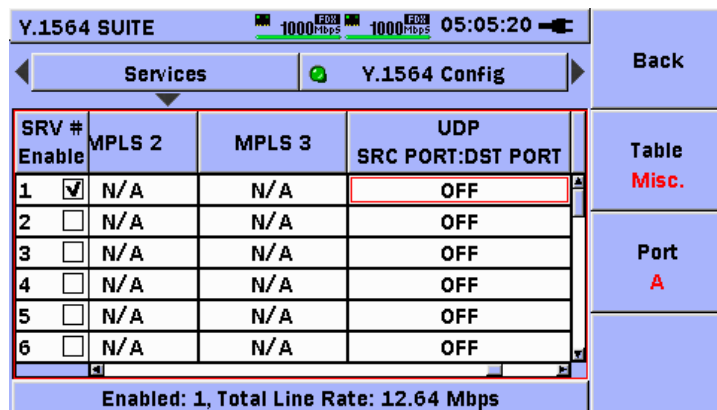

Figure 3.11.6-68 Services Setup – UDP Ports Column

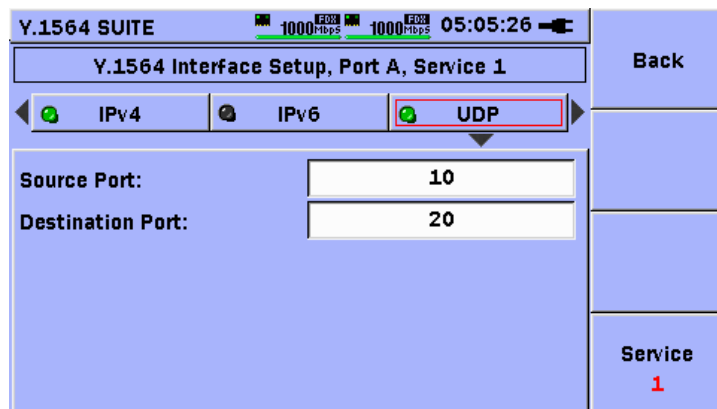

Figure 3.11.6-69 Services Setup – UDP Enable / Input Screen

Use the **Up/Down/Left/Right**-arrow keys to move the highlight to the **UDP** button, as shown in Figure 3.11.6-69. Press the **Set** key to enable (LED ON) or disable (LED OFF) the inclusion of UDP port numbers in the IP header.

Use the **Up/Down/Left/Right**-arrow keys to move the highlight to input field across from the Source Port: label. Press the **Set** key to display the Source Port editor. Use the **Up/Down/Left/Right**-arrow keys to edit the Source Port value. Press the **Set** key to release the editor and return to the previous screen.

Use the **Up/Down/Left/Right**-arrow keys to move the highlight to input field across from the Destination Port: label. Press the **Set** key to display the Destination Port editor. Use the **Up/Down/Left/Right**-arrow keys to edit the Destination Port value. Press the **Set** key to release the editor and return to the previous screen.

Press the **F1 Back** soft-key to return to the Service setup table.

TCP Column (Optional)

Press the **Right**-arrow key to move the highlight to the TCP column, as shown in Figure 3.11.6-70.

When a cell in the TCP column is highlighted, pressing the **Set** key will cause the TCP input screen to be displayed, as shown in Figure 3.11.6-71.

The screenshot shows the 'Services Setup' screen in the Y.1564 Suite. At the top, it displays 'Y.1564 SUITE', signal strength, speed (1000 Mbps), and time (05:05:34). Below this is a navigation bar with 'Services' and 'Y.1564 Config'. The main area is a table with columns for 'SRV #', 'Enable', 'UDP SRC PORT:DST PORT', and 'TCP SRC PORT:DST PORT'. The 'TCP' column is highlighted. The status bar at the bottom indicates 'Enabled: 1, Total Line Rate: 12.64 Mbps'. On the right side, there are buttons for 'Back', 'Table Misc.', and 'Port A'.

SRV #	Enable	UDP SRC PORT:DST PORT	TCP SRC PORT:DST PORT
1	<input checked="" type="checkbox"/>	10:20	OFF
2	<input type="checkbox"/>	OFF	OFF
3	<input type="checkbox"/>	OFF	OFF
4	<input type="checkbox"/>	OFF	OFF
5	<input type="checkbox"/>	OFF	OFF
6	<input type="checkbox"/>	OFF	OFF

Figure 3.11.6-70 Services Setup – TCP Column

Use the **Up/Down/Left/Right**-arrow keys to move the highlight to the TCP button, as shown in Figure 3.11.6-71. Press the **Set** key to enable (LED ON) or disable (LED OFF) the inclusion of TCP port numbers and other TCP specific fields in the IP header.

Use the **Up/Down/Left/Right**-arrow keys to move the highlight to input field across from the **Source Port:** label. Press the **Set** key to display the Source Port editor. Use the **Up/Down/Left/Right**-arrow keys to edit the Source Port value. Press the **Set** key to release the editor and return to the previous screen.

Use the **Up/Down/Left/Right**-arrow keys to move the highlight to input field across from the **Destination Port:** label. Press the **Set** key to display the Destination Port editor. Use the **Up/Down/Left/Right**-arrow keys to edit the Destination Port value. Press the **Set** key to release the editor and return to the previous screen.

Use the **Up/Down/Left/Right**-arrow keys to move the highlight to input field across from the **Sequence number:** label. Press the **Set** key to display the Sequence number editor. Use the **Up/Down/Left/Right**-arrow keys to edit the Sequence number value. Press the **Set** key to release the editor and return to the previous screen.

Use the **Up/Down/Left/Right**-arrow keys to move the highlight to input field across from the **Ack. Number:** label. Press the **Set** key to display the Ack. Number: editor. Use the **Up/Down/Left/Right**-arrow keys to edit the Ack. Number: value. Press the **Set** key to release the editor and return to the previous screen.

Use the **Up/Down/Left/Right**-arrow keys to move the highlight to input field across from the **Reserved:** label. Press the **Set** key to display the Reserved: editor. Use the **Up/Down/Left/Right**-arrow keys to edit the Reserved: value. Press the **Set** key to release the editor and return to the previous screen.

Use the **Up/Down/Left/Right**-arrow keys to move the highlight to input field across from the **Flags:** label. Press the **Set** key to display the Flags: editor. Use the **Up/Down/Left/Right**-arrow keys to edit the Flags: value. Press the **Set** key to release the editor and return to the previous screen.

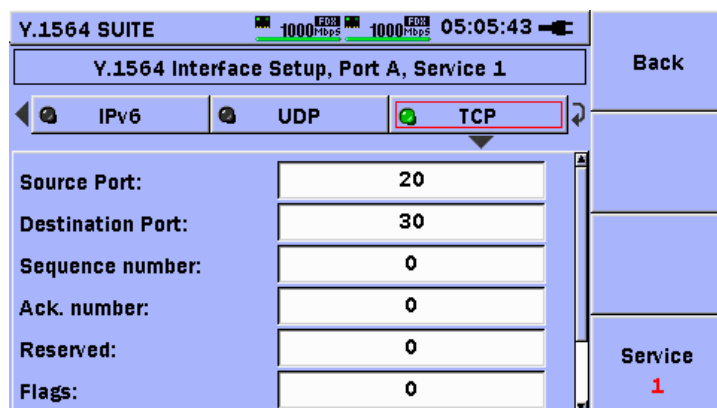

Figure 3.11.6-71 Services Setup – TCP Enable / Input Screen

Press the **F1 Back** soft-key to return to the Service setup table.

LLC1 Column (Optional)

Press the **Right**-arrow key to move the highlight to the **LLC 1** column, as shown in Figure 3.11.6-72.

When a cell in the LLC 1 column is highlighted, pressing the **Set** key will cause the LLC 1 screen to be displayed, as shown in Figure 3.11.6-73.

The screenshot shows the 'Services' configuration screen in the Y.1564 Suite. At the top, it displays 'Y.1564 SUITE', signal strength, speed (1000 Mbps), and time (05:05:57). Below this is a navigation bar with 'Services' and 'Y.1564 Config' buttons, and a 'Back' button on the right. The main area is a table with columns: SRV #, P, Enable, DST PORT, TCP SRC PORT:DST PORT, and LLC 1. The 'LLC 1' column is highlighted with a red border. The table contains six rows of service configurations. At the bottom, a status bar shows 'Enabled: 1, Total Line Rate: 12.64 Mbps'. On the right side of the screen, there are buttons for 'Table Misc.' and 'Port A'.

SRV #	P	Enable	DST PORT	TCP SRC PORT:DST PORT	LLC 1
1	F	<input checked="" type="checkbox"/>	F	20:30	OFF
2	F	<input type="checkbox"/>	F	OFF	OFF
3	F	<input type="checkbox"/>	F	OFF	OFF
4	F	<input type="checkbox"/>	F	OFF	OFF
5	F	<input type="checkbox"/>	F	OFF	OFF
6	F	<input type="checkbox"/>	F	OFF	OFF

Figure 3.11.6-72 Services Setup – LLC1 Column

Use the **Up/Down/Left/Right**-arrow keys to move the highlight to the LLC 1 button, as shown in Figure 3.11.6-73. Press the **Set** key to enable (LED ON) or disable (LED OFF) the inclusion of LLC 1 headers in the test frames.

Note:

The LLC 1 and SNAP headers are related. Both LLC 1 and SNAP may be ON. If LLC 1 is OFF, SNAP must be OFF. LLC 1 can be ON when SNAP is OFF. This behavior is enforced by the software automatically.

The screenshot shows the 'LLC1 Enable Screen' in the Y.1564 Suite. At the top, it displays 'Y.1564 SUITE', signal strength, speed (1000 Mbps), and time (05:06:03). Below this is a navigation bar with 'Y.1564 Interface Setup, Port A, Service 1' and a 'Back' button on the right. The main area shows three buttons: 'MAC', 'VLAN', and 'LLC1'. The 'LLC1' button is highlighted with a red border. Below the buttons, the following values are displayed: DSAP: AA, SSAP: AA, and Control: 3. At the bottom right, there is a 'Service 1' button.

Figure 3.11.6-73 Services Setup – LLC1 Enable Screen

Press the **F1 Back** soft-key to return to the Service setup table.

SNAP Column (Optional)

Press the **Right**-arrow key to move the highlight to **the SNAP column**, as shown in Figure 3.11.6-74.

When a cell in the SNAP column is highlighted, pressing the **Set** key will cause the SNAP screen to be displayed, as shown in Figure 3.11.6-75.

SRV #	TCP Enable	C PORT:DST PORT	LLC 1	SNAP
1	<input checked="" type="checkbox"/>	20:30	ON	ON
2	<input type="checkbox"/>	OFF	OFF	OFF
3	<input type="checkbox"/>	OFF	OFF	OFF
4	<input type="checkbox"/>	OFF	OFF	OFF
5	<input type="checkbox"/>	OFF	OFF	OFF
6	<input type="checkbox"/>	OFF	OFF	OFF

Enabled: 1, Total Line Rate: 12.64 Mbps

Figure 3.11.6-74 Services Setup – SNAP Column

Use the **Up/Down/Left/Right**-arrow keys to move the highlight to the SNAP button, as shown in Figure 3.11.6-73. Press the **Set** key to enable (LED ON) or disable (LED OFF) the inclusion of SNAP headers in the test frames.

Note:

The LLC 1 and SNAP headers are related. Both LLC 1 and SNAP may be ON. If LLC 1 is OFF, SNAP must be OFF. LLC 1 can be ON when SNAP is OFF. This behavior is enforced by the software automatically.

Y.1564 Interface Setup, Port A, Service 1

VLAN LLC1 SNAP

OUI: 0

Service 1

Figure 3.11.6-75 Services Setup – SNAP Enable Screen

3.11.7 Y.1564 Config Setup

After defining the Services to be used for the test(s), move to the **Y.1564 Config** setup screen (button).

The Y.1564 Config test includes five (5) possible sub-tests, which can be enabled independently. The Y.1565 Config test transmits each enabled Service one at a time, at various rates as prescribed by the standard, based on user inputs for CIR, EIR, CBS, and EBS.

Use the **Up/Down/Left/Right**-arrow keys to move the highlight to the Y.1564 Config button, as shown in Figure 3.11.7-1. Press the **Set** key to enable (LED ON) or disable (LED OFF) the Y.1564 Config test.

Notes:

- The MU909060A has two (2) ports A and B. The Y.1564 Config test can be configured and enabled independently for each port. Pay careful attention to the state of the **F3 Port A/B** soft-key when making the enable / disable selection.
- One or both of the Y.1564 Config test and Y.1564 Perform test must be enabled (LED ON). If the user attempts to disable (LED OFF) one test while the other is disabled, the other test will be enabled (LED ON) automatically.

Service	Step	% CIR	Enabled
<input checked="" type="checkbox"/> CIR	<input checked="" type="checkbox"/> 1	5	Services: 1
<input checked="" type="checkbox"/> Ramped	<input checked="" type="checkbox"/> 2	10	X
<input checked="" type="checkbox"/> EIR	<input checked="" type="checkbox"/> 3	25	Enabled
<input checked="" type="checkbox"/> Traffic Police	<input checked="" type="checkbox"/> 4	50	Tests+Steps: 10
<input checked="" type="checkbox"/> CBS	<input checked="" type="checkbox"/> 5	75	X
<input checked="" type="checkbox"/> EBS	Test/Step Time: 5 Sec		
Estimated Test Time:			00:01:30

Figure 3.11.7-1 Y.1564 Config Setup Screen

This screen will provide a method to input the following fields:

Table 3.11.7-1 Y.1564 Config Test Setup Fields

Option	Selections	Description
CIR	Enable (√) or (un-√) disable. Default is enabled (√).	Enables the CIR test. All enabled services will be processed as defined in the standard under the CIR test.
Ramped	Enable (√) or (un-√) disable. The ramp will offer up to five (5) throughput levels, defined as a percentage of each Service's CIR. When checked (√), a ramp level will be enabled. Default is disabled (un-√). The ramp configuration is common for all configured services.	Each ramp step is defined as a percentage of CIR. Ramp steps are not required to be enabled in order. Ramp steps are not required to be defined in increasing order of % CIR. Range: [0% to 100%] Default: 0%
EIR	Enable (√) or (un-√) disable. Default is disabled (un-√).	Enables the EIR test. All enabled services with EIR > 0 will be processed as defined in the standard under the EIR test.
Traffic Policing	Enable (√) or (un-√) disable. Default is disabled (un-√).	Enables the Traffic Policing test. All enabled services with EIR > 0 will be processed as defined in the standard under the Traffic Policing test.
M	Margin value.	This value is used to adjust the threshold for the traffic policing test depending on the accuracy of the policing algorithms of the network equipment being tested.
CBS	Enable (√) or (un-√) disable. Default is disabled (un-√).	Enables the CBS test. All enabled services with CBS > 0 will be processed as defined in the standard under the CBS test.
EBS	Enable (√) or (un-√) disable. Default is disabled (un-√).	Enables the EBS test. All enabled services with EIR > 0 and EBS > 0 will be processed as defined in the standard under the EBS test.
Step Time	The duration of each throughput step in seconds.	Input range [1, 60]. Default is 5 seconds.
Total Test Time	Calculated	Product of Step Time x (Steps + Other) x Services x Overhead + Fixed Overhead.

Use the **Up/Down/Left/Right**-arrow keys to move the highlight to the check-box to the left of the CIR label. Press the **Set** key to enable (✓) or disable (un-✓) the CIR test.

If the CIR test is enabled, the Ramped option can be enabled. If Ramped operation is desired, assuming CIR is enabled, use the **Up/Down/Left/Right**-arrow keys to move the highlight to the check-box to the left of the Ramped label. Press the **Set** key to enable (✓) or disable (un-✓) the Ramped option. If the Ramped option is enabled, the Ramp step enable check-boxes and Ramp step input fields will be enabled. Otherwise these fields are disabled (grayed-out).

Use the **Up/Down/Left/Right**-arrow keys to move the highlight to the check-box to the left of the EIR label. Press the **Set** key to enable (✓) or disable (un-✓) the EIR test.

Use the **Up/Down/Left/Right**-arrow keys to move the highlight to the check-box to the left of the Traffic Police label. Press the **Set** key to enable (✓) or disable (un-✓) the Traffic Policing test.

If the Traffic Policing test is enabled, the M (margin) value input can be entered, otherwise the field is grayed-out (disabled for input). Use the **Up/Down/Left/Right**-arrow keys to move the highlight to the input field to the right of the M label. Press the **Set** key to display the Margin input editor, as shown in Figure 3.11.7-2. Use the **Up/Down/Left/Right**-arrow keys to input the M(argin) value. Press the **Set** key to complete the editing process.

The screenshot shows the 'Y.1564 Config' screen for 'Port A'. The 'Traffic' test is enabled (checked). The 'M' value is currently set to 1. A pop-up window titled 'Y.1564 SUITE 1 Port A, Traffic Police Margin' is open, showing a numeric keypad with the value 1.000 entered. The background shows the following configuration:

<input checked="" type="checkbox"/> CIR	<input type="checkbox"/> Ramped	<input type="checkbox"/> EIR	<input checked="" type="checkbox"/> Traffic	M: 1	<input type="checkbox"/> CBS	<input checked="" type="checkbox"/> 5	<input type="checkbox"/> 75	<input checked="" type="checkbox"/> X	Test/Step Time: 5 Sec	Estimated Test Time: 00:00:18
---	---------------------------------	------------------------------	---	------	------------------------------	---------------------------------------	-----------------------------	---------------------------------------	-----------------------	-------------------------------

Figure 3.11.7-2 Y.1564 Config Setup – M Value Editor

Use the **Up/Down/Left/Right**-arrow keys to move the highlight to the check-box to the left of the CBS label. Press the **Set** key to enable (✓) or disable (un-✓) the CBS test.

Use the **Up/Down/Left/Right**-arrow keys to move the highlight to the check-box to the left of the EBS label. Press the **Set** key to enable (✓) or disable (un-✓) the EBS test.

To define Ramp steps, assuming the Ramped check-box is enabled, use the **Up/Down/Left/Right**-arrow keys to move the highlight to any of the check-boxes under the Step label. Press the **Set** key to enable (✓) or disable (un-✓) the individual steps. Use the **Up/Down/Left/Right**-arrow keys to move the highlight to any of the input fields to the right of the check-boxes under the % CIR label. Press the **Set** key to display the Percentage (%) editor, as shown in Figure 3.11.7-3. Use the **Up/Down/Left/Right**-arrow keys to enter the desired percentage of CIR for the step. Press the **Set** key to complete the editing process.

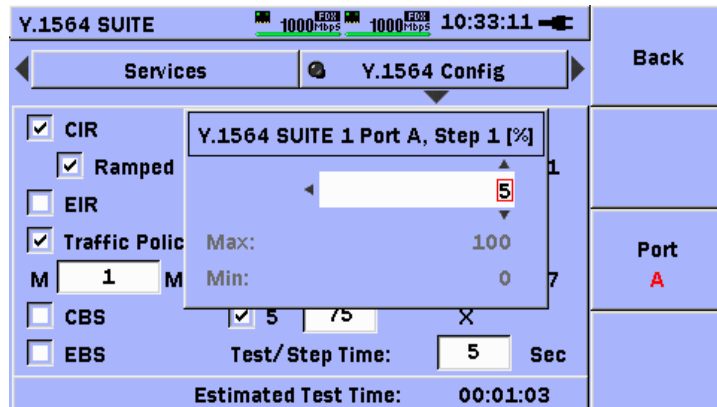

Figure 3.11.7-3 Y.1564 Config Setup – Ramp Step %CIR Editor

Use the **Up/Down/Left/Right**-arrow keys to move the highlight to the input field to the right of the Test/Step Time: label. Press the **Set** key to display the Step Time editor, as shown in Figure 3.11.7-4. Use the **Up/Down/Left/Right**-arrow keys to enter the desired step time. Press the **Set** key to complete the editing process.

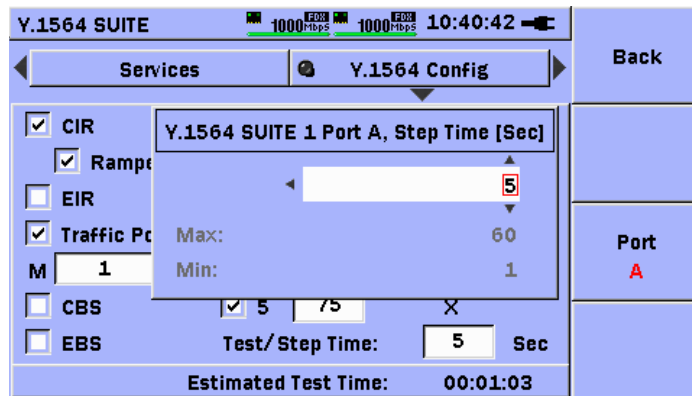

Figure 3.11.7-4 Y.1564 Config Setup – Step Time Editor

Note:

The estimated test time will be calculated by the software. This estimate includes overhead per step and a fixed overhead at the start of the test.

3.11.8 Y.1564 Perform Setup

After defining the inputs specific to the Y.1564 Config test, move to the **Y.1564 Perform** setup screen (button), as shown in Figure 3.11.8-1 below. The Y.1564 Perform test transmits all selected Services concurrently at their defined CIR rate.

Note:

The MU909060A has two (2) ports A and B. The Y.1564 Perform test can be configured and enabled independently for each port. Pay careful attention to the state of the **F3 Port A/B** soft-key when making the enable / disable selection.

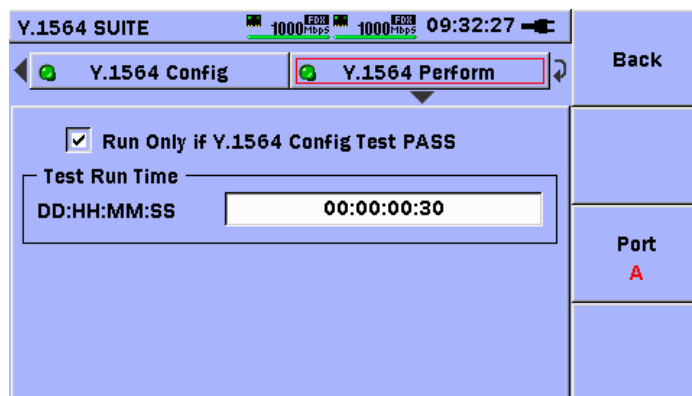

Figure 3.11.8-1 Y.1564 Perform Setup Screen

This screen will provide a method to input the following fields:

Table 3.11.8-1 Y.1564 Perform Test Inputs

Option	Selections	Comments
Enable / Disable	Enable (LED ON) Disable (LED OFF)	The Y.1564 Perform test can be enabled or disabled independently of the Y.1564 Config test.
Run Only if Y.1564 Config Test PASS	Enabled (√), Disabled(un-√)	If checked, run the Performance test only if the Configuration test has passed all metrics for all Services.
Test Run Time	The total run time in (DD:HH:MM:SS) for the performance test.	Range: 3 seconds to 30 days.

Use the **Up/Down/Left/Right**-arrow keys to move the highlight to the Y.1564 Perform button, as shown in 3.11.8-1. Press the **Set** key to enable (LED ON) or disable (LED OFF) the Y.1564 Perform test.

Note:

One or both of the Y.1564 Config test and Y.1564 Perform test must be enabled (LED ON). If the user attempts to disable (LED OFF) one test while the other is disabled, the other test will be enabled (LED ON) automatically.

Use the **Up/Down/Left/Right**-arrow keys to move the highlight to the check-box to the left of the label Run Only if Y.1564 Config Test PASS. Press the **Set** key to enable (√) or disable (un-√) this feature.

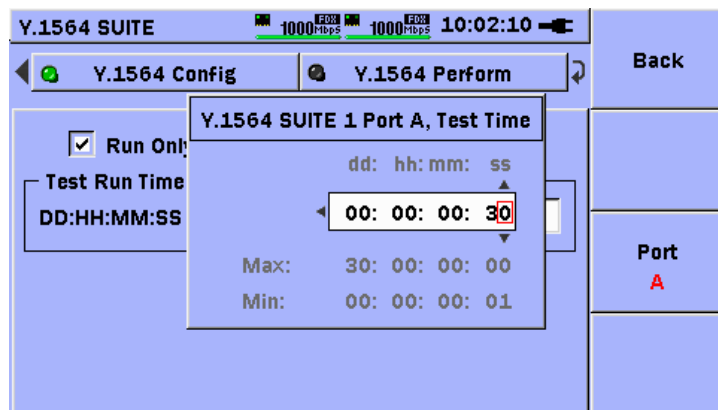

Figure 3.11.8-2 Y.1564 Perform Test Time Editor

Use the **Up/Down/Left/Right**-arrow keys to move the highlight to the field to the right of the DD:HH:MM:SS label. Press the **Set** key to display the Test Time editor, as shown in Figure 3.11.8-2. Use the **Up/Down/Left/Right**-arrow keys to input the desired time value. Press the **Set** key to complete the editing process.

3.11.9 Y.1564 ARP Processing

Up to thirty-two (32) services can be defined and each service can include an ARP request. The software will process all ARP requests in sequence at the start of the test. If one or more ARP requests fail, the test will not proceed. This processing method is necessary to prevent interruption of a test in progress due to a failed ARP request.

3.11.10 Y.1564 Test Flow

Note:

The test will be processed by column. Each Service will be completed before the next service is started.

General processing rules:

At least one (1) Service must be enabled for the Y.1564 Config Test or Y.1564 Perform test to start. This requirement will be checked upon starting the test. An error message will be presented to the user if no Services are enabled.

If the enable LED of the Y.1564 Config test is ON (enabled), at least one sub-test must be enabled or the test will not start. If no sub-tests are enabled an error message will be presented to the user.

If the enable LED of the Y.1564 Config test is OFF (disabled), then the state of the “Run Only if Y.1564 Config Test PASS” check-box on the Y.1564 Perform setup screen will be ignored.

If the enable LED of the Y.1564 Config test is ON (enabled), and the Run Only if Y.1564 Config Test PASS” check-box on the Y.1564 Perform setup screen is enabled (✓), the Y.1564 Config test must show a PASS verdict or the Y.1564 Perform test will not start.

3.11.11Y.1564 Test Processing

The following tables describe the user inputs, processing, FAIL criteria, and results for each sub-test of the Y.1564 Suite.

Table 3.11.11-1 CIR Test - Inputs and FAIL Criteria

SubTest	Color	Ramp	Description
CIR	N/A	No	Enabled Services are processed one at a time. A single stream is transmitted at the specified CIR rate using the specified Frame Profile and Payload Pattern . Parameters IR, FTD, FDV, and FL are measured ⁽¹⁾ . If the P/F judgment for a stream results in a FAIL indication, the entire test is stopped.

Table 3.11.11-2 CIR Test - Inputs and FAIL Criteria

Setup Parameters	Measured Parameters ⁽³⁾	FAIL Criteria (OR)	Results
CIR Frame Profile Payload Pattern Max FTD _T Max FDV _T Max FLR _T	Min, Avg, Max IR Min, Avg, Max, FTD Min, Avg, Max, FDV FL _{Count} FL _{Rate}	Max FTD _M > Max FTD _T Max FDV _M > Max FDV _T FL _{Rate,M} > Max FLR _T	One row per enabled Service.

Table 3.11.11-3 Ramped CIR Test – Inputs and FAIL Criteria

SubTest	Color	Ramp	Description
CIR	N/A	Yes	A ramp is defined using up to five (5) steps. Each step is defined as a percentage of CIR <= 100%. A final step at 100% of CIR is always processed. The ramp applies to all enabled Services. Enabled Services are processed one at a time. For each enabled step, a single stream is transmitted at the specified step rate using the specified Frame Profile and Payload Pattern . Parameters IR, FTD, FDV, and FL are measured ⁽¹⁾ . If the P/F judgment for a stream / step combination results in a FAIL indication, the entire test is stopped.

Table 3.11.11-4 Ramped CIR Test – Inputs and FAIL Criteria

Setup Parameters	Measured Parameters ⁽³⁾	FAIL Criteria (OR)	Results
CIR Frame Profile Payload Pattern Max FTD _T Max FDV _T Max FLR _T Ramp Definition	Min, Avg, Max IR Min, Avg, Max, FTD Min, Avg, Max, FDV FL _{Count} FL _{Rate}	Max FTD _M > Max FTD _T Max FDV _M > Max FDV _T FL _{Rate,M} > Max FLR _T	One row per enabled Service per step.

Table 3.11.11-5 EIR Test – Inputs and FAIL Criteria

SubTest	Color	Ramp	Description
EIR	No	N/A	Enabled Services are processed one at a time. A single stream is transmitted at the specified CIR+EIR rate using the specified Frame Profile and Payload Pattern . Parameters IR , FTD , FDV , and FL are measured ⁽¹⁾ . If the P/F judgment for the stream results in a FAIL indication, the entire test is stopped.

Table 3.11.11-6 EIR Test – Inputs and FAIL Criteria

Setup Parameters	Measured Parameters ⁽³⁾	FAIL Criteria (OR)	Results
CIR EIR Frame Profile Payload Pattern Max FLR _T	Min, Avg, Max IR Min, Avg, Max, FTD Min, Avg, Max, FDV FL _{Count} FL _{Rate}	(Average IR _M > CIR _T + EIR _T) CIR*(1-FLR _T) > Average IR _M	One row per enabled Service.

Table 3.11.11-7 EIR (Colored Mode) Test – Inputs and FAIL Criteria

SubTest	Color	Ramp	Description
EIR	Yes	N/A	Enabled Services are processed one at a time. A stream is transmitted at the specified CIR rate using the specified Frame Profile, Payload Pattern and GREEN color identifier ⁽²⁾ . A second stream is transmitted at the specified EIR rate using the specified Frame Profile, Payload Pattern and YELLOW color identifier. Parameters IR, FTD, FDV, and FL are measured ⁽¹⁾ for each colored stream. If the P/F judgment for a stream results in a FAIL indication, the entire test is stopped.

Table 3.11.11-8 EIR (Colored Mode) Test – Inputs and FAIL Criteria

Setup Parameters	Measured Parameters ⁽³⁾	FAIL Criteria (OR)	Results
CIR EIR Frame Profile Payload Pattern Color Definition IP DSCP (GR/YL) or VLAN Priority (GR/YL) Max FTD _T Max FDV _T Max FLR _T	Min, Avg, Max IR Min, Avg, Max, FTD Min, Avg, Max, FDV FL _{Count} FL _{Rate}	Max FTD _{M,G} > Max FTD _T Max FDV _{M,G} > Max FDV _T Max FL _{Rate,M,G} > Max FLR _T M,G = Measured, Green Yellow colored Services always show COMPLETED. No P/F judgment is made.	One row for each Service-Color combination.

Table 3.11.11-9 Traffic Policing Test – Inputs and FAIL Criteria

SubTest	Color	Ramp	Description
Traffic Policing	No	N/A	Enabled Services are processed one at a time. A single stream is transmitted at the specified CIR+125% EIR or, if EIR < 20% CIR, then 125% CIR + EIR, rate using the specified Frame Profile and Payload Pattern . Parameters IR, FTD, FDV, and FL are measured ⁽¹⁾ . If the P/F judgment for a stream results in a FAIL indication, the entire test is stopped.

Table 3.11.11-10 Traffic Policing Test – Inputs and FAIL Criteria

Setup Parameters	Measured Parameters ⁽³⁾	FAIL Criteria (OR)	Results
CIR EIR Frame Profile Payload Pattern M Max FLR _T	Min, Avg, Max IR Min, Avg, Max, FTD Min, Avg, Max, FDV FL _{Count} FL _{Rate}	Average IR _M > CIR _T + EIR _T +M CIR*(1-FLR _T) > Average IR _M	One row per enabled Service.

Table 3.11.11-11 Traffic Policing (Colored Mode) Test – Inputs and FAIL Criteria

SubTest	Color	Ramp	Description
Traffic Policing	Yes	N/A	Enabled Services are processed one at a time. A stream is transmitted at the specified CIR rate using the specified Frame Profile, Payload Pattern and GREEN color identifier ⁽²⁾ . A second stream is transmitted at the specified 125% EIR or if EIR < 20% CIR, then 25% CIR + 100% EIR rate using the specified Frame Profile, Payload Pattern and YELLOW color identifier. Parameters IR, FTD, FDV, and FL are measured ⁽¹⁾ for each colored stream. If the P/F judgment for a stream results in a FAIL indication, the entire test is stopped.

Table 3.11.11-12 Traffic Policing (Colored Mode) Test – Inputs and FAIL Criteria

Setup Parameters	Measured Parameters ⁽³⁾	FAIL Criteria (OR)	Results
CIR EIR Frame Profile Payload Pattern Color Definition IP DSCP (GR/YL) or VLAN Priority (GR/YL) M Max FTD _T Max FDV _T Max FLR _T	Min, Avg, Max IR Min, Avg, Max, FTD Min, Avg, Max, FDV FL _{Count} FL _{Rate}	Average IR _M > CIR _T + EIR _T +M Max FTD _{M,G} > Max FTD _T Max FDV _{M,G} > Max FDV _T Max FL _{Rate,M,G} > Max FLR _T M,G = Measured, Green Yellow colored Services always show COMPLETED. No P/F judgment is made.	One row for each Service-Color combination.

Table 3.11.11-13 CBS Test – Inputs and FAIL Criteria

SubTest	Color	Ramp	Description
CBS	N/A	N/A	Enabled Services are processed one at a time. A single stream which alternates between transmitting at the specified CIR rate and bursting at the specified CBS rate, using the specified Frame Profile and Payload Pattern is run. Parameters IR, FTD, FDV, and FL are measured ⁽¹⁾ . If the P/F judgment for the stream results in a FAIL indication, the entire test is stopped.

Table 3.11.11-14 CBS Test – Inputs and FAIL Criteria

Setup Parameters	Measured Parameters ⁽³⁾	FAIL Criteria (OR)	Results
CIR CBS Frame Profile Payload Pattern Max FTD _T Max FDV _T Max FLR _T	Min, Avg, Max IR Min, Avg, Max, FTD Min, Avg, Max, FDV FL _{Count} FL _{Rate}	Max FTD _M > Max FTD _T Max FDV _M > Max FDV _T Max FL _{Rate,M} > Max FLR _T	One row per enabled Service.

Table 3.11.11-15 EBS Test – Inputs and FAIL Criteria

SubTest	Color	Ramp	Description
EBS	No	N/A	Enabled Services are processed one at a time. A single stream which alternates between transmitting at the specified CIR ⁽⁵⁾ rate and bursting at the specified CBS+ EBS rate, using the specified Frame Profile and Payload Pattern is run. Parameters IR, FTD, FDV, and FL are measured ⁽¹⁾ . If the P/F judgment for the stream results in a FAIL indication, the entire test is stopped.

Table 3.11.11-16 EBS Test – Inputs and FAIL Criteria

Setup Parameters	Measured Parameters ⁽³⁾	FAIL Criteria (OR)	Results
CIR CBS EBS Frame Profile Payload Pattern Max FTD _T Max FDV _T Max FLR _T	Min, Avg, Max IR Min, Avg, Max, FTD Min, Avg, Max, FDV FL _{Count} FL _{Rate}	Max FTD _M > Max FTD _T Max FDV _M > Max FDV _T Max FL _{Rate,M} > Max FLR _T Note: All EBS frames could be lost in normal operation.	One row per enabled Service.

Table 3.11.11-17 EBS (Colored Mode) Test – Inputs and FAIL Criteria

SubTest	Color	Ramp	Description
EBS	Yes	N/A	Enabled Services are processed one at a time. A stream is transmitted which alternates between the specified CIR rate and bursting at the CBS rate, using the specified Frame Profile, Payload Pattern and GREEN color identifier ⁽²⁾ . A second stream is transmitted which alternates between the specified EIR rate and bursting at EBS, using the specified Frame Profile, Payload Pattern and YELLOW color identifier. Parameters IR, FTD, FDV, and FL are measured ⁽¹⁾ for each colored stream. If the P/F judgment for a stream results in a FAIL indication, the entire test is stopped.

Table 3.11.11-18 EBS (Colored Mode) Test – Inputs and FAIL Criteria

Setup Parameters	Measured Parameters ⁽³⁾	FAIL Criteria (OR)	Results
CIR EIR CBS EBS Frame Profile Payload Pattern Color Definition IP DSCP (GR/YL) or VLAN Priority (GR/YL) Max FTD _T Max FDV _T Max FLR _T	Min, Avg, Max IR Min, Avg, Max, FTD Min, Avg, Max, FDV FL _{Count} FL _{Rate}	Max FTD _{M,G} > Max FTD _T Max FDV _{M,G} > Max FDV _T Max FL _{Rate,M,G} > Max FLR _T M,G = Measured, Green Yellow colored Services always show COMPLETED. No P/F judgment is made.	One row for each Service-Color combination.

- (1) The method of measurement varies with the port/unit configuration.
- (2) The GREEN color identifier is the IP DSCP or VLAN Priority that is normally defined in the IP SRC or VLAN definition.
- (3) The MIN, AVERAGE, MAX for IR, FTD, and FDV is measured. Some are not used for P/F determination.

Table 3.11.11-19 Y.1564 Perform Test – Inputs and FAIL Criteria

SubTest	Color	Ramp	Description
Perform	N/A	N/A	All enabled Services are processed concurrently. A single stream per Service is transmitted at the specified CIR rate using the specified Frame Profile and Payload Pattern . Parameters IR, FTD, FDV, and FL are measured ⁽¹⁾ . If the P/F judgment for a stream results in a FAIL indication, the entire test is stopped.

Table 3.11.11-20 Y.1564 Perform Test – Inputs and FAIL Criteria

Setup Parameters	Measured Parameters ⁽²⁾	FAIL Criteria (OR)	Results
CIR Max FTD _T Max FDV _T Max FLR _T	Min, Avg, Max IR Min, Avg, Max, FTD Min, Avg, Max, FDV FL _{Count} FL _{Rate} AVAIL(%) UN-AVAIL(SeCs) SEQ ERR _{Count} SEQ ERR (%)	Max FTD _M > Max FTD _T Max FDV _M > Max FDV _T Max FL _{Rate,M} > Max FLR _T P/F is on an individual Service basis. P/F for FTD, FDV will be shown in real-time. P/F for FL will be shown at the end of the test.	All services are shown at once.

- (1) The method of measurement varies with the port/unit configuration.
- (2) The MIN, AVERAGE, MAX for IR, FTD, and FDV is measured. Some are not used for P/F determination.

3.11.12 Y.1564 Suite Global Results

The Y.1564 Suite test includes three (3) results tabs. The first result tab is Y.1564 Global which displays the overall status of the Y.1564 test.

Note:

The Global Verdict is a combined result for all tests, for all ports, for all directions.

While the test is running, the Y.1564 Global tab will indicate the status of the Y.1564 Config and Y.1564 Perform tests, as shown in Figure 3.11.12-1 below:

Table 3.11.12-1 Y.1564 Config and Perform Test Status Indications

Global Verdict	Description
RUNNING	The test is running.
PENDING	The test is waiting to run.
ABORTED	The test was stopped due to the failure of one of the metrics on another test.
N/A	The test is not enabled.

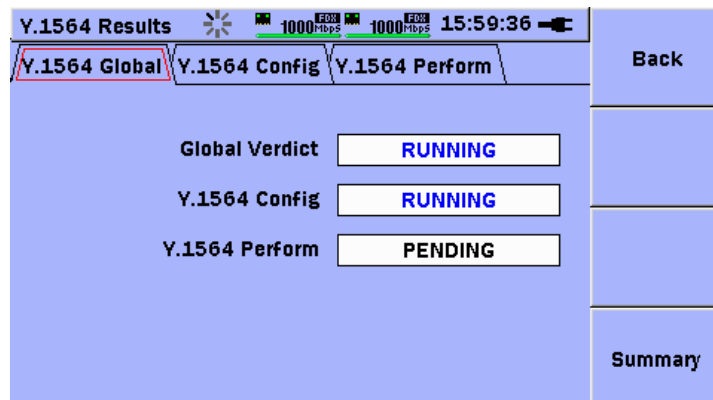

Figure 3.11.12-1 Global Results Screen

The Global Verdict field indicates one of the following values at the completion of the test, as shown in the example in Figure 3.11.12-2 below:

Table 3.11.12-2 Global Status Indications

Global Verdict	Description
PASS	All enabled tests (Y.1564 Config and/or Y.1564 Perform) have passed.
FAIL	One or both of the enabled tests (Y.1564 Config and/or Y.1564 Perform) have failed.
ABORTED	The Y.1564 Config or Y.1564 Perform test was stopped by the user before it completed.

The **Y.1564 Config** field indicates one of the following values at the completion of the test, as shown in the example in Figure 3.11.12-2 below:

Table 3.11.12-3 Y.1564 Config Verdict Indications

Global Verdict	Description
PASS	The Y.1564 Config test has passed.
FAIL	The Y.1564 Config test has failed.
ABORTED	The test was stopped by the user.

The Y.1564 Perform field indicates one of the following values at the completion of the test, as shown in the example in Figure 3.11.12-2 below:

Table 3.11.12-4 Y.1564 Perform Verdict Indications

Global Verdict	Description
PASS	The Y.1564 Perform test has passed.
FAIL	The Y.1564 Perform test has failed.
ABORTED	The test was stopped by the user or the Y.1564 Config test failed.

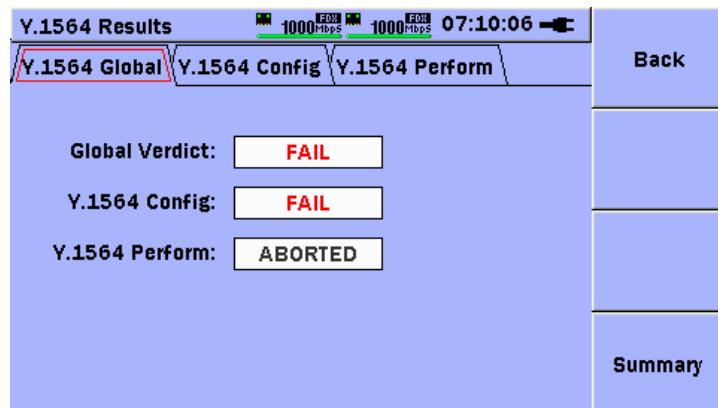

Figure 3.11.12-2 Global Results Screen

Press the **F1 Back** soft-key, to return to the Result Overview display.

Press the **F4 Summary** soft-key to view the summary statistics tabs and event log.

3.11.13 Y.1564 Config Results

The Y.1564 Config results tab displays the results of the Y.1564 Config sub-tests in table form using two (2) levels of detail; **Top Level** and **Detail Level**. When the Y.1564 Config tab is selected (as indicated by the RED highlight on the tab, as shown in Figure 3.11.13-1 below), press the **Down**-arrow key to move the highlight to the main table, as shown in Figure 3.11.13-2 below.

SRV #	SRV Name	All Tests	CIR	EIR
--	ALL	RUNNING	RUNNING	PENDING
1	Service	RUNNING	RUNNING	PENDING

Figure 3.11.13-1 Y.1564 Config Test – SRV#, SRV Name, All Tests Columns

SRV #	EIR	Traffic Policing	CBS	EBS
--	PASS	PASS	PENDING	PENDING
1	PASS	PASS	PENDING	PENDING

Figure 3.11.13-2 Y.1564 Config Test – EIR, Traffic Policing, CBS, EBS Columns

Note:

The user should be aware that in certain configurations, the results that are shown are a combination of transmitted Services from one port and received statistics from another port. These configurations are illustrated in the table below.

Table 3.11.13-1 Multi-Port Results Overview

Configuration	When Viewing Port	Comments
Switch Router Test Direction = LOOP	A B	Services transmitted on A, statistics received on B. Services transmitted on B, statistics received on A.
Single Ended Network Test Direction = LOOP	A B	Services transmitted on A, statistics received on A Services transmitted on B, statistics received on B
End to End Network Test Direction = L _A >R _B Direction = L _B >R _A Direction = R _A >L _B Direction = R _A >L _B	A A B B	Services transmitted L _A , received on R _B Services transmitted L _B , received on R _A Services transmitted R _A , received on L _B Services transmitted R _A , received on L _B All data is viewed on the local unit. The Results soft-key shows local/remote to indicate where the results were collected.

Note:

While the Top Level table view and the RED highlight rectangle is located on a cell that is not grayed-out, the message “Press Set to view all Y.1564 Config results.” is shown at the bottom of the display.

The first row in the Top Level table is reserved to show the status of **ALL tests**. This row is identified by the Service number (SRV #) “_” and the Service name (SRV Name) **ALL**. The remaining rows of the Top Level table correspond to the Services that were defined and enabled by the user in the Services setup table.

Note:

Due to the potentially large number of rows of results, the ALL Tests column and “_” row are not available for selection while the test is running, as indicated by the grey color of the cells in that row and column.

The Top Level table includes columns for all possible sub-tests, as shown in Table 3.11.13-2 below. Columns listed as Descriptive are used only to display information and are not selectable. Columns listed as Status can be selected by pressing the **Set** key.

Table 3.11.13-2 Top Level Results Columns

Column Heading	Type	Description
Service Number	Descriptive Non-selectable Grayed-out	Displays service numbers
Service Name	Descriptive Non-selectable Grayed-out	Displays service names
ALL Tests	Status / Selectable (when test is stopped).	Indicates the combined status of all sub-tests.
CIR	Status / Selectable	Indicates the status of the CIR sub-test.
EIR	Status / Selectable	Indicates the status of the EIR sub-test.
Traffic Policing	Status / Selectable	Indicates the status of the Traffic Policing sub-test.
CBS	Status / Selectable	Indicates the status of the CBS sub-test.
EBS	Status / Selectable	Indicates the status of the EBS sub-test.

Note:

If a sub-test was not enabled (not checked on the Y.1564 Config setup tab) in the setup process, the cells in the column for that sub-test will be disabled (grayed-out) and will not be selectable.

To view the Top Level status of all enabled Y.1564 Config sub-tests for all enabled Services, press the **Up/Down/Left/Right**-arrow keys to move the highlight to the first row of the table. Press the **Left/Right**-arrow keys to scroll though the columns for the various sub-tests.

To view the **Top Level status** of all enabled Y.1564 Config sub-tests **for a particular Service**, press the **Up/Down/Left/Right**-arrow keys to move the highlight to the row of the table that corresponds to that Service. Press the **Left/Right**-arrow keys to scroll though the columns for the various sub-tests.

The status of the sub-test is indicated in the cell and can have one of the following values:

Table 3.11.13-3 Sub-Test Status Indications

Value	Description
RUNNING	The test is running.
PENDING	The test is waiting to run.
ABORTED	The test was stopped due to the failure of one of the metrics on another test.
COMPLETED	The row for the yellow colored frames are not judged for P/F.
N/A	The test is not enabled.
PASS	The test has passed.
FAIL	The test has failed.

3

Examples of the Top Level results table are shown in Figures 3.11.13-1, 3.11.13-2, and 3.11.13-3.

Ethernet Application

The screenshot shows a web interface for 'Y.1564 Results 1'. At the top, there are tabs for 'Y.1564 Global', 'Y.1564 Config', and 'Y.1564 Perform'. Below the tabs is a table with the following columns: SRV #, EIR, Traffic Policing, CBS, and EBS. The table contains five rows, all with 'PENDING' status. A red selection bar is visible on the right side of the table, and a 'Back' button is located at the top right. Below the table, there is a 'Summary' button and a prompt: 'Press Set to view selected test(s) details.'

SRV #	EIR	Traffic Policing	CBS	EBS
--	PENDING	PENDING	PENDING	PENDING
1	PENDING	PENDING	PENDING	PENDING
2	PENDING	PENDING	PENDING	PENDING
3	PENDING	PENDING	PENDING	PENDING
4	PENDING	PENDING	PENDING	PENDING

Figure 3.11.13-3 Y.1564 Config Test – Traffic Policing, CBS, EBS Columns

The screenshot shows the same web interface as Figure 3.11.13-3, but with different test results. The table columns are: SRV #, All Tests, CIR, EIR, and Traffic Policing. The table contains five rows with various status indicators: FAIL, ABORTED, and PASS. A red selection bar is visible on the right side of the table, and a 'Back' button is located at the top right. Below the table, there is a 'Summary' button and a prompt: 'Press Set to view selected test(s) details.'

SRV #	All Tests	CIR	EIR	Traffic Policing
--	FAIL	ABORTED	ABORTED	FAIL
1	FAIL	PASS	PASS	FAIL
2	ABORTED	ABORTED	ABORTED	ABORTED
3	ABORTED	ABORTED	ABORTED	ABORTED
4	ABORTED	ABORTED	ABORTED	ABORTED

Figure 3.11.13-4 Y.1564 Config Test – Various Status Indications

To move from the **Top Level table view** to the **Detail Level table view**, use the **Up/Down/Left/Right**-arrow keys to move the selection indicator (RED rectangle) to a cell that is selectable (that is not grayed-out).

Press the **Set key** to view the detailed results for the combination of Service and sub-test defined by the row heading and column heading of the cell.

For example, to view the detailed results including the individual metrics for ALL tests and ALL services, use the **Up/Down/Left/Right**-arrow keys to position the highlight in the cell at the intersection of the ALL row and the All Tests column. Press the **Set key**. The details of all enabled services and all enabled tests will be displayed, as shown in Figure 3.11.13-6 below. Use the **Up/Down/Left/Right**-arrow keys to scroll through the table of results.

Note:

If a cell in the Top Level table shows a FAIL indication the user may desire to see the details of the individual metric that caused the failure. To view the individual metric that caused the failure, use the **Up/Down/Left/Right**-arrow keys to move the highlight over the cell that shows the FAIL indication. Press the **Set key** to move to the Detail Level table view. Use the **Up/Down/Left/Right**-arrow keys to show the cell in the Detail Level table that is highlighted in RED color, as shown in Figure 3.11.13-5 below. This is the metric that failed and caused the FAIL indication for the test in the Top Level table view.

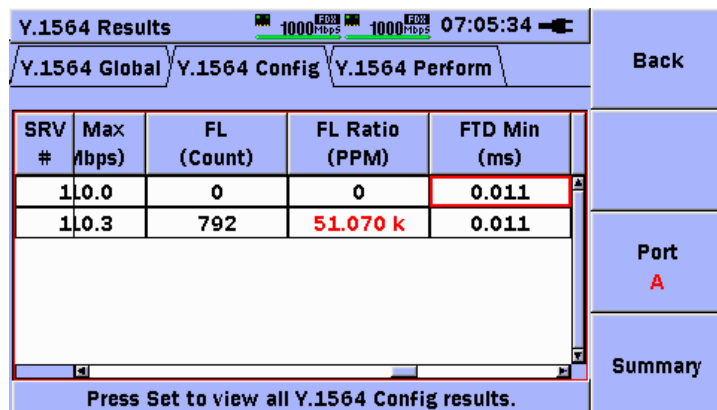

SRV #	Max (Mbps)	FL (Count)	FL Ratio (PPM)	FTD Min (ms)
1	0.0	0	0	0.011
1	0.3	792	51.070 k	0.011

Figure 3.11.13-5 Y.1564 Config Test – Individual Metric Fail Indication

The columns in the Detail Level table shown in Figures 3.11.13-6, 3.11.13-7, 3.11.13-8, 3.11.13-9 below and are described in Table 3.11.13-4 below:

Refer to section 3.11.10 of this document for a detailed description of the metrics per configuration.

Table 3.11.13-4 Detail Level Results Columns

Column	Description
SRV #	Service number
SRV Name	Service name
Test Type	CIR, EIR, Traffic Policing, CBS, EBS
Test Result	RUNNING, PENDING, PASS, FAIL, ABORTED,
Step (% CIR)	For stepped CIR test only. Shows the step in % CIR
Color	For colored mode tests only. GR = green, YL = yellow
Test Direction	A->B, B->A or LOOP
IR Min (Mbps)	Minimum Information Rate (utilization rate) in Mbps
IR Avg (Mbps)	Average Information Rate (utilization rate) in Mbps
IR Max (Mbps)	Maximum Information Rate (utilization rate) in Mbps
FL Count	Frame Loss count
FL Ratio (PPM)	Frame Loss Ratio in PPM
FTD Min (ms)	Minimum Latency (ms). Estimated for End to End configuration. For the End to End Network Test, ~FTD (approximate FTD) may be shown.
FTD Avg (ms)	Average Latency (ms). Estimated for End to End configuration. For the End to End Network Test, ~FTD (approximate FTD) may be shown.
FTD Max (ms)	Maximum Latency (ms). Estimated for End to End configuration. For the End to End Network Test, ~FTD (approximate FTD) may be shown.
FDV Min (ms)	Minimum Jitter (ms)
FDV Avg (ms)	Average Jitter (ms)
FDV Max (ms)	Maximum Jitter (ms)



Y.1564 Results 1  1000Mbps 1000Mbps 13:32:58 					Back
Y.1564 Global Y.1564 Config Y.1564 Perform					
SRV #	SRV Name	Test Type	Test Result	Step (% CIR)	
1	A-1	CIR	PASS	5	Port A
1	A-1	CIR	PASS	10	
1	A-1	CIR	PASS	25	
1	A-1	CIR	PASS	50	
1	A-1	CIR	PASS	75	
1	A-1	CIR	RUNNING	100	
Press Set to view all Y.1564 Config results.					Summary

Figure 3.11.13-6 Y.1564 Config – Detail Level Table (SRV#, SRV Name, Test Type, Test Result, Step %CIR)



Y.1564 Results 1  1000Mbps 1000Mbps 13:33:10 						Back
Y.1564 Global Y.1564 Config Y.1564 Perform						
SRV #	IR (Mbps)	Color	Test Direction	IR Min (Mbps)	IR Avg (Mbps)	
1	5.0	GR	A->B	5.0	5.0	Port A
10	10.0	GR	A->B	10.0	10.0	
15	25.0	GR	A->B	25.0	25.0	
10	50.0	GR	A->B	50.0	50.0	
15	75.0	GR	A->B	75.0	75.0	
10	100.0	GR	A->B	100.0	100.0	
Press Set to view all Y.1564 Config results.						Summary

Figure 3.11.13-7 Y.1564 Config – Detail Level Table (Color, Test Direction, IR Min, IR Avg)



Y.1564 Results 1  1000Mbps 1000Mbps 14:16:57 					Back
Y.1564 Global Y.1564 Config Y.1564 Perform					
SRV #	IR Max (Mbps)	FL Count	FL Ratio (PPM)	FTD Mii (ms)	
1	5.0	0	0	0.002	Port A
1	10.0	0	0	0.002	
1	25.0	0	0	0.002	
1	50.0	0	0	0.002	
1	75.0	0	0	0.001	
1	100.0	0	0	0.002	
Press Set to view all Y.1564 Config results.					Summary

Figure 3.11.13-8 Y.1564 Config – Detail Level Table (IR Max, FL Count, FL Ratio)

SRV #	Max (ms)	FDV Min (ms)	FDV Avg (ms)	FDV Max (ms)
1.000	0.000	0.000	0.000	0.000
1.000	0.000	0.000	0.000	0.000
1.000	0.000	0.000	0.000	0.000
1.000	0.000	0.000	0.000	0.000
1.000	0.000	0.000	0.000	0.000
1.000	0.000	0.000	0.000	0.000

Press Set to view all Y.1564 Config results.

Figure 3.11.13-9 Y.1564 Config – Detail Level Table (FDV Min, FDV Avg, FDV Max)

To return to the Top Level table view, press the Set key. This instruction is displayed at the bottom of the table when in the Detailed Table view, as shown in Figure 3.11.13-9 above.

Press the **F1 Back** soft-key, to return to the Result Overview display.

Press the **F3 Port A/B** soft-key, to view the results from the other port.

Press the **F4 Summary** soft-key to view the summary statistics tabs and event log.

3.11.14 Y.1564 Perform Results

The Y.1564 Perform results tab displays the results of the Y.1564 Perform test in table form. When the Y.1564 Perform tab is selected (as indicated by the RED highlight on the tab, as shown in Figure 3.11.14-1 below), press the **Down**-arrow key to move the highlight to the main table, as shown in Figure 3.11.14-2 below.

For the Y.1564 Perform test all enabled Services are run simultaneously, there are no sub-tests, and Color Mode is not considered, but metrics are measured independently on each individual Service. Therefore the results table for the Y.1564 Perform test **has only a Detail Level view**, which is similar to the Detail Level view of the Y.1564 Config test, with some additional columns.

The columns in the Y.1564 Perform results table are shown in Figures 3.11.14-1, 3.11.14-2, 3.11.14-3, 3.11.14-4, 3.11.14-5 and 3.11.14-6 below and are described in Table 3.11.14-2 below:

Refer to section 3.11.10 of this document for a detailed description of the metrics per configuration.

Note:

The user should be aware that in certain configurations, the results that are shown are a combination of transmitted Services from one port and received statistics from another port.

Table 3.11.14-1 Multi-Port Results Overview

Configuration	When Viewing Port	Comments
Switch Router Test Direction = LOOP	A B	Services transmitted on A, statistics received on B. Services transmitted on B, statistics received on A.
Single Ended Network Test Direction = LOOP	A B	Services transmitted on A, statistics received on A Services transmitted on B, statistics received on B
End to End Network Test Direction = L _A >R _B Direction = L _B >R _A Direction = R _A >L _B Direction = R _A >L _B	A A B B	Services transmitted L _A , received on R _B Services transmitted L _B , received on R _A Services transmitted R _A , received on L _B Services transmitted R _A , received on L _B All data is viewed on the local unit. The Results soft-key shows local/remote/both to indicate the source and destination of the information being shown.

To view the status and results of the individual Services that were included in the Y.1564 Perform test, use the **Up/Down/Left/Right**-arrow keys to scroll through the table and view the results.

Note:

Individual metrics that caused a FAIL indication will show a RED highlight in the cell for that metric. If any metric fails for an individual service, the entire Y.1564 Perform test will result in a FAIL indication at the Global Verdict level.

Table 3.11.14-2 Y.1564 Perform Results Columns

Column	Description
SRV #	Service number
SRV Name	Service name
Status	Test Status. RUNNING, PENDING, PASS, FAIL, ABORTED
Test Direction	A->B, B->A or LOOP
IR Min (Mbps)	Minimum Information Rate (utilization rate) in Mbps
IR Avg (Mbps)	Average Information Rate (utilization rate) in Mbps
IR Max (Mbps)	Maximum Information Rate (utilization rate) in Mbps
FL Count	Frame Loss count
FL Ratio (PPM)	Frame Loss Ratio in PPM
FTD Min (ms)	Minimum Latency (ms). Estimated for End to End configuration. For the End to End Network Test, ~FTD (approximate FTD) may be shown.
FTD Avg (ms)	Average Latency (ms). Estimated for End to End configuration. For the End to End Network Test, ~FTD (approximate FTD) may be shown.
FTD Max (ms)	Maximum Latency (ms). Estimated for End to End configuration. For the End to End Network Test, ~FTD (approximate FTD) may be shown.
FDV Min (ms)	Minimum Jitter (ms)
FDV Avg (ms)	Average Jitter (ms)
FDV Max (ms)	Maximum Jitter (ms)
AVAIL (%)	Percentage of availability (as defined in MEF)
UN-AVAIL (Sec)	Unavailable seconds (as defined in MEF)
SEQ ERR Count	Count of sequence errors.
SEQ ERR (%)	Percentage of frames received out of sequence.

SRV #	SRV Name	Status	Test Direction	IR Min (Mbps)
1	A-1	RUNNING	A->B	100.0
2	A-2	RUNNING	A->B	100.0
3	A-3	RUNNING	A->B	100.0
4	A-4	RUNNING	A->B	100.0

Figure 3.11.14-1 Y.1564 Perform Tab Highlighted (SRV #, SRV Name, Status, Test Direction, IRM Min Columns)

SRV #	IR Avg (Mbps)	IR Max (Mbps)	FL Count	FL Ratio (PPM)
1	100.0	100.0	0	0
2	100.0	100.0	0	0
3	100.0	100.0	0	0
4	100.0	100.0	0	0

Figure 3.11.14-2 Y.1564 Perform Test - Results Table Highlighted (IRM Max, FL Count, FL Ratio Columns)

SRV #	Ratio (M)	FTD Min (ms)	FTD Avg (ms)	FTD Max (ms)
1	0	0.001	0.001	0.002
2	0	0.001	0.001	0.002
3	0	0.001	0.001	0.002
4	0	0.001	0.001	0.002

Figure 3.11.14-3 Y.1564 Perform Test (FTD Min, FTD Avg, FTD Max Columns)

SRV #	Max (s)	FDV Min (ms)	FDV Avg (ms)	FDV Max (ms)
1	02	0.000	0.000	0.000
2	02	0.000	0.000	0.000
3	02	0.000	0.000	0.000
4	02	0.000	0.000	0.000

Figure 3.11.14-4 Y.1564 Perform Test (FDV Min, FDV Avg, FDV Max Columns)

Y.1564 Results 1 1000Mbps 1000Mbps 14:10:55

Y.1564 Global Y.1564 Config Y.1564 Perform Back

SRV #	AVAIL (%)	UN-AVAIL (Sec)	SEQ ERR Count	SEQ ERR (%)
1	0	0	0	0
2	0	0	0	0
3	0	0	0	0
4	0	0	0	0

Port A

Summary

Figure 3.11.14-5 Y.1564 Perform Test (AVAIL %, UN-AVAIL (Sec), SEQ ERR Columns)

Y.1564 Results 1 1000Mbps 1000Mbps 13:54:57

Y.1564 Global Y.1564 Config Y.1564 Perform Back

SRV #	AVAIL (%)	UN-AVAIL (Sec)	SEQ ERR Count	SEQ ERR (%)
1	0	0	0	0
2	0	0	0	0
3	0	0	0	0
4	0	0	0	0

Port A

Summary

Figure 3.11.14-6 Y.1564 Perform Test (SEQ ERR (%) Column)

To move to another results tab, use the **Up**-arrow key to move the highlight to the Y.1564 Perform tab, as shown in Figure 3.11.14-1. Then use the **Left**-arrow key to move the highlight to another results tab (Y.1564 Global or Y.1564 Config).

Press the **F1 Back** soft-key, to return to the Result Overview display.

Press the **F3 Port A/B** soft-key, to view the results from the other port.

Press the **F4 Summary** soft-key to view the summary statistics tabs and event log.

3.11.15 Y.1564 Reports

To create a report that includes the test settings and results, perform the steps listed below:

When the test has finished, press the **Menu** key. The main menu will be displayed, as shown in Figure 3.11.15-1 below. Use the **Up/Down**-arrow keys to position the highlight over the Test Report item. Press the **Set** key and the **Report Setup** screen will be displayed, as shown in Figure 3.11.15-2

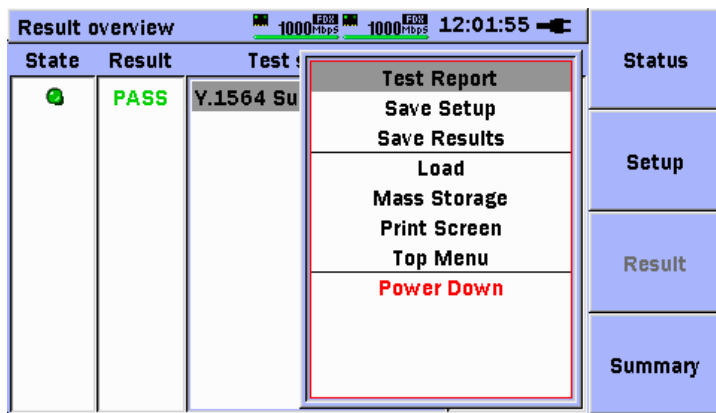

Figure 3.11.15-1 Menu / Test Report Item

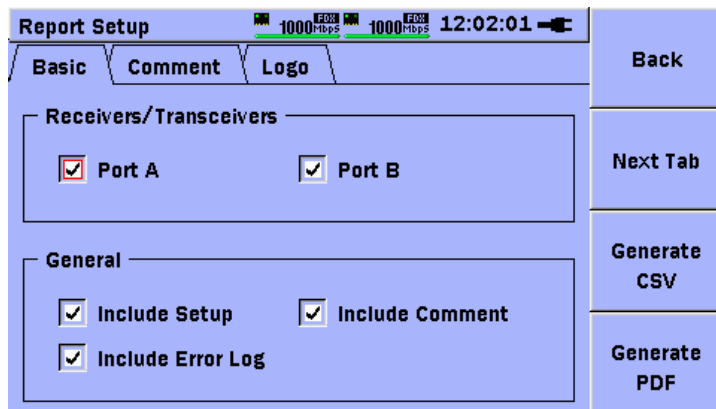

Figure 3.11.15-2 Report Setup Tabs

Select the desired options. Use the **Next Tab (F2)** soft-key to add comments and define a logo image if required.

Press the **Generate CSV (F3)** or **Generate PDF (F4)** soft-key. The **Save PDF Report** screen will be displayed, as shown in Figure 3.11.15-3.

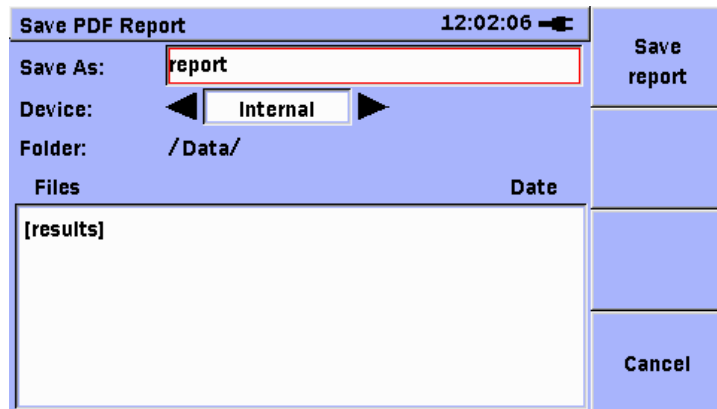

Figure 3.11.15-3 Save PDF Report Screen

With the highlight positioned over the field to the right of the Save As: label, press the **Set** key to display the alpha-numeric editors and change the file name for the report.

Move the highlight over the field to the right of the Device: label. Use the **Left/Right**-arrow keys to select the output device.

Use the **Down**-arrow key to position the highlight on the Files field. Use the **Up/Down**-arrow keys to position the highlight over the desired output folder. Press the **Set** key to open the folder.

When finished, press the **Save (F1)** report soft-key to save the report to the currently selected folder.

A sample of the report is shown below:

Anritsu 2007-11-09 12:02:09

Document Information

Comment

Customer:
Project/Description:
Operator:
Notes:

Result overview

State	Result	Test schedule	dd:hh:mm:ss
OK	PASS	Y.1564 Suite 1	00:00:00:54



2007-11-09 12:02:09

Y.1564 Suite 1 - Result

Y.1564 Global	
Global Verdict	PASS
Y.1564 Config	PASS
Y.1564 Perform	N/A

Y.1564 Config Port A Local					
SRV	CIR	EIR	Policing	CBS	EBS
1 (Service)	PASS	PASS	PASS	PASS	PASS

Y.1564 Config Port B Local					
SRV	CIR	EIR	Policing	CBS	EBS
1 (Service)	PASS	N/A	N/A	N/A	N/A

3.12 Address Wizard

An Address Wizard function is available under Interface Setup (standard and Y.1564) and Destination setup (Generator and Y.1564). The purpose of the Address Wizard is to make the generation of MAC and IP addresses for multiple streams (or Services) and multiple ports easier.

Note:

Many of the descriptions, Tables, and Figures below refer to the setup of **Streams**. The **Stream** terminology is used by standard Interface Setup and the Generator test. See Figure 3.12-6 for an example. When using the Address Wizard function from within a Y.1564 test, the terminology is changed from **Streams** to **Services**, (consistent with the terminology used in the ITU standard). See figure 3.12-6.1 for an example. This is only a terminology difference and does not affect the operation of the Wizard functions as described. All differences in operation when using the Wizard function from within a Y.1564 test are listed in Tables 3.12-5 and 3.12-6 below.

To access the Address Wizard display, while in Interface Setup (standard or Y.1564) or Destination Setup (Generator or Y.1564), move the highlight to the **Address Wizard** button, as shown in Figure 3.12-1 below.

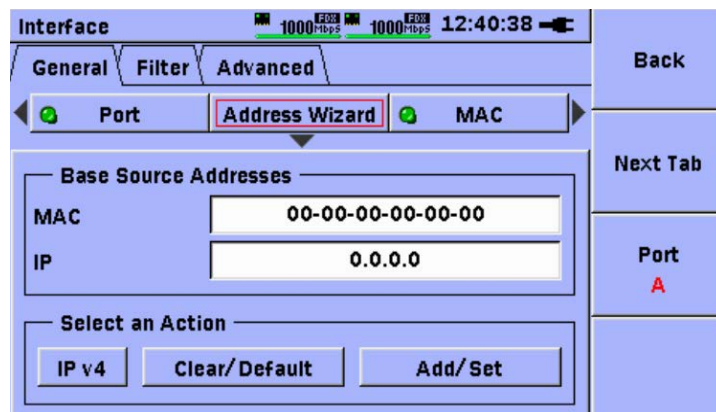

Figure 3.12-1 Interface Setup - Address Wizard Button

The Address Wizard maintains a Base MAC address and a Base IPv4 and IPv6 address.

To set the base MAC address, use the **Up/Down**-arrow keys to position the highlight in the field to the right of the MAC label. Press the **Set** key. The MAC editor shown in Figure 3.12-2 will be displayed. Use the **Up/Down/Left/Right**-arrow keys to input the desired MAC address. Press the **Set** key to complete the editing session.

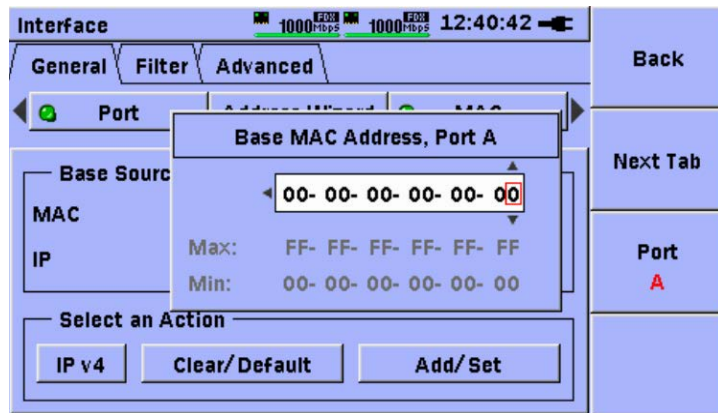

Figure 3.12-2 Interface Setup - Address Wizard Button (Base MAC Address Editor)

To set the base IP address, use the **Up/Down**-arrow keys to position the highlight in the field to the right of the IP label. Press the **Set** key. The IP editor shown in Figure 3.12-3 will be displayed. Use the **Up/Down/Left/Right**-arrow keys to input the desired IP address. Press the **Set** key to complete the editing session.

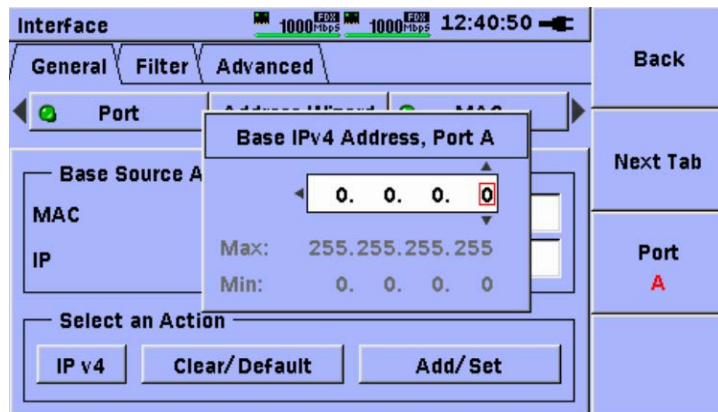

Figure 3.12-3 Interface Setup - Address Wizard Button (Base IPv4 Address Editor)

Note:

If the IPv4/IPv6 button (located at the bottom left corner of the display) shows IPv6, then the IP editor shown in Figure 3.15-4 will be displayed.

To change the Base IP address from IPv4 to IPv6, use the **Up/Down/Left/Right**-arrow keys to position the highlight over the IPv4/IPv6 button located in the bottom left corner of the display, as shown in Figure 3.12-4. Press the **Set** key until the label on the button displays the desired setting. Note the input field for the Base IP address will change as the state of the button changes.



Figure 3.12-4 Interface Setup - Address Wizard Button (Base IPv6 Address Editor)

To use the Clear/Default functions, use the **Up/Down/Left/Right**-arrow keys to move the highlight over the Clear/Default button, as shown in Figure 3.12-5. Press the **Set** key.

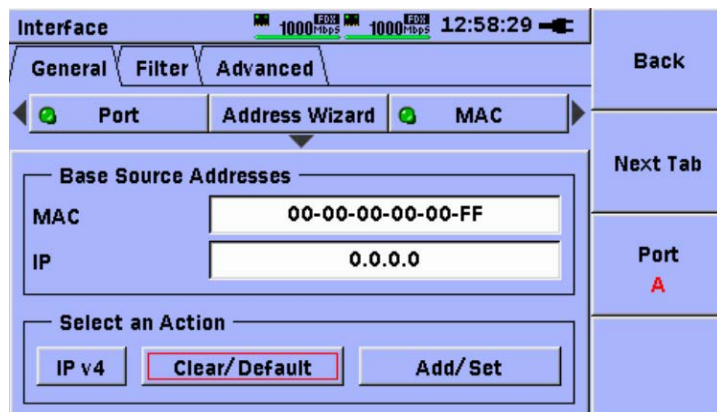

Figure 3.12-5 Interface Setup - Address Wizard Button (Clear/Default Button Highlighted)

The Clear/Default action list shown in Figure 3.12-6 will be displayed. Use the **Up/Down**-arrow keys to move the highlight over the desired action. Press the **Set** key to complete the selection.

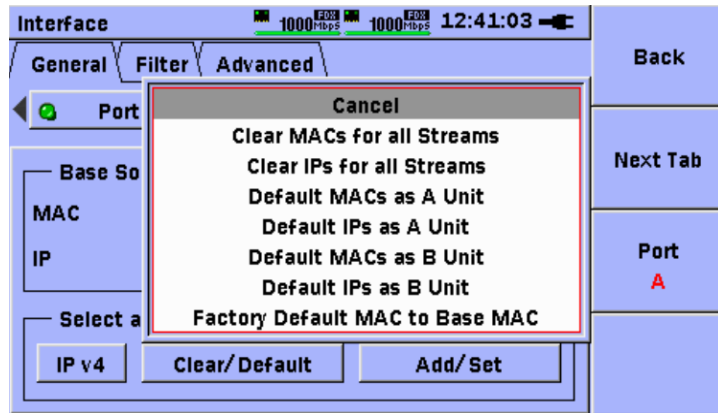

Figure 3.12-6 Interface Setup - Address Wizard Button (Clear/Default Action List)

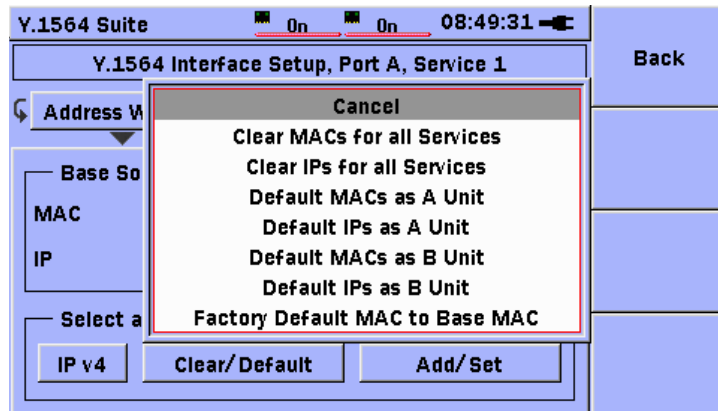

Figure 3.12-7 Y.1564 Suite - Address Wizard Button (Clear/Default Action List)

The following actions are available:

Table 3.12-1 Clear/Default Actions

Action	Description
Cancel	Cancel the selection and return to the previous screen with no action taken.
Clear MACs for all Streams	Set the MAC addresses for all streams to 00:00:00:00:00:00
Clear IPs for all Streams	Set the IP addresses for all streams to 0.0.0.0 (or IPv6 equivalent).
Default MACs as A unit	Set each MAC address to a sequential default number: 00:00:00:00:00:11 – 00:00:00:00:00:18 (port A) 00:00:00:00:00:21 – 00:00:00:00:00:28 (port B)
Default IPs as A unit	Set each IP address to a sequential default number: 0.0.0.11 – 0.0.0.18 (port A) 0.0.0.21 – 0.0.0.28 (port B)
Default MACs as B unit	Set each MAC address to a sequential default number: 00:00:00:00:00:21 – 00:00:00:00:00:28 (port A) 00:00:00:00:00:11 – 00:00:00:00:00:18 (port B)
Default IPs as B unit	Set each IP address to a sequential default number: 0.0.0.21 – 0.0.0.28 (port A) 0.0.0.11 – 0.0.0.18 (port B)
Factory Default MAC to Base MAC	Load the factory default MAC into the Base MAC field.

A pop-up dialog shows the results of the action to the user. See Figure 3.12-9 for an example. With the highlight over the **OK** item, press the **Set** key to commit the changes.

Note:

After the selected operation is executed there is still an opportunity to cancel the operation, as shown in Figure 3.12-9. Use the **Up/Down** arrow keys to move the highlight over the **Cancel** item, press the **Set** key to cancel the operation.

To use the Add/Set functions, use the **Up/Down/Left/Right** arrow keys to move the highlight over the **Add/Set** button, as shown in Figure 3.12-7. Press the **Set** key.

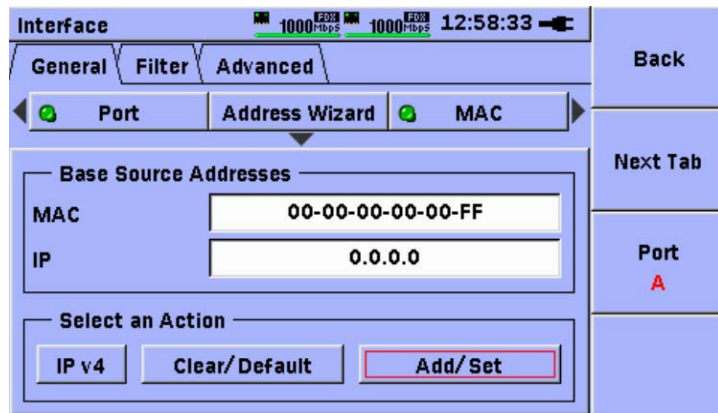

Figure 3.12-8 Interface Setup - Address Wizard Button (Add/Set Button Highlighted)

The Add/Set action list shown in Figure 3.12-8 will be displayed. Use the **Up/Down**-arrow keys to move the highlight over the desired action. Press the **Set** key to complete the selection.

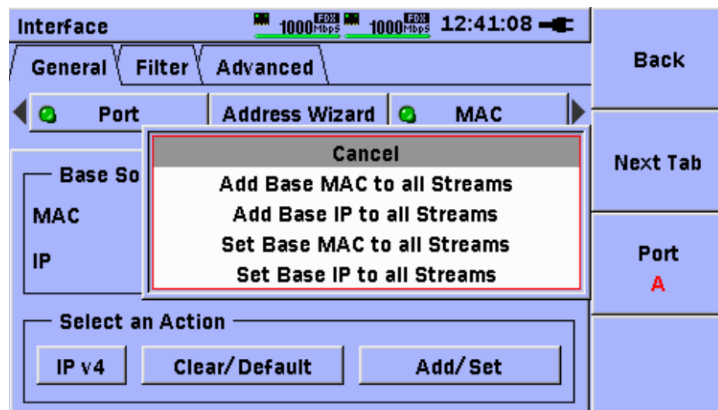

Figure 3.12-9 Interface Setup - Address Wizard Button (Add/Set Button Action List)

The following actions are available:

Table 3.12-2 Add/Set Actions

Action	Description
Cancel	Cancel the selection and return to the previous screen with no action taken.
Add Base MAC to all Streams	Add the Base MAC address to the existing MAC address for all streams.
Add Base IP to all Streams	Add the Base IP address to the existing IP address for all streams.
Set Base MAC to all Streams	Set the Base MAC address as the MAC address for all streams.
Set Base IP to all Streams	Set the Base IP address as the IP address for all streams.

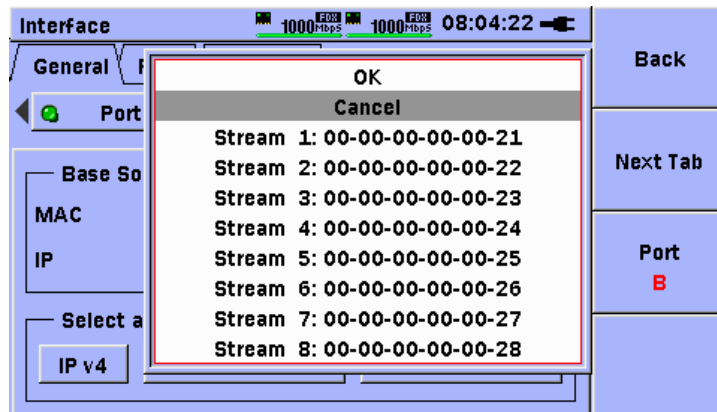

Figure 3.12-10 Interface Setup - Address Wizard Button (Example of Feedback Dialog from Selected Action)

Note:

If an addition operation results in a value that is greater than what is allowed or the octet of an address, the maximum value 0xFF or 255 will be used as a limit.

The Address Wizard feature is also available in the Generator test setup function, as shown in Figure 3.12-11 below.

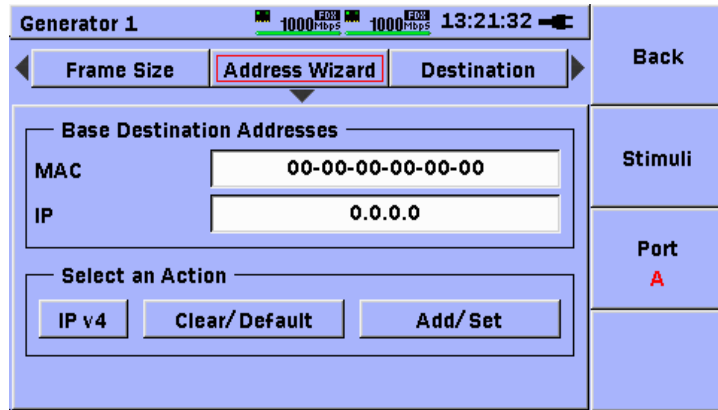

Figure 3.12-11 Generator Setup - Address Wizard Button

If used in the Generator function, the following differences (from the function inside Interface Setup) should be noted:

Table 3.12-3 Additional Clear/Default Actions for Generator

Clear/Default Actions	
Action	Description
Default MACs as A unit	Set each MAC address to a sequential default number: 00:00:00:00:00:21 – 00:00:00:00:00:28 (port A) 00:00:00:00:00:11 – 00:00:00:00:00:18 (port B)
Default IPs as A unit	Set each IP address to a sequential default number: 0.0.0.21 – 0.0.0.28 (port A) 0.0.0.11 – 0.0.0.18 (port B)
Default MACs as B unit	Set each MAC address to a sequential default number: 00:00:00:00:00:11 – 00:00:00:00:00:18 (port A) 00:00:00:00:00:21 – 00:00:00:00:00:28 (port B)
Default IPs as B unit	Set each IP address to a sequential default number: 0.0.0.11 – 0.0.0.18 (port A) 0.0.0.21 – 0.0.0.28 (port B)

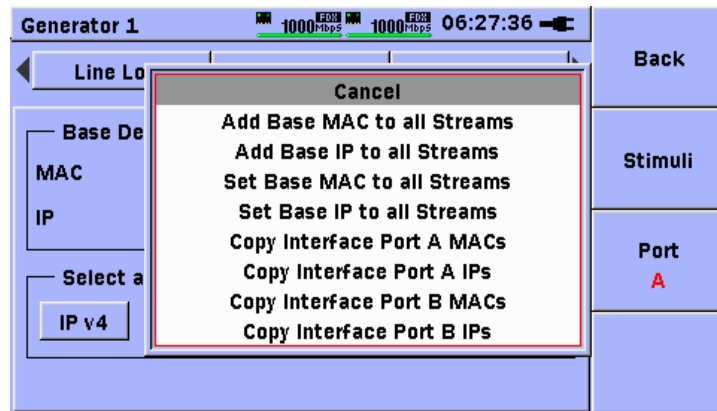

Figure 3.12-12 Generator Setup – Add/Set Actions

Table 3.12-4 Additional Add/Set Actions for Generator

Add/Set Actions	
Action	Description
Copy Interface Port A MACs	Copy the Source MAC addresses from all streams of Interface Setup-Port A, to the Destination MAC addresses of the corresponding streams of the currently selected port.
Copy Interface Port A IPs	Copy the Source IP addresses from all streams of Interface Setup-Port A, to the Destination IP addresses of the corresponding streams of the currently selected port.
Copy Interface Port B MACs	Copy the Source MAC addresses from all streams of Interface Setup-Port B, to the Destination MAC addresses of the corresponding streams of the currently selected port.
Copy Interface Port B IPs	Copy the Source IP addresses from all streams of Interface Setup-Port B, to the Destination IP addresses of the corresponding streams of the currently selected port.

Note:

When the Address Wizard function is used from within the Y.1564 Suite application, the range of addresses is increased to accommodate thirty-two (32) Services.

When used in the Y.1564 Source Address setup function, the following values will be set:

Table 3.12-5 Y.1564 Address Ranges

Action	Description
Default MACs as A unit	Set each MAC address to a sequential default number: 00:00:00:00:01:01 – 00:00:00:00:01:20 (port A) 00:00:00:00:02:01 – 00:00:00:00:02:20 (port B)
Default IPs as A unit	Set each IP address to a sequential default number: 0.0.0.101 – 0.0.0.132 (port A) 0.0.0.201 – 0.0.0.232 (port B)
Default MACs as B unit	Set each MAC address to a sequential default number: 00:00:00:00:02:01 – 00:00:00:00:02:20 (port A) 00:00:00:00:01:01 – 00:00:00:00:01:20 (port B)
Default IPs as B unit	Set each IP address to a sequential default number: 0.0.0.201 – 0.0.0.232 (port A) 0.0.0.101 – 0.0.0.132 (port B)

When used in the Y.1564 Destination Address setup function, the following values will be set:

Table 3.12-6 Y.1564 Address Ranges

Action	Description
Default MACs as A unit	Set each MAC address to a sequential default number: 00:00:00:00:02:01 – 00:00:00:00:02:20 (port A) 00:00:00:00:01:01 – 00:00:00:00:01:20 (port B)
Default IPs as A unit	Set each IP address to a sequential default number: 0.0.0.201 – 0.0.0.232 (port A) 0.0.0.101 – 0.0.0.132 (port B)
Default MACs as B unit	Set each MAC address to a sequential default number: 00:00:00:00:01:01 – 00:00:00:00:01:20 (port A) 00:00:00:00:02:01 – 00:00:00:00:02:20 (port B)
Default IPs as B unit	Set each IP address to a sequential default number: 0.0.0.101 – 0.0.0.132 (port A) 0.0.0.201 – 0.0.0.232 (port B)

3.13 OAM Loopback Application

The Ethernet application supports the 802.3ah protocol (point-to-point only) through the OAM Loopback application for the following functions:

- Discover the OAM Loopback device upon request (soft-key press)
- Command an OAM device to enter or exit loopback mode (at run-time)

To add an OAM Loopback test instance to the Test Automator list, highlight the [+] Add new test field and press the **Set** key. Use the **Up/Down** arrow keys to highlight the OAM Loopback line and press the **Set** key.

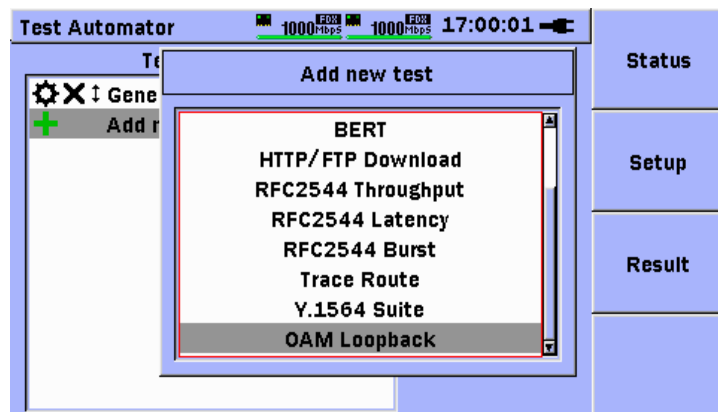

Figure 3.13-1 Add new test – OAM Loopback

Note:

The OAM Loopback test instances can be setup to “bracket” other tests such as RFC or Y.1564 that require loopback services from the remote device. The first instance of OAM Loopback can send the command to Enter loopback mode. The second instance can send the command to Exit loopback mode when testing is finished. An example of this configuration is shown in Figure 3.13-2

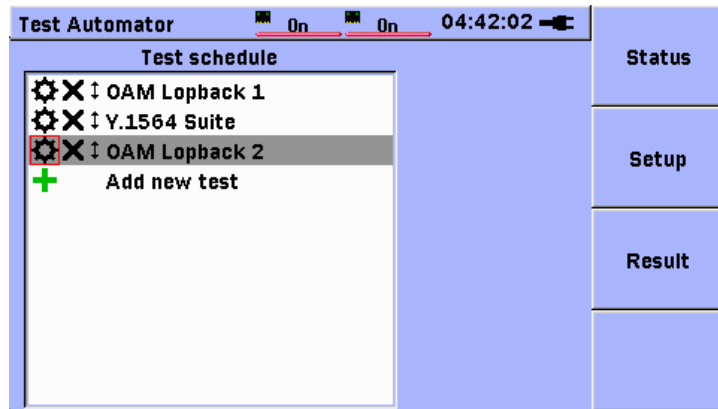

Figure 3.13-2 OAM Loopback Tests Around a Y.1564 Test

When an instance of the OAM Loopback test is added to the Test Automator, pressing the **Set** key will cause the following display to be shown:

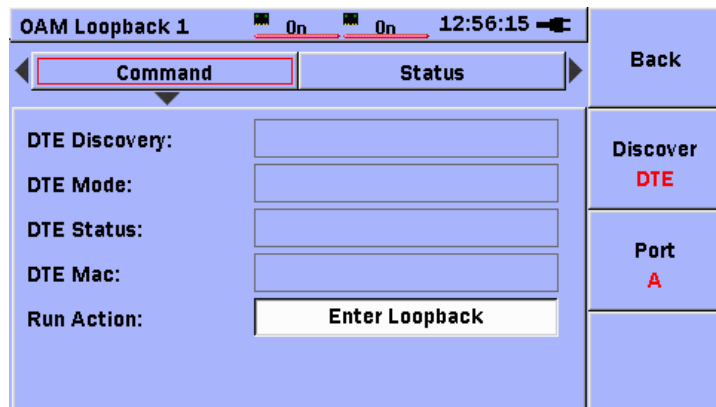

Figure 3.13-3 OAM Loopback Command Screen

OAM Loopback Setup

The OAM Loopback application has a setup mode and a run-time mode. While in the setup mode it is possible to establish a connection with the remote DTE and obtain basic status information from the remote DTE.

Press the **Back (F1)** soft-key to return to the Test Automator (list) screen.

Press the **Discover DTE (F2)** soft-key to reset the OAM protocol state machine and begin the OAM discovery process. The local unit will send an Information OAMPDU with a Local Information TLV. The local unit will wait for an Information OAMPDU from the remote DTE or a timeout. If the local unit receives an Information OAMPDU from the remote DTE, the MAC address of the remote DTE will be displayed and the status will change to show the remote units capabilities. The following information from the remote DTE will be displayed:

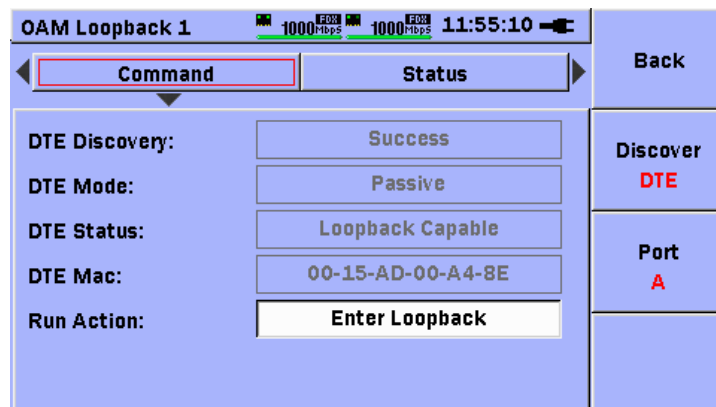

Figure 3.13-4 Command Screen after Discovery

DTE Mode: Passive or Active

DTE Status: Loopback capable or not

DTE MAC: The unicast MAC address of the remote DTE

Press the **F3 Port A/B** soft-key to change ports.

Use the **Up/Down** arrow keys to position the highlight in the field to the right of the Run Action: label. Press the **Set** key to view the Run Action list, as shown in Figure 3.13-5 below.

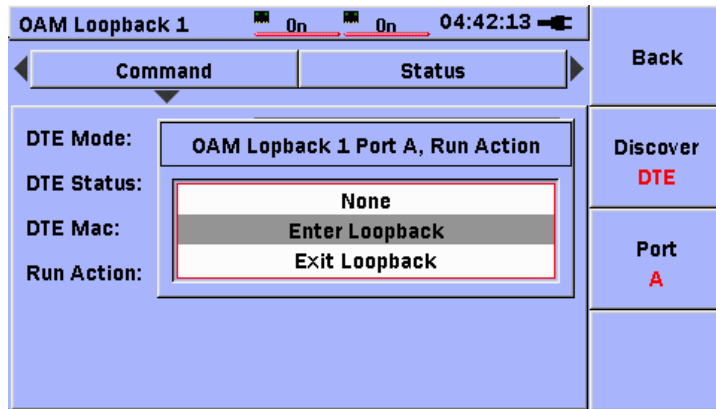

Figure 3.13-5 OAM Loopback Run Action List

The selected Run Action will be executed when the OAM Loopback test instance is run from the Test Automator schedule.

None - No run-time action is performed on this port. This setting can also be used to temporarily disable the run action without removing the test instance from the Test Automator schedule.

Enter Loopback - the test instance will command the remote DTE to enter loopback mode.

Exit Loopback - the test instance will command the remote DTE to exit loopback mode.

Status Button

Use the **Up/Down/Left/Right**-arrow keys to move the highlight to the Status button. If the discovery step was successfully performed, the following (static) information will be displayed:

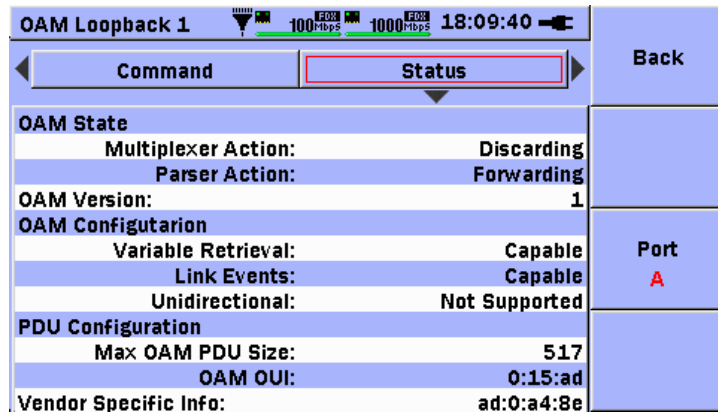

Figure 3.13-6 Remote DTE Status Screen

Table 3.13-1 OAM State and Configuration Information

Field	Description
OAM State	
Multiplexer Action	Device is forwarding non-OAMPDUs to the lower sub-layer Device is discarding non-OAMPDUs
Parser Action	Device is forwarding non-OAMPDUs to higher sub-layer Device is looping back non-OAMPDUs to the lower sub-layer Device is discarding non-OAMPDUs
OAM Version	Protocol version supported by the DTE
OAM Configuration	
Variable Retrieval	DTE supports sending Variable Response OAMPDUs. DTE does not support sending Variable Response OAMPDUs.
Link Events	DTE supports interpreting Link Events. DTE does not support interpreting Link Events.
Unidirectional	DTE is capable of sending OAMPDUs when the receive path is non-operational. DTE is not capable of sending OAMPDUs when the receive path is non-operational.
PDU Configuration	
Max OAMPDU Size	The largest OAMPDU, in octets, supported by the DTE. This value is compared to the remote's Maximum PDU Size and the smaller of the two is used.
OAM OUI	24-bit Organizationally Unique Identifier of the vendor.
Vendor Specific Info	32-bit identifier that may be used to differentiate a vendor's product models/versions.

OAM Loopback Results

The results screen for the OAM Loopback test instance indicates the status of the requested command execution:

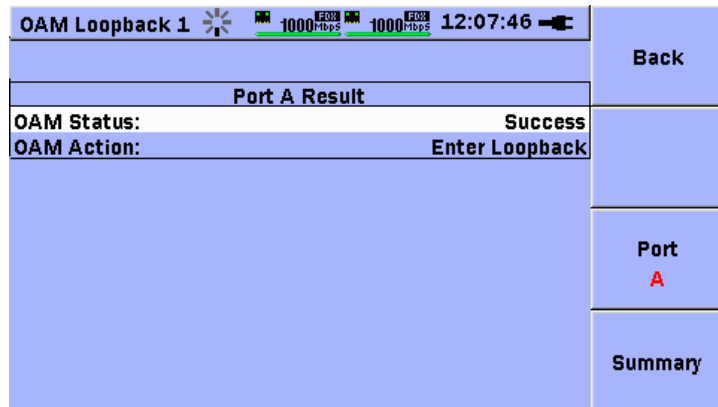

Figure 3.13-7 OAM Loopback Test – Result Screen

If the command succeeds, the LED status for the test will be GREEN (●).
 If the command fails, the LED status for the test will be RED (●).

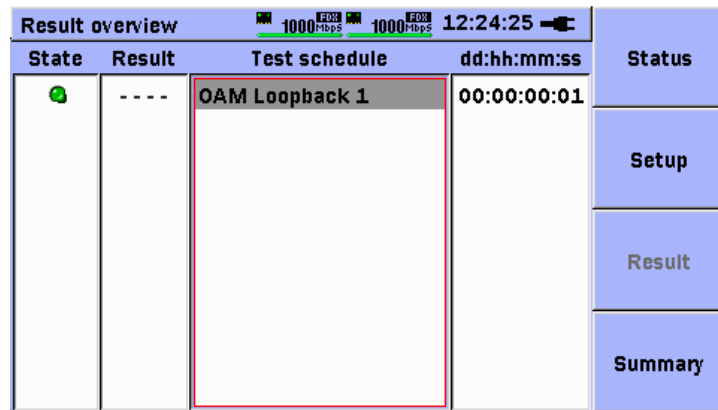

Figure 3.13-8 OAM Loopback Test – Successful Execution

Note:

When the OAM Loopback test instance executes, the Run Action will be performed and the test instance will exit. If the Run Action was Enter Loopback, a background service will be activated to keep the OAM session alive by sending keep-alive protocol frames as required by the standard.

Supported Models

The following models have been tested with the MU909060A and are supported:

Manufacturer	Model
Overture Networks	ISG 24
Transition Networks	SBFFG4040-105

Note:

All OAM Loopback devices are required to maintain an 802.3ah protocol session while in loopback mode. Due to this requirement it is possible that the device may not loopback all frames that are transmitted to it, resulting in some frame loss in the test results. It is also possible that some frames will continue to be forwarded from one port to the other while the device is in loopback mode.

Chapter 4 Application Reflector

The Reflector application is used to reflect incoming traffic, while giving the user a simultaneous view of the current statistics.

4.1	Status.....	4-2
4.2	Setup Interface.....	4-3
	4.2.1 Port.....	4-4
	4.2.2 Reflector.....	4-6
4.3	Result.....	4-7
	4.3.1 Reflector.....	4-7
	4.3.2 Event Log and Statistics.....	4-8

4.1 Status

The Status screen is the first screen that is displayed when starting the Reflector application.

It gives an overview of the current hardware and Ethernet status. For details about the Status screen tabs, refer to section 2.5.

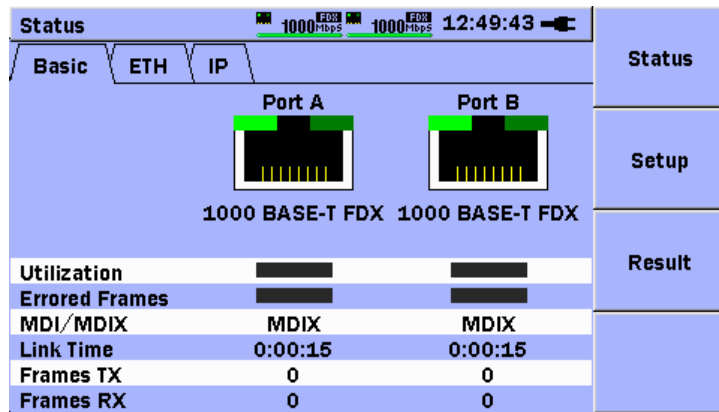

Figure 4.1-1 Status Window, Basic tab

The three buttons on the right are controlled by the **F1** to **F3** soft keys.

Status	F1	Displays Status screen See Figure 4.1-1.
Setup Interface	F2	Activates Setup Interface screen which is used to setup ports and the Reflector test See section 4.2.
Result	F3	Shows test results for both ports See section 4.3

These are the main soft keys for the Reflector application and they are shared by all screens.

4.2 Setup Interface

The Setup Interface screen consists of two panels:

- Port Panel (Figure 4.2.1-1)
- Reflector Panel (Figure 4.2.2-1)

When entering this screen, a new **Port** button (**F4**) is added at the bottom of the soft key menu.

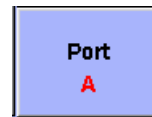

Figure 4.2-1 Port Button (Port A)

This button displays the currently active port and also allows the user to switch between Port A and Port B.

4.2.1 Port

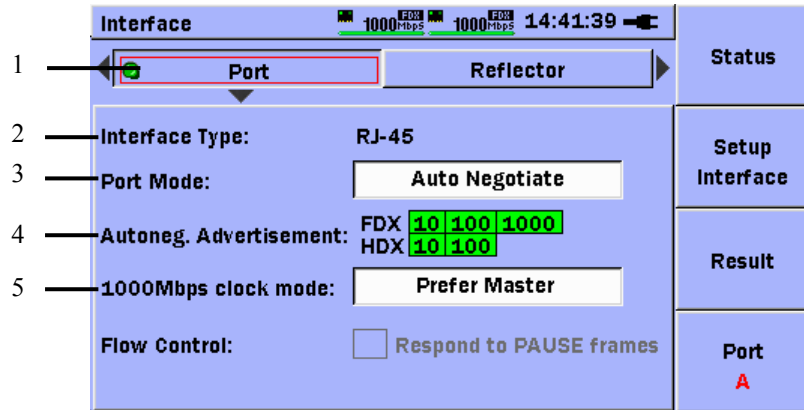

Figure 4.2.1-1 Setup Interface, Port – Auto Negotiate

The arrow keys and the **Set** key are used to navigate and select settings. See section 1.1.2.

The above figure shows the port setup screen when **Auto Negotiate** is selected:

When **Auto Negotiate** selected at **Port Mode** (Figure 4.2.1-1):

- [1] This switches the port on and off.
- [2] This indicates the current interface type for the selected port (RJ-45 or SFP).
- [3] This selects the mode for the linking port. There are two modes: **Auto Negotiate** (Figure 4.2.1-1), or **Forced** (Figure 4.2.1-2).
- [4] This selects the link speed modes broadcast by the Network Master.
- [5] This selects which link partner is the master and which is the slave during auto negotiation (1000 Mbps mode only).

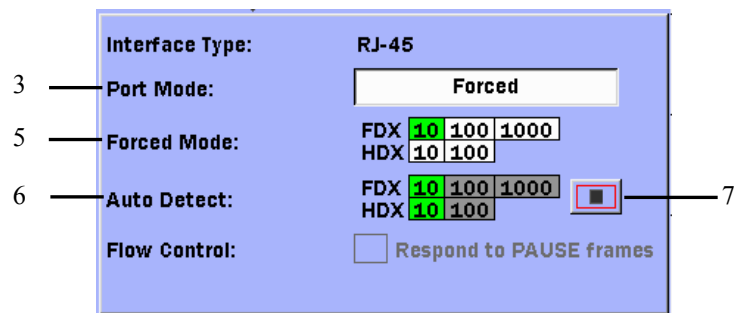

Figure 4.2.1-2 Setup Interface, Port – Forced

When **Forced** selected at **Port Mode** (Figure 4.2.1-2):

- [5] This selects the speed mode used by the Network Master.
- [6] This scans and displays supported speeds.
- [7] This is the Auto Detect (above item 6) start and stop button.

4.2.2 Reflector

The Reflector screen is used for making specific settings for the Reflector test.

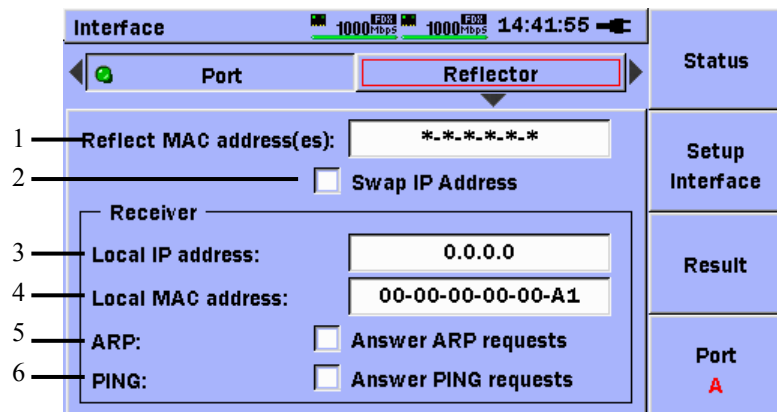

Figure 4.2.2-1 Setup Interface (Reflector)

- [1] This is the mask setting that specifies the range of reflected MAC addresses, excluding multicast and broadcast. See the following example below for clarification.

..*-FC-0A-01	Example 1: Reflects all MAC addresses with the last three bytes of FC-0A-01
A0-52-43-FC-0A-01	Example 2: Reflects only specified MAC address A0-52-43-FC-0A-01

- [2] This enables/disables IP address swapping for reflected data packages.
- [3] This sets the local IP address.
- [4] This sets the local MAC address.
- [5] This enables/disables answers to ARP requests.
- [6] This enables/disables answers to ping requests. All ping requests are reflected regardless of this setting.

4.3 Result

The Result screen is blank when no test has been run, but starts displaying results as soon as the test is started by pressing the **Start** key (section 1.1.2). To disable the Reflector application, press the **Start** key again.

After starting the test, the Network Master switches automatically to the Result screen if it is not already displayed.

Notes:

- The Network Master only reflects traffic while a test is running.
- An icon  on the top bar indicates that the Reflector application is enabled.

4.3.1 Reflector

When the Result screen is opened, the default screen is the Reflector screen (Figure 4.3.1-1) and displays an overview of current traffic conditions. This screen is refreshed every 1 s until the Reflector test is stopped.

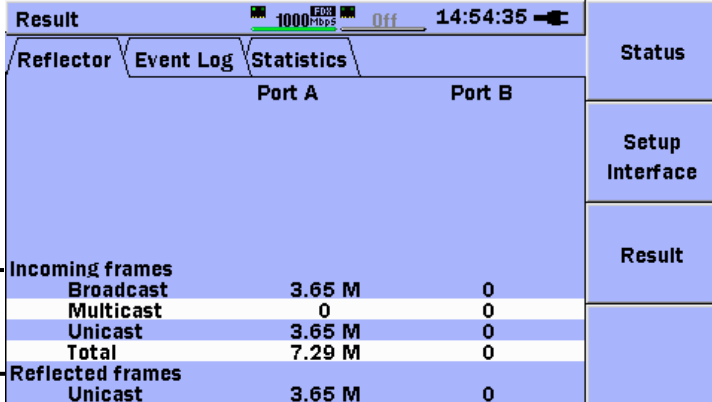

Result		1000 Mbps Off		14:54:35	
Reflector		Event Log		Statistics	
		Port A	Port B	Status	Setup Interface
1	Incoming frames				Result
	Broadcast	3.65 M	0		
	Multicast	0	0		
	Unicast	3.65 M	0		
	Total	7.29 M	0		
2	Reflected frames				
	Unicast	3.65 M	0		

Figure 4.3.1-1 Result overview Screen

- [1] This is the overview of incoming traffic. Use the **Statistics** tab for more detailed information.
- [2] This is the overview of outgoing (reflected) traffic. The Reflector only reflects unicast traffic.

4.3.2 Event Log and Statistics

The **Event Log** and **Statistics** tabs are explained in section 2.6.3 and 2.6.4. As mentioned above, the **Statistics** tab gives a detailed view of incoming traffic. The **Reflector** tab gives an overview of received and reflected traffic.

Chapter 5 *Pass Through*

The Pass Through application passes the incoming traffic from one port to the other, while simultaneously giving the user a view of the current statistics.

5.1	Status.....	5-2
5.2	Setup Interface.....	5-3
	5.2.1 Port.....	5-3
5.3	Testing.....	5-5
5.4	Result.....	5-6
	5.4.1 Pass Through.....	5-6
	5.4.2 Event Log.....	5-7
	5.4.3 Statistics.....	5-7

5.1 Status

The Status screen is the first screen that is displayed when starting the Pass Through application.

It gives an overview of the current hardware, Ethernet and SFP (Optional) status. For details about the Status screen tabs, refer to section 2.5.

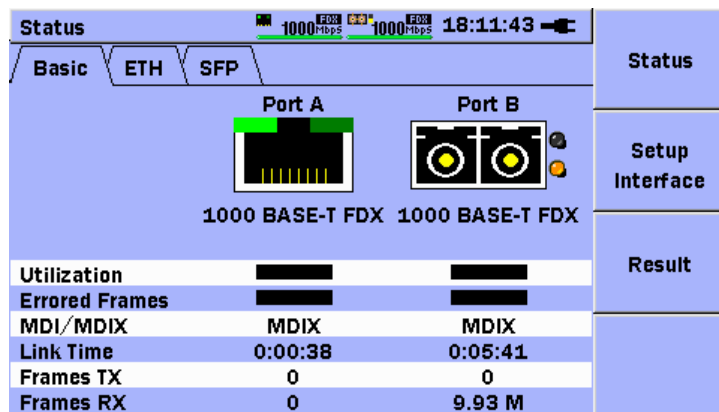

Figure 5.1-1 Status Window, Basic tab

The three buttons on the right are controlled by the **F1** to **F3** soft keys.

Status	F1	Displays Status screen See Figure 5.1-1.
Setup Interface	F2	Activates Setup Interface screen which is used to setup the ports See section 5.2.
Result	F3	Shows test results for both ports See section 5.4

These are the main soft keys for the Pass Through application and they are shared by all screens.

5.2 Setup Interface

The Setup Interface screen consists of one panel:

- Port Panel (Figure 5.2.1-1)

When entering this screen, a new **Port** button (**F4**) is added at the bottom of the soft key menu.

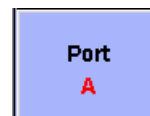

Figure 5.2-1 Port Button, Port A

This button displays the currently active port and also allows the user to switch between Port A and Port B.

5.2.1 Port

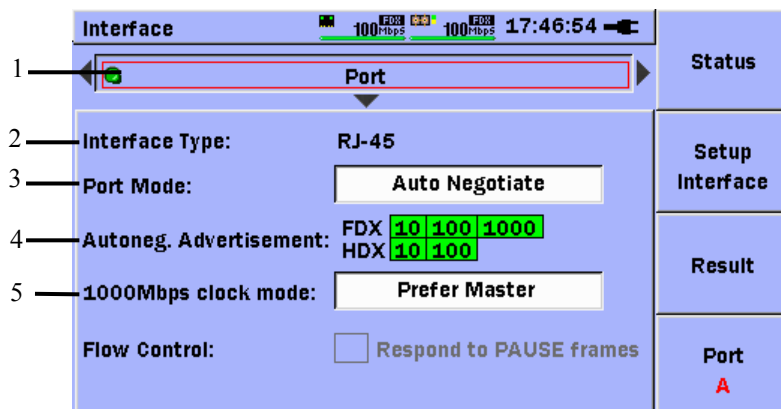

Figure 5.2.1-1 Setup Interface, Port – Auto Negotiate

The **Up/Down** arrow keys and the **Set** key are for navigate and select settings. See Section 1.2.2 “Panel Keys”.

When **Auto Negotiate** selected at **Port Mode** (Figure 5.2.1-1):

- [1] This switches the port on and off.
- [2] This indicates the current interface type for the selected port (RJ-45 or SFP).
- [3] This selects the mode for the linking port. There are two modes: **Auto Negotiate** (Figure 5.2.1-1), or **Forced** (Figure 5.2.1-2).
- [4] This selects the link speed modes advertised by the Network Master.
- [5] This selects which link partner is the master and which is the slave during auto negotiation (1000 Mbps mode only).

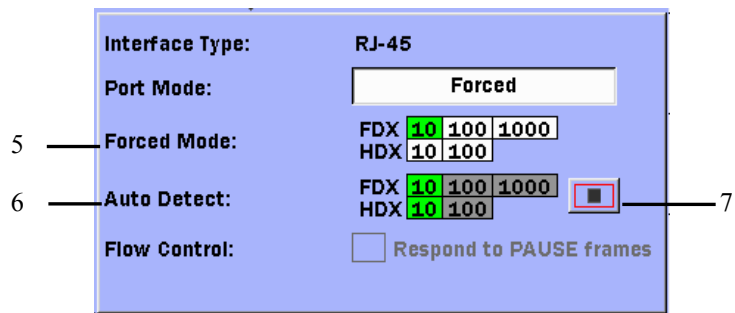

Figure 5.2.1-2 Setup Interface, Port – Forced

When **Forced** selected at **Port Mode** (Figure 5.2.1-2):

- [5] This selects the speed mode used by the Network Master.
- [6] This displays the **Auto Detect** result.
- [7] This is the **Auto Detect** start and stop button.

5.3 Testing

To enable the pass through mode press the **Start** key. To disable the pass through mode, press the **Start** key again.

Note:

The Network Master will only pass frames while a test is running and port speed and duplex match, indicated by this  icon on the top bar.

If during testing link is lost or speed or duplex no longer matches, pass through will be disabled. Pass through will be enabled when link is reestablished and speed and duplex match.

5.4 Result

The Result screen is blank when no test has been run, but starts displaying results as soon as the test is started. After starting the test, the Network Master automatically switches to the **Result overview** screen if it is not already displayed.

5.4.1 Pass Through

When the Result screen is opened, the default tab is **Pass Through** (Figure 5.4.1-1). This tab displays an overview of current traffic conditions and is refreshed every one second until the test is stopped.

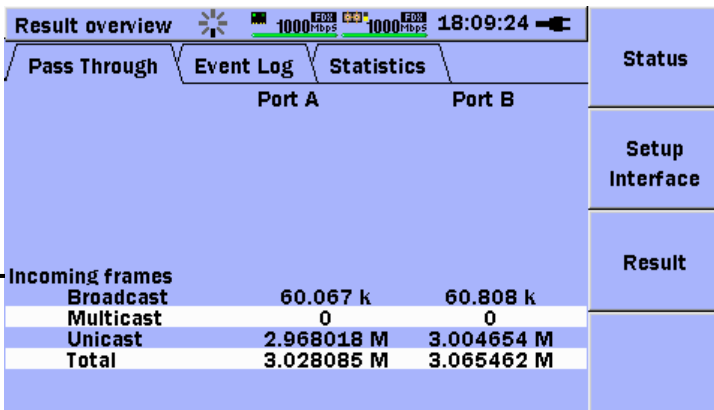

The screenshot shows a software interface with a top status bar containing 'Result overview', a star icon, two '1000Mbps' speed indicators, and a clock showing '18:09:24'. Below the status bar are three tabs: 'Pass Through' (selected), 'Event Log', and 'Statistics'. The main area is divided into two columns, 'Port A' and 'Port B'. On the right side, there are three vertically stacked buttons: 'Status', 'Setup Interface', and 'Result'. A table of traffic statistics is displayed in the main area, with a callout '1' pointing to the 'Incoming frames' row.

	Port A	Port B
Incoming frames	60.067 k	60.808 k
Broadcast	0	0
Multicast	0	0
Unicast	2.968018 M	3.004654 M
Total	3.028085 M	3.065462 M

Figure 5.4.1-1 Result Screen

- [1] This is the overview of incoming traffic. Use the **Statistics** tab for more detailed information.

5.4.2 Event Log

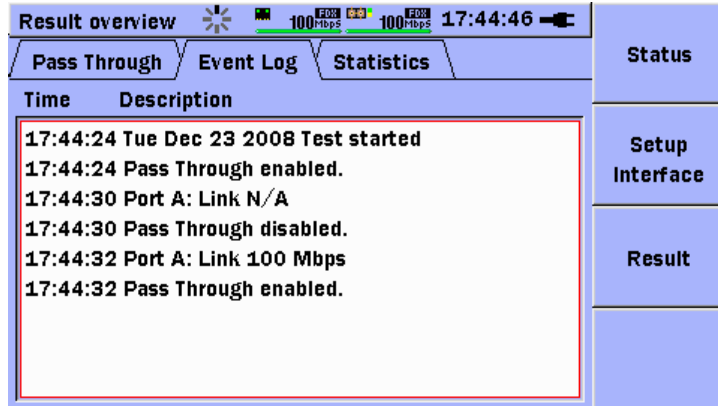

Result overview		Status
Pass Through	Event Log	Statistics
Time	Description	
17:44:24 Tue Dec 23 2008	Test started	Setup Interface
17:44:24	Pass Through enabled.	
17:44:30	Port A: Link N/A	
17:44:30	Pass Through disabled.	Result
17:44:32	Port A: Link 100 Mbps	
17:44:32	Pass Through enabled.	

Figure 5.4.2-1 Event Log

As described in section 5.3 pass through can be disabled/enabled if certain conditions are met. This will be indicated in the **Event Log** with the lines **Pass through disabled** or **Pass through enabled**, see figure 5.4.2-1.

The **Event Log** tab is explained more in depth in section 2.6.3.

5.4.3 Statistics

The **Statistics** tab is explained in 2.6.4.

Chapter 6 Updating Firmware

The application software is updated by uploading the latest Anritsu firmware. The firmware file extension is BBM.

6.1	Updating Firmware	6-2
-----	-------------------------	-----

6.1 Updating Firmware

Use the following procedure to update the firmware.

CAUTION

Always connect the AC Charger/Adapter to the instrument before updating the firmware.

1. Copy the BBM file released by Anritsu to a USB flash drive (version 1.1 or later).
2. Plug the USB flash drive into the USB (Type A) port on the instrument.
3. Hold down the **F1** key while powering up the instrument (press the **Menu/Power** key).

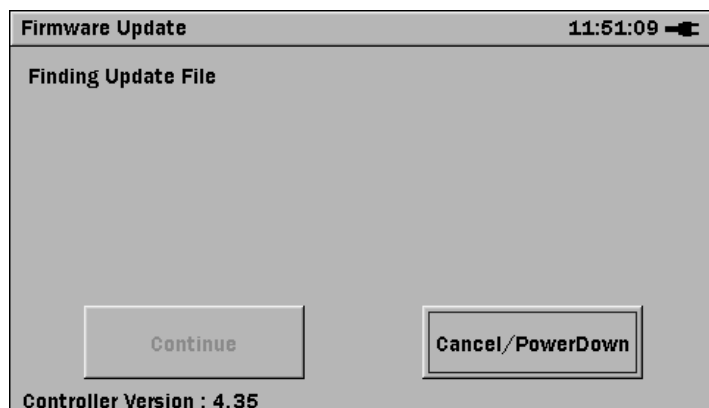

Figure 6.1-1 First Firmware Update Screen

4. Release the **Menu/Power** key when the Anritsu splash screen appears, but continue pressing the **F1** key until the first **Firmware Update** screen is displayed (Figure 6.1-1).

Note

If there is more than one BBM file saved on the USB flash drive, the **Choose Update File** dialog is displayed in front of the first **Firmware Update** screen. Select (highlight) the correct BBM file and press the **Set** key to continue.

5. The **Finding Update File** text changes to **Extracting Update File**. When the update file is fully extracted, the **Installing New Firmware** screen is displayed (Figure 6.1-2).

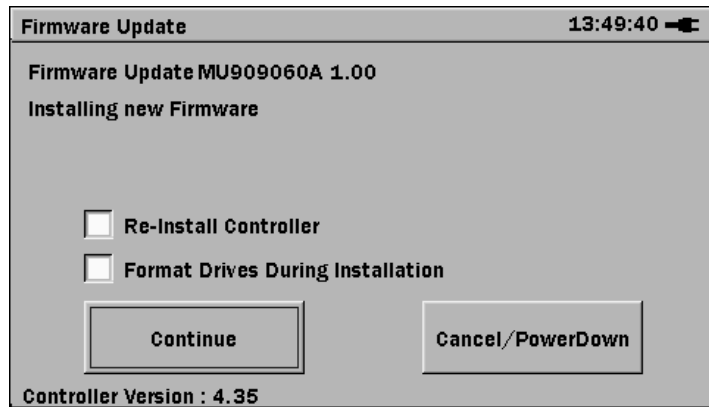

Figure 6.1-2 Installing New Firmware Screen

If desired the controller can be re-installed by selecting the **Re-Install Controller**. This is only relevant when the version of the currently installed controller and the version in the BBM update are the same. If the **Controller version** in the BBM update file is newer than the version currently installed, the new controller firmware is installed automatically independently of this checkbox.

If wanted the internal user drives can be reformatted during installation by selecting the **Format Drives During Installation** checkbox.

6. Press the **Set** key to continue. The first **Installing Update** screen is displayed (Figure 6.1-3).

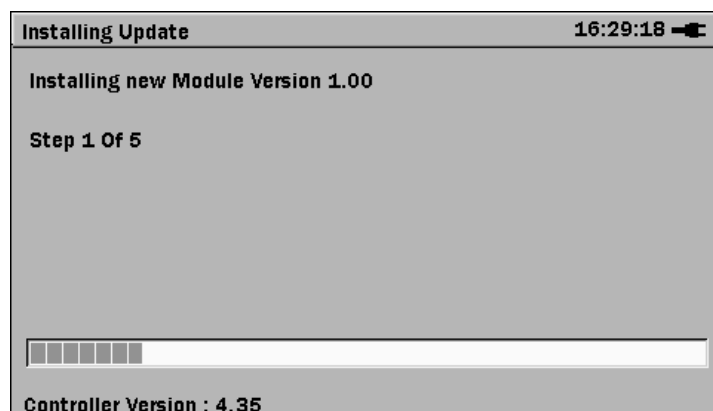

Figure 6.1-3 First Installing Update screen

7. The installation is complete when the Finish button is displayed (Figure 6.1-4). Press the **Set** key to finish the firmware version upgrade.

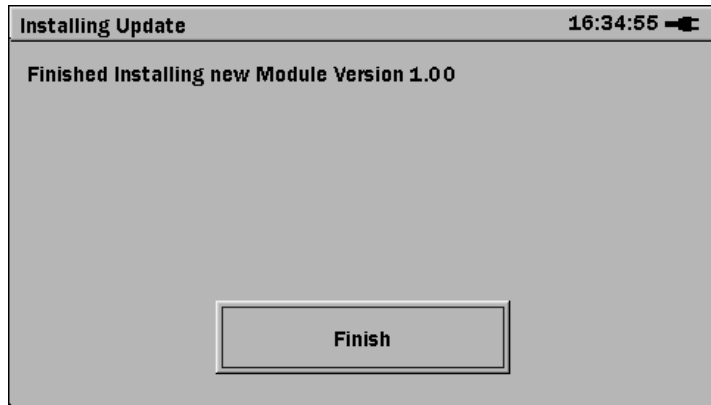

Figure 6.1-4 Finished button

 **WARNING**

When Format Drives During Installation is checked, all user data is lost. Backup all user data before installing updates.

Chapter 7 Service Information

This chapter describes the Self Diagnostics function and maintenance.

7.1	Self Diagnostics	7-2
7.1.1	Starting and Stopping Self Diagnostics	7-2
7.1.2	Progress Bar.....	7-2
7.1.3	Test Results.....	7-3
7.1.4	Pass/Fail Indication	7-4
7.1.5	Scrolling In Result Box	7-4
7.1.6	Cursor Key Navigation.....	7-4
7.1.7	Soft Key Navigation	7-5
7.2	Maintenance	7-6
7.2.1	Cleaning Optical Connectors.....	7-6
7.2.2	Cleaning Network Master	7-6
7.2.3	User Calibration.....	7-6
7.2.4	Repacking for Shipment	7-6
7.2	Disposal	7-7

7.1 Self Diagnostics

Self Diagnostics is an application that can verify whether the Network Master Gigabit Ethernet module hardware is working properly.

Self Diagnostics is a separate application and can only be accessed from the Top Menu. Therefore if an application is running it must be stopped first by returning to the Top Menu.

Do the following to start the Self Diagnostics application:

1. Navigate to the Top Menu by powering on the Network Master or return from the currently running application.
2. Highlight the **Self Diagnostics** button and press the **Set** key.

7.1.1 Starting and Stopping Self Diagnostics

To start Self Diagnostics:

1. Highlight the **Start** button at the Self Diagnostics screen and press the **Set** key, or press the **Start** key.

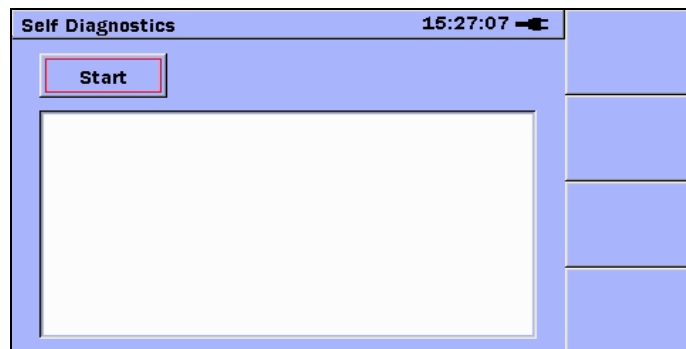

Figure 7.1.1-1 Highlighted Start button at Self Diagnostics Screen

While Self Diagnostics is running, the text on the **Start** button changes to **Stop**.

To stop Self Diagnostics:

1. Highlight the **Stop** button at the Self Diagnostics screen and press the **Set** key, or press the **Start** key.

7.1.2 Progress Bar

When Self Diagnostics is running, a progress bar indicates progress of the tests towards completion.

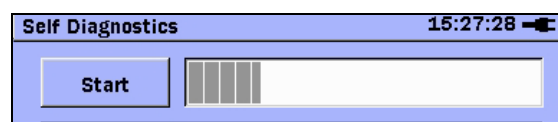

Figure 7.1.2-1 Progress Bar

7.1.3 Test Results

When Self Diagnostics has been started, the Result box displays information about completed tests.

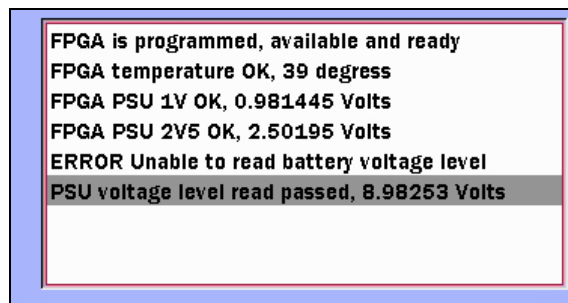

Figure 7.1.3-1 Test Results in Result Box

Each completed test is described by a single line of text describing:

- Test completed with or without errors
- What has been tested

In addition, some tests contain information on test results (Figure 7.1.3-2).

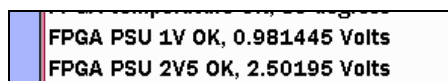

Figure 7.1.3-2 Test Completed with Result Information

If a test is completed with an error, the text line starts with the word ERROR (Figure 7.1.3-3).

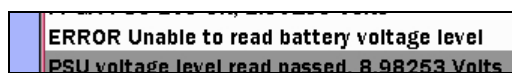

Figure 7.1.3-3 Example of Test Completed with Error

7.1.4 Pass/Fail Indication

When Self Diagnostics is completed, an LED on the GUI indicates whether the diagnostics were completed with or without errors; if there are errors, it indicates how many.

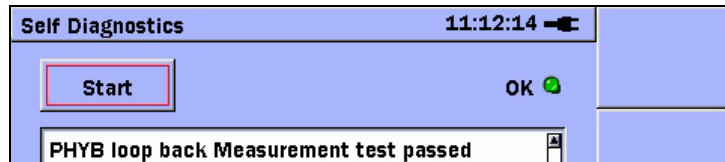

Figure 7.1.4-1 Indication of Test Completed Without Errors

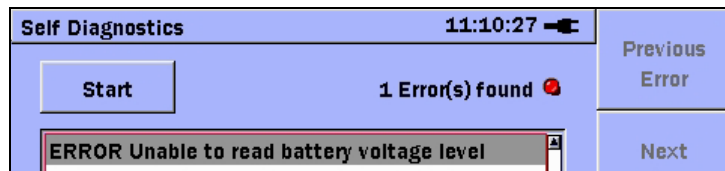

Figure 7.1.4-2 Indication of Test Completed With Errors

7.1.5 Scrolling In Result Box

Because Self Diagnostics runs more tests than can be displayed at once in the Result box, a scroll bar is displayed when the Result box is overflowing.

Navigating and scrolling between individual tests in the Result box are explained below.

7.1.6 Cursor Key Navigation

The **Up** and **Down** arrow keys are used to scroll in the result box if there is any results and to toggle focus between the **Start/Stop** button and the result box.

7.1.7 Soft Key Navigation

When Self Diagnostics has completed with errors, the **F1** and **F2** soft keys are used to navigate between errors.

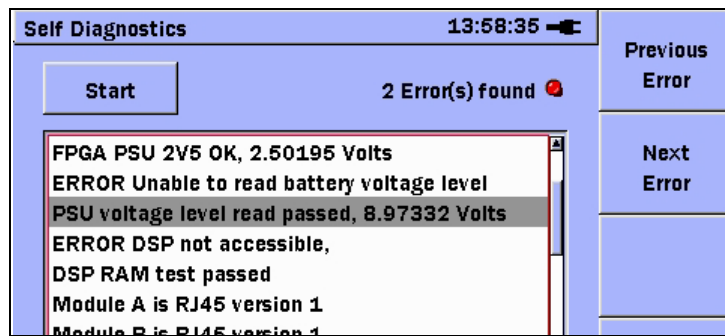

Figure 7.1.7-1 Error Navigation Soft Keys

When the last error in the list is selected so there is no next error to navigate to, the **Next Error** soft key is grayed out. The same applies to the **Previous Error** soft key when the first error in the list is selected.

7.2 Maintenance

User maintenance is limited to the following:

- Cleaning connectors
- Cleaning Network Master case

 **WARNING**

**Do NOT attempt to service the Network Master yourself.
Request servicing by authorized Anritsu personnel only.**

7.2.1 Cleaning Optical Connectors

Refer to the cleaning instructions in section 1.5.4.

7.2.2 Cleaning Network Master

If necessary, follow these steps to clean the unit case:

- Unplug the power cord from the top panel before cleaning.
- Clean the unit with a soft cloth lightly dampened with isopropyl alcohol.
- Do NOT clean the RJ-45 connector, and electric connector between the module and main frame with any solvents. Use dry compressed air to blow out any dust.

 **CAUTION**

Do NOT use chemically active or abrasive materials to clean the instrument.

7.2.3 User Calibration

The Network Master does not need calibration.

7.2.4 Repacking for Shipment

Keep the original packing for future use. Use the original packing when returning the Network Master to Anritsu for servicing. Contact Anritsu for instructions on returning the instrument.

7.3 Disposal

When the Network Master has reached the end of its useful life, dispose of it in accordance with local environmental regulations.

Before disposal, dismantle or physically destroy any non-volatile memory media in the Network Master to ensure that data in memory cannot be recovered by third parties.

Appendix A Specifications

A.1	Specifications.....	A-2
A.2	Parts and Accessories.....	A-9

A.1 Specifications

Table A.1-1 Specifications

Items	Specifications
Controller number Controller name	MT9090A Main Frame
Module number Module name Application	MU909060A1, MU909060A2, MU909060A3 Gigabit Ethernet module Installation Commissioning QoS Verification In-service troubleshooting Multistream (SW option) RFC 2544 Test (SW option) Stacked VLAN (SW option) MPLS (SW option) Remote GUI (SW option) Channel Stats (SW option) Y.1564 test (SW option)
Module configurations	MU909060A1: Gigabit Ethernet module with one electrical RJ-45 port One electrical or optical SFP module can be installed. MU909060A2: Gigabit Ethernet module with two electrical RJ-45 ports MU909060A3: Gigabit Ethernet module Two electrical or optical SFP modules can be installed. Electrical interfaces (if installed): 10/100/1000 Mbps RJ-45 (10BASE-T, 100BASE-TX, 1000BASE-T) Optical interfaces (if installed, depending on model and SFP module): 100 or 1000 Mbps LC connector (100BASE-FX, 1000BASE-SX, 1000BASE-LX or 1000BASE-ZX)
SW Options	Option 001 RFC 2544 test Option 002 Multistream Option 003 Stacked VLAN Option 004 MPLS Option 005 Remote GUI Option 006 Channel Stats Option 007 Y.1564 test

Table A.1-1 Specifications (Cont'd)

Items	Specifications				
Ethernet Interfaces	Duplex modes: Full duplex; Electrical 10/100 Mbps also Half duplex				
	Test configurations: Monitor/Generate, Pass Through, Reflector Reflector delay: 2.44 μ s @ 1000 Mbps, 5.16 μ s @ 100 Mbps, 31.93 μ s @ 10 Mbps				
	Specification of optical modules purchased from Anritsu for Network Master Gigabit Ethernet tester:				
	<i>NB: Correct functioning is only guaranteed with Anritsu optical modules specifically for MU909060A Series. Modules with extended temperature range (up to +85°C) must be used.</i>				
	Description	Min. input sensitivity and wavelength range		Output power and wavelength	
	1000BASE-S X 850 nm Multimode	-17 dBm	Min. 770 nm Max. 860 nm	-9.5 to -1.5 dBm	830 to 860 nm
	1000BASE-L X 1310 nm Single mode	-20 dBm	Min. 1260 nm Max. 1580 nm	-10 to -3 dBm	1270 to 1355 nm
1000BASE-Z X 1550 nm Single mode	-22 dBm	Min. 1260 nm Max. 1580 nm	-3 to 2 dBm	1480 to 1580 nm	
100BASE-F X 1310 nm Multimode	-31 dBm	Min. 1270 nm Max. 1600 nm	-20 to -15 dBm	1280 to 1380 nm	
100BASE-L X 1310 nm Single mode	-28 dBm	Min. 1260 nm Max. 1600 nm	-15 to -8 dBm	1261 to 1360 nm	

Table A.1-1 Specifications (Cont'd)

Items	Specifications
<p>Ethernet Interfaces(Cont'd)</p>	<p>Supported encapsulations: EtherType II (DIX v.2), IEEE 802.3 with 802.2 (LLC1), IEEE 802.3 with SNAP</p> <p>Traffic generation: Variable line rate traffic generation, up to full line rate Traffic shaping: Constant, Burst, Ramped Frame sizes can be set to constant, stepped or random length. Configurable Ethernet (MAC) and IP source and destination addresses (supports IPv4 and IPv6), UDP/TCP address and DSCP/TOS byte Request IP source address from DHCP server (on/off) Adjustable frame size from 46 to 10,000 bytes User-defined VLAN TIPD, VLAN ID and VLAN priority (multiple VLAN tags require Option 003) User-defined MPLS label, MPLS CoS and MPLS TTL (requires Option 004) User-defined traffic mix of unicast and broadcast frames Generate and respond to pause frames Answer incoming ARP request (On/Off) Optional Ethernet (MAC) and IP address swapping (reflector configuration)</p>
<p>Measurements and dedicated tests</p>	<p>Status: Link status, Signal and Frames present (utilization), Errored frames, Rx/Tx frame count, Link time, Remote fault, Speed, Full/Half duplex, MDI/MDIX, Interface type, Link partner abilities (Pause Capable and Asymmetric pause Request), Local clock (1000 Mbps), DHCP lease time, Optical level of optical interfaces</p> <p>Frame statistics: Total frames, Unicast/multicast/broadcast frames, Untagged frames, Single VLAN frames, Multiple VLAN frames, Unlabeled frames, Single MPLS frames, Multiple MPLS frames, Pause frames</p> <p>Errors: Number of fragmented frames, Oversized frames, Undersized (runts) frames, FCS errored frames, Collisions (10/100 Mbps Half duplex) Preamble violations, IFG violations (10/100Mbps non SFP), Severe IFG violations (SFP)</p> <p>SDT (Service Disruption Time): Measures gaps between received frames to detect service disruptions based on a user defined threshold. Min, Max, Average, Count, Total time, Total SDT (%) and Last Frame Received (interval) Timestamp.</p>

Table A.1-1 Specifications (Cont'd)

Items	Specifications
Measurements and dedicated tests(Cont'd)	<p>Electrical cable test: Detection of MDI/MDIX mode, Link speed and status, Cable status and distance to fault (if any), Polarity, Skew for 1000 Mbps Pin mapping: Tx/Rx for 10/100 Mbps, DA, DB, DC, DD for 1000 Mbps</p> <p>BER Test: Generation and detection of test patterns, Count of errors in received test pattern Pattern generation: Unframed, Framed with IP header or Framed with IP and TCP/UDP header Test patterns: PRBS 9, PRBS 11, PRBS 15, PRBS 20, PRBS 23, PRBS 29, PRBS 31, HF test pattern, CRPAT, JTPAT, SPAT Detection of sequence errors and loss of sequence synchronization</p> <p>Ping test: For connectivity and configuration check Round Trip Time (RTT) Supports IPv4 and IPv6 addressing Answer incoming Ping requests (On/Off)</p> <p>RFC 2544 test (option): Single ended network test and Switch/Router test modes: Throughput and utilization, Frame loss, Latency, Packet jitter, Back-to-back frames (burstability) End-to-end network test mode (two Network Master Gigabit Ethernet testers in master-slave setup): Throughput and utilization, Frame loss, Back-to-back frames (burstability) Router latency test mode: IP ping-based latency, IP ping-based packet jitter</p> <p>Multistream (option): Number of streams: Max. 8 active streams on Ethernet line Available current (per second) and cumulative information per stream: Transmitted and received total frames and bits, transmitted and received utilization(%) and throughput(%), transmitted and received broadcast frames and errored frames, SDT measurement (see above). Frame loss count/rate (not supported in Any Source configuration). Bar graph presentation of transmitted and received utilization(%), throughput(%), and errored frames(%)</p>

Table A.1-1 Specifications (Cont'd)

Items	Specifications
<p>Measurements and dedicated tests(Cont'd)</p>	<p>Channel Stats (option): Collects statistics on individual channels (received data streams) defined by user selected address and protocol key fields. Channels are auto-discovered. Up to 63 unique channels and 1 overflow channel are supported. Current (per second) and cumulative statistics are available. Order of arrival and Top talker modes are supported.</p> <p>Trace Route: Trace the network path to a destination. Available information: Hop number, Host IP address (when available), min, max and average RTT (round trip time).</p> <p>HTTP/FTP Download Throughput: Measure the download throughput of a link using HTTP or FTP protocol. Available information: Connection progress and protocol error messages, status (current bytes received), file size, graphical progress bar, min, max, average throughput.</p> <p>Y.1564 test (option): Perform the Y.1564 test methodologies for Ethernet Service Activation as defined by the ITU-T Y.1564 standard. The test suite includes the Y.1564 Config test for service configuration testing and the Y.1564 Perform test for service performance testing.</p> <p>Report generation: Generation of customized test result reports as .pdf or .csv files with user logo (pdf only) and comments</p> <p>PASS/FAIL Thresholds: Most applications support user specification of PASS/FAIL thresholds on key measurement parameters. If thresholds are enabled a PASS or FAIL indication for the test is shown on the Results Overview display.</p> <p>Event log: Major events during test with 1-s precision time stamp, including Link/No link, test Start/Stop, and test specific threshold violations.</p> <p>Remote GUI (option): Control the unit from a remote PC. Client application runs inside the PC's Web browser. Client application is served from the unit (no software installation is required on the PC). Uses HTTP protocol to pass through most firewalls without configuration changes. Supports upload (PC to unit) and download (unit to PC) of setup and result files.</p>

Table A.1-1 Specifications (Cont'd)

Items	Specifications
Other functions	<p>Date and time display/setting Color theme: Default, Outdoor White, Night, Orange Crush, Lush Green Language: English, Japanese, Spanish (Spain), Chinese (simplified), Chinese (traditional), German, Korean, French Battery level indication</p> <p>Internal memory: 40 MB internal memory for results, setups and screen shots</p> <p>Stored configurations: The user can save a number of configuration files for recall. Configuration files can be transferred to other instruments using a USB memory stick or PC.</p> <p>Test Automator: The user can create a macro to run several tests in sequence. The user can also load, save, import and export test macros.</p>
Display	4.3-inch color transmissive LCD (480 × 272 pixels, with LED backlight)
Service interfaces	<p>1 × USB 1.1 Type A (for USB memory stick)</p> <p>1 × USB 1.1 Type B (USB mass storage; internal device accessed as removable media on PC while connected to PC with USB cable)</p>
Laser safety	<p>Only applicable to MU909060A1 and MU909060A3 IEC 60825-1:2007 Class 1 THIS PRODUCT COMPLIES WITH 21 CFR 1040.10 AND 1040.11 EXCEPT FOR DEVIATIONS PURSUANT TO LASER NOTICE. NO.50, DATED JUNE 24, 2007.</p>
Power supply*	<p>Dedicated battery pack or four AA Ni-MH batteries AC Adapter: 100 to 240 V, 50/60 Hz</p>
Power consumption	15 W max. from AC supply
Battery operation time	Up to 3 hours of continuous measurement (MU909060A2) with backlight on at 25°C using dedicated battery pack (Ni-MH 2700 mAh) or 4 AA Ni-MH batteries
Battery charging time	3.6 hours (Typical) at +10° to +30°C with power off
Dimensions	<p>MT9090A mainframe: 96 (H) x 180 (W) x 18 (D) mm</p> <p>MU909060A1, MU909060A2, MU909060A3 Gigabit Ethernet Module: 96 (H) x 190 (W) x 30 (D) mm</p>

*: Operating voltage: within the range of +10% to -10% from the rated voltage

Table A.1-1 Specifications

Items	Specifications
Mass	800 g max. Main frame and module with dedicated battery pack
Environmental conditions	
Operating – Temperature Humidity	0° to +40°C ≤85%, No condensation
Storage – Temperature Humidity	–20° to +60°C ≤80%, No condensation
Vibration	IEC 60 068-2-6 Fc and IEC 60 068-2-64 Fh
Shock	IEC 60 068-2-27 Ea
Drop and topple	IEC 60 068-2-31 Ec
Bump	IEC 60 068-2-29 Eb
Free fall	IEC 60 068-2-32 Ed
EMC	EN61326-1: 2006 (Class A, Table 2) EN61000-3-2: 2006 +A1:2009 A2:2009 (Class A)
Dust proof, Drip proof	JIS C0920 IP51

A.2 Parts and Accessories

Table A.2-1 Parts and Accessories

Items	Specifications	Model Name
1000 Mbps SX SFP		G0240A
1000 Mbps LX SFP		G0241A
1000 Mbps ZX SFP		G0242A
100 Mbps FX SFP		G0243A
100 Mbps LX SFP		G0244A
10/100/1000 Mbps RJ-45 SFP		G0246A
OPTICALFIBERCORD (DUPLEX, SM, LC-LC CONNECTOR), 2M		J1271
OPTICALFIBERCORD (DUPLEX, GI, LC-LC CONNECTOR), 2M		J1273
LAN CABLE (CAT5E, STRAIGHT), 1M		J1275
LAN CABLE (CAT5E, STRAIGHT), 5M		J1275B
LAN CABLE (CAT5E, CROSS), 1M		J1275C
LAN CABLE (CAT5E, CROSS), 5M		J1275D
Ferrule cleaner	CLETOP type (one)	Z0914A
Replacement reel for ferrule cleaner	6 reel / pack	Z0915A
Ferrule side face cleaner (MU, LC)	Pipe type (600 pcs. per pack)	Z1211A
Ni-MH Battery pack	Ni-MH Battery pack, 4.8 Vdc, 2700 mAh	G0202A
AC adapter	100 to 240 Vac, 50/60 Hz, 9 Vdc	G0203A
Car plug cord		J1402A
USB-Ethernet converter		J1480A
USB-Ethernet converter		J1522A (New product)
Hard case		B0600B
Standard soft case		B0601B
Deluxe soft case	Can't put in with the protector attached.	B0602A
Strap		Z1023A
Network Master Gigabit Ethernet Tester Operation Manual - MT9090A Mainframe - MU909060A1/2/3 Gigabit Ethernet Module	Printed version	W3166AE
Protector & soft case		Z1580A
Protector		B0663A
Network Master Gigabit Ethernet Tester Quick Start Guide - MT9090A Mainframe - MU909060A1/2/3 Gigabit Ethernet Module	Printed version	W3173AE

Appendix B Remote Control

Option MU909060/A1/A2/A3-005 adds remote control capability to the unit. This option may be installed at the factory or it may be installed as a field upgrade after initial delivery.

The Remote Control option includes the following features:

- HTTP based connection to the instrument through a standard Web browser
- No PC installation required. Client software provided by the unit at connection.
- Security through password authentication
- Real-time updates of the local screen image in the browser application
- Remote control panel emulates local front panel button presses
- Simultaneous local and remote control for training or instructional purposes
- File download (transfer files from the MU909060 to a PC)
- File upload (transfer files from a PC to the MU909060)
- Supports optional automatic connection to the network through DHCP

B.1	Remote Control Setup	B-2
B.2	Remote Control Client	B-7

B.1 Remote Control Setup

The MU909060/A1/A2/A3 supports connection to an Ethernet network through a USB-Ethernet converter. The USB-Ethernet converter accessory is available from Anritsu as order number J1480A or (the newer model) J1522A, USB-Ethernet converter.

Notes:

- Software version V2.02 (or higher) is required to support the model J1522A accessory.
- Anritsu does not guarantee the performance of USB-Ethernet converters that are not supplied by Anritsu.

If option MU909060/A1/A2/A3-005 is installed on the unit, a networking tab (Net) will be available when in Top Menu setup, as shown in Figure B.1-1.

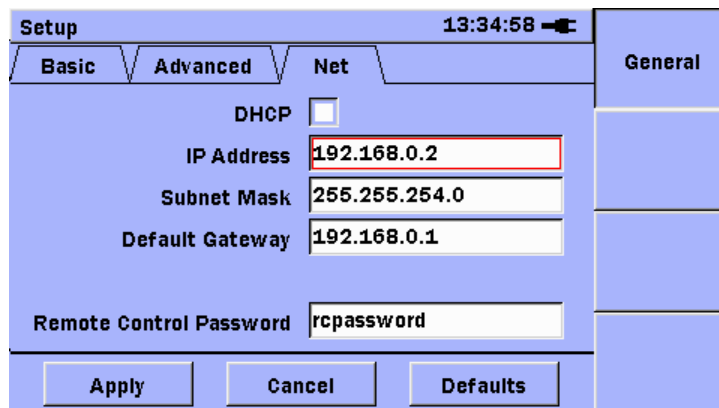

Figure B.1-1 Net Tab

To prepare the unit for connection to the network and remote control, it is necessary to establish a proper **network address** and **password** for the unit. There are two options for how the network address can be established:

- DHCP ON (checked) – automatic address assignment
- DHCP OFF (un-checked) - manual address assignment

DHCP (Automatic Assignment)

If the network supports **DHCP**, an IP address will be assigned automatically by the network. To use **DHCP**, perform the following steps:

1. Highlight the **DHCP** check box as shown in Figure B.1-2 and press the **Set** key so the box is selected.
2. Highlight the **Remote Control Password** field and enter a password for the unit. This password will be required to gain access to the unit from the remote client (described in section B.2 “Remote Control Client” below).

Note:

The default password is **rcpassword**.

3. Once all fields have been entered, highlight the **Apply** button and press the **Set** key to record the new settings. The setup screen will close and the **Top Menu** will be shown.

The screenshot shows a 'Setup' screen with a title bar displaying 'Setup' and the time '14:43:40'. There are three tabs: 'Basic', 'Advanced', and 'Net', with 'Net' being the active tab. On the right side, there is a 'General' tab. The 'Net' tab contains the following fields and controls:

- DHCP**: A checked checkbox.
- IP Address**: An empty text input field.
- Subnet Mask**: An empty text input field.
- Default Gateway**: An empty text input field.
- Remote Control Password**: A text input field containing the value 'rcpassword'.

At the bottom of the screen, there are three buttons: 'Apply', 'Cancel', and 'Defaults'.

Figure B.1-2 Net Tab (DHCP On)

4. Connect the RJ-45 connector of the Ethernet drop cable to Ethernet end of the USB-Ethernet converter.
5. Connect the USB end of the USB-Ethernet converter to the USB type A port of the controller (see Figure 1.5-1). The screen shown in Figure B.1-3 will be displayed.

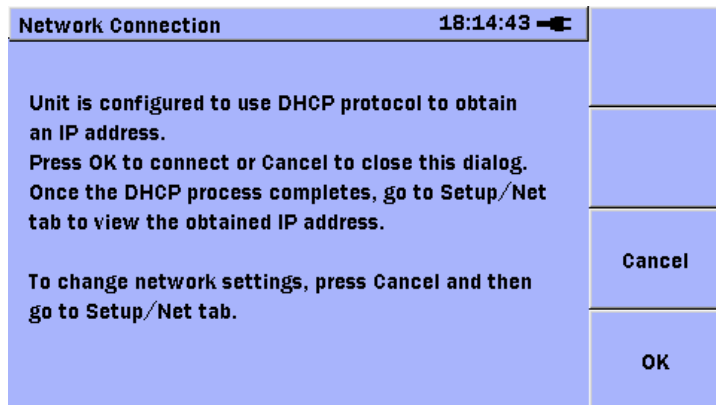

Figure B.1-3 DHCP Pop-Up

6. Press **F3 Cancel** to cancel the DHCP request process.
7. Press **F4 OK** to start the DHCP request process.
8. After a while, the DHCP Pop-up screen will close..
9. Press **Menu**, the setup menu will be displayed
10. Select **Setup**, the Top Menu setup will be displayed. Navigate to the Net tab.
11. If the DHCP request was successful, the assigned IP address and subnet mask will be shown on the Net tab, as shown in Figure B.1-4.
12. If the DHCP request was not successful, no IP address or subnet mask will be shown on the Net tab.

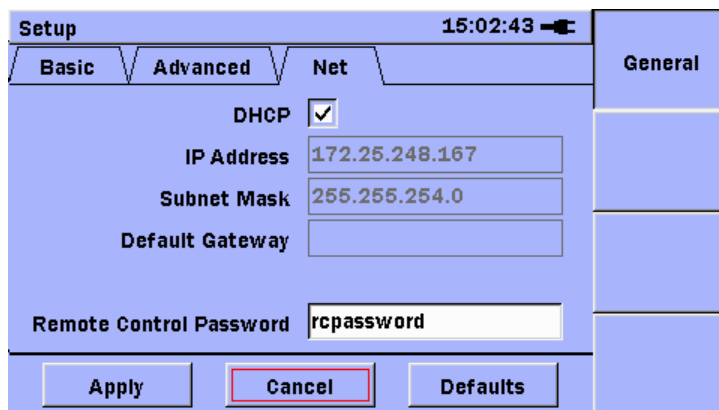

Figure B.1-4 Net Tab (DHCP Assigned IP Address)

Note:

The user should record the assigned IP Address so that it can be used to communicate with the unit from the remote PC.

MANUAL ASSIGNMENT

If the network does not support DHCP, or manual assignment of an IP address is desired, follow the steps below:

1. Highlight the DHCP check box. If the box is checked, press the **Set** key so that the box is cleared, as shown in Figure B.1-5
2. Highlight and edit the remaining address fields (IP Address, Subnet Mask, and Default Gateway). With the highlight positioned on any address field, press the **Set** key and the address editor will be displayed, as shown in Figure B.1-6.

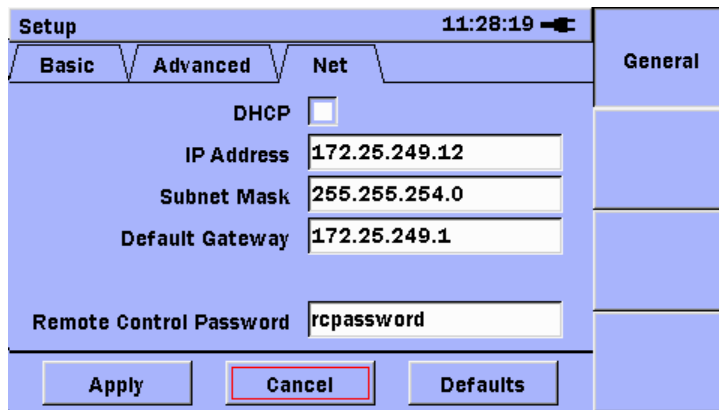

Figure B.1-5 Net Tab, DHCP Off

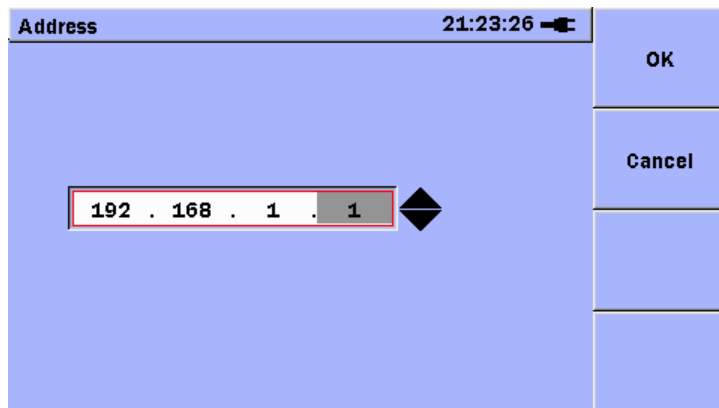

Figure B.1-6 Address Editor

Note:

If the Default Gateway field is set to 0.0.0.0, no value will appear in the Default Gateway field, and Gateway processing will not be used.

3. Highlight the **Remote Control Password** field and enter a password for the unit. This password will be required to gain access to the unit from the remote client (described in section B.2 below).

Note:

The default password is **rcpassword**.

- Once all fields have been entered, highlight the **Apply** button and press the **Set** key to record the new settings. The setup screen will close and the **Top Menu** will be shown.
- Connect the RJ-45 connector of the Ethernet drop cable to Ethernet end of the USB-Ethernet converter.
- Connect the USB end of the USB-Ethernet converter to the USB type A port of the controller (see Figure 1.5-1). The screen shown in Figure B.1-7 will be displayed.

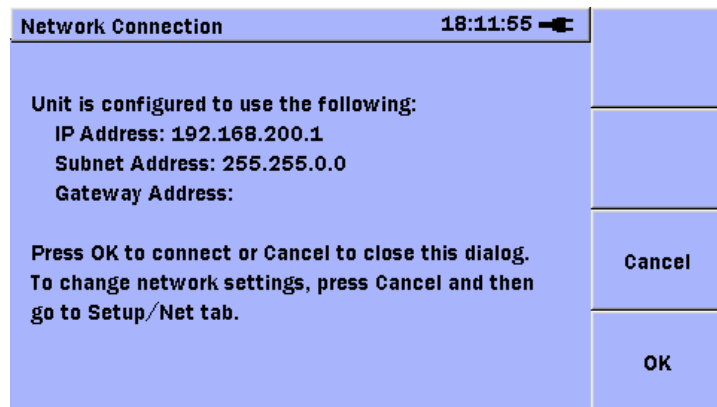

Figure B.1-7 Static Address Information

- Press **OK** (F4) to accept the settings and connect to the network.
- Press **Cancel** (F3) to close the screen without connecting to the network.

Note:

If the IP address information (shown in Figure B.1-5) is changed while the USB-Ethernet adapter is plugged in to the MU909060 unit, then it is necessary to remove the USB-Ethernet adapter from the MU909060 and re-insert it, before the new IP address information will take affect.

B.2 Remote Control Client

To run the Remote Client, perform the following steps:

Note:

The Web browser to be used must support Adobe Flash™ technology. Ensure that the latest version of Adobe Flash™ player is installed prior to performing the steps below.

1. Start a Web Browser on the PC (or other computer).
2. In the URL input field, type [HTTP://xxx.xxx.xxx.xxx](http://xxx.xxx.xxx.xxx), where xxx.xxx.xxx.xxx is the IP address that was entered or assigned in section B.1.
3. If network communications can be properly established between the PC and the MU909060, the screen shown in Figure B.2-1 will be displayed.

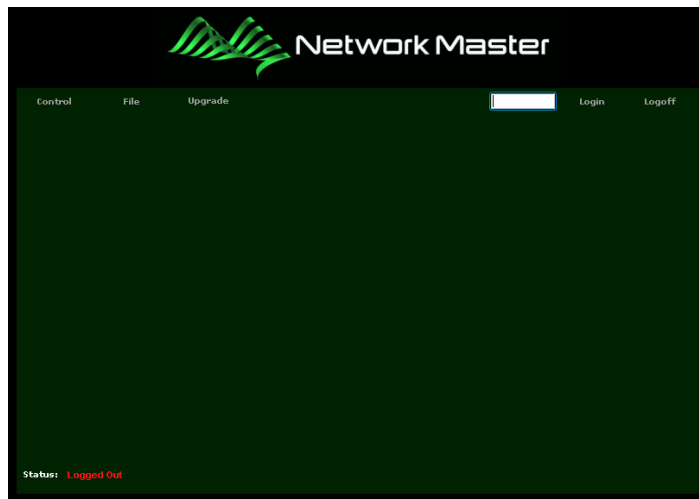

Figure B.2-1 Remote Client (before Login)

4. Enter the **Remote Control Password** that was established in section B.1, and click on the **Login** label. The screen shown in Figure B.2-2 will be displayed.

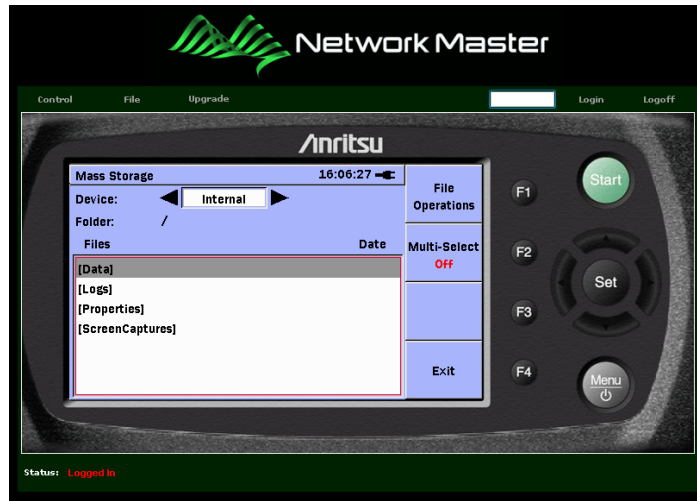

Figure B.2-2 Remote Client (after Login)

There are two (2) main remote control functions:

1. **Control** – the user can control the remote unit by clicking on the active zones of the client application. This is the default display immediately after login.
2. **File** – the user will be presented with the directory structure (folders and files) of the remote unit. This function supports:
 - File Upload (from PC to MU909060) - this function is useful for sending configuration and result files from a computer to the unit.
 - File Download (from MU909060 to PC) - this function is useful for retrieving configuration files, result file, and reports from the unit.

To use the **Control** function, perform the following steps:

1. Click on the **Control** label at the top left of the image of the MU909060 front panel.
2. There is an active zone around the image of each of the front panel hard keys (F1, F2, F3, F4, Start, Set, Menu, Up, Down, Left, Right arrows). Move the cursor for the pointing device (mouse) over the image of any of the front panel keys, and the active zone will turn red in color, as shown in Figure B.2-3.
3. Click on the active zone to execute a key press on the remote unit.

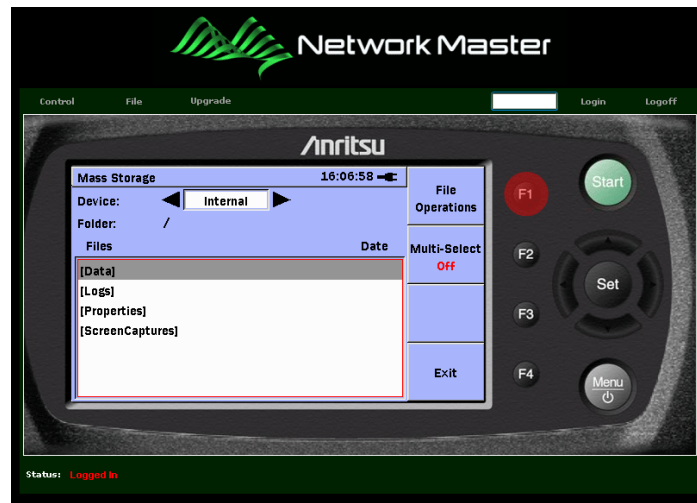



Figure B.2-3 Remote Client (F1 Control Zone)

To use the **File** function, perform the following steps:

1. Click on the **File** label at the top left of the image of the MU909060 front panel.
2. The screen shown in Figure B.2-5 will be displayed.
3. To navigate in the directory structure, click on any of the directory folders. The selected folder will open (or close) to expand (or contract) the contents of the folder, as shown in Figure B.2-6.
4. To download a file, click on the filename. A download will start automatically and a standard file save dialog from the Web browser will be shown to allow the user to select a location to save the file, or cancel the save operation.
5. To **upload** a file, click on the  button which is located near the bottom left corner of the **File** display. A standard file selection dialog will appear. Browse to the file to be uploaded and select it. Then click on the **Open** button of the file selection dialog. The upload will start automatically.

Notes:

- A file that is uploaded to the unit will be saved in the folder that is currently open (expanded) as described in step 3 above. If no folder is currently open, the upload operation cannot proceed and a warning message will be displayed in the **Status** line.

- The unit must have enough free space on its internal data drive to hold the file to be uploaded or the operation will not proceed. In addition, if the upload operation would cause the free space on the internal data drive to be reduced below one megabyte (1 MB), the upload operation will not proceed. Either condition will cause a warning message to be displayed in the **Status** line.
- An **upload** or **download** operation can be canceled after it is started by clicking on the  icon which is located near the end of the **Download/Upload progress:** bar.
- The user should observe the **Status** line at the bottom of the display. The **Status** line shows the progress of an **upload/download** operation while it is in progress. Other messages shown in the **Status** line may indicate the operation has failed due to an error, or that the operation has completed successfully.

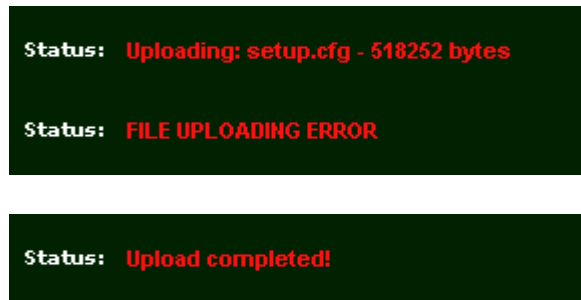

Figure B.2-4 Status Messages

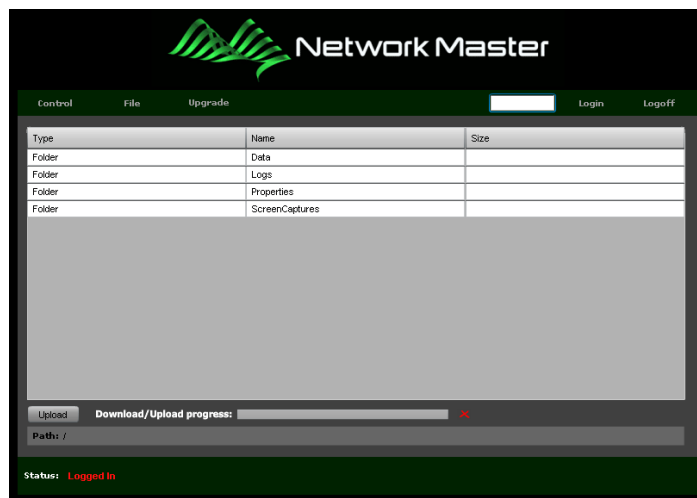

Figure B.2-5 Remote Client (File Menu)

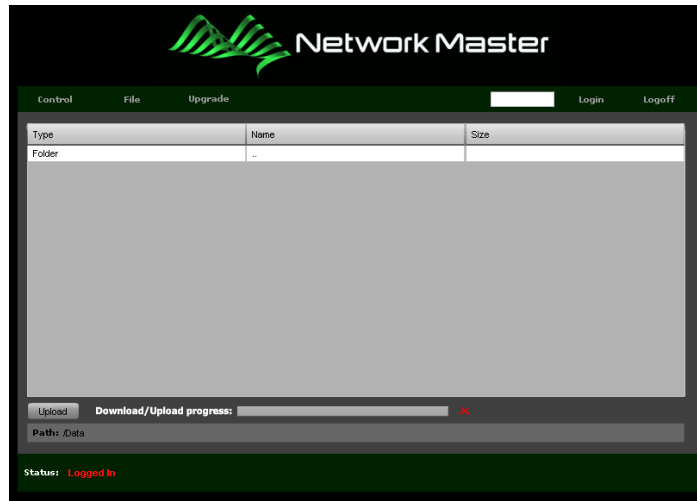

Figure B.2-6 Remote Client (Data Directory)

To close the remote session, perform the following steps:

1. Click on the **Logoff** label at the top right of the image of the MU909060 front panel.
2. Close the Web browser

Note:

If the Web browser is closed before the Logoff is performed, it is possible the connection will not be dropped by the remote unit. To make sure a new connection can always be established, it is necessary to close all existing connections whenever a user logs in to the unit. This implies that a current user session can be forced to close by a new user who logs in to the same unit.

Appendix C PC Application Manual

C.1	Overview	C-2
C.2	Operating System Requirements.....	C-2
C.3	Software Installation	C-3
C.4	Running the Application.....	C-11
	C.4.1 Checking the Version of the Application.....	C-12
	C.4.2 Managing Files	C-13
	C.4.3 Managing Paid Options	C-14
C.5	Creating and Editing Setup Files	C-17
	C.5.1 Interface Setup	C-18
	C.5.2 Test Destination Setup	C-19
	C.5.3 Report Setup.....	C-19
	C.5.4 Y.1564 Setup.....	C-20
C.6	Copy/Paste Functions.....	C-32
C.7	Input Validation	C-34

C.1 Overview

The MU909060A Setup Application is a Windows application that is provided with **MU909060A Gigabit Ethernet product**. The application allows the user to create or modify configuration files on a PC that are compatible with the MU909060A Ethernet firmware V3.00 (or higher).

C.2 Operating System Requirements

The MU909060A Setup Application requires a Windows XP*¹, Windows Vista, or Windows 7 (32-bit or 64-bit) operating system to be installed on the PC. In addition, the application requires the .NET Framework V4.0 to be installed on the PC. The .NET Framework V4.0 is included in the installation package.

*1: A minimum configuration of Windows XP Service Pack 3 (SP3) with Windows Installer 3.1 is required.

C.3 Software Installation

The MU909060A Setup Application is included on the Network Master Gigabit Ethernet Tester CD, supplied with the unit. It is also available as a free download from www.anritsu.com.

To install the software from CD, perform the following steps:

1. Insert the Network Master Gigabit Ethernet Tester CD in the drive on the PC.
2. Browse to the MX909060A folder.
3. Double-click on the Setup.exe file to run it

To install the software from a download file, perform the following steps:

1. Download MX909060A.exe from www.anritsu.com
2. Double-click on the MX909060A.exe file to run it. The image below will be displayed.

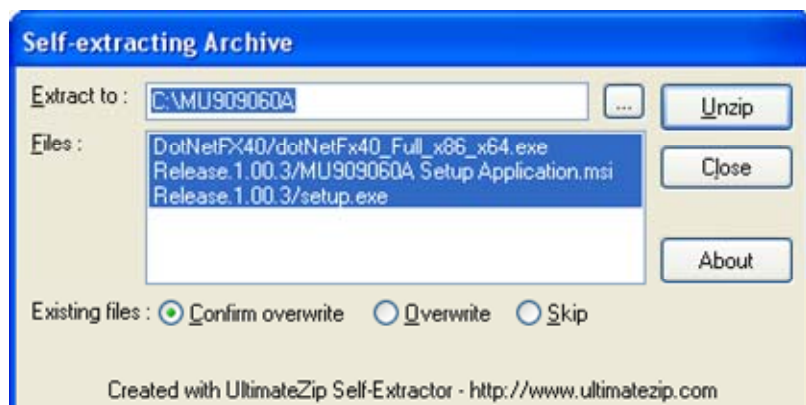

3. Click on the  button to browse to a folder that will hold the extracted program files.
4. Click on the **Unzip** button. The files will be extracted to the specified folder.
5. Browse to the folder that received the files. Double-click on the **Setup.exe** file to run it.

Installing the .NET Framework

The Microsoft .NET Framework is a set of components supplied by Microsoft Corporation. If the .NET Framework V4.0 is not installed on the PC, it will be installed before the MU909060A Setup Application is installed. The image below will be displayed:

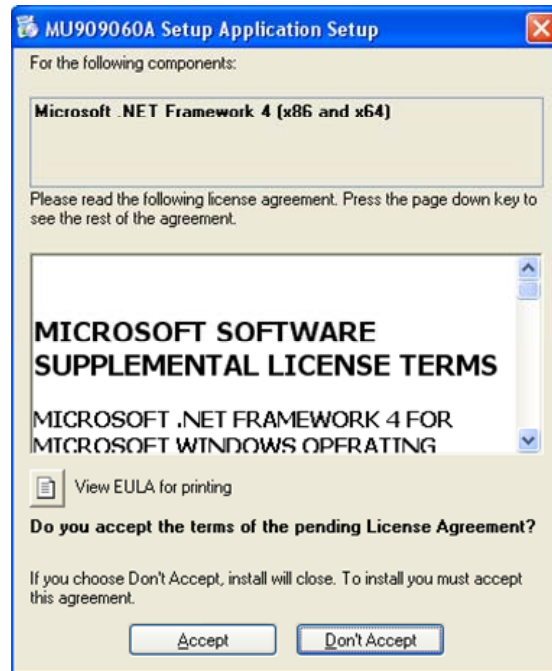

Read the EULA (End User License Agreement). Click on the **Accept** button to accept the terms of the EULA and proceed with the installation. Click on the **Don't Accept** button to cancel the installation process.

While the .NET Framework software is installing, the image below will be displayed:

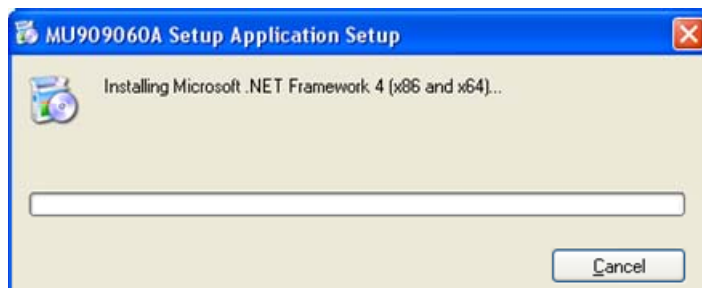

This step can take several minutes to complete. A system re-boot may be required after this step is completed. If a re-boot is required, the installation process will continue automatically when the system returns from the re-boot process.

User Account Control

Certain Windows operating systems such as Vista or Windows 7 employ UAC (User Account Control) to monitor software programs that attempt to modify the system. If your system includes UAC and you are attempting to install or un-install the MU909060A Setup Application software from an account that does not have Administrator access privileges, a message similar to the one shown below may appear:

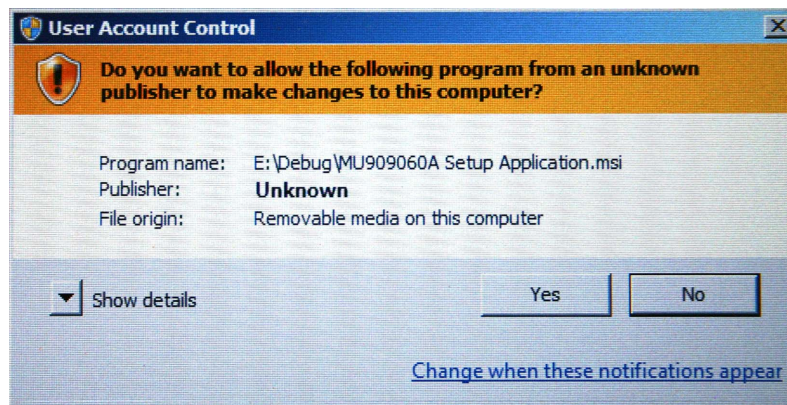

Select **Yes** to allow the installation (or un-installation) to continue. Select **No** to abort the installation process.

Removing Prior Versions of Software

If the image shown below is displayed, a prior version of MU909060A Setup Application is already installed on the PC and must be removed before the new version can be installed. Otherwise proceed to Completing the Installation.

1. Click on the **Remove** radio button as shown below and click on the **Finish** button.

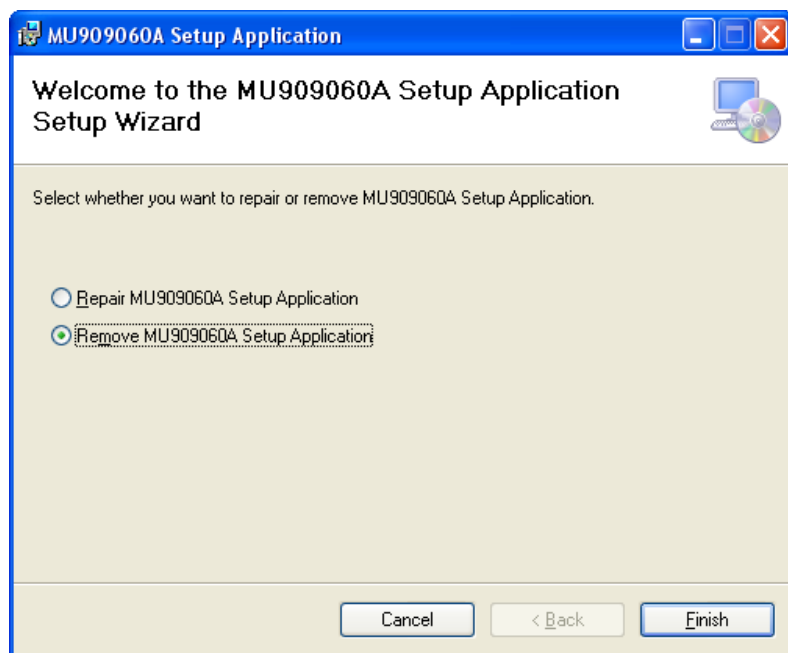

2. The image below will be displayed while the software is being removed.

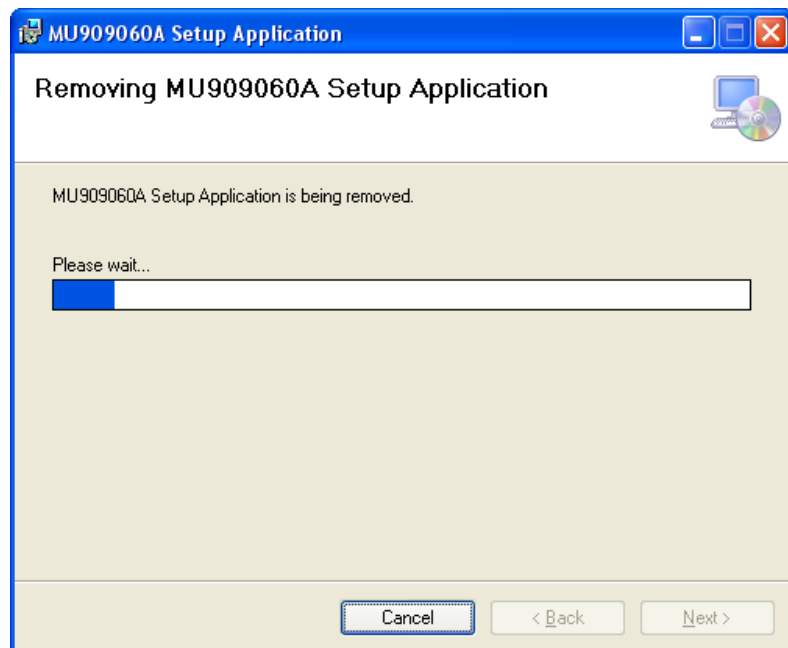

3. The image below will be displayed when the removal process is complete. Click **Close** to complete the process.

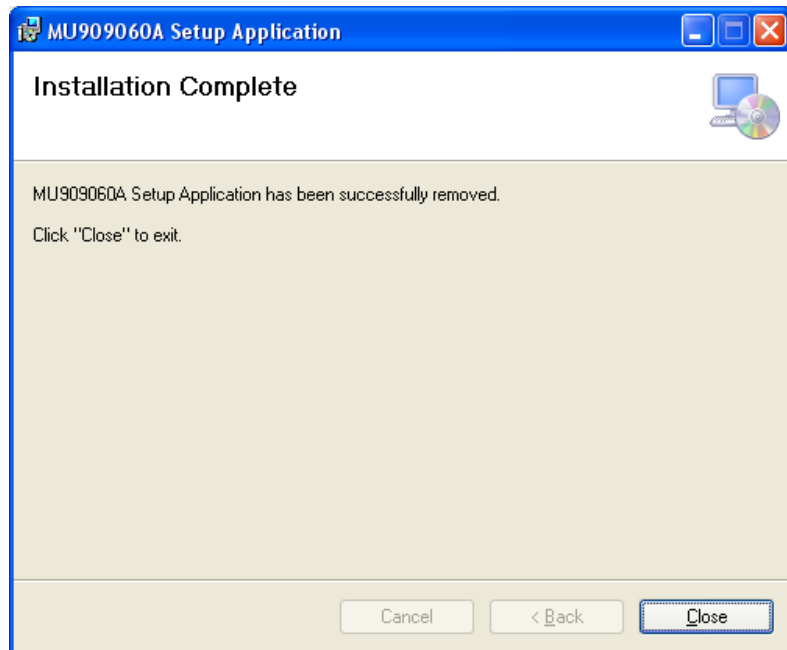

Completing the Installation

1. Double-click on the **Setup.exe** file to run it. The image below will be displayed. To proceed with the installation, click on the **Next** button. Otherwise click on the **Cancel** button.

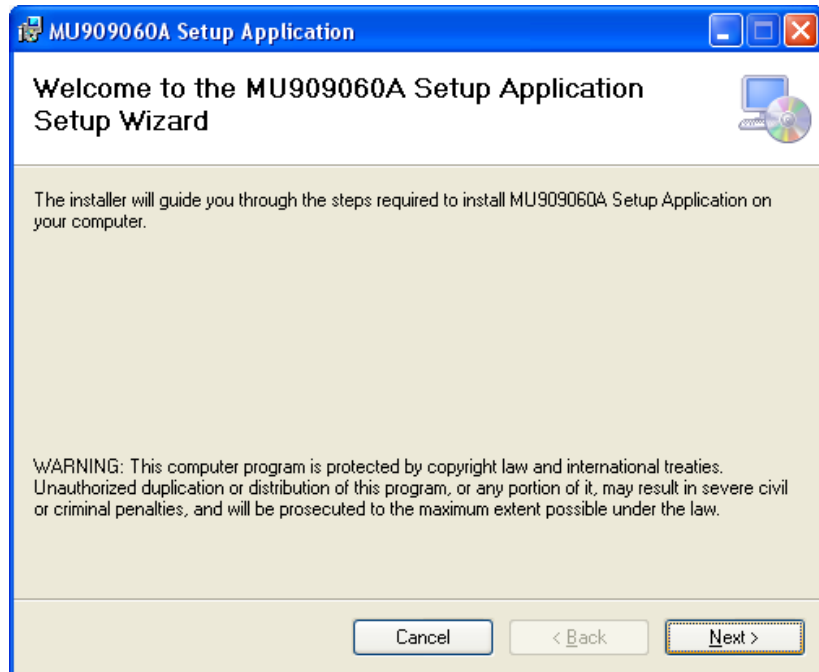

2. The image below will be displayed.

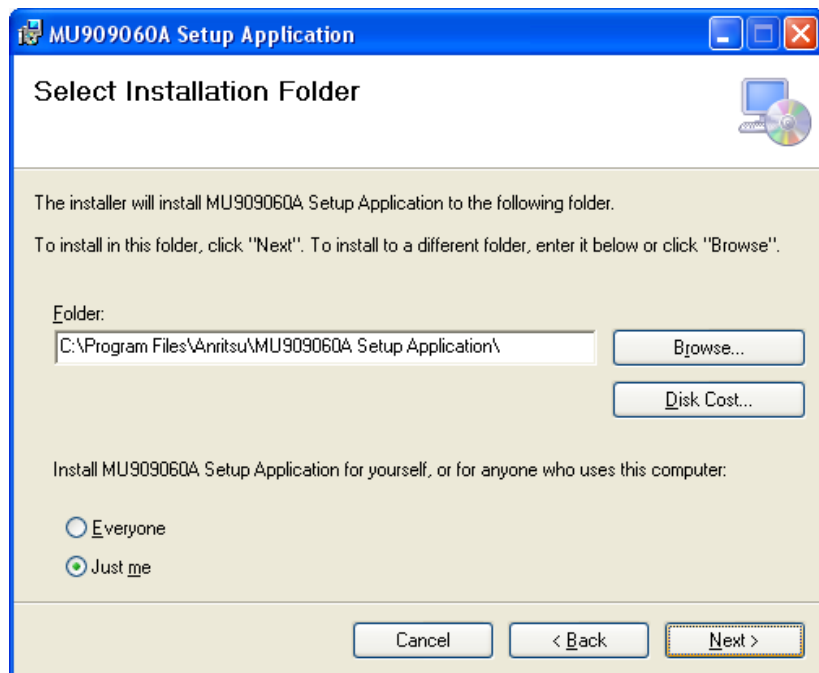

3. Browse or enter the folder name where the application will be installed. Click **Next**. The image below will be displayed:

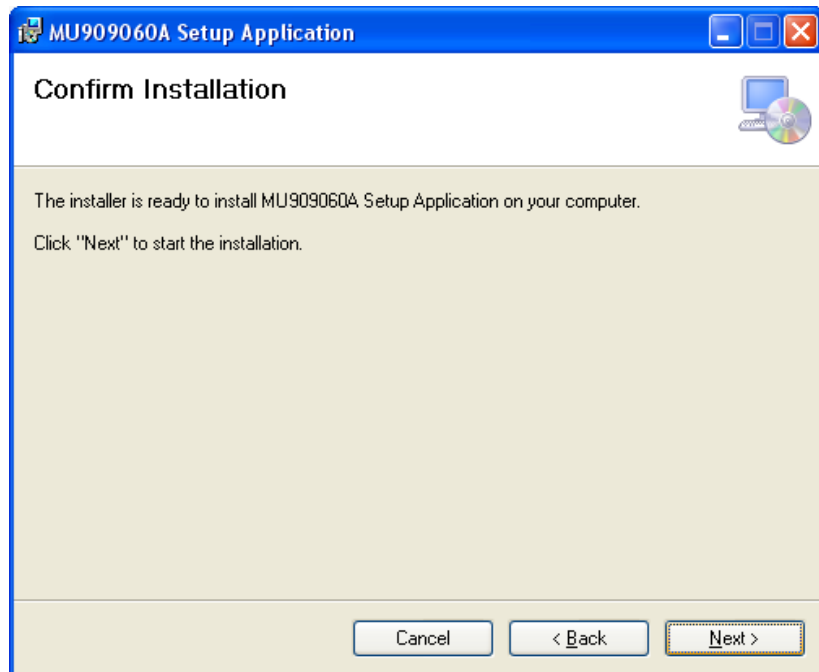

4. Click **Next** to begin the installation process. The image below will be displayed:

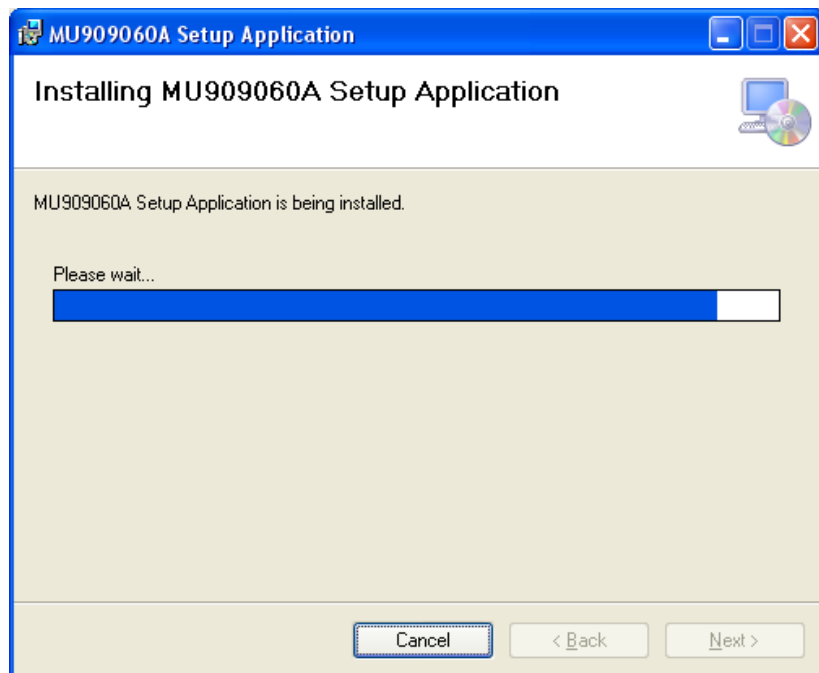

5. Click on the **Close** button to complete the installation process.

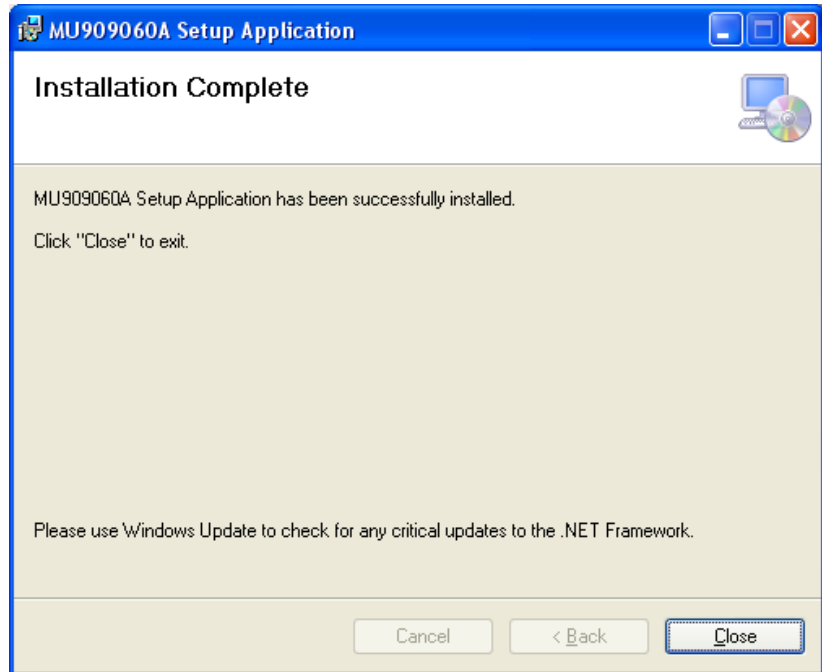

C.4 Running the Application

The installation will create an icon on the desktop as shown below,



and it will add the application to the Programs menu under Anritsu, as shown below:



To run the MU909060A Setup Application, double-click on the desktop icon or select the program from the Programs menu. The image below will be displayed:

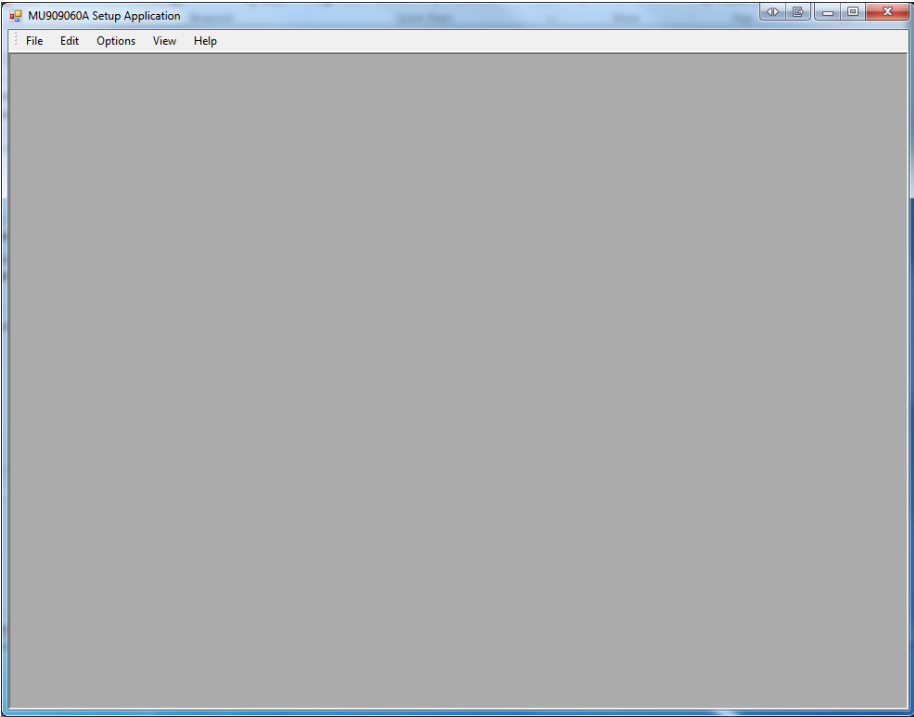

C.4.1 Checking the Version of the Application

To check the version of the application, use the **Help>About** function. The image below will be displayed:

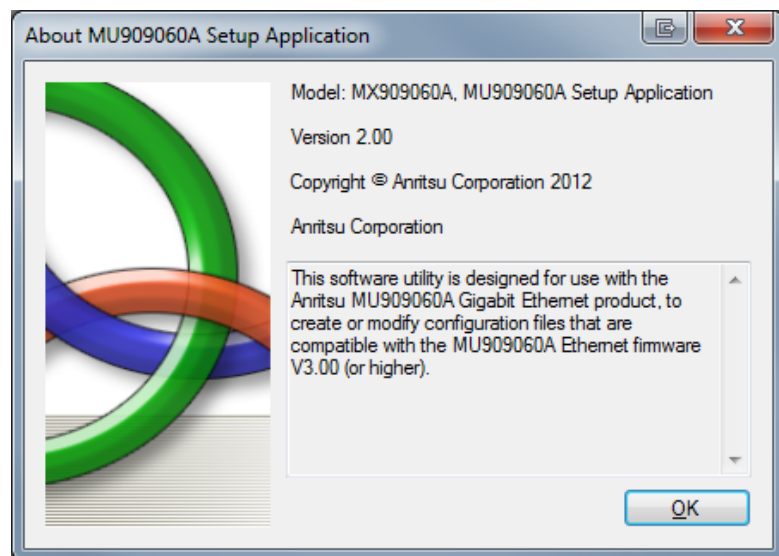

C.4.2 Managing Files

When the application is started, a **default setup file** will be loaded. This file includes all of the defaults for the application setups.

The application can operate on a **default setup file** or a **user supplied setup file** which was previously saved on the MU909060A instrument, running V3.00 firmware (or higher). File operations are managed through the **File menu** as shown below:

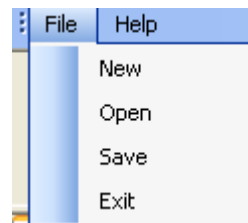

- To load the **default setup file** at any time, select the **New** menu item. The **default setup file** will be loaded.
- To **open a user supplied setup file**, select the **Open** menu item.
- To **save the current file**, select the **Save** menu item.
- To **exit the application**, select the **Exit** menu item.

C.4.3 Managing Paid Options

There are five (5) paid options that can affect the setup.

- Option MU909060A2-001 RFC2544 adds the RFC2544 Throughput, Latency and Burst tests.
- Option MU909060A2-002 Multi-stream allows up to 8 interface options and 64 test generator destinations.
- Option MU909060A2-003 Stacked VLAN controls the presence or absence of the VLAN 2 and VLAN 3 columns.
- Option MU909060A2-004 MPLS controls the presence or absence of the MPLS 1, MPLS 2, and MPLS 3 columns.
- Option MU909060A2-007 Y1564 test setup which enables the Y1564 test setup view.

To access the software options control, click on the **Options** label. To enable (✓) or disable (un-✓) the paid options in the PC Setup Application, select the check box to the left of the option name.

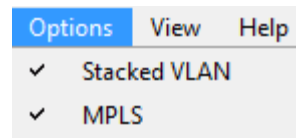

The table below summarizes the results of creating a setup file with the VLAN option flag enabled or disabled, and subsequently loading the file on a unit that has the VLAN option flag enabled or disabled.

Table C.4-1 VLAN option vs Setup file load control

		Unit	
		VLAN option is enabled	VLAN option is disabled
Setup File Created on PC	VLAN option is enabled	The file will load correctly and the optional columns and data entered from the PC will be available.	A warning message will be displayed. The setup file will not load.
	VLAN option is disabled	The optional columns will not be available for input from the setup application. The file will load correctly on the unit. The optional columns will show default values on the unit.	The optional columns will not be available for input from the setup application. The file will load correctly on the unit. The optional columns will not be available on the unit.

Note:

If the Stacked VLAN option on the Options menu is enabled and the state of the check-box is changed to disabled, a warning message will appear as shown below:

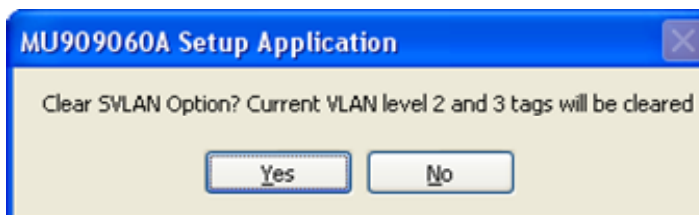

Click **Yes** to disable the Stacked VLAN option and clear all inputs in the VLAN 2 and VLAN 3 columns. Click **No** to cancel this operation.

The table below summarizes the results of creating a setup file with the MPLS option flag enabled or disabled, and subsequently loading the file on a unit that has the MPLS option flag enabled or disabled.

Table C.4-2 MPLS option vs Setup file load control

		Unit	
		MPLS option is enabled	MPLS option is disabled
Setup File Created on PC	MPLS option is enabled	The file will load correctly and the optional columns and data entered from the PC will be available.	A warning message will be displayed. The setup file will not load.
	MPLS option is disabled	The optional columns will not be available for input from the setup application. The file will load correctly on the unit. The optional columns will show default values on the unit.	The optional columns will not be available for input from the setup application. The file will load correctly on the unit. The optional columns will not be available on the unit.

Note:

If the MPLS option on the Options menu is enabled and the state of the check-box is changed to disabled, a warning message will appear as shown below:

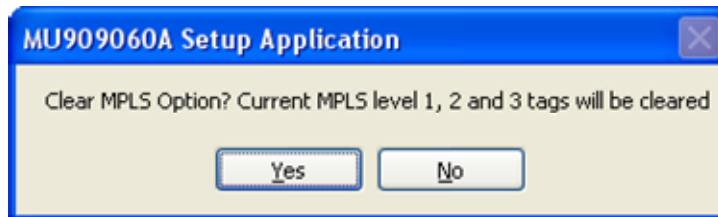

Click **Yes** to disable the MPLS option and clear all inputs in the MPLS 1, MPLS 2, and MPLS 3 columns. Click **No** to cancel this operation.

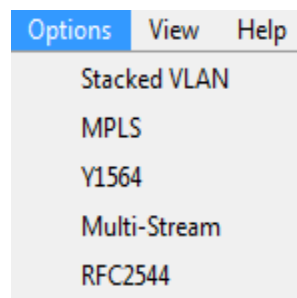

- Y1564 option will enabled the Y1564 setup in the View menu.
- Multi-Stream option turns on up to 8 streams for the interface setup and the Test Generator.
- RFC2544 option will enable the RFC tests for configuration under the View → Port A/B Test Setup.

C.5 Creating and Editing Setup Files

The MU909060A Setup application has been designed to provide an easy method to create setup files.

There are five (5) steps to create (or modify) a setup file:

1. Open a user supplied setup file or use the default file supplied with the application.
2. Enter all of the desired address and information for the test. Select the tests and sub-tests to be run.
3. Save the file using the **File>Save** menu item to a USB memory device.
4. With the Ethernet application running on the MU909060A unit, insert the memory device into the unit. Browse to the USB device and highlight the setup file.
5. Select **Load** from the Menu and press the **LOAD SETUP** soft-key.

Note:

An optional method (at Step 3) is to use the Mass Storage/Copy function to permanently copy the setup file from the USB memory device to the internal memory of the unit. Then (at Step 4) browse to the unit's internal memory to load the file.

In the View menu there are 3 setup screens to be configured and if Y.1564 is enabled that will also appear as an option.

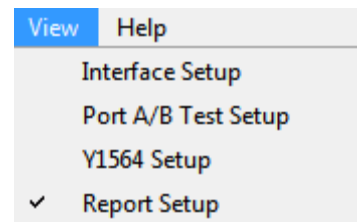
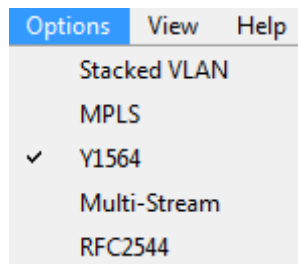

C.5.1 Interface Setup

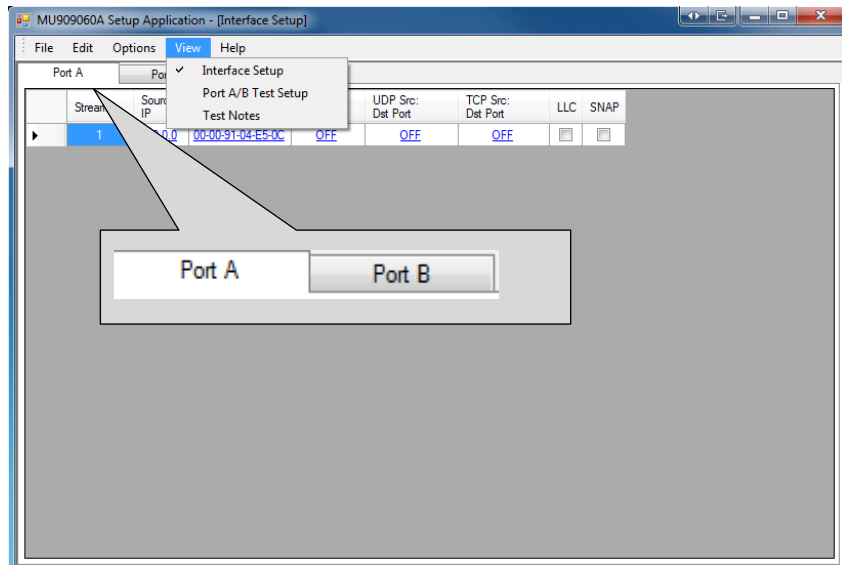

The interface setup allows you to configure both port A and port B's source IP, source MAC, VLAN, UDP/TCP, LLC, and SNAP for one or multiple streams if the multi-stream option is enabled. There is validation for both the source IP and source MAC. If SNAP is enabled then LLC is automatically checked with it, however if LLC is only checked then SNAP does not need to be. If UDP or TCP is chosen then the Protocol inside the Source IP will also change accordingly.

If the interface source IP is set to IPv4 then the test destination IP for that stream will also be IPv4 and similarly for IPv6.

C.5.2 Test Destination Setup

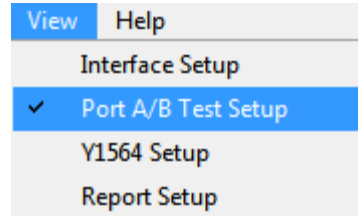

The Port A/B Test setup page will allow you to configure port A and B setup for the Generator, Ping, BERT, HTTP/FTP, Trace Route as well as RFC2544 Throughput, Latency and Burst if the RFC2544 option is enabled. There can be up to 8 tests configured for each port and up to 64 tests configured for Generator if multi-stream is enabled. For each test you can configure the Destination IP and Destination MAC for both ports. The inputs for IP and MAC are both validated.

C.5.3 Report Setup

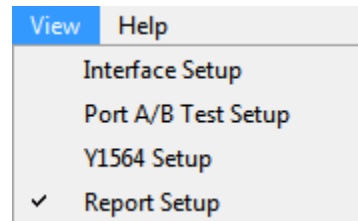

In the Report Setup section there are three tabs: Basic, Comment and Logo.

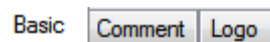

- In the Basic tab you can set what port you want to be Receivers/Transceivers. You are also able to choose if you want to include the Setup, Comment and Error Logs with the report.
- In the Comment tab there are 4 text fields each of which can hold up to 20 characters. These fields are: Customer, Project/Description, Operator, and Notes.
- The last tab is Logo where you can include a logo and also set the path.

Note:

The Path is relative to the unit.

C.5.4 Y.1564 Setup

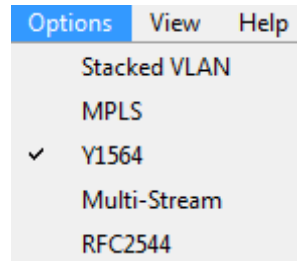

If the Y1564 option is enabled in the dropdown then the Y1564 Setup will be shown in the View menu.

C.5.4.1 Ports

Change ports by using the tab control, located near the top-left of the display:

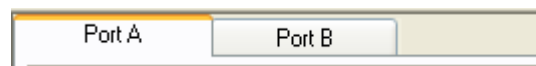

All of the individual setup items described in sections below can be selected independently for each port.

C.5.4.2 Test Mode Selection

The Test Mode option group is located near the top of the display and includes the same selections that are available on the Y.1564 Suite Test Mode and End to End setup tabs on the unit. Refer to section 3.11.5 of the MU909060A Ethernet Application manual for a complete description of these settings.

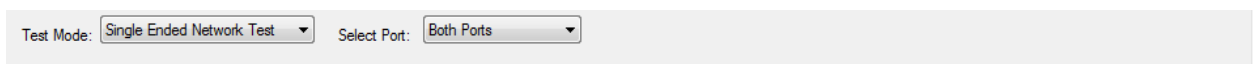

- Test Mode: (Switch-Router Test, Single Ended Network Test, End to End Network Test)
- Select Port: (Port A, Port B, Both Ports)

If the End to End Network Test mode is selected:

- End to End One way test (✓ = enable)
- Store results on slave (✓ = enable)
- Show Estimated One Way FTD (✓ = enable)
- Clock Drift Correction (us/sec)
- VLAN Levels
- MPLS Levels

If the End to End One way test is enabled:

- One way Direction: (Slave->Master, Master->Slave)

The screenshot shows a configuration panel with the following settings:

- Test Mode: End to End Network Test
- Select Port: Both Ports
- End to End One way test:
- Store results on slave:
- VLAN Levels: 1<->3
- MPLS Levels: None<->3
- One way Direction: Slave->Master
- Show Estimated One Way FTD:
- Clock Drift Correction (us/sec): -13.009

C.5.4.3 Y.1564 Perform Test Options

The Y.1564 Perform Test option group is located near the top-left of the display and includes the same selections that are available on the Y.1564 Suite Perform setup tab on the unit. Refer to section 3.11.8 of the MU909060A Ethernet Application manual for a complete description of these settings.

The screenshot shows the 'Perform Test' configuration window with the following settings:

- Enable Y.1564 Perform:
- Run Only if Y.1564 Config Test PASS:
- Test Run Time (dd:hh:mm:ss): 5:00:05

- Enable Y.1564 Perform (✓ = enable)
- Run Only if Y.1564 Config Test PASS (✓ = enable)
- Test Run Time (dd:hh:mm:ss) - use the dial controls to enter the desired run time for the test.

C.5.4.4 Y.1564 Config Test Options

The Y.1564 Config Test option group is located near the center-left of the display and includes the same selections that are available on the Y.1564 Suite Config setup tab on the unit. Refer to section 3.11.7 of the MU909060A Ethernet Application manual for a complete description of these settings.

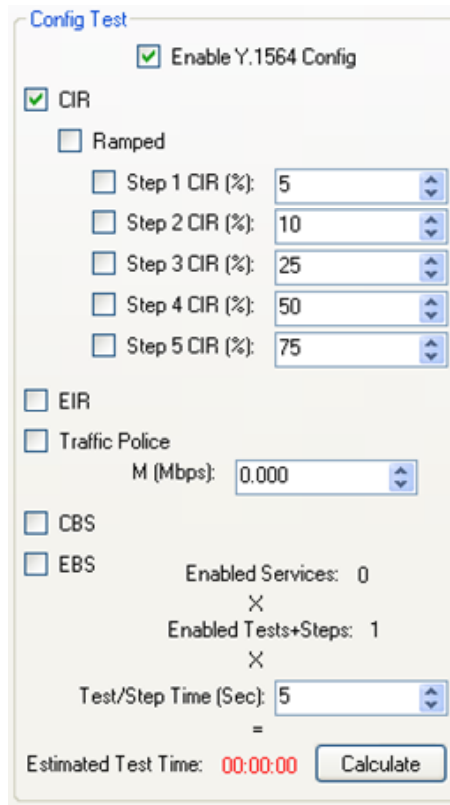

- Enable Y.1564 Config (√ = enable)
- CIR Test (√ = enable)

If CIR test enabled:

- Ramped (√ = enable)

If Ramped enabled:

- Step 1 – Step 5 (√ = enable) – use the dial control to enter the percentage of CIR for the step.
- EIR Test (√ = enable)
- Traffic Policing Test (√ = enable)

If Traffic Policing test enabled:

- M (Margin) – use the dial control to enter the margin value (M) in Mbps
- CBS Test (√ = enable)
- EBS Test (√ = enable)

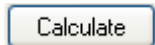
- Test/Step Time – use the dial control to enter the time for each test step in seconds.
- To calculate the Estimated Test Time, click the  button.

C.5.4.5 Services Table

The Services table is designed to define one Service in each row of the table. Each Service has twenty-three (23) possible fields that can be selected and edited. The fields are described in the table below:

Table C.5.4.5-1 Service Table

Field	Description	How To Edit
SRV#/ Enable	Service number Enable flag. ✓ to enable the Service to run.	N/A Click on the check-box to enable (✓) or disable (un-✓)
Service Name	Service name. Up to 8 characters.	Click to highlight the field. Type directly in the field.
Service Profile	OFF, Voice, Video	<p>Click on the field. The Service Profile pop-up dialog will appear.</p>  <p>Click on the radio button for the desired selection. Use the pull-down list to select the protocol. Use the dial control to define the number of Calls/Channels. Click on OK to save the changes. Click on Cancel to discard the changes.</p>
CIR(Mbps)	Committed Information Rate in Mbps.	Click to highlight the field. Enter the value directly in the field.
EIR(Mbps)	Excess Information Rate in Mbps.	Click to highlight the field. Enter the value directly in the field.

Table C.5.4.5-1 Service Table (Continued)

Field	Description	How To Edit
SRC IP	Source IP Address	<p>Click on the field. The IP Setup pop-up dialog will be displayed.</p>  <p>Use the radio-button to select IPv4 or IPv6. Enter the Source and Destination IP addresses. Enable (✓) Gateway processing (if desired). Enter the Gateway addresses for the local and remote units. Enable (✓) the remaining options. Enter the required values directly in the input fields.</p>
DST IP	Destination IP Address	See cell above.

Table C.5.4.5-1 Service Table (Continued)

Field	Description	How To Edit
SRC MAC	Source MAC Address	<p>Click on the field. The MAC Address Setup pop-up dialog will be displayed.</p>  <p>Enter the Source and Destination MAC addresses. Click on the Use ARP check-box if ARP processing is desired.</p>

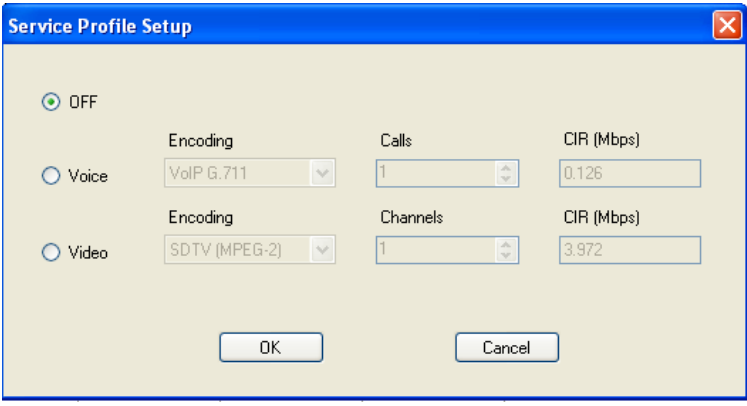
Table C.5.4.5-1 Service Table (Continued)

Field	Description	How To Edit
DST MAC	Destination MAC Address	See cell above.
Color Mode	Color Mode Selection	<p>Click on the field. The Color Mode pop-up dialog will be displayed.</p>  <p>Click on the radio button to make the color mode selection. Use the dial controls to input the VLAN Priority values. Use the pull-down lists and dial controls to input the IP DSCP values.</p>
VLAN	VLAN ID,PRI	<p>Click on the field. The VLAN pop-up dialog will be displayed.</p> <p>Note: if the Stacked VLAN option is disabled, only the VLAN 1 column will be shown.</p>  <p>Click on the VLAN button to enable the VLAN. Use the pull-down list to select the TPID. Use the dial-control to select the priority value. Click on the CFI check-box to enable (✓) or disable (un-✓) the CFI flag. Use the dial-control to set the VID value.</p>

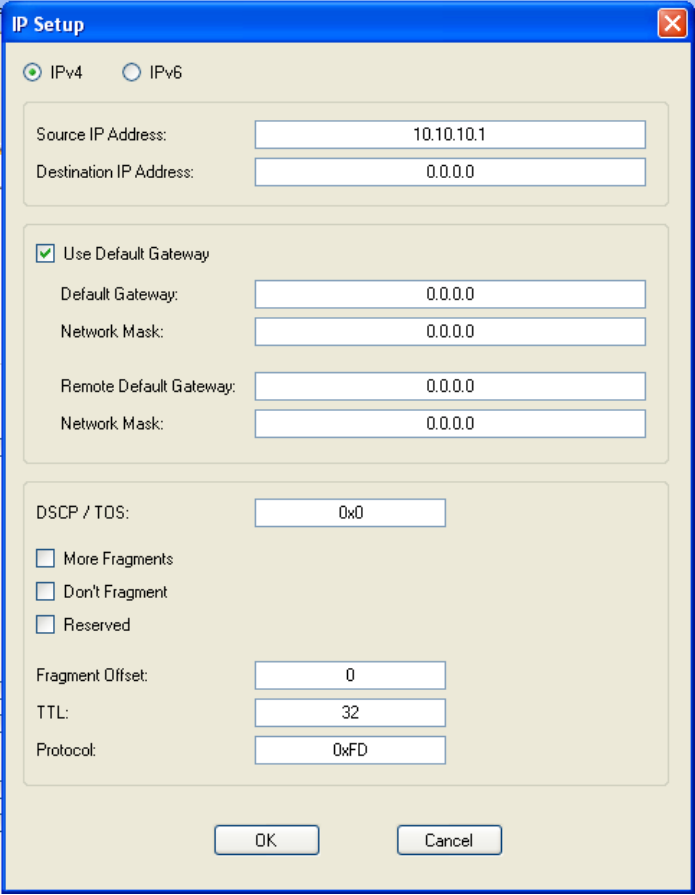
Table C.5.4.5-1 Service Table (Continued)

Field	Description	How To Edit
Frame Profile		<p>Click on the field. The Frame Profile pop-up dialog will be displayed</p>  <p>Click on the radio button to make the Frame Size selection. If Fixed Size is selected, use the pull-down list to select a frame size from the list. If User Defined is selected, enter the frame size in the field. If EMIX is selected, click on the input field. The EMIX letter code choices will be displayed. Enter up to five (5) letters shown. Click on the H=MTU field. Enter the MTU frame size. Click on the U=User field. Enter the User frame size.</p>

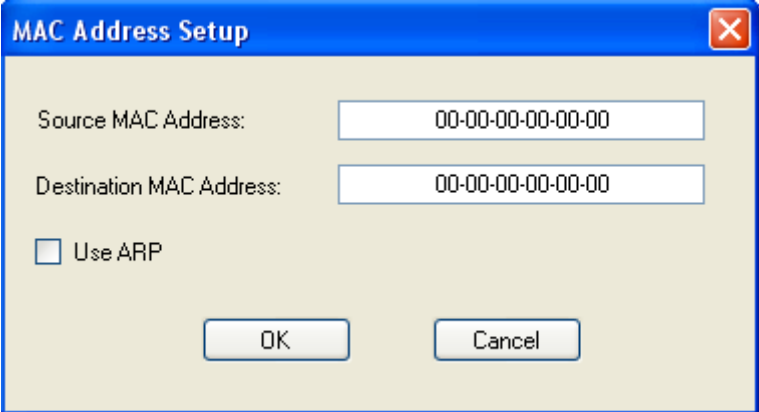
Table C.5.4.5-1 Service Table (Continued)

Field	Description	How To Edit
Payload Pattern	Binary pattern to be included in the un-used portion of the test frame payload.	<p>Click on the field. Make a selection from the pull-down list.</p> 
CBS(Bytes)	Committed burst size.	Click to highlight the field. Enter the value directly in the field.
EBS(Bytes)	Excess burst size.	Click to highlight the field. Enter the value directly in the field.
Max FTD(ms)	Maximum Frame Transfer Delay (Latency) Threshold	Click to highlight the field. Enter the value directly in the field.
Max FDV(ms)	Maximum Frame Delay Variation(Jitter) Threshold	Click to highlight the field. Enter the value directly in the field.
Max FLR(PPM)	Maximum Frame Loss Ratio Threshold	Click to highlight the field. Enter the value directly in the field.

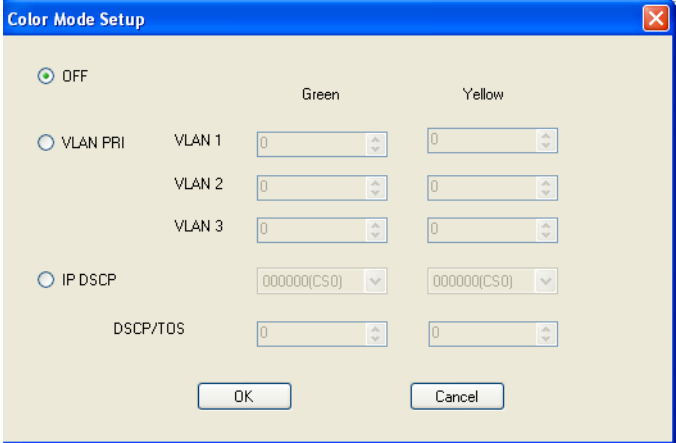
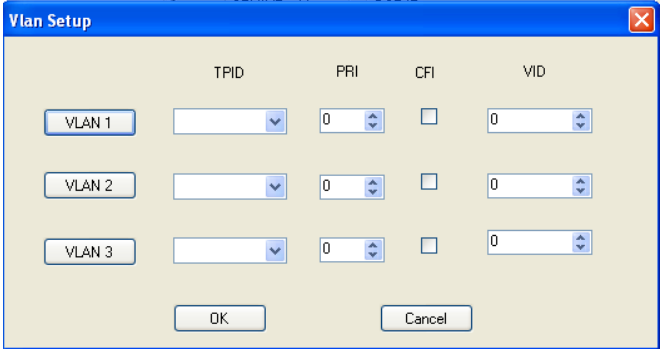
Table C.5.4.5-1 Service Table (Continued)

Field	Description	How To Edit
MPLS		<p>Click on the field. The MPLS pop-up dialog will be displayed</p> <p>Note: if the MPLS option is disabled, no MPLS columns will be available for selection.</p>  <p>Click on the MPLSx button to enable the MPLS label for level x. Use the dial-control to enter the LABEL value. Use the dial-control to select the CoS value. Use the dial-control to set the TTL value.</p>

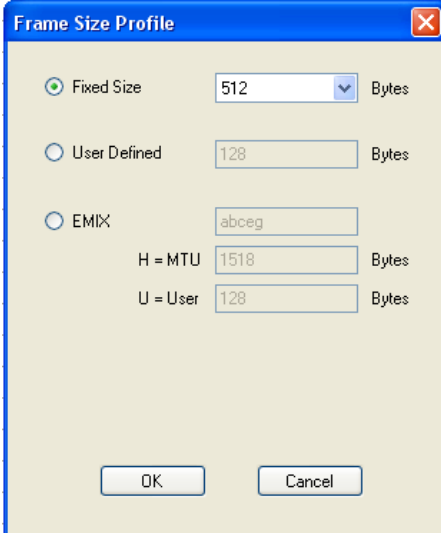
Table C.5.4.5-1 Service Table (Continued)

Field	Description	How To Edit
TCP		<p>Click on the field. The TCP/UDP pop-up dialog will be displayed.</p> <div data-bbox="807 562 1302 1234" style="border: 1px solid black; padding: 10px; margin: 10px auto; width: fit-content;"> </div> <p>Click on the TCP radio-button to select the TCP protocol to be included in the test frames. Click on each field and enter the value directly in the field.</p>

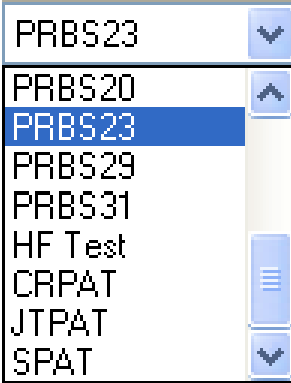
Table C.5.4.5-1 Service Table (Continued)

Field	Description	How To Edit
UDP		<p>Click on the field. The TCP/UDP pop-up dialog will be displayed.</p>  <p>Click on the UDP radio-button to select the UDP protocol to be included in the test frames. Click on each field and enter the value directly in the field.</p>
LLC1		Click on the check-box to enable (√) or disable (un-√) the LLC1 frame header.
SNAP		Click on the check-box to enable (√) or disable (un-√) the SNAP frame header.

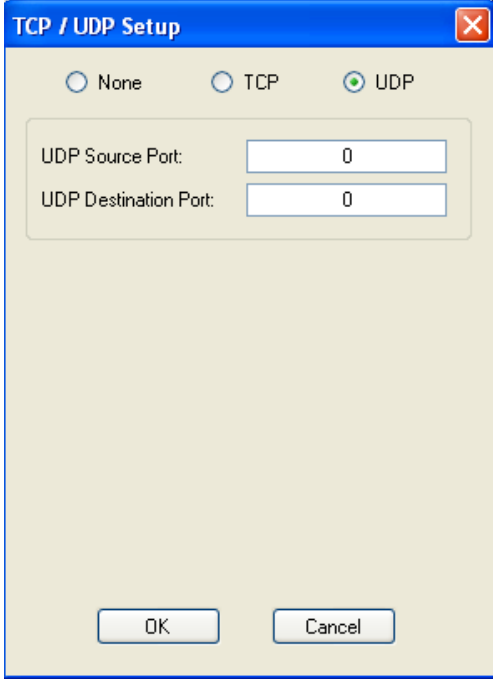
C.6 Copy/Paste Functions

The copy/paste function follows standard Windows Copy/Paste selection methods. In the row-selector column of the Y1564 or Port A/B Test setup (as indicated by the RED colored rectangle in the image below), click on the starting row of the selection to be copied.

SRV#	Enable	Service Name	Service Profile	CIR (Mbps)	EIR (Mbps)	SRC IP
1	<input type="checkbox"/>	Service	OFF	1	0	0.0.0.0
2	<input type="checkbox"/>	Service	OFF	1	0	0.0.0.0
3	<input type="checkbox"/>	Service	OFF	1	0	0.0.0.0
4	<input type="checkbox"/>	Service	OFF	1	0	0.0.0.0
5	<input type="checkbox"/>	Service	OFF	1	0	0.0.0.0
6	<input type="checkbox"/>	Service	OFF	1	0	0.0.0.0
7	<input type="checkbox"/>	Service	OFF	1	0	0.0.0.0
8	<input type="checkbox"/>	Service	OFF	1	0	0.0.0.0
9	<input type="checkbox"/>	Service	OFF	1	0	0.0.0.0
10	<input type="checkbox"/>	Service	OFF	1	0	0.0.0.0
11	<input type="checkbox"/>	Service	OFF	1	0	0.0.0.0
12	<input type="checkbox"/>	Service	OFF	1	0	0.0.0.0
13	<input type="checkbox"/>	Service	OFF	1	0	0.0.0.0
14	<input type="checkbox"/>	Service	OFF	1	0	0.0.0.0
15	<input type="checkbox"/>	Service	OFF	1	0	0.0.0.0
16	<input type="checkbox"/>	Service	OFF	1	0	0.0.0.0
17	<input type="checkbox"/>	Service	OFF	1	0	0.0.0.0

To select a contiguous set of rows, hold the left-mouse button down and drag the mouse pointer to the last row of the selection to be copied.

SRV#	Enable	Service Name	Service Profile	CIR (Mbps)	EIR (Mbps)	SRC IP	DST IP
1	<input checked="" type="checkbox"/>	Service	OFF	1	66	0.0.0.0	0.0.0.0
2	<input checked="" type="checkbox"/>	Service	OFF	2	0	0.0.0.0	0.0.0.0
3	<input checked="" type="checkbox"/>	Service	OFF	3	0	0.0.0.0	0.0.0.0
4	<input checked="" type="checkbox"/>	Service	OFF	4	0	0.0.0.0	0.0.0.0
5	<input checked="" type="checkbox"/>	hkhkj	OFF	5	0	0.0.0.0	0.0.0.0
6	<input checked="" type="checkbox"/>	Service	OFF	6	0	0.0.0.0	0.0.0.0
7	<input checked="" type="checkbox"/>	Service	OFF	7	0	0.0.0.0	0.0.0.0
8	<input checked="" type="checkbox"/>	Service	OFF	8	0	0.0.0.0	0.0.0.0
9	<input checked="" type="checkbox"/>	Service	OFF	9	0	0.0.0.0	0.0.0.0
10	<input checked="" type="checkbox"/>	Service	OFF	10	0	0.0.0.0	0.0.0.0

To select additional individual rows, hold the CTRL key down and click on each individual row to be copied.

Click on the Edit menu and select the Copy Row(s) item. Release the mouse button to complete the Copy operation.

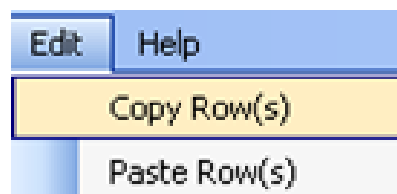

Note:

To copy rows from one port to the other port, change ports by clicking on the Port tabs.

In the **row-selector column**, **click-and-hold** the **left-mouse button** on the starting row of the selection for the Paste operation. Drag the mouse pointer to ending row of the selection for the Paste operation. Release the mouse button.

20	<input type="checkbox"/>	Service	DEF	1	66	0.00.0	0.00.0
21	<input type="checkbox"/>	Service	DEF	2	0	0.00.0	0.00.0
22	<input type="checkbox"/>	Service	DEF	3	0	0.00.0	0.00.0
23	<input type="checkbox"/>	Service	DEF	4	0	0.00.0	0.00.0
24	<input type="checkbox"/>	hkhkqj	DEF	5	0	0.00.0	0.00.0
25	<input type="checkbox"/>	Service	DEF	6	0	0.00.0	0.00.0
26	<input type="checkbox"/>	Service	DEF	7	0	0.00.0	0.00.0
27	<input type="checkbox"/>	Service	DEF	8	0	0.00.0	0.00.0
28	<input type="checkbox"/>	Service	DEF	9	0	0.00.0	0.00.0
29	<input type="checkbox"/>	Service	DEF	10	0	0.00.0	0.00.0

Click on the Edit menu and select the Paste Row(s) item. Release the mouse button to complete the Paste operation.

Notes:

- If the number of rows from the copy selection area is larger than the number of rows in the paste selection area, the excess rows will not be pasted.
- Each individual row from the copy selection area will be pasted into the first available row in the paste selection area. The rows in the copy selection area do not need to align with rows in the paste selection areas.
- If a copy and paste operation is executed on the same port, then the selection ranges should not overlap.
- If the copy selection area includes only one line, this line will be duplicated into all lines in the paste selection area.
- The Interface setup and Report setup pages will not allow you to use the copy/paste options and will instead display a popup.

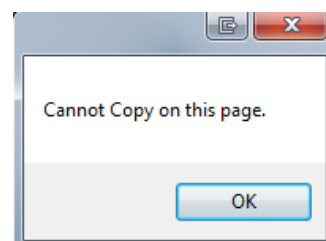

C.7 Input Validation

Many of the input fields must be validated at run-time. If a field is not valid for the current test configuration the user will be notified when the test is started. Any invalid fields can be modified on the instrument at run-time.

Appendix D Software Licenses

The MT9090A and MU909060A1/MU909060A2/MU909060A3 include the software listed in the table below. These software are not covered by the Anritsu Software License Agreement.

The details of each software license can be accessed at the following URL:

<https://www1.anritsu.co.jp/Download/Mservice/Login.asp>

D.1	Software Licenses	D-2
-----	-------------------------	-----

D.1 Software Licenses

Table D.1-1 Software Licenses

Package name	License	Remarks
linux-2.6.20.1	GPL ^(*1)	
busybox	GPL ^(*1)	
e2fsprogs	GPL ^(*1)	
sys5utils	GPL ^(*1)	
util-linux	GPL ^(*1)	
inetutils 1.5	GPL ^(*1)	
freetype 2.1.7	FTL ^(*2) , GPL ^(*1)	
mtd-utils	GPL ^(*1)	
U-Boot 1.1.4	GPL ^(*1)	
Microwindows	MPL ^(*3)	Microwindows was downloaded from CVS on 2 Aug 2006.
flnx 0.18	LGPL + exceptions ^(*4)	
dosfstools 2.11	GPL ^(*1)	
portman 5 beta	Other ^(*5)	
Haru Free PDF Library	zlib/libpng License	
Libpng	zlib/libpng License	
Tinyxml	zlib/libpng License	
Zlib	zlib/libpng License	
Lwip	BSD License	

References are to page numbers.

A

- AC Charger/Adapter 1-17
- Accumulate repeated steps
 - RFC2544..... 3-98
- Advanced pane
 - RFC2544 Burst 3-93
 - RFC2544 Latency 3-90
 - RFC2544 Throughput..... 3-84
- Alarms pop-up 3-66
- Amp
 - Cable Test..... 3-77
- Anritsu Corporation Contact..... xiii
- Anritsu Warranty xii
- Answers ARP requests 3-27
- Answers pings 3-27
- Arrow keys 1-9
- Average 3-58

B

- Back Panel 1-10
- Basic 2-43
- Basic tab 2-22
- Battery Status LED 1-20
- BBM file 6-2
- BERT Seq. Error 3-68
- Binary
 - RFC2544 Throughput..... 3-83
- BKSP soft key 2-19
- Bottom Panel 1-15
- Broadcast 2-31
- Burst Size pane
 - RFC2544 Burst 3-93
- Burst*1E-2..... 3-67
- Burst/10Sec..... 3-67
- Burst/Sec..... 3-67

C

- Calibration..... 7-6
- CFI (Canonical Format Indicator) 3-8
- Changing Test Module 1-29

- Channel Stats results screen..... 3-59
- Channel Stats setup pane
 - Generator 3-47
- Cleaning Optical Connectors 1-22
- Collisions..... 2-32
- Comment..... 2-44
- Control..... 3-10
- Count..... 3-58

D

- Destination pane
 - Generator 3-43
 - Ping Test..... 3-70
 - RFC2544 Burst 3-92
 - RFC2544 Latency 3-88
- DF (Don't fragment) 3-16
- Disposal..... 7-7
- DNS Setup 3-14
- DSAP (Destination Service Access Points) 3-10
- DSCP/TOS 3-15
- Duration pane
 - RFC2544 Burst 3-92
 - RFC2544 Latency 3-88
 - RFC2544 Throughput..... 3-81

E

- End to End Network Test
 - RFC2544 Throughput..... 3-79
- End-to-End setup
 - RFC2544 Throughput..... 3-80
- Equipment Certificate..... xii
- Error Burst Length 3-67
- Error Symbol 3-68
- Errors/Violations pop-up 3-67
- ETH tab..... 2-23
- Event Log
 - Pass Through 5-7
- Event Log tab..... 2-30

F

- Fail

Index

Cable Test..... 3-77
FCS..... 3-68
FCS (Frame Check Sequence) Errors 2-32
Filter Tab 3-20
Flow Control 3-6
Flow Label 3-17
Forcibly Power Down 2-3
Format Drives During Installation 6-3
Fragmented 2-32
Fragmented IP..... 3-68
Frame Loss 3-56, 3-65
Frame Loss 3-64
Frame Loss (%)..... 3-56
Frame Loss Seconds..... 3-65
Frame Size pane
 RFC2544 Burst 3-92
 RFC2544 Latency 3-88
 RFC2544 Throughput..... 3-82
Front Panel..... 1-6

G

Gateway Setup 3-15
Generator setup pane..... 3-41

H

Hop Limit..... 3-17
HTTP download test 3-104
HTTP/FTP download test 3-100

I

IFG 3-68
IFG violations 2-32
Include Comment 2-43
Include Error Log 2-43
Include Setup..... 2-43
Intelligent Setup 2-40
Interface setup..... 2-40
IP Checksum..... 3-68
IP tab..... 2-24
IPv4 setup pane..... 3-13
IPv6 setup pane..... 3-17

J

Jumbo Frame
 RFC2544 Latency 3-88

K

Key1 Label 3-62

L

Last Frame Received..... 3-58
Layer 4 Checksum..... 3-68
Line Load pane
 RFC2544 Latency 3-89
 RFC2544 Throughput..... 3-83
Line Load setup pane 3-40
Load Results 2-39
Load Setup..... 2-35
Logo 2-43, 2-45

M

Maintenance 7-6
Mass Storage 2-13
Max..... 3-58
Menu/Power key 1-9
Messages
 FTP and HTTP Processing..... 3-106
MF 3-16
Min 3-58
Mode/Duration pane
 Generator Test 3-38
Move test..... 3-32
MPLS..... 3-23
Multicast 2-31

N

Next Header..... 3-17
Next Tab
 Ethernet 3-5
Ni-MH Battery Pack 1-12
No Link 3-68
Normal
 Cable Test..... 3-77

O	
Open	
Cable Test.....	3-77
Optical Fiber Cables	1-27
Option	1-3
OUI	3-11
Oversized	2-32
P	
Panel Keys	1-8
Path.....	2-45
Pattern Bit Count.....	3-65
Pattern Bit Rate (Mbps)	3-65
Pattern Errors	3-64, 3-65
Pattern Errors(%).....	3-65
PAUSE frames.....	3-68
PDF report	2-42
ping results	3-74
polarity	
Cable Test.....	3-77
Port	
Pass Through	5-3
Reflector	4-4
Port Button	4-3
PRBS Bit Error.....	3-68
Preamble.....	3-68
Preamble violations.....	2-32
Print Screen.....	2-7, 2-20
R	
Receivers/Transceivers.....	2-43
Rechargeable battery pack	1-11
Reflector	4-1
Re-Install Controller	6-3
Remote Fault	3-68
Remove test	3-32
Rename	2-19
Repetition	
RFC2544.....	3-95
Replaceable batteries	1-11
RES	3-16
Result	
Pass Through	5-6
Reflector.....	4-7
Result overview	2-27
Result overview screen.....	2-27
Result screen	
Reflector.....	4-7
Result soft key	2-27
Round trip time	3-74
Router Latency Test	
RFC2544 Latency	3-87
Rx Frame Loss Avg	
RFC2544.....	3-96, 3-98
Rx Frame Loss Max	
RFC2544.....	3-96, 3-98
Rx Frame Loss Min	
RFC2544.....	3-96, 3-98
Rx Jitter Avg	
RFC2544.....	3-97
Rx Jitter Max	
RFC2544.....	3-97
Rx Jitter Min	
RFC2544.....	3-97
Rx Latency Avg	
RFC2544.....	3-97
Rx Latency Max	
RFC2544.....	3-97
Rx Latency Min	
RFC2544.....	3-97
Rx Loss Rate Avg(%)	
RFC2544.....	3-96
Rx Loss Rate Max(%)	
RFC2544.....	3-96
Rx Loss Rate Min(%)	
RFC2544.....	3-96
Rx Throughput(Mbps)	
RFC2544.....	3-96
Rx Total Frames	
RFC2544.....	3-96
Rx Utilization(%)	
RFC2544.....	3-96
S	
Save Results.....	2-36

Index

Save Setup	2-33	Stream 1 - 8	
screen dump.....	2-20	Ethernet	3-5
SDT (Service Disruption Time) setup pane		Summary	
Generator	3-45	Ping.....	3-74
SDT Threshold	3-58	Summary screen.....	2-28
Self Diagnostics	7-2	Summary soft key.....	2-29
Seq. Errors.....	3-64, 3-65	Switch Router Test	
Seq. Sync. Lost	3-64, 3-65	RFC2544 Latency	3-87
Set key.....	1-9	RFC2544 Throughput.....	3-79
Setup		T	
PDF Reports.....	2-43	Temperature Monitoring.....	2-4
Setup Interface		Test Automator	3-29
Pass Through	5-3	Test Mode pane	
Reflector	4-3	RFC2544 Burst	3-92
Setup soft key	2-27	RFC2544 Latency	3-87
Severe IFG violations.....	2-32	RFC2544 Throughput.....	3-79
SFP tab	2-25	Test Repetitions	
Shipment.....	7-6	RFC2544 Throughput.....	3-81
Short		Test schedule.....	3-29
Cable Test.....	3-77	Test setup	2-40, 3-32
Single Ended Network Test		Testing	
RFC2544 Latency	3-87	Pass Through	5-5
RFC2544 Throughput.....	3-79	Threshold setup pane	
Skew		Generator	3-44
Cable Test.....	3-77	Tolerance Level	
Smart		RFC2544 Latency	3-90
RFC2544 Throughput.....	3-83	Top Bar	2-25
Soft keys.....	1-7	Top Connector Panel	1-16
Source MAC	3-7	Top Menu.....	2-5
SSAP (Source Service Access Points)	3-10	Total.....	2-31, 3-58
Standard Configuration	1-2	Total SDT (%).....	3-58
Start key	1-8	Total Test Time	3-58
Statistics		Trace Route Results	3-109
Pass Through	5-7	Trace Route test.....	3-107
Statistics tab.....	2-31	Traffic Class	3-17
Status		Tx Burst Size	
Pass Through	5-2	RFC2544.....	3-98
Reflector	4-2	Tx Frame Rate(Fps)	
Status screen		RFC2544.....	3-96
Ethernet	3-3	Tx Frame Size(bytes)	
Step		RFC2544.....	3-96
RFC2544.....	3-95		

Tx Total Frames		Unframed	3-64
RFC2544.....	3-96	Unicast	2-31
Tx Utilization(Mbps)		Unit pane	
RFC2544.....	3-96	Generator Test	3-36
TX,RX Broadcast Frames	3-56	Updating Firmware.....	6-2
TX,RX Errored Frames	3-56	USB (Type A) port	1-24
TX,RX Throughput (%)	3-56	USB (Type B) port	1-26
TX,RX Throughput (Mbps)	3-56	Use anonymous.....	3-102
TX,RX Total Bits.....	3-56	V	
TX,RX Total Frames.....	3-56	VLAN Setup Pane	3-8
TX,RX Utilization (%)	3-56	W	
U		Wildcard	3-20
Undersized	2-32		

