

**MS9740B**  
**Optical Spectrum Analyzer**  
**SCPI Remote Control**  
**Operation Manual**

**Second Edition**

- For safety and warning information, please read this manual before attempting to use the equipment.
- Additional safety and warning information is provided within the MS9740B Spectrum Analyzer Operation Manual. Please also refer to it before using the equipment.
- Keep this manual with the equipment.

**ANRITSU CORPORATION**

# Safety Symbols

To prevent the risk of personal injury or loss related to equipment malfunction, Anritsu Corporation uses the following safety symbols to indicate safety-related information. Ensure that you clearly understand the meanings of the symbols BEFORE using the equipment. Some or all of the following symbols may be used on all Anritsu equipment. In addition, there may be other labels attached to products that are not shown in the diagrams in this manual.

## Symbols used in manual

 **DANGER** This indicates a very dangerous procedure that could result in serious injury or death if not performed properly.

 **WARNING** This indicates a hazardous procedure that could result in serious injury or death if not performed properly.

 **CAUTION** This indicates a hazardous procedure or danger that could result in light-to-severe injury, or loss related to equipment malfunction, if proper precautions are not taken.

## Safety Symbols Used on Equipment and in Manual

The following safety symbols are used inside or on the equipment near operation locations to provide information about safety items and operation precautions. Ensure that you clearly understand the meanings of the symbols and take the necessary precautions BEFORE using the equipment.



This indicates a prohibited operation. The prohibited operation is indicated symbolically in or near the barred circle.



This indicates an obligatory safety precaution. The obligatory operation is indicated symbolically in or near the circle.



This indicates a warning or caution. The contents are indicated symbolically in or near the triangle.



This indicates a note. The contents are described in the box.



These indicate that the marked part should be recycled.

MS9740B  
Optical Spectrum Analyzer  
SCPI Remote Control Operation Manual

9 April 2019 (First Edition)  
7 October 2020 (Second Edition)

Copyright © 2019-2020, ANRITSU CORPORATION.

All rights reserved. No part of this manual may be reproduced without the prior written permission of the publisher.

The operational instructions of this manual may be changed without prior notice.

Printed in Japan

## Notes On Export Management

---

This product and its manuals may require an Export License/Approval by the Government of the product's country of origin for re-export from your country.

Before re-exporting the product or manuals, please contact us to confirm whether they are export-controlled items or not.

When you dispose of export-controlled items, the products/manuals need to be broken/shredded so as not to be unlawfully used for military purpose.



# About This Manual

This operation manual how to perform remote control of the MS9740B Optical Spectrum Analyzer.

This operation manual assumes that:

- the reader has already read the *MS9740B Optical Spectrum Analyzer Operation Manual* and the *MS9740B Optical Spectrum Analyzer Remote Control Operation Manual*.

Refer to the *MS9740B Optical Spectrum Analyzer (M-W3998AE)* for how to connect the power and peripheral equipment, for the panel operations, and the maintenance procedures.

This manual consists of the following chapters and appendix:

## Chapter 1 Outline

This chapter describes an overview of remote control using SCPI commands.

## Chapter 2 Before Use

This chapter contains the following information you should read before performing remote control of MS9740B: how to perform setup of MS9740B, how to connect cables, message format, register structure, and synchronous control.

## Chapter 3 Message Details

This chapter explains the SCPI command messages and rules.

## Appendix A Message Codes

This appendix describes error codes and their meanings.

# Table of Contents

<b>About This Manual.....</b>	<b>I</b>
<b>Chapter 1 Outline.....</b>	<b>1-1</b>
1.1 SCPI Remote Control .....	1-2
1.2 Message Format.....	1-2
<b>Chapter 2 Before Use .....</b>	<b>2-1</b>
2.1 Preparing Equipment .....	2-2
2.2 Connecting Equipment .....	2-4
2.3 Setting Interface.....	2-7
2.4 Checking Connection.....	2-12
2.5 Message Format.....	2-14
2.6 Checking Instrument Status.....	2-16
2.7 Controlling Message Sync.....	2-24
<b>Chapter 3 Message Details .....</b>	<b>3-1</b>
3.1 Rules for Describing Messages .....	3-2
3.2 Correspondence between Panel Operation and Message .....	3-3
3.3 Message Function Category.....	3-22
3.4 Device Message Details .....	3-26
<b>Appendix A Message Codes.....</b>	<b>A-1</b>
<b>Index .....</b>	<b>Index-1</b>

# Table of Commands

*CLS [Clear Status] .....	3-26
*ESE [Event Status Enable] .....	3-27
*ESR [Standard Event Status Register] .....	3-28
*IDN [Identification] .....	3-28
*OPC [Operation Complete] .....	3-28
*OPT [Option Identification Query] .....	3-29
*RST [Reset] .....	3-30
*SRE [Service Request Enable] .....	3-30
*STB [Status Byte] .....	3-31
*TST [Self-Test Query] .....	3-31
*WAI [Wait to Continue] .....	3-31
:ABORt .....	3-32
:CALCulate[1 2 3 4 5 6]:AVERAge:COUNT .....	3-37
:CALCulate[1 2 3 4 5 6]:AVERAge[:STATe] .....	3-38
:CALCulate:CATegory .....	3-39
:CALCulate[1 2 3 4 5 6]:CENTermass[:DATA]? .....	3-40
:CALCulate[1 2 3 4 5 6]:CENTermass:STATe .....	3-40
:CALCulate:DATA? .....	3-41
:CALCulate:DATA:ANAR? .....	3-47
:CALCulate:DATA:APR? .....	3-49
:CALCulate:DATA:APR:AMTBI? .....	3-56
:CALCulate:DATA:APR:DFBNdw? .....	3-57
:CALCulate:DATA:APR:LDNDw? .....	3-58
:CALCulate:DATA:APR:LDSBco? .....	3-58
:CALCulate:DATA:APR:LDSNr? .....	3-60
:CALCulate:DATA:APR:MPKC? .....	3-61
:CALCulate:DATA:APR:WMPK? .....	3-61
:CALCulate:DATA:APR:WREL? .....	3-62
:CALCulate:DATA:APR:WSGav? .....	3-63
:CALCulate:DATA:APR:WSNR? .....	3-64
:CALCulate:DATA:APR:WTBL? .....	3-65
:CALCulate:DATA:CGAin? .....	3-66
:CALCulate:DATA:CNF? .....	3-66
:CALCulate:DATA:CPOWers? .....	3-67
:CALCulate:DATA:CSNR? .....	3-67
:CALCulate:DATA:CWAVelengths? .....	3-68
:CALCulate:DATA:NCHannels? .....	3-68
:CALCulate[1 2 3 4 5 6]:FWHM[:DATA]? .....	3-69
:CALCulate[1 2 3 4 5 6]:FWHM:STATe .....	3-69
:CALCulate:LMARker:AOFF .....	3-70
:CALCulate:LMARker:X .....	3-70

1
2
3
Appendix
Index

:CALCulate:LMARker:Y .....	3-71
:CALCulate:MARker:AOff .....	3-71
:CALCulate:MARker[1 2 3 4]:FUNction:DELta[:STATe] .....	3-72
:CALCulate:MARker[1 2 3 4]:FUNction:DELta:X:OFFSet? .....	3-73
:CALCulate:MARker[1 2 3 4]:FUNction:DELta:X:OFFSet:FREQuency .....	3-74
:CALCulate:MARker[1 2 3 4]:FUNction:DELta:X:OFFSet[:WAVelength] .....	3-74
:CALCulate:MARker[1 2 3 4]:FUNction:DELta:X:READout .....	3-76
:CALCulate:MARker[1 2 3 4]:FUNction:DELta:X:REFerence? .....	3-77
:CALCulate:MARker:FUNction:DELta:XY .....	3-78
:CALCulate:MARker[1 2 3 4]:FUNction:DELta:Y:OFFSet? .....	3-79
:CALCulate:MARker[1 2 3 4]:FUNction:DELta:Y:REFerence? .....	3-79
:CALCulate:MARker[1 2 3 4]:MAXimum .....	3-80
:CALCulate:MARker[1 2 3 4]:MAXimum:LEFT .....	3-80
:CALCulate:MARker[1 2 3 4]:MAXimum:NEXT .....	3-80
:CALCulate:MARker[1 2 3 4]:MAXimum:RIGHT .....	3-81
:CALCulate:MARker:MAXimum:SCENter .....	3-81
:CALCulate:MARker:MAXimum:SRLevel .....	3-81
:CALCulate:MARker:MAXimum:SZCenter .....	3-81
:CALCulate:MARker[1 2 3 4]:MINimum .....	3-82
:CALCulate:MARker[1 2 3 4]:MINimum:LEFT .....	3-82
:CALCulate:MARker[1 2 3 4]:MINimum:NEXT .....	3-82
:CALCulate:MARker[1 2 3 4]:MINimum:RIGHT .....	3-83
:CALCulate:MARker[1 2 3 4]:PEXCursion[:PEAK] .....	3-83
:CALCulate:MARker[1 2 3 4]:PEXCursion:PIT .....	3-84
:CALCulate:MARker:PP:DATA? .....	3-85
:CALCulate:MARker:PP[:STATe] .....	3-85
:CALCulate:MARker[1 2 3 4][:STATe] .....	3-86
:CALCulate:MARker:TMK:DATA .....	3-87
:CALCulate:MARker[1 2 3 4]:TRACe .....	3-88
:CALCulate:MARker:UNIT .....	3-89
:CALCulate:MARker[1 2 3 4]:X:FREQuency .....	3-90
:CALCulate:MARker[1 2 3 4]:X:READout .....	3-91
:CALCulate:MARker[1 2 3 4]:X[:WAVelength] .....	3-92
:CALCulate:MARker[1 2 3 4]:Y? .....	3-93
:CALCulate:MARker:ZONE:ERACe .....	3-93
:CALCulate:MARker:ZONE:SPAN .....	3-93
:CALCulate:MARker:ZONE:WAVelength .....	3-94
:CALCulate:MARker:ZONE:ZOOM .....	3-95
:CALCulate[1 2 3 4 5 6]:MATH[:EXPRession][:DEFine] .....	3-96
:CALCulate[1 2 3 4 5 6]:MATH:STATe .....	3-97
:CALCulate:MATH:TRC .....	3-97
:CALCulate:MATH:TRF .....	3-98
:CALCulate:MATH:TRG .....	3-99
:CALCulate:MATH:TRX:NORMalize .....	3-100



:CALCulate[1 2 3 4 5 6]:MAXimum[:STATe].....	3-100
:CALCulate[1 2 3 4 5 6]:MINimum[:STATe].....	3-101
:CALCulate:OFFSet:AMPLifier.....	3-102
:CALCulate:OFFSet:SOURce.....	3-103
:CALCulate:PARAmeter[:CATegory]:AMP:MSElect.....	3-104
:CALCulate:PARAmeter[:CATegory]:AMP:PARAmeter.....	3-104
:CALCulate:PARAmeter[:CATegory]:AMP:PASE.....	3-107
:CALCulate:PARAmeter[:CATegory]:AMP:PIN.....	3-108
:CALCulate:PARAmeter[:CATegory]:AMP:POUT.....	3-108
:CALCulate:PARAmeter[:CATegory]:AMP:RESCalibrate.....	3-109
:CALCulate:PARAmeter[:CATegory]:DFBLd.....	3-110
:CALCulate:PARAmeter[:CATegory]:DFBLd:SRES.....	3-111
:CALCulate:PARAmeter[:CATegory]:FP.....	3-112
:CALCulate:PARAmeter[:CATegory]:LD:AREA.....	3-113
:CALCulate:PARAmeter[:CATegory]:LD:K.....	3-113
:CALCulate:PARAmeter[:CATegory]:LD:NACHannel.....	3-114
:CALCulate:PARAmeter[:CATegory]:LD:NAFunction.....	3-115
:CALCulate:PARAmeter[:CATegory]:LD:NAUSer.....	3-116
:CALCulate:PARAmeter[:CATegory]:LD:NDBWidth.....	3-117
:CALCulate:PARAmeter[:CATegory]:LD:NNORmalize.....	3-118
:CALCulate:PARAmeter[:CATegory]:LD:NOISe.....	3-119
:CALCulate:PARAmeter[:CATegory]:LD:NPOSITION.....	3-120
:CALCulate:PARAmeter[:CATegory]:LD:POINT.....	3-121
:CALCulate:PARAmeter[:CATegory]:LD:SGLevel.....	3-122
:CALCulate:PARAmeter[:CATegory]:LD:SGSelect.....	3-123
:CALCulate:PARAmeter[:CATegory]:LD:SGWavelength.....	3-124
:CALCulate:PARAmeter[:CATegory]:LD:SMSR.....	3-125
:CALCulate:PARAmeter[:CATegory]:LD:SRES.....	3-126
:CALCulate:PARAmeter[:CATegory]:LD:THReshold.....	3-127
:CALCulate:PARAmeter[:CATegory]:LED.....	3-128
:CALCulate:PARAmeter[:CATegory]:NDB.....	3-129
:CALCulate:PARAmeter[:CATegory]:NF:AALGo.....	3-130
:CALCulate:PARAmeter[:CATegory]:NF:AREA.....	3-131
:CALCulate:PARAmeter[:CATegory]:NF:ASE.....	3-132
:CALCulate:PARAmeter[:CATegory]:NF:FALGo.....	3-133
:CALCulate:PARAmeter[:CATegory]:NF:FARea.....	3-134
:CALCulate:PARAmeter[:CATegory]:NF:IOFFset.....	3-134
:CALCulate:PARAmeter[:CATegory]:NF:MARea.....	3-135
:CALCulate:PARAmeter[:CATegory]:NF:MDIFF.....	3-136
:CALCulate:PARAmeter[:CATegory]:NF:MSElect.....	3-136
:CALCulate:PARAmeter[:CATegory]:NF:OBPF.....	3-137
:CALCulate:PARAmeter[:CATegory]:NF:OOffset.....	3-138
:CALCulate:PARAmeter[:CATegory]:NF:PARAmeter.....	3-139
:CALCulate:PARAmeter[:CATegory]:NF:PDISplay.....	3-141

:CALCulate:PARAmeter[:CATegory]:NF:PIN .....	3-141
:CALCulate:PARAmeter[:CATegory]:NF:POUT .....	3-142
:CALCulate:PARAmeter[:CATegory]:NF:RBWidth .....	3-142
:CALCulate:PARAmeter[:CATegory]:NF:SNOise .....	3-143
:CALCulate:PARAmeter[:CATegory]:NF:TH .....	3-144
:CALCulate:PARAmeter[:CATegory]:NF:WDETECT .....	3-145
:CALCulate:PARAmeter[:CATegory]:PMD .....	3-146
:CALCulate:PARAmeter[:CATegory]:POWER:OFFSet .....	3-147
:CALCulate:PARAmeter[:CATegory]:SMSR .....	3-148
:CALCulate:PARAmeter[:CATegory]:SWENvelope:TH1 .....	3-148
:CALCulate:PARAmeter[:CATegory]:SWPKrms .....	3-149
:CALCulate:PARAmeter[:CATegory]:SWPKrms:TH .....	3-150
:CALCulate:PARAmeter[:CATegory]:SWTHresh:TH .....	3-151
:CALCulate:PARAmeter[:CATegory]:WDM:AREA .....	3-152
:CALCulate:PARAmeter[:CATegory]:WDM:DTYPE .....	3-152
:CALCulate:PARAmeter[:CATegory]:WDM:FALGo .....	3-154
:CALCulate:PARAmeter[:CATegory]:WDM:MARea .....	3-155
:CALCulate:PARAmeter[:CATegory]:WDM:NACHannel .....	3-156
:CALCulate:PARAmeter[:CATegory]:WDM:NAFunction .....	3-157
:CALCulate:PARAmeter[:CATegory]:WDM:NARea .....	3-158
:CALCulate:PARAmeter[:CATegory]:WDM:NAUSer .....	3-159
:CALCulate:PARAmeter[:CATegory]:WDM:NBW .....	3-160
:CALCulate:PARAmeter[:CATegory]:WDM:NNORMALize .....	3-160
:CALCulate:PARAmeter[:CATegory]:WDM:PDISplay .....	3-161
:CALCulate:PARAmeter[:CATegory]:WDM:PEXCursion .....	3-162
:CALCulate:PARAmeter[:CATegory]:WDM:POINT .....	3-163
:CALCulate:PARAmeter[:CATegory]:WDM:SGLevel .....	3-164
:CALCulate:PARAmeter[:CATegory]:WDM:SGWavelength .....	3-165
:CALCulate:PARAmeter[:CATegory]:WDM:SLICE .....	3-166
:CALCulate:PARAmeter[:CATegory]:WDM:SPOWER .....	3-167
:CALCulate:PARAmeter[:CATegory]:WDM:TH .....	3-168
:CALCulate:PARAmeter[:CATegory]:WFIL:BANDwidth .....	3-169
:CALCulate:PARAmeter[:CATegory]:WFIL:PEXCursion .....	3-170
:CALCulate:PARAmeter[:CATegory]:WFIL:RIPPLE .....	3-171
:CALCulate:PARAmeter[:CATegory]:WFIL:SGLevel .....	3-172
:CALCulate:PARAmeter[:CATegory]:WFIL:SGWavelength .....	3-173
:CALCulate:PARAmeter[:CATegory]:WFIL:SLICE .....	3-173
:CALCulate:PARAmeter[:CATegory]:WFIL:TCL .....	3-174
:CALCulate:PEXCursion[:PEAK] .....	3-175
:CALCulate[1 2 3 4 5 6]:SIGMA[:DATA]? .....	3-175
:CALCulate:SNOise .....	3-176
:CALCulate[1 2 3 4 5 6]:SOURCE[:DATA]? .....	3-177
:CALCulate:SOURCE:FUNCTION:BWIDth BANDwidth:NDB .....	3-179
:CALCulate[1 2 3 4 5 6]:SOURCE:TEST .....	3-180

:CALCulate:THReshold .....	3-181
:CALCulate[1 2 3 4 5 6]:TPOWer[:DATA]?.....	3-181
:CALCulate[1 2 3 4 5 6]:TPOWer:STATe .....	3-182
:CALibration:ACTRes .....	3-183
:CALibration:ACTRes:DATA?.....	3-184
:CALibration:ALIG[:IMMEDIATE] .....	3-184
:CALibration:ALIGNment.....	3-185
:CALibration:ALIGNment:PRESet.....	3-185
:CALibration:AUTOalign:ENABLE .....	3-186
:CALibration:PRESet .....	3-186
:CALibration:RESCal .....	3-186
:CALibration:WAVelength:EXTernal[:IMMEDIATE].....	3-187
:CALibration:WAVelength[:EXTernal][:NORMAl] .....	3-188
:CALibration:WAVelength:INTernal[:IMMEDIATE].....	3-189
:CALibration:WAVelength:INTernal[:NORMAl].....	3-190
:CALibration:ZCAL.....	3-191
:CALibration:ZERO[:AUTO] .....	3-192
:DISPlay:WINDow:SYSTem.....	3-194
:DISPlay[:WINDow[1]]:TEXT:CLEAr .....	3-195
:DISPlay[:WINDow[1]]:TEXT:DATA .....	3-195
:DISPlay[:WINDow[1]]:TRACe:ALL[:SCALe][:AUTO].....	3-196
:DISPlay[:WINDow[1]]:TRACe[:STATe] .....	3-196
:DISPlay[:WINDow]:TRACe:X[:SCALe]:CENTer.....	3-197
:DISPlay[:WINDow]:TRACe:X[:SCALe]:SPAN.....	3-198
:DISPlay[:WINDow]:TRACe:X[:SCALe]:START.....	3-199
:DISPlay[:WINDow]:TRACe:X[:SCALe]:STOP .....	3-200
:DISPlay[:WINDow[1]]:TRACe:Y:SCALe:LINear.....	3-200
:DISPlay[:WINDow[1]]:TRACe:Y[1 2][:SCALe]:PDIVision .....	3-201
:DISPlay[:WINDow[1]]:TRACe:Y[1 2][:SCALe]:RLEVel.....	3-202
:DISPlay[:WINDow[1]]:TRACe:Y[1 2][:SCALe]:SPACing.....	3-203
:DISPlay[:WINDow]:TRACe:Y1[:SCALe]:BLEVel.....	3-204
:DISPlay[:WINDow]:TRACe:Y1[:SCALe]:UNIT .....	3-205
:FORMat[:DATA].....	3-206
:FORMat:DELimiter .....	3-207
:INITiate:CONTInuous.....	3-208
:INITiate[:IMMEDIATE] .....	3-208
:INITiate:IMMEDIATE:SEQuence[1 2].....	3-209
:INITiate:POWer:DATA?.....	3-209
:INITiate:POWer:OFF .....	3-209
:INITiate:POWer:WAVelength.....	3-210
:INITiate:SMODE .....	3-210
:INITiate:SMODE:STATe? .....	3-211
:INSTrument:SELEct.....	3-212
:MMEMory:CATalog? .....	3-214

:MMEMory:COpy:CSV .....	3-215
:MMEMory:COpy:GRAPhics .....	3-215
:MMEMory:COpy:SYSinfo .....	3-216
:MMEMory:COpy:XML .....	3-216
:MMEMory:DATA .....	3-217
:MMEMory:DElete .....	3-218
:MMEMory:DElete:SYSinfo .....	3-218
:MMEMory:LOAD:ATRACE .....	3-219
:MMEMory:LOAD:SETTING .....	3-220
:MMEMory:LOAD:TRACe .....	3-220
:MMEMory:MOVE:CSV .....	3-221
:MMEMory:MOVE:GRAPhics .....	3-222
:MMEMory:MOVE:SYSinfo .....	3-222
:MMEMory:MOVE:XML .....	3-223
:MMEMory:PROTECT:CSV .....	3-224
:MMEMory:PROTECT:GRAPhics .....	3-225
:MMEMory:PROTECT:SYSinfo .....	3-226
:MMEMory:PROTECT:XML .....	3-226
:MMEMory:STORE:ATRACE .....	3-227
:MMEMory:STORE:COLOR .....	3-228
:MMEMory:STORE:GRAPhics .....	3-229
:MMEMory:STORE:GRAPhics:BINary? .....	3-230
:MMEMory:STORE:GRAPhics:TYPE .....	3-231
:MMEMory:STORE:SETTING .....	3-231
:MMEMory:STORE:TRACe .....	3-232
:SENSe:ATT[:STATe] .....	3-234
:SENSe:AVERAge:COUNT .....	3-234
[:SENSe]:BANDwidth BWIDth[:RESolution] .....	3-235
[:SENSe]:BANDwidth BWIDth:VIDeo .....	3-236
[:SENSe]:CHOP[:STATe] .....	3-236
:SENSe:CHOPper .....	3-237
:SENSe:CORRection:LEVel:SHIFt .....	3-238
[:SENSe]:CORRection:RVELocity:MEDIum .....	3-239
:SENSe:CORRection:WAVElength:SHIFt .....	3-239
:SENSe:SETTING:MMMode .....	3-240
:SENSe:SETTING:SMOoth .....	3-240
[:SENSe]:SWEep:POINTs .....	3-241
:SENSe:SWEep:TIME:INTerval .....	3-241
[:SENSe][:WAVElength]:CENTer .....	3-242
[:SENSe][:WAVElength]:OFFSet .....	3-243
[:SENSe][:WAVElength]:SPAN .....	3-244
[:SENSe][:WAVElength]:SPAN:FULL .....	3-244
[:SENSe][:WAVElength]:START .....	3-245
[:SENSe][:WAVElength]:STOP .....	3-246

:SOURce:STATe 'EELED1550' .....	3-247
:STATus:EVENT:CONDition? .....	3-248
:STATus:EVENT:ENABLE .....	3-248
:STATus:EVENT:ERRor:CONDition? .....	3-249
:STATus:EVENT:ERRor:ENABLE .....	3-249
:SYSTem:BUZZer .....	3-250
:SYSTem:ERRor[:NEXT]? .....	3-250
:SYSTem:INFormation? .....	3-251
:SYSTem:PRESet .....	3-251
:SYSTem:SOFTware:VERSion? .....	3-252
:TRACe:ACTive .....	3-253
:TRACe:ATTRibute[:<trace_name> TRG] .....	3-254
:TRACe:ATTRibute:RAVG[:<trace_name>] .....	3-255
:TRACe[:DATA]:SNUMber? .....	3-255
:TRACe[:DATA]:X:START? .....	3-256
:TRACe[:DATA]:X:STOP? .....	3-256
:TRACe[:DATA]:X[:WAVelength]:SSTop .....	3-257
:TRACe[:DATA][:Y]? .....	3-258
:TRACe[:DATA][:Y]:DCA DCB DCC DCD DCE DCF DCG DCH DCI DCJ? .....	3-259
:TRACe[:DATA][:Y]:DMA DMB DMC DMD DME DMF DMG DMH DMI DMJ? .....	3-260
:TRACe:DELete .....	3-261
:TRACe:DELete:EOV .....	3-261
:TRACe:FEED:CONTRol .....	3-261
:TRACe:POINts .....	3-262
:TRACe:STATe[:<trace_name> TRG] .....	3-262
:TRACe:STORage .....	3-263
:TRIGger[:SEQUence]:DELay .....	3-264
:TRIGger[:SEQUence]:SOURce .....	3-265
:TRIGger[:SEQUence]:STATe .....	3-265
:UNIT:POWer .....	3-266



# Chapter 1 Outline

---

This chapter provides an overview of SCPI commands.

1.1	SCPI Remote Control .....	1-2
1.2	Message Format.....	1-2

1

Outline

## 1.1 SCPI Remote Control

SCPI (Standard Commands for Programmable Instruments) is a standard concerning the command syntax and data structure of remote control commands developed for measuring instruments.

The MS9740B Optical Spectrum Analyzer provides command messages that conform to the SCPI standard syntax. However, it does not support the status registers and required command messages that are specified in the SCPI standard.

## 1.2 Message Format

For general description of messages, refer to 2.5, “Message Format” in the *MS9740B Optical Spectrum Analyzer Remote Control Operation Manual*.

SCPI messages have a hierarchical structure separated by colons as shown in the following example. Lowercase characters and sequences of characters enclosed in square brackets can be omitted. The behavior of MS9740B is the same between the following messages:

```
:DISPlay[:WINDow]:TRACe:X[:SCALe]:STOP  
:DISP:TRAC:X:STOP
```

A query command has the question symbol (?) appended to the string.

Example:

```
:DISPlay[:WINDow]:TRACe:X[:SCALe]:CENTer?  
:SYSTem:INFormation?
```



## Chapter 2 Before Use

---

This chapter explains the preparations for using remote control.

2.1	Preparing Equipment .....	2-2
2.2	Connecting Equipment.....	2-4
2.2.1	Connecting Ethernet .....	2-4
2.2.2	Connecting GPIB .....	2-5
2.3	Setting Interface.....	2-7
2.3.1	Setting Ethernet .....	2-7
2.3.2	Setting GPIB .....	2-11
2.4	Checking Connection .....	2-12
2.4.1	When using Ethernet:.....	2-12
2.4.2	When using GPIB.....	2-13
2.5	Message Format.....	2-14
2.6	Checking Instrument Status .....	2-16
2.6.1	Register Structure .....	2-16
2.6.2	Status Byte Register .....	2-18
2.6.3	Event Register .....	2-19
2.7	Controlling Message Sync.....	2-24

## 2.1 Preparing Equipment

The following MS9740B is required to perform remote control.

- PC
- Ethernet interface
- Ethernet cable
- GPIB interface (when installing Option 001)
- GPIB cable (when installing Option 001)
- VISA
- Program development tools

### Ethernet Interface

Prepare the interface that conforms to the following specifications:

10BASE-T

100BASE-TX

1000BASE-T

Furthermore, use the cable corresponding to each specification.

### GPIB Interface

Procure the GPIB interfaces that conform with IEEE 488.2.

### VISA

When controlling the MS9740B remotely using the Ethernet port, a VISA<sup>\*1</sup> driver must be installed in the PC controller. We recommend using NI-VISA<sup>TM\*2</sup> from National Instruments<sup>TM</sup> (NI hereafter) as the VISA driver.

Although a license is generally required to use NI-VISA<sup>TM</sup>, the licensed NI-VISA<sup>TM</sup> driver is provided free-of-charge for use when performing remote control<sup>\*1,\*2</sup> of a MS9740B unit in which the MS9740B-001 GPIB option has been installed.

The NI-VISA<sup>TM</sup> driver can be downloaded from the NI website at:

<http://sine.ni.com/psp/app/doc/p/id/psp-411>

Be sure to comply with the NI license agreement for the usage and license scope.

Be sure to uninstall the NI-VISA<sup>TM</sup> driver when disposing of the MS9740B or transferring it to a third party, etc., or when ceasing to use NI-VISA<sup>TM</sup>.

\*1: Although the NI-VISA<sup>TM</sup> driver itself can be downloaded free-of-charge from the web, an implementation license is required for legal reasons if some requirements are not met. (Check the NI web page for the detailed requirements.)

\*2: If these requirements are not met, permission is not granted to use NI hardware and software and an NI implementation license must be purchased. However, since the MS9740B-001 GPIB Interface incorporates NI hardware (GPIB ASIC), the NI-VISA™ driver can be used free-of-charge.

Glossary of Terms:

- VISA: Virtual Instrument Software Architecture  
I/O software specification for remote control of measuring instruments using interfaces such as GPIB, Ethernet, USB, etc.
- NI-VISA™  
World *de facto* standard I/O software interface developed by NI and standardized by the VXI Plug&Play Alliance.

Trademarks:

- National Instruments™, NI™, NI-VISA™ and National Instruments Corporation are all trademarks of National Instruments Corporation.

Program Development Tools

Prepare some tools for developing and running programs for performing remote control. Refer to the VISA and Interface manuals for the specifications required by the program development tools.

PC

The PC must be able to run the GPIB interface, VISA and program development tools.

## 2.2 Connecting Equipment

### 2.2.1 Connecting Ethernet

Connect the Ethernet connector on the rear-panel of the MS9740B and external devices using LAN cables.

Use a LAN crossover cable to connect the MS9740B and an external device. Use a network hub when connecting to multiple external devices.

**Note:**

Check the network settings of the MS9740B when connecting to multiple external devices

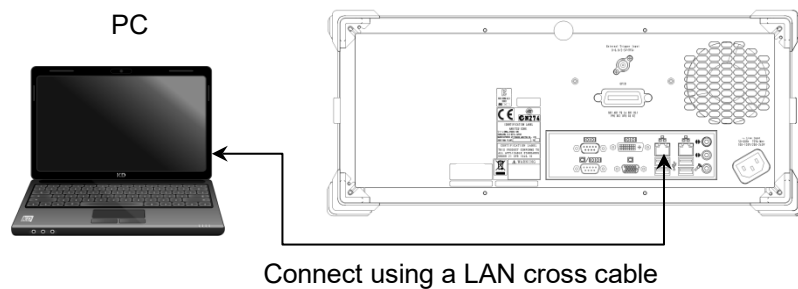

Figure 2.2.1-1 Sample Connection with One External Device

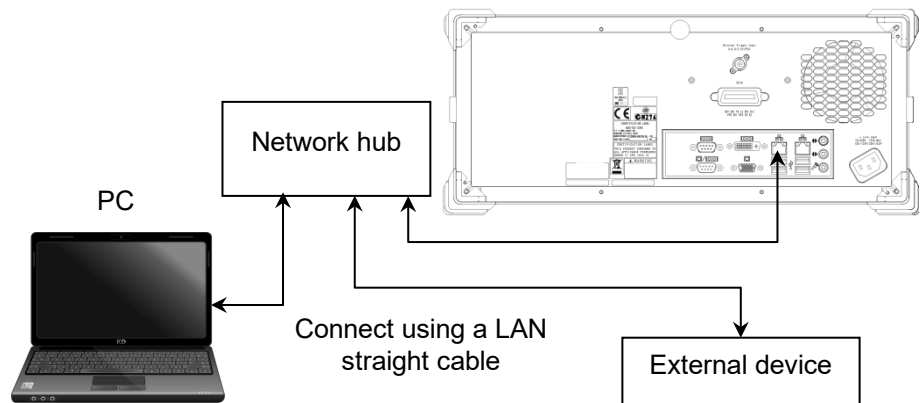

Figure 2.2.1-2 Sample Connection with Multiple External Devices

**Note:**

External devices may experience difficulty in communicating with the MS9740B, depending on the status of communications between them. A LAN crossover-cable connection is recommended to ensure communication stability.

## 2.2.2 Connecting GPIB

Connect the GPIB connector on the rear panel of the MS9740B and an external device using a GPIB cable.



### CAUTION

**Be sure to connect the GPIB cable before turning power on the MS9740B. Connecting it while the power is on may damage internal circuits.**

Up to 15 devices, including the external controller (PC), can be connected to one MS9740B unit. Be sure to abide by the conditions shown below when connecting devices.

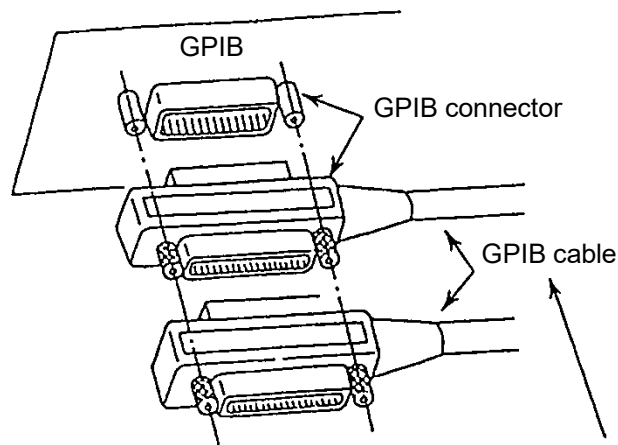

Total cable length:	Up to 20 m
Cable length between devices:	Up to 4 m
Number of devices that can be connected:	Up to 15

**Figure 2.2.2-1 GPIB Cable Connection 1**

Connect cables without forming loops.

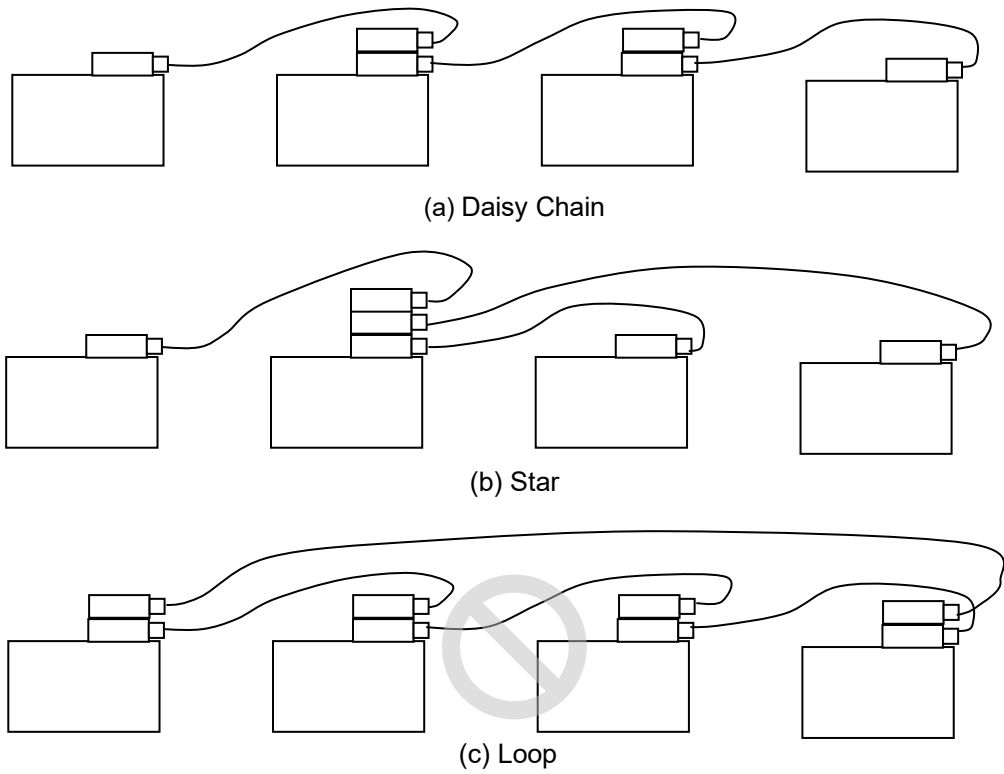

**Figure 2.2.2-2 GPIB Cable Connection 2**

## 2.3 Setting Interface

### 2.3.1 Setting Ethernet

Check the IP address and delimiter.

1. Press **F6** to display **Config** on the horizontal function keys.
2. Press **f1 Interface Setting**.
3. Open the dialog box to display the MS9740B address in the Ethernet setting IP address.
4. Set the terminator.  
Select “CR/LF,” “LF,” or “None (EOI only)” for Terminator in the Terminator Settings field.

The terminator indicates the end of the sent command.

- CR/LF: When two characters, ASCII code 13 (carriage return—CR) and 10 (line feed—LF), received
- LF: When one character, ASCII code 10 (line feed) , received
- EOI: When signal received from GPIB signal line (End or Identity)

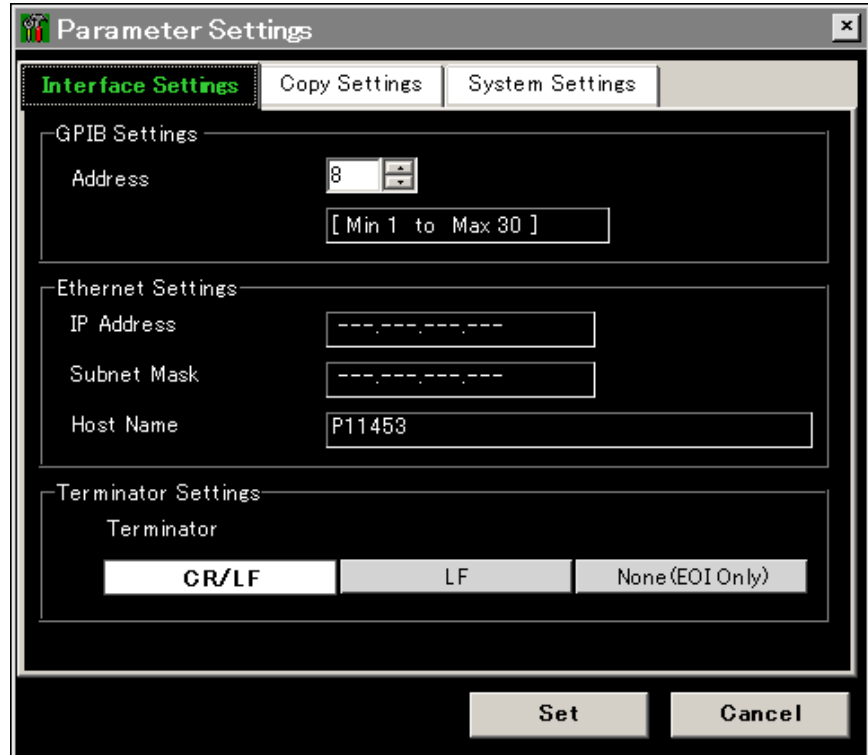

Figure 2.3.1-1 Interface Settings Dialog Box

Connect a keyboard to the MS9740B, when changing the IP address.

When the OS is WES7

1. Press the Windows key on the connected keyboard.
2. Click **Control Panel**.
3. The Control Panel window is displayed, and then click **Network and Sharing Center**.

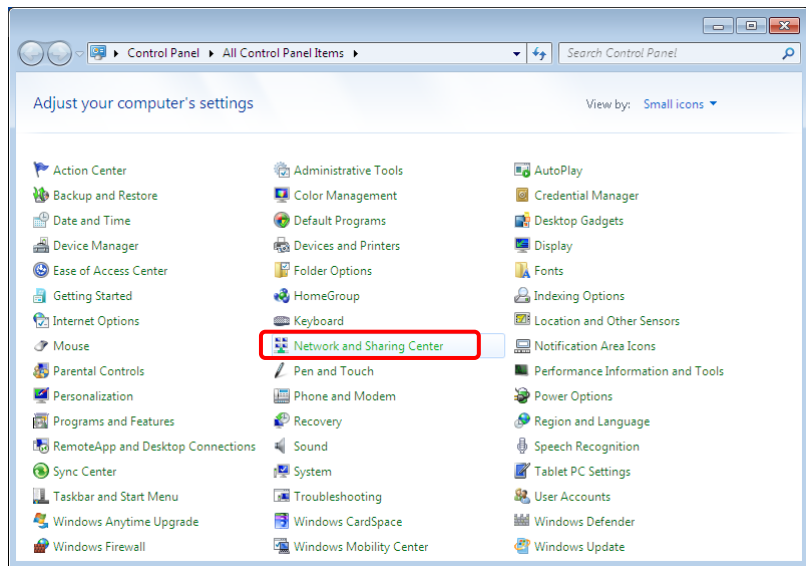

Figure 2.3.1-2 Control Panel Window

4. Click **Change adapter settings** on the **Network and Sharing Center**.

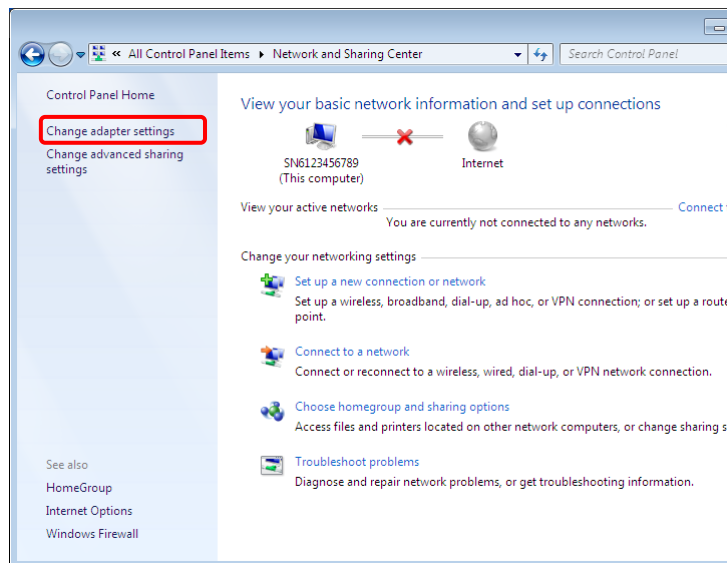

Figure 2.3.1-3 Network and Sharing Center Window



5. Right-click **Local Area Connection 2**, and then click **Properties**.

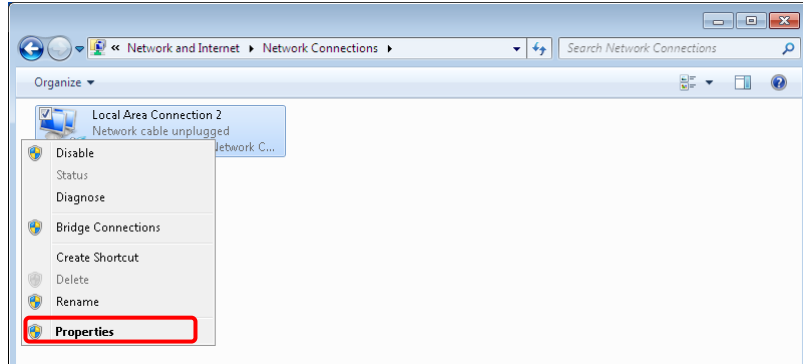

Figure 2.3.1-4 Network Connections Window

6. The Local Area Connection 2 Properties dialog box is displayed. On the list box, click **Internet Protocol Version 4 (TCP/IPv4)** and click **Properties**.

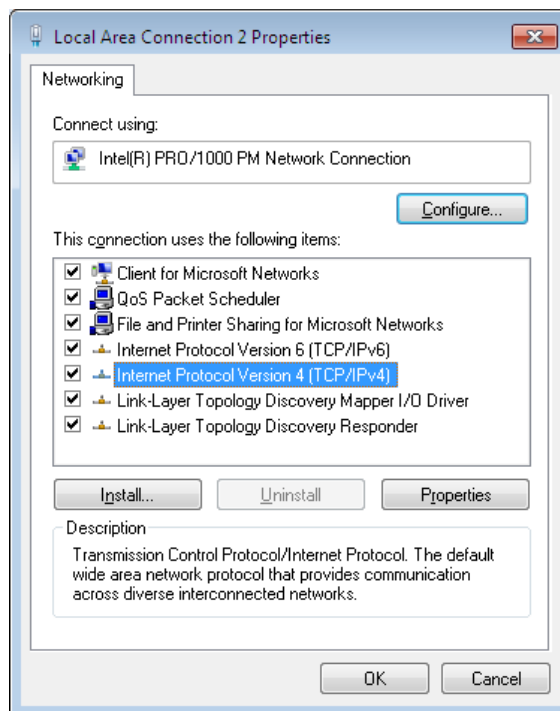
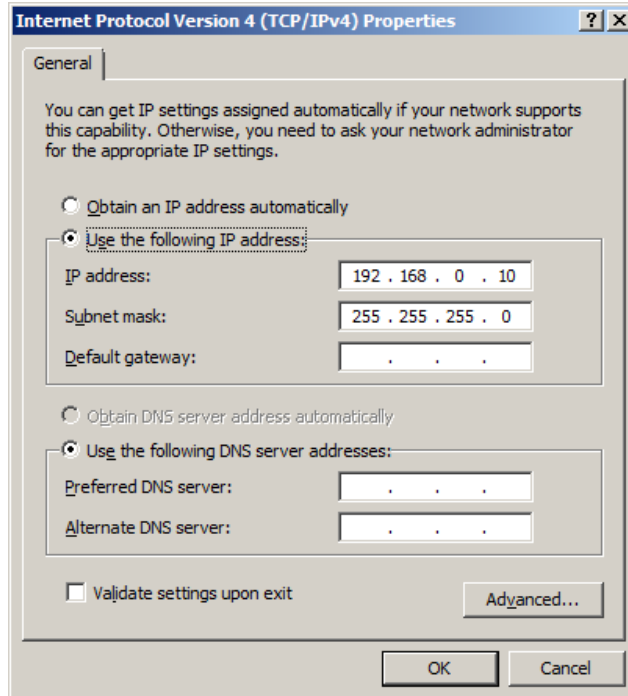

Figure 2.3.1-5 Local Area Connection 2 Properties Dialog Box

7. Select **Use the following IP address**.



**Figure 2.3.1-6 Internet Protocol Version 4 (TCP/IPv4) Properties Dialog Box**

8. Enter **IP address** and **Subnet mask**.  
When creating a program to control this instrument, the IP address input here is required.
9. Click **OK**.
10. Click **OK** on the **Local Area Connection 2 Properties**.

When the OS is Win10

1. On the connected keyboard, press the Windows key to display the Windows taskbar.
2. Right-click the **Start** (  ).
3. In the Start menu, click **Network Connections**.
4. In the Settings window, click **Ethernet** > **Change adapter options**.

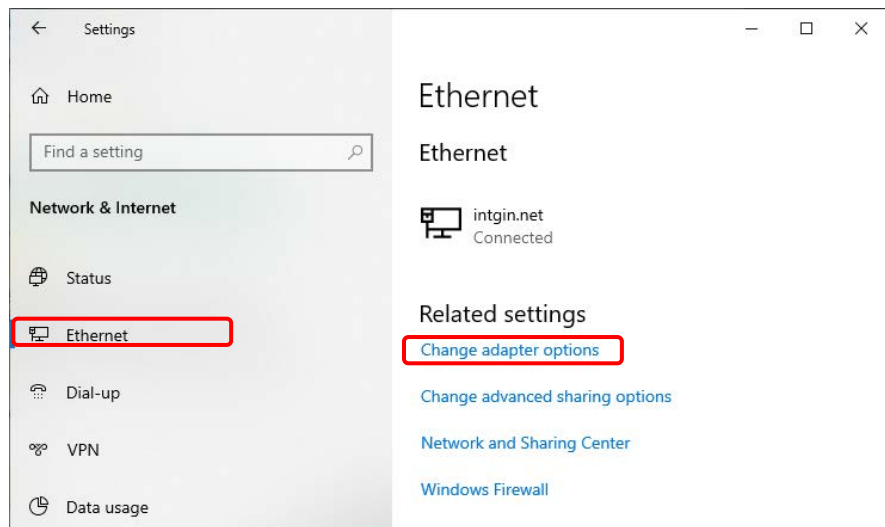

Figure 2.3.1-7 Settings Window

5. The subsequent steps are the same as for WES7.

## 2.3.2 Setting GPIB

Check the MS9740B GPIB address and delimiter with the following procedure.

1. Press **F6** to display Config on the horizontal function keys.
2. Press **f1 Interface Setting**.
3. Open the dialog box. The MS9740B address is displayed in the GPIB setting address.
4. Set the GPIB address in the range from 1 to 30 using the arrow keys or rotary knob.
5. Set the terminator of the response message.  
Select “CR/LF,” “LF,” or “None (EOI only)” for Terminator in the Terminator Settings field.

## 2.4 Checking Connection

Check that the link between the PC and MS9740B has been established.

### 2.4.1 When using Ethernet:

When the OS is WES7

1. Click **Programs** at the Windows Start menu.
2. Click **Accessories**.
3. Click **Command Prompt**.
4. Input ping and the MS9740B IP address at the command prompt screen.

Figure 2.4.1-1 shows how to set the IP address to 192.168.0.10.

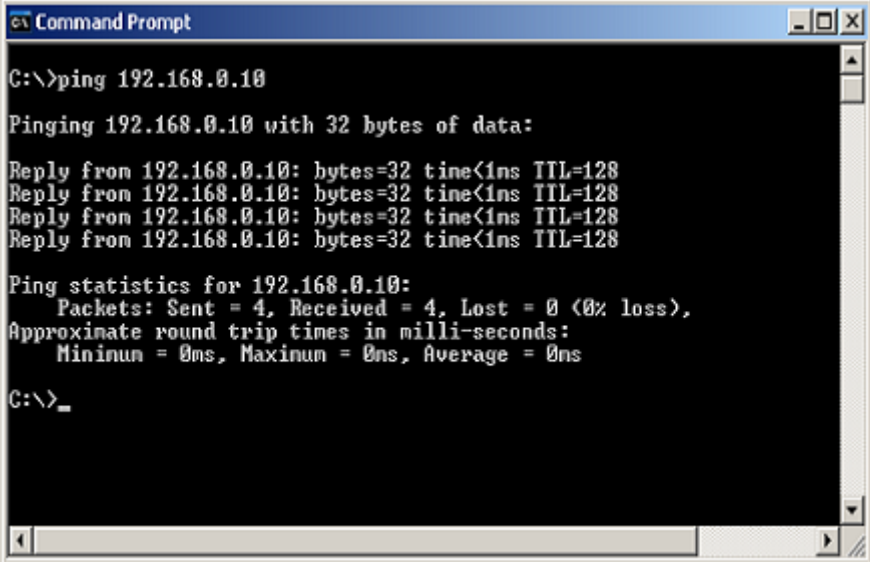

```
Command Prompt
C:\>ping 192.168.0.10

Pinging 192.168.0.10 with 32 bytes of data:

Reply from 192.168.0.10: bytes=32 time<1ms TTL=128
Reply from 192.168.0.10: bytes=32 time<1ms TTL=128
Reply from 192.168.0.10: bytes=32 time<1ms TTL=128
Reply from 192.168.0.10: bytes=32 time<1ms TTL=128

Ping statistics for 192.168.0.10:
    Packets: Sent = 4, Received = 4, Lost = 0 (0% loss),
    Approximate round trip times in milli-seconds:
        Minimum = 0ms, Maximum = 0ms, Average = 0ms

C:\>_
```

Figure 2.4.1-1 Example of Ping Command

5. If “Request timed out” message is displayed, the link between the PC and MS9740B has not been connected properly. Check that IP address is correct and cable is connected properly.

When the OS is Win10

1. Click the **Start** (Windows logo) to open the Start menu.
2. Click **Windows System Tools**.
3. Click **Command Prompt**.
4. The subsequent steps are the same as for WES7.

### 2.4.2 When using GPIB

1. Install the software supplied with the GPIB interface.
2. Start the software.  
For the software operation method, refer to the GPIB interface operation manual.
3. Confirm that the address for the displayed instrument is the same as the GPIB address set on the MS9740B.

## 2.5 Message Format

Messages are composed of character strings for executing commands and character strings indicating the message end. The later character strings are set in 2.3 “Setting Interface”.

Messages are composed of the following types:

### Program Messages

Messages sent from PC to instrument

These are composed of commands to set the instrument and queries requesting sending of a response message.

### Response Messages:

Messages sent from instrument to PC controller

These messages are composed of header and data parts separated by more than a half width space.

The header is composed of alphanumeric characters and underbars while the head string is alphabetic characters. However, common commands defined by IEEE 488.2 have an asterisk (\*) appended to the header string. Both upper and lower-case alphabetic characters are supported.

Command with only header:

```
*RST
:DISPlay:WINDow:TRACe:ALL
:INITate
:CALCulate:LMARker:AOFF
```

Command with header and data:

```
:DISPlay:TRACe:X:SPAN 10NM
:SENSe:AVERage:COUNT OFF
```

Messages with multiple data use commas (,) to separate the data parts.

Example:

```
:CALCulate:PARAmeter:WDM:NAFunction GAUSS,ON
:CALCulate:MARKer:ZONE:WAVelength 1310NM,20NM
```

Queries have a question mark (?) appended to the header.

Example:

```
:TRACe:DMA?
:CALCulate:DATA:APR:WMPK? 16
:CALCulate:LMARker:X? 1
```

When linking multiple program messages, separate the message using semicolons (;).

Example:

```
:DISPlay:TRACe:X:CENT 1550NM ; :INITate ; *WAI ; :TRACe:DMA?
```

The data format is character string data, numeric data, and binary data. String data is ASCII code enclosed in quotation marks.

An example of the program message when inputting Model ANR-005 at the title is shown below.

Example:

```
:DISPlay:TEXT:DATA 'Model ANR-005',
:DISPlay:TEXT:DATA "Model ANR-005"
```

When using numeric data, input numeric values either as integers or floating point representation. Each following example indicates the same value.

Example:

-90	-90.00	-9E1
1310	1310.0	1.31E3
0.0023	2.3E-4	

For the binary data, the head string starts with a sign (#) and continues with data after a numeric value indicating the data length.

The character after the sign (#) indicates the number of digits in the data length.

The binary data follows the number indicating the data length.

Example:

```
#4 2002 an%*qe4445+\
```

4 digits    2002 bytes of binary data

## 2.6 Checking Instrument Status

MS9740B has registers indicating the status, such as errors and command execution status. This section explains these registers.

### 2.6.1 Register Structure

Figure 2.6.1-1 shows the structure of the registers indicating the MS9740B status.

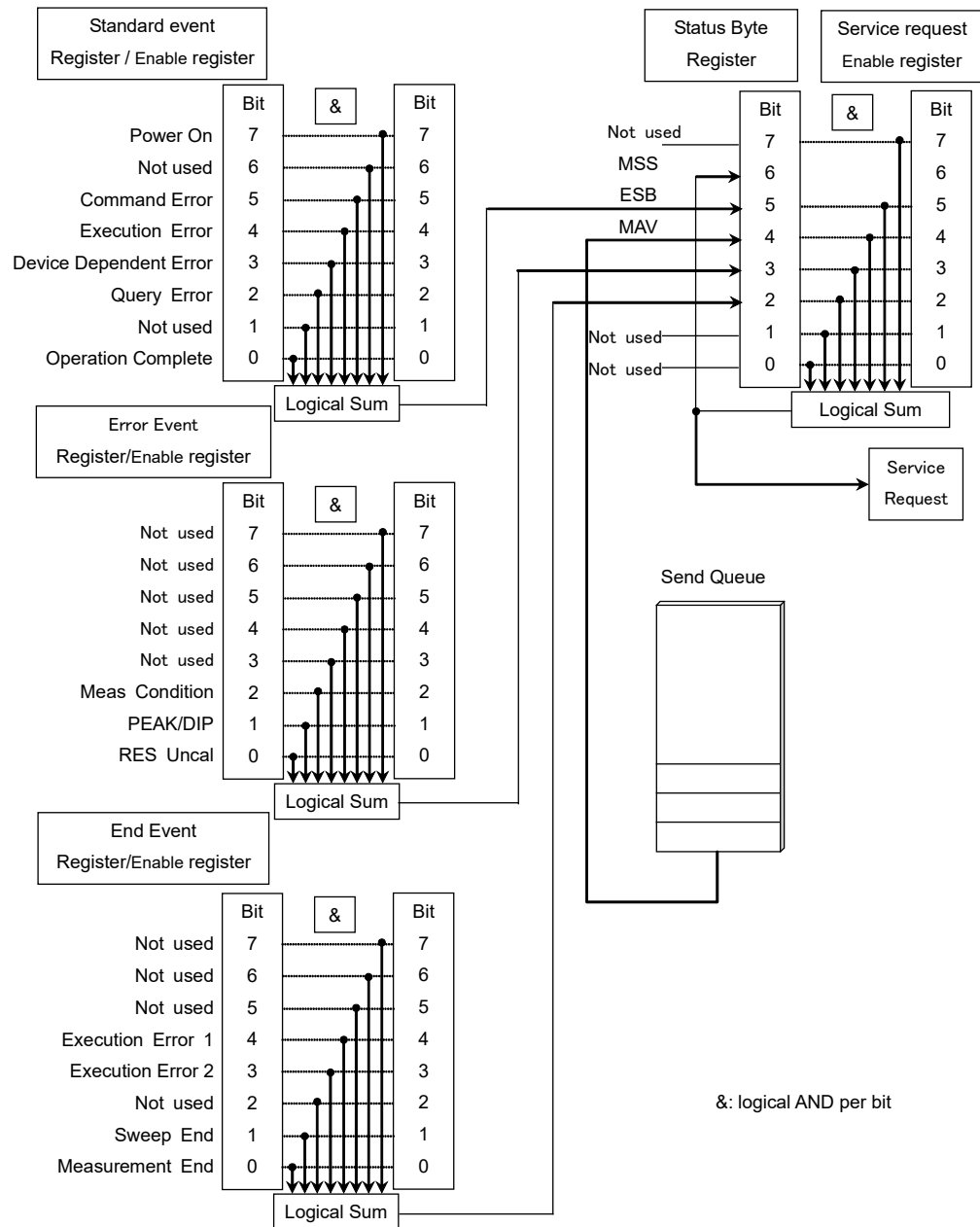

Figure 2.6.1-1 Register Structure



Each register uses 8-bit data. The register output values are the decimal totals for each bit shown in Figure 2.6.1-1.

**Table 2.6.1-1 Register Bit Decimal Conversion Values**

Bit	Decimal value
7	128
6	64
5	32
4	16
3	8
2	4
1	2
0	1

The service request enable register has a corresponding status byte register. The logical product per bit of these two registers is obtained and the logical sum of this result is output to the MSS (Master Summary Status) bit. When the MSS bit is 1, the data report to the PC controller is displayed on the MS9740B screen; when the MSS bit changes from 0 to 1, an interrupt is generated from MS9740B to the PC controller. This interrupt is called the service request.

Each standard event register (standard, error, end) has a corresponding enable register. The logical product per bit of the event and enable registers is obtained and the logical sum of this result is output to bit 5, 3 and 2 of the status byte register.

## 2.6.2 Status Byte Register

The meaning of each bit of the status byte register is shown in the following table.

**Table 2.6.2-1 Meaning of Status Byte Register**

Bit	Explanation
7	Not used; always 0
6	MSS (Master Summary Register) It is the logical sum of the bit 5 to 0, bit 7 logical product of the status byte register and the service request enable register.
5	This is the logical sum of each bit of the logical product of the standard event status register and standard event enable register.
4	MAV (Message Available summary) This is always 1 when there is a response message in the output queue of MS9740B
3	This is the logical sum of each bit of the logical product of the error event register and event enable register.
2	This is the logical sum of each bit of the logical product of the end event register and event enable register.
1	Not used; always 0
0	Not used; always 0

The following methods are used to read the status byte register.

- Using common `*STB?` command
- Using GPIB serial poll (when MS9740B-001 installed)

Read the GPIB interface manual for the serial poll method.

When using serial polling, even if bit 6 is 1, it becomes 0 after reading once.

The `*SRE` and `*SRE?` common commands can be used for setting and reading the service request enable register for setting reading of the status byte register. To output the status byte register data, set the bit corresponding to the service request enable register to 1.

Bits 5, 3, and 2 of the status byte register can be set to 0 using the `*CLS` common command.

When `*CLS` is sent after a command or when a query is sent after `*CLS`, the send queue is cleared and bit 4 is set to 0.

### 2.6.3 Event Register

#### Standard Event Status Register

The meaning of each bit of the standard event status register is listed in the table below.

**Table 2.6.3-1 Meaning of Standard Event Status Register**

Bit	Explanation
7	Power-on Becomes 1 at power-on and returns 0 when read.
6	Not used; always 0
5	Command Error Becomes 1 when received undefined program message, message that cannot executed according to syntax, or message with spelling error
4	Execution Error Becomes 1 when received program message that cannot be executed.
3	Device Dependent Error Becomes 1 at errors other than command, execution and query errors.
2	Query Error Becomes 1 when no data to read in output queue or output queue data fails for some reason.
1	Not used; always 0
0	Operation Complete Becomes 1 when all command operation completed after the *OPC command operation.

Bit 7 to bit 0 of the standard event register can be read by the \*ESR? command. The standard event register returns to 0 when read.

The standard event register enable register can be set and read using the \*ESE and \*ESE? commands. To output standard event register data, set the bit corresponding to the enable register to 1.

The standard event register can be set to 0 using the \*CLS command.

End Event Register

The meaning of each bit of the end event status register is listed in the table below.

**Table 2.6.3-2 Meaning of End Event Status Register**

Bit	Explanation
7	Not used; always 0
6	Not used; always 0
5	Not used; always 0
4	End Execution 1 Becomes 1 when calibrating wavelength of resolution and adjusting optical system operations completed.
3	End Execution 2 Becomes 1 when sweep averaging or measuring with power monitor operations completed.
2	Not used; always 0
1	Sweep end Become 1 when sweeping completed.
0	Measurement end Becomes 1 when one of the following commands has been processed: Auto Measurement, analysis using Analysis function, Peak/Dip Search processing, analysis using Application function. To execute multiple commands, send :STATus:EVENT:CONDition? for each command to query end event register.

The commands for checking the completion of end event register execution are shown below.

**Table 2.6.3-3 Commands for Checking End Event Register Execution**

End Event Register Bit	Command
4	:CALCulate:PARAmeter[:CATegory]:AMP:RESCalibrate, :CALibration:ALIGNment, :CALibration:ALIG[:IMMediate], :CALibration:RESCal :CALibration:WAVelength:EXTernal[:IMMediate], :CALibration:WAVelength[:EXTernal][:NORMal], :CALibration:WAVelength:INTernal[:IMMediate], :CALibration:WAVelength:INTernal[:NORMal], :CALibration:ZCAL
3	:INITiate:POWer:WAVelength, :INITiate[:IMMediate] :INITiate:IMMediate:SEQuence[1 2]
1	:INITiate[:IMMediate] :INITiate:IMMediate:SEQuence[1 2]
0	:CALCulate:CATegory :CALCulate[1 2 3 4 5 6]:CENTermass:[DATA]? :CALCulate[1 2 3 4 5 6]:CENTermass:STATE :CALCulate[1 2 3 4 5 6]:FWHM[:DATA]? :CALCulate[1 2 3 4 5 6]:FWHM:STATE :CALCulate[1 2 3 4 5 6]:SIGMa:[DATA]? :CALCulate[1 2 3 4 5 6]:SOURce:TEST :CALCulate[1 2 3 4 5 6]:TPOWer[:DATA]? :CALCulate[1 2 3 4 5 6]:TPOWer:STATE :CALCulate:MARKer[1 2 3 4]:MAXimum, :CALCulate:MARKer[1 2 3 4]:MAXimum:LEFT, :CALCulate:MARKer[1 2 3 4]:MAXimum:NEXT, :CALCulate:MARKer[1 2 3 4]:MAXimum:RIGHT, :CALCulate:MARKer[1 2 3 4]:MINimum, :CALCulate:MARKer[1 2 3 4]:MINimum:LEFT, :CALCulate:MARKer[1 2 3 4]:MINimum:NEXT, :CALCulate:MARKer[1 2 3 4]:MINimum:RIGHT :CALCulate:MARKer:PP[:STATE] :CALCulate:OFFSet:SOURce :CALCulate:PARAmeter[:CATegory] :CALCulate:PEXCursion[:PEAK] :CALCulate:THReshold :CALCulate:SNOise :CALCulate:SOURce:FUNCTion:BWIDth   BANDwidth:NDB :DISPlay[:WINDow[1]]:TRACe:ALL[:SCALe][:AUTO], :INSTrument:SELect

2

Before Use

The end event register can be read by the :STATus:EVENT:CONDition?.  
The end event register enable register can be set and read using  
the :STATus:EVENT:ENABle and :STATus:EVENT:ENABle? commands.

To output end event register data, set the bit corresponding to the enable register to 1.

The end event register can be set to 0 using the \*CLS command.

The enable register of the end event register cannot be changed using \*CLS.

#### Error Event Register

The meaning of each bit of the error event status register is listed in the table below.

**Table 2.6.3-4 Meaning of Error Event Status Register**

Bit	Explanation
7	Not used; always 0
6	Not used; always 0
5	Not used; always 0
4	Not used; always 0
3	Not used; always 0
2	Meas-Condition Becomes 1 at mismatch between current measurement condition parameters (Active trace measurement conditions) and result measurement condition parameters
1	Peak/Dip Becomes 1 when level peak or dip not found when peak or dip search executed.
0	RES-Uncal Becomes 1 when resolution setting not appropriate for sweep width and sample count.

The commands for checking the completion of error event register execution are shown in Table 2.6.3-5.

**Table 2.6.3-5 Commands for Checking Error Event Register Execution**

Error Event Register Bit	Command
2	:DISPlay[:WINDow]:TRACe:X[:SCALe]:CENTer, :DISPlay[:WINDow]:TRACe:X[:SCALe]:SPAN, :DISPlay[:WINDow]:TRACe:X[:SCALe]:START, :DISPlay[:WINDow]:TRACe:X[:SCALe]:STOP, [:SENSe]:BANDwidth BWIDth[:RESolution], [:SENSe]:SWEep:POINts, [:SENSe][:WAVelength]:CENTer, [:SENSe][:WAVelength]:SPAN, [:SENSe][:WAVelength]:START, [:SENSe][:WAVelength]:STOP, :TRACe:POINts
1	:CALCulate:MARKer[1 2 3 4]:MAXimum, :CALCulate:MARKer[1 2 3 4]:MAXimum:LEFT, :CALCulate:MARKer[1 2 3 4]:MAXimum:NEXT, :CALCulate:MARKer[1 2 3 4]:MAXimum:RIGHT, :CALCulate:MARKer:MAXimum:SCENTer :CALCulate:MARKer:MAXimum:SRLevel :CALCulate:MARKer[1 2 3 4]:MINimum, :CALCulate:MARKer[1 2 3 4]:MINimum:LEFT, :CALCulate:MARKer[1 2 3 4]:MINimum:NEXT :CALCulate:MARKer[1 2 3 4]:MINimum:RIGHT
0	:DISPlay[:WINDow]:TRACe:X[:SCALe]:SPAN, :DISPlay[:WINDow]:TRACe:X[:SCALe]:START, :DISPlay[:WINDow]:TRACe:X[:SCALe]:STOP, [:SENSe]:BANDwidth BWIDth[:RESolution], [:SENSe]:SWEep:POINts, [:SENSe][:WAVelength]:SPAN, [:SENSe][:WAVelength]:START, [:SENSe][:WAVelength]:STOP, :TRACe:POINts

2

Before Use

The error event register can be read by

the:STATus:EVENT:ERROR:CONDition?.

The error event register enable register can be set and read using

the :STATus:EVENT:ERROR:ENABLE

and :STATus:EVENT:ERROR:ENABLE? commands. To output error event register data, set the bit corresponding to the enable register to 1.

The error event register can be set to 0 using the \*CLS command.

The enable register of the error event register cannot be changed using \*CLS.

## 2.7 Controlling Message Sync

There are two message types.

### Synchronous message

This message cannot be executed with the next message at the same time while executing the program message.

### Asynchronous message

This message can be executed with the next sent message at the same time while executing the program message. The followings are the asynchronous messages for the MS9740B.

```
:CALCulate:CATegory
:CALCulate[1|2|3|4|5|6]:CENTermass:[DATA]?
:CALCulate[1|2|3|4|5|6]:CENTermass:STATE
:CALCulate[1|2|3|4|5|6]:FWHM[:DATA]?
:CALCulate[1|2|3|4|5|6]:FWHM:STATE
:CALCulate[1|2|3|4|5|6]:SIGMa:[DATA]?
:CALCulate[1|2|3|4|5|6]:SOURce:TEST
:CALCulate[1|2|3|4|5|6]:TPOWer[:DATA]?
:CALCulate[1|2|3|4|5|6]:TPOWer:STATE
:CALCulate:OFFSet:SOURce
:CALCulate:PARAmeter[:CATegory]
:CALCulate:PEXCursion[:PEAK]
:CALCulate:THReshold
:CALCulate:SNOise
:CALCulate:SOURce:FUNCTion:BWIDth | BANDwidth:NDB
:CALCulate:MARKer[1|2|3|4]:MAXimum,
:CALCulate:MARKer[1|2|3|4]:MAXimum:LEFT,
:CALCulate:MARKer[1|2|3|4]:MAXimum:NEXT,
:CALCulate:MARKer[1|2|3|4]:MAXimum:RIGHT,
:CALCulate:MARKer[1|2|3|4]:MINimum,
:CALCulate:MARKer[1|2|3|4]:MINimum:LEFT,
:CALCulate:MARKer[1|2|3|4]:MINimum:NEXT
:CALCulate:MARKer[1|2|3|4]:MINimum:RIGHT
:CALibration:ALIGNment,
:CALibration:ALIG[:IMMediate],
:CALibration:RESCal,
:CALibration:WAVelength:EXTernal[:IMMediate],
:CALibration:WAVelength[:EXTernal][:NORMAl],
:CALibration:WAVelength:INTernal[:IMMediate],
:CALibration:WAVelength:INTernal[:NORMAl],
:CALibration:ZCAL
:INITiate[:IMMediate],
```



```
:INITiate:IMMediate:SEquence [1|2]
:INSTrument:SElect
```

However, if the next message is sent before the previous asynchronous message processing is completed, the message is discarded and the correct measurement conditions will not be obtained.

The following program message executes the single measurement, detects the peak level and its wavelength, and read its wavelength.

```
:INIT; :CALC:MARKer1:MAX; :CALC:MARK1:Y?
```

Figure 2.7-1 shows the message execution sequence when this message is sent to the MS9740B. After executing `:INIT`, sweeping starts. As the peak search is executed during sweeping, `:CALC:MARKer1:MAX` is executed as well. The read peak level and wavelength during sweeping are sometimes different from those after sweeping.

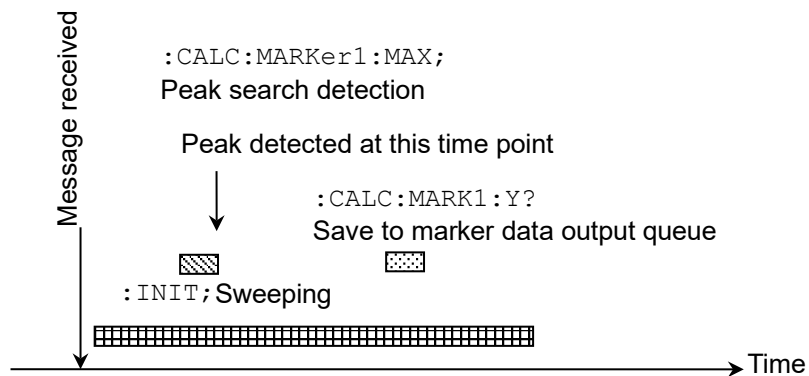

**Figure 2.7-1 Message Processing Order**

The control for processing the next command after completing processing of the message sent first is called sync control.

Sync control is performed by the following methods.

- Using `*WAI` command
- Using `*OPC?` query
- Using `*OPC` command and `*ESR?` query
- By querying execution end
- Using `ESR2?` query

The `*WAI` command, `*OPC?` query, `*OPC` command, and `*ESR?` query can be used for all messages.



**Using \*OPC and \*ESR?**

The \*OPC common command sets the standard event status register bit to 1 and displays the OPC bit when completing all command operation.

**Examples of Use:**

*OPC	Displays OPC bit in Standard Event Status register
*ESR?	Standard Event Status register query
> 0	0: A command is in progress.
*ESR?	Standard Event Status register query
> 1	1: No command is in progress or *ESR has completed.

2

Before Use

**Querying Measurement End**

The instrument program messages query the end of processing execution. These queries send the following messages after confirming the processing end.

**Examples of Use:**

:CAL:ALIG	Command of auto alignment execution
:CAL:ALIG?	Queries result of auto alignment
> 1	1: Alignment is in progress.
:CAL:ALIG?	Queries result of auto alignment
> 0	0: Alignment has completed.
:INIT	Performs single measurement.

**Using :STATus:EVENT:CONDition?**

The commands in Table 2.6.3-1 set bit of the end event register when execution is completed.

The following messages are sent after confirming the completion of execution when reading the end event register using the :STATus:EVENT:CONDition? query.

Examples of Use:

*CLS	Sets OPC bit to 0
:INIT	Performs single measurement.
:STAT:EVEN:COND?	Queries end event register
> 0	0: A command is in progress.
:STAT:EVEN:COND?	Queries end event register
> 2	2: Single measurement has completed.
:CALC:PAR:CAT:SMSR 2NDPEAK	Executes spectrum analysis by SMSR.
:STAT:EVEN:COND?	Queries end event register
> 0	0: A command is in progress.
:STAT:EVEN:COND?	Queries end event register
> 1	1: SMSR spectrum analysis has completed.
:CALC:MARKer1:MAX	Executes peak search
:STAT:EVEN:COND?	Queries end event register
> 0	0: A command is in progress.
:STAT:EVEN:COND?	Queries end event register
> 1	1: Peak search has completed.
:CALC:MARK1:Y?	Queries trace marker data

## Chapter 3 Message Details

---

This chapter describes the message details of remote control commands for MS9740B.

For the initial value of parameters, refer to Appendix B, “Initial Values” in the *MS9740B Optical Spectrum Analyzer Operation Manual*.

3.1	Rules for Describing Messages .....	3-2
3.2	Correspondence between Panel Operation and Message .....	3-3
3.2.1	Panel key .....	3-3
3.2.2	Function key .....	3-5
3.3	Message Function Category.....	3-22
3.3.1	IEEE488.2 Common Messages and Device Dependent Messages .....	3-22
3.3.2	System Management and Measurement Commands .....	3-23
3.4	Device Message Details.....	3-26
3.4.1	IEEE488.2 Common Message .....	3-26
3.4.2	ABORt Subsystem .....	3-32
3.4.3	CALCulate Subsystem .....	3-32
3.4.4	CALibration Subsystem.....	3-183
3.4.5	DISPlay Subsystem .....	3-193
3.4.6	FORMat Subsystem.....	3-206
3.4.7	INITiate Subsystem.....	3-208
3.4.8	INSTRument Subsystem .....	3-212
3.4.9	MMEMory Subsystem .....	3-213
3.4.10	SENSe Subsystem.....	3-233
3.4.11	SOURce Subsystem .....	3-247
3.4.12	STATus Subsystem .....	3-248
3.4.13	SYSTem Subsystem .....	3-250
3.4.14	TRACe Subsystem.....	3-253
3.4.15	TRIGger Subsystem.....	3-264
3.4.16	UNIT Subsystem.....	3-266

### 3.1 Rules for Describing Messages

The following table shows the rules for describing messages.

**Table 3.1-1 Rules for Describing Messages**

Symbols	Usage
<>	Parameters in triangle brackets are input by the programmer.
[]	Parameters in square brackets can be omitted.
	Select one out of multiple choices. In the case of A B C D, select one from A, B, C, or D.
{}	Group the choices. In the case of A B ({C D}), select one from A, B (C) or B (D).
<binary_data>	This string is in binary data format.
<file_name>	Character string within 32 characters enclosed by single quotes (') \, /, :, *, ?, ", <, >,   cannot be used. Example 'Sample_LD(201) '
<numeric>	This is a string of numeric code. Example 0,1.2E-6,2.35
<string>	This is a character string data.
<switch>	This is a specific selection of message. Example 100KHZ, LEFT
<trace>	Select one from A,B,C,D,E,F,G,H,I,J.
<trace_name>	Select one from A,B,C,D,E,F,G,H,I,J,TRA,TRB,TRC,TRD,TRE,TRF.
<unit_h>	Select the frequency unit from below. THZ: THz (10 <sup>12</sup> Hz) GHZ: GHz (10 <sup>9</sup> Hz) MHZ: MHz (10 <sup>6</sup> Hz) KHZ: kHz (10 <sup>3</sup> Hz) HZ: Hz
<unit_m>	Select the frequency unit from below. M: mm (10 <sup>-3</sup> m) UM: μm (10 <sup>-6</sup> m) NM: nm (10 <sup>-9</sup> m) PM: pm (10 <sup>-12</sup> m) A: am (10 <sup>-18</sup> m)
<user_drive>	Select one from E,F,G,H,I,J,K,L,M,N,O,P,Q,R,S,T,U,V,W,X,Y,Z.

## 3.2 Correspondence between Panel Operation and Message

This section explains correspondence between panel operation and message.

### 3.2.1 Panel key

Table 3.2.1-1 shows the corresponding keys to message.

“—” in the following table indicates that there is no corresponding message.

**Table 3.2.1-1 Correspondence Between Panel Operation and Message**

Key name	Command
	Query
→ Center	:CALCulate:MARKer:MAXimum:SCENter
	—
→ Ref Lvl	:CALCulate:MARKer:MAXimum:SRLevel
	—
Auto Measure	:DISPlay[:WINDow[1]]:TRACe:ALL[:SCALe][:AUTO] :INITiate:SMODE 3 AUTO;:INITiate[:IMMediate]
	:DISPlay[:WINDow[1]]:TRACe:ALL[:SCALe][:AUTO]?
Center	:DISPlay[:WINDow]:TRACe:X[:SCALe]:CENTer [:SENSe][:WAVelength]:CENTer
	:DISPlay[:WINDow]:TRACe:X[:SCALe]:CENTer? [:SENSe][:WAVelength]:CENTer?
Copy	:MMEMory:STORe:GRAPhics
	—
Local	—
	—
Log (/div)	:DISPlay[:WINDow[1]]:TRACe:Y[1 2][:SCALe]:PDIVision
	:DISPlay[:WINDow[1]]:TRACe:Y[1 2][:SCALe]:PDIVision?
Marker Select	:CALCulate:LMARker:X :CALCulate:LMARker:Y :CALCulate:MARKer:TMK:DATA :CALCulate:MARKer:FUNcTion:DELta:XY
	:CALCulate:LMARker:X? :CALCulate:LMARker:Y? :CALCulate:MARKer:TMK:DATA? :CALCulate:MARKer:FUNcTion:DELta:XY?
Peak Search	:CALCulate:MARKer[1 2 3 4]:MAXimum
	—

**Table 3.2.1-1 Correspondence Between Panel Operation and Message (Cont'd)**

Key name	Command
	Query
Preset*	:SYSTem:PRESet
	-
Recall*	:MMEMory:DATA :MMEMory:LOAD:TRACe :MMEMory:LOAD:ATRACE
	-
Ref	:DISPlay[:WINDow[1]]:TRACe:Y[1 2][:SCALE]:RLEVel
	:DISPlay[:WINDow[1]]:TRACe:Y[1 2][:SCALE]:RLEVel?
Repeat	:INITiate:CONTInuous 1 ON :INITiate[:IMMediate] :INITiate:SMODE 2 REPeat;:INITiate[:IMMediate]
	:INITiate:CONTInuous? :INITiate:SMODE?
Res	[:SENSe]:BANDwidth BWIDth[:RESolution]
	[:SENSe]:BANDwidth BWIDth[:RESolution]?
Save*	:MMEMory:STORE:ATRACE
	-
Single	:INITiate:CONTInuous 0 OFF :INITiate[:IMMediate] :INITiate:SMODE 1 SINGle;:INITiate[:IMMediate]
	:INITiate:CONTInuous? :INITiate:SMODE?
Span	:DISPlay[:WINDow]:TRACe:X[:SCALE]:SPAN [:SENSe][:WAVelength]:SPAN
	:DISPlay[:WINDow]:TRACe:X[:SCALE]:SPAN? [:SENSe][:WAVelength]:SPAN
Stop	:ABORT
	-
VBW	[:SENSe]:BANDwidth BWIDth:VIDeo
	[:SENSe]:BANDwidth BWIDth:VIDeo?
Zone Marker	:CALCulate:MARKer:ZONE:SPAN :CALCulate:MARKer:ZONE:WAVelength
	:CALCulate:MARKer:ZONE:WAVelength?

\*: Refer to Table 3.2.2-20.



### 3.2.2 Function key

Table 3.2.1-1 through Table 3.2.2-20 show the correspondence between function key and messages.

“—” in the following table indicates that there is no corresponding message.

**Table 3.2.2-1 Correspondence Between F1 Wavelength Key and Message**

f1-f8 Key Name	Command
	Query
Center	:DISPlay[:WINDow]:TRACe:X[:SCALe]:CENTer [:SENSe][:WAVelength]:CENTer
	:DISPlay[:WINDow]:TRACe:X[:SCALe]:CENTer? [:SENSe][:WAVelength]:CENTer?
Span	:DISPlay[:WINDow]:TRACe:X[:SCALe]:SPAN [:SENSe][:WAVelength]:SPAN
	:DISPlay[:WINDow]:TRACe:X[:SCALe]:SPAN? [:SENSe][:WAVelength]:SPAN?
Peak->Center	:CALCulate:MARKer:MAXimum:SCENter
	—
Start	:DISPlay[:WINDow]:TRACe:X[:SCALe]:START [:SENSe][:WAVelength]:START
	:DISPlay[:WINDow]:TRACe:X[:SCALe]:START? [:SENSe][:WAVelength]:START?
	:TRACe[:DATA]:X:START?
Stop	:DISPlay[:WINDow]:TRACe:X[:SCALe]:STOP [:SENSe][:WAVelength]:STOP
	:DISPlay[:WINDow]:TRACe:X[:SCALe]:STOP? [:SENSe][:WAVelength]:STOP?
	:TRACe[:DATA]:X:STOP?
MkrValue W/Freq	:CALCulate:MARKer[1 2 3 4]:FUNCTion:DELTA:X:READout :CALCulate:MARKer[1 2 3 4]:X:READout :CALCulate:MARKer:UNIT
	:CALCulate:MARKer[1 2 3 4]:FUNCTion:DELTA:X:READout? :CALCulate:MARKer[1 2 3 4]:X:READout? :CALCulate:MARKer:UNIT?
Value in Air/Vac	[:SENSe]:CORRection:RVELocity:MEDIum
	[:SENSe]:CORRection:RVELocity:MEDIum?

**Table 3.2.2-2 Correspondence Between F2 Level Scale Key and Message**

f1-f8 Key Name	Command
	Query
Log (/div)	:DISPlay[:WINDow[1]]:TRACe:Y[1 2][:SCALe]:PDIVision
	:DISPlay[:WINDow[1]]:TRACe:Y[1 2][:SCALe]:PDIVision?
Ref Level	:DISPlay[:WINDow[1]]:TRACe:Y[1 2][:SCALe]:RLEVel
	:DISPlay[:WINDow[1]]:TRACe:Y[1 2][:SCALe]:RLEVel?
Peak->RefLevel	:CALCulate:MARKer:MAXimum:SRLevel
	-
Linear Level	:DISPlay[:WINDow]:TRACe:Y1[:SCALe]:BLEVel
	:DISPlay[:WINDow]:TRACe:Y1[:SCALe]:BLEVel?
Opt.Att On/Off	:SENSe:ATT[:STATe]
	:SENSe:ATT[:STATe]?

**Table 3.2.2-3 Correspondence Between F3 Res/VBW/Avg Key and Message**

f1-f8 Key Name	Command
	Query
Res	[:SENSe]:BANDwidth BWIDth[:RESolution]
	[:SENSe]:BANDwidth BWIDth[:RESolution]?
VBW	[:SENSe]:BANDwidth BWIDth:VIDeo
	[:SENSe]:BANDwidth BWIDth:VIDeo?
Point Average	:SENSe:AVERage:COUNT
	:SENSe:AVERage:COUNT?
Sweep Average	:CALCulate[1 2 3 4 5 6]:AVERage:COUNT
	:TRACe:ATTRibute:RAVG[:<trace_name>]
	:CALCulate[1 2 3 4 5 6]:AVERage:COUNT? :TRACe:ATTRibute:RAVG[:<trace_name>]?
Smooth	:SENSe:SETTing:SMOoth
	:SENSe:SETTing:SMOoth?
Sampling Points	[:SENSe]:SWEep:POINTs
	:TRACe:POINTs
	[:SENSe]:SWEep:POINTs? :TRACe[:DATA]:SNUMber? :TRACe:POINTs?
Act-Res On/Off	:CALibration:ACTRes
	:CALibration:ACTRes?

Table 3.2.2-4 Correspondence Between F4 Peak/Dip Search Key and Message

f1-f8 Key Name	Command
	Query
Peak Search	:CALCulate:MARKer[1 2 3 4]:MAXimum
	-
Dip Search	:CALCulate:MARKer[1 2 3 4]:MINimum
	-
Off	:CALCulate:MARKer[1 2 3 4][:STATe]
	:CALCulate:MARKer[1 2 3 4][:STATe]?
Next	:CALCulate:MARKer[1 2 3 4]:MAXimum:NEXT
	:CALCulate:MARKer[1 2 3 4]:MINimum:NEXT
	-
Last	-
	-
Left	:CALCulate:MARKer[1 2 3 4]:MAXimum:LEFT
	:CALCulate:MARKer[1 2 3 4]:MINimum:LEFT
	-
Right	:CALCulate:MARKer[1 2 3 4]:MAXimum:RIGHT
	:CALCulate:MARKer[1 2 3 4]:MINimum:RIGHT
	-
Search Threshold Auto/Manual	:CALCulate:MARKer[1 2 3 4]:PEXCursion[:PEAK]
	:CALCulate:MARKer[1 2 3 4]:PEXCursion:PIT
	:CALCulate:MARKer[1 2 3 4]:PEXCursion[:PEAK]?
	:CALCulate:MARKer[1 2 3 4]:PEXCursion:PIT?
Search Threshold	:CALCulate:MARKer[1 2 3 4]:PEXCursion[:PEAK]
	:CALCulate:MARKer[1 2 3 4]:PEXCursion:PIT
	:CALCulate:MARKer[1 2 3 4]:PEXCursion[:PEAK]?
	:CALCulate:MARKer[1 2 3 4]:PEXCursion:PIT?
Peak to Peak Calculation On/Off	:CALCulate:MARKer:PP[:STATe]
	:CALCulate:MARKer:PP[:STATe]?

**Table 3.2.2-5 Correspondence Between F5 Analysis Key and Message**

f1-f8 Key Name	Command
	Query
Threshold	:CALCulate:CATegory 0 SWThresh :CALCulate:PARAmeter[:CATegory]:SWThresh:TH
	:CALCulate:CATegory? :CALCulate:PARAmeter[:CATegory]:SWThresh:TH?
ndB Loss	:CALCulate:CATegory 20 NDB :CALCulate:PARAmeter[:CATegory]:NDB
	:CALCulate:CATegory? :CALCulate:PARAmeter[:CATegory]:NDB?
SMSR	:CALCulate:CATegory 21 SMSR :CALCulate:PARAmeter[:CATegory]:SMSR
	:CALCulate:CATegory? :CALCulate:PARAmeter[:CATegory]:SMSR?
Envelope	:CALCulate:CATegory 1 SWENvelope :CALCulate:PARAmeter[:CATegory]:SWENvelope:TH1
	:CALCulate:CATegory? :CALCulate:PARAmeter[:CATegory]:SWENvelope:TH1?
RMS	:CALCulate:CATegory 3 SWPKrms :CALCulate:PARAmeter[:CATegory]:SWPKrms:TH
	:CALCulate:CATegory? :CALCulate:PARAmeter[:CATegory]:SWPKrms:TH?
Spectrum Power	:CALCulate:CATegory 9 POWER
	:CALCulate:CATegory?
Off	:CALCulate:CATegory OFF
	-

**Table 3.2.2-6 Correspondence Between F6 Trace Key and Message**

f1-f8 Key Name	Command
	Query
Active Trace	:CALCulate:MARKer[1 2 3 4]:TRACe :TRACe:ACTive
	:CALCulate:MARKer[1 2 3 4]:TRACe? :TRACe:ACTive?
Trace Type	:TRACe:ATTRibute[:<trace_name> TRG] :TRACe:FEED:CONTrol
	:TRACe:ATTRibute[:<trace_name> TRG]? :TRACe:FEED:CONTrol?
Storage Mode	:CALCulate[1 2 3 4 5 6]:AVERage[:STATe] :CALCulate[1 2 3 4 5 6]:MAXimum[:STATe] :CALCulate[1 2 3 4 5 6]:MINimum[:STATe] :TRACe:ATTRibute[:<trace_name> TRG] :TRACe:STORage
	:CALCulate[1 2 3 4 5 6]:AVERage[:STATe]? :CALCulate[1 2 3 4 5 6]:MAXimum[:STATe]? :CALCulate[1 2 3 4 5 6]:MINimum[:STATe]? :TRACe:ATTRibute[:<trace_name> TRG]? :TRACe:STORage?
Calculation	:CALCulate[1 2 3 4 5 6]:MATH[:EXPRession][:DEFine] :CALCulate:MATH:TRC :CALCulate:MATH:TRF :CALCulate:MATH:TRG
	:CALCulate[1 2 3 4 5 6]:MATH[:EXPRession][:DEFine]? :CALCulate:MATH:TRC? :CALCulate:MATH:TRF? :CALCulate:MATH:TRG?
Display On/Off	:DISPlay[:WINDow[1]]:TRACe[:STATe] :TRACe:STATe[:<trace_name> TRG]
	:DISPlay[:WINDow[1]]:TRACe[:STATe]? :TRACe:STATe[:<trace_name> TRG]?
Graph	:CALCulate:MATH:TRX:NORMalize :CALCulate:MATH:TRX:NORMalize?
Erase Overlap	:TRACe:DELete:EOV
	-

**Table 3.2.2-7 Correspondence Between F7 Application Key and Message**

f1-f8 Key Name	Command
	Query
DFB-LD Test	:CALCulate:CATegory 5 DFBLd :CALCulate:PARAmeter[:CATegory]:DFBLd :CALCulate[1 2 3 4 5 6]:SOURce:TEST DFB :INSTrument:SElect 'DFB'
	:CALCulate:CATegory? :CALCulate:PARAmeter[:CATegory]:DFBLd? :CALCulate[1 2 3 4 5 6]:SOURce:TEST? :INSTrument:SElect?
FP-LD Test	:CALCulate:CATegory 6 FPLD :CALCulate:PARAmeter[:CATegory]:FP :CALCulate[1 2 3 4 5 6]:SOURce:TEST FP :INSTrument:SElect 'FP'
	:CALCulate:CATegory? :CALCulate:PARAmeter[:CATegory]:FP? :CALCulate[1 2 3 4 5 6]:SOURce:TEST? :INSTrument:SElect?
LED Test	:CALCulate:CATegory 7 LED :CALCulate:PARAmeter[:CATegory]:LED :CALCulate[1 2 3 4 5 6]:SOURce:TEST LED :INSTrument:SElect 'LED'
	:CALCulate:CATegory? :CALCulate:PARAmeter[:CATegory]:LED? :CALCulate[1 2 3 4 5 6]:SOURce:TEST? :INSTrument:SElect?
PMD Test	:CALCulate:CATegory 24 PMD :CALCulate:PARAmeter[:CATegory]:PMD :INSTrument:SElect 'PMD'
	:CALCulate:CATegory? :CALCulate:PARAmeter[:CATegory]:PMD? :INSTrument:SElect?
WDM Test	:CALCulate:CATegory 11 WDM :INSTrument:SElect 'WDM' :INSTrument:SElect 'WDM_Autoscan'
	:CALCulate:CATegory? :INSTrument:SElect?

**Table 3.2.2-7 Correspondence Between F7 Application Key and Message (Cont'd)**

f1-f8 Key Name	Command
	Query
LD Module Test	:CALCulate:CATegory 23 LD :INSTrument:SElect 'LD'
	:CALCulate:CATegory? :INSTrument:SElect?
Opt Amp Test	:CALCulate:CATegory 22 AMP :INSTrument:SElect 'AMP'
	:CALCulate:CATegory? :INSTrument:SElect?
Opt Amp (Multi Channel) Test	:CALCulate:CATegory 12 NF :INSTrument:SElect 'AMP2' :INSTrument:SElect 'AMP_ISS_Test'
	:CALCulate:CATegory? :INSTrument:SElect?
WDM Filter Test	:CALCulate:CATegory 15 WFPeak :INSTrument:SElect 'WFIL'
	:CALCulate:CATegory? :INSTrument:SElect?

3

Message Details

**Table 3.2.2-8 Correspondence Between F7 Application (DFB-LD) Key and Message**

f1-f8 Key Name	Command
	Query
Slice Level	:CALCulate:PARAmeter[:CATegory]:DFBLd
	:CALCulate:PARAmeter[:CATegory]:DFBLd?
Side Mode	:CALCulate:PARAmeter[:CATegory]:DFBLd
	:CALCulate:PARAmeter[:CATegory]:DFBLd?
Kσ	:CALCulate:PARAmeter[:CATegory]:DFBLd
	:CALCulate:PARAmeter[:CATegory]:DFBLd?
ndB Width	:CALCulate:SOURce:FUNction:BWIDth BANDwidth:NDB
	:CALCulate:SOURce:FUNction:BWIDth BANDwidth:NDB?
Search Resolution	:CALCulate:PARAmeter[:CATegory]:DFBLd:SRES
	:CALCulate:PARAmeter[:CATegory]:DFBLd:SRES?

**Table 3.2.2-9 Correspondence Between F7 Application (WDM) Key and Message**

f1-f8 Key Name	Command
	Query
Display Mode	:CALCulate:PARAmeter[:CATegory]:WDM:DTYPe
	:CALCulate:PARAmeter[:CATegory]:WDM:DTYPe?
Signal Parameter	:CALCulate:PARAmeter[:CATegory]:WDM:PEXCursion :CALCulate:PARAmeter[:CATegory]:WDM:SGLevel :CALCulate:PARAmeter[:CATegory]:WDM:SGWavelength :CALCulate:PARAmeter[:CATegory]:WDM:SLICe :CALCulate:PARAmeter[:CATegory]:WDM:SPOWer :CALCulate:PARAmeter[:CATegory]:WDM:TH
	:CALCulate:PARAmeter[:CATegory]:WDM:PEXCursion? :CALCulate:PARAmeter[:CATegory]:WDM:SGLevel? :CALCulate:PARAmeter[:CATegory]:WDM:SGWavelength? :CALCulate:PARAmeter[:CATegory]:WDM:SLICe? :CALCulate:PARAmeter[:CATegory]:WDM:SPOWer? :CALCulate:PARAmeter[:CATegory]:WDM:TH?
Noise Parameter	:CALCulate:PARAmeter[:CATegory]:WDM:AREA :CALCulate:PARAmeter[:CATegory]:WDM:FALGo :CALCulate:PARAmeter[:CATegory]:WDM:MAREa :CALCulate:PARAmeter[:CATegory]:WDM:NACHannel :CALCulate:PARAmeter[:CATegory]:WDM:NAFunction :CALCulate:PARAmeter[:CATegory]:WDM:NAREa :CALCulate:PARAmeter[:CATegory]:WDM:NAUSer :CALCulate:PARAmeter[:CATegory]:WDM:NBW :CALCulate:PARAmeter[:CATegory]:WDM:NNORmalize :CALCulate:PARAmeter[:CATegory]:WDM:PDISplay :CALCulate:PARAmeter[:CATegory]:WDM:POINt
	:CALCulate:PARAmeter[:CATegory]:WDM:AREA? :CALCulate:PARAmeter[:CATegory]:WDM:FALGo? :CALCulate:PARAmeter[:CATegory]:WDM:MAREa? :CALCulate:PARAmeter[:CATegory]:WDM:NACHannel? :CALCulate:PARAmeter[:CATegory]:WDM:NAFunction? :CALCulate:PARAmeter[:CATegory]:WDM:NAREa? :CALCulate:PARAmeter[:CATegory]:WDM:NAUSer? :CALCulate:PARAmeter[:CATegory]:WDM:NBW? :CALCulate:PARAmeter[:CATegory]:WDM:NNORmalize? :CALCulate:PARAmeter[:CATegory]:WDM:PDISplay? :CALCulate:PARAmeter[:CATegory]:WDM:POINt?



**Table 3.2.2-10 Correspondence Between F7 Application (LD Module) Key and Message**

f1-f8 Key Name	Command
	Query
SMSR Parameter	:CALCulate:PARAmeter[:CATegory]:LD:SMSR
	:CALCulate:PARAmeter[:CATegory]:LD:SMSR?
K $\sigma$	:CALCulate:PARAmeter[:CATegory]:LD:K
	:CALCulate:PARAmeter[:CATegory]:LD:K?
ndB Width	:CALCulate:PARAmeter[:CATegory]:LD:NDBWidth
	:CALCulate:PARAmeter[:CATegory]:LD:NDBWidth?
Search Resolution	:CALCulate:PARAmeter[:CATegory]:LD:SRES
	:CALCulate:PARAmeter[:CATegory]:LD:SRES?
Signal Parameter	:CALCulate:PARAmeter[:CATegory]:LD:SGLevel
	:CALCulate:PARAmeter[:CATegory]:LD:SGSelect
	:CALCulate:PARAmeter[:CATegory]:LD:SGWavelength
	:CALCulate:PARAmeter[:CATegory]:LD:SGLevel?
Noise Parameter	:CALCulate:PARAmeter[:CATegory]:LD:SGSelect?
	:CALCulate:PARAmeter[:CATegory]:LD:SGWavelength?
	:CALCulate:PARAmeter[:CATegory]:LD:AREA
	:CALCulate:PARAmeter[:CATegory]:LD:NACHannel
	:CALCulate:PARAmeter[:CATegory]:LD:NAFunction
	:CALCulate:PARAmeter[:CATegory]:LD:NAUser
	:CALCulate:PARAmeter[:CATegory]:LD:NNORMALize
	:CALCulate:PARAmeter[:CATegory]:LD:NOISE
	:CALCulate:PARAmeter[:CATegory]:LD:THReshold
	:CALCulate:PARAmeter[:CATegory]:LD:AREA?
:CALCulate:PARAmeter[:CATegory]:LD:NACHannel?	
:CALCulate:PARAmeter[:CATegory]:LD:NAFunction?	
:CALCulate:PARAmeter[:CATegory]:LD:NAUser?	
:CALCulate:PARAmeter[:CATegory]:LD:NNORMALize?	
:CALCulate:PARAmeter[:CATegory]:LD:NOISE	
:CALCulate:PARAmeter[:CATegory]:LD:THReshold?	
Noise Position	:CALCulate:PARAmeter[:CATegory]:LD:NPOSITION
	:CALCulate:PARAmeter[:CATegory]:LD:POINT
	:CALCulate:PARAmeter[:CATegory]:LD:NPOSITION?
	:CALCulate:PARAmeter[:CATegory]:LD:POINT?

**Table 3.2.2-11 Correspondence Between F7 Application (Opt Amp Test) Key and Message**

f1-f8 Key Name	Command
	Query
Method	:CALCulate:PARAmeter[:CATegory]:AMP:PARAmeter
	:CALCulate:PARAmeter[:CATegory]:AMP:PARAmeter?
Parameter	:CALCulate:PARAmeter[:CATegory]:AMP:PARAmeter
	:CALCulate:PARAmeter[:CATegory]:AMP:PARAmeter?
Write to	:CALCulate:PARAmeter[:CATegory]:AMP:MSElect
	:CALCulate:PARAmeter[:CATegory]:AMP:MSElect?
Ext Trigger Delay	:TRIGger[:SEQuence]:DELay
	:TRIGger[:SEQuence]:DELay?
Res Cal	:CALCulate:PARAmeter[:CATegory]:AMP:RESCalibrate
	:CALCulate:PARAmeter[:CATegory]:AMP:RESCalibrate?
Pin	:CALCulate:PARAmeter[:CATegory]:AMP:PIN
	:CALCulate:PARAmeter[:CATegory]:AMP:PIN?
Pout	:CALCulate:PARAmeter[:CATegory]:AMP:POUT
	:CALCulate:PARAmeter[:CATegory]:AMP:POUT?
Pase	:CALCulate:PARAmeter[:CATegory]:AMP:PASE
	:CALCulate:PARAmeter[:CATegory]:AMP:PASE?

**Table 3.2.2-12 Correspondence Between F7 Application (Opt Amp Test (Multi Channel)) Key and Message**

f1-f8 Key Name	Command
	Query
ISS Method	:CALCulate:PARAmeter[:CATegory]:NF:PARAmeter
	:CALCulate:PARAmeter[:CATegory]:NF:PARAmeter?
Channel Parameter	:CALCulate:PARAmeter[:CATegory]:NF:MDIFf :CALCulate:PARAmeter[:CATegory]:NF:TH :CALCulate:PARAmeter[:CATegory]:NF:WDETECT :CALCulate:PEXCursion[:PEAK] :CALCulate:THReshold
	:CALCulate:PARAmeter[:CATegory]:NF:MDIFf? :CALCulate:PARAmeter[:CATegory]:NF:TH? :CALCulate:PARAmeter[:CATegory]:NF:WDETECT? :CALCulate:PEXCursion[:PEAK]? :CALCulate:THReshold?

**Table 3.2.2-12 Correspondence Between F7 Application (Opt Amp Test (Multi Channel)) Key and Message (Cont'd)**

f1-f8 Key Name	Command
	Query
Opt Amp Test Parameter	:CALCulate:OFFSet:AMPLifier :CALCulate:OFFSet:SOURce :CALCulate:PARAmeter[:CATegory]:NF:AALGo :CALCulate:PARAmeter[:CATegory]:NF:AREA :CALCulate:PARAmeter[:CATegory]:NF:ASE :CALCulate:PARAmeter[:CATegory]:NF:FALGo :CALCulate:PARAmeter[:CATegory]:NF:FARea :CALCulate:PARAmeter[:CATegory]:NF:IOFFset :CALCulate:PARAmeter[:CATegory]:NF:MARea :CALCulate:PARAmeter[:CATegory]:NF:OBPF :CALCulate:PARAmeter[:CATegory]:NF:OOFFset :CALCulate:PARAmeter[:CATegory]:NF:PARAmeter :CALCulate:PARAmeter[:CATegory]:NF:PDISplay :CALCulate:PARAmeter[:CATegory]:NF:RBWidth :CALCulate:PARAmeter[:CATegory]:NF:SNOise :CALCulate:SNOise
	:CALCulate:OFFSet:AMPLifier? :CALCulate:OFFSet:SOURce? :CALCulate:PARAmeter[:CATegory]:NF:AALGo? :CALCulate:PARAmeter[:CATegory]:NF:AREA? :CALCulate:PARAmeter[:CATegory]:NF:ASE? :CALCulate:PARAmeter[:CATegory]:NF:FALGo? :CALCulate:PARAmeter[:CATegory]:NF:FARea? :CALCulate:PARAmeter[:CATegory]:NF:IOFFset? :CALCulate:PARAmeter[:CATegory]:NF:MARea? :CALCulate:PARAmeter[:CATegory]:NF:OBPF? :CALCulate:PARAmeter[:CATegory]:NF:OOFFset? :CALCulate:PARAmeter[:CATegory]:NF:PARAmeter? :CALCulate:PARAmeter[:CATegory]:NF:PDISplay? :CALCulate:PARAmeter[:CATegory]:NF:RBWidth? :CALCulate:PARAmeter[:CATegory]:NF:SNOise? :CALCulate:SNOise?

**Table 3.2.2-12 Correspondence Between F7 Application (Opt Amp Test (Multi Channel)) Key and Message (Cont'd)**

f1-f8 Key Name	Command
	Query
Write to	:CALCulate:PARAmeter[:CATegory]:NF:MSElect
	:CALCulate:PARAmeter[:CATegory]:NF:MSElect?
Pin	:CALCulate:PARAmeter[:CATegory]:NF:PIN
	:CALCulate:PARAmeter[:CATegory]:NF:PIN?
Pout	:CALCulate:PARAmeter[:CATegory]:NF:POUT
	:CALCulate:PARAmeter[:CATegory]:NF:POUT?

**Table 3.2.2-13 Correspondence Between F7 Application (WDM Filter) Key and Message**

f1-f8 Key Name	Command
	Query
Test Parameter	:CALCulate:PARAmeter[:CATegory]:WFIL:BANDwidth :CALCulate:PARAmeter[:CATegory]:WFIL:PEXCursion :CALCulate:PARAmeter[:CATegory]:WFIL:RIPPlE :CALCulate:PARAmeter[:CATegory]:WFIL:SGLevel :CALCulate:PARAmeter[:CATegory]:WFIL:SGWavelength :CALCulate:PARAmeter[:CATegory]:WFIL:SLICe :CALCulate:PARAmeter[:CATegory]:WFIL:TCL
	:CALCulate:PARAmeter[:CATegory]:WFIL:BANDwidth? :CALCulate:PARAmeter[:CATegory]:WFIL:PEXCursion? :CALCulate:PARAmeter[:CATegory]:WFIL:RIPPlE? :CALCulate:PARAmeter[:CATegory]:WFIL:SGLevel? :CALCulate:PARAmeter[:CATegory]:WFIL:SGWavelength? :CALCulate:PARAmeter[:CATegory]:WFIL:SLICe? :CALCulate:PARAmeter[:CATegory]:WFIL:TCL?

**Table 3.2.2-14 Correspondence Between F1 Measure Mode Key and Message**

f1-f8 Key Name	Command
	Query
Dynamic Range	[ :SENSe] :CHOP [ :STATe] :SENSe:CHOPper
	[ :SENSe] :CHOP [ :STATe] ? :SENSe:CHOPper?
Ext. Trigger Delay	:TRIGger [ :SEQuence] :DELay*1 :TRIGger [ :SEQuence] :SOURce :TRIGger [ :SEQuence] :STATe
	:TRIGger [ :SEQuence] :DELay? :TRIGger [ :SEQuence] :SOURce? :TRIGger [ :SEQuence] :STATe?
Interval Time	:SENSe:SWEep:TIME:INTerval
	:SENSe:SWEep:TIME:INTerval?
Power Monitor	:INITiate:POWer:WAVelength*2 :INITiate:POWer:OFF*3
	:INITiate:POWer:DATA?
	:INITiate:POWer:WAVelength?
MM Mode	:SENSe:SETTing:MMMode
	:SENSe:SETTing:MMMode?

\*1: :TRIGger[:SEQuence]:DELay sets the Trigger Delay.

\*2: Command for starting power monitoring

\*3: Command for stopping power monitoring

**Table 3.2.2-15 Correspondence Between F2 Cal Key and Message**

f1-f8 Key Name	Command
	Query
WI Offset	:SENSe:CORRection:WAVelength:SHIFt [:SENSe][:WAVelength]:OFFSet
	:SENSe:CORRection:WAVelength:SHIFt? [:SENSe][:WAVelength]:OFFSet?
Level Offset	:CALCulate:PARAmeter[:CATegory]:POWer:OFFSet :SENSe:CORRection:LEVel:SHIFt
	:CALCulate:PARAmeter[:CATegory]:POWer:OFFSet? :SENSe:CORRection:LEVel:SHIFt?
WI Cal (Ext)	:CALibration:WAVelength:EXTErnal[:IMMediate] :CALibration:WAVelength[:EXTErnal][:NORMal]
	:CALibration:WAVelength:EXTErnal[:IMMediate]? :CALibration:WAVelength[:EXTErnal][:NORMal]?
WI Cal (Ref)	:CALibration:WAVelength:INTernAl[:IMMediate] :CALibration:WAVelength:INTernAl[:NORMal]
	:CALibration:WAVelength:INTernAl[:IMMediate]? :CALibration:WAVelength:INTernAl[:NORMal]?
Align with Cal	:CALibration:AUTOalign:ENABle
	:CALibration:AUTOalign:ENABle?
WI Cal (Init)	:CALibration:PRESet
	-
Auto Align	:CALibration:ALIGnment :CALibration:ALIGnment:PRESet :CALibration:ALIG[:IMMediate]
	:CALibration:ALIGnment? :CALibration:ALIG[:IMMediate]?
Res Cal	:CALibration:RESCal
	:CALibration:RESCal?
Auto Cal On/Off	- *1
	- *2
Auto Offset On/Off	:CALibration:ZERO[:AUTO]
	:CALibration:ZERO[:AUTO]?
Zero Cal	:CALibration:ZCAL
	:CALibration:ZCAL?

\*1: Auto Cal On/Off cannot be set by the remote control.  
For details, refer to :CALibration:ZCAL.

\*2: Auto Cal On/Off settings cannot be queried by the remote control.  
For details, refer to:CALibration:ZCAL.

**Table 3.2.2-16 Correspondence Between F3 Marker Key and Message**

f1-f8 Key Name	Command
	Query
λMkr_A	:CALCulate:LMARker:X
	:CALCulate:LMARker:X?
λMkr_B	:CALCulate:LMARker:X
	:CALCulate:LMARker:X?
LMkr_C	:CALCulate:LMARker:Y
	:CALCulate:LMARker:Y?
LMkr_D	:CALCulate:LMARker:Y
	:CALCulate:LMARker:Y?
TMkr	:CALCulate:MARKer:TMK:DATA
	:CALCulate:MARKer[1 2 3 4]:X[:WAVelength]
	:CALCulate:MARKer:TMK:DATA?
	:CALCulate:MARKer[1 2 3 4]:X[:WAVelength]?
ΔMkr	:CALCulate:MARKer:FUNcTion:DELTA:XY
	:CALCulate:MARKer:FUNcTion:DELTA:XY?
Erase	:CALCulate:LMARker:AOFF
	:CALCulate:MARKer:AOFF
	-

**Table 3.2.2-17 Correspondence Between F4 Zone Marker Key and Message**

f1-f8 Key Name	Command
	Query
Zone Center	:CALCulate:MARKer:ZONE:WAVelength
	:CALCulate:MARKer:ZONE:WAVelength?
Zone Width	:CALCulate:MARKer:ZONE:WAVelength
	:CALCulate:MARKer:ZONE:WAVelength?
Zone->Span	:CALCulate:MARKer:ZONE:SPAN
	:CALCulate:MARKer:ZONE:SPAN?
Zoom Out/In	:CALCulate:MARKer:ZONE:ZOOM
	:CALCulate:MARKer:ZONE:ZOOM?
Erase	:CALCulate:MARKer:ZONE:ERAcE
	-

**Table 3.2.2-18 Correspondence Between F5 Others Key and Message**

f1-f8 Key Name	Command
	Query
Optical Output On/Off	:SOURce:STATe 'EELED1550'
	:SOURce:STATe 'EELED1550'?
Title	:DISPlay[:WINDow[1]]:TEXT:DATA
	:DISPlay[:WINDow[1]]:TEXT:DATA?

**Table 3.2.2-19 Correspondence Between F6 Config Key and Message\***

f1-f8 Key Name	Command
	Query
Interface Settings	:FORMat:DELimiter
	:FORMat:DELimiter?
Copy Settings	:MMEMemory:STORe:COLor
	:MMEMemory:STORe:GRAPhics:TYPE
	:MMEMemory:STORe:COLor? :MMEMemory:STORe:GRAPhics:TYPE?
System Settings	:SYSTem:BUZZer
	:SYSTem:BUZZer?
System Info	-
	:SYSTem:INFormation?
Option Info	-
	*OPT?
File Operation	<ul style="list-style-type: none"> <li>• Copying file copy :MMEMemory:COpy:CSV :MMEMemory:COpy:GRAPhics :MMEMemory:COpy:SYSInfo :MMEMemory:COpy:XML</li> <li>• Deleting file :MMEMemory:DELeTe :MMEMemory:DELeTe:SYSInfo</li> <li>• Moving file :MMEMemory:MOVe:CSV :MMEMemory:MOVe:GRAPhics :MMEMemory:MOVe:SYSInfo :MMEMemory:MOVe:XML</li> <li>• File protect :MMEMemory:PROTeCt:CSV :MMEMemory:PROTeCt:GRAPhics :MMEMemory:PROTeCt:SYSInfo :MMEMemory:PROTeCt:XML</li> </ul>
	<ul style="list-style-type: none"> <li>• Querying file list :MMEMemory:CATalog?</li> <li>• Querying file protect :MMEMemory:PROTeCt:CSV? :MMEMemory:PROTeCt:GRAPhics? :MMEMemory:PROTeCt:SYSInfo? :MMEMemory:PROTeCt:XML?</li> </ul>
Software Install	-
	-

\*: Before using the Config screen message, send :DISPlay:WINDow:SYSTem CONFIG,ACT. Refer to 3.3.2, “System Management and Measurement Commands”.



**Table 3.2.2-20 Correspondence Between Preset, Save, Recall Key and Message**

f1-f8 Key Name	Command
	Query
Preset	:SYSTem:PRESet
	-
Device	:MMEMory:STORe:ATRACE
	-
Save CSV All Data	:MMEMory:STORe:ATRACE
	-
Save CSV	:MMEMory:STORe:TRACe
	-
Save XML	:MMEMory:STORe:SETTing
	:MMEMory:STORe:TRACe
Device	-
	:MMEMory:DATA :MMEMory:LOAD:ATRACE :MMEMory:LOAD:SETTing
Recall XML	-
	:MMEMory:DATA :MMEMory:LOAD:ATRACE :MMEMory:LOAD:SETTing
	-

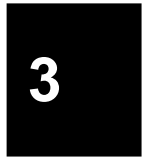

## 3.3 Message Function Category

### 3.3.1 IEEE488.2 Common Messages and Device Dependent Messages

The device messages are classified by the IEEE488.2 common commands and instrument dependent commands.

#### **IEEE488.2 Common Commands and Queries**

The device messages are specified by IEEE488.2-1992. The header first letter of these messages is an asterisk symbol (\*).

Common messages and queries are defined as required or optional by IEEE standard.

The common messages used with MS9740B are only the messages defined as obligatory by the standard.

#### **Device Dependent Messages**

These are the device messages required for the panel operations and measurement functions of MS9740B.

### 3.3.2 System Management and Measurement Commands

The device messages used by this model are divided into system management commands, measurement commands, and neutral commands that can be used anytime.

This machine has a system management mode and a measurement mode. The mode must be switched (:DISPlay:WINDow:SYSTem command) for to the type of command to use

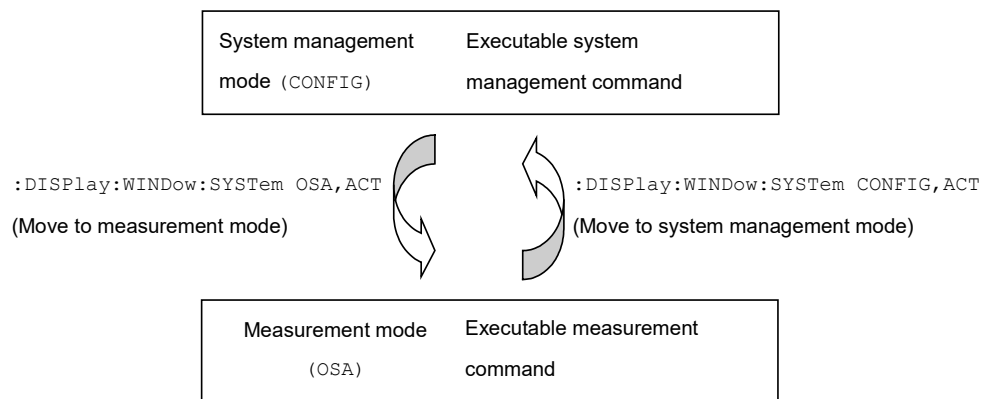

Figure 3.3.2-1 Switching System Status

#### System Management Command

System management commands are the device messages corresponding to the operations set at the **F6 Config** screen. There are commands for the following operations. These commands are listed in Table 3.3.2-2.

- Listing, saving, copying, deleting, moving and protecting of files
- Reading software version and option information
- Setting communications interface and buzzer

To use system management commands, send :DISPlay:WINDow:SYSTem CONFIG,ACT. Measurement commands cannot be used during this time.

#### Measurement Commands

Measurement commands are the device messages for the measurement functions of the optical spectrum analyzer. Measurement commands are commands not listed in Table 3.3.2-1 and Table 3.3.2-2.

To use measurement commands, send :DISPlay:WINDow:SYSTem OSA,ACT. System management commands cannot be used during this time.

### Neutral Commands

Neutral commands for switching between system management commands for saving IEEE488.2 common device messages, saving screen image files and initializing parameters, and measurement commands do not belong to either system management commands or measurement commands. These commands can be used at any time. These commands are listed in Table 3.3.2-1.

The following commands can be used at any time.

**Table 3.3.2-1 Neutral Commands**

*CLS
*ESE
*ESR
*IDN
*OPC
*OPT
*RST
*SRE
*STB
*TST
*WAI
:DISPlay:WINDow:SYSTem
:MMEMory:STORe:GRAPhics
:MMEMory:STORe:GRAPhics:TYPE
:SYSTem:PRESet

The following system management commands can be used after sending :DISPlay:WINDow:SYSTemz CONFIG,ACT.

**Table 3.3.2-2 System Management Command**

```
:FORMat:DELimiter
:MMEMory:CATalog?
:MMEMory:COPI:GRAPhics
:MMEMory:COPI:CSV
:MMEMory:COPI:SYSinfo
:MMEMory:COPI:XML
:MMEMory:DATA
:MMEMory:DELeTe
:MMEMory:DELeTe:SYSinfo
:MMEMory:MOVE:CSV
:MMEMory:MOVE:GRAPhics
:MMEMory:MOVE:SYSinfo
:MMEMory:MOVE:XML
:MMEMory:PROTect:CSV
:MMEMory:PROTect:GRAPhics
:MMEMory:PROTect:SYSinfo
:MMEMory:PROTect:XML
:MMEMory:STORe:COLor
:SYSTem:BUZZer
:SYSTem:INFormation?
:SYSTem:SOFTware:VERSion?
```

## 3.4 Device Message Details

### 3.4.1 IEEE488.2 Common Message

This subsection describes the IEEE 488.2 common messages supported by MS9740B.

\*CLS  
\*ESE  
\*ESR  
\*IDN  
\*OPC  
\*OPT  
\*RST  
\*SRE  
\*STB  
\*TST  
\*WAI

#### \*CLS [Clear Status]

##### Function

(1) The \*CLS common command clears the following registers.

- Standard event status register
- Extended event status register
- Error event register
- Therefore, bits 5, 3, and 2 of status byte register become 0.

The setting value of each enable register does not vary depending on \*CLS.

(2) The \*CLS common command clears the status byte register when sent before the query after the program message terminator.

All unread messages in the output queue are cleared at this time.

The relevant message example indicates below.

```
:DISP:TRAC:X:CENT 1305.8nm  
:DISP:TRAC:X:SPAN 1000nm  
*CLS  
:CENT?
```

##### Syntax

\*CLS

**\*ESE [Event Status Enable]****Function**

This command sets the standard event status enable register.

The setting of 0 to 255 is equivalent to 8-bit binary.

The standard event status mask bit is set to 0.

The command queries the standard event status enable register value.

**Syntax**

```
*ESE <numeric>
```

```
*ESE?
```

```
<numeric> = bit0 + bit1 + bit2 + bit3 + bit4 + bit5 + bit6 + bit7
```

bit7 : $2^7 = 128$	Power-on
bit6 : $2^6 = 64$	Not used
bit5 : $2^5 = 32$	Command error
bit4 : $2^4 = 16$	Execution error
bit3 : $2^3 = 8$	Unique device error
bit2 : $2^2 = 4$	Query error
bit1 : $2^1 = 2$	Not used
bit0 : $2^0 = 1$	Completion of operation

```
Range    0 to 255
```

**Example of Use**

The following example shows how to mask bits 7 to 4 and permit bits 3 to 0. The command data is specified in decimal.

```
*ESE 15
```

```
*ESE?
```

```
>15
```

### **\*ESR [Standard Event Status Register]**

#### **Function**

This command queries the standard event status register value. The standard event status register value is cleared after readout. This value is the logical product of the 8 bits set by \*ESE.

#### **Syntax**

\*ESR?

#### **Example of Use**

The following example queries the value of the standard event status register. The data is the value when an execution error or command error occurs. There are a total of 48 values (bit 5 =  $2^5 = 32$  and bit 4 =  $2^4 = 16$ ) as shown in Table 2.6.3-1.

```
*ESR?  
>48
```

### **\*IDN [Identification]**

#### **Function**

This command queries product supplier name, model name, serial number, and firmware.

#### **Syntax**

\*IDN?

#### **Example of Use**

```
*IDN?  
>ANRITSU,MS9740B,6200123456,1.00.00
```

### **\*OPC [Operation Complete]**

#### **Function**

If a \*OPC command is received, the operation completion bit (bit 0) is set to 1 once all active processes are completed.

If a \*OPC? query is received, 1 is returned once all active processes are complete.

The wait for operation completion set by \*OPC/\*OPC? is disabled after the following events:

- Power ON
- Reception of DCL or SCL on the IEEE488.1 interface
- Reception of the \*CLS command
- Reception of the \*RST command





### **\*RST [Reset]**

#### **Function**

This command initializes the setting conditions. However, the following items are not initialized.

- GPIB address
- Output queue
- Service request enable register
- Standard event status enable register

#### **Syntax**

\*RST

### **\*SRE [Service Request Enable]**

#### **Function**

This command sets the service request enable register.

The setting of 0 to 255 is equivalent to 8-bit binary.

The status byte register mask bit is set to 0.

This command queries the service request enable register value.

#### **Syntax**

\*SRE <numeric>

\*SRE?

<numeric> = bit0 + bit1 + bit2 + bit3 + bit4 + bit5 + bit6 + bit7

bit7 : $2^7 = 128$	Not used
bit6 : $2^6 = 64$	Always 0
bit5 : $2^5 = 32$	Standard event status register
bit4 : $2^4 = 16$	MAV
bit3 : $2^3 = 8$	Error event register
bit2 : $2^2 = 4$	End event register
bit1 : $2^1 = 2$	Not used
bit0 : $2^0 = 1$	Not used

Range 0 to 255

#### **Example of Use**

The following example shows how to mask bits 7, 6, 1, and 0 and permit bits 5 and 2.

```
*SRE 60
```

```
*SRE?
```

```
>60
```

**\*STB [Status Byte]****Function**

This command queries the status byte register.

**Syntax**

\*STB?

**\*TST [Self-Test Query]****Function**

This command queries the results of self-diagnosis.

0 Error does not occur after completing test

1 Test cannot be executed. Even though test can be executed, error occurs.

**Syntax**

\*TST?

**Example of Use**

\*TST?

>0

**\*WAI [Wait to Continue]****Function**

This command holds execution of the next message until processing of the message sent before \*WAI is completed.

**Syntax**

\*WAI

**Example of Use**

INIT ; \*WAI ; :TRACe:DATA:Y? TRA

### 3.4.2 ABORt Subsystem

#### :ABORt

##### Function

This command aborts the following processes:

- Optical alignment
- Wavelength calibration when using an external light source or a reference light source option
- Spectrum measurement

##### Syntax

:ABORt

### 3.4.3 CALCulate Subsystem

The commands in CALCulate subsystem have the following command hierarchy.

:AVERage

  :COUNt

  [:STATe]

:CATegory

:CENTermass

  [:DATA]?

  :STATe

:DATA

  :ANAR?

  :APR?

    :AMTBl?

    :DFBNdw?

    :LDNDw?

    :LDSBco?

    :LDSNr?

    :MPKC?

    :WMPK?

    :WREL?

    :WSGav?

    :WSNR?

    :WTBL?

  :CGAin?

  :CNF?

  :CPOWers?

  :CSNR?

  :CWAVelengths?

```

:NCHannels?
:FWMH
  [:DATA]?
  :STATe
:LMARker
  :AOFF
  :X
  :Y
:MARker
  :AOFF
  :FUNction:DELTA:XY
  :MAXimum
    :SCENter
    :SRLevel
    :SZCenter
  :PP
    :DATA?
    [:STATe]
  :TMK:DATA
  :UNIT
  :ZONE
    :ERACe
    :SPAN
    :WAVelength
    :ZOOM
:MARker[1|2|3|4]
  :FUNction
    :DELTA
      [:STATe]
      :X
        :OFFSet?
        :FREQuency
        [:WAVelength]
      :READout
      :REFerence?
    :Y
      :OFFSet?
      :REFerence?
  :MAXimum
    :LEFT
    :NEXT
    :RIGHT
  :MINimum
    :LEFT

```

:NEXT  
:RIGHt  
:PEXCursion  
  [:PEAK]  
:PIT  
[:STATe]  
:TRACe  
:X  
  :FREQuency  
  :READout  
  [:WAVelength]  
:Y?  
:MATH  
  [:EXPRession][:DEFine]  
:STATe  
:TRC  
:TRF  
:TRG  
  :TRX:NORMalize  
:MAXimum[:STATe]  
:MINimum[:STATe]  
:OFFSet  
  :AMPLifier  
  :SOURce  
:PARAmeter  
  [:CATegory]  
  :AMP  
    :MSElect  
    :PARAmeter  
    :PASE  
    :PIN  
    :POUT  
    :RESCalibrate  
  :DFBLd  
    :SRES  
  :FP  
  :LD  
    :AREA  
    :K  
    :NACHannel  
    :NAFunction  
    :NAUser  
    :NDBWidth  
    :NNORMalize

:NOISe  
 :NPOStion  
 :POINt  
 :SGLevel  
 :SGSelect  
 :SGWavelength  
 :SMSR  
 :SRES  
 :THReshold  
 :LED  
 :NDB  
 :NF  
   :AALGo  
   :AREA  
   :ASE  
   :FALGo  
   :FARea  
   :IOFFset  
   :MARea  
   :MDIFf  
   :MSElect  
   :OBPF  
   :OOFfset  
   :PARAmeter  
   :PDISplay  
   :PIN  
   :POUT  
   :RBWidth  
   :SNOise  
   :TH  
   :WDETECT  
 :PMD  
 :POWER:OFFSet  
 :SMSR  
 :SWENvelope:TH1  
 :SWPKrms  
   :TH  
 :SWTHresh:TH  
 :WDM  
   :AREA  
   :DTYPE  
   :FALGo  
   :MARea  
   :NACHannel

:NAFunction  
:NARea  
:NAUser  
:NBW  
:NNORmalize  
:PDISplay  
:PEXCursion  
:POINT  
:SGLevel  
:SGWavelength  
:SLICe  
:SPOWer  
:TH  
:WFIL  
  :BANDwidth  
  :PEXCursion  
  :RIPple  
  :SGLevel  
  :SGWavelength  
  :SLICe  
  :TCL  
:PEXCursion[:PEAK]  
:SIGMa[:DATA]?  
:SNOise  
:SOURce  
  [:DATA]?  
  :FUNcTION:BWIDth | BANDwidth:NDB  
  :TEST  
:THReshold  
:TPOWer  
  [:DATA]?  
:STATe



**:CALCulate[1|2|3|4|5|6]:AVERage:COUNT****Function**

This command sets the average processing (sweep averaging) count.

This command queries the average processing (sweep averaging) count.

**Syntax**

```
:CALCulate[1|2|3|4|5|6]:AVERage:COUNT <numeric>
```

```
:CALCulate[1|2|3|4|5|6]:AVERage:COUNT?
```

Specify the Active trace (A to F) by specifying a number from 1 to 6.

When omitted, the Active trace is not changed.

Range            1 to 1000

Resolution      1

**Response Data**

```
<numeric>
```

```
<numeric>:      Sweep averaging setting count 1 to 1000
```

**Example of Use**

```
:CALCulate2:AVERage:COUNT 250
```

```
:CALCulate2:AVERage:COUNT?
```

```
>250
```

**:CALCulate[1|2|3|4|5|6]:AVERage[:STATe]**

**Function**

This command sets the Trace Storage Mode to Average.

This command queries whether the Trace Storage Mode is Average.

**Syntax**

:CALCulate[1|2|3|4|5|6]:AVERage[:STATe] 0|1|OFF|ON

:CALCulate[1|2|3|4|5|6]:AVERage[:STATe]?

Specify the Active trace (A to F) by specifying a number from 1 to 6.

When omitted, the Active trace is not changed.

0|OFF: Turns off the Storage Mode—Average.

1|ON: Turns on the Storage Mode—Average.

**Response Data**

0|1

**Example of Use**

:CALCulate3:AVERage:STATe OFF

:CALCulate3:AVERage:STATe?

>0

**:CALCulate:CATegory****Function**

This command sets the type of analysis function or application and performs analysis.

This command queries the type of analysis function or application executed last.

When the analysis has completed, the bit 0 (measurement-end bit) of the end event status register is set to 1.

**Syntax**

```
:CALCulate:CATegory <switch>
```

```
:CALCulate:CATegory?
```

<switch>	Description
0   SWThresh	Executes the Threshold method analysis.
1   SWEnvelope	Executes the Envelope method analysis.
3   SWPKrms	Executes the RMS method analysis
5   DFBLd	Executes the Distributed feedback laser diode application
6   FPLD	Executes the Fabry-Perot laser diode application
7   LED	Executes the Light-emitting diode application
9   POWer	Executes the Spectrum analysis for integral power.
11   WDM	Executes the wavelength division multiplex application.
12   NF	Executes the Optical amplifier (WDM) application.
15   WFPeak	Executes the WDM filter application.
20   NDB	Executes the ndB-Loss method analysis.
21   SMSR	Executes the SMSR method analysis.
22   AMP	Executes the Optical amplifier application.
23   LD	Executes the Laser diode module application.
24   PMD	Executes the Polarization mode dispersion application
OFF	Terminates the display of analysis results or application function. In the response data, it means that the analysis is not executed.

**Response Data**

```
<switch>
```

The switch values in the response data are shown below:

```
0 | 1 | 3 | 5 | 6 | 7 | 9 | 11 | 12 | 15 | 20 | 21 | 22 | 23 | 24 | OFF
```

### **:CALCulate[1|2|3|4|5|6]:CENTermass[:DATA]?**

#### **Function**

This command queries the Mean Wl (FWHM) value measured by the LED application.

#### **Syntax**

```
:CALCulate[1|2|3|4|5|6]:CENTermass[:DATA]?
```

Specify the Active trace (A to F) by specifying a number from 1 to 6. When omitted, the Active trace is not changed.

#### **Response Data**

<numeric>

<numeric>: Mean Wl (FWHM) measured value (m)

#### **Example of Use**

```
:CALCulate4:CENTermass:DATA?  
>+1.31000000E-006
```

### **:CALCulate[1|2|3|4|5|6]:CENTermass:STATE**

#### **Function**

This command sets and queries the On/Off state of the LED application display.

#### **Syntax**

```
CALCulate[1|2|3|4|5|6]:CENTermass:STATE 0|1|OFF|ON  
CALCulate[1|2|3|4|5|6]:CENTermass:STATE?
```

Specify the Active trace (A to F) by specifying a number from 1 to 6. When omitted, the Active trace is not changed.

0|OFF: LED application not displayed  
1|ON: LED application displayed

#### **Response Data**

0|1

#### **Example of Use**

```
:CALCulate2:CENTermass:STATE ON  
:CALCulate2:CENTermass:STATE?  
>1
```

**:CALCulate:DATA?****Function**

This command queries the results measured by the analysis function or application executed last.

**Syntax**

```
:CALCulate:DATA?
```

**Response Data**

For details on response data of the respective applications, refer to the following descriptions:

**When executing the spectrum analysis using Threshold, Envelope or RMS method**

No.	Parameter type	Description
1	<numeric>	Center wavelength (m   Hz)
2	<numeric>	Spectrum width (m   Hz)
3	<numeric>	Longitudinal mode count

When executing the spectrum analysis using Threshold or Envelope method, the third parameter is always -999.99.

**When executing the DFB-LD application**

No.	Parameter type	Description
1	<numeric>	ko: Spectrum width used by RMS method (m)
2	<numeric>	Peak: Peak wavelength (m)
3	<numeric>	Peak: Peak level (dBm)
4	<numeric>	Mode Offset: Difference between side mode wavelength and peak wavelength (m)
5	<numeric>	SMSR: Side mode suppression ratio (dB)

**When executing the FP-LD application**

No.	Parameter type	Description
1	<numeric>	FWHM: Spectrum width using RMS method (m)
2	<numeric>	Peak: Peak wavelength (m)
3	<numeric>	Peak: Peak level (dBm)
4	<numeric>	Mean Wl: Center wavelength (m)
5	<numeric>	Total Power: Spectrum integral power (dBm)
6	<numeric>	Mode (n dB): Number of longitudinal modes

**When executing the LED application**

No.	Parameter type	Description
1	<numeric>	n dB Width: Spectrum width using dB Loss method (m)
2	<numeric>	Peak: Peak wavelength (m)
3	<numeric>	Peak: Peak level (dBm)
4	<numeric>	Mean Wl (FWHM): Center wavelength of spectrum half width (m)
5	<numeric>	Total Power: Spectrum integral power (dBm)

**When executing the spectrum analysis using Spectrum Power**

No.	Parameter type	Description
1	<numeric>	Pow: Spectrum integral power (dBm)

**When executing the WDM application (MultiPeak)**

No.	Parameter type	Description
1	<numeric>	PeakCount
2	<numeric>	Wl: First peak wavelength (m)
3	<numeric>	Level: First peak level (dBm)
		:
2n	<numeric>	Wl: n th peak wavelength (m)
2n+1	<numeric>	Level: n th peak level (dBm)

**When executing the WDM application (SNR)**

No.	Parameter type	Description
1	<numeric>	Peak Count
2	<numeric>	Wl: First peak wavelength (m)
3	<numeric>	Level: First peak level (dBm)
4	<numeric>	SNR: First signal to noise ratio (dB)
5	<switch>= AVERAGE LEFT  RIGHT ERR  FITTING	L/R:: First noise detection method ERR when noise position off screen at noise detection FITTING when Noise Parameter Detection Type is Area
		:
4n-2	<numeric>	Wl: n th peak wavelength (m)
4n-1	<numeric>	Level: n th peak level (dBm)
4n	<numeric>	SNR: nth peak signal to noise ratio (dB)
4n+1	<switch>= AVERAGE LEFT  RIGHT ERR  FITTING	L/R:: nth peak noise detection method ERR when noise position off screen at noise detection FITTING when Noise Parameter Detection Type is Area

**When executing the WDM application (Relative)**

No.	Parameter type	Description
1	<numeric>	Peak Count
2	<numeric>	Ref: Reference peak number
3	<numeric>	Wl: First peak wavelength (m)
4	<numeric>	Spacing: Spacing of first peak wavelength (m)
5	<numeric>	Wl-Ref: Wavelength difference between first peak and reference peak (m)
6	<numeric>	Level: First peak level (dBm)
7	<numeric>	Level-Ref: First relative level (dB)
:		
5n-2	<numeric>	Wl: nth peak wavelength (m)
5n-1	<numeric>	Spacing: Spacing of nth peak wavelength (m)
5n	<numeric>	Wl-Ref: Differences between nth peak and reference peak wavelength (m)
5n+1	<numeric>	Level: nth peak level (dBm)
5n+2	<numeric>	Level-Ref: nth relative level (dB)

The first peak wavelength spacing is normally 0.

**When executing the WDM application (Table)**

No.	Parameter type	Description
1	<numeric>	No. Channel Number 1
2	<numeric>	SignalWl: First peak wavelength (m)
3	<numeric>	Level: First peak level (dBm)
4	<numeric>	Spacing Wl: First peak wavelength spacing (m)
5	<numeric>	-999.99
6	<numeric>	-999.99
7	<numeric>	SNR: First peak signal to noise ratio (dB)
:		
7n-6	<numeric>	No. Channel Number n
7n-5	<numeric>	Signal Wl: nth peak wavelength (m)
7n-4	<numeric>	Level: nth peak level (dBm)
7n-3	<numeric>	Spacing Wl: nth peak wavelength spacing (m)
7n-2	<numeric>	-999.99
7n-2	<numeric>	-999.99
7n	<numeric>	SNR: nth peak signal to noise ratio (dB)

If there is no peak, the returned values are wavelength  $\lambda = -1$ , level  $L = -999.99$  or  $999.99$ .

**When executing the spectrum analysis using ndB-Loss method**

No.	Parameter type	Description
1	<numeric>	Center wavelength (m   Hz)
2	<numeric>	Spectrum width (m   Hz)
3	<numeric>	Longitudinal mode count

**When executing the spectrum analysis using SMSR**

No.	Parameter type	Description
1	<numeric>	Wavelength difference (m   Hz)
2	<numeric>	Level difference (dB)

**When executing the Optical Amp application**

No.	Parameter type	Description
1	<numeric>	Gain: Gain (dB)
2	<numeric>	NF: Noise figure (dB)
3	<numeric>	Signal Wl: Peak wavelength of amplified light (m)
4	<numeric>	ASE Lvl/(Res): ASE level of amplified light (dBm)
5	<numeric>	Res: Actual resolution used for the NF calculation (m)

**When executing the Optical AMP (WDM) application**

No.	Parameter type	Description
1	<numeric>	No: Channel number 1
2	<numeric>	Wl: 1st peak wavelength (m)
3	<numeric>	Pin: 1st optical level input (dBm)
4	<numeric>	Pout: 1st optical level output (dBm)
5	<numeric>	ASE: 1st amplified spontaneous emission level (dBm)
6	<numeric>	Res: 1st actual resolution (m)
7	<numeric>	Gain: 1st gain (dB)
8	<numeric>	NF: 1st noise figure (dB)
	:	
8n-7	<numeric>	No: Channel number n
8n-6	<numeric>	Wl: n th peak wavelength (m)
8n-5	<numeric>	Pin: n th optical level input (dBm)
8n-4	<numeric>	Pout: n th optical level output (dBm)
8n-3	<numeric>	ASE: n th amplified spontaneous emission level (dBm)
8n-2	<numeric>	Res: n th actual resolution (m)
8n-1	<numeric>	Gain: n th gain (dB)
8n	<numeric>	NF: n th noise figure (dB)



**When executing the LD Module application**

No.	Parameter type	Description
1	<numeric>	K $\sigma$ : Spectrum width (m)
2	<numeric>	$\sigma$ : Standard deviation (m)
3	<numeric>	2nd Peak: Side mode wavelength (m)
4	<numeric>	2nd Peak: Side mode level (dBm)
5	<numeric>	Mode Offset: Differences between side mode wavelength and peak wavelength (m)
6	<numeric>	SMSR: Side mode suppression ratio (dB)
7	<numeric>	Peak: Peak wavelength (m)
8	<numeric>	Peak: Peak level (dBm)
9	<numeric>	SNR(/*. *nm): Signal-noise ratio (noise level per noise bandwidth) (dB)
10	<numeric>	SNR (Res **nm): Signal to noise ratio (true value) (dB)

**When executing the PMD application**

No.	Parameter type	Description
1	<numeric>	Diff Group Delay: $\Delta t$ differential group delay time (s)
2	<numeric>	1st Peak Wl: Wavelength of 1st peak (m)
3	<numeric>	Last Peak Wl: Wavelength of last peak (m)
4	<numeric>	Peak Count

**When executing the WDM Filter application**

No.	Parameter type	Description	
1	<numeric>	PeakCount:	Channel count 1
2	<numeric>	No:	Channel number
3	<numeric>	CH Wl:	1st channel wavelength (m)
4	<numeric>	Spacing:	1st channel spacing (m)
5	<numeric>	PK Wl:	1st peak wavelength (m)
6	<numeric>	CH Lvl:	1st channel level (dBm) or 1st channel loss (dB)
7	<numeric>	x dB BW:	1st channel bandwidth (Cut Level A) (m)
8	<numeric>	y dB BW:	1st channel bandwidth (Cut Level B) (m)
9	<numeric>	x dB Wl:	Threshold wavelength of the 1st channel (Cut Level A) (m)
10	<numeric>	y dB Wl:	Threshold wavelength of the 1st channel (Cut Level B) (m)
11	<numeric>	PK Lvl:	Peak level (dBm) or minimum loss (dB) of the 1st channel
12	<numeric>	Ripple:	1st channel ripple (dB)
	:		
11n-9	<numeric>	No:	Channel number
11n-8	<numeric>	CH Wl:	nth channel wavelength (m)
11n-7	<numeric>	Spacing:	nth channel interval (m)
11n-6	<numeric>	PK Wl:	nth peak wavelength (m)
11n-5	<numeric>	CH Lvl:	nth channel level (dBm) or nth channel loss (dB)
11n-4	<numeric>	x dB BW:	nth channel bandwidth (Cut Level A) (m)
11n-3	<numeric>	y dB BW:	nth channel bandwidth (Cut Level B) (m)
11n-2	<numeric>	x dB Wl:	nth channel threshold wavelength (Cut Level A) (m)
11n-1	<numeric>	y dB Wl:	nth channel threshold wavelength (Cut Level B) (m)
11n	<numeric>	PK Lvl:	Peak level (dBm) or minimum loss (dB) of nth channel
11n+1	<numeric>	Ripple:	nth channel ripple (dB)

The spacing of the 1st peak wavelength is always “0”.

**Example of Use**

```

:CALCulate:CATegory SWThresh
:CALCulate:DATA?
>+1.55018500E-006,+9.60000000E-011,-999.99
:CALCulate:CATegory SMSR
:CALCulate:DATA?
>+1.03000000E-009,+6.32600000E+001
:CALCulate:CATegory PMD
:CALCulate:DATA?
>+4.73010000E-015,1.53899000E-006,1.55678000E-006,13

```

**:CALCulate:DATA:ANAR?****Function**

This command queries the spectrum analysis result.

**Syntax**

```
:CALCulate:DATA:ANAR?
```

**Response Data**

```
<numeric>,<numeric>[,<numeric>]
```

The details of spectrum analysis method and numeric values are as follows.

**Table 3.4.3-1 Response of CALCulate:DATA:ANAR?**

Analysis method	Numeric value 1	Numeric value 2	Numeric value 3
Envelope method	Center wavelength (m   Hz)	Spectrum width (m   Hz)	None
ndB Loss method	Center wavelength (m   Hz)	Spectrum width (m   Hz)	Longitudinal mode count
Integral power	Power (dBm)	Center wavelength (m   Hz)	None
RMS method	Center wavelength (m   Hz)	Spectrum width (m   Hz)	Standard deviation $\sigma$
SMSR method	Wavelength difference (m   Hz)	Level difference (dB)	None
Threshold method	Center wavelength (m   Hz)	Spectrum width (nm)	None

The center wavelength, spectrum width and wavelength difference are -1 when analysis cannot be performed. The level difference when analysis cannot be performed is -999.99.

**Example of Use**

Queries analysis results at envelope method

:CALCulate:DATA:ANAR?

>+1.56522300E-006,+1.08000000E-009

Queries analysis results at ndB Loss method

:CALCulate:DATA:ANAR?

>+1.55010000E-006,1.28400000E-008,9

Queries analysis results at integral power

:CALCulate:DATA:ANAR?

>+1.54400000E+000,+1.55010000E-006

Queries analysis results at RMS method

:CALCulate:DATA:ANAR?

>+1.35059300E-006,+6.30120000E-009,+2.67600000E-009

Queries SMSR analysis

:CALCulate:DATA:ANAR?

>-9.20000000E-010,+3.87400000E+001

Queries SMSR analysis results (when cannot perform analysis)

:CALCulate:DATA:ANAR?

>-1,-999.99

Queries analysis results at Threshold method

:CALCulate:DATA:ANAR?

>+1.29843000E-006,+2.35200000E-008

**:CALCulate:DATA:APR?****Function**

This command queries the results analyzed by the application executed last by the :CALCulate:CATegory command.

**Syntax**

:CALCulate:DATA:APR?

**Response Data**

Response data varies among applications.

For details on response data of the respective applications, refer to the following descriptions:

**When executing the Optical Amp application**

No.	Parameter type	Description	
1	<numeric>	Gain:	Gain (dB)
2	<numeric>	NF:	Noise figure (dB)
3	<numeric>	Signal Wl:	Peak wavelength of amplified light (m)
4	<numeric>	ASE Lvl/(Res):	ASE level of amplified light (dBm)
5	<numeric>	Res:	Actual resolution used for the NF calculation (m)

**When executing the Optical AMP (WDM) application**

No.	Parameter type	Description
1	<numeric>	PeakCount: Number of peaks
2	<numeric>	Gain Slope: The gain slope (dB/nm)
3	<numeric>	Gain Vari: Difference between the maximum and the minimum gain values in the entire signal spectrum (dB)
4	<numeric>	Wl: 1st peak wavelength (m)
5	<numeric>	Pin: 1st optical level input (dBm)
6	<numeric>	Pout: 1st optical level output (dBm)
7	<numeric>	ASE: 1st amplified spontaneous emission level (dBm)
8	<numeric>	Res: 1st actual resolution (m)
9	<numeric>	Gain: 1st gain (dB)
10	<numeric>	NF: 1st Noise Figure (dB)
	:	
7n-3	<numeric>	Wl: n th peak wavelength (m)
7n-2	<numeric>	Pin: n th optical level input (dBm)
7n-1	<numeric>	Pout: n th optical level output (dBm)
7n	<numeric>	ASE: n th amplified spontaneous emission level (dBm)
7n+1	<numeric>	Res: n th actual resolution (m)
7n+2	<numeric>	Gain: n th gain (dB)
7n+3	<numeric>	NF: n th Noise Figure (dB)

**When executing the DFB-LD application**

No.	Parameter type	Description
1	<numeric>	SMSR: Side mode suppression ratio (dB)
2	<numeric>	ko: Spectrum width used by RMS method (m)
3	<numeric>	Peak: Peak wavelength (m)
4	<numeric>	Peak: Peak level (dBm)
5	<numeric>	2nd Peak: Side mode wavelength (m)
6	<numeric>	2nd Peak: Side mode level (dBm)
7	<numeric>	Mode Offset: differences between side mode wavelength and peak wavelength (m)
8	<numeric>	Stop Band: Wavelength difference of both side modes of peak wavelength (m)
9	<numeric>	Center Offset: Difference of means of peak wavelength and both side modes wavelength (m)
10	<numeric>	σ: Standard deviation (m)

**When executing the FP-LD application**

No.	Parameter type	Description
1	<numeric>	FWHM: Spectrum width using RMS method (m)
2	<numeric>	Mean Wl: Center wavelength (m)
3	<numeric>	Peak: Peak wavelength (m)
4	<numeric>	Peak: Peak level (dBm)
5	<numeric>	Mode (n dB): Number of longitudinal modes
6	<numeric>	Mode Spacing: longitudinal mode interval (gap) (m)
7	<numeric>	Total Power: Spectrum integral power (dBm)
8	<numeric>	$\sigma$ : Standard deviation using RMS method (m)

**When executing the LD Module application**

No.	Parameter type	Description
1	<numeric>	K $\sigma$ : Spectrum width (m)
2	<numeric>	$\sigma$ : Standard deviation (m)
3	<numeric>	2nd Peak: Side mode wavelength (m)
4	<numeric>	2nd Peak: Side mode level (dBm)
5	<numeric>	Mode Offset: Differences between side mode wavelength and peak wavelength (m)
6	<numeric>	SMSR: Side mode suppression ratio (dB)
7	<numeric>	Peak: Peak wavelength (m)
8	<numeric>	Peak: Peak level (dBm)
9	<numeric>	SNR(/*.*nm): Signal-noise ratio (noise level per noise bandwidth) (dB)
10	<numeric>	SNR (Res **nm): Signal to noise ratio (true value) (dB)

**When executing the LED application**

No.	Parameter type	Description
1	<numeric>	Mean Wl (FWHM): Center wavelength of spectrum half width (m)
2	<numeric>	Mean Wl (ndB): Center wavelength using ndB Loss method (m)
3	<numeric>	FWHM (n $\sigma$ ): Spectrum half width for RMS (m)
4	<numeric>	n dB Width: Spectrum width using dB Loss method (m)
5	<numeric>	Peak: Peak wavelength (m)
6	<numeric>	Peak: Peak level (dBm)
7	<numeric>	PkDens (/1nm): Spectrum density max. value (dBm)
8	<numeric>	Total Power: Spectrum integral power (dBm)
9	<numeric>	$\sigma$ : Standard deviation differences using RMS method (m)

**When executing the PMD application**

No.	Parameter type	Description
1	<numeric>	Diff Group Delay: $\Delta t$ differential group delay time (s)
2	<numeric>	1st Peak Wl: Wavelength of 1st peak (m)
3	<numeric>	Last Peak Wl: Wavelength of last peak (m)
4	<numeric>	Peak Count

**When executing the WDM application (MultiPeak)**

No.	Parameter type	Description
1	<numeric>	PeakCount
2	<numeric>	Wl: First peak wavelength (m)
3	<numeric>	Level: First peak level (dBm)
	:	
2n	<numeric>	Wl: n th peak wavelength (m)
2n+1	<numeric>	Level: n th peak level (dBm)



**When executing the WDM application (SNR)**

No.	Parameter type	Description
1	<numeric>	Peak Count
2	<numeric>	Wl: First peak wavelength (m)
3	<numeric>	Level: First peak level (dBm)
4	<numeric>	SNR: First signal to noise ratio (dB)
5	<switch> = AVERAGE   LEFT   RIGHT   ERR   FITTING	L/R: First noise detection method ERR when noise position off screen at noise detection FITTING when Noise Parameter Detection Type is Area
:		
4n-2	<numeric>	Wl: n th peak wavelength (m)
4n-1	<numeric>	Level: n th peak level (dBm)
4n	<numeric>	SNR: nth peak signal to noise ratio (dB)
4n+1	<switch>= AVERAGE   LEFT   RIGHT   ERR   FITTING	L/R: nth peak noise detection method ERR when noise position off screen at noise detection FITTING when Noise Parameter Detection Type is Area

**When executing the WDM application (Relative)**

No.	Parameter type	Description
1	<numeric>	Peak Count
2	<numeric>	Ref: Reference peak number
3	<numeric>	Wl: First peak wavelength (m)
4	<numeric>	Spacing: Spacing of first peak wavelength (m)
5	<numeric>	Wl-Ref: Wavelength difference between first peak and reference peak (m)
6	<numeric>	Level: First peak level (dBm)
7	<numeric>	Level-Ref: First relative level (dB)
:		
5n-2	<numeric>	Wl: nth peak wavelength (m)
5n-1	<numeric>	Spacing: Spacing of nth peak wavelength (m)
5n	<numeric>	Wl-Ref: Differences between nth peak and reference peak wavelength (m)
5n+1	<numeric>	Level: nth peak level (dBm)
5n+2	<numeric>	Level-Ref: nth relative level (dB)

The first peak wavelength spacing is normally 0.

**When executing the WDM application (Table)**

No.	Parameter type	Description
1	<numeric>	PeakCount
2	<numeric>	SignalWl: First peak wavelength (m)
3	<numeric>	Signal Frq: First peak frequency (Hz)
4	<numeric>	Level: First peak level (dBm)
5	<numeric>	SNR: First peak signal to noise ratio (dB)
6	<switch>= AVERAGE  LEFT RIGHT  ERR FITTING	L/R: First peak noise detection method ERR when noise position off screen at noise detection FITTING when Noise Parameter Detection Type is Area
7	<numeric>	Spacing Wl: First peak wavelength spacing (m)
8	<numeric>	Spacing Frq: First peak frequency spacing (Hz)
	:	
7n-5	<numeric>	Signal Wl: nth peak wavelength (m)
7n-4	<numeric>	Signal Frq: nth peak frequency (Hz)
7n-3	<numeric>	Level: nth peak level (dBm)
7n-2	<numeric>	SNR: nth peak signal to noise ratio (dB)
7n-1	<switch> = AVERAGE LEFT  RIGHT ERR	L/R: nth peak noise detection method ERR when noise position off screen at noise detection
7n	<numeric>	Spacing Wl: nth peak wavelength spacing (m)
7n+1	<numeric>	Spacing Frq: nth peak frequency spacing (Hz)

If there is no peak, the returned values are wavelength  $\lambda = -1$ , level  $L = -999.99$  or  $999.99$ .

**When executing the WDM Filter application**

No.	Parameter type	Description
1	<numeric>	PeakCount: Channel count
2	<numeric>	No: Channel number 1
3	<numeric>	CH Wl: 1st channel wavelength (m)
4	<numeric>	Spacing: 1st channel spacing (m)
5	<numeric>	PK Wl: 1st peak wavelength (m)
6	<numeric>	CH Lvl: 1st channel level (dBm) or 1st channel loss (dB)
7	<numeric>	x dB BW: 1st channel bandwidth (Cut Level A) (m)
8	<numeric>	y dB BW: 1st channel bandwidth (Cut Level B) (m)
9	<numeric>	x dB Wl: Threshold wavelength of the 1st channel (Cut Level A) (m)
10	<numeric>	y dB Wl: Threshold wavelength of the 1st channel (Cut Level B) (m)
11	<numeric>	PK Lvl: Peak level (dBm) or minimum loss (dB) of the 1st channel
12	<numeric>	Ripple: 1st channel ripple (dB)
	:	
11n-9	<numeric>	No: Channel number
11n-8	<numeric>	CH Wl: nth channel wavelength (m)
11n-7	<numeric>	Spacing: nth channel interval (m)
11n-6	<numeric>	PK Wl: nth peak wavelength (m)
11n-5	<numeric>	CH Lvl: nth channel level (dBm) or nth channel loss (dB)
11n-4	<numeric>	x dB BW: nth channel bandwidth (Cut Level A) (m)
11n-3	<numeric>	y dB BW: nth channel bandwidth (Cut Level B) (m)
11n-2	<numeric>	x dB Wl: nth channel threshold wavelength (Cut Level A) (m)
11n-1	<numeric>	y dB Wl: nth channel threshold wavelength (Cut Level B) (m)
11n	<numeric>	PK Lvl: Peak level (dBm) or minimum loss (dB) of nth channel
11n+1	<numeric>	Ripple: nth channel ripple (dB)

The spacing of the 1st peak wavelength is always “0”.

### **:CALCulate:DATA:APR:AMTBI?**

#### **Function**

This command queries the results analyzed by the Optical AMP (WDM) application, specifying the peak No.

#### **Syntax**

`:CALCulate:DATA:APR:AMTBI? <numeric>`

<numeric>: Peak No. to query the analysis results

#### **Response Data**

<numeric>,<numeric>,<numeric>,<numeric>,<numeric>,<numeric>,<numeric>,<numeric>

No.	Parameter type	Description
1	<numeric>	Wl: Peak wavelength of specified peak No. (m)
2	<numeric>	Pin: Optical input level (dBm) for the specified peak No.
3	<numeric>	Pout: Optical output level (dBm) for the specified peak No.
4	<numeric>	ASE: Amplified spontaneous emission level (dBm) for the specified peak No.
5	<numeric>	Res: Actual resolution (m) for the specified peak No.
6	<numeric>	Gain: Gain (dB) for the specified peak No.
7	<numeric>	NF: Noise Figure (dB) for the specified peak No.

#### **Example of Use**

```
:CALCulate:DATA:APR:AMTBI? 1
>+1.54681500E-006,-3.40600000E+001,-8.72000000E+000,-2.5
2900000E+001,8.90000000E-011,+2.58800000E001,+7.26000000
E+000
```

**:CALCulate:DATA:APR:DFBNdw?****Function**

This command queries the DFB-LD application results.

This command queries the ndB-Width analysis result, which cannot be queried with the:CALCulate:DATA:APR?.

**Syntax**

```
:CALCulate:DATA:APR:DFBNdw?
```

**Response Data**

```
<numeric>,<numeric>,...,<numeric>
```

No.	Parameter type	Description	
1	<numeric>	SMSR:	Side mode suppression ratio (dB)
2	<numeric>	$K\sigma$ :	Spectrum width (m)
3	<numeric>	Peak:	Peak wavelength (m)
4	<numeric>	Peak:	Peak level (dBm)
5	<numeric>	2nd Peak:	Side mode wavelength (m)
6	<numeric>	2nd Peak:	Side mode level (dBm)
7	<numeric>	Mode Offset:	Difference between side mode wavelength and peak wavelength (m)
8	<numeric>	Stop Band:	Wavelength difference of both side modes of peak wavelength (m)
9	<numeric>	Center Offset:	Difference of means of peak wavelength and both side modes wavelength (m)
10	<numeric>	$\sigma$ :	Standard deviation (m)
11	<numeric>	NDW:	Spectrum wavelength width at cut level (m)

**Example of Use**

```
:CALCulate:DATA:APR:DFBNdw?
```

```
>+3.30500000E+001,+2.33700000E-009,+1.55145800E-006,-3.45000000E+000,+1.55366400E-006,-3.65000000E+001,+2.20600000E-009,+7.897000000E-009,1.13400000E-010,+7.61000000E-010,+9.94000000E-010
```

**:CALCulate:DATA:APR:LDNDw?**

This command queries the LD Module application results.  
 The response data to this command has the following data appended to the response data to the :CALCulate:DATA:APR? command.  
 Signal, NDW

**Syntax**

:CALCulate:DATA:APR:LDNDw?

**Response Data**

<numeric>, <numeric>, ..., <numeric>

No.	Parameter type	Description	
1	<numeric>	Kσ:	Spectrum width (m)
2	<numeric>	σ:	Standard deviation (m)
3	<numeric>	2nd Peak:	Side mode wavelength (m)
4	<numeric>	2nd Peak:	Side mode level (dBm)
5	<numeric>	Mode Offset:	Difference between side mode wavelength and peak wavelength (m)
6	<numeric>	SMSR:	Side mode suppression ratio (dB)
7	<numeric>	Peak:	Peak wavelength (m)
8	<numeric>	Peak:	Peak level (dBm)
9	<numeric>	SNR (/*. *nm):	Signal-noise ratio (noise level per noise bandwidth) (dB)
10	<numeric>	SNR(Res **nm):	Signal-noise ratio (actual value) (dB)
11	<numeric>	Signal:	Signal wavelength (m)
12	<numeric>	Signal:	Signal level (dBm)
13	<numeric>	NDW:	Spectrum wavelength width at cut level (m)

**Example of Use**

```
:CALCulate:DATA:APR:LDNDw?
>+1.25000000E-009,+5.30000000E-011,+1.54611900E-006,-3.3
3100000E+001,+2.10400000E-009,+3.95600000E+001,+1.548223
00E-006,+6.25000000E+000,+4.46100000E+001,+4.16500000E+0
01,+1.54820900E-006,+5.22000000E+000,+8.60000000E-011
```

**:CALCulate:DATA:APR:LDSBco?**

**Function**

This command queries the LD Module application results.  
 The :CALCulate:DATA:APR? command response plus the below data is returned to this command.

Signal, NDW, Stop Band, Center Offset

### Syntax

```
:CALCulate:DATA:APR:LDSBco?
```

### Response Data

```
<numeric>,<numeric>,...,<numeric>
```

No.	Parameter type	Description	
1	<numeric>	K $\sigma$ :	Spectrum width (m)
2	<numeric>	$\sigma$ :	Standard deviation (m)
3	<numeric>	2nd Peak:	Side mode wavelength (m)
4	<numeric>	2nd Peak:	Side mode level (dBm)
5	<numeric>	Mode Offset:	Difference between side mode wavelength and peak wavelength (m)
6	<numeric>	SMSR:	Side mode suppression ratio (dB)
7	<numeric>	Peak:	Peak wavelength (m)
8	<numeric>	Peak:	Peak level (dBm)
9	<numeric>	SNR(/*. *nm):	Signal-noise ratio (noise level per noise bandwidth) (dB)
10	<numeric>	SNR(Res **nm):	Signal-noise ratio (actual value) (dB)
11	<numeric>	Signal:	Signal wavelength (m)
12	<numeric>	Signal:	Signal level (dBm)
13	<numeric>	NDW:	Spectrum wavelength width at cut level (m)
14	<numeric>	Stop Band:	Wavelength difference of both side modes of peak wavelength (m)
15	<numeric>	Center Offset:	Difference of means of peak wavelength and both side modes wavelength (m)

### Example of Use

```
:CALCulate:DATA:APR:LDSBco?
```

```
>+1.25000000E-010,+5.30000000E-011,+1.54611900E-006,-3.3  
3100000E+001,+2.10400000E+000,+3.95600000E+001,+1.548223  
00E-006,+6.25000000E+000,+4.46100000E+001,+4.16500000E+0  
01,+1.54820900E-006,+5.22000000E+000,+8.60000000E-011,+4  
.12700000E-009,1.44400000E-010
```

## :CALCulate:DATA:APR:LDSNr?

### Function

This command queries the LD Module application results.

The :CALCulate:DATA:APR? command response plus the below data is returned to this command.

Signal

### Syntax

:CALCulate:DATA:APR:LDSNr?

### Response Data

<numeric>,<numeric>,...,<numeric>

No.	Parameter type	Description	
1	<numeric>	K $\sigma$ :	Spectrum width (m)
2	<numeric>	$\sigma$ :	Standard deviation (m)
3	<numeric>	2nd Peak:	Side mode wavelength (m)
4	<numeric>	2nd Peak:	Side mode level (dBm)
5	<numeric>	Mode Offset:	Difference between side mode wavelength and peak wavelength (m)
6	<numeric>	SMSR:	Side mode suppression ratio (dB)
7	<numeric>	Peak:	Peak wavelength (m)
8	<numeric>	Peak:	Peak level (dBm)
9	<numeric>	SNR(*.*nm):	Signal-noise ratio (noise level per noise bandwidth) (dB)
10	<numeric>	SNR(Res **nm):	Signal-noise ratio (actual value) (dB)
11	<numeric>	Signal:	Signal wavelength (m)
12	<numeric>	Signal:	Signal level (dBm)

### Example of Use

:CALCulate:DATA:APR:LDSNr?

```
>+2.37210000E-008,+3.90800000E-009,+1.35920000E-006,-1.64400000E+001,+8.90000000E-010,+4.12000000E+000,+1.35030000E-006,-1.23100000E+001,+3.10100000E+001,+3.05900000E+001,+1.35030000E-006,-1.23100000E+001
```



**:CALCulate:DATA:APR:MPKC?****Function**

This command queries the number of the detected multi peaks.

**Syntax**

```
:CALCulate:DATA:APR:MPKC?
```

**Response Data**

```
<numeric>
```

```
<numeric>: Multi peak count
```

**Example of Use**

```
:CALCulate:DATA:APR:MPKC?
>1
```

**:CALCulate:DATA:APR:WMPK?****Function**

This command queries the analysis results at the MultiPeak display of the WDM application function for the specified peak No.

**Syntax**

```
:CALCulate:DATA:APR:WMPK? <numeric>
```

```
<numeric>: No. of peak to query analysis results
```

**Response Data**

```
<numeric>,<numeric>
```

No.	Parameter type	Description
1	<numeric>	Peak wavelength of specified peak (m)
2	<numeric>	Peak level of specified peak (dBm)

**Example of Use**

```
:CALCulate:DATA:APR:WMPK? 10
>+1.55276000E-006,-1.90200000E+000
```

### **:CALCulate:DATA:APR:WREL?**

#### **Function**

This command queries the analysis results at the Relative display of the WDM application function for the specified peak No.

#### **Syntax**

`:CALCulate:DATA:APR:WREL? <numeric>`

<numeric>: No. of peak to query analysis results

#### **Response Data**

`<numeric>,<numeric>,<numeric>,<numeric>,<numeric>`

No.	Parameter type	Description
1	<numeric>	Peak wavelength of specified peak No. (m)
2	<numeric>	Specified peak No. peak wavelength spacing (m)
3	<numeric>	Wavelength difference between specified No. peak wavelength and reference peak (m)
4	<numeric>	Specified peak No. peak level (dBm)
5	<numeric>	Specified peak No. relative level (dB)

#### **Example of Use**

```
:CALCulate:DATA:APR:WREL? 2
>+1.53845000E-006,+5.80000000E-010,+5.80000000E-010,-2.1
7900000E+001,-2.96000000E+000
```

**:CALCulate:DATA:APR:WSGav?****Function**

This command queries the gain variation results at the SNR display of the WDM application function.

**Syntax**

```
:CALCulate:DATA:APR:WSGav?
```

**Response Data**

```
<numeric>
```

<numeric>: Gain variation (dB)  
Difference between max and min values of peaks in full signal spectrum

**Example of Use**

```
:CALCulate:DATA:APR:WSGav?  
>+1.02300000E+001
```

### **:CALCulate:DATA:APR:WSNR?**

#### **Function**

This command queries the analysis results at the SNR display of the WDM application function for the specified peak No.

#### **Syntax**

`:CALCulate:DATA:APR:WSNR? <numeric>`

`<numeric>`: No. of peak to query analysis results

#### **Response Data**

`<numeric>,<numeric>,<numeric>,<numeric>`

No.	Parameter type	Description
1	<code>&lt;numeric&gt;</code>	Peak wavelength of specified peak (m)
2	<code>&lt;numeric&gt;</code>	Peak level of specified peak (dBm)
3	<code>&lt;numeric&gt;</code>	Signal to noise ratio of specified peak (dB)
4	<code>&lt;switch&gt;= AVERAGE   LEFT   RIGHT   ERR   FITTING</code>	Noise detection method for specified peak ERR when noise position off screen at noise detection FITTING when Noise Parameter Detection Type is Area

#### **Example of Use**

`:CALCulate:DATA:APR:WSNR? 1`

`>+1.55276000E-006,-1.85300000E+000,+2.15400000E+001,RIGH  
T`

**:CALCulate:DATA:APR:WTBL?****Function**

This command queries the analysis results at the Table display of the WDM application function for the specified peak No.

**Syntax**

```
:CALCulate:DATA:APR:WTBL? <numeric>
```

<numeric>: No. of peak to query analysis results

**Response Data**

```
<numeric>,<numeric>,<numeric>,<numeric>,<numeric>,<numeric>,<numeric>,<numeric>
```

No.	Parameter type	Description
1	<numeric>	Specified peak No. peak wavelength (m)
2	<numeric>	Specified peak No. peak frequency (Hz)
3	<numeric>	Peak level of specified peak (dBm)
4	<numeric>	Signal to noise ratio of specified peak (dB)
5	<switch>= AVERAGE   LEFT   RIGHT   ERR   FITTING	Specified peak No. noise detection method ERR when noise position off screen at noise detection FITTING when Noise Parameter Detection Type is Area
6	<numeric>	Specified peak No. peak wavelength spacing (m)
7	<numeric>	Specified peak No. peak frequency spacing (Hz)

**Example of Use**

```
:CALCulate:DATA:APR:WTBL? 1
>+1.55276000E-006,+1.93070700e+014,-1.90200000E+000,+5.14000000E+001,RIGHT,0,0
```

### **:CALCulate:DATA:CGain?**

#### **Function**

This command queries the gain of all signals measured by the Optical AMP (WDM) application.

#### **Syntax**

:CALCulate:DATA:CGain?

#### **Response Data**

<numeric>, ..., <numeric>

<numeric>: Gain (dB)

#### **Example of Use**

:CALCulate:DATA:CGain?

>1.25680000+001,1.26950000E+001,1.26040000E+001, ..., 1.2559  
0000E+001

### **:CALCulate:DATA:CNF?**

#### **Function**

This command queries the noise figure of all signals measured by the Optical AMP (WDM) application.

#### **Syntax**

:CALCulate:DATA:CNF?

#### **Response Data**

<numeric>, ..., <numeric>

<numeric>: Noise figure (dB)

#### **Example of Use**

:CALCulate:DATA:CNF?

>8.23560000+000,8.52230000E+000,8.88530000E+000, ..., 8.1289  
0000E+000

**:CALCulate:DATA:CPOWers?****Function**

This command queries the level of all signals measured by the Optical AMP (WDM), WDM or WDM Filter application.

**Syntax**

```
:CALCulate:DATA:CPOWers?
```

**Response Data**

```
<numeric>, ..., <numeric>
```

```
<numeric>:
```

When executing the Optical AMP (WDM) application	Optical input level(dBm)
When executing the WDM application	Peak level (dBm)
When executing the WDM Filter application	Channel level (dBm) or channel loss (dB)

**Example of Use**

```
:CALCulate:DATA:CPOWers?
```

```
>-3.98014973E+000, -3.48055343E+000, -3.39665861E+000, ..., -4.26060507E+000
```

**:CALCulate:DATA:CSNR?****Function**

This command queries the SNR of all signals measured by the WDM application in the SNR view.

**Syntax**

```
:CALCulate:DATA:CSNR?
```

**Response Data**

```
<numeric>, ..., <numeric>
```

```
<numeric>: SNR (dB)
```

**Example of Use**

```
:CALCulate:DATA:CSNR?
```

```
>8.23560000+000, 8.52230000E+000, 8.88530000E+000, ..., 8.12890000E+000
```

### **:CALCulate:DATA:CWAVelengths?**

#### **Function**

This command queries the wavelength of all signals measured by the Optical AMP (WDM), WDM or WDM Filter application.

#### **Syntax**

:CALCulate:DATA:CWAVelengths?

#### **Response Data**

<numeric>, ..., <numeric>

<numeric>: Wavelength (m) or Frequency (Hz)

#### **Example of Use**

:CALCulate:DATA:CWAVelengths?

>1.54999400E-006,1.55081500E-006,1.55157500E-006,...,1.56235500E-006

### **:CALCulate:DATA:NCHannels?**

#### **Function**

This command queries the number of signals of the Optical AMP (WDM), WDM or WDM Filter application.

#### **Syntax**

:CALCulate:DATA:NCHannels?

#### **Response Data**

<numeric>

<numeric>: Peak count

#### **Example of Use**

:CALCulate:DATA:NCHannels?

>46



**:CALCulate[1|2|3|4|5|6]:FWHM[:DATA]?****Function**

This command queries the spectrum width measured by the Threshold method with the cut level specified to 3 dB.

**Syntax**

```
:CALCulate[1|2|3|4|5|6]:FWHM[:DATA]?
```

Specify the Active trace (A to F) by specifying a number from 1 to 6. When omitted, the Active trace is not changed.

**Response Data**

```
<numeric>
```

```
<numeric>: Spectrum width (m|Hz)
```

**Example of Use**

```
:CALCulate1:FWHM:DATA?
>+8.23000000E-010
```

**:CALCulate[1|2|3|4|5|6]:FWHM:STATe****Function**

This command sets and queries the On/Off state of the 3 dB spectrum width analysis.

**Syntax**

```
:CALCulate[1|2|3|4|5|6]:FWHM:STATe 0|1|OFF|ON
:CALCulate[1|2|3|4|5|6]:FWHM:STATe?
```

Specify the Active trace (A to F) by specifying a number from 1 to 6. When omitted, the Active trace is not changed.

```
0|OFF: 3 dB spectrum width analysis OFF
1|ON: 3 dB spectrum width analysis ON
```

**Response Data**

```
0|1
```

**Example of Use**

```
:CALCulate5:FWHM:STATe ON
:CALCulate5:FWHM:STATe?
>1
```

### **:CALCulate:LMARker:AOff**

#### **Function**

This command erases display of the wavelength, level, trace and delta markers.

#### **Syntax**

```
:CALCulate:LMARker:AOff
```

### **:CALCulate:LMARker:X**

#### **Function**

This command sets and displays the value of marker A or marker B. This command queries the value of marker A or marker B.

#### **Syntax**

```
:CALCulate:LMARker:X  
<switch>,<numeric>[{{<unit_m>|<unit_h>}}]  
:CALCulate:LMARker:X? <switch>
```

<switch>	Description
1	Specifies the wavelength marker A.
2	Specifies the wavelength marker B.

<numeric>: Wavelength or Frequency (m | Hz)

Range	From the start wavelength/frequency to the stop wavelength/frequency
Resolution	0.1 pm when the wavelength marker is displayed 0.01 GHz when the frequency marker is displayed

If a suffix is omitted, the unit will be m or Hz.

#### **Response Data**

```
<numeric>
```

#### **Example of Use**

```
:CALCulate:LMARker:X 1,850NM  
:CALCulate:LMARker:X? 1  
>+8.50000000E-007
```

**:CALCulate:LMARker:Y****Function**

This command sets and displays the value of the level marker.  
This command queries the value of level marker.

**Syntax**

```
:CALCulate:LMARker:Y
<switch>,<numeric>{DBM|MW|NW|PW|UW|W}
:CALCulate:LMARker:Y? 3|4
```

<switch>	Description
3	Specifies the level marker C.
4	Specifies the level marker D.

<numeric>

Log scale in absolute value

Range -190.000 to +50.000 dBm

Resolution 0.001

Linear scale in relative value

Range 0.001 pW to 1.200 W

Resolution 0.001

When the vertical axis shows relative values (dB, %), the level marker value cannot be set or queried.

If a suffix is omitted, the unit will be dBm or W.

**Response Data**

<numeric>

**Example of Use**

```
:CALCulate:LMARker:Y 3,-20.55DBM
:CALCulate:LMARker:Y? 3
>-2.05500000E+001
```

**:CALCulate:MARker:AOff****Function**

This command erases display of the wavelength, level, trace and delta markers.

**Syntax**

```
:CALCulate:MARker:AOff
```

**:CALCulate:MARKer[1|2|3|4]:FUNction:DELta[:STATe]**

**Function**

This command sets and queries the On/Off state of the delta marker display.

**Syntax**

:CALCulate:MARKer[1|2|3|4]:FUNction:DELta[:STATe]

0|1|OFF|ON

:CALCulate:MARKer[1|2|3|4]:FUNction:DELta[:STATe]?

The process will not change regardless of whether a number [1|2|3|4] is specified or omitted.

0|OFF: Does not display the delta marker.

1|ON: Displays the delta marker.

**Response Data**

0|1

**Example of Use**

:CALCulate:MARKer:FUNction:DELta:STATe ON

:CALCulate:MARKer:FUNction:DELta:STATe?

>1

**:CALCulate:MARKer[1|2|3|4]:FUNction:DELTA:X:OFFSet?****Function**

This command queries the wavelength or frequency difference between delta marker and trace marker.

**Syntax**

```
:CALCulate:MARKer[1|2|3|4]:FUNction:DELTA:X:OFFSet?
```

The process will not change regardless of whether a number [1|2|3|4] is specified or omitted.

**Response Data**

<numeric>

<numeric>: Wavelength difference or Frequency difference (m|Hz)

To switch the response data type between wavelength and frequency, use the :CALCulate:MARKer[1|2|3|4]:FUNction:DELTA:X:READout command.

**Example of Use**

```
:CALCulate:MARKer:FUNction:DELTA:X:OFFSet?  
>+2.00000000E-010
```

### **:CALCulate:MARKer[1|2|3|4]:FUNCTION:DELTA:X:OFFSet:FREQUENCY**

#### **Function**

This command displays the delta marker and sets its frequency.  
This command queries the frequency difference between delta marker and trace marker.

#### **Syntax**

```
:CALCulate:MARKer[1|2|3|4]:FUNCTION:DELTA:X:OFFSet:FREQU  
ency <numeric>[<unit_h>]  
:CALCulate:MARKer[1|2|3|4]:FUNCTION:DELTA:X:OFFSet:FREQU  
ency?
```

The process will not change regardless of whether a number [1|2|3|4] is specified or omitted.

<numeric>: Frequency (Hz)

Range From the start frequency to the stop frequency

Resolution 0.01 GHz

If a suffix is omitted, the unit will be Hz.

If there is no data at the specified frequency point, the delta marker is displayed at the closest data point to the specified frequency.

#### **Response Data**

<numeric>

<numeric>: Frequency difference (Hz)

#### **Example of Use**

```
:CALCulate:MARKer3:FUNCTION:DELTA:X:OFFSet:FREQUENCY  
192.49424THZ  
:CALCulate:MARKer:FUNCTION:DELTA:X:OFFSet:FREQUENCY?  
>-3.66550000E+011
```

### **:CALCulate:MARKer[1|2|3|4]:FUNCTION:DELTA:X:OFFSet[:WAVElength]**

#### **Function**

This command displays the delta marker and sets its wavelength.  
This command queries the wavelength difference between delta marker and trace marker.

#### **Syntax**

```
:CALCulate:MARKer[1|2|3|4]:FUNCTION:DELTA:X:OFFSet[:WAVE  
length] <numeric>[{<unit_m>|<unit_h>}]
```

```
:CALCulate:MARKer[1|2|3|4]:FUNction:DELTA:X:OFFSet[:WAVElength]?
```

The process will not change regardless of whether a number [1|2|3|4] is specified or omitted.

<numeric>: Wavelength or frequency of delta marker (m|Hz)

Range From the start wavelength to the stop wavelength

Resolution 0.1 pm

If a suffix is omitted, the unit will be m.

If there is no data at the specified wavelength point, the delta marker is displayed at the closest data point to the specified wavelength.

If [:WAVElength] is omitted when setting the frequency of the marker display, the delta marker can be set even by the frequency.

Range From the start frequency to the stop frequency

Resolution 0.01 GHz

If a suffix is omitted, the unit will be Hz.

### Response Data

<numeric>

<numeric>: Wavelength difference or Frequency difference (m|Hz)

If [:WAVElength] is omitted when setting the frequency of the marker display, the frequency difference of the delta marker can be obtained.

### Example of Use

```
:CALCulate:MARKer:FUNction:DELTA:X:OFFSet:WAVElength
1554.8923nm
```

```
:CALCulate:MARKer:FUNction:DELTA:X:OFFSet:WAVElength?
>+5.00119076E-009
```

```
:CALCulate:MARKer:FUNction:DELTA:X:OFFSet 192.81614THZ
```

```
:CALCulate:MARKer:FUNction:DELTA:X:OFFSet?
```

```
>+1.01700000E+010
```

## **:CALCulate:MARKer[1|2|3|4]:FUNCTion:DELTA:X:READout**

### **Function**

This command switches the delta marker display type between wavelength and frequency.

This command queries whether the delta marker display type is wavelength or frequency.

### **Syntax**

```
:CALCulate:MARKer[1|2|3|4]:FUNCTion:DELTA:X:READout  
FREQ|WAV
```

```
:CALCulate:MARKer[1|2|3|4]:FUNCTion:DELTA:X:READout?
```

The process will not change regardless of whether a number [1|2|3|4] is specified or omitted.

FREQ: Sets to the frequency display.

WAV: Sets to the wavelength display.

### **Response Data**

```
FREQ|WAV
```

### **Example of Use**

```
:CALCulate:MARKer:FUNCTion:DELTA:X:READout WAV
```

```
:CALCulate:MARKer:FUNCTion:DELTA:X:READout?
```

```
>WAV
```



**:CALCulate:MARKer[1|2|3|4]:FUNCTION:DELTA:X:REFERENCE?****Function**

This command queries the wavelength or frequency of the trace marker.

**Syntax**

```
:CALCulate:MARKer[1|2|3|4]:FUNCTION:DELTA:X:REFERENCE?
```

The process will not change regardless of whether a number [1|2|3|4] is specified or omitted.

**Response Data**

```
<numeric>
```

```
<numeric>: Wavelength or Frequency (m|Hz)
```

To set the unit of response data, use the :CALCulate:MARKer[1|2|3|4]:FUNCTION:DELTA:X:READout command.

**Example of Use**

```
:CALCulate:MARKer:FUNCTION:DELTA:X:REFERENCE?  
>+1.53500000E-006
```

## **:CALCulate:MARKer:FUNCTion:DELTA:XY**

### **Function**

This command displays the delta marker and sets its wavelength or frequency.

This command queries the difference in wavelength and level between delta marker and trace marker.

When the level scale is displayed in units of percentage (%), the delta marker cannot be set or queried.

### **Syntax**

CALCulate:MARKer:FUNCTion:DELTA:XY

<numeric>[{<unit\_m>|<unit\_h>}]

CALCulate:MARKer:FUNCTion:DELTA:XY?

<numeric>:      Wavelength or Frequency

Range            From the start wavelength/frequency to the stop wavelength/frequency

Resolution      0.1 pm when the wavelength marker is displayed  
                  0.01 GHz when the frequency marker is displayed

If a suffix is omitted, the unit will be m or Hz.

If there is no data at the specified wavelength/frequency point, the delta marker is displayed at the closest data point to the specified wavelength/frequency.

### **Response Data**

<numeric>,<numeric>

No.	Parameter type	Description
1	<numeric>	Wavelength difference (m) or frequency difference (Hz) between delta marker and trace marker
2	<numeric>	Level difference between delta marker and trace marker (Unit: dB or no unit (for linear scale display))

### **Example of Use**

CALCulate:MARKer:FUNCTion:DELTA:XY 1310NM

CALCulate:MARKer:FUNCTion:DELTA:XY?

>+2.50000000E-009,-3.32600000E+001

**:CALCulate:MARKer[1|2|3|4]:FUNCTION:DELTA:Y:OFFset?****Function**

This command queries the difference in level between delta and trace markers.

When the level scale is displayed in units of percentage (%), the level difference cannot be queried.

**Syntax**

```
:CALCulate:MARKer[1|2|3|4]:FUNCTION:DELTA:Y:OFFset?
```

The process will not change regardless of whether a number [1|2|3|4] is specified or omitted.

**Response Data**

<numeric>: Level differences between delta and trace markers (Unit: dB or no unit (for linear scale display))

**Example of Use**

```
:CALCulate:MARKer:FUNCTION:DELTA:Y:OFFset?  
>+2.00615565E+001
```

**:CALCulate:MARKer[1|2|3|4]:FUNCTION:DELTA:Y:REFerence?****Function**

This command queries the level of the trace marker.

When the level scale is displayed in units of percentage (%), the level cannot be queried.

**Syntax**

```
:CALCulate:MARKer[1|2|3|4]:FUNCTION:DELTA:Y:REFerence?
```

The process will not change regardless of whether a number [1|2|3|4] is specified or omitted.

**Response Data**

<numeric>: Level of the trace marker (dB|dBm|W)

**Example of Use**

To query the trace marker level (dB|dBm) when displayed in a log scale.

```
:CALCulate:MARKer:FUNCTION:DELTA:Y:REFerence?  
>-5.39715403E+001
```

To query the trace marker level (W) when displayed in a linear scale.

```
:CALCulate:MARKer:FUNCTION:DELTA:Y:REFerence?  
>+4.00724565E-009
```

### **:CALCulate:MARKer[1|2|3|4]:MAXimum**

#### **Function**

This command detects the spectrum peak level point and moves the trace marker to it.

#### **Syntax**

`:CALCulate:MARKer[1|2|3|4]:MAXimum`

The process will not change regardless of whether a number [1|2|3|4] is specified or omitted.

#### **Example of Use**

`CALCulate:MARKer:MAXimum`

### **:CALCulate:MARKer[1|2|3|4]:MAXimum:LEFT**

#### **Function**

This command detects next peak on the left after current point and moves trace marker to that point.

#### **Syntax**

`:CALCulate:MARKer[1|2|3|4]:MAXimum:LEFT`

The process will not change regardless of whether a number [1|2|3|4] is specified or omitted.

#### **Example of Use**

`CALCulate:MARKer:MAXimum:LEFT`

### **:CALCulate:MARKer[1|2|3|4]:MAXimum:NEXT**

#### **Function**

This command detects next shortest peak level after current point and moves trace marker to that point.

#### **Syntax**

`:CALCulate:MARKer[1|2|3|4]:MAXimum:NEXT`

The process will not change regardless of whether a number [1|2|3|4] is specified or omitted.

#### **Example of Use**

`CALCulate:MARKer:MAXimum:NEXT`

**:CALCulate:MARKer[1|2|3|4]:MAXimum:RIGHT****Function**

This command detects next peak on the right after current point and moves trace marker to that point.

**Syntax**

```
:CALCulate:MARKer[1|2|3|4]:MAXimum:RIGHT
```

The process will not change regardless of whether a number [1|2|3|4] is specified or omitted.

**Example of Use**

```
CALCulate:MARKer:MAXimum:RIGHT
```

**:CALCulate:MARKer:MAXimum:SCENter****Function**

This command sets the peak wavelength of spectrum to the center wavelength.

**Syntax**

```
:CALCulate:MARKer:MAXimum:SCENter
```

**:CALCulate:MARKer:MAXimum:SRLevel****Function**

This command sets the peak level of spectrum to the reference level.

**Syntax**

```
:CALCulate:MARKer:MAXimum:SRLevel
```

**:CALCulate:MARKer:MAXimum:SZCenter****Function**

This command sets the peak wavelength of spectrum to the center wavelength.

**Syntax**

```
:CALCulate:MARKer:MAXimum:SZCenter
```

### **:CALCulate:MARKer[1|2|3|4]:MINimum**

#### **Function**

This command detects the minimum level point and moves the trace marker to that point.

#### **Syntax**

`:CALCulate:MARKer[1|2|3|4]:MINimum`

The process will not change regardless of whether a number [1|2|3|4] is specified or omitted.

#### **Example of Use**

`CALCulate:MARKer:MINimum`

### **:CALCulate:MARKer[1|2|3|4]:MINimum:LEFT**

#### **Function**

This command detects next dip point on the left after current point and moves trace marker to point.

#### **Syntax**

`:CALCulate:MARKer[1|2|3|4]:MINimum:LEFT`

The process will not change regardless of whether a number [1|2|3|4] is specified or omitted.

#### **Example of Use**

`CALCulate:MARKer:MINimum:LEFT`

### **:CALCulate:MARKer[1|2|3|4]:MINimum:NEXT**

#### **Function**

This command detects next highest dip point after current point and moves trace marker to point.

#### **Syntax**

`:CALCulate:MARKer[1|2|3|4]:MINimum:NEXT`

The process will not change regardless of whether a number [1|2|3|4] is specified or omitted.

#### **Example of Use**

`CALCulate:MARKer:MINimum:NEXT`

**:CALCulate:MARKer[1|2|3|4]:MINimum:RIGHT****Function**

This command detects next dip point on the right after current point and moves trace marker to point.

**Syntax**

```
:CALCulate:MARKer[1|2|3|4]:MINimum:RIGHT
```

The process will not change regardless of whether a number [1|2|3|4] is specified or omitted.

**Example of Use**

```
CALCulate:MARKer:MINimum:RIGHT
```

**:CALCulate:MARKer[1|2|3|4]:PEXCursion[:PEAK]****Function**

This command sets the Search Threshold for Peak/Dip Search to Manual and sets its value.

This command queries the Search Threshold value for Peak/Dip Search.

**Syntax**

```
:CALCulate:MARKer[1|2|3|4]:PEXCursion[:PEAK]
<numeric>[DB]
:CALCulate:MARKer[1|2|3|4]:PEXCursion[:PEAK]?
```

The process will not change regardless of whether a number [1|2|3|4] is specified or omitted.

<numeric>: Search Threshold

Range 0.01 to 10.00 dB

Resolution 0.01 dB

If a suffix is omitted, the unit will be dB.

**Response Data**

```
<numeric>
```

<numeric>: Search Threshold(dB)  
+1.00000000E-002 to +1.00000000E+001

**Example of Use**

```
:CALCulate:MARKer:PEXCursion:PEAK 2
:CALCulate:MARKer:PEXCursion:PEAK?
>+2.00000000E+000
```

### **:CALCulate:MARKer[1|2|3|4]:PEXCursion:PIT**

#### **Function**

This command sets the Search Threshold for Peak/Dip Search to Manual and sets its value.

This command queries the Search Threshold value for Peak/Dip Search.

#### **Syntax**

```
:CALCulate:MARKer[1|2|3|4]:PEXCursion:PIT <numeric>[DB]  
:CALCulate:MARKer[1|2|3|4]:PEXCursion:PIT?
```

The process will not change regardless of whether a number [1|2|3|4] is specified or omitted.

<numeric>: Search Threshold

Range 0.01 to 10.00 dB

Resolution 0.01 dB

If a suffix is omitted, the unit will be dB.

#### **Response Data**

<numeric>

<numeric>: Search Threshold (dB)  
+1.00000000E-002 to +1.00000000E+001

#### **Example of Use**

```
:CALCulate:MARKer:PEXCursion:PIT 2  
:CALCulate:MARKer:PEXCursion:PIT?  
>+2.00000000E+000
```



**:CALCulate:MARKer:PP:DATA?****Function**

This command queries the Peak to Peak measured result of trace. When the level scale is displayed in units of percentage (%), the result of “Peak to Peak” calculation cannot be queried.

**Syntax**

```
CALCulate:MARKer:PP:DATA?
```

**Response Data**

```
<numeric>
```

<numeric>: Peak to Peak measurement result (dB|W)

When Peak to Peak Calculation is NOT set to On, the response data for :CALCulate:MARKer:PP:DATA? command is -999.99.

**:CALCulate:MARKer:PP[:STATE]****Function**

This command sets and queries the Peak to Peak display of trace.

**Syntax**

```
CALCulate:MARKer:PP[:STATE] 0|1|OFF|ON  
CALCulate:MARKer:PP[:STATE]?
```

0|OFF: Does not display Peak to Peak.

1|ON: Displays Peak to Peak.

**Response Data**

```
OFF|ON
```

**Example of Use**

```
CALCulate:MARKer:PP:STATE 1  
CALCulate:MARKer:PP:STATE?  
>1
```

**:CALCulate:MARKer[1|2|3|4][:STATe]**

**Function**

This command sets and queries the On/Off state of the trace marker display.

**Syntax**

:CALCulate:MARKer[1|2|3|4][:STATe] 0|1|OFF|ON

:CALCulate:MARKer[1|2|3|4][:STATe]?

The process will not change regardless of whether a number [1|2|3|4] is specified or omitted.

0|OFF: Does not display the trace marker.

1|ON: Displays the trace marker.

**Response Data**

0|1

**Example of Use**

:CALCulate:MARKer:STATe 1

:CALCulate:MARKer:STATe?

>1

**:CALCulate:MARKer:TMK:DATA****Function**

This command sets the wavelength or frequency of the trace marker and displays the trace marker.

This command queries the wavelength or frequency and level of the trace marker.

When the level scale is displayed in units of percentage (%), the trace marker cannot be set or queried.

**Syntax**

```
:CALCulate:MARKer:TMK:DATA <numeric>[{{<unit_m>|<unit_h>}}]
:CALCulate:MARKer:TMK:DATA?
```

<numeric>: Wavelength or Frequency (m | Hz)

Range From the start wavelength/frequency to the stop wavelength/frequency

Resolution 0.1 pm when the wavelength marker is displayed  
0.01 GHz when the frequency marker is displayed

If a suffix is omitted, the unit will be m or Hz.

If there is no data at the specified wavelength/frequency point, the trace marker is displayed at the closest data point to the specified wavelength/frequency.

**Response Data**

```
<numeric>,<numeric>
```

No.	Parameter type	Description
1	<numeric>	Trace Marker wavelength (m   Hz)
2	<numeric>	Trace Marker level (dBm   dB   W)

**Example of Use**

```
:CALCulate:MARKer:TMK:DATA 1550nm
:CALCulate:MARKer:TMK:DATA?
>+1.55000000E-006,-6.94600000E+001
```

## **:CALCulate:MARKer[1|2|3|4]:TRACe**

### **Function**

This command sets and queries the active trace.

### **Syntax**

```
:CALCulate:MARKer[1|2|3|4]:TRACe <trace_name>  
:CALCulate:MARKer[1|2|3|4]:TRACe?
```

The process will not change regardless of whether a number [1|2|3|4] is specified or omitted.

### **Response Data**

```
TRA|TRB|TRC|TRD|TRE|TRF|G|H|I|J
```

### **Example of Use**

```
:CALCulate:MARKer:TRACe TRB  
:CALCulate:MARKer:TRACe?  
>TRB  
:CALCulate:MARKer:TRACe J  
:CALCulate:MARKer:TRACe?  
>J
```

**:CALCulate:MARKer:UNIT****Function**

This command sets the marker display to either wavelength or frequency. This command queries whether the marker display is set to wavelength or frequency.

**Syntax**

```
:CALCulate:MARKer:UNIT 0|1|WAVelength|FREQuency  
:CALCulate:MARKer:UNIT?
```

0 WAVelength:	Wavelength
1 FREQuency:	Frequency

**Response Data**

```
0|1
```

**Example of Use**

```
:CALCulate:MARKer:UNIT WAVelength  
:CALCulate:MARKer:UNIT?  
>0  
:CALCulate:MARKer:UNIT FREQuency  
:CALCulate:MARKer:UNIT?  
>1
```

### **:CALCulate:MARKer[1|2|3|4]:X:FREQUENCY**

#### **Function**

This command sets the frequency of the trace marker and displays the trace marker.

#### **Syntax**

```
:CALCulate:MARKer[1|2|3|4]:X:FREQUENCY  
<numeric>[<unit_h>]
```

The process will not change regardless of whether a number [1|2|3|4] is specified or omitted.

<numeric>:      Frequency of the trace marker

Range            From the start frequency to the stop frequency

Resolution      0.01 GHz

If a suffix is omitted, the unit will be Hz.

If there is no data at the specified frequency point, the trace marker is displayed at the closest data point to the specified frequency.

#### **Example of Use**

```
:CALCulate:MARKer:X:FREQUENCY 193.8THZ  
:CALCulate:MARKer:X?  
>+1.93800000E+014
```

**:CALCulate:MARKer[1|2|3|4]:X:READout****Function**

This command sets the trace marker display to either wavelength or frequency.

This command queries whether the trace marker display is set to wavelength or frequency.

**Syntax**

```
:CALCulate:MARKer[1|2|3|4]:X:READout  FREQ|WAV  
:CALCulate:MARKer[1|2|3|4]:X:READout?
```

The process will not change regardless of whether a number [1|2|3|4] is specified or omitted.

FREQ:	Frequency
WAV:	Wavelength

**Response Data**

```
FREQ|WAV
```

**Example of Use**

```
:CALCulate:MARKer:X:READout  FREQ  
:CALCulate:MARKer:X:READout?  
>FREQ
```

### **:CALCulate:MARKer[1|2|3|4]:X[:WAVelength]**

#### **Function**

This command sets the wavelength of the trace marker and displays the trace marker.

This command queries the wavelength of the trace marker.

#### **Syntax**

```
:CALCulate:MARKer[1|2|3|4]:X[:WAVelength]
<numeric>[<unit_m>|<unit_h>]
:CALCulate:MARKer[1|2|3|4]:X[:WAVelength]?
```

The process will not change regardless of whether a number [1|2|3|4] is specified or omitted.

<numeric>: Wavelength or frequency of the trace marker (m | Hz)

Range From the start wavelength to the stop wavelength

Resolution 0.1 pm

If a suffix is omitted, the unit will be m.

If there is no data at the specified wavelength point, the trace marker is displayed at the closest data point to the specified wavelength.

If [:WAVelength] is omitted when setting the frequency of the marker display, the trace marker can be set even by the frequency.

Range From the start frequency to the stop frequency

Resolution 0.01 GHz

If a suffix is omitted, the unit will be Hz.

#### **Response Data**

```
<numeric>
```

<numeric>: Wavelength or frequency of the trace marker (m | Hz)

If [:WAVelength] is omitted when setting the frequency of the marker display, the frequency of the trace marker can be obtained.

#### **Example of Use**

```
:CALCulate:MARKer:X:WAVelength 1.555UM
:CALCulate:MARKer:X?
>+1.55500000E-006
```



**:CALCulate:MARKer[1|2|3|4]:Y?****Function**

This command queries the level of the trace marker.

When the level scale is displayed in units of percentage (%), the trace marker level cannot be queried.

**Syntax**

```
:CALCulate:MARKer[1|2|3|4]:Y?
```

The process will not change regardless of whether a number [1|2|3|4] is specified or omitted.

**Response Data**

```
<numeric>:    Level of the trace marker (dB|dBm|W)
```

**Example of Use**

To query the trace marker level (dB|dBm) when displayed in a log scale.

```
:CALCulate:MARKer:Y?
```

```
>-4.28000000E+000
```

To query the trace marker level (W) when displayed in a linear scale.

```
:CALCulate:MARKer:Y?
```

```
>+3.72900000E-004
```

**:CALCulate:MARKer:ZONE:ERACe****Function**

This command erases the zone marker display.

**Syntax**

```
:CALCulate:MARKer:ZONE:ERACe
```

**:CALCulate:MARKer:ZONE:SPAN****Function**

This command sets the wavelength width of the zone marker to the sweep width.

**Syntax**

```
:CALCulate:MARKer:ZONE:SPAN
```

## :CALCulate:MARKer:ZONE:WAVelength

### Function

This command sets and queries the center wavelength of the zone marker and wavelength width.

### Syntax

```
:CALCulate:MARKer:ZONE:WAVelength  
<numeric>[<unit_m>],<numeric>[<unit_m>]  
:CALCulate:MARKer:ZONE:WAVelength?
```

No.	Parameter type	Range	Description
1	<numeric>	Larger than Start wavelength and smaller than Stop wavelength	Zone Marker center wavelength
2	<numeric>	Larger than 0.2 nm and smaller than wavelength span	Zone Marker wavelength width

Resolution 1 pm

If a suffix is omitted, the unit will be m.

### Response Data

```
<numeric>,<numeric>
```

No.	Parameter type	Description
1	<numeric>	Zone Marker center wavelength (m)
2	<numeric>	Zone Marker wavelength width (m)

### Example of Use

```
:CALCulate:MARKer:ZONE:WAVelength 1545NM,2NM  
:CALCulate:MARKer:ZONE:WAVelength?  
>+1.54500000E-006,+2.00000000E-009
```

**:CALCulate:MARKer:ZONE:ZOOM****Function**

This command sets and queries the Zone Marker zoom in and zoom out range.

**Syntax**

```
:CALCulate:MARKer:ZONE:ZOOM IN|OUT
```

```
:CALCulate:MARKer:ZONE:ZOOM?
```

IN:               Zooms in on Zone Marker range

OUT:              Resets the zoom.

**Response Data**

```
IN|OUT
```

**Example of Use**

```
:CALCulate:MARKer:ZONE:ZOOM IN
```

```
:CALCulate:MARKer:ZONE:ZOOM?
```

```
>IN
```

## **:CALCulate[1|2|3|4|5|6]:MATH[:EXPRession][:DEFine]**

### **Function**

This command sets the calculation formula for the active trace whose trace type is CALC.

This command queries the calculation formula for the active trace whose trace type is CALC.

### **Syntax**

```
:CALCulate[1|2|3|4|5|6]:MATH[:EXPRession][:DEFine]
<trace_name><operator><trace_name>
:CALCulate[1|2|3|4|5|6]:MATH[:EXPRession][:DEFine]?
```

Specify the Active trace (A to F) by specifying a number from 1 to 6. When omitted, the Active trace is not changed.

<trace\_name>: Calculated trace  
<operator>: Operator “-“ (minus)  
<trace\_name>: Calculating

### **Response Data**

```
<trace_name>,<trace_name>,{-|/},<trace_name>
```

The operator for linear scale is “-“ (minus), and that for log scale is “/” (slash).

### **Example of Use**

```
:CALCulate1:MATH:EXPRession:DEFine B-C
:CALCulate1:MATH:EXPRession:DEFine?
>TRA,TRB,-,TRC
```

Set the trace type of Active trace to Calculate.

Set two traces other than the Active trace. If the Active trace is set to A, the command cannot be executed when set as follows:

```
:CALCulate1:MATH:EXPRession:DEFine A-B
```

Set traces with the Write or Fix trace type for traces set at the first or third command parameter.

The trace of Calculate type cannot be set.

**:CALCulate[1|2|3|4|5|6]:MATH:STATE****Function**

This command sets and queries the On/Off state of the trace type CALC.

**Syntax**

```
:CALCulate[1|2|3|4|5|6]:MATH:STATE 0|1|OFF|ON
:CALCulate[1|2|3|4|5|6]:MATH:STATE?
```

Specify the Active trace (A to F) by specifying a number from 1 to 6. When omitted, the Active trace is not changed.

```
0|OFF:      Sets Trace Type to Write
1|ON:       Sets Trace Type to Calculate
```

**Response Data**

```
0|1
```

**Example of Use**

```
:CALCulate2:MATH:STATE ON
:CALCulate2:MATH:STATE?
>1
```

**:CALCulate:MATH:TRC****Function**

This command sets and queries the display method of vertical axis, and the formula for Trace C.

**Syntax**

```
:CALCulate:MATH:TRC <switch>
:CALCulate:MATH:TRC?
```

<switch>	Display method	Formula
A-B (LOG)	Log scale	A-B
B-A (LOG)	Log scale	B-A
A-B (LIN)	Linear scale	A/B
B-A (LIN)	Linear scale	B/A

**Response Data**

```
A-B (LOG) | B-A (LOG) | A-B (LIN) | B-A (LIN)
```

**Example of Use**

```
:CALCulate:MATH:TRC A-B (LIN)
:CALCulate:MATH:TRC?
>A-B (LIN)
```

## **:CALCulate:MATH:TRF**

### **Function**

This command sets and queries the display method of vertical axis, and the formula for Trace F.

### **Syntax**

`:CALCulate:MATH:TRF <switch>`

`:CALCulate:MATH:TRF?`

<code>&lt;switch&gt;</code>	Display method	Formula
C-D (LOG)	Log scale	C-D
D-C (LOG)	Log scale	D-C
D-E (LOG)	Log scale	D-E
E-D (LOG)	Log scale	E-D
C-D (LIN)	Linear scale	C/D
D-C (LIN)	Linear scale	D/C
D-E (LIN)	Linear scale	D/E
E-D (LIN)	Linear scale	E/D

### **Response Data**

C-D (LOG) | D-C (LOG) | D-E (LOG) | E-D (LOG) | C-D (LIN) | D-C (LIN) | D-E (LIN) | E-D (LIN)

### **Example of Use**

`:CALCulate:MATH:TRF E-D (LIN)`

`:CALCulate:MATH:TRF?`

`>E-D (LIN)`

**:CALCulate:MATH:TRG****Function**

This command sets and queries the display method of vertical axis, and the formula for Trace G.

**Syntax**

```
:CALCulate:MATH:TRG <switch>
```

```
:CALCulate:MATH:TRG?
```

<switch>	Display method	Formula
C-F (LOG)	Log scale	C-F
F-C (LOG)	Log scale	F-C
E-F (LOG)	Log scale	E-F
F-E (LOG)	Log scale	F-E
C-F (LIN)	Linear scale	C/F
F-C (LIN)	Linear scale	F/C
E-F (LIN)	Linear scale	E/F
F-E (LIN)	Linear scale	F/E

**Response Data**

```
C-F (LOG) | F-C (LOG) | E-F (LOG) | F-E (LOG) | C-F (LIN) | F-C (LIN) | E-F (LIN) | F-E (LIN)
```

**Example of Use**

```
:CALCulate:MATH:TRG F-E (LOG)
```

```
:CALCulate:MATH:TRG?
```

```
>F-E (LOG)
```

### **:CALCulate:MATH:TRX:NORMALize**

#### **Function**

This command sets and queries the level display to the absolute or relative values.

#### **Syntax**

```
:CALCulate:MATH:TRX:NORMALize NRM|NRMZ
:CALCulate:MATH:TRX:NORMALize?
```

NRM: Absolute value display (Normal)  
NRMZ: Relative value display (Normalize)

#### **Response Data**

NRM|NRMZ

#### **Example of Use**

```
:CALCulate:MATH:TRX:NORMALize NRM
:CALCulate:MATH:TRX:NORMALize?
>NRM
```

### **:CALCulate[1|2|3|4|5|6]:MAXimum[:STATe]**

#### **Function**

This command sets and queries the On/Off state of the Max Hold function for Storage Mode.

#### **Syntax**

```
:CALCulate[1|2|3|4|5|6]:MAXimum[:STATe] 0|1|OFF|ON
:CALCulate[1|2|3|4|5|6]:MAXimum[:STATe]?
```

Specify the Active trace (A to F) by specifying a number from 1 to 6. When omitted, the Active trace is not changed.

0|OFF: Turns off the Max Hold function for Storage Mode.  
1|ON: Turns on the Max Hold function for Storage Mode.

#### **Response Data**

0|1

#### **Example of Use**

```
:CALCulate1:MAXimum:STATe ON
:CALCulate1:MAXimum:STATe?
>1
```



**:CALCulate[1|2|3|4|5|6]:MINimum[:STATE]****Function**

This command sets and queries the On/Off state of the Min Hold function for Storage Mode.

**Syntax**

```
:CALCulate[1|2|3|4|5|6]:MINimum[:STATE] 0|1|OFF|ON
```

```
:CALCulate[1|2|3|4|5|6]:MINimum[:STATE]?
```

Specify the Active trace (A to F) by specifying a number from 1 to 6. When omitted, the Active trace is not changed.

0|OFF: Turns off the Min Hold function for Storage Mode.

1|ON: Turns on the Min Hold function for Storage Mode.

**Response Data**

```
0|1
```

**Example of Use**

```
:CALCulate2:MINimum:STATE ON
```

```
:CALCulate2:MINimum:STATE?
```

```
>1
```

### **:CALCulate:OFFSet:AMPLifier**

#### **Function**

This command sets and queries the loss correction factor for optical output level of the Optical AMP (WDM) application.

#### **Syntax**

```
:CALCulate:OFFSet:AMPLifier <numeric>[DB]
```

```
:CALCulate:OFFSet:AMPLifier?
```

<numeric>: Pout Loss  
Loss correction factor for optical level output

Range -10.00 to 10.00 dB

Resolution 0.01 dB

If a suffix is omitted, the unit will be dB.

#### **Response Data**

```
<numeric>
```

<numeric>: Pout Loss (dB)  
-1.00000000E+001 to +1.00000000E+001

#### **Example of Use**

```
:CALCulate:OFFSet:AMPLifier 1.2
```

```
:CALCulate:OFFSet:AMPLifier?
```

```
>+1.20000000E+000
```

**:CALCulate:OFFSet:SOURce****Function**

This command sets and queries the loss correction factor for signal level of the Optical AMP (WDM) application.

**Syntax**

```
:CALCulate:OFFSet:SOURce <numeric value>[DB]
```

```
:CALCulate:OFFSet:SOURce?
```

<numeric>: Pin Loss (dB)  
Loss correction factor for signal level coefficient

Range -10.00 to 10.00 dB

Resolution 0.01 dB

If a suffix is omitted, the unit will be dB.

**Response Data**

```
<numeric>
```

<numeric>: Pin Loss (dB)  
-1.00000000E+001 to +1.00000000E+001

**Example of Use**

```
:CALCulate:OFFSet:SOURce -0.5
```

```
:CALCulate:OFFSet:SOURce?
```

```
>-5.00000000E-001
```

### **:CALCulate:PARAmeter[:CATegory]:AMP:MSElect**

#### **Function**

This command selects and queries the saving destination of the measurement data at the Optical AMP application.

#### **Note:**

PASE can be specified as the measured data save destination of the measured data when an optical amplifier measurement method is polarization nulling (PLZN Nulling). If another measurement method is set, an error is returned when PASE is specified.

#### **Syntax**

```
:CALCulate:PARAmeter[:CATegory]:AMP:MSElect <switch>  
:CALCulate:PARAmeter[:CATegory]:AMP:MSElect?
```

<switch>: Saving destination of measurement data  
{PIN|POUT|PASE}

#### **Response Data**

PIN|POUT|PASE

#### **Example of Use**

```
:CALCulate:PARAmeter:CATegory:AMP:MSElect POUT  
:CALCulate:PARAmeter:CATegory:AMP:MSElect?  
>POUT
```

### **:CALCulate:PARAmeter[:CATegory]:AMP:PARAmeter**

#### **Function**

This command sets and queries the measurement parameter in the Optical AMP application.

#### **Syntax**

```
:CALCulate:PARAmeter[:CATegory]:AMP:PARAmeter  
<switch>,<switch>,<switch>,<numeric>,...,<numeric>  
:CALCulate:PARAmeter[:CATegory]:AMP:PARAmeter?
```

No.	Parameter type	Range	Description
1	<switch>	0 1	0: NF(S-ASE) 1: NF(Total)
2	<switch>	0 1 2 3 4	0: Spect Div Off: Spectrum division off 1: Spect Div On: Spectrum division on 2: PLZN Nulling: Polarization nulling 3: Pulse Method: Pulse method 4: WDM Measure: WDM measurement
3	<switch>	0 1	0: Gauss Fitting ASE Level found by Gauss method 1: Mean Fitting ASE Level found by averaging value
4	<numeric>	0.10 to 100.00 nm Res. 0.01 nm	Fitting Span (m) Wavelength range for calculating ASE level
5	<numeric>	0.10 to 100.00 nm Res. 0.01 nm	Masked Span (m) Wavelength range excluded from ASE level calculation Set a small value than Fitting Span.
6	<numeric>	-10.00 to 10.00 Res. 0.01 dB	Pin Loss Optical signal level loss correction coefficient
7	<numeric>	-10.00 to 10.00 Res. 0.01 dB	Pout Loss Optical signal level loss correction coefficient
8	<numeric>	0.100 to 10.000 Res. 0.001	NF Calibration Noise figure correction coefficient
9	<numeric>	0.00 to 30.00 Res. 0.01 dB	O.BPF Level Calibration Optical filter loss correction coefficient
10	<numeric>	0.00 to 999.99 nm Res. 0.01 nm	O.BPF Band Width Optical filter passband width
11	<numeric>	-10.00 to 10.00 Res. 0.01 dB	Pol Loss Polarization controller loss correction coefficient

**Note:**

Parameters 5th to 11th are common parameters at optical amplifier measurement depending on the second <switch> (measurement method) setting.

Depending on the measurement method, the 5th to 11th <numeric> is an unnecessary parameter but it cannot be omitted. In this case, set any in-range value at the 5th to 11th <numeric>.

**Response Data**

<switch>, <switch>, <switch>, <numeric>, ..., <numeric>

No.	Parameter type	Description
1	<switch>	0: NF(S-ASE) 1: NF(Total)
2	<switch>	0: Spect Div Off: Spectrum division off 1: Spect Div On: Spectrum division on 2: PLZN Nulling: Polarization nulling 3: Pulse Method: Pulse method 4: WDM Measure: WDM measurement
3	<switch>	0: Gauss Fitting ASE Level found by Gauss method 1: Mean Fitting ASE Level found by averaging value
4	<numeric>	Fitting Span (m) Wavelength range for calculating ASE level
5	<numeric>	Masked Span (m) Wavelength range excluded from ASE level calculation Set a small value than Fitting Span.
6	<numeric>	Pin Loss (dB) Optical signal level loss correction coefficient
7	<numeric>	Pout Loss (dB) Optical signal level loss correction coefficient
8	<numeric>	NF Calibration Noise figure correction coefficient
9	<numeric>	O.BPF Level Calibration (dB) Optical filter loss correction coefficient
10	<numeric>	O.BPF Band Width (m) Optical filter passband width
11	<numeric>	Pol Loss (dB) Polarization controller loss correction coefficient

**Example of Use**

```
:CALCulate:PARAmeter:CATegory:AMP:PARAmeter
0,2,0,20NM,2NM,0,0,1,0,30NM,0
:CALCulate:PARAmeter:CATegory:AMP:PARAmeter?
>0,2,0,+2.00000000E-008,+2.00000000E-009,+0.00000000E+00
0,+0.00000000E+000,+1.00000000E+000,+0.00000000E+000,+3.
00000000E-008,+0.00000000E+000
```

**:CALCulate:PARAmeter[:CATegory]:AMP:PASE****Function**

This command selects and queries the trace memory saving PASE at the Optical AMP application.

**Note:**

The PASE trace memory can be selected when optical amplifier measurement method is not polarization nulling (PLZN Nulling). However, the PASE trace memory cannot be used when using the measurement method other than PLZN Nulling.

**Syntax**

```
:CALCulate:PARAmeter[:CATegory]:AMP:PASE <trace>  
:CALCulate:PARAmeter[:CATegory]:AMP:PASE?
```

**Response Data**

```
<trace>
```

**Example of Use**

```
:CALCulate:PARAmeter:CATegory:AMP:PASE D  
:CALCulate:PARAmeter:CATegory:AMP:PASE?  
>D
```

### **:CALCulate:PARAmeter[:CATegory]:AMP:PIN**

#### **Function**

This command selects and queries the trace memory saving Pin at the Optical AMP application.

#### **Syntax**

```
:CALCulate:PARAmeter[:CATegory]:AMP:PIN <trace>  
:CALCulate:PARAmeter[:CATegory]:AMP:PIN?
```

#### **Response Data**

```
<trace>
```

#### **Example of Use**

```
:CALCulate:PARAmeter:CATegory:AMP:PIN E  
:CALCulate:PARAmeter:CATegory:AMP:PIN?  
>E
```

### **:CALCulate:PARAmeter[:CATegory]:AMP:POUT**

#### **Function**

This command selects and queries the trace memory saving Pout for the Optical AMP application.

#### **Syntax**

```
:CALCulate:PARAmeter[:CATegory]:AMP:POUT <trace>  
:CALCulate:PARAmeter[:CATegory]:AMP:POUT?
```

#### **Response Data**

```
<trace>
```

#### **Example of Use**

```
:CALCulate:PARAmeter:CATegory:AMP:POUT F  
:CALCulate:PARAmeter:CATegory:AMP:POUT?  
>F
```



**:CALCulate:PARAmeter[:CATegory]:AMP:RESCalibrate****Function**

This command calibrates the resolution of the optical spectrum analyzer for the Optical AMP application.

Bit 4 (execution completion bit) of the end event status register (ESR2) is set to 1 after the completion of resolution calibration.

This command queries the status of the resolution calibration in the Optical AMP application.

**Syntax**

```
:CALCulate:PARAmeter[:CATegory]:AMP:RESCalibrate 0|1
```

```
:CALCulate:PARAmeter[:CATegory]:AMP:RESCalibrate?
```

- 0: Initializes current resolution calibration data
- 1: Executes resolution calibration

**Response Data**

```
0|1|2|3
```

- 0: Uses default resolution calibration value
- 1: Resolution calibration finished normally
- 2: Calibrating resolution
- 3: Resolution calibration finished abnormally

**Example of Use**

```
:CALCulate:PARAmeter:CATegory:AMP:RESCalibrate 1  
:CALCulate:PARAmeter:CATegory:AMP:RESCalibrate?  
>2  
:CALCulate:PARAmeter:CATegory:AMP:RESCalibrate?  
>3
```

## **:CALCulate:PARAmeter[:CATegory]:DFBLd**

### **Function**

This command sets the parameters and performs DFB-LD application analysis.

This command queries the parameters for the DFB-LD application.

### **Syntax**

```
:CALCulate:PARAmeter[:CATegory]:DFBLd  
<switch>,<numeric>,<numeric>  
:CALCulate:PARAmeter[:CATegory]:DFBLd?
```

The parameters are as follows.

No.	Parameter Type	Range	Description
1	<switch>	2NDPEAK   LEF T   RIGHT	Detecting method of SMSR analysis rates
2	<numeric>	0.1 to 50.0 dB Res. 0.1 dB	Slice level
3	<numeric>	1.00 to 10.00 Res. 0.01	k: Standard deviation factor

### **Response Data**

```
<switch>,<numeric>,<numeric>
```

No.	Parameter Type	Description
1	<switch>	Detecting method of SMSR analysis rates
2	<numeric>	Slice level (dB)
3	<numeric>	k: Standard deviation factor

### **Example of Use**

```
:CALCulate:PARAmeter:CATegory:DFBLd 2ndpeak,0.1,2.00  
:CALCulate:PARAmeter:CATegory:DFBLd?  
> 2NDPEAK,+1.00000000E-001,+2.00000000E+000
```

**:CALCulate:PARAmeter[:CATegory]:DFBLd:SRES****Function**

This command sets and queries the level resolution to detect the side mode in DFB-LD application.

**Syntax**

```
:CALCulate:PARAmeter[:CATegory]:DFBLd:SRES <numeric>[DB]
```

```
:CALCulate:PARAmeter[:CATegory]:DFBLd:SRES?
```

<numeric>: Level resolution

Range 0.10 to 10.00 dB

Resolution 0.01 dB

If a suffix is omitted, the unit will be dB.

**Response Data**

```
<numeric>
```

<numeric>: Level resolution (dB)  
+1.00000000-E001 to +1.00000000+E001

**Example of Use**

```
:CALCulate:PARAmeter:CATegory:DFBLd:SRES 2
```

```
:CALCulate:PARAmeter:CATegory:DFBLd:SRES?
```

```
>+2.00000000+E000
```

## **:CALCulate:PARAmeter[:CATegory]:FP**

### **Function**

This command sets the parameter and performs FP-LD application analysis.

This command queries the parameter.

### **Syntax**

```
:CALCulate:PARAmeter[:CATegory]:FP <numeric>[DB]  
:CALCulate:PARAmeter[:CATegory]:FP?
```

<numeric>: Cut Level  
Range 0.1 to 50.0 dB  
Resolution 0.1 dB

If a suffix is omitted, the unit will be dB.

### **Response Data**

<numeric>

<numeric>: Cut Level (dB)  
+1.00000000E-001 to +5.00000000E+001

### **Example of Use**

```
:CALCulate:PARAmeter:CATegory:FP 30  
:CALCulate:PARAmeter:CATegory:FP?  
>+3.00000000E+001
```

**:CALCulate:PARAmeter[:CATegory]:LD:AREA****Function**

This command sets and queries the Noise Parameter Area Type for the LD Module application.

**Syntax**

```
:CALCulate:PARAmeter[:CATegory]:LD:AREA CH|USER
:CALCulate:PARAmeter[:CATegory]:LD:AREA?
```

CH: Sets Area Type to Channel  
 USER: Sets Area Type to User Specify

**Response Data**

CH|USER

**Example of Use**

```
:CALCulate:PARAmeter:CATegory:LD:AREA USER
:CALCulate:PARAmeter:CATegory:LD:AREA?
>USER
```

**:CALCulate:PARAmeter[:CATegory]:LD:K****Function**

This command sets and queries the magnification for standard deviation in the LD Module application.

**Syntax**

```
:CALCulate:PARAmeter[:CATegory]:LD:K <numeric>
:CALCulate:PARAmeter[:CATegory]:LD:K?
```

<numeric>: k Standard deviation multiplier  
 Range 1.00 to 10.00  
 Resolution 0.01

**Response Data**

<numeric>

<numeric>: k Standard deviation multiplier  
 +1.00000000E+000 to +1.00000000E+001

**Example of Use**

```
:CALCulate:PARAmeter:CATegory:LD:K 6.07
:CALCulate:PARAmeter:CATegory:LD:K?
>+6.07000000E+000
```

## **:CALCulate:PARAmeter[:CATegory]:LD:NACHannel**

### **Function**

This command sets and queries the Channel Area in Noise Parameter for LD Module application.

### **Syntax**

```
:CALCulate:PARAmeter[:CATegory]:LD:NACHannel  
<numeric>,<numeric>  
:CALCulate:PARAmeter[:CATegory]:LD:NACHannel?
```

No.	Type	Range	Description
1	<numeric>	0.01 to 20.00 nm	Fitting Span
2	<numeric>	0.01 to 20.00 nm	Masked Span

Resolution 0.01 nm

If a suffix is omitted, the unit will be m.

### **Response Data**

```
<numeric>,<numeric>
```

```
<numeric>: Fitting/Masked Span (m)  
+1.00000000E-011 to +2.00000000E-008
```

### **Example of Use**

```
:CALCulate:PARAmeter:CATegory:LD:NACHannel 2.4NM,1.2NM  
:CALCulate:PARAmeter:CATegory:LD:NACHannel?  
>+2.40000000E-009,+1.20000000E-009
```

**:CALCulate:PARAmeter[:CATegory]:LD:NAFunction****Function**

This command sets and queries the Fitting Curve in Noise Parameter for LD Module application.

**Syntax**

```
:CALCulate:PARAmeter[:CATegory]:LD:NAFunction
<switch>, {0|1|OFF|ON}
:CALCulate:PARAmeter[:CATegory]:LD:NAFunction?
```

**Parameter 1: Fitting Curve Type**

<switch>	Fitting Curve
LINear	Linear
GAUSS	Gauss
3RD	3rd POLY
4TH	4th POLY
5TH	5th POLY

**Parameter 2: Fitting Curve Display**

0|OFF: Does not display fitting curve  
1|ON: Displays fitting curve

**Response Data**

```
<switch>, {0|1}
```

**Example of Use**

```
:CALCulate:PARAmeter:CATegory:LD:NAFunction GAUSS,ON
:CALCulate:PARAmeter:CATegory:LD:NAFunction?
>GAUSS,1
```

## **:CALCulate:PARAmeter[:CATegory]:LD:NAUSer**

### **Function**

This command sets and queries the User Specify Area in Noise Parameter for LD Module application.

### **Syntax**

```
:CALCulate:PARAmeter[:CATegory]:LD:NAUSer  
<numeric>,<numeric>,<numeric>,<numeric>  
:CALCulate:PARAmeter[:CATegory]:LD:NAUSer?
```

No.	Parameter Type	Range	Description
1	<numeric>	0.01 to 100.00 nm	Left Noise Position
2	<numeric>	0.01 to 100.000 nm	Left Span
3	<numeric>	0.01 to 100.000 nm	Right Noise Position
4	<numeric>	0.01 to 100.000 nm	Right Span

Resolution 0.01 nm

If a suffix is omitted, the unit will be m.

### **Response Data**

```
<numeric>,<numeric>,<numeric>,<numeric>
```

```
<numeric>: Span/Noise Position (m)  
+1.00000000E-011 to +1.00000000E-007
```

### **Example of Use**

```
:CALCulate:PARAmeter:CATegory:LD:NAUSer  
50.00NM,10.00NM,60.00NM,15.00NM  
:CALCulate:PARAmeter:CATegory:LD:NAUSer?  
>+5.00000000E-008,+1.00000000E-008,+6.00000000E-008,+1.5  
0000000E-008
```



**:CALCulate:PARAmeter[:CATegory]:LD:NDBWidth****Function**

This command sets and queries the ndB Width parameter for the LD Module application.

**Syntax**

```
:CALCulate:PARAmeter[:CATegory]:LD:NDBWidth <numeric>[DB]
```

```
:CALCulate:PARAmeter[:CATegory]:LD:NDBWidth?
```

<numeric>: Cut Level

Range 0.1 to 50.0 dB

Resolution 0.1 dB

If a suffix is omitted, the unit will be dB.

**Response Data**

```
<numeric>
```

<numeric>: Cut Level (dB)

+1.00000000E-001 to +5.00000000E+001

**Example of Use**

```
:CALCulate:PARAmeter:CATegory:LD:NDBWidth 20
```

```
:CALCulate:PARAmeter:CATegory:LD:NDBWidth?
```

```
>+2.00000000E+001
```

## **:CALCulate:PARAmeter[:CATegory]:LD:NNORmalize**

### **Function**

This command sets and queries the Noise BW of Noise Parameter for the LD Module application.

### **Syntax**

```
:CALCulate:PARAmeter[:CATegory]:LD:NNORmalize  
<numeric>[<unit_m>]  
:CALCulate:PARAmeter[:CATegory]:LD:NNORmalize?
```

<numeric>: Noise BW setting value

Range 0.1 to 1.0 nm

Resolution 0.1 nm

If a suffix is omitted, the unit will be m.

### **Response Data**

```
<numeric>
```

<numeric>: Noise BW setting value (m)

+1.00000000E-010 to +1.00000000E-009

### **Example of Use**

```
:CALCulate:PARAmeter:CATegory:LD:NNORmalize 0.3NM  
:CALCulate:PARAmeter:CATegory:LD:NNORmalize?  
>+3.00000000E-010
```

**:CALCulate:PARAmeter[:CATegory]:LD:NOISe****Function**

This command sets and queries the Detection Type of Noise Parameter for the LD Module application.

**Syntax**

```
:CALCulate:PARAmeter[:CATegory]:LD:NOISe AREA|POINT
```

```
:CALCulate:PARAmeter[:CATegory]:LD:NOISe?
```

AREA:           Sets Detection Type to Area  
POINT:           Sets Detection Type to Point

**Response Data**

```
AREA|POINT
```

**Example of Use**

```
:CALCulate:PARAmeter:CATegory:LD:NOISe AREA
```

```
:CALCulate:PARAmeter:CATegory:LD:NOISe?
```

```
>AREA
```

## **:CALCulate:PARAmeter[:CATegory]:LD:NPOStion**

### **Function**

This command sets and queries Noise Position in Noise Parameter for the LD Module application.

### **Syntax**

```
:CALCulate:PARAmeter[:CATegory]:LD:NPOStion  
{<numeric>[<unit_m>]|OFF}  
:CALCulate:PARAmeter[:CATegory]:LD:NPOStion?
```

<numeric>: Noise Position

Range 0.01 to 20.00 nm

Resolution 0.01 nm

If a suffix is omitted, the unit will be m.

OFF: Sets the noise measurement at the Noise Position to Off.

### **Response Data**

```
<numeric>|0
```

<numeric>: Noise Position (m)  
+1.00000000E-011 to +2.00000000E-008

0: Off

### **Example of Use**

```
:CALCulate:PARAmeter:CATegory:LD:NPOStion 5NM  
:CALCulate:PARAmeter:CATegory:LD:NPOStion?  
>+5.00000000E-009
```

**:CALCulate:PARAmeter[:CATegory]:LD:POINT****Function**

This command sets and queries Point and Noise Position in Noise Parameter for LD Module application.

**Syntax**

```
:CALCulate:PARAmeter[:CATegory]:LD:POINT
<switch>, {<numeric>[<unit_m>] | OFF}
:CALCulate:PARAmeter[:CATegory]:LD:POINT?
```

Parameter 1: Measurement method of noise level

<switch>	Point
AVERAGE	(L+R)/2
HIGHER	Higher
LEFT	Left
RIGHT	Right

Parameter 2:

```
<numeric>: Noise Position
Range      0.01 to 20.00 nm
Resolution 0.01 nm
```

If a suffix is omitted, the unit will be m.

OFF: Sets the Noise Position measurement to Off.

**Response Data**

```
<switch>,{<numeric>|0}
```

Parameter 1: Measurement method of noise level

<switch>	Point
AVERAGE	(L+R)/2
HIGHER	Higher
LEFT	Left
RIGHT	Right

Parameter 2:

```
<numeric>: Noise Position
```

```
<numeric>: Noise Position (m)
           +1.00000000E-011 to +2.00000000E-008
```

```
0: Off
```

**Example of Use**

```
:CALCulate:PARAmeter:CATegory:LD:POINT AVERAGE,OFF
:CALCulate:PARAmeter:CATegory:LD:POINT?
>AVERAGE,0
```

## **:CALCulate:PARAmeter[:CATegory]:LD:SGLevel**

### **Function**

This command sets and queries the level detection method in Signal Parameter for LD Module application.

### **Syntax**

```
:CALCulate:PARAmeter[:CATegory]:LD:SGLevel  
{INTG[, <numeric>[<unit_m>]] | POINT}  
:CALCulate:PARAmeter[:CATegory]:LD:SGLevel?
```

Parameter 1: Sets Detection Type

INTG:             $\Sigma$ Power  
POINT:          Point

Parameter 2:

<numeric>:     Signal Span (m)  
Range          0.01 to 50.00 nm  
Resolution     0.01 nm

If a suffix is omitted, the unit will be m.

If Parameter 2 is omitted, the Signal Span value is not changed.

### **Response Data**

INTG | POINT, <numeric>

<numeric>:     Signal Span (m)  
                 +1.00000000E-011 to +5.00000000E-008

### **Example of Use**

```
:CALCulate:PARAmeter:CATegory:LD:SGLevel INTG,0.5NM  
:CALCulate:PARAmeter:CATegory:LD:SGLevel?  
>INTG,+5.00000000E-010
```

**:CALCulate:PARAmeter[:CATegory]:LD:SGSelect****Function**

This command sets and queries the signal level in Signal Parameter for the LD Module application.

**Syntax**

```
:CALCulate:PARAmeter[:CATegory]:LD:SGSelect SIGNAL|SIG
```

```
:CALCulate:PARAmeter[:CATegory]:LD:SGSelect?
```

SIGNAL:       Signal - Noise

SIG:           Signal

**Response Data**

```
SIGNAL|SIG
```

**Example of Use**

```
:CALCulate:PARAmeter:CATegory:LD:SGSelect SIGNAL
```

```
:CALCulate:PARAmeter:CATegory:LD:SGSelect?
```

```
>SIGNAL
```

## **:CALCulate:PARAmeter[:CATegory]:LD:SGWavelength**

### **Function**

This command sets and queries the wavelength detection method in Signal Parameter for the LD Module application.

### **Syntax**

```
:CALCulate:PARAmeter[:CATegory]:LD:SGWavelength  
{PEAK|THRESHOLD[,<numeric>[DB]]}  
:CALCulate:PARAmeter[:CATegory]:LD:SGWavelength?
```

Parameter 1: Sets Detection Type

PEAK: Peak

THRESHOLD: Threshold

Parameter 2: Threshold Cut Level (dB)

<numeric>: Threshold Cut Level

Range 0.1 to 50.0 dB

Resolution 0.1 dB

If a suffix is omitted, the unit will be dB.

If Parameter 2 is omitted, Threshold Cut Level is not changed.

### **Response Data**

```
PEAK|THRESHOLD,<numeric>
```

<numeric>: Threshold Cut Level (dB)

+1.00000000E-001 to +5.00000000E+001

### **Example of Use**

```
:CALCulate:PARAmeter:CATegory:LD:SGWavelength  
THRESHOLD,25  
:CALCulate:PARAmeter:CATegory:LD:SGWavelength?  
>THRESHOLD,+2.50000000E+001
```



**:CALCulate:PARAmeter[:CATegory]:LD:SMSR****Function**

This command sets and queries the detection method of the side mode suppression ratio for the LD module application.

**Syntax**

```
:CALCulate:PARAmeter[:CATegory]:LD:SMSR  
2NDPEAK|LEFT|RIGHT  
:CALCulate:PARAmeter[:CATegory]:LD:SMSR?
```

2NDPEAK:	2nd Peak
LEFT:	Left
RIGHT:	Right

**Response Data**

```
2NDPEAK|LEFT|RIGHT
```

**Example of Use**

```
:CALCulate:PARAmeter:CATegory:LD:SMSR 2NDPEAK  
:CALCulate:PARAmeter:CATegory:LD:SMSR?  
>2NDPEAK
```

## **:CALCulate:PARAmeter[:CATegory]:LD:SRES**

### **Function**

This command sets and queries the level resolution to detect the side mode for the LD module application.

### **Syntax**

```
:CALCulate:PARAmeter[:CATegory]:LD:SRES <numeric>[DB]
```

```
:CALCulate:PARAmeter[:CATegory]:LD:SRES?
```

<numeric>: Level resolution

Range 0.10 to 10.00 dB

Resolution 0.01 dB

If a suffix is omitted, the unit will be dB.

### **Response Data**

```
<numeric>
```

<numeric>: Level resolution (dB)

```
+1.00000000E-001+1.00000000E+001
```

### **Example of Use**

```
:CALCulate:PARAmeter:CATegory:LD:SRES 0.5
```

```
:CALCulate:PARAmeter:CATegory:LD:SRES?
```

```
>+5.00000000E-001
```

**:CALCulate:PARAmeter[:CATegory]:LD:THReshold****Function**

This command sets and queries the slice level in Signal Parameter in the LD Module application.

**Syntax**

```
:CALCulate:PARAmeter[:CATegory]:LD:THReshold  
<numeric>[DB]  
:CALCulate:PARAmeter[:CATegory]:LD:THReshold?
```

<numeric>	Slice level
Range	0.1 to 50.0 dB
Resolution	0.1 dB

If a suffix is omitted, the unit will be dB.

**Response Data**

```
<numeric>
```

<numeric>:	Slice level (dB)
	+1.00000000E-001 to +5.00000000E+001

**Example of Use**

```
:CALCulate:PARAmeter:CATegory:LD:THReshold 3  
:CALCulate:PARAmeter:CATegory:LD:THReshold?  
>+3.00000000E+000
```

## **:CALCulate:PARAmeter[:CATegory]:LED**

### **Function**

This command executes the LED application and specifies the parameters.

This command queries the parameters for the LED application.

### **Syntax**

```
:CALCulate:PARAmeter[:CATegory]:LED
```

```
<numeric>,<numeric>,<numeric>
```

```
:CALCulate:PARAmeter[:CATegory]:LED?
```

No.	Parameter Type	Range	Description
1	<numeric>	0.1 to 50.00 dB Res. 0.01 dB	Cut Level
2	<numeric>	-10.00 to 10.00dB Res. 0.01 dB	Total power correction value (dB)
3	<numeric>	1.00 to 10.00 Res. 0.01	k: Standard deviation factor

### **Response Data**

```
<numeric>,<numeric>,<numeric>
```

No.	Parameter Type	Description
1	<numeric>	Cut Level (dB)
2	<numeric>	Total power correction value (dB)
3	<numeric>	k: Standard deviation factor

### **Example of Use**

```
:CALCulate:PARAmeter:CATegory:LED 35,0,2.35
```

```
:CALCulate:PARAmeter:CATegory:LED?
```

```
>7,+3.5000000E+001,+0.0000000E+000,+2.3500000E+000
```

**:CALCulate:PARAmeter[:CATegory]:NDB****Function**

This command sets the ndB-Loss method and loss and performs spectrum analysis.

This command queries the loss.

**Syntax**

```
:CALCulate:PARAmeter[:CATegory]:NDB <numeric>[DB]  
:CALCulate:PARAmeter[:CATegory]:NDB?
```

Range            0.1 to 50.0 dB

Resolution      0.1 dB

If a suffix is omitted, the unit will be dB.

**Response Data**

<numeric>

<numeric>:      Loss (dB)  
                 +1.00000000E-001 to +5.00000000E+001

**Example of Use**

```
:CALCulate:PARAmeter:CATegory:NDB 20.2  
:CALCulate:PARAmeter:CATegory:NDB?  
>+2.02000000E+001
```

### **:CALCulate:PARAmeter[:CATegory]:NF:AALGo**

#### **Function**

This command sets and queries the Noise Position for the Optical AMP (WDM) application.

#### **Syntax**

```
:CALCulate:PARAmeter[:CATegory]:NF:AALGo  
<switch>[,<numeric>[<unit_m>]]  
:CALCulate:PARAmeter[:CATegory]:NF:AALGo?
```

The correspondence between <switch> and Opt Amp Test Parameter dialog box is shown below.

<switch>	Detection Type	Point	Fitting Span Mode
ACENter	Point	Auto (Center)	–
AFIX	Point	Auto (Res)	–
MCENter	Area	–	Auto (Center)
MFIX	Area	–	Manual
NPOStion	Point	Manual	–

When <switch> is set to NPOStion, set <numeric>.

<numeric>: Noise Position  
Range 0.10 to 100.00 nm  
Resolution 0.01 nm

If a suffix is omitted, the unit will be m.

#### **Response Data**

```
0|1|2|3|{4,<numeric>}
```

0: AFIX  
1: MFIX  
2: ACENter  
3: MCENter  
4: NPOStion  
<numeric>: Noise Position (m)

#### **Example of Use**

```
:CALCulate:PARAmeter:CATegory:NF:AALGo ACENter  
:CALCulate:PARAmeter:CATegory:NF:AALGo?  
>2
```

**:CALCulate:PARAmeter[:CATegory]:NF:AREA****Function**

This command sets and queries the ASE Area Parameter for the Optical AMP (WDM) application.

**Syntax**

```
:CALCulate:PARAmeter[:CATegory]:NF:AREA
CENTER|<numeric>[<unit_m>],<numeric>[<unit_m>]
:CALCulate:PARAmeter[:CATegory]:NF:AREA?
```

No.	Parameter type	Range	Description
1	CENTER	–	Sets the halfway point between channels as the interpolation range.
	<numeric>	0.10 to 100.00 nm	Fitting Span
2	<numeric>	0.10 to 100.00 nm	Masked Span
	Resolution	0.01 nm	

If a suffix is omitted, the unit will be m.

**Response Data**

```
CENTER|<numeric_value>,<numeric>
```

No.	Parameter type	Description
1	CENTER	Sets the halfway point between channels as the interpolation range.
	<numeric>	Fitting Span (m)
2	<numeric>	Masked Span (m)
<numeric>:		Fitting Span/ Masked Span (m)
		+1.00000000E-010 to +1.00000000E-007

**Example of Use**

```
:CALCulate:PARAmeter:CATegory:Nf:AREA 1.00e-9,0.50e-9
:CALCulate:PARAmeter:CATegory:Nf:AREA?
>+1.00000000E-009,+5.00000000E-010
```

## **:CALCulate:PARAmeter[:CATegory]:NF:ASE**

### **Function**

This command sets and queries the ASE Noise Detection Type for the Optical AMP (WDM) application.

### **Syntax**

```
:CALCulate:PARAmeter[:CATegory]:NF:ASE AREA|POINT
```

```
:CALCulate:PARAmeter[:CATegory]:NF:ASE?
```

AREA:           The Detection Type is set to Area.

POINT:          The Detection Type is set to Point.

### **Response Data**

```
AREA|POINT
```

### **Example of Use**

```
:CALCulate:PARAmeter:CATegory:Nf:ASE AREA
```

```
:CALCulate:PARAmeter:CATegory:Nf:ASE?
```

```
>AREA
```



**:CALCulate:PARAmeter[:CATegory]:NF:FALGo****Function**

This command sets and queries the Fitting Curve for the Optical AMP (WDM) application.

**Syntax**

```
:CALCulate:PARAmeter[:CATegory]:NF:FALGo <switch>
```

```
:CALCulate:PARAmeter[:CATegory]:NF:FALGo?
```

<switch>	Fitting Curve
LINear	Linear
GAUSS	Gauss
3RD	3rd POLY
4TH	4th POLY
5TH	5th POLY

**Response Data**

```
0|1|3|4|5
```

```
0:      Linear
1:      Gauss
3:      3rd POLY
4:      4th POLY
5:      5th POLY
```

**Example of Use**

```
:CALCulate:PARAmeter:CATegory:NF:FALGo GAUSS
:CALCulate:PARAmeter:CATegory:NF:FALGo?
>1
```

### **:CALCulate:PARAmeter[:CATegory]:NF:FARea**

#### **Function**

This command sets and queries the Fitting Span for the Optical AMP (WDM) application.

#### **Syntax**

```
:CALCulate:PARAmeter[:CATegory]:NF:FARea  
<numeric>[<unit_m>]  
:CALCulate:PARAmeter[:CATegory]:NF:FARea?
```

Range            0.10 to 100.00 nm  
Resolution       0.01 nm  
If a suffix is omitted, the unit will be m.

#### **Response Data**

<numeric>

<numeric>:     Fitting Span (m)  
                 +1.00000000E-010 to +1.00000000E-007

#### **Example of Use**

```
:CALCulate:PARAmeter:CATegory:Nf:FARea 5NM  
:CALCulate:PARAmeter:CATegory:Nf:FARea?  
>+5.00000000E-009
```

### **:CALCulate:PARAmeter[:CATegory]:NF:IOFFset**

#### **Function**

This command sets and queries the Loss correction factor for signal level of the Optical AMP (WDM) application.

#### **Syntax**

```
:CALCulate:PARAmeter[:CATegory]:NF:IOFFset <numeric>[DB]  
:CALCulate:PARAmeter[:CATegory]:NF:IOFFset?
```

<numeric>:     Pin Loss (Offset)  
Range           -10.00 to 10.00 dB  
Resolution       0.01 dB  
If a suffix is omitted, the unit will be dB.

#### **Response Data**

<numeric>

<numeric>: Pin Loss (Offset) (dB)  
-1.00000000E+001 to +1.00000000E+001

**Example of Use**

```
:CALCulate:PARAmeter:CATegory:NF:IOFFset 0.2
:CALCulate:PARAmeter:CATegory:NF:IOFFset?
>+2.00000000E-001
```

**:CALCulate:PARAmeter[:CATegory]:NF:MARea****Function**

This command sets and queries the Masked Span for the Optical AMP (WDM) application.

**Syntax**

```
:CALCulate:PARAmeter[:CATegory]:NF:MARea
<numeric>[<unit_m>]
:CALCulate:PARAmeter[:CATegory]:NF:MARea?
```

Range 0.10 to 100.00 nm

Resolution 0.01 nm

If a suffix is omitted, the unit will be m.

**Response Data**

<numeric>

<numeric>: Masked Span (m)  
+1.00000000E-010 to +1.00000000E-007

**Example of Use**

```
:CALCulate:PARAmeter:CATegory:NF:MARea 2.5NM
:CALCulate:PARAmeter:CATegory:NF:MARea?
>+2.50000000E-009
```

### **:CALCulate:PARAmeter[:CATegory]:NF:MDIFF**

#### **Function**

This command sets and queries the threshold value for detecting the peak (channel) in the Optical AMP (WDM) application.

#### **Syntax**

```
:CALCulate:PARAmeter[:CATegory]:NF:MDIFF <numeric>[DB]
:CALCulate:PARAmeter[:CATegory]:NF:MDIFF?
```

<numeric>: Search Threshold  
Range 0.01 to 10.00 dB  
Resolution 0.01 dB  
If a suffix is omitted, the unit will be dB.

#### **Response Data**

<numeric>

<numeric>: Search Threshold (dB)  
+1.00000000E-002 to +1.00000000E+001

#### **Example of Use**

```
:CALCulate:PARAmeter:CATegory:NF:MDIFF 6
:CALCulate:PARAmeter:CATegory:NF:MDIFF?
>+6.00000000E+000
```

### **:CALCulate:PARAmeter[:CATegory]:NF:MSElect**

#### **Function**

This command selects the saving destination for measurement data from the Optical AMP (WDM) application.

This command queries the saving destination for measurement data from the Optical AMP (WDM) application.

#### **Syntax**

```
:CALCulate:PARAmeter[:CATegory]:NF:MSElect <switch>
:CALCulate:PARAmeter[:CATegory]:NF:MSElect?
```

<switch>: Measurement data saving destination {PIN|POUT}

#### **Response Data**

<switch>

#### **Example of Use**

```
:CALCulate:PARAmeter:CATegory:NF:MSElect PIN
```

```
:CALCulate:PARAmeter:CATegory:NF:MSElect?
>PIN
```

### :CALCulate:PARAmeter[:CATegory]:NF:OBPF

#### Function

This command sets the O.BPF Lvl Cal/BW for the Optical AMP (WDM) application.

This command queries the O.BPF Lvl Cal/BW setting for the Optical AMP (WDM) application.

#### Syntax

```
:CALCulate:PARAmeter[:CATegory]:NF:OBPF
<numeric>,<numeric>[<unit_m>]
:CALCulate:PARAmeter[:CATegory]:NF:OBPF?
```

No.	Parameter type	Range	Description
1	<numeric>	0.00 to 30.00 dB Res. 0.01 dB	O.BPF Level Calibration Optical filter loss correction coefficient If a suffix is omitted, the unit will be dB.
2	<numeric>	0.00 to 999.99 nm Res. 0.01 nm	O.BPF Band Width Optical filter pass band width If a suffix is omitted, the unit will be m.

#### Response Data

```
<numeric>,<numeric>
```

No.	Parameter type	Description
1	<numeric>	O.BPF Level Calibration (dB) Optical filter loss correction coefficient
2	<numeric>	O.BPF Band Width (m) Optical filter pass band width

#### Example of Use

```
:CALCulate:PARAmeter:CATegory:NF:OBPF 1.00dB,30.00nm
:CALCulate:PARAmeter:CATegory:NF:OBPF?
>+1.00000000E+000,+3.00000000E-008
```

## **:CALCulate:PARAmeter[:CATegory]:NF:OOFFSET**

### **Function**

This command sets and queries the Loss correction factor for optical level output of the Optical AMP (WDM) application.

### **Syntax**

```
:CALCulate:PARAmeter[:CATegory]:NF:OOFFSET <numeric>[DB]
```

```
:CALCulate:PARAmeter[:CATegory]:NF:OOFFSET?
```

<numeric>: Pout Loss (Offset)

Range -10.00 to 10.00 dB

Resolution 0.01 dB

If a suffix is omitted, the unit will be dB.

### **Response Data**

<numeric>

<numeric>: Pout Loss (Offset) (dB)

-1.00000000E+001 to +1.00000000E+001

### **Example of Use**

```
:CALCulate:PARAmeter:CATegory:Nf:OOFFSET -0.18
```

```
:CALCulate:PARAmeter:CATegory:Nf:OOFFSET?
```

```
>-1.80000000E-001
```

**:CALCulate:PARAmeter[:CATegory]:NF:PARAmeter****Function**

This command sets the measurement parameters for the Optical AMP (WDM) application.

This command queries the measurement parameters for the Optical AMP (WDM) application.

**Syntax**

```
:CALCulate:PARAmeter[:CATegory]:NF:PARAmeter
<switch>,<switch>,<numeric>,<numeric>,<numeric>,<switch>
,<switch>
:CALCulate:PARAmeter[:CATegory]:NF:PARAmeter?
```

No.	Parameter type	Range	Description
1	<switch>	0 1	0: NF (S-ASE) 1: NF (Total)
2	<switch>	0 1 2	0: ISS Method (IEC) 1: ISS Method (Advanced) 2: Off
3	<numeric>	-10.00 to 10.00 dB Res. 0.01 dB	Pin Loss(Offset) Loss correction factor for signal level
4	<numeric>	-10.00 to 10.00 dB Res. 0.01 dB	Pout Loss(Offset) Loss correction factor for optical level output
5	<numeric>	0.100 to 10.000 Res. 0.001	NF Calibration Correction factor for noise figure
6	<switch>	0 1	0: Actual Resolution (Measured) 1: Actual Resolution (Initial)
7	<switch>	OFF ON	OFF: Fitting curve not displayed ON: Fitting curve displayed

**Response Data**

<switch>,<switch>,<numeric>,<numeric>,<numeric>,<switch>  
,<switch>

No.	Parameter type	Description
1	<switch>	0: NF (S-ASE) 1: NF (Total)
2	<switch>	0: ISS Method (IEC) 1: ISS Method (Advanced) 2: Off
3	<numeric>	Pin Loss(Offset) (dB) Loss correction factor for signal level
4	<numeric>	Pout Loss(Offset) (dB) Loss correction factor for optical level output
5	<numeric>	NF Calibration Correction factor for noise figure
6	<switch>	0: Actual Resolution (Measured) 1: Actual Resolution (Initial)
7	<switch>	OFF: Fitting curve not displayed ON: Fitting curve displayed

**Example of Use**

```
:CALCulate:PARAmeter:CATegory:Nf:PARAmeter
0,2,10,5,10,0,ON
:CALCulate:PARAmeter:CATegory:Nf:PARAmeter?
>0,2,+1.00000000E+001,+5.00000000E+000,+1.00000000E+001,
0,ON
```



**:CALCulate:PARAmeter[:CATegory]:NF:PDISplay****Function**

This command sets and queries the On/Off state of the Fitting Curve display of the Optical AMP (WDM) application.

**Syntax**

```
:CALCulate:PARAmeter[:CATegory]:NF:PDISplay 0|1|OFF|ON
:CALCulate:PARAmeter[:CATegory]:NF:PDISplay?
```

0|OFF:           Fitting curve not displayed  
1|ON:            Fitting curve displayed

**Response Data**

```
0|1
```

**Example of Use**

```
:CALCulate:PARAmeter:CATegory:Nf:PDISplay ON
:CALCulate:PARAmeter:CATegory:Nf:PDISplay?
>1
```

**:CALCulate:PARAmeter[:CATegory]:NF:PIN****Function**

This command selects the trace memory for saving the Pin of the Optical AMP (WDM) application.

This command queries the trace memory for saving the Pin of the Optical AMP (WDM) application.

**Syntax**

```
:CALCulate:PARAmeter[:CATegory]:NF:PIN <trace>
:CALCulate:PARAmeter[:CATegory]:NF:PIN?
```

**Response Data**

```
<trace>
```

**Example of Use**

```
:CALCulate:PARAmeter:CATegory:Nf:PIN G
:CALCulate:PARAmeter:CATegory:Nf:PIN?
>G
```

### **:CALCulate:PARAmeter[:CATegory]:NF:POUT**

#### **Function**

This command selects the trace memory that saves Pout for the Optical AMP (WDM) application.

This command queries the trace memory that saves Pout for the Optical AMP (WDM) application.

#### **Syntax**

```
:CALCulate:PARAmeter[:CATegory]:NF:POUT <trace>  
:CALCulate:PARAmeter[:CATegory]:NF:POUT?
```

#### **Response Data**

```
<trace>
```

#### **Example of Use**

```
:CALCulate:PARAmeter:CATegory:Nf:POUT H  
:CALCulate:PARAmeter:CATegory:Nf:POUT?  
>H
```

### **:CALCulate:PARAmeter[:CATegory]:NF:RBWidth**

#### **Function**

This command sets and queries the Actual Resolution for the Optical AMP (WDM) application.

#### **Syntax**

```
:CALCulate:PARAmeter[:CATegory]:NF:RBWidth <switch>  
:CALCulate:PARAmeter[:CATegory]:NF:RBWidth?
```

<switch>	Actual Resolution
0 MEASured	Measured
1 CAL	Initial

#### **Response Data**

```
0|1
```

#### **Example of Use**

```
:CALCulate:PARAmeter:CATegory:Nf:RBWidth MEASured  
:CALCulate:PARAmeter:CATegory:Nf:RBWidth?  
>0
```

**:CALCulate:PARAmeter[:CATegory]:NF:SNOise****Function**

This command sets and queries the NF calculation method for the Optical AMP (WDM) application.

**Syntax**

```
:CALCulate:PARAmeter[:CATegory]:NF:SNOise 0|1|OFF|ON
```

```
:CALCulate:PARAmeter[:CATegory]:NF:SNOise?
```

0|OFF: Sets NF Select to S-ASE

1|ON: Sets NF Select to Total

**Response Data**

```
0|1
```

**Example of Use**

```
:CALCulate:PARAmeter:Nf:SNOise OFF
```

```
:CALCulate:PARAmeter:Nf:SNOise?
```

```
>0
```

## **:CALCulate:PARAmeter[:CATegory]:NF:TH**

### **Function**

This command sets and queries the slice level for the Optical AMP (WDM) application.

### **Syntax**

`:CALCulate:PARAmeter[:CATegory]:NF:TH <numeric>[DB]`

`:CALCulate:PARAmeter[:CATegory]:NF:TH?`

`<numeric>:` S.Level

Range 0.1 to 50.0 dB

Resolution 0.1 dB

If a suffix is omitted, the unit will be dB.

### **Response Data**

`<numeric>`

`<numeric>:` S.Level (dB)

+1.00000000E-001 to +5.00000000E+001

### **Example of Use**

`:CALCulate:PARAmeter:CATegory:Nf:Th 36`

`:CALCulate:PARAmeter:CATegory:Nf:Th?`

`>+3.60000000E+001`

**:CALCulate:PARAmeter[:CATegory]:NF:WDETECT****Function**

This command sets and queries the wavelength detection method in Signal Parameter for the Optical AMP (WDM) application.

**Syntax**

```
:CALCulate:PARAmeter[:CATegory]:NF:WDETECT
PEAK|THRESHOLD[,<numeric>[DB]]
:CALCulate:PARAmeter[:CATegory]:NF:WDETECT?
```

Parameter 1: Sets Detection Type

PEAK: Peak

THRESHOLD: Threshold

Parameter 2:

<numeric>: Threshold Cut Level

Range 0.1 to 50.0 dB

Resolution 0.1 dB

If a suffix is omitted, the unit will be dB.

If Parameter 2 is omitted, Threshold Cut Level is not changed.

**Response Data**

```
PEAK|THRESHOLD,<numeric>
```

Parameter 1: Sets Detection Type

PEAK: Peak

THRESHOLD: Threshold

Parameter 2:

<numeric>: Threshold Cut Level (dB)

+1.00000000E-001 to +5.00000000E+001

**Example of Use**

```
:CALCulate:PARAmeter:CATegory:Nf:WDETECT THRESHOLD,25
:CALCulate:PARAmeter:CATegory:Nf:WDETECT?
>THRESHOLD,+2.50000000E+001
```

## :CALCulate:PARAmeter[:CATegory]:PMD

### Function

This command sets the parameters and performs PMD application analysis.

This command queries the parameters for the PMD application.

### Syntax

```
:CALCulate:PARAmeter[:CATegory]:PMD
<numeric>[DB],<switch>,[<numeric>]
:CALCulate:PARAmeter[:CATegory]:PMD?
```

No.	Parameter Type	Range	Description
1	<numeric>	0.01 to 1.00 dB Res. 0.01 dB	Mode Coupling factor (dB) If a suffix is omitted, the unit will be dB.
2	<switch>	0 1	Selecting measurement method 0: Auto 1: Manual
3	<numeric>	2 to 99 Res. 1	Peak Count Measurement method 0: can be omitted when Auto is set.

### Response Data

```
<numeric>,<switch>,[<numeric>]
```

No.	Parameter Type	Description
1	<numeric>	Mode Coupling factor (dB)
2	<switch>	Selecting measurement method 0: Auto 1: Manual
3	<numeric>	Peak Count

### Example of Use

```
:CALCulate:PARAmeter:CATegory:PMD 0.8,1,8
:CALCulate:PARAmeter:CATegory:PMD?
>+8.00000000E-001,1,8
```

**:CALCulate:PARAmeter[:CATegory]:POWER:OFFSet****Function**

This command sets the level offset and moves the screen waveform by the level offset amount.

This command queries the level offset.

**Syntax**

```
:CALCulate:PARAmeter[:CATegory]:POWER:OFFSet  
<numeric>[DB]  
:CALCulate:PARAmeter[:CATegory]:POWER:OFFSet?
```

Range            -30.00 to 30.00 dB

Resolution      0.01 dB

If a suffix is omitted, the unit will be dB.

**Response Data**

<numeric>

<numeric>:      Level offset value (dB)  
                 -3.00000000E+001 to +3.00000000E+001

**Example of Use**

```
:CALCulate:PARAmeter:CATegory:POWER:OFFSet 2.6  
:CALCulate:PARAmeter:CATegory:POWER:OFFSet?  
>+2.60000000E+000
```

### **:CALCulate:PARAmeter[:CATegory]:SMSR**

#### **Function**

This command sets the SMSR method and detecting method and performs spectrum analysis.

This command queries the spectrum analysis method and detecting method.

#### **Syntax**

```
:CALCulate:PARAmeter[:CATegory]:SMSR 2NDPEAK|LEFT|RIGHT  
:CALCulate:PARAmeter[:CATegory]:SMSR?
```

2NDPEAK: 2nd Peak  
LEFT: Left  
RIGHT: Right

#### **Response Data**

2NDPEAK|LEFT|RIGHT

#### **Example of Use**

```
:CALCulate:PARAmeter:CATegory:SMSR LEFT  
:CALCulate:PARAmeter:CATegory:SMSR?  
>LEFT
```

### **:CALCulate:PARAmeter[:CATegory]:SWENvelope:TH1**

#### **Function**

This command sets and queries the cut level for the envelop method.

#### **Syntax**

```
:CALCulate:PARAmeter[:CATegory]:SWENvelope:TH1  
<numeric>[DB]  
:CALCulate:PARAmeter[:CATegory]:SWENvelope:TH1?
```

Range 0.1 to 20.0 dB  
Resolution 0.1 dB

If a suffix is omitted, the unit will be dB.

#### **Response Data**

<numeric>

<numeric>: Cut level (dB)  
+1.00000000E-001 to +2.00000000E+001



**Example of Use**

```
:CALCulate:PARAmeter:CATegory:SWENvelope:TH1 10
:CALCulate:PARAmeter:CATegory:SWENvelope:TH1?
>+1.00000000E+001
```

**:CALCulate:PARAmeter[:CATegory]:SWPKrms****Function**

This command sets and queries slice level and factor K for the RMS method.

**Syntax**

```
:CALCulate:PARAmeter[:CATegory]:SWPKrms
<numeric>[DB],<numeric>
:CALCulate:PARAmeter[:CATegory]:SWPKrms?
```

Parameter 1: Slice level

<numeric>:

Range 0.1 to 50.0 dB

Resolution 0.1 dB

If a suffix is omitted, the unit will be dB.

Parameter 2:

<numeric>: Standard deviation factor k

Range 1.00 to 10.00

Resolution 0.01

**Response Data**

<numeric>,<numeric>

Parameter 1:

<numeric>: Slice level (dB)

+1.00000000E-001 to +5.00000000E+001

Parameter 2:

<numeric>: Standard deviation factor k

+1.00000000E+000 to +1.00000000E+001

**Example of Use**

```
:CALCulate:PARAmeter:CATegory:SWPKrms 6,2.35
:CALCulate:PARAmeter:CATegory:SWPKrms?
>+6.00000000E+000,+2.35000000E+000
```

## **:CALCulate:PARAmeter[:CATegory]:SWPKrms:TH**

### **Function**

This command sets and queries slice level for the RMS method.

### **Syntax**

```
:CALCulate:PARAmeter[:CATegory]:SWPKrms:TH <numeric>[DB]  
:CALCulate:PARAmeter[:CATegory]:SWPKrms:TH?
```

Range            0.1 to 50.0 dB

Resolution      0.1 dB

If a suffix is omitted, the unit will be dB.

### **Response Data**

<numeric>

<numeric>:      Slice level (dB)  
                 +1.00000000E-001 to +5.00000000E+001

### **Example of Use**

```
:CALCulate:PARAmeter:CATegory:SWPKrms:TH 20  
:CALCulate:PARAmeter:CATegory:SWPKrms:TH?  
>+2.00000000E+001
```

**:CALCulate:PARAmeter[:CATegory]:SWTHresh:TH****Function**

This command sets and queries the cut level for the Threshold method.

**Syntax**

```
:CALCulate:PARAmeter[:CATegory]:SWTHresh:TH <numeric>[DB]
:CALCulate:PARAmeter[:CATegory]:SWTHresh:TH?
```

Range            0.1 to 50.0 dB

Resolution      0.1 dB

If a suffix is omitted, the unit will be dB.

**Response Data**

<numeric>

```
<numeric>:      Cut Level (dB)
                 +1.00000000E-001 to +5.00000000E+001
```

**Example of Use**

```
:CALCulate:PARAmeter:CATegory:SWTHresh:TH 30
:CALCulate:PARAmeter:CATegory:SWTHresh:TH?
>+3.00000000E+001
```

### **:CALCulate:PARAmeter[:CATegory]:WDM:AREA**

#### **Function**

This command sets the Area Type in Noise Parameter for the WDM application to Channel or User Specify and queries the Area Type.

#### **Syntax**

```
:CALCulate:PARAmeter[:CATegory]:WDM:AREA [CH|USER]
:CALCulate:PARAmeter[:CATegory]:WDM:AREA?
```

CH: Sets Area Type to Channel

USER: Sets Area Type to User Specify

When the parameter is omitted, the Noise Parameter Detection Type is set to Area.

#### **Response Data**

CH|USER

#### **Example of Use**

```
:CALCulate:PARAmeter:CATegory:WDM:AREA USER
:CALCulate:PARAmeter:CATegory:WDM:AREA?
>USER
```

### **:CALCulate:PARAmeter[:CATegory]:WDM:DTYPE**

#### **Function**

This command sets and queries the display method for the WDM application.

#### **Syntax**

```
:CALCulate:PARAmeter[:CATegory]:WDM:DTYPE
<switch>[,<numeric>]
:CALCulate:PARAmeter[:CATegory]:WDM:DTYPE? [REL]
```

<switch>	Screen display
ABSolute	Table
RELative	Relative
MPK	Multi Peak
TBL	Table
SNR	SNR

When <switch> is set to REL, <numeric> can be specified.

<numeric>: Reference wavelength number from 1 to 300

**Response Data**

0|1|2|3|<numeric>

0:	Displays absolute value (ABSolute TBL)
1:	Displays relative value (RELative)
2:	MPK
3:	SNR
<numeric>:	Reference wavelength number if the query parameter REL is specified

**Example of Use**

```
:CALCulate:PARAmeter:WDM:DTYPE TBL
```

```
:CALCulate:PARAmeter:WDM:DTYPE?
```

```
>0
```

```
:CALCulate:PARAmeter:CATegory:WDM:DTYPE REL
```

```
:CALCulate:PARAmeter:CATegory:WDM:DTYPE?
```

```
>1
```

```
:CALCulate:PARAmeter:CATegory:WDM:DTYPE REL,7
```

```
:CALCulate:PARAmeter:CATegory:WDM:DTYPE? REL
```

```
>7
```

```
:CALCulate:PARAmeter:CATegory:WDM:DTYPE MPK
```

```
:CALCulate:PARAmeter:CATegory:WDM:DTYPE?
```

```
>2
```

```
:CALCulate:PARAmeter:CATegory:WDM:DTYPE SNR
```

```
:CALCulate:PARAmeter:CATegory:WDM:DTYPE?
```

```
>3
```

## **:CALCulate:PARAmeter[:CATegory]:WDM:FALGo**

### **Function**

This command sets and queries the Fitting Curve in Noise Parameter for the WDM application.

### **Syntax**

`:CALCulate:PARAmeter[:CATegory]:WDM:FALGo <switch>`

`:CALCulate:PARAmeter[:CATegory]:WDM:FALGo?`

<code>&lt;switch&gt;</code>	Fitting Curve
LINear	Linear
GAUSS	Gauss
3RD	3rd POLY
4TH	4th POLY
5TH	5th POLY

### **Response Data**

0|1|3|4|5

0:	Linear
1:	Gauss
3:	3rd POLY
4:	4th POLY
5:	5th POLY

### **Example of Use**

`:CALCulate:PARAmeter:CATegory:WDM:FALGo 3RD`

`:CALCulate:PARAmeter:CATegory:WDM:FALGo?`

`>3`

**:CALCulate:PARAmeter[:CATegory]:WDM:MARea****Function**

This command sets and queries the Masked Span in Noise Parameter for the WDM application.

**Syntax**

```
:CALCulate:PARAmeter[:CATegory]:WDM:MARea
<numeric>[<unit_m>]
:CALCulate:PARAmeter[:CATegory]:WDM:MARea?
```

Range            0.01 to 20.00 nm

Resolution      0.01 nm

If a suffix is omitted, the unit will be m.

**Response Data**

<numeric>

<numeric>:      Masked Span (m)  
                 +1.00000000E-011 to +2.00000000E-008

**Example of Use**

```
:CALCulate:PARAmeter:CATegory:WDM:MARea 1.2NM
:CALCulate:PARAmeter:CATegory:WDM:MARea?
>+1.20000000E-009
```

## **:CALCulate:PARAmeter[:CATegory]:WDM:NACHannel**

### **Function**

This command sets and queries the Channel Area in Noise Parameter for the WDM application.

### **Syntax**

```
:CALCulate:PARAmeter[:CATegory]:WDM:NACHannel  
<numeric>[<unit_m>],<numeric>[<unit_m>]  
:CALCulate:PARAmeter[:CATegory]:WDM:NACHannel?
```

No.	Parameter Type	Range	Description
1	<numeric>	0.01 to 20.00 nm	Fitting Span
2	<numeric>	0.01 to 20.00 nm	Masked Span

Resolution 0.01 nm

If a suffix is omitted, the unit will be m.

### **Response Data**

```
<numeric>,<numeric>
```

```
<numeric>: Fitting/Masked Span (m)  
+1.00000000E-011 to 2.00000000E-008
```

### **Example of Use**

```
:CALCulate:PARAmeter:CATegory:WDM:NACHannel 10NM,8NM  
:CALCulate:PARAmeter:CATegory:WDM:NACHannel?  
>+1.00000000E-008,+8.00000000E-009
```



**:CALCulate:PARAmeter[:CATegory]:WDM:NAFunction****Function**

This command sets and queries the Fitting Curve in Noise Parameter for the WDM application.

**Syntax**

```
:CALCulate:PARAmeter[:CATegory]:WDM:NAFunction
<switch>,0|1|OFF|ON
:CALCulate:PARAmeter[:CATegory]:WDM:NAFunction?
```

**Parameter 1: Fitting Curve Type**

<switch>	Fitting Curve
LINear	Linear
GAUSS	Gauss
3RD	3rd POLY
4TH	4th POLY
5TH	5th POLY

**Parameter 2: Fitting Curve Display**

0|OFF: Does not display fitting curve  
1|ON: Displays fitting curve

**Response Data**

```
<switch>,0|1
```

**Example of Use**

```
:CALCulate:PARAmeter:CATegory:WDM:NAFunction LINear,ON
:CALCulate:PARAmeter:CATegory:WDM:NAFunction?
>LINEAR,1
```

## **:CALCulate:PARAmeter[:CATegory]:WDM:NARea**

### **Function**

This command sets and queries the Fitting Span in Noise Parameter for the WDM application.

### **Syntax**

```
:CALCulate:PARAmeter[:CATegory]:WDM:NARea  
<numeric>[<unit_m>]  
:CALCulate:PARAmeter[:CATegory]:WDM:NARea?
```

Range            0.01 to 20.00 nm

Resolution      0.01 nm

If a suffix is omitted, the unit will be m.

### **Response Data**

<numeric>

<numeric>:      Fitting Span (m)  
                  +1.00000000E-011 to +2.00000000E-008

### **Example of Use**

```
:CALCulate:PARAmeter:CATegory:WDM:NARea 3NM  
:CALCulate:PARAmeter:CATegory:WDM:NARea?  
>+3.00000000E-009
```

**:CALCulate:PARAmeter[:CATegory]:WDM:NAUSer****Function**

This command sets and queries the User Specify Area in Noise Parameter for the WDM application.

**Syntax**

```
:CALCulate:PARAmeter[:CATegory]:WDM:NAUSer
<numeric>[<unit_m>],<numeric>[<unit_m>],<numeric>[<unit_
m>],<numeric>[<unit_m>]
:CALCulate:PARAmeter[:CATegory]:WDM:NAUSer?
```

No.	Parameter Type	Range	Description
1	<numeric>	0.01 to 100.00 nm	Left Noise Position
2	<numeric>	0.01 to 100.00 nm	Left Span
3	<numeric>	0.01 to 100.00 nm	Right Noise Position
4	<numeric>	0.01 to 100.00 nm	Right Span

Resolution 0.01 nm

If a suffix is omitted, the unit will be m.

**Response Data**

```
<numeric>,<numeric>,<numeric>,<numeric>
```

<numeric>: Wavelength position/interval (m)  
+1.00000000E-011 to +1.00000000E-007

**Example of Use**

```
:CALCulate:PARAmeter:CATegory:WDM:NAUSer
50.00NM,10.00NM,60.00NM,15.00NM
:CALCulate:PARAmeter:CATegory:WDM:NAUSer?
>+5.00000000E-008,+1.00000000E-008,+6.00000000E-008,+1.5
0000000E-008
```

### **:CALCulate:PARAmeter[:CATegory]:WDM:NBW**

#### **Function**

This command sets and queries the Noise BW value for Normalization performed by the WDM application.

#### **Syntax**

```
:CALCulate:PARAmeter[:CATegory]:WDM:NBW
<numeric>[<unit_m>]
:CALCulate:PARAmeter[:CATegory]:WDM:NBW?
```

<numeric>: Noise BW setting value  
Range 0.1 to 1.0 nm  
Resolution 0.1 nm  
If a suffix is omitted, the unit will be m.

#### **Response Data**

<numeric>

<numeric>: Noise BW setting value (m)  
+1.00000000E-010 to +1.00000000E-009

When this command is executed, Normalization for Noise Parameter is set to On.

#### **Example of Use**

```
:CALCulate:PARAmeter:CATegory:WDM:NBW 0.5NM
:CALCulate:PARAmeter:CATegory:WDM:NBW?
>+5.00000000E-010
```

### **:CALCulate:PARAmeter[:CATegory]:WDM:NNORmalize**

#### **Function**

This command sets and queries the Normalization and Noise BW for the WDM application.

#### **Syntax**

```
:CALCulate:PARAmeter[:CATegory]:WDM:NNORmalize
{0|1|OFF|ON}[,<numeric>[<unit_m>]]
:CALCulate:PARAmeter[:CATegory]:WDM:NNORmalize?
```

0|OFF: Sets the Normalization to Off.  
1|ON: Sets the Normalization to On.

<numeric>: Noise BW setting value

Range 0.1 to 1.0 nm  
 Resolution 0.1 nm  
 If a suffix is omitted, the unit will be m.

**Response Data**

{0|1}, <numeric>

<numeric>: Noise BW setting value (m)  
 +1.00000000E-010 to +1.00000000E-009

**Example of Use**

```
:CALCulate:PARAmeter:WDM:NNORmalize ON
:CALCulate:PARAmeter:WDM:NNORmalize?
>1,+1.00000000E-009
```

**:CALCulate:PARAmeter[:CATegory]:WDM:PDISplay****Function**

This command sets and queries the On/Off state of the Fitting Curve display of the WDM application.

**Syntax**

```
:CALCulate:PARAmeter[:CATegory]:WDM:PDISplay 0|1|OFF|ON
:CALCulate:PARAmeter[:CATegory]:WDM:PDISplay?
```

0|OFF: Does not display fitting curve  
 1|ON: Displays fitting curve

**Response Data**

0|1

**Example of Use**

```
:CALCulate:PARAmeter:CATegory:WDM:PDISplay 0
:CALCulate:PARAmeter:CATegory:WDM:PDISplay?
>0
```

## **:CALCulate:PARAmeter[:CATegory]:WDM:PEXCursion**

### **Function**

This command sets and queries the Search Threshold in Signal Parameter at WDM application.

### **Syntax**

```
:CALCulate:PARAmeter[:CATegory]:WDM:PEXCursion  
<numeric>[DB]  
:CALCulate:PARAmeter[:CATegory]:WDM:PEXCursion?
```

Range            0.01 to 10.00 dB

Resolution      0.01 dB

If a suffix is omitted, the unit will be dB.

### **Response Data**

```
<numeric>
```

```
<numeric>:    Search Threshold (dB)  
              +1.00000000E-002 to +1.00000000E+001
```

### **Example of Use**

```
:CALCulate:PARAmeter:CATegory:WDM:PEXCursion 5  
:CALCulate:PARAmeter:CATegory:WDM:PEXCursion?  
>+5.00000000E+000
```

**:CALCulate:PARAmeter[:CATegory]:WDM:POINT****Function**

This command sets and queries Point and Noise Position in Noise Parameter for the WDM application.

**Syntax**

```
:CALCulate:PARAmeter[:CATegory]:WDM:POINT
<switch>, {<numeric>|OFF}
:CALCulate:PARAmeter[:CATegory]:WDM:POINT?
```

Parameter 1: Position of noise level detection

<switch>	Point
AVERAGE	(L+R)/2
HIGHER	Higher
LEFT	Left
RIGHT	Right

Parameter 2:

<numeric>: Noise Position

Range 0.01 to 20.00 nm

Resolution 0.01 nm

If a suffix is omitted, the unit will be m.

OFF: Sets the Noise Position measurement to Off.

**Response Data**

```
<switch>, {<numeric>|0}
```

Parameter 1: Position of noise level detection

<switch>	Point
AVERAGE	(L+R)/2
HIGHER	Higher
LEFT	Left
RIGHT	Right

Parameter 2:

<numeric>: Noise Position

+1.00000000E-011 to +2.00000000E-008

0 Off

**Example of Use**

```
:CALCulate:PARAmeter:CATegory:WDM:POINT AVERAGE,OFF
:CALCulate:PARAmeter:CATegory:WDM:POINT?
>AVERAGE,0
```

## **:CALCulate:PARAmeter[:CATegory]:WDM:SGLevel**

### **Function**

This command sets and queries the Level Detection type of Signal Parameter for the WDM application.

### **Syntax**

```
:CALCulate:PARAmeter[:CATegory]:WDM:SGLevel  
{INTG[,<numeric>[<unit_m>]]|POINT}  
:CALCulate:PARAmeter[:CATegory]:WDM:SGLevel?
```

Parameter 1: Detection Type setting

INTG:  $\Sigma$ Power

POINT: Point

Parameter 2:

<numeric>: Signal Span

Range 0.01 to 50.00 nm

Resolution 0.01 nm

If a suffix is omitted, the unit will be m.

If second parameter is omitted, the Signal Span is not changed.

### **Response Data**

```
INTG|POINT ,<numeric>
```

<numeric>: Signal Span (m)

+1.00000000E-011 to +5.00000000E-008

### **Example of Use**

```
:CALCulate:PARAmeter:CATegory:WDM:SGLevel INTG,0.5NM
```

```
:CALCulate:PARAmeter:CATegory:WDM:SGLevel?
```

```
>INTG,+5.00000000E-010
```



**:CALCulate:PARAmeter[:CATegory]:WDM:SGWavelength****Function**

This command sets and queries the level detection method in Signal Parameter for the WDM application.

**Syntax**

```
:CALCulate:PARAmeter[:CATegory]:WDM:SGWavelength
{<switch>[,<numeric>[DB]]}
:CALCulate:PARAmeter[:CATegory]:WDM:SGWavelength?
```

Parameter 1: Sets Detection Type

PEAK: Peak

THRESHOLD: Threshold

Parameter 2:

<numeric>: Threshold Cut Level

Range 0.1 to 50.0 dB

Resolution 0.1 dB

If a suffix is omitted, the unit will be dB.

If Parameter 2 is omitted, Threshold Cut Level is not changed.

**Response Data**

```
PEAK|THRESHOLD,<numeric>
```

<numeric>: Threshold Cut Level (dB)

+1.00000000E-001 to +5.00000000E+001

**Example of Use**

```
:CALCulate:PARAmeter:CATegory:WDM:SGWavelength
THRESHOLD,25
:CALCulate:PARAmeter:CATegory:WDM:SGWavelength?
>THRESHOLD,+2.50000000E+001
```

## **:CALCulate:PARAmeter[:CATegory]:WDM:SLICe**

### **Function**

This command sets and queries Slice Level in Signal Parameter at WDM application.

### **Syntax**

`:CALCulate:PARAmeter[:CATegory]:WDM:SLICe <numeric>[DB]`

`:CALCulate:PARAmeter[:CATegory]:WDM:SLICe?`

`<numeric>:` Slice Level

Range 0.1 to 50.0 dB

Resolution 0.1 dB

If a suffix is omitted, the unit will be dB.

### **Response Data**

`<numeric>`

`<numeric>:` Slice Level (dB)

+1.00000000E-001 to +5.00000000E+001

### **Example of Use**

`:CALCulate:PARAmeter:CATegory:WDM:SLICe 3`

`:CALCulate:PARAmeter:CATegory:WDM:SLICe?`

`>+3.00000000E+000`

**:CALCulate:PARAmeter[:CATegory]:WDM:SPOWer****Function**

This command sets and queries the signal level measurement method of the WDM application.

**Syntax**

```
:CALCulate:PARAmeter[:CATegory]:WDM:SPOWer  
0|1|PEAK|INTEgral  
:CALCulate:PARAmeter[:CATegory]:WDM:SPOWer?
```

0 PEAK:	Detects the peak level of the detected signal wavelength.
1 INTEgral:	Detects the integrated spectral power in the specified wavelength range.

**Response Data**

```
0|1
```

**Example of Use**

```
:CALCulate:PARAmeter:CATegory:WDM:SPOWer PEAK  
:CALCulate:PARAmeter:CATegory:WDM:SPOWer?  
>0
```

## **:CALCulate:PARAmeter[:CATegory]:WDM:TH**

### **Function**

This command sets and queries the cut level of the Signal Parameter Threshold method at WDM application.

### **Syntax**

`:CALCulate:PARAmeter[:CATegory]:WDM:TH <numeric>[DB]`

`:CALCulate:PARAmeter[:CATegory]:WDM:TH?`

Range            0.1 to 50.0 dB

Resolution      0.1 dB

If a suffix is omitted, the unit will be dB.

### **Response Data**

`<numeric>`

`<numeric>:`    Cut Level (dB)

                 +1.00000000E-001 to +5.00000000E+001

### **Example of Use**

`:CALCulate:PARAmeter:CATegory:WDM:TH 10`

`:CALCulate:PARAmeter:CATegory:WDM:TH?`

`>+1.00000000E+001`

**:CALCulate:PARAmeter[:CATegory]:WFIL:BANDwidth****Function**

This command sets and queries the BW/Pass Band parameters of the WDM Filter application.

**Syntax**

```
:CALCulate:PARAmeter[:CATegory]:WFIL:BANDwidth
<switch>,<numeric>,<numeric>[,<numeric>[<unit_m>]]
:CALCulate:PARAmeter[:CATegory]:WFIL:BANDwidth?
```

No.	Parameter Type	Range	Description
1	<switch>	BW PASSBAND	Measurement Method for Bandwidth
2	<numeric>	0.01 to 50.0 dB Res. 0.1 dB	Cut Level A
3	<numeric>	0.01 to 50.0 dB Res. 0.1 dB	Cut Level B
4	<numeric>	0.01 to 999.99 nm Res 0.01 nm	Pass Band Span

If Parameter 4 is omitted, Pass Band Span is not changed.

**Response Data**

```
<switch>,<numeric>,<numeric>[,<numeric>]
```

No.	Parameter Type	Description
1	<switch>	Measurement Method for Bandwidth
2	<numeric>	Cut Level A (dB)
3	<numeric>	Cut Level B (dB)
4	<numeric>	Pass Band Span (m)

When <switch> is set to BW, the fourth parameter is not available.

```
<numeric>: Cut Level (dB)
+1.00000000E-001 to +5.00000000E+001
<numeric>: Pass Band Span (m)
+1.00000000E-011 to +9.99990000E-007
```

**Example of Use**

```
:CALCulate:PARAmeter:CATegory:WFIL:BANDwidth
PASSBAND,6.00,26.00,1.20nm
:CALCulate:PARAmeter:CATegory:WFIL:BANDwidth?
>PASSBAND,+6.00000000E+000,+2.60000000E+001,+1.20000000E-009
```

## **:CALCulate:PARAmeter[:CATegory]:WFIL:PEXCursion**

### **Function**

This command sets and queries the Search Threshold for peak (channel) at WDM filter application.

### **Syntax**

```
:CALCulate:PARAmeter[:CATegory]:WFIL:PEXCursion  
<numeric>[DB]  
:CALCulate:PARAmeter[:CATegory]:WFIL:PEXCursion?
```

Range            0.01 to 10.00 dB

Resolution      0.01 dB

If a suffix is omitted, the unit will be dB.

### **Response Data**

<numeric>

<numeric>:      Search Threshold (dB)  
                  +1.00000000E-002 to +1.00000000E+001

### **Example of Use**

```
:CALCulate:PARAmeter:CATegory:WFIL:PEXCursion 5  
:CALCulate:PARAmeter:CATegory:WFIL:PEXCursion?  
>+5.00000000E+000
```

**:CALCulate:PARAmeter[:CATegory]:WFIL:RIPple****Function**

This command sets and queries the Ripple Span for the WDM Filter application.

**Syntax**

```
:CALCulate:PARAmeter[:CATegory]:WFIL:RIPple  
<numeric>[<unit_m>]  
:CALCulate:PARAmeter[:CATegory]:WFIL:RIPple?
```

Range            0.01 to 999.99 nm

Resolution      0.01 nm

If a suffix is omitted, the unit will be m.

**Response Data**

<numeric>

<numeric>:      Ripple Span (m)  
                 +1.00000000E-011 to +9.99990000E-007

**Example of Use**

```
:CALCulate:PARAmeter:CATegory:WFIL:RIPple 1.5NM  
:CALCulate:PARAmeter:CATegory:WFIL:RIPple?  
>+1.50000000E-009
```

## **:CALCulate:PARAmeter[:CATegory]:WFIL:SGLevel**

### **Function**

This command sets and queries the channel level detection method at WDM filter application.

### **Syntax**

```
:CALCulate:PARAmeter[:CATegory]:WFIL:SGLevel  
INTG|POINT[, <numeric>[<unit_m>]]  
:CALCulate:PARAmeter[:CATegory]:WFIL:SGLevel?
```

Parameter 1: Sets Detection Type

INTG:  $\Sigma$ Power  
POINT: Point

Parameter 2:

<numeric>: Signal Span  
Range 0.01 to 50.00 nm  
Resolution 0.01 nm

If a suffix is omitted, the unit will be m.

If Parameter 2 is omitted, Signal Span is not changed.

### **Response Data**

```
{INTG, <numeric>} | POINT
```

<numeric> Signal Span (m)  
+1.00000000E-011 to +5.00000000E-008

### **Example of Use**

```
:CALCulate:PARAmeter:CATegory:WFIL:SGLevel INTG, 0.5NM  
:CALCulate:PARAmeter:CATegory:WFIL:SGLevel?  
>INTG, +5.00000000E-010
```



**:CALCulate:PARAmeter[:CATegory]:WFIL:SGWavelength****Function**

This command sets and queries the channel wavelength detection method at WDM filter application.

**Syntax**

```
:CALCulate:PARAmeter[:CATegory]:WFIL:SGWavelength
{<switch>[,<numeric>[DB]]}
:CALCulate:PARAmeter[:CATegory]:WFIL:SGWavelength?
```

No.	Parameter Type	Range	Description
1	<switch>	PEAK RMS  THRESHOLD	Detection Method for Channel Wavelength
2	<numeric>	0.1 to 50.0 dB Res. 0.1 dB	Cut Level (dB) If a suffix is omitted, the unit will be dB.

If Parameter 2 is omitted, Channel Detection Cut Level is not changed.

**Response Data**

```
PEAK|THRESHOLD|RMS[,<numeric>]
```

```
<numeric>: Cut Level (dB)
+1.00000000E-001 to +5.00000000E+001
```

**Example of Use**

```
:CALCulate:PARAmeter:CATegory:WFIL:SGWavelength PEAK,25
:CALCulate:PARAmeter:CATegory:WFIL:SGWavelength?
>PEAK
```

**:CALCulate:PARAmeter[:CATegory]:WFIL:SLICe****Function**

This command sets and queries the slice level to detect the channel at WDM filter application.

**Syntax**

```
:CALCulate:PARAmeter[:CATegory]:WFIL:SLICe <numeric>[DB]
:CALCulate:PARAmeter[:CATegory]:WFIL:SLICe?
```

```
Range      0.1 to 50.0 dB
Resolution 0.1 dB
If a suffix is omitted, the unit will be dB.
```

**Response Data**

<numeric>

<numeric>: Slice Level (dB)  
+1.00000000E-001 to +5.00000000E+001

**Example of Use**

```
:CALCulate:PARAmeter:CATegory:WFIL:SLICE 32  
:CALCulate:PARAmeter:CATegory:WFIL:SLICE?  
>+3.20000000E+001
```

**:CALCulate:PARAmeter[:CATegory]:WFIL:TCL**

**Function**

This command sets and queries the cut level to measure the wavelength at WDM filter application.

**Syntax**

```
:CALCulate:PARAmeter[:CATegory]:WFIL:TCL  
<numeric>[DB],<numeric>[DB]  
:CALCulate:PARAmeter[:CATegory]:WFIL:TCL?
```

Parameter 1: Cut Level A

Parameter 2: Cut Level B

Range 0.1 to 50.0 dB

Resolution 0.1 dB

If a suffix is omitted, the unit will be dB.

**Response Data**

<numeric>,<numeric>

Parameter 1: Cut Level A (dB)

Parameter 2: Cut Level B (dB)

<numeric>: Cut Level (dB)  
+1.00000000E-001 to +5.00000000E+001

**Example of Use**

```
:CALCulate:PARAmeter:CATegory:WFIL:TCL 6,36  
:CALCulate:PARAmeter:CATegory:WFIL:TCL?  
>+6.00000000E+000,+3.60000000E+001
```

**:CALCulate:PEXCursion[:PEAK]****Function**

This command sets and queries the threshold value for detecting the peak (channel) in the Optical AMP (WDM) application.

**Syntax**

```
:CALCulate:PEXCursion[:PEAK] <numeric>[DB]
:CALCulate:PEXCursion[:PEAK]?
```

Range            0.01 to 10.00 dB

Resolution       0.01 dB

If a suffix is omitted, the unit will be dB.

**Response Data**

<numeric>

<numeric>:      Peak (channel) detection threshold value (dB)  
                  +1.00000000E-002 to +1.00000000E+001

**Example of Use**

```
:CALCulate:PEXCursion:PEAK 0.5
:CALCulate:PEXCursion:PEAK?
>+5.00000000E-001
```

**:CALCulate[1|2|3|4|5|6]:SIGMa[:DATA]?****Function**

This command queries the standard deviation at the RMS measurement of LED application.

**Syntax**

```
:CALCulate[1|2|3|4|5|6]:SIGMa[:DATA]?
```

Specify the Active trace (A to F) by specifying a number from 1 to 6. When omitted, the Active trace is not changed.

**Response Data**

<numeric>

<numeric>:      Standard deviation using RMS method (m)

**Example of Use**

```
:CALCulate1:SIGMa:DATA?
>+3.19875252E-009
```

### **:CALCulate:SNOise**

#### **Function**

This command sets and queries the NF calculation method of the Optical AMP (WDM) application.

#### **Syntax**

```
:CALCulate:SNOise 0|1|OFF|ON
```

```
:CALCulate:SNOise?
```

0|OFF: Sets the NF calculation method to NF (S-ASE).

1|ON: Sets the NF calculation method to NF (Total).

#### **Response Data**

```
0|1
```

#### **Example of Use**

```
:CALCulate:SNOise ON
```

```
:CALCulate:SNOise?
```

```
>1
```

**:CALCulate[1|2|3|4|5|6]:SOURce[:DATA]?****Function**

This command queries the analysis results of DFB application, FP-LD application, or LED application.

**Syntax**

```
:CALCulate[1|2|3|4|5|6]:SOURce[:DATA]?
```

Specify the Active trace (A to F) by specifying a number from 1 to 6. When omitted, the Active trace is not changed.

**Response Data****When executing the DFB-LD Application**

No.	Parameter	Type	Description
1	<numeric>	Peak:	Peak wavelength (m)
2	<numeric>	Mode Offset:	Difference between side mode wavelength and peak wavelength (m)
3	<numeric>	Stop Band:	Wavelength difference of both side modes of peak wavelength (m)
4	<numeric>	Center Offset:	Difference of means of peak wavelength and both side modes wavelength (m)
5	<numeric>	SMSR:	Side mode suppression ratio (dB)
6	<numeric>	Peak:	Peak level (dBm)
7	<numeric>	-999.99	
8	<numeric>	-999.99	

**When executing the FP-LD Application**

No.	Parameter	Type	Description
1	<numeric>	Mean Wl:	Center wavelength (m)
2	<numeric>	Peak:	Peak wavelength (m)
3	<numeric>	Mode Spacing (m)	
4	<numeric>	-999.99	
5	<numeric>	FWHM:	Spectrum width using RMS method (m)
6	<numeric>	Peak:	Peak level (dBm)
7	<numeric>	Total Power:	Spectrum integral power (dBm)
8	<numeric>	$\sigma$ :	Standard deviation using RMS method (m)

**When executing the LED Application**

No.	Parameter	Type	Description
1	<numeric>	Mean Wl (FWHM):	Center wavelength of spectrum half width (m)
2	<numeric>	Mean Wl (ndB):	Center wavelength using ndB Loss method (m)
3	<numeric>	Peak:	Peak wavelength (m)
4	<numeric>	$\sigma$ :	Standard deviation using RMS method (m)
5	<numeric>	FWHM (no):	Spectrum width using RMS method (m)
6	<numeric>	n dB Width :	Spectrum width using dB Loss method (m)
7	<numeric>	Total Power:	Spectrum integral power (dBm)
8	<numeric>	PkDens (/1nm):	Spectrum density max. value (dBm)

**Example of Use**

```
:CALCulate:SOURce:TEST LED
:CALCulate:SOURce:DATA?
>+1.52809200E-006,+1.53072500E-006,+1.53440000E-006,+3.2
1810000E-008,+7.57810000E-008,+7.07820000E-008,-1.988000
00E+001,-3.86800000E+001
```

**:CALCulate:SOURce:FUNCTion:BWIDth|BANDwidth:NDB****Function**

This command sets and queries the cut level for the DFB-LD application.

**Syntax**

```
:CALCulate:SOURce:FUNCTion:BWIDth|BANDwidth:NDB  
<numeric>[DB]  
:CALCulate:SOURce:FUNCTion:BWIDth|BANDwidth:NDB?
```

Range            0.1 to 50.0 dB

Resolution      0.1 dB

If a suffix is omitted, the unit will be dB.

**Response Data**

```
<numeric>
```

```
<numeric>:      Cut Level (dB)  
                 +1.00000000E-001 to +5.00000000E+001
```

**Example of Use**

```
:CALCulate:SOURce:FUNCTion:BWIDth:NDB 16  
:CALCulate:SOURce:FUNCTion:BWIDth:NDB?  
>+1.60000000E+001  
:CALCulate:SOURce:FUNCTion:BANDwidth:NDB 18  
:CALCulate:SOURce:FUNCTion:BANDwidth:NDB?  
>+1.80000000E+001
```

### **:CALCulate[1|2|3|4|5|6]:SOURce:TEST**

#### **Function**

This command runs the DFB application, FP-LD application or LED application.

This command queries which application is running.

When the analysis has completed, the bit 0 (measurement-end bit) of the end event status register is set to 1.

#### **Syntax**

`:CALCulate[1|2|3|4|5|6]:SOURce:TEST DFB|FP|LED|OFF`

`:CALCulate[1|2|3|4|5|6]:SOURce:TEST?`

Specify the Active trace (A to F) by specifying a number from 1 to 6.

When omitted, the Active trace is not changed.

DFB:	Runs the DFB application.
FP:	Runs the FP-LD application.
LED:	Runs the LED application.
OFF:	Sets the analysis by application to Off.

#### **Response Data**

DFB|FP|LED|OFF



**:CALCulate:THReshold****Function**

This command sets and queries the slice level for the Optical AMP (WDM) application.

**Syntax**

```
:CALCulate:THReshold <numeric>[DB]
:CALCulate:THReshold?
```

Range            0.1 to 50.0 dB

Resolution      0.1 dB

If a suffix is omitted, the unit will be dB.

**Response Data**

<numeric>

<numeric>:      Slice Level (dB)  
                  +1.00000000E-001 to +5.00000000E+001

**Example of Use**

```
:CALCulate:THReshold 0.1
:CALCulate:THReshold?
>+1.00000000E-001
```

**:CALCulate[1|2|3|4|5|6]:TPOWer[:DATA]?****Function**

This command queries the value of integrated power analysis of spectrum level.

**Syntax**

```
:CALCulate[1|2|3|4|5|6]:TPOWer[:DATA]?
```

Specify the Active trace (A to F) by specifying a number from 1 to 6. When omitted, the Active trace is not changed.

**Response Data**

<numeric>

<numeric>:      Value of integral analysis of spectrum level (dBm)

**Example of Use**

```
:CALCulate1:TPOWer:DATA?
>-1.11200277E+001
```

### **:CALCulate[1|2|3|4|5|6]:TPOWer:STATe**

#### **Function**

This command sets and queries the On/Off state of the integrated power analysis of spectrum level.

#### **Syntax**

`:CALCulate[1|2|3|4|5|6]:TPOWer:STATe 0|1|OFF|ON`

`:CALCulate[1|2|3|4|5|6]:TPOWer:STATe?`

Specify the Active trace (A to F) by specifying a number from 1 to 6. When omitted, the Active trace is not changed.

0|OFF: Sets the integrated power analysis of spectrum level to Off.

1|ON: Sets the integrated power analysis of spectrum level to On.

#### **Response Data**

0|1

#### **Example of Use**

`:CALCulate:TPOWer:STATe ON`

`:CALCulate:TPOWer:STATe?`

`>1`

### 3.4.4 CALibration Subsystem

The commands in CALibration subsystem have the following command hierarchy.

```

:ACTRes
  :DATA?
:ALIG[:IMMEDIATE]
:ALIGNment
  :PRESet
:AUTOalign
  :ENABLE
:PRESet
:RESCal
:WAVelength
  :EXTernal[:IMMEDIATE]
  [:EXTernal][:NORMal]
  :INTernal
    [:IMMEDIATE]
    [:NORMal]
:ZCAL
:ZERO[:AUTO]

```

#### :CALibration:ACTRes

##### Function

This command sets and queries display of the actual resolution.

##### Syntax

```

:CALibration:ACTRes 0|1|OFF|ON
:CALibration:ACTRes?

```

0|OFF: Does not display the actual resolution.  
1|ON: Displays the actual resolution.

##### Response Data

```
0|1
```

##### Example of Use

```

:CALibration:ACTRes ON
:CALibration:ACTRes?
>1

```

### **:CALibration:ACTRes:DATA?**

#### **Function**

This command queries the actual resolution.

#### **Syntax**

```
:CALibration:ACTRes:DATA?
```

#### **Response Data**

<numeric>

<numeric>: Actual resolution (m)

#### **Example of Use**

```
:CALibration:ACTRes:DATA?  
>+2.05000000E-010
```

### **:CALibration:ALIG[:IMMediate]**

#### **Function**

This command executes optical alignment. When alignment is complete, bit 4 of the end event status register (execution complete bit) is set to 1.

#### **Syntax**

```
:CALibration:ALIG[:IMMediate]  
:CALibration:ALIG[:IMMediate]?
```

#### **Response Data**

0|1|2|3

- 0: Normal end
- 1: During alignment
- 2: Aborted optical alignment due to lack of optical level
- 3: Aborted optical alignment due to other abnormality

#### **Example of Use**

```
:CALibration:ALIG:IMMediate  
:CALibration:ALIG:IMMediate?  
>0
```

**:CALibration:ALIGnment****Function**

This command executes optical alignment. When alignment is complete, bit 4 of the end event status register (execution complete bit) is set to 1.

**Syntax**

```
:CALibration:ALIGnment  
:CALibration:ALIGnment?
```

**Response Data**

```
0|1|2|3
```

- 0: Normal end
- 1: During alignment
- 2: Aborted optical alignment due to lack of optical level
- 3: Aborted optical alignment due to other abnormality

**Example of Use**

```
:CALibration:ALIGnment  
:CALibration:ALIGnment?  
>1
```

**:CALibration:ALIGnment:PRESet****Function**

This command returns the optical alignment data to the factory defaults.

**Syntax**

```
:CALibration:ALIGnment:PRESet
```

### **:CALibration:AUTOalign:ENABLE**

#### **Function**

This command sets and queries whether performing optical alignment using the optional reference light source.

#### **Syntax**

`:CALibration:AUTOalign:ENABLE 0|1|OFF|ON`

`:CALibration:AUTOalign:ENABLE?`

0|OFF: Disables performing the optical alignment.

1|ON: Enables performing the optical alignment.

#### **Response Data**

0|1

#### **Example of Use**

`:CALibration:AUTOalign:ENABLE 1`

`:CALibration:AUTOalign:ENABLE?`

>1

### **:CALibration:PRESet**

#### **Function**

This command returns the optical alignment data and wavelength calibration data to the factory defaults.

#### **Syntax**

`:CALibration:PRESet`

### **:CALibration:RESCal**

#### **Function**

This command sets the actual resolution value to the initial value or correction value.

This command queries the actual resolution calibration status.

When processing is completed, bit 4 of the end event status register (ESR2) is set to 1.

#### **Syntax**

`:CALibration:RESCal 0|1`

`:CALibration:RESCal?`

0: Uses default resolution calibration value

1: Executes resolution calibration and calculates resolution calibration value

**Response Data**

0|1|2|3

- 0: Uses default resolution calibration value
- 1: Resolution calibration finished normally
- 2: Calibrating resolution
- 3: Resolution calibration finished abnormally

**Example of Use**

```
:CALibration:RESCal 1
:CALibration:RESCal?
>2
```

**:CALibration:WAVelength:EXTernal[:IMMEDIATE]****Function**

This command performs wavelength calibration when using an external light source and creates the wavelength calibration data.

This command queries the wavelength calibration execution result.

When wavelength calibration is completed, 1 is written to bit 4 (execution completion bit) of the end event status register.

**Syntax**

```
:CALibration:WAVelength:EXTernal[:IMMEDIATE]
:CALibration:WAVelength:EXTernal[:IMMEDIATE]?
```

**Response Data**

0|1|2|3

- 0: Ends wavelength calibration
- 1: Wavelength calibration in progress
- 2: Terminates wavelength calibration due to lack of optical level
- 3: Terminates wavelength calibration due to other abnormal phenomena

**Example of Use**

```
:CALibration:WAVelength:EXTernal:IMMEDIATE
:CALibration:WAVelength:EXTernal:IMMEDIATE?
>2
```

**:CALibration:WAVelength[:EXTernal][:NORMal]**

**Function**

This command performs wavelength calibration when using an external light source and creates the wavelength calibration data.  
This command queries the wavelength calibration execution result.  
When wavelength calibration is completed, 1 is written to bit 4 (execution completion bit) of the end event status register.

**Syntax**

```
:CALibration:WAVelength[:EXTernal] [:NORMal]  
:CALibration:WAVelength[:EXTernal] [:NORMal]?
```

**Response Data**

0|1|2|3

- 0: Ends wavelength calibration
- 1: Wavelength calibration in progress
- 2: Terminates wavelength calibration due to lack of optical level
- 3: Terminates wavelength calibration due to other abnormal phenomena

**Example of Use**

```
:CALibration:WAVelength:EXTernal:NORMal  
:CALibration:WAVelength:EXTernal:NORMal?  
>3
```



**:CALibration:WAVelength:INTernal[:IMMediate]****Function**

This command performs wavelength calibration when using a reference light source option and creates the wavelength calibration data.

This command queries the wavelength calibration execution result.

When wavelength calibration is completed, 1 is written to bit 4 (execution completion bit) of the end event status register.

**Syntax**

```
:CALibration:WAVelength:INTernal[:IMMediate]  
:CALibration:WAVelength:INTernal[:IMMediate]?
```

**Response Data**

```
0|1|2|3
```

- 0: Ends wavelength calibration
- 1: Wavelength calibration in progress
- 2: Terminates wavelength calibration due to lack of optical level
- 3: Terminates wavelength calibration due to other abnormal phenomena

**Example of Use**

```
:CALibration:WAVelength:INTernal:IMMediate  
:CALibration:WAVelength:INTernal:IMMediate?  
>1
```

### **:CALibration:WAVelength:INTernal[:NORMal]**

#### **Function**

This command performs wavelength calibration when using a reference light source option and creates the wavelength calibration data.

This command queries the wavelength calibration execution result.

When wavelength calibration is completed, 1 is written to bit 4 (execution completion bit) of the end event status register.

#### **Syntax**

```
:CALibration:WAVelength:INTernal[:NORMal]
```

```
:CALibration:WAVelength:INTernal[:NORMal]?
```

#### **Response Data**

```
0|1|2|3
```

- 0: Ends wavelength calibration
- 1: Wavelength calibration in progress
- 2: Terminates wavelength calibration due to lack of optical level
- 3: Terminates wavelength calibration due to other abnormal phenomena

#### **Example of Use**

```
:CALibration:WAVelength:INTernal:NORMal
```

```
:CALibration:WAVelength:INTernal:NORMal?
```

```
>1
```

**:CALibration:ZCAL****Function**

This command executes the calibration function (Zero Calibration). When zero level calibration is completed, bit 4 of end event status register (execution completion bit) is written to 1.

This command queries the actual Zero Calibration status.

**Syntax**

```
:CALibration:ZCAL 1|2  
:CALibration:ZCAL?
```

- 1: Starts Zero Calibration
- 2: Stops performing Zero Calibration

**Response Data**

```
0|1|2
```

- 0: Normal ends Zero Calibration
- 1: Performing Zero Calibration
- 2: Abnormal ends Zero Calibration

**Example of Use**

```
:CALibration:ZCAL 1  
:CALibration:ZCAL?  
>0
```

**Note:**

The message to set Auto Cal, explained in 3.1.2, “Calibrating Wavelength” in the *MS9740B Optical Spectrum Analyzer Operation Manual*, is not available.

In cases where the measurement is performed via remote control, even when Auto Cal is set to On, the Zero Calibration cannot be performed automatically. On the other hand, if :CALibration:ZCAL is sent, Zero Calibration can be performed at the given timing.

### **:CALibration:ZERO[:AUTO]**

#### **Function**

This command sets and queries the On/Off state of the Auto Offset adjustment.

#### **Syntax**

`:CALibration:ZERO[:AUTO] 0|1|OFF|ON`

`:CALibration:ZERO[:AUTO]?`

0|OFF: Disables the Auto Offset adjustment.

1|ON: Enables the Auto Offset adjustment.

#### **Response Data**

0|1

#### **Example of Use**

`:CALibration:ZERO:AUTO ON`

`:CALibration:ZERO:AUTO?`

`>1`

### 3.4.5 DISPlay Subsystem

The commands in DISPlay subsystem have the following command hierarchy.

```

:WINDow:SYSTem
[:WINDow]
  :TRACe
    :X
      [:SCALe]
        :CENTer
        :SPAN
        :STARt
        :STOP
    :Y1
      [:SCALe]
        :BLEVel
        :UNIT
[:WINDow[1]]
  :TEXT
    :CLEar
    :DATA
  :TRACe
    :ALL[:SCALe][:AUTO]
    [:STATe]
    :Y
      :SCALe:LINear
  :Y[1|2]
    [:SCALe]
      :PDIVision
      :RLEVel
      :SPACing

```

## **:DISPlay:WINDow:SYSTem**

### **Function**

This command switches the Config screen and the Spectrum Measurement screen. It can be switched using a system management command or a measurement command.

This command queries the types of commands that can be used and the screen display.

For the system management and measurement commands, refer to 3.3.2, “System Management and Measurement Commands”.

### **Syntax**

```
:DISPlay:WINDow:SYSTem CONFIG|OSA[,ACT|INACT|MIN]  
:DISPlay:WINDow:SYSTem? CONFIG|OSA
```

**CONFIG:** Activates Config screen display and system management command

**OSA:** Activates measurement screen display and measurement command

**ACT:** Displays front-most screen and permits operation (active status)  
When the Config screen is set to Active, the system management command is available. When the measurement screen is set to Active, the measurement command is available.

**INACT:** Makes screen operations inactive

**MIN:** Minimizes screen display size

ACT is assumed if the setting is omitted.

### **Response Data**

```
CRRENT|IDLE|RUN|UNLOAD,ACT|INACT|MIN|NON
```

<b>CURRENT:</b>	Executes and makes operation target
<b>IDLE:</b>	Loads but does not execute
<b>RUN:</b>	Executes, but does not make operation target
<b>UNLOAD:</b>	Does not load

<b>ACT</b>	Displays active screen
<b>INACT</b>	Displays not active screen
<b>RUN:</b>	Displays minimized screen
<b>NON:</b>	No display

### **Example of Use**

```
:DISPlay:WINDow:SYSTem OSA,MIN  
:DISPlay:WINDow:SYSTem? OSA  
>CURR,MIN  
:DISPlay:WINDow:SYSTem CONFIG,ACT  
:DISPlay:WINDow:SYSTem OSA,ACT
```

```
:DISPlay:WINDow:SYSTem? CONFIG
>IDLE, NON
```

### **:DISPlay[:WINDow[1]]:TEXT:CLEAr**

#### **Function**

This command deletes all characters displayed in the title.

#### **Syntax**

```
:DISPlay[:WINDow[1]]:TEXT:CLEAr
```

### **:DISPlay[:WINDow[1]]:TEXT:DATA**

#### **Function**

This command sets and queries the title.

#### **Syntax**

```
:DISPlay[:WINDow[1]]:TEXT:DATA <string>
:DISPlay[:WINDow[1]]:TEXT:DATA?
```

#### **Response Data**

```
<string>
```

<string>: Title string of 32 or less characters

#### **Example of Use**

```
:DISPlay:WINDow1:TEXT:DATA "SFP-10G LX4 No.1"
:DISPlay:WINDow1:TEXT:DATA?
>SFP-10G LX4 No.1
```

### **:DISPlay[:WINDow[1]]:TRACe:ALL[:SCALe][:AUTO]**

#### **Function**

This command performs the measurement automatically.

Bit 0 of the end event status register is set to 1 when measurement ends.

This command queries the automatic measurement status.

#### **Syntax**

```
:DISPlay[:WINDow[1]]:TRACe:ALL[:SCALe][:AUTO]
```

```
:DISPlay[:WINDow[1]]:TRACe:ALL[:SCALe][:AUTO]?
```

#### **Response Data**

0|1

0: Measurement end (Both successful end and failed end)

1: Measurement in progress

#### **Example of Use**

```
:DISPlay:WINDow1:TRACe:ALL
```

```
:DISPlay:WINDow1:TRACe:ALL?
```

```
>1
```

```
:DISPlay:WINDow1:TRACe:ALL?
```

```
>0
```

### **:DISPlay[:WINDow[1]]:TRACe[:STATe]**

#### **Function**

This command sets and queries the trace display.

#### **Syntax**

```
:DISPlay[:WINDow[1]]:TRACe[:STATe] <switch>,0|1|OFF|ON
```

```
:DISPlay[:WINDow[1]]:TRACe[:STATe]? <switch>
```

<switch>: Specify a trace from the following.

A|B|C|D|E|F|G|H|I|J|TRA|TRB|TRC|TRD|TRE|TRF

0|OFF: Deletes the specified trace waveform.

1|ON: Displays the specified trace waveform.

#### **Response Data**

0|1

#### **Example of Use**

```
:DISPlay:WINDow:TRACe:STATe I,ON
```

```
:DISPlay:WINDow:TRACe:STATe? I
```



---

>1

**:DISPlay[:WINDow]:TRACe:X[:SCALe]:CENTer****Function**

This command sets and queries the center wavelength.

**Syntax**

```
:DISPlay[:WINDow]:TRACe:X[:SCALe]:CENTer  
<numeric_data>[<unit_m>]  
:DISPlay[:WINDow]:TRACe:X[:SCALe]:CENTer?
```

Range            600.00 to 1750.00 nm

Resolution      0.01 nm

If a suffix is omitted, the unit will be m.

**Response Data**

<numeric\_data>

<numeric>:      Center wavelength (m)  
                 +6.00000000E-007 to +1.75000000E-006

**Example of Use**

```
:DISPlay:WINDow:TRACe:X:SCALe:CENTer 850NM  
:DISPlay:WINDow:TRACe:X:SCALe:CENTer?  
>+8.50000000E-007
```

## **:DISPlay[:WINDow]:TRACe:X[:SCALe]:SPAN**

### **Function**

This command sets and queries the sweep width

### **Syntax**

```
:DISPlay[:WINDow]:TRACe:X[:SCALe]:SPAN  
<numeric>[<unit_m>]  
:DISPlay[:WINDow]:TRACe:X[:SCALe]:SPAN?
```

Range            0|0.2 to 1200.0 nm

Resolution      0.1 nm

If a suffix is omitted, the unit will be m.

### **Response Data**

<numeric>

<numeric>:      Sweep width (m)

                 0|+2.00000000E-010 to +1.20000000E-006

### **Example of Use**

```
:DISPlay:WINDow:TRACe:X:SCALe:SPAN 1E-7  
:DISPlay:WINDow:TRACe:X:SCALe:SPAN?  
>+1.00000000E-007
```

**:DISPlay[:WINDow]:TRACe:X[:SCALe]:START****Function**

This command sets and queries the start wavelength.

**Syntax**

```
:DISPlay[:WINDow]:TRACe:X[:SCALe]:START  
<numeric>[<unit_m>]  
:DISPlay[:WINDow]:TRACe:X[:SCALe]:START?
```

Range            600.0 to 1750.0 nm (Start wavelength)

Resolution      0.1 nm

If a suffix is omitted, the unit will be m.

**Response Data**

<numeric>

<numeric>:      Start wavelength (m)  
                 +6.00000000E-007 to +1.75000000E-006

Specify smaller value than Stop wavelength.

**Example of Use**

```
:DISPlay:WINDow:TRACe:X:SCALe:START 1500NM  
:DISPlay:WINDow:TRACe:X:SCALe:START?  
>+1.50000000E-006
```

### **:DISPlay[:WINDow]:TRACe:X[:SCALe]:STOP**

#### **Function**

This command sets and queries the stop wavelength.

#### **Syntax**

```
:DISPlay[:WINDow]:TRACe:X[:SCALe]:STOP  
<numeric>[<unit_m>]  
:DISPlay[:WINDow]:TRACe:X[:SCALe]:STOP?
```

Range            600.0 to 1800.0 nm (Stop wavelength)

Resolution      0.1 nm

If a suffix is omitted, the unit will be m.

#### **Response Data**

<numeric>

<numeric>:      Stop wavelength (m)  
                  +6.00000000E-007 to +1.80000000E-006

Specify larger value than Start wavelength.

#### **Example of Use**

```
:DISPlay:WINDow:TRACe:X:SCALe:STOP 1600NM  
:DISPlay:WINDow:TRACe:X:SCALe:STOP?  
>+1.60000000E-006
```

### **:DISPlay[:WINDow[1]]:TRACe:Y:SCALe:LINear**

#### **Function**

This command sets the level scale to Log or Linear.

This command queries whether the level scale is set to Log or Linear.

#### **Syntax**

```
:DISPlay[:WINDow[1]]:TRACe:Y:SCALe:LINear 0|1|OFF|ON  
:DISPlay[:WINDow[1]]:TRACe:Y:SCALe:LINear?
```

0|OFF:            Log scale

1|ON:            Linear scale

#### **Response Data**

0|1

#### **Example of Use**

```
:DISPlay:WINDow:TRACe:Y:SCALe:LINear ON  
:DISPlay:WINDow:TRACe:Y:SCALe:LINear?
```

&gt;1

**:DISPlay[:WINDow[1]]:TRACe:Y[1|2][:SCALe]:PDIVision****Function**

This command sets the level scale to Log and scale division (dB/div)

This command queries the Log scale.

**Syntax**

```
:DISPlay[:WINDow[1]]:TRACe:Y[1|2][:SCALe]:PDIVision
```

```
<numeric>[DB]
```

```
:DISPlay[:WINDow[1]]:TRACe:Y[1|2][:SCALe]:PDIVision?
```

The process will not change regardless of whether a number [1|2] is specified or omitted.

Range            0.1 to 10.0 dB (Absolute value display)

                  0.1 to 20.0 dB (Relative value display)

Resolution      0.1 dB

If a suffix is omitted, the unit will be dB.

**Response Data**

```
<numeric>
```

```
<numeric>:      Log scale value (dB)
```

```
                  +1.00000000E-001 to +1.00000000E+001 (Absolute value display)
```

```
                  +1.00000000E-001 to +2.00000000E+001 (Relative value display)
```

**Example of Use**

```
:DISPlay:WINDow:TRACe:Y:SCALe:PDIVision 0.2
```

```
:DISPlay:WINDow:TRACe:Y:SCALe:PDIVision?
```

```
>+2.00000000E-001
```

## **:DISPlay[:WINDow[1]]:TRACe:Y[1|2][:SCALe]:RLEVel**

### **Function**

At the time of setting the Log scale, this command sets and queries the reference level.

### **Syntax**

```
:DISPlay[:WINDow[1]]:TRACe:Y[1|2][:SCALe]:RLEVel  
<numeric>[DB|DBM]  
:DISPlay[:WINDow[1]]:TRACe:Y[1|2][:SCALe]:RLEVel?
```

### **Range**

At absolute value display:	Reference level (dBm) -90.0 to 30.0
At relative value display:	Reference level (dB) -100.0 to 100.0
Resolution	0.1 dB

If a suffix is omitted, the unit will be dB or dBm.

### **Response Data**

<numeric>

<numeric>: Reference Level

At absolute value display:

-9.00000000E+001 to +3.00000000E+001 (dBm)

At relative value display:

-1.00000000E+002 to +1.00000000E+002 (dB)

### **Example of Use**

```
:DISPlay:WINDow:TRACe:Y:SCALe:RLEVel -20  
:DISPlay:WINDow:TRACe:Y:SCALe:RLEVel?  
>-2.00000000E+001
```

**:DISPlay[:WINDow[1]]:TRACe:Y[1|2][:SCALe]:SPACing****Function**

This command sets the level scale to Log or Linear.

This command queries whether the level scale is set to Log or Linear.

**Syntax**

```
:DISPlay[:WINDow[1]]:TRACe:Y[1|2][:SCALe]:SPACing
```

```
0|1|LOG|LIN
```

```
:DISPlay[:WINDow[1]]:TRACe:Y[1|2][:SCALe]:SPACing?
```

```
0|OFF:      Log scale
```

```
1|ON:       Linear scale
```

**Response Data**

```
0|1
```

**Example of Use**

```
:DISPlay:WINDow:TRACe:Y:SCALe:SPACing LIN
```

```
:DISPlay:WINDow:TRACe:Y:SCALe:SPACing?
```

```
>1
```

## **:DISPlay[:WINDow]:TRACe:Y1[:SCALe]:BLEVel**

### **Function**

The command sets the level scale to the linear and sets the Linear Level value.

This command queries the linear Level value.

### **Syntax**

```
:DISPlay[:WINDow]:TRACe:Y1[:SCALe]:BLEVel  
<numeric>[MW|NW|PW|UW|W]  
:DISPlay[:WINDow]:TRACe:Y1[:SCALe]:BLEVel?
```

<numeric>:

- The units for absolute value display are from 1 pW to 1 W as follows:  
MW:mW, UW:  $\mu$ W, NW:nW, PW:pW, W:W  
If the units are omitted, W is assumed.
- When the scale is displayed in relative values (%), the Linear Level value cannot be set.

### **Response Data**

<numeric>

<numeric>: Linear Level value (W)

### **Example of Use**

```
:DISPlay:WINDow:TRACe:Y1:SCALe:BLEVel 50UW  
:DISPlay:WINDow:TRACe:Y1:SCALe:BLEVel?  
>+5.00000000E-005
```



**:DISPlay[:WINDow]:TRACe:Y1[:SCALe]:UNIT****Function**

This command sets the level scale to Log or Linear.

This command queries whether the level scale is set to Log or Linear.

**Syntax**

```
:DISPlay[:WINDow]:TRACe:Y1[:SCALe]:UNIT 0|1|DBM|W
```

```
:DISPlay[:WINDow]:TRACe:Y1[:SCALe]:UNIT?
```

0 DBM:	Log scale
1 W:	Linear scale

**Response Data**

```
0|1
```

**Example of Use**

```
:DISPlay:WINDow:TRACe:Y1:SCALe:UNIT W
```

```
:DISPlay:WINDow:TRACe:Y1:SCALe:UNIT?
```

```
>1
```

### 3.4.6 FORMat Subsystem

The commands in FORMat subsystem have the following command hierarchy.

```
[ :DATA ]
:DELimiter
```

#### :FORMat[:DATA]

##### Function

This command sets and queries the format that is used when transferring data by using the :TRACe[:DATA][:Y]? command.

##### Syntax

```
:FORMat[:DATA] REAL[,64] | ASCii
:FORMat[:DATA]?
```

REAL[,64]: Sets the binary format  
ASCii: Sets the numerical format separated by comma

##### Response Data

```
{REAL,+64} | {ASC,+0}
```

##### Example of Use

```
:FORMat:DATA REAL
:FORMat:DATA?
>REAL,+64
:FORMat:DATA ASCii
:FORMat:DATA?
>ASC,+0
```

## **:FORMat:DELimiter**

### **Function**

This command sets and queries the terminator of response data in the remote control.

This message is a system management command.

### **Syntax**

```
:FORMat:DELimiter 0|1|2  
:FORMat:DELimiter?
```

- 0: Sets remote control terminator to Line Feed (LF)
- 1: Sets remote control terminator to Carriage Return and Line Feed (CR/LF)
- 2: Sets remote control terminator to None and uses only EOI only

### **Response Data**

```
0|1|2
```

### 3.4.7 INITiate Subsystem

The commands in INITiate subsystem have the following command hierarchy.

```
:CONTInuous
[:IMMEDIATE]
:IMMEDIATE[:SEQUENCE[1|2]]
:POWer
    :DATA?
    :OFF
    :WAVElength
:SMODE
    :STATE?
```

#### :INITiate:CONTInuous

##### Function

This command sets the sweep mode to Single or Repeat.

This command queries the sweep mode.

To start the sweep, execute the :INITiate[:IMMEDIATE] command.

##### Syntax

```
:INITiate:CONTInuous 0|1|OFF|ON
:INITiate:CONTInuous?
```

0|OFF:       Single

1|ON:         Repeat

##### Response Data

0|1

#### :INITiate[:IMMEDIATE]

##### Function

This command starts the sweeping in the sweep mode set by the :INITiate:SMODE command.

When :INITiate:CONTInuous is set to 0, a single sweep is performed.

When :INITiate:CONTInuous is set to 1, the sweeping is repeatedly performed.

After a single sweep has completed, the bit 1 (sweep-end bit) of the end event status register (ESR2) is set to 1.

##### Syntax

```
:INITiate[:IMMEDIATE]
```

To check that the sweeping is completed, use the \*OPC? command. When the sweeping has completed, the response to the \*OPC? command is 1.

### **:INITiate:IMMEDIATE:SEQUENCE[1|2]**

#### **Function**

This command starts the Pin or Pout measurement by the Optical AMP (WDM) application.

#### **Syntax**

```
:INITiate:IMMEDIATE:SEQUENCE[1|2]
```

1: Pin

2: Pout

If [1|2] is omitted, Pin is measured.

### **:INITiate:POWER:DATA?**

#### **Function**

This command sets and queries the power monitor wavelength.

#### **Syntax**

```
:INITiate:POWER:DATA?
```

#### **Response Data**

```
<numeric>
```

<numeric>: Measurement results of the power monitor (dBm)

When sending :INITiate:POWER:DATA? without setting to power monitor, \*\*\* is queried as response data.

#### **Example of Use**

```
:INITiate:POWER:DATA?  
>-4.88000000E+000
```

### **:INITiate:POWER:OFF**

#### **Function**

This command exits the power monitor measurement.

#### **Syntax**

```
:INITiate:POWER:OFF
```

### **:INITiate:POWer:WAVelength**

#### **Function**

This command sets and queries the power monitor wavelength. When processing is completed, bit 3 of the end event status register is set to 1.

#### **Syntax**

```
:INITiate:POWer:WAVelength 632.8|850|1300|1550  
:INITiate:POWer:WAVelength?
```

632.8:	632.8 nm
850:	850 nm
1310:	1310 nm
1550:	1550 nm

#### **Response Data**

```
632.8|850|1300|1550
```

Other functions cannot be executed while the power monitor measurement is in progress.

To execute the other function, use the :INITiate:POWer:OFF command to terminate the power monitor measurement.

### **:INITiate:SMODE**

#### **Function**

This command sets and queries the sweep mode.

#### **Syntax**

```
:INITiate:SMODE <switch>  
:INITiate:SMODE?
```

<switch>:	Sweep mode
1 SINGLE:	Single sweeping
2 REPeat:	Repeat sweeping
3 AUTO:	Auto Measure

#### **Response Data**

```
1|2|3
```

To start sweeping, send :INITiate[:IMMediate] after this message.

### **:INITiate:SMODE:STATe?**

#### **Function**

This command queries the measurement state.

#### **Syntax**

:INITiate:SMODE:STATe?

#### **Response Data**

0|1|2|3

- 0: Spectrum measurement end
- 1: Spectrum measurement in progress (Single sweeping)
- 2: Spectrum measurement in progress (Repeat sweeping)
- 3: Power monitor

### 3.4.8 INSTRUMENT Subsystem

#### :INSTRUMENT:SELEct

##### Function

This command sets the type of application function and performs analysis.

When the processing is completed, bit 0 (measurement end bit) of the end event status register is set to 1.

This command terminates the display of the application function.

This command queries the application function that is running.

##### Syntax

```
:INSTRUMENT:SELEct <switch>  
:INSTRUMENT:SELEct?
```

<switch>: Specify an application from the following.

<switch>	Application Type
'AMP'	Optical amplifier
'AMP2'	Optical amplifier (WDM)
'Amp_ISS_Test'	Optical amplifier (WDM)
'DFB'	Distributed feedback laser diode
'FP'	Fabry-Perot laser diode
'LD'	Laser diode module
'LED'	Light-emitting diode
'OFF'	End of application function
'OSA'	End of application function
'PMD'	Polarization mode dispersion
'WDM'	Wavelength division multiplexing
'WDM_AutoScan'	Wavelength division multiplexing
'WFIL'	WDM filter

##### Example of Use

```
:INSTRUMENT:SELEct 'WDM_Autoscan'  
:INSTRUMENT:SELEct?  
>WDM_AutoScan
```



### 3.4.9 MMEMemory Subsystem

The commands in MMEMemory subsystem have the following command hierarchy.

```
:CATalog?  
:COPY  
  :CSV  
  :GRAPhics  
  :SYSinfo  
  :XML  
:DATA  
:DELete  
  :SYSinfo  
:LOAD  
  :ATRace  
  :SETTing  
  :TRACe  
:MOVE  
  :CSV  
  :GRAPhics  
  :SYSinfo  
  :XML  
:PROTect  
  :CSV  
  :GRAPhics  
  :SYSinfo  
  :XML  
:STORe  
  :ATRace  
  :COLor  
  :GRAPhics  
    :BINary?  
    :TYPE  
  :SETTing  
  :TRACe
```

## :MMEMory:CATalog?

### Function

This command queries the file list saved in the specified device.

This command can query up to 1000 files sorted in alphabetic order.

If the specified device or file cannot be found and an error is generated, the standard event status execution error bit becomes 1.

This message is a system management command.

Files in the following folder of the specified device are output as a list.

```
x:\Anritsu Corporation\Optical Spectrum Analyzer\User Data\All Trace Data
x:\Anritsu Corporation\Optical Spectrum Analyzer\User Data\Screenshot
x:\Anritsu Corporation\Optical Spectrum Analyzer\User Data\CSV Data
x:\Anritsu Corporation\Optical Spectrum Analyzer\User Data\System Information
```

### Syntax

```
:MMEMory:CATalog?
[<switch>|<user_drive>] [,<directory_name>]
```

<switch>: Specify a device from the following.

INTernal: Internal storage media (Drive D)

EXTernal|FLOppy:

USB storage media

When there are two or more USB storage media, the drive having the first drive letter (alphabetically) is specified automatically.

If <switch> or <user\_drive> is omitted, it defaults to INTernal.

The process will not change even though <directry\_name> is specified.

### Response Data

```
<numeric>[,<file_name>,<file_name>,<file_name>,...]
```

No.	Parameter type	Description
1	<numeric>	Number of files:0 to 1000
2	<file_name>	File name without extension
:		
	<file_name>	File name without extension (No. of files)

### Example of Use

```
:MMEMory:CATalog? D
>5, Sys_000, Sys_001, Sys_002, Sys_003, Sys_004
:MMEMory:CATalog? EXT
>0
```

**:MMEMory:COPY:CSV****Function**

This command copies the trace CSV file from drives E to Z to drive D. If the specified device or file cannot be found and an error is generated, the standard event status execution error bit becomes 1.

The copy source CSV file should be moved to the following folder of the specified drive.

x:\Anritsu Corporation\Optical Spectrum Analyzer\User Data\CSV Data

This message is a system management command.

**Syntax**

```
:MMEMory:COPY:CSV <file_name>,<user_drive>
```

It is not necessary to add the extension to file\_name.

**Example of Use**

```
:MMEMory:COPY:CSV 'file001',E
```

**:MMEMory:COPY:GRAPHics****Function**

This command copies the image file from drives E to Z to drive D.

If the specified device or file cannot be found and an error is generated, the standard event status execution error bit becomes 1.

The copy source image file should be moved to the following folder of the specified drive.

x:\Anritsu Corporation\Optical Spectrum Analyzer\User Data\Screenshot

This message is a system management command.

**Syntax**

```
:MMEMory:COPY:GRAPHics <file_name>,<user_drive>
```

It is not necessary to add the extension to file\_name.

**Example of Use**

```
:MMEMory:COPY:GRAPHics 'file001',E
```

### **:MMEMory:COPY:SYSinfo**

#### **Function**

This command copies the system information file from drives E to Z to drive D.

If the specified device or file cannot be found and an error is generated, the standard event status execution error bit becomes 1.

The copy source system information file should be moved to the following folder of the specified drive.

x:\Anritsu Corporation\Optical Spectrum Analyzer\User Data\System Information

This message is a system management command.

#### **Syntax**

```
:MMEMory:COPY:SYSinfo <file_name>,<user_drive>
```

It is not necessary to add the extension to file\_name.

#### **Example of Use**

```
:MMEMory:COPY:SYSinfo 'SystemInfo_20140101_010203',E
```

### **:MMEMory:COPY:XML**

#### **Function**

This command copies the trace XML file from drives E to Z to drive D.

If the specified device or file cannot be found and an error is generated, the standard event status execution error bit becomes 1.

The copy source XML file should be moved to the following folder of the specified drive.

x:\Anritsu Corporation\Optical Spectrum Analyzer\User Data\All Trace Data

This message is a system management command.

#### **Syntax**

```
:MMEMory:COPY:XML <file_name>,<user_drive>
```

It is not necessary to add the extension to file\_name.

#### **Example of Use**

```
:MMEMory:COPY:XML 'file001',E
```

**:MMEMory:DATA****Function**

This command reads the parameters and data for 10 traces from the XML file saved in the specified device.

If the specified device or file cannot be found and an error is generated, the standard event status execution error bit becomes 1.

**Syntax**

```
:MMEMory:DATA <file_name>[,<switch>]
```

It is not necessary to add the extension to file\_name.

<switch>: Specify a device from the following.

INTernal: Internal storage media (DriveD)

EXTernal: USB storage media

When there are two or more USB storage media, the drive having the first drive letter (alphabetically) is specified automatically.

If <switch> is omitted, it defaults to INTernal.

**Example of Use**

```
:MMEMory:DATA 'file1',INT
```

## **:MMEMory:DELeTe**

### **Function**

This command deletes files saved in the specified device.  
If the specified device or file cannot be found and an error is generated, the standard event status execution error bit becomes 1.  
This message is a system management command.

### **Syntax**

```
:MMEMory:DELeTe <file_name>[, {<switch>|<user_drive>}]
```

It is necessary to add the extension to file\_name.

<switch>: Specify a device from the following.

INTernal: Internal storage media (DriveD)

EXTernal|FLOppy:

USB storage media

When there are two or more USB storage media, the drive having the first drive letter (alphabetically) is specified automatically.

If <switch> is omitted, it defaults to INTernal.

### **Example of Use**

```
:MMEMory:DELeTe 'Sample_01.csv',INTernal  
:MMEMory:DELeTe 'Image00.png',EXTernal  
:MMEMory:DELeTe 'LED_125M(025).xml',E
```

## **:MMEMory:DELeTe:SYSInfo**

### **Function**

This command deletes the system information file saved in the specified device.

If the specified device or file cannot be found and an error is generated, the standard event status execution error bit becomes 1.

This message is a system management command.

### **Syntax**

```
:MMEMory:DELeTe:SYSInfo <file_name>,<user_drive>
```

It is not necessary to add the extension to file\_name.

### **Example of Use**

```
:MMEMory:DELeTe:SYSInfo 'SystemInfo_20140101_010203',E
```

**:MMEMory:LOAD:ATRace****Function**

This command reads the parameters and data for 10 traces from the XML file saved in the specified device.

If the specified device or file cannot be found and an error is generated, the standard event status execution error bit becomes 1.

The XML files in the following folder of the specified device can be read.

x:\Anritsu Corporation\Optical Spectrum Analyzer\User Data\All Trace Data

**Syntax**

```
:MMEMory:LOAD:ATRace <file_name>[,<switch>]
```

It is not necessary to add the extension to file\_name.

<switch>: Specify a device from the following.

INTernal: Internal storage media (DriveD)

EXTernal: USB storage media

When there are two or more USB storage media, the drive having the first drive letter (alphabetically) is specified automatically.

If <switch> is omitted, it defaults to INTernal.

**Example of Use**

```
:MMEMory:LOAD:ATRace 'LED_125M(025)',EXTernal
```

### **:MMEMory:LOAD:SETTing**

#### **Function**

This command reads the parameters and data for 10 traces from the XML file saved in the specified device.

If the specified device or file cannot be found and an error is generated, the standard event status execution error bit becomes 1.

The XML files in the following folder of the specified device can be read.  
x:\Anritsu Corporation\Optical Spectrum Analyzer\User Data\All Trace Data

#### **Syntax**

```
:MMEMory:LOAD:SETTing <file_name>[,<switch>]
```

It is not necessary to add the extension to file\_name.

<switch>: Specify a device from the following.

INTernal: Internal storage media (DriveD)

EXTernal: USB storage media

When there are two or more USB storage media, the drive having the first drive letter (alphabetically) is specified automatically.

If <switch> is omitted, it defaults to INTernal.

#### **Example of Use**

```
:MMEMory:LOAD:SETTing 'LED_125M(025)',EXTernal
```

### **:MMEMory:LOAD:TRACe**

#### **Function**

This command reads the parameters and data for 10 traces from the XML file saved in the specified device.

If the specified device or file cannot be found and an error is generated, the standard event status execution error bit becomes 1.

The XML files in the following folder of the specified device can be read.  
x:\Anritsu Corporation\Optical Spectrum Analyzer\User Data\All Trace Data

#### **Syntax**

```
:MMEMory:LOAD:TRACe <trace_name>,<file_name>[,<switch>]
```

The process will not change regardless of which trace is set to <trace\_name>.

It is not necessary to add the extension to file\_name.

<switch>: Specify a device from the following.

INTernal: Internal storage media (DriveD)



EXTernal|FLOppy:

USB storage media

When there are two or more USB storage media, the drive having the first drive letter (alphabetically) is specified automatically.

If <switch> is omitted, it defaults to INTernal.

#### Example of Use

```
:MMEMory:LOAD:TRACe a, 'LED_125M(025)', EXTernal
```

### :MMEMory:MOVE:CSV

#### Function

This command moves the trace CSV file from drive D to drives E to Z . If the specified device or file cannot be found and an error is generated, the standard event status execution error bit becomes 1.

The copy source CSV file should be moved to the following folder of the specified drive.

```
x:\Anritsu Corporation\Optical Spectrum Analyzer\User Data\CSV Data
```

This message is a system management command.

#### Syntax

```
:MMEMory:MOVE:CSV <file_name>,<user_drive>
```

It is not necessary to add the extension to file\_name.

#### Example of Use

```
:MMEMory:MOVE:CSV 'PMD_Coupler-03', F
```

### **:MMEMory:MOVE:GRAPhics**

#### **Function**

This command moves the image file from drive D to drives E to Z .  
The extension (bmp or png) of the moved file is specified at Copy Settings.  
If the specified device or file cannot be found and an error is generated,  
the standard event status execution error bit becomes 1.

The copy source image file should be moved to the following folder of the  
specified drive.

x:\Anritsu Corporation\Optical Spectrum Analyzer\User Data\Screenshot

This message is a system management command.

#### **Syntax**

```
:MMEMory:MOVE:GRAPhics <file_name>,<user_drive>
```

It is not necessary to add the extension to file\_name.

#### **Example of Use**

```
:MMEMory:MOVE:GRAPhics 'LED_125M(025)',F
```

### **:MMEMory:MOVE:SYSinfo**

#### **Function**

This command moves the system information file from drive D to drives E  
to Z.

If the specified device or file cannot be found and an error is generated,  
the standard event status execution error bit becomes 1.

The system information file should be moved to the following folder of the  
specified drive.

x:\Anritsu Corporation\Optical Spectrum Analyzer\User Data\System Information

This message is a system management command.

#### **Syntax**

```
:MMEMory:MOVE:SYSinfo <file_name>,<user_drive>
```

It is not necessary to add the extension to file\_name.

#### **Example of Use**

```
:MMEMory:MOVE:SYSinfo 'SystemInfo-20131205_001',F
```

**:MMEMory:MOVE:XML****Function**

This command moves the trace XML file from drive D to drives E to Z. If the specified device or file cannot be found and an error is generated, the standard event status execution error bit becomes 1.

The XML file should be moved to the following folder of the specified drive.

x:\Anritsu Corporation\Optical Spectrum Analyzer\User Data\All Trace Data

This message is a system management command.

**Syntax**

```
:MMEMory:MOVE:XML <file_name>,<user_drive>
```

It is not necessary to add the extension to file\_name.

**Example of Use**

```
:MMEMory:MOVE:XML 'Trace-OPT_AMP',F
```

## **:MMEMory:PROTECT:CSV**

### **Function**

This command prohibits deletion of CSV files saved in the specified device.

If the specified device or file cannot be found and an error is generated, the standard event status execution error bit becomes 1.

CSV files in the following folder of the specified device can be set to write protect.

x:\Anritsu Corporation\Optical Spectrum Analyzer\User Data\CSV Data

This message is a system management command.

### **Syntax**

```
:MMEMory:PROTECT:CSV
```

```
<file_name>,0|1|OFF|ON,D|<user_drive>
```

```
:MMEMory:PROTECT:CSV? <file_name>,D|<user_drive>
```

It is not necessary to add the extension to file\_name.

0|OFF:       Permits deletion

1|ON:        Prohibits deletion

### **Response Data**

0|1

### **Example of Use**

```
:MMEMory:PROTECT:CSV 'PMD_Coupler-03',OFF,E
```

```
:MMEMory:PROTECT:CSV? 'PMD_Coupler-03',E
```

```
>0
```

**:MMEMory:PROTECT:GRAPHics****Function**

This command prohibits deletion of screen image files saved in the specified device.

The extension (bmp or png) of the target image file is the extension specified at Copy Settings.

When an error occurs because the specified device or file is not found, the execution error bit of the standard event status register is set to 1.

The screen image files in the following folder of the specified device can be set to "write protect".

x:\Anritsu Corporation\Optical Spectrum Analyzer\User Data\Screenshot

This message is a system management command.

**Syntax**

```
:MMEMory:PROTECT:GRAPHics  
<file_name>,0|1|OFF|ON,D|<user_drive>  
:MMEMory:PROTECT:GRAPHics? <file_name>,D|<user_drive>
```

It is not necessary to add the extension to file\_name.

0 OFF:	Permits deletion
1 ON:	Prohibits deletion

**Response Data**

0|1

**Example of Use**

```
:MMEMory:PROTECT:GRAPHics 'LED_125M(025)',ON,E  
:MMEMory:PROTECT:GRAPHics? 'LED_125M(025)',E  
>1
```

### **:MMEMory:PROTECT:SYSInfo**

#### **Function**

This command prohibits deletion of system information files saved at the specified device.

If the specified device or file cannot be found and an error is generated, the standard event status execution error bit becomes 1.

The system information files in the following folder of the specified device can be set to write protect.

x:\Anritsu Corporation\Optical Spectrum Analyzer\User Data\System Information

This message is a system management command.

#### **Syntax**

```
:MMEMory:PROTECT:SYSInfo  
<file_name>,0|1|OFF|ON,D|<user_drive>  
:MMEMory:PROTECT:SYSInfo? <file_name>,D|<user_drive>
```

It is not necessary to add the extension to file\_name.

0 OFF:	Permits deletion
1 ON:	Prohibits deletion

#### **Response Data**

0|1

#### **Example of Use**

```
:MMEMory:PROTECT:SYSInfo 'SystemInfo-20131205_001',ON,E  
:MMEMory:PROTECT:SYSInfo? 'SystemInfo-20131205_001',E  
>1
```

### **:MMEMory:PROTECT:XML**

#### **Function**

This command prohibits deletion of XML files saved in the specified device.

If the specified device or file cannot be found and an error is generated, the standard event status execution error bit becomes 1.

XML files in the following folder of the specified device can be set to "write protect".

x:\Anritsu Corporation\Optical Spectrum Analyzer\User Data\All Trace Data

This message is a system management command.

#### **Syntax**

```
:MMEMory:PROTECT:XML  
<file_name>,0|1|OFF|ON,D|<user_drive>
```

```
:MMEMory:PROTECT:XML? <file_name>,D|<user_drive>
```

It is not necessary to add the extension to file\_name.

```
0|OFF:      Permits deletion
1|ON:       Prohibits deletion
```

#### Response Data

```
0|1
```

#### Example of Use

```
:MMEMory:PROTECT:XML 'Trace-OPT_AMP',OFF,E
:MMEMory:PROTECT:XML? 'Trace-OPT_AMP',E
>0
```

### :MMEMory:STORE:ATRACE

#### Function

This command saves all trace CSV and XML files to the specified device. Files are saved to the following directory in the specified drive.

```
x:\Anritsu Corporation\Optical Spectrum Analyzer\User Data\CSV Data
x:\Anritsu Corporation\Optical Spectrum Analyzer\User Data\All Trace Data
```

When an error is caused because a specified device is not found, 1 is written to the execution error bit of the standard event status register.

#### Syntax

```
:MMEMory:STORE:ATRACE <file_name>[,<switch>]
```

It is not necessary to add the extension to file\_name.

<switch>: Specify a device from the following.

INTernal: Internal storage media (Drive D)

EXTernal: USB storage media

When there are two or more USB storage media, the drive having the first drive letter (alphabetically) is specified automatically.

If <switch> is omitted, it defaults to INTernal.

#### Example of Use

```
:MMEMory:STORE:ATRACE 'WDM_Filter_20131201-1'
```

## **:MMEMory:STORe:COLor**

### **Function**

This command sets and queries the color of the image file to be saved by pressing **Copy**.

This message is a system management command.

### **Syntax**

`:MMEMory:STORe:COLor NORMal|REVerse`

`:MMEMory:STORe:COLor?`

**NORMal:** Creates image file using same colors as screen display.

**REVerse:** Creates image file using reverse screen colors.

### **Response Data**

NORM|REV



**:MMEMory:STORe:GRAPhics****Function**

This command saves the screen image files.

When saving a file, you can specify a file name, file format, destination drive, and whether to change graphic colors.

Files are saved to the following directory in the specified drive.

x:\Anritsu Corporation\Optical Spectrum Analyzer\User Data\Screenshot

Up to 1000 files can be saved in the folder.

**Syntax**

:MMEMory:STORe:GRAPhics

B&W|COLor, BMP|PNG, <file\_name>[, <switch>]

B&W: Creates image file using reverse screen colors.

COLor: Creates image file using same colors as screen display.

BMP: bmp format

PNG: png format

It is not necessary to add the extension to file\_name.

<switch>: Specify a device from the following.

INTernal: Internal storage media (Drive D)

EXTernal: USB storage media

When there are two or more USB storage media, the drive having the first drive letter (alphabetically) is specified automatically.

If <switch> is omitted, it defaults to INTernal.

**Example of Use**

:MMEMory:STORe:GRAPhics COL, PNG, 'Image\_LED\_0001'

### **:MMEMory:STORe:GRAPhics:BINary?**

#### **Function**

This command reads the image file in binary format.

The command target is a file in the following folder.

x:\Anritsu Corporation\Optical Spectrum Analyzer\User Data\Screenshot

The size of the binary data is about 1.4 MB for bmp files and 46 KB for png files.

#### **Syntax**

:MMEMory:STORe:GRAPhics:BINary?

<file\_name>,D|<user\_drive>

File name includes a file extension bmp or png.

#### **Response Data**

<binary\_data>

#### **Example of Use**

:MMEMory:STORe:GRAPhics:BINary? 'Sample-23.bmp',D

>#541056Avdl-\*;E4"as...

The binary data is the character after the number sign (#) indicating the number of digits in the data.

The binary data follows the number indicating the data length.

Example: #42002an%\*qe4445+\...

4 digits                      2002 bytes of binary data

**:MMEMory:STORe:GRAPhics:TYPE****Function**

This command sets and queries the file extension for the image data saved by pressing **Copy**.

**Syntax**

```
:MMEMory:STORe:GRAPhics:TYPE [BMP|PNG]
```

```
:MMEMory:STORe:GRAPhics:TYPE?
```

BMP: bmp format

PNG: png format

When omitted: bmp format

**Response Data**

BMP | PNG

**:MMEMory:STORe:SETTing****Function**

This command saves the trace XML file in the specified device.

Files are saved to the following directory in the specified drive.

```
x:\Anritsu Corporation\Optical Spectrum Analyzer\User Data\All Trace Data
```

When an error is caused because a specified device is not found, 1 is

written to the execution error bit of the standard event status register.

**Syntax**

```
:MMEMory:STORe:SETTing <file_name>[,<switch>]
```

It is not necessary to add the extension to file\_name.

<switch>: Specify a device from the following.

INTernal: Internal storage media (Drive D)

EXTernal: USB storage media

When there are two or more USB storage media, the drive having the first drive letter (alphabetically) is specified automatically.

If <switch> is omitted, it defaults to INTernal.

**Example of Use**

```
:MMEMory:STORe:SETTing 'LD_module_1545nm'
```

## **:MMEMory:STORe:TRACe**

### **Function**

This command saves a trace as CSV, XML and image files to the specified device.

Files are saved to the following directory in the specified drive.

x:\Anritsu Corporation\Optical Spectrum Analyzer\User Data\CSV Data

x:\Anritsu Corporation\Optical Spectrum Analyzer\User Data\Screenshot

x:\Anritsu Corporation\Optical Spectrum Analyzer\User Data\All Trace Data

When an error is caused because a specified device is not found, 1 is written to the execution error bit of the standard event status register.

### **Syntax**

`:MMEMory:STORe:TRACe`

`<trace_name>[,CSV],<file_name>[,{INTernal|EXTernal}]`

It is not necessary to add the extension to file\_name.

`<switch>`: Specify a device from the following.

`INTernal`: Internal storage media (Drive D)

`EXTernal`: USB storage media

When there are two or more USB storage media, the drive having the first drive letter (alphabetically) is specified automatically.

If `<switch>` is omitted, it defaults to `INTernal`.

### **Example of Use**

`:MMEMory:STORe:TRACe TRD,'LD_module_1545nm',EXTernal`

### 3.4.10 SENSE Subsystem

The commands in SENSE subsystem have the following command hierarchy.

```
:ATT[:STATe]
:AVERage:COUNT
:BANDwidth | BWIDth
  [:RESolution]
  :VIDeo
:CHOP[:STATe]
:CHOPper
:CORRection
  :LEVel:SHIFt
  :RVELOCITY:MEDIUm
  :WAVElength:SHIFt
:SETTing
  :MMMode
  :SMOoth
:SWEep
  :POINts
  :TIME:INTerval
[:WAVElength]
  :CENTer
  :OFFSet
  :SPAN
    :FULL
:START
:STOP
```

### **:SENSe:ATT[:STATe]**

#### **Function**

This command sets the internal optical attenuator.

This command queries the internal optical attenuator status.

#### **Syntax**

`:SENSe:ATT[:STATe] 0|1|OFF|ON`

`:SENSe:ATT[:STATe]?`

0|OFF: Does not use the optical attenuator.

1|ON: Uses the optical attenuator.

#### **Response Data**

0|1

#### **Example of Use**

`:SENSe:ATT:STATe ON`

`:SENSe:ATT:STATe?`

`>1`

### **:SENSe:AVERAge:COUNT**

#### **Function**

This command sets and queries the average processing (point averaging) count.

#### **Syntax**

`:SENSe:AVERAge:COUNT <numeric>|OFF`

`:SENSe:AVERAge:COUNT?`

Range 2 to 1000

Resolution 1

#### **Response Data**

`<numeric>|OFF`

`<numeric>`: Point averaging setting count 2 to 1000

OFF: Point averaging OFF

#### **Example of Use**

`:SENSe:AVERAge:COUNT 200`

`:SENSe:AVERAge:COUNT?`

`>200`

**[[:SENSE]:BANDwidth|BWIDth[:RESolution]****Function**

This command sets and queries the resolution.

**Syntax**

```
[[:SENSE]:BANDwidth|BWIDth[:RESolution]  
<numeric>[<unit_m>]  
[:SENSE]:BANDwidth|BWIDth[:RESolution]?
```

Set any of the following values.

0.03|0.05|0.07|0.1|0.2|0.5|1.0 (nm)

If a suffix is omitted, the unit will be m.

**Response Data**

<numeric>

<numeric>: Resolution (m)

**Example of Use**

```
:SENSE:BANDwidth:RESolution 0.1NM  
:SENSE:BWIDth:RESolution?  
>+1.00000000E-010
```

## **[[:SENSe]:BANDwidth|BWIDth:VIDeo**

### **Function**

This command sets and queries the video band width.

### **Syntax**

```
[[:SENSe]:BANDwidth|BWIDth:VIDeo <numeric>[<unit_h>]  
[:SENSe]:BANDwidth|BWIDth:VIDeo?
```

Set any of the following values.

```
10HZ|100HZ|200HZ|1KHZ|2KHZ|10KHZ|100KHZ|1MHZ|  
-200HZ|-1KHZ|10|100|200|1000|2000|10000|100000|1000000|  
-200|-1000
```

If a suffix is omitted, the unit will be Hz.

-200HZ and -200 represent “200HzFast”, -1KHZ and -1000 represent “1kHzFast”.

### **Response Data**

```
<numeric>
```

```
<numeric>: Video Band Width (Hz)
```

### **Example of Use**

```
:SENSe:BANDwidth:VIDeo 1000  
:SENSe:BWIDth:VIDeo?  
>+1.00000000E+003  
:SENSe:BANDwidth:VIDeo -200  
:SENSe:BWIDth:VIDeo?  
>-2.00000000E+002
```

## **[[:SENSe]:CHOP[:STATe]**

### **Function**

This command sets and queries the dynamic range High/Normal.

### **Syntax**

```
[[:SENSe]:CHOP[:STATe] 0|1|OFF|ON  
[:SENSe]:CHOP[:STATe]?
```

```
0|OFF: NORMAL
```

```
1|ON: HIGH
```

### **Response Data**

```
0|1
```



**Example of Use**

```
:SENSe:CHOP:STATe ON
:SENSe:CHOP:STATe?
>1
```

**:SENSe:CHOPper****Function**

This command sets and queries the dynamic range High/Normal.

**Syntax**

```
:SENSe:CHOPper 0|2|OFF|SWITCh
:SENSe:CHOPper?
```

```
0|OFF:    NORMAL
2|SWITCh: HIGH
```

**Response Data**

```
0|2
```

**Example of Use**

```
:SENSe:CHOPper SWIT
:SENSe:CHOPper?
>2
```

## **:SENSe:CORRection:LEVel:SHIFt**

### **Function**

This command sets the level offset and moves the screen waveform by the level offset amount.

This command queries the level offset.

### **Syntax**

:SENSe:CORRection:LEVel:SHIFt <numeric>[DB]

:SENSe:CORRection:LEVel:SHIFt?

Range            -30.00 to 30.00 dB

Resolution      0.01 dB

If a suffix is omitted, the unit will be dB.

### **Response Data**

<numeric>

<numeric>:      Level offset value (dB)  
                  -3.00000000E+001 to +3.00000000E+001

### **Example of Use**

:SENSe:CORRection:LEVel:SHIFt -0.2DB

:SENSe:CORRection:LEVel:SHIFt?

>-2.00000000E-001

**[[:SENSe]:CORRection:RVELOCITY:MEDIUm****Function**

This command sets and queries whether to display the wavelength in air or in vacuum.

**Syntax**

```
[[:SENSe]:CORRection:RVELOCITY:MEDIUm 0|1|AIR|VACuum
[:SENSe]:CORRection:RVELOCITY:MEDIUm?
```

```
0|AIR:      Value in air
1|VACuum:   Value in vacuum
```

**Response Data**

```
AIR|VAC
```

**Example of Use**

```
:SENSe:CORRection:RVELOCITY:MEDIUm AIR
:SENSe:CORRection:RVELOCITY:MEDIUm?
>AIR
```

**:SENSe:CORRection:WAVElength:SHIFt****Function**

This command sets and queries the wavelength offset and moves the waveform on the screen by the offset.

**Syntax**

```
:SENSe:CORRection:WAVElength:SHIFt <numeric>[<unit_m>]
:SENSe:CORRection:WAVElength:SHIFt?
```

```
Range      -1.00 to 1.00 nm
Resolution  0.01 nm
If a suffix is omitted, the unit will be m.
```

**Response Data**

```
<numeric>
```

```
<numeric>:  Wavelength offset value (m)
-1.00000000E-009 to +1.00000000E-009
```

**Example of Use**

```
:SENSe:CORRection:WAVElength:SHIFt -0.05NM
:SENSe:CORRection:WAVElength:SHIFt?
>-5.00000000E-011
```

### **:SENSe:SETTing:MMMode**

#### **Function**

This command sets and queries the multimode fiber mode.

#### **Syntax**

```
:SENSe:SETTing:MMMode 0|1|OFF|ON  
:SENSe:SETTing:MMMode?
```

0|OFF:        Releases multimode fiber mode  
1|ON:         Sets multimode fiber mode

#### **Response Data**

0|1

#### **Example of Use**

```
:SENSe:SETTing:MMMode OFF  
:SENSe:SETTing:MMMode?  
>0
```

### **:SENSe:SETTing:SMOoth**

#### **Function**

This command sets and queries the smoothing point count.

#### **Syntax**

```
:SENSe:SETTing:SMOoth 3|5|7|9|11|OFF  
:SENSe:SETTing:SMOoth?
```

3, 5, 7, 9, 11: This is the point count for smoothing.  
OFF:            Smoothing is not performed.

#### **Response Data**

3|5|7|9|11|OFF

#### **Example of Use**

```
:SENSe:SETTing:SMOoth 3  
:SENSe:SETTing:SMOoth?  
>3
```

**[[:SENSE]:SWEep:POINts****Function**

This command sets and queries the number of sampling points.

**Syntax**

```
[[:SENSE]:SWEep:POINts <numeric>
[:SENSE]:SWEep:POINts?
```

Specify any of the following to <numeric>.

51, 101, 251, 501, 1001, 2001, 5001, 10001, 20001, 50001

**Response Data**

51|101|251|501|1001|2001|5001|10001|20001|50001

**Example of Use**

```
:SENSE:SWEep:POINts 1001
:SENSE:SWEep:POINts?
>1001
```

**:SENSE:SWEep:TIME:INTERval****Function**

This command sets and queries the time interval of the sweep start.

**Syntax**

```
:SENSE:SWEep:TIME:INTERval <numeric>[S]
:SENSE:SWEep:TIME:INTERval?
```

Range            0 to 5940 s

Resolution      1 s

If a suffix is omitted, the unit will be s.

**Response Data**

<numeric>

<numeric>:      Time interval (s) 0 to 5940

**Example of Use**

```
:SENSE:SWEep:TIME:INTERval 60S
:SENSE:SWEep:TIME:INTERval?
>60
```

## **[[:SENSe][:WAVelength]:CENTer**

### **Function**

This command sets and queries the center wavelength.

### **Syntax**

```
[[:SENSe][:WAVelength]:CENTer <numeric>[<unit_m>]  
[:SENSe][:WAVelength]:CENTer?
```

Range            600.00 to 1750.00 nm

Resolution      0.01 nm

If a suffix is omitted, the unit will be m.

### **Response Data**

<numeric>

<numeric>:      Center wavelength (m)  
                  +6.00000000E-007 to +1.75000000E-006

### **Example of Use**

```
:SENSe:WAVelength:CENTer 1545350PM  
:SENSe:WAVelength:CENTer?  
>+1.54535000E-006
```

**[[:SENSe][:WAVelength]:OFFSet****Function**

This command sets and queries the wavelength offset and moves the waveform on the screen by the offset.

**Syntax**

```
[[:SENSe][:WAVelength]:OFFSet <numeric>[<unit_m>]
```

```
[[:SENSe][:WAVelength]:OFFSet?
```

Range            -1.00 to 1.00 nm

Resolution      0.01 nm

If a suffix is omitted, the unit will be m.

**Response Data**

```
<numeric>
```

<numeric>:      Wavelength offset value (m)  
-1.00000000E-009 to +1.00000000E-009

**Example of Use**

```
:SENSe:WAVelength:OFFSet -0.05NM  
:SENSe:WAVelength:OFFSet?  
>-5.00000000E-011
```

### **[[:SENSe]][:WAVelength]:SPAN**

#### **Function**

This command sets and queries the sweep width.

#### **Syntax**

```
[[:SENSe]][:WAVelength]:SPAN <numeric>[<unit_m>]  
[:SENSe]][:WAVelength]:SPAN?
```

Range            0|0.2 to 1200.0 nm

Resolution      0.1 nm

If a suffix is omitted, the unit will be m.

#### **Response Data**

<numeric>

<numeric>:      Sweep width (m)  
                 0|+2.00000000E-010 to +1.20000000E-006

#### **Example of Use**

```
:SENSe:WAVelength:SPAN 100NM  
:SENSe:WAVelength:SPAN?  
>+1.00000000E-007
```

### **[[:SENSe]][:WAVelength]:SPAN:FULL**

#### **Function**

This command sets the sweep width to the full span (600 to 1750 nm).

#### **Syntax**

```
[[:SENSe]][:WAVelength]:SPAN:FULL
```



**[[:SENSe][:WAVelength]:START****Function**

This command sets and queries the start wavelength.

**Syntax**

```
[[:SENSe][:WAVelength]:START <numeric>[<unit_m>]  
[:SENSe][:WAVelength]:START?
```

Range            600.0 to 1750.0 nm (Start wavelength)

Resolution      0.1 nm

If a suffix is omitted, the unit will be m.

**Response Data**

<numeric>

<numeric>:      Start wavelength (m)  
                  +6.00000000E-007 to +1.75000000E-006

Specify smaller value than Stop wavelength.

**Example of Use**

```
:SENSe:WAVelength:START 1541.0NM  
:SENSe:WAVelength:START?  
>+1.54100000E-006
```

## **[[:SENSe][:WAVelength]:STOP**

### **Function**

This command sets and queries the stop wavelength.

### **Syntax**

```
[[:SENSe][:WAVelength]:STOP <numeric>[<unit_m>]  
[:SENSe][:WAVelength]:STOP?
```

Range            600.0 to 1800.0 nm (Stop wavelength)

Resolution      0.1 nm

If a suffix is omitted, the unit will be m.

### **Response Data**

<numeric>

<numeric>:      Stop wavelength (m)  
                  +6.00000000E-007 to +1.80000000E-006

Specify larger value than Start wavelength.

### **Example of Use**

```
:SENSe:WAVelength:STOP 1562.8NM  
:SENSe:WAVelength:STOP?  
>+1.56280000E-006
```

### 3.4.11 SOURce Subsystem

#### :SOURce:STATe 'EELED1550'

**Function**

This command sets and queries the On/Off state of the light source option.

**Syntax**

```
:SOURce:STATe 'EELED1550',0|1|OFF|ON  
:SOURce:STATe? 'EELED1550'
```

0 OFF:	Obstructs light output
1 ON:	Outputs light

**Response Data**

0|1

**Example of Use**

```
:SOURce:STATe 'EELED1550',ON  
:SOURce:STATe? 'EELED1550'  
>1
```

### 3.4.12 STATus Subsystem

The commands in STATus subsystem have the following command hierarchy.

```
:EVENT
  :CONDition?
  :ENABle
  :ERRor
    :CONDition?
    :ENABle
```

#### **:STATus:EVENT:CONDition?**

##### **Function**

This command queries the end event status register value.

##### **Syntax**

```
:STATus:EVENT:CONDition?
```

##### **Response Data**

```
<numeric>
```

```
<numeric>: End event register value 0 to 255
```

#### **:STATus:EVENT:ENABle**

##### **Function**

This command sets and queries the enable register value of the end event status register.

##### **Syntax**

```
:STATus:EVENT:ENABle <numeric>
:STATus:EVENT:ENABle?
```

```
<numeric>: Enable register value 0 to 255
```

##### **Response Data**

```
<numeric>
```

**:STATus:EVENT:ERRor:CONDition?****Function**

This command queries the error event status register value.

**Syntax**

```
:STATus:EVENT:ERRor:CONDition?
```

**Response Data**

```
<numeric>
```

```
<numeric>: Error event status register value 0 to 255
```

**:STATus:EVENT:ERRor:ENABle****Function**

This command sets and queries the enable register value of the error event status register.

**Syntax**

```
:STATus:EVENT:ERRor:ENABle <numeric>  
:STATus:EVENT:ERRor:ENABle?
```

```
<numeric>: Enable register value 0 to 255
```

**Response Data**

```
<numeric>
```

### 3.4.13 SYSTem Subsystem

The commands in SYSTem subsystem have the following command hierarchy.

:BUZZer  
:ERRor[:NEXT]?  
:INFormation?  
:PRESet  
:SOFTware:VERSion?

#### :SYSTem:BUZZer

##### Function

This command sets and queries the On/Off state of the buzzer. This message is a system management command.

##### Syntax

:SYSTem:BUZZer 0|1|OFF|ON  
:SYSTem:BUZZer?

0|OFF:       Disable the buzzer.  
1|ON:         Enable the buzzer.

##### Response Data

0|1

#### :SYSTem:ERRor[:NEXT]?

##### Function

This command queries the message code described in Appendix A. The message code is a value other than under the following conditions:

- Command error bit (bit 5) of standard event status register is 1
- Execution error bit (bit 4) is 1
- Equipment-dependent error bit (bit 3) is 1.

##### Syntax

:SYSTem:ERRor[:NEXT]?

##### Response Data

<numeric>

<numeric>:    Message code

**:SYSTem:INFormation?****Function**

This command queries the system information.  
This message is a system management command.

**Syntax**

```
:SYSTem:INFormation? ALL|MODEL|SERIAL|TYPE
```

ALL:           Queries product name, model name, and serial number.  
MODEL:         Queries model name.  
SERIAL:        Queries serial number.  
TYPE:          Queries product name.

**Response Data**

```
<string>|<numeric>|{<string>,<string>,<numeric>}
```

<string>:      Character displaying product name model  
<numeric>:    Integer value indicating serial number

**Example of Use**

```
:SYSTem:INFormation? ALL
>Optical Spectrum Analyzer,MS9740B,626000001
:SYSTem:INFormation? MODEL
>MS9740B
:SYSTem:INFormation? SERIAL
>626000001
:SYSTem:INFormation? TYPE
>Optical Spectrum Analyzer
```

**:SYSTem:PRESet****Function**

This command initializes the measurement parameter.  
As for the initialized parameters and default values, refer to Appendix B, “Initial Values” in the *MS9740B Optical Spectrum Analyzer Operation Manual*.

**Syntax**

```
:SYSTem:PRESet
```

## **:SYSTem:SOFTware:VERSion?**

### **Function**

This command queries the software version.

This message is a system management command.

### **Syntax**

`:SYSTem:SOFTware:VERSion? ALL|OSA`

**ALL:** Queries all versions of the software installed in the MS9740B.

**OSA:** Queries the version of software for the Optical Spectrum Analyzer.

### **Response Data**

`ALL|OSA <string>`

**<string>:** Character string indicating software version

### **Example of Use**

`:SYSTem:SOFTware:VERSion? OSA`

`>OSA 1.05.00`



### 3.4.14 TRACe Subsystem

The commands in TRACe subsystem have the following command hierarchy.

```

:ACTive
:ATTRibute
    [<trace_name>|TRG]
    :RAVG[<trace_name>]
[:DATA]
    :SNUMber?
    :X
        :START?
        :STOP?
        [:WAVelength]:SSTop
    [:Y]?
    :DCX?
    :DMA|DMB|DMC|DMD|DME|DMF|DMG|DMH|DMI|DMJ?
:DELeTe
    :EOV
:FEED:CONTRol
:POINts
:STATe[<trace_name>]
:STORage

```

#### :TRACe:ACTive

##### Function

This command sets and queries the active trace.

##### Syntax

```

:TRACe:ACTive <trace_name>|TRG
:TRACe:ACTive?

```

##### Response Data

```

TRA|TRB|TRC|TRD|TRE|TRF|TRG|H|I|J

```

##### Example of Use

```

:TRACe:ACTive B
:TRACe:ACTive?
>TRB
:TRACe:ACTive H
:TRACe:ACTive?
>H

```

**:TRACe:ATTRibute[:<trace\_name>|TRG]**

**Function**

This command sets and queries the active trace type and the storage Mode.

**Syntax**

:TRACe:ATTRibute[:<trace\_name>|TRG] <switch>

:TRACe:ATTRibute[:<trace\_name>|TRG]?

<switch>: Specify either Trace Type or Storage Mode from the following.

- WRITe: Write
- FIX: Fix
- CALC: Calculate
- RAVG: Sweep Average
- MAX: Max Hold
- MIN: Min Hold
- OVL: Overlap
- BLANk: Blank

**Response Data**

0|1|2|3|4|5|6|7

The response data values are described below.

Response	Trace type	Storage Mode
0	Write	Off
1	Fix	–
2	Write	Max Hold
3	Write	Min Hold
4	Write	Sweep Average
5	Calculate	–
6	Write	Overlap
7	Blank	–

**Example of Use**

```
:TRACe:ATTRibute:TRA WRITe
:TRACe:ATTRibute:TRA MAX
:TRACe:ATTRibute:TRA?
>2
:TRACe:ATTRibute:TRA CALC
:TRACe:ATTRibute:TRA?
>5
```

**:TRACe:ATTRibute:RAVG[:<trace\_name>]****Function**

This command sets and queries the average processing (sweep averaging) count.

**Syntax**

```
:TRACe:ATTRibute:RAVG[:<trace_name>] <numeric>  
:TRACe:ATTRibute:RAVG[:<trace_name>]?
```

Even though <trace\_name> is specified, this command sets or queries the sweep average count of every trace.

<numeric>: Sweep average setting value 1 to 1000

**Response Data**

<numeric>

**Example of Use**

```
:TRACe:ATTRibute:RAVG:H 300  
:TRACe:ATTRibute:RAVG:H?  
>300
```

**:TRACe[:DATA]:SNUMber?****Function**

This command queries the number of sampling points.

**Syntax**

```
:TRACe[:DATA]:SNUMber? <trace_name>
```

**Response Data**

51|101|251|501|1001|2001|5001|10001|20001|50001

**Example of Use**

```
:TRACe:DATA:SNUMber? B  
>501
```

### **:TRACe[:DATA]:X:START?**

#### **Function**

This command queries the start wavelength.

#### **Syntax**

```
:TRACe[:DATA]:X:START? <trace_name>
```

#### **Response Data**

<numeric>

<numeric>: Start wavelength (m)  
+6.00000000E-007 to +1.75000000E-006

#### **Example of Use**

```
:TRACe:DATA:X:START? TRC  
>+1.54102000E-006
```

### **:TRACe[:DATA]:X:STOP?**

#### **Function**

This command queries the stop wavelength.

#### **Syntax**

```
:TRACe[:DATA]:X:STOP? <trace_name>
```

#### **Response Data**

<numeric>

<numeric>: Stop wavelength (m)  
+6.00000000E-007 to +1.80000000E-006

#### **Example of Use**

```
:TRACe:DATA:X:STOP? TRC  
>+1.60000000E-006
```

**:TRACe[:DATA]:X[:WAVelength]:SSTop****Function**

This command sets and queries the start and stop wavelength simultaneously.

**Syntax**

```
:TRACe[:DATA]:X[:WAVelength]:SSTop
<trace_name>,<numeric>[<unit_m>],<numeric>[<unit_m>]
:TRACe[:DATA]:X[:WAVelength]:SSTop?
```

Even though <trace\_name> is specified, this command sets or queries the start wavelength and stop wavelength of every trace.

No.	Parameter	Type	Range	Description
1	<numeric>		600.0 to 1750.0 nm	Start wavelength
2	<numeric>		600.0 to 1800.0 nm	Stop wavelength

Resolution 0.1 nm

If a suffix is omitted, the unit will be m.

**Response Data**

```
<numeric>,<numeric>
```

No.	Parameter	Type	Range	Description
1	<numeric>		+6.00000000E-007 to +1.75000000E-006	Start wavelength (m)
2	<numeric>		+6.00000000E-007 to +1.80000000E-006	Stop wavelength (m)

The value of the second parameter must be equal to or greater than the value of the first parameter.

**Example of Use**

```
:TRACe:DATA:X:WAVelength:SSTop TRA,1243.5nm,1551.0nm
:TRACe:DATA:X:WAVelength:SSTop?
>+1.24350000E-006,+1.55100000E-006
```

## :TRACe[:DATA][:Y]?

### Function

When :FORMat[:DATA] REAL is set:

This command specifies the Response Data in binary format and queries the trace data.

When :FORMat[:DATA] ASCii is set:

This command specifies the numeric format of the response data and queries the sampling count for trace A to J data. The data are output with comma separators.

When the level scale is set to Normalize, trace data cannot be output.

### Syntax

:TRACe[:DATA][:Y]? <trace\_name>|TRG

### Response Data

When :FORMat[:DATA] REAL is set:

<binary\_data>

Data format: Double Precision Floating Point

When :FORMat[:DATA] ASCii is set:

<numeric>,<numeric>,<numeric>,...,<numeric>

Display scale	Unit
Linear scale in absolute value	W
Linear scale in relative value (When Trace Type is set to Calc)	%
Log scale in absolute value	dBm
Log scale in relative value (When Trace Type is set to Calc)	dB

The binary data is the character after the number sign (#) indicating the number of digits in the data.

The binary data follows the number indicating the data length.

Example:

#42002an%\*qe4445+\...

4 digits

2002 bytes of binary data

**:TRACe[:DATA][:Y]:DCA|DCB|DCC|DCD|DCE|DCF|DCG|DCH|DCI|DCJ?****Function**

This command queries wavelength and sampling points of the trace. Specify a trace (A to J) by specifying a parameter value from DCA to DCJ.

**Syntax**

```
:TRACe[:DATA][:Y]:DCA|DCB|DCC|DCD|DCE|DCF|DCG|DCH|DCI|DCJ?
```

**Response Data**

```
<numeric>,<numeric>,<switch>
```

No.	Parameter Type	Range	Description
1	<numeric>	+6.00000000E-007 to +1.75000000E-006	Start wavelength (m)
2	<numeric>	+6.00000000E-007 to +1.80000000E-006	Stop wavelength (m)
3	<switch>	51 101 251 501 1001 2001  5001 10001 20001 50001	Sampling points

**Example of Use**

```
:TRACe:DATA:Y:DCA?
>+1.55239000E+003,+1.55739000E+003,2001
```

**:TRACe[:DATA][:Y]:DMA|DMB|DMC|DMD|DME|DMF|DMG|DMH|DMI|DMJ?**

**Function**

This command specifies the response data numeric format and queries the trace data sampling points, which is displayed on the screen. Specify a trace (A to J) by specifying a parameter value from DMA to DMJ.

Data is output with the following string separators.

Communication I/F terminator LF or NONE: LF (Line Feed)

Communication I/F terminator CR/LF or NONE: CR (Carriage Return) + LF (Line Feed)

When the level scale is set to Normalize, trace data cannot be output.

**Syntax**

:TRACe [ :DATA ] [ :Y ] :DMA | DMB | DMC | DMD | DME | DMF | DMG | DMH | DMI | DMJ?

**Response Data**

<numeric>

Display scale	Unit
Linear scale in absolute value	W
Linear scale in relative value (When Trace Type is set to Calc)	%
Log scale in absolute value	dBm
Log scale in relative value (When Trace Type is set to Calc)	dB

**Example of Use**

```
:TRACe:DATA:DMA?
>-5.60320000E+000
>-5.60420000E+000
>-5.60580000E+000
>-5.61080000E+000
>-5.61230000E+000
>-5.61550000E+000
:
```

For the binary data, the head string starts with a sign (#) and continues with data after a numeric value indicating the data length.

The character after the sign (#) indicates the number of digits in the data length.

The binary data follows the number indicating the data length.

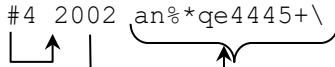
Example: #4 2002 an%\*qe4445+\  



**:TRACe:DELeTe****Function**

This command deletes the trace waveform

**Syntax**

```
:TRACe:DELeTe <trace_name>|TRG
```

**:TRACe:DELeTe:EOV****Function**

This command erases the overlap display of the specified traces.

**Syntax**

```
:TRACe:DELeTe:EOV <trace>
```

**:TRACe:FEED:CONTRol****Function**

This command sets and queries the trace type.

**Syntax**

```
:TRACe:FEED:CONTRol <trace_name>,ALW|BLANK|CALC|NEV  
:TRACe:FEED:CONTRol? <trace_name>
```

ALW:	Write
BLANK:	Blank
CALC:	Calculate
NEV:	Fix

**Response Data**

ALW|BLANK|CALC|NEV

**Example of Use**

```
:TRACe:FEED:CONTRol F,ALW  
:TRACe:FEED:CONTRol? F  
>ALW
```

## **:TRACe:POINts**

### **Function**

This command sets and queries the number of sampling points.

### **Syntax**

```
:TRACe:POINts TRA|TRB|TRC|TRD|TRE|TRF,<numeric>  
:TRACe:POINts?
```

Specify any of the following to <numeric>.

51, 101, 251, 501, 1001, 2001, 5001, 10001, 20001, 50001

### **Response Data**

51|101|251|501|1001|2001|5001|10001|20001|50001

### **Example of Use**

```
:TRACe:POINts TRF,2001  
:TRACe:POINts?  
>2001
```

## **:TRACe:STATe[:<trace\_name>|TRG]**

### **Function**

This command sets and queries the trace display.

### **Syntax**

```
:TRACe:STATe[:<trace_name>|TRG] 0|1|OFF|ON  
:TRACe:STATe[:<trace_name>|TRG]?
```

0|OFF: Does not display the trace.

1|ON: Displays the trace.

### **Response Data**

0|1

### **Example of Use**

```
:TRACe:STATe:B ON  
:TRACe:STATe:B?  
>1
```

**:TRACe:STORage****Function**

This command sets and queries the Storage Mode of trace.

**Syntax**

```
:TRACe:STORage <trace>,AVS|MAX|MIN|OFF|OVL
```

```
:TRACe:STORage? <trace>
```

AVS: Sweep Average

MAX: Max Hold

MIN: Min Hold

OFF: Off

OVL: Overlap

**Response Data**

```
AVS|MAX|MIN|OFF|OVL
```

**Example of Use**

```
:TRACe:STORage C,MAX
```

```
:TRACe:STORage? C
```

```
>MAX
```

### 3.4.15 TRIGger Subsystem

The commands in TRIGger subsystem have the following command hierarchy.

```
[:SEQuence]
  :DELay
  :SOURce
  :STATe
```

#### **:TRIGger[:SEQuence]:DELay**

##### **Function**

This command sets and queries the delay time when using the external trigger.

##### **Syntax**

```
:TRIGger[:SEQuence]:DELay <numeric>[S|MS|US|NS]
:TRIGger[:SEQuence]:DELay?
```

<numeric>: Delay time

Range 0 to 5 s

Resolution 1  $\mu$ s

If a suffix is omitted, the unit will be s.

##### **Response Data**

```
<numeric>
```

<numeric>: Delay time (s)

+0.00000000E+000 to +5.00000000E+000

##### **Example of Use**

```
:TRIGger:SEQuence:DELay 6.553MS
```

```
:TRIGger:SEQuence:DELay?
```

```
>+6.55300000E-003
```

**:TRIGger[:SEQuence]:SOURce****Function**

This command sets and queries the trigger of the modulation measurement mode.

**Syntax**

```
:TRIGger[:SEQuence]:SOURce EXT|INT  
:TRIGger[:SEQuence]:SOURce?
```

EXT: Uses external trigger.  
INT: Does not use external trigger.

**Response Data**

EXT|INT

**Example of Use**

```
:TRIGger:SEQuence:SOURce INT  
:TRIGger:SEQuence:SOURce?  
>INT
```

**:TRIGger[:SEQuence]:STATe****Function**

This command sets and queries the trigger of the modulation measurement mode.

**Syntax**

```
:TRIGger[:SEQuence]:STATe 0|1|OFF|ON  
:TRIGger[:SEQuence]:STATe?
```

0|OFF: Does not use external trigger.  
1|ON: Uses external trigger.

**Response Data**

0|1

**Example of Use**

```
:TRIGger:SEQuence:STATe ON  
:TRIGger:SEQuence:STATe?  
>1
```

### 3.4.16 UNIT Subsystem

#### :UNIT:POWer

##### Function

This command sets the level scale to Log or Linear.

This command queries the level scale setting.

##### Syntax

:UNIT:POWer DBM|W

:UNIT:POWer?

DBM:           Log scale

W:             Linear scale

##### Response Data

DBM|W

##### Example of Use

:UNIT:POWer DBM

:UNIT:POWer?

>DBM

# Appendix A Message Codes

---

This appendix describes the meanings of response numbers (codes) for the `:SYSTEM:ERROR[:NEXT]?` message.

## A.1 Command errors

Error codes [–100 to –199] indicate that an IEEE488.2 syntax error occurs. When an error occurs, bit 5 of the event status register is set.

**Table A.1-1 Command Error Codes**

Code	Meaning
113	Command header undefined
–140	Character data error
–140	Illegal character in input string
–160	Block data error

## A.2 Execution errors

Error codes [–200 to –299] indicate the occurrence of errors during command processing by MS9740B. When an error occurs, bit 4 of the event status register is set.

**Table A.2-1 Execution Error Codes**

Code	Meaning
–220	Other error. *
–250	File read failed.
–250	File read failed (incorrect model).
–250	File read failed (incorrect option configuration).
–250	File write failed.
–250	Folder not found.
–250	Input title.
–250	Item not selected.
–250	Mass storage error
–250	No file selected.
–250	Either the device has insufficient free space or the 1000 limit on saved files has been reached.
–250	Save file name not specified.
–252	No external storage device
–254	Target device full.
–256	File not found.
–258	Operation failed because write protected.

\*: This message indicates that an undefined error has occurred.



## A.3 Device-dependent errors

Error codes [–300 to –399] and [0 to 32767] indicate that an error other than command or execution error occurs in MS9740B. When a device error occurs, bit 3 of the event status register is set.

**Table A.3-1 System-Related Error Codes (0 to 99)**

Code	Meaning
0	No error.
1	Optical Unit failed memory test at boot.
2	Slit 1 error in Optical Unit.
3	Slit 2 error in Optical Unit.
4	Optical Unit failed alignment adjustment.
5	Optical attenuator error.
7	Optional light source error.
8	Optical Unit failed grating control.
9	Optical Unit failed offset adjustment.
10	Optical input power too high. Insert attenuator or decrease input level.
11	Optical Unit failed program test. Contact Anritsu or representative.
12	Optical Unit failed calibration data test Contact Anritsu or representative
13	Optical Unit failed FPGA data test. Contact Anritsu or representative
14	Error in Optical Unit.
49	Control CPU application error. File not found.
51	Control CPU Boot Error.
52	FPGA Config Error.
53	Control CPU Shutdown Error.

**Table A.3-2 Measurement-Related Codes (100 to 199, 5000 to 5199)**

<b>Code</b>	<b>Meaning</b>
101	Peak point not found. Confirm that optical level is high enough for Peak Search.
102	Dip point not found. Confirm that optical level is high enough for Dip Search.
108 109	Incorrect parameter count.
110	Optical power too low to calibrate wavelength. Adjust input level.
113	Optical Unit failed auto alignment.
113	Undefined error.
114	Resolution bandwidth calibration failed.
115	Auto CAL failed.
120	Incorrect numeric data.
150	Incorrect string data.
5000	Auto Measure finished unsuccessfully.
5001	Optical power too low for Optical Unit auto-adjustment. Adjust input level.
5008	Wavelength calibration failed.

Table A.3-3 Operation-Related Codes (200 to 299)

Code	Meaning
200	Execution error
210	Operation prohibited during measurement.
211	Operation prohibited during Auto Measure.
212	Operation prohibited while Power Monitor displayed.
213	Operation prohibited at Peak Search or Dip Search.
214	Invalid In Sweep-Average.
215	Operation prohibited while Ext.Trig. displayed.
216	Operation prohibited at Calibration.
217	No Write-Trace
220	Operation prohibited at Analysis.
221	Operation prohibited when Application selected.
221	Setting conflict.
222	Character string too long.
222	Input value out of range.
222	Operation prohibited when WDM Application selected.
223	Operation prohibited when Opt.Amp Application selected.
224	Operation prohibited when Auto PMD selected.
225	Operation prohibited when Pulse Method or WDM Method in Opt. Amp Application is selected.
226	Operation prohibited when Spectrum Power is selected.
227	Operation prohibited when Peak/Dip Search is not performed.
228	Operation prohibited when Area specified as Noise Detection Type.
230	Operation prohibited when Normalize Disp displayed.
231	Operation prohibited when Zone Marker displayed. Turn Zone Marker off.
232	Set Span larger than 0.
233	Operation prohibited at frequency unit Change unit from frequency to wavelength.
235	Operation prohibited at Linear Scale. Change Linear Scale to Log Scale.
236	Option Error(**)
238	Operation prohibited when Calculation set for Trace Type. Change Trace Type to setting other than Calculation.
239	Set Display of Active Trace to On.
240	Selected TCP Port Number busy. Change TCP Port Number.
241	Storage Mode enabled only when Write set for Trace Type of active trace
242	Calculation enabled only when calculation set for Trace Type of active trace
243	Trace measurement parameters must be same to calculate between traces.
244	Trace already in use
245	Invalid wavelength
246	Pase enabled only when PLZN Nulling set for Method.

**Table A.3-4 Remote-Control-Related Codes (-300 to -399)**

<b>Code</b>	<b>Meaning</b>
-350	Queue overflow

References are to page numbers.

## A

About This Manual ..... I  
Asynchronous message ..... 2-24

## B

binary data.....2-15, 3-230, 3-258, 3-260

## C

Change adapter options .....2-11  
Change adapter settings ..... 2-8  
Checking Connection ..... 2-12  
Command Error..... 2-19  
Command Prompt ..... 2-12  
commands ..... 2-14  
Common Commands ..... 3-22  
Connecting Ethernet..... 2-4  
Connecting GPIB..... 2-5  
Controlling Message Sync ..... 2-24  
Correspondence between Panel Operation and  
Message ..... 3-3  
CR/LF ..... 2-7

## D

Device dependant Error Code.....A-3  
Device Dependent Error ..... 2-19  
Device Dependent Messages..... 3-22

## E

End Event Register ..... 2-20  
End Execution ..... 2-20  
EOI ..... 2-7  
Error Event Register..... 2-22  
Ethernet Interface..... 2-2  
Execution Error ..... 2-19  
Execution Error Code.....A-2

## G

GPIB Cable Connection ..... 2-5  
GPIB Interface ..... 2-2  
GPIB Settings.....2-11

## I

IEEE488.2 Common Message ..... 3-26

IEEE488.2 Common Messages and Device  
Dependent Messages ..... 3-22  
Interface Setting..... 2-7, 2-11

## L

LF ..... 2-7  
Local Area Connection 2 ..... 2-9

## M

Meas-Condition..... 2-22  
Measurement commands ..... 3-23  
Measurement end..... 2-20  
Message Format ..... 2-14

## N

Network and Sharing Center ..... 2-8  
Network Connections ..... 2-11  
Neutral commands ..... 3-24

## O

Operation Complete ..... 2-19

## P

ping ..... 2-12  
Power-on..... 2-19  
Program Messages ..... 2-14

## Q

queries ..... 2-14  
Query Error ..... 2-19  
Querying Measurement End ..... 2-27

## R

Register Structure ..... 2-16  
Response Messages ..... 2-14  
RES-Uncal ..... 2-22  
Rules for Describing Messages ..... 3-2

## S

SCPI ..... 1-2  
service request ..... 2-17  
Setting Ethernet..... 2-7  
Setting GPIB..... 2-11  
Standard Event Status Register ..... 2-19

*Index*

---

Status Byte Register ..... 2-18  
String data ..... 2-15  
Sweep end ..... 2-20  
Synchronous message ..... 2-24  
Syntax Error Code.....A-1  
System management commands ..... 3-23

**T**

Terminator Settings ..... 2-7, 2-11

**U**

Using \*OPC ..... 2-26  
Using \*OPC and \*ESR? ..... 2-27

**V**

VISA ..... 2-2