

MS9740B
Optical Spectrum Analyzer
Operation Manual

Fourth Edition



**For safety and warning information, please read this manual before attempting to use the equipment.
Keep this manual with the equipment.**

ANRITSU CORPORATION

Safety Symbols

To prevent the risk of personal injury or loss related to equipment malfunction, Anritsu Corporation uses the following safety symbols to indicate safety-related information. Ensure that you clearly understand the meanings of the symbols BEFORE using the equipment. Some or all of the following symbols may be used on all Anritsu equipment. In addition, there may be other labels attached to products that are not shown in the diagrams in this manual.

Symbols used in manual

-  **DANGER** This indicates a very dangerous procedure that could result in serious injury or death if not performed properly.
-  **WARNING** This indicates a hazardous procedure that could result in serious injury or death if not performed properly.
-  **CAUTION** This indicates a hazardous procedure or danger that could result in light-to-severe injury, or loss related to equipment malfunction, if proper precautions are not taken.

Safety Symbols Used on Equipment and in Manual

The following safety symbols are used inside or on the equipment near operation locations to provide information about safety items and operation precautions. Ensure that you clearly understand the meanings of the symbols and take the necessary precautions BEFORE using the equipment.



This indicates a prohibited operation. The prohibited operation is indicated symbolically in or near the barred circle.



This indicates an obligatory safety precaution. The obligatory operation is indicated symbolically in or near the circle.



This indicates a warning or caution. The contents are indicated symbolically in or near the triangle.



This indicates a note. The contents are described in the box.



These indicate that the marked part should be recycled.

MS9740B
Optical Spectrum Analyzer
Operation Manual

9 April 2019 (First Edition)
15 September 2021 (Fourth Edition)

Copyright © 2019-2021, ANRITSU CORPORATION.

All rights reserved. No part of this manual may be reproduced without the prior written permission of the publisher.

The operational instructions of this manual may be changed without prior notice.

Printed in Japan

For Safety

DANGER

Replacing Battery



- When replacing the battery, use the specified battery and insert it with the correct polarity. If the wrong battery is used, or if the battery is inserted with reversed polarity, there is a risk of explosion causing severe injury or death.

Battery Disposal

- DO NOT expose batteries to heat or fire. This is dangerous and can result in explosions or fire. Heating batteries may cause them to leak or explode.
-

WARNING



- ALWAYS refer to the operation manual when working near locations at which the alert mark shown on the left is attached. If the advice in the operation manual is not followed, there is a risk of personal injury or reduced equipment performance. The alert mark shown on the left may also be used with other marks and descriptions to indicate other dangers.

- **Overvoltage Category**

This equipment complies with overvoltage category II defined in IEC 61010. DO NOT connect this equipment to the power supply of overvoltage category III or IV.

- **Laser radiation warning**

- NEVER look directly into the cable connector on the equipment nor into the end of a cable connected to the equipment. There is a risk of injury if laser radiation enters the eye.
- The Laser Safety label is attached to the equipment for safety use as indicated in "Laser Safety" later in this section.

Electric Shock

- To ensure that the equipment is grounded, always use the supplied 3-pin power cord, and insert the plug into an outlet with a ground terminal. If power is supplied without grounding the equipment, there is a risk of receiving a severe or fatal electric shock or causing damage to the internal components.
-

For Safety

WARNING

Repair



- Only qualified service personnel with a knowledge of electrical fire and shock hazards should service this equipment. This equipment cannot be repaired by the operator. DO NOT attempt to remove the equipment covers or unit covers or to disassemble internal components. There are high-voltage parts in this equipment presenting a risk of severe injury or fatal electric shock to untrained personnel. In addition, there is a risk of damage to precision components.

Calibration



- The performance-guarantee seal verifies the integrity of the equipment. To ensure the continued integrity of the equipment, only Anritsu service personnel, or service personnel of an Anritsu sales representative, should break this seal to repair or calibrate the equipment. Be careful not to break the seal by opening the equipment or unit covers. If the performance-guarantee seal is broken by you or a third party, the performance of the equipment cannot be guaranteed.

Falling Over

- This equipment should always be positioned in the correct manner. If the cabinet is turned on its side, etc., it will be unstable and may be damaged if it falls over as a result of receiving a slight mechanical shock.

Always set up the equipment in a position where the power switch can be reached without difficulty.

Battery Fluid

- DO NOT short the battery terminals and never attempt to disassemble the battery or dispose of it in a fire. If the battery is damaged by any of these actions, the battery fluid may leak.

This fluid is poisonous.

DO NOT touch the battery fluid, ingest it, or get in your eyes. If it is accidentally ingested, spit it out immediately, rinse your mouth with water and seek medical help. If it enters your eyes accidentally, do not rub your eyes, rinse them with clean running water and seek medical help. If the liquid gets on your skin or clothes, wash it off carefully and thoroughly with clean water.

For Safety

WARNING

LCD

-
- This equipment uses a Liquid Crystal Display (LCD). DO NOT subject the equipment to excessive force or drop it. If the LCD is subjected to strong mechanical shock, it may break and liquid may leak. This liquid is very caustic and poisonous. DO NOT touch it, ingest it, or get in your eyes. If it is ingested accidentally, spit it out immediately, rinse your mouth with water and seek medical help. If it enters your eyes accidentally, do not rub your eyes, rinse them with clean running water and seek medical help. If the liquid gets on your skin or clothes, wash it off carefully and thoroughly with soap and water.
-

For Safety

CAUTION

Cleaning

-
- Always remove the main power cable from the power outlet before cleaning dust around the power supply and fan.
 - Clean the power inlet regularly. If dust accumulates around the power pins, there is a risk of fire.
 - Keep the cooling fan clean so that the ventilation holes are not obstructed. If the ventilation is obstructed, the cabinet may overheat and catch fire.
-

For Safety

Laser Safety

The laser in this equipment is classified as Class 1 according to the IEC 60825-1:2007 standard, or as Class I according to the 21 CFR 1040.10:1995 standard. Class 1 and Class I are defined as below.

Class 1: Lasers that are safe under reasonably foreseeable conditions of operation, including the use of optical instruments for intrabeam viewing.

Class I: Class I levels of laser radiation are not considered to be hazardous.



Use of controls or adjustments or performance of procedures other than those specified herein may result in hazardous radiation exposure.

The use of optical instruments with this product will increase eye hazard.

Table 1 Laser Safety Classifications Based on IEC 60825-1:2007

Model Name	Class	Max. Optical Output Power (mW)*	Pulse Width (s)/ Repetition Rate	Emitted Wavelength (nm)	Beam Divergence (deg.)	Laser Aperture
MS9740B + MS9740B-002 (option)	1	1	CW	1530-1570	11.5	Figure 1, [1]

*: Indicates the possible optical output power when each and every reasonably foreseeable single-fault condition is included.

Table 2 Specifications of Laser Built into MS9740B

Model Name	Max. Optical Output Power (mW)*	Pulse Width (s)/ Repetition Rate	Emitted Wavelength (nm)	Beam Divergence (deg.)
MS9740B + MS9740B-002 (option)	1	CW	1530-1570	11.5

*: Indicates the possible optical output power when each and every reasonably foreseeable single-fault condition is included.



Table 3 Laser Safety Classifications Based on 21 CFR 1040.10:1995

Model Name	Class	Max. Optical Output Power (μW)*	Pulse Width (s)/ Repetition Rate	Emitted Wavelength (nm)	Laser Aperture
MS9740B + MS9740B-002 (option)	I	400	CW	1530-1570	Figure 1, [1]

*: Indicates the possible optical output power during normal operation.

For Safety

Table 4 Labels on Product

	Type	Label	Affixed to:	Model Name
1	Explanation		Figure 1, A	MS9740B + MS9740B-002 (option)
2	Certification		Figure 1, B	MS9740B + MS9740B-002 (option)
3	Identification		Figure 1, C	MS9740B + MS9740B-002 (option)

Laser Radiation Markings

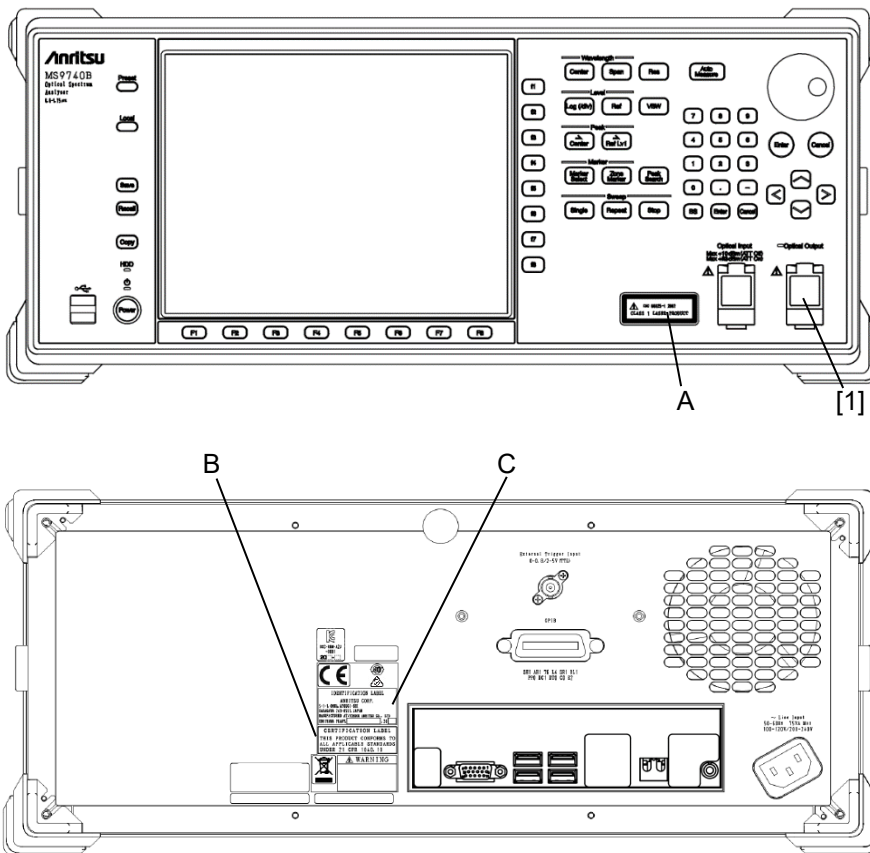

Figure 1 Locations of Laser Beam Apertures and Affixed Labels

For Safety



CAUTION

Replacing Memory Back-up Battery

This equipment uses a Poly-carbon monofluoride lithium battery to backup the memory. This battery must be replaced by service personnel when it has reached the end of its useful life; contact the Anritsu sales section or your nearest representative.

Note: The battery used in this equipment has a maximum useful life of 4 years. It should be replaced before this period has elapsed.

Hard disk

The equipment is equipped with an internal hard disk from which, as with any hard disk, data may be lost under certain conditions. It is recommended to periodically back up all important data and programs to protect them from being lost accidentally.

Anritsu will not be held responsible for lost data.

To reduce the possibility of data loss, particular attention should be given to the following points.

- The equipment should only be used within the recommend temperature range, and should not be used in locations where the temperature may fluctuate suddenly.
- Always follow the guidelines to ensure that the equipment is set up in the specified manner.
- Always ensure that the fans at the rear and side of the equipment are not blocked or obstructed in any way.
- Exercise care not to bang or shake the equipment whilst the power is on.
- Never disconnect the mains power at the plug or cut the power at the breaker with the equipment turned on.

Lifetime of Parts

The life span of certain parts used in this equipment is determined by the operating time or the power-on time. Due consideration should be given to the life spans of these parts when performing continuous operation over an extended period. The safety of the equipment cannot be guaranteed if component parts are used beyond their life spans. These parts must be replaced at the customer's expense even if within the guaranteed period described in Warranty at the beginning of this manual. For details on life-span, refer to the corresponding section in this manual.

Use in a Residential Environment

This equipment is designed for an industrial environment.

In a residential environment, this equipment may cause radio interference in which case the user may be required to take adequate measures.

For Safety

CAUTION

Use in Corrosive Atmospheres

Exposure to corrosive gases such as hydrogen sulfide, sulfurous acid, and hydrogen chloride will cause faults and failures.

Note that some organic solvents release corrosive gases.

Equipment Certificate

Anritsu Corporation certifies that this equipment was tested before shipment using calibrated measuring instruments with direct traceability to public testing organizations recognized by national research laboratories, including the National Institute of Advanced Industrial Science and Technology, and the National Institute of Information and Communications Technology, and was found to meet the published specifications.

Anritsu Warranty

Anritsu Corporation will repair this equipment free-of-charge if a malfunction occurs within one year after shipment due to a manufacturing fault, and software bug fixes will be performed in accordance with the separate Software End-User License Agreement, provide, however, that Anritsu Corporation will deem this warranty void when:

- The fault is outside the scope of the warranty conditions separately described in the operation manual.
- The fault is due to mishandling, misuse, or unauthorized modification or repair of the equipment by the customer.
- The fault is due to severe usage clearly exceeding normal usage.
- The fault is due to improper or insufficient maintenance by the customer.
- The fault is due to natural disaster, including fire, wind or flood, earthquake, lightning strike, or volcanic ash, etc.
- The fault is due to damage caused by acts of destruction, including civil disturbance, riot, or war, etc.
- The fault is due to explosion, accident, or breakdown of any other machinery, facility, or plant, etc.
- The fault is due to use of non-specified peripheral or applied equipment or parts, or consumables, etc.
- The fault is due to use of a non-specified power supply or in a non-specified installation location.
- The fault is due to use in unusual environments^(Note).
- The fault is due to activities or ingress of living organisms, such as insects, spiders, fungus, pollen, or seeds.

In addition, this warranty is valid only for the original equipment purchaser. It is not transferable if the equipment is resold.

Anritsu Corporation shall assume no liability for damage or financial loss of the customer due to the use of or a failure to use this equipment, unless the damage or loss is caused due to Anritsu Corporation's intentional or gross negligence.

Note:

For the purpose of this Warranty, "unusual environments" means use:

- In places of direct sunlight
- In dusty places
- Outdoors
- In liquids, such as water, oil, or organic solvents, and medical fluids, or places where these liquids may adhere
- In salty air or in place chemically active gases (sulfur dioxide, hydrogen sulfide, chlorine, ammonia, nitrogen dioxide, or hydrogen chloride etc.) are present
- In places where high-intensity static electric charges or electromagnetic fields are present
- In places where abnormal power voltages (high or low) or instantaneous power failures occur
- In places where condensation occurs
- In the presence of lubricating oil mists
- In places at an altitude of more than 2,000 m
- In the presence of frequent vibration or mechanical shock, such as in cars, ships, or airplanes

Anritsu Corporation Contact

In the event of this equipment malfunctions, please contact an Anritsu Service and Sales office. Contact information can be found on the last page of the printed version of this manual, and is available in a separate file on the PDF version.

Notes On Export Management

This product and its manuals may require an Export License/Approval by the Government of the product's country of origin for re-export from your country.

Before re-exporting the product or manuals, please contact us to confirm whether they are export-controlled items or not.

When you dispose of export-controlled items, the products/manuals need to be broken/shredded so as not to be unlawfully used for military purpose.

Crossed-out Wheeled Bin Symbol

Equipment marked with the Crossed-out Wheeled Bin Symbol complies with council directive 2012/19/EU (the “WEEE Directive”) in European Union.



For Products placed on the EU market after August 13, 2005, please contact your local Anritsu representative at the end of the product's useful life to arrange disposal in accordance with your initial contract and the local law.

Software End-User License Agreement (EULA)

Please carefully read and accept this Software End-User License Agreement (hereafter this EULA) before using (includes executing, copying, installing, registering, etc.) this Software (includes programs, databases, scenarios, etc., used to operate, set, etc., Anritsu electronic equipment, etc.). By using this Software, you shall be deemed to have agreed to be bound by the terms of this EULA, and Anritsu Corporation (hereafter Anritsu) hereby grants you the right to use this Software with the Anritsu specified equipment (hereafter Equipment) for the purposes set out in this EULA.

Article 1. Grant of License and Limitations

1. You may not to sell, transfer, rent, lease, lend, disclose, sublicense, or otherwise distribute this Software to third parties, whether or not paid therefor.
2. You may make one copy of this Software for backup purposes only.
3. You are not permitted to reverse engineer, disassemble, decompile, modify or create derivative works of this Software.
4. This EULA allows you to install one copy of this Software on one piece of Equipment.

Article 2. Disclaimers

To the extent not prohibited by law, in no event shall Anritsu be liable for direct, or any incidental, special, indirect or consequential damages whatsoever, including, without limitation, damages for loss of profits, loss of data, business interruption or any other commercial damages or losses, and damages claimed by third parties, arising out of or related to your use or inability to use this Software, unless the damages are caused due to Anritsu's intentional or gross negligence.

Article 3. Limitation of Liability

1. If a fault (bug) is discovered in this Software, failing this Software to operate as described in the operation manual or specifications even though you have used this Software as described in the manual, Anritsu shall at its own discretion, fix the bug, or replace the software, or suggest a workaround, free-of-charge, provided, however, that the faults caused by the following items and any of your lost or damaged data whatsoever

shall be excluded from repair and the warranty.

- i) If this Software is deemed to be used for purposes not described in the operation manual or specifications.
 - ii) If this Software has been used in conjunction with other non-Anritsu-approved software.
 - iii) If this Software or the Equipment has been modified, repaired, or otherwise altered without Anritsu's prior approval.
 - iv) For any other reasons out of Anritsu's direct control and responsibility, such as but not limited to, natural disasters, software virus infections, or any devices other than this Equipment, etc.
2. Expenses incurred for transport, hotel, daily allowance, etc., for on-site repairs or replacement by Anritsu engineers necessitated by the above faults shall be borne by you.
 3. The warranty period for faults listed in Section 1 of this Article shall be either 6 months from the date of purchase of this Software or 30 days after the date of repair or replacement, whichever is longer.

Article 4. Export Restrictions

You shall not use or otherwise export or re-export directly or indirectly this Software except as authorized by the laws and regulations of Japan and the United States, etc. In particular, this Software shall not be exported or re-exported (a) into any Japan or US embargoed countries or (b) to anyone restricted by the Japanese export control regulations, or the US Treasury Department's list of Specially Designated Nationals or the US Department of Commerce Denied Persons List or Entity List. In using this Software, you warrant that you are not located in any such embargoed countries or on any such lists. You also agree that you will not use or otherwise export or re-export this Software for any purposes prohibited by the Japanese and US laws and regulations, including, without limitation, the development, design and manufacture or production of missiles or nuclear, chemical or biological weapons of mass destruction, and conventional weapons.

Article 5. Change of Terms

Anritsu may change without your approval the terms of this EULA if the changes are for the benefit of general customers, or are reasonable in light of the purpose of this EULA and circumstances of the changes. At the time of change, Anritsu will inform you of those changes and its effective date, as a general rule 45 days, in advance on its website, or in writing or by e-mail.

Article 6. Termination

1. Anritsu may terminate this EULA immediately if you violate any conditions described herein. This EULA shall also be terminated immediately by Anritsu if there is any good reason that it is deemed difficult to continue this EULA, such as your violation of Anritsu copyrights, patents, etc. or any laws and ordinances, or if it turns out that you belong to an antisocial organization

or has a socially inappropriate relationship with members of such organization.

2. You and Anritsu may terminate this EULA by a written notice to the other party 30 days in advance.

Article 7. Damages

If Anritsu suffers any damages or loss, financial or otherwise, due to your violation of the terms of this EULA, Anritsu shall have the right to seek proportional damages from you.

Article 8. Responsibility after Termination

Upon termination of this EULA in accordance with Article 6, you shall cease all uses of this Software immediately and shall as directed by Anritsu either destroy or return this Software and any backup copies, full or partial, to Anritsu.

Article 9. Negotiation for Dispute Resolution

If matters of interpretational dispute or items not covered under this EULA arise, they shall be resolved by negotiations in good faith between you and Anritsu.

Article 10. Governing Law and Court of Jurisdiction

This EULA shall be governed by and interpreted in accordance with the laws of Japan without regard to the principles of the conflict of laws thereof, and any disputes arising from or in relation to this EULA that cannot be resolved by negotiation described in Article 9 shall be subject to and be settled by the exclusive agreed jurisdiction of the Tokyo District Court of Japan.

Revision History:

February 29th, 2020

Cautions Against Computer Virus Infection

- Copying files and data
Only files that have been provided directly from Anritsu or generated using Anritsu equipment should be copied to the instrument.
All other required files should be transferred by means of USB flash drive or CompactFlash media after undergoing a thorough virus check.
- Adding software
Do not download or install software that has not been specifically recommended or licensed by Anritsu.
- Network connections
Ensure that the network has sufficient anti-virus security protection in place.
- Protection against malware (malicious software such as viruses).
This equipment runs on Windows Operating System.
To connect this equipment to network, the following is advised.
 - Activate Firewall.
 - Install important updates of Windows.
 - Use antivirus software.

CE Conformity Marking

Anritsu affixes the CE conformity marking on the following product in accordance with the Decision 768/2008/EC to indicate that it conforms to the EMC, LVD, and RoHS directive of the European Union (EU).

CE marking



1. Product Model

Model: MS9740B Optical Spectrum Analyzer

2. Applied Directive

EMC: Directive 2014/30/EU

LVD: Directive 2014/35/EU

RoHS: Directive 2011/65/EU, (EU) 2015/863

3. Applied Standards

- EMC: Emission: EN 61326-1: 2013 (Class A)
Immunity: EN 61326-1: 2013 (Table 2)

	Performance Criteria*
IEC 61000-4-2 (ESD)	B
IEC 61000-4-3 (EMF)	A
IEC 61000-4-4 (Burst)	B
IEC 61000-4-5 (Surge)	B
IEC 61000-4-6 (CRF)	A
IEC 61000-4-8 (RPFMF)	A
IEC 61000-4-11 (V dip/short)	B, C

*: Performance Criteria

A: The equipment shall continue to operate as intended during and after the test. No degradation of performance or loss of function is allowed below a performance level specified by the manufacturer, when the equipment is used as intended. The performance level may be replaced by a permissible loss of performance. If the minimum performance level or the permissible performance loss is not specified by the manufacturer, either of these may be derived from the product description and documentation and what the user may reasonably expect from the equipment if used as intended.

- B: The equipment shall continue to operate as intended after the test. No degradation of performance or loss of function is allowed below a performance level specified by the manufacturer, when the equipment is used as intended. The performance level may be replaced by a permissible loss of performance. During the test, degradation of performance is however allowed. No change of actual operating state or stored data is allowed. If the minimum performance level or the permissible performance loss is not specified by the manufacturer, either of these may be derived from the product description and documentation and what the user may reasonably expect from the equipment if used as intended.
- C: Temporary loss of function is allowed, provided the function is self-recoverable or can be restored by the operation of the controls.

Harmonic current emissions:

EN 61000-3-2: 2014 (Class A equipment)

No limits apply to this equipment with an active input power under 75 W.

- LVD: EN 61010-1: 2010 (Pollution Degree 2)
- RoHS: EN IEC 63000:2018 (Category 9)

If the third digit of the serial number is "7", the product complies with Directive 2011/65/EU as amended by (EU) 2015/863.

(Pb,Cd,Cr6+,Hg,PBB,PBDE,DEHP,BBP,DBP,DIBP)

If the third digit of the serial number is "6", the product complies with Directive 2011/65/EU.

(Pb,Cd,Cr6+,Hg,PBB,PBDE)

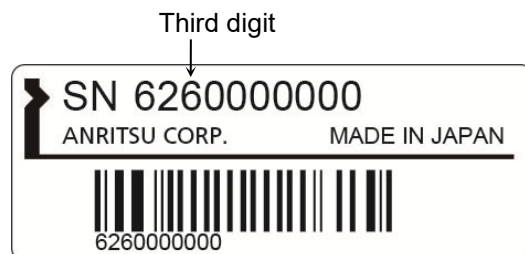

Serial number example

4. Contact

Name: Anritsu GmbH
 Address, city: Nemetschek Haus, Konrad-Zuse-Platz 1
 81829 München,
 Country: Germany

UKCA Marking

Anritsu affixes the UKCA marking on the following product in accordance with the guidance to indicate that it conforms to the EMC, LVD, and RoHS regulations in the United Kingdom.

UKCA marking



1. Product Model

Model: MS9740B Optical Spectrum Analyzer

2. Applied Regulations

EMC: S.I. 2016 No. 1091

LVD: S.I. 2016 No. 1101

RoHS: S.I. 2012 No. 3032

3. Applied Standards

- EMC: Emission: EN 61326-1: 2013 (Class A)
Immunity: EN 61326-1: 2013 (Table 2)
- LVD: EN 61010-1: 2010 (Pollution Degree 2)
- RoHS: EN IEC 63000: 2018 (Category 9)

4. Contact

Name: ANRITSU EMEA Ltd.
Address, city: 200 Capability Green, Luton
Bedfordshire, LU1 3LU
Country: United Kingdom

RCM Conformity Marking

Anritsu affixes the RCM mark on the following product in accordance with the regulation to indicate that it conforms to the EMC framework of Australia/New Zealand.

RCM marking



1. Product Model

Model: MS9740B Optical Spectrum Analyzer

2. Applied Standards

EMC: Emission: EN 61326-1: 2013 (Class A equipment)

About Eco label



The label shown on the left is attached to Anritsu products meeting our environmental standards.

Details about this label and the environmental standards are available on the Anritsu website at <https://www.anritsu.com>

About This Manual

This manual explains the usage precautions, product outline, product layout, panel operations, performance tests, calibration, and maintenance of the MS9740B Optical Spectrum Analyzer (hereafter, MS9740B).

For remote control of the MS9740B Optical Spectrum Analyzer via a PC, refer to the MS9740B Optical Spectrum Analyzer Remote Control Operation Manual (W3999AE).

This manual is configured by the following structures: Chapter 1 through 7 and Appendixes. Read Chapter 1 through 3, Chapter 6 and 7 before using this equipment. For Chapter 4 and 5, read them as needed.

Chapter 1 Outline

This chapter explains the outline and main uses of the Optical Spectrum Analyzer and technical terms used in this manual.

Chapter 2 Before Use

This chapter explains the setting items, cable connections, character string format controlling the MS9740B, register configuration displaying the MS9740B status, and sync control. It also explains unpacking after purchase, names of each part, and procedures up to power-on.

Chapter 3 Measurement

This chapter explains the measurement method using the panel keys.

Chapter 4 Changing Measurement Conditions

This chapter explains how to set the measurement conditions using the function keys. The analysis function is explained in Chapter 5.

Chapter 5 Measurement Functions

The MS9740B has separate functions for measuring laser diodes, optical amplifiers, PMD, etc. This section explains the operation method for each of these functions.

Chapter 6 Setting Operating Environment

This chapter explains various MS9740B settings, such as remote control and file saving, as well as how to confirm system information and upgrade firmware.

Chapter 7 Performance Test and Maintenance

This chapter explains how to calibrate the MS9740B and test performance. It also explains daily maintenance, connector cleaning, storage precautions, etc.

This manual assumes the reader has some basic knowledge about optical communications, handling optical parts, Windows file operations and the Windows Control Panel.

Manual Notation System

The MS9740B Optical Spectrum Analyzer is abbreviated MS9740B in this manual.

The names of panel and function keys are in bold.

Example: **Center**, **f1** **λMkr A**:

Table of Contents

For Safety	iii
-------------------------	------------

About This Manual	I
--------------------------------	----------

Chapter 1 Outline	1-1
--------------------------------	------------

1.1 Introduction of Optical Spectrum Analyzer	1-2
1.2 Intended Use	1-6
1.3 Glossary	1-7

Chapter 2 Before Use	2-1
-----------------------------------	------------

2.1 Unpacking and Installation	2-2
2.2 Part Names.....	2-5
2.3 Power Connection.....	2-8
2.4 Connecting Peripheral Devices	2-10
2.5 Connecting Remote Control Devices.....	2-11
2.6 Cautions on Handling Optical Fiber Cables	2-12
2.7 Precautions at Measurement.....	2-14
2.8 Turning Power On/Off	2-18
2.9 Setting Control Panel	2-21
2.10 Windows Security Measures	2-29
2.11 Configuring Storage Media.....	2-44
2.12 Screen Names	2-45

Chapter 3 Measurement.....	3-1
-----------------------------------	------------

3.1 Calibrating Before Measurement	3-2
3.2 Connecting DUT	3-11
3.3 Inputting Data	3-12
3.4 Measurement Types	3-13
3.5 Changing Wavelength and Resolution.....	3-14
3.6 Setting Level Scale	3-15
3.7 Using Markers.....	3-16
3.8 Saving and Reading Data	3-22
3.9 Initializing Measurement Conditions	3-27

3.10	Releasing Panel Lock	3-28
------	----------------------------	------

Chapter 4 Changing Measurement

	Conditions.....	4-1
4.1	Wavelength-related Settings	4-2
4.2	Setting Level Display.....	4-5
4.3	Changing Data Capturing Method	4-7
4.4	Displaying Level Peaks and Dips	4-11
4.5	Analyzing Waveform	4-13
4.6	Changing Waveform Memory Settings and Calculation between Memories.....	4-22
4.7	Changing Measurement Mode	4-27
4.8	Inputting Title to Waveform Data	4-31
4.9	Using Light Source Option	4-32

Chapter 5 Measurement Functions 5-1

5.1	Measuring DFB-LD (Distributed Feedback Laser Diode).....	5-3
5.2	Measuring FP-LD (Fabry-Perot Laser Diode)	5-7
5.3	Measuring LED (Light Emitting Diode).....	5-10
5.4	Measuring PMD (Polarization Mode Dispersion).....	5-13
5.5	Measuring WDM (Wavelength Division Multiplexed) Signals.....	5-17
5.6	Measuring Laser Diode Modules	5-33
5.7	Measuring Optical Amplifier.....	5-47
5.8	Measuring Optical Amplifier (Wavelength Division Multiplex)	5-67
5.9	Measuring WDM Filter	5-86

Chapter 6 Setting Operating Environment 6-1

6.1	Setting and Checking Instrument Data	6-2
6.2	Managing Files	6-9
6.3	Updating Software	6-11

Chapter 7 Performance Test and Maintenance7-1

7.1	Calibration	7-2
7.2	Performance Test	7-3
7.3	Replacement of Optical Connector.....	7-8
7.4	Optical Connector/Optical Adapter Cleaning.....	7-10
7.5	Daily Maintenance	7-14
7.6	Cautions on Storage MS9740B for Extended Period .	7-15
7.7	Transporting and Disposal	7-16
7.8	Troubleshooting	7-17

Appendix A Specifications A-1

Appendix B Initial Values B-1

Appendix C Message List..... C-1

Appendix D Keyboard and Mouse Operations D-1

Appendix E Video Band Width and Sweep Time.....E-1

Appendix F Performance Test Result Form F-1

Appendix G Excel Macro G-1

Appendix H Bibliography H-1

IndexIndex-1

Chapter 1 Outline

This chapter introduces the optical spectrum analyzer, explains its intended use, and lists technical terms and abbreviations.

1.1	Introduction of Optical Spectrum Analyzer.....	1-2
1.1.1	Description of Optical Spectrum Analyzer.....	1-2
1.1.2	Feature	1-4
1.2	Intended Use	1-6
1.3	Glossary	1-7

1.1 Introduction of Optical Spectrum Analyzer

1.1.1 Description of Optical Spectrum Analyzer

The MS9740B Optical Spectrum Analyzer (hereafter, MS9740B) measures the power distribution (spectrum) of optical wavelengths. Figure 1.1.1-1 shows a measurement example.

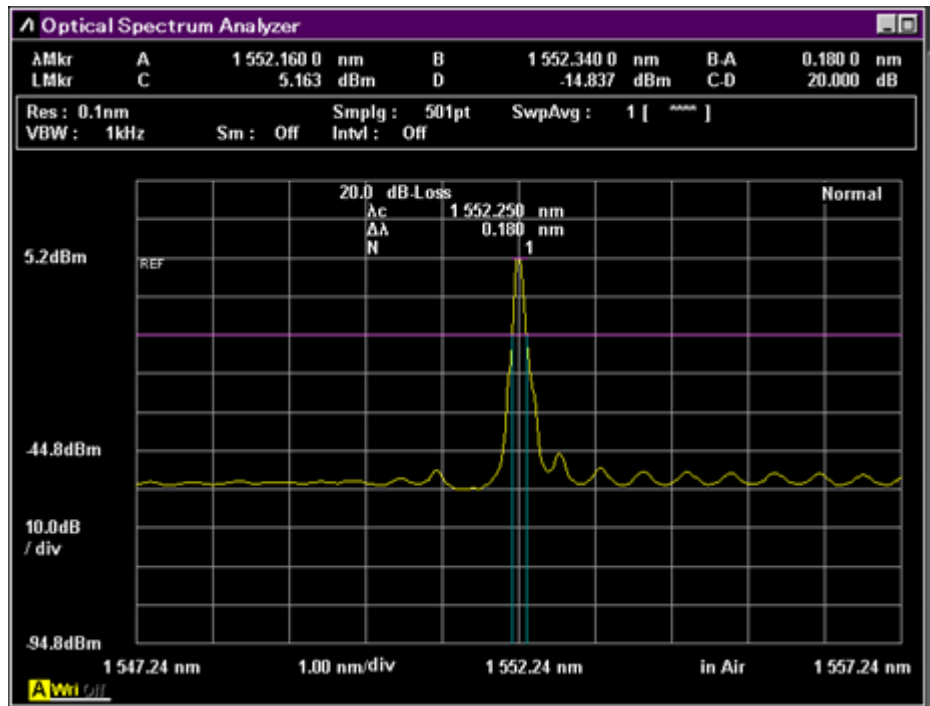

Figure 1.1.1-1 Measurement Example of Optical Spectrum Analyzer

The horizontal axis indicates the wavelength only. The marker position and analysis result indicate the wavelength or frequency.

The vertical axis indicates the power or relative values. The relative value is the ratio assuming that the measurement value with the maximum power is 100%. The scale can be changed to linear or logarithm.

The scale unit is as follows.

Horizontal axis	Wavelength	nm (nanometer)	1 nm = 10 ⁻⁹ m
	Frequency	THz (terahertz)	1 THz = 10 ¹² Hz
Vertical axis	Linear scale, normal value state	W (watt),	
		mW (milliwatt)	1 mW = 10 ⁻³ W,
		μW (microwatt)	1 μW = 10 ⁻⁶ W,
		nW (nanowatt)	1 nW = 10 ⁻⁹ W,
	pW (picowatt)	1 pW = 10 ⁻¹² W	
Linear scale, relative value state	% (percentage)		
	Logarithm scale, normal value state	dBm	
	Logarithm scale, relative value state	dB (decibel)	

The frequency indication of horizontal axis is compatible with the marker location and analysis result.

dBm is an abbreviation for the power ratio in dB of the measured power referenced to 1 mW. The conversion formula of P₁ (mW) and P₂ (dBm) is as follows.

$$P_2 = 10 \cdot \log(P_1)$$

dB is the logarithm of the ratio. The conversion formula of R₁ (%) and R₂ (dB) is as follows.

$$R_2 = 10 \cdot \log\left(\frac{R_1}{100}\right)$$

The optical wavelength varies with the Index of Refraction n. The relationship between the wavelength in a vacuum λ_v and in air λ_a is as follows.

$$\lambda_a = \frac{\lambda_v}{n}$$

The horizontal axis can be switched to display wavelength either in a vacuum or in air.

For more information, refer to 4.1 “Wavelength-related Settings”.

1.1.2 Feature

The MS9740B is an optical spectrum analyzer that uses a diffraction grating to analyze the optical spectrum of light in the wavelength range of 600 to 1750 nm. In addition to measuring the spectrum of LDs, LEDs, etc., it also has functions for measuring loss of passive elements, such as optical isolators, and the noise figure and gain of fiber amplifier systems. It adds excellent stability and reliability to the basic functions of a spectrum analyzer and also features improved performance such as high dynamic range, superior Rx sensitivity, fast sweep speed based on Anritsu's long experience in these technologies. The MS9740B is the ideal analyzer for monitoring production of optical parts and optical communications circuits.

MS9740B allows setting VBW at 1kHz Fast and at 200 Hz Fast that enable faster sweeps than those by the existing MS9740A.

The adoption of Windows improved the data management and interface convenience of MS9740B. In addition to high reliability and excellent basic functions, it also has various applications to support users with faster and more accurate measurements.

Basic features:

- Supports both single mode (SM) and multimode (MM) fibers (50/125 μm)
Supports also multimode fiber (62.5/125 μm) when MS9740B-009 is installed.
- High-speed measurement with sweep times of 350 ms/30 nm (VBW, 1kHz Fast)
- High wavelength accuracy of ± 20 pm (WDM wavelength band, when MS9740B-002 Light Source for Wavelength Calibration is installed)
- Dynamic range of 42 dB (0.2 nm from peak wavelength) and 70 dB (1 nm from peak wavelength) (in High Dynamic Range Mode)
- High resolution of 0.03 nm (1550 nm band)
- Rx Sensitivity of -90 dBm (1 pW)
- Optical input of $+23$ dBm (200 mW) max.

Table 1.1.2-1 Abundant Features

Item	Function	References
Trace	Displays up to 10 waveform traces and calculates between waveforms Max. Hold, Min. Hold functions	Refer to 4.6 “Changing Waveform Memory Settings and Calculation between Memories”.
Device Analysis	Wavelength analysis and evaluation of optical elements (DFB-LD, FP-LD, LED, LD)	Refer to Chapter 5 “Measurement Functions”.
Wavelength Analysis	Center wavelength, spectrum analysis and side mode suppression ratio (SMSR) measurements using RMS, threshold, envelope and ndB Loss methods	Refer to 4.5 “Analyzing Waveform”.
Measurements	NF and gain of EDFA, PMD, CW and spectrum of optical elements	Refer to Chapter 5 “Measurement Functions”.
Modulation/Pulse Measurement	1 MHz VBW	Refer to 4.7 “Changing Measurement Mode”.
Markers	Trace, Delta, Wavelength, Level Zone: Wavelength analysis in specified zone Peak/Dip Search: Search for peak and dip points	Refer to 3.7 “Using Markers”.
Power Monitor	Optical power meter function	Refer to 4.7 “Changing Measurement Mode”.
Wavelength in Vacuum Display	Displays measured wavelength as value in vacuum	Refer to 4.1 “Wavelength-related Settings”.
External I/F	Remote Control: Ethernet, GPIB (option) USB (mouse, keyboard, and memory), VGA monitor out	Refer to 2.9 “Setting Control Panel” and Chapter 6 “Setting Operating Environment”.
Averaging	Point averaging (per measured wavelength), Sweep averaging (per sweep), Smoothing	Refer to 4.3 “Changing Data Capturing Method”.

1.2 Intended Use

The main uses of optical spectrum measurements are listed below:

- Evaluation of optical devices such as laser diodes, optical diodes, optical transceivers, etc.
- Evaluation of active devices such as optical amplifiers
- Loss evaluation of passive devices such as optical fibers, optical couplers, optical isolators, optical filters, etc.
- Monitoring signal level and wavelength of communications circuits

The standards for public communications, LANs, etc., specify the wavelength to be used. As a result, devices used in these circuits must meet these standards, which requires measurement of the optical spectrum and loss of these devices.

For example, in optical communications using multiplexing of several different wavelengths in one optical fiber (WDM) must be monitored by accurate measurement of the level and wavelength of each part of the multiplexed signal. This is achieved by measuring the optical spectrum in the optical circuit.

The MS9740B has the functions and performance needed to make parts evaluation, WDM communication, and etc. For a detailed explanation of these measurements, refer to Chapter 5 “Measurement Functions”.

1.3 Glossary

This section explains the technical terms used in this manual.

External Trigger

This function synchronizes measurement of waveform data points with input triggers pulses. It is used when measuring modulated light. For an explanation of the external trigger, refer to 4.7 “Changing Measurement Mode”.

Accuracy

Displayed measured values include some errors and the wavelength and level displayed by MS9740B also include errors. The maximum error guaranteed for the MS9740B used under fixed conditions is called the accuracy.

Calibration

To minimize errors, the MS9740B has a calibration function that adjusts the internal optical systems using a light source with a known wavelength and level by subtracting the difference between the calibration value and the measured value. For an explanation of calibration, refer to 3.1 “Calibrating Before Measurement” and 7.1. “Calibration”.

Sweep Speed Time

Sweep time is the time required to start measurement and write the results to the screen. The sweep time of the MS9740B depends on the measurement conditions such as the Rx bandwidth, number of averaging as well as on the waveform shape.

Video Band Width (VBW)

VBW (Video Band Width) is the bandwidth of the internal received amplifier.

Narrowing the VBW helps suppress noise in measurements.

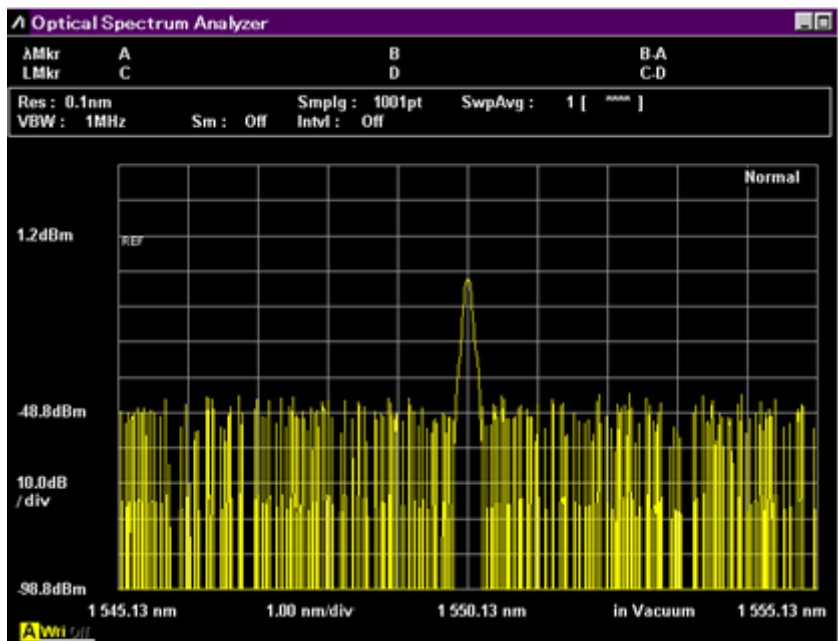

Figure 1.3-1 Example of Measurement at VBW 1 MHz

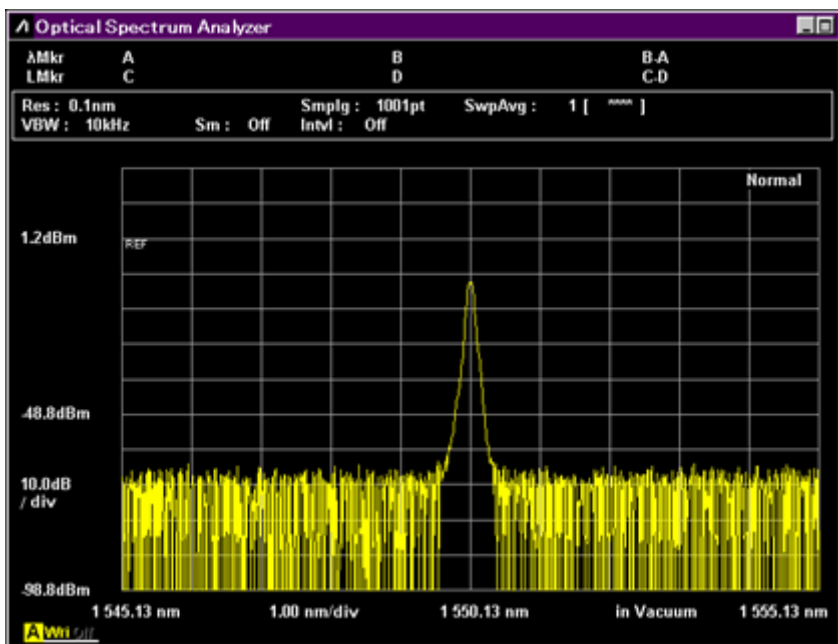

Figure 1.3-2 Example of Measurement at VBW 10kHz

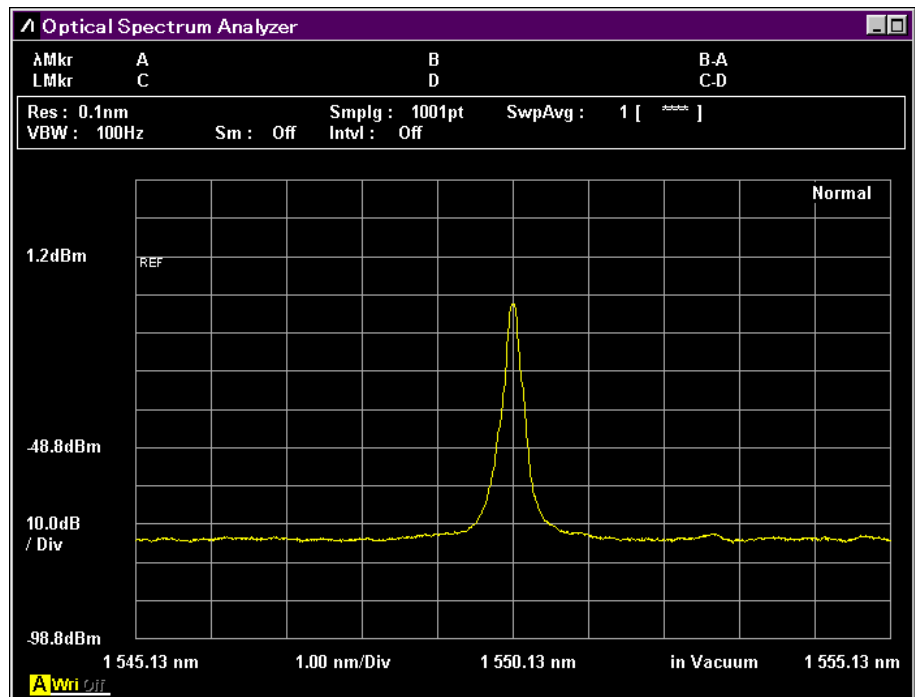

Figure 1.3-3 Example of Measurement at VBW 100Hz

When measuring intense modulated light using an external trigger, set the value of VBW to a higher value than the modulation signal. If the VBW value is lower than the modulation frequency, the level is not measured accurately.

Measured Level Range

The measured level range is the maximum and minimum levels that the analyzer can measure. It depends on the wavelength due to the characteristics of the analyzer's internal optical systems. In addition, the minimum level is very much impacted by internal electrical noise. A narrow VBW and smoothing/ averaging processing reduce the impact of this noise.

Dynamic Range

Near the wavelengths of input lights, the detectable level is limited by the effect of the lights. Dynamic range is the ratio between the maximum level of this input optical spectrum and the detectable optical level. Figure 1.3-4 shows the definition of dynamic range.

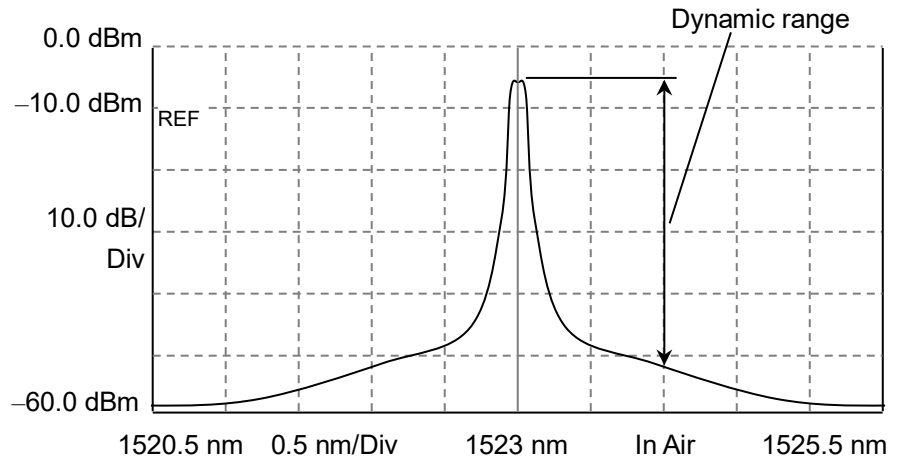

Figure 1.3-4 Definition of Dynamic Range

Waveform Analysis

This is a function for analyzing and displaying measured waveform data. The center wavelength and spectrum half width measurement are given as an example of waveform analysis. Refer to 4.5 “Analyzing Waveform” for an explanation of this measurement analysis function.

Waveform Calculation

This is a function for calculating between two waveforms. It is used to measure loss characteristics of optical parts. Refer to 4.6 “Changing Waveform Memory Settings and Calculation between Memories” for an explanation of this function.

Wavelength Resolution

Wavelength resolution (Res) is the ability to separate two adjacent optical wavelengths. Figure 1.3-5 thru Figure 1.3-7 show the changes in half-width when changing the resolution, if measuring a light source with a narrow spectrum such as a laser. The resolution must be set depending on the required measurement wavelength resolution. The actual resolution displayed on the screen is determined by integrating the levels of the optical spectrum of single wavelength light source with sufficiently narrow linewidth compared with resolution of the MS9740B and dividing by the peak level. The values used in the calculation are the defaults values at factory shipment or the values measured by executing resolution calibration. For the resolution calibration method, refer to 3.1 “Calibrating Before Measurement”.

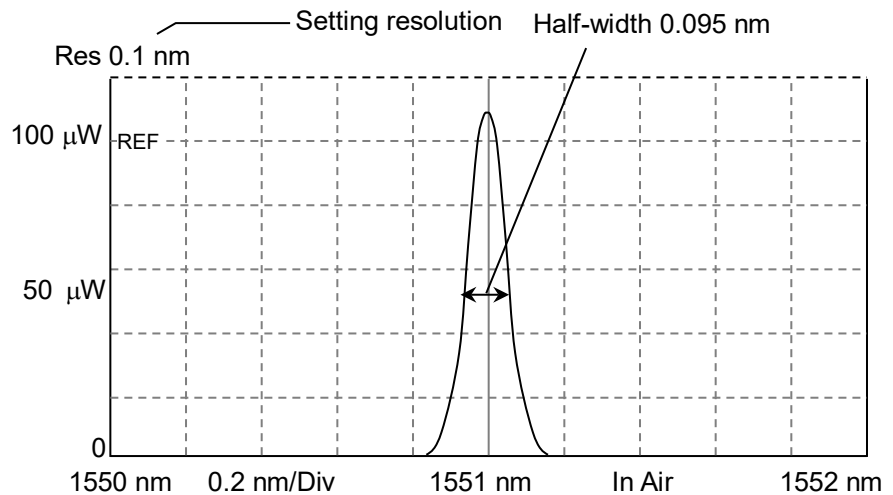

Figure 1.3-5 Measurement Example of Resolution 0.1 nm

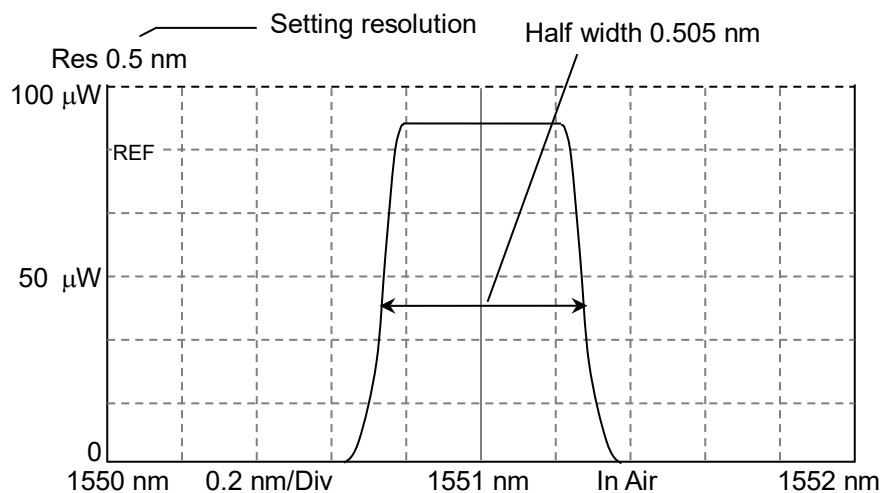

Figure 1.3-6 Measurement Example of Resolution 0.5 nm

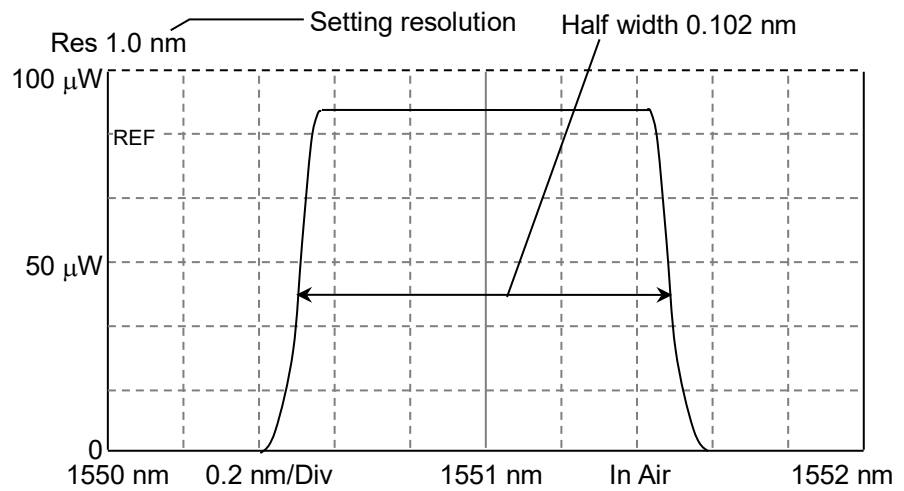

Figure 1.3-7 Measurement Example of Resolution 1.0 nm

Remote Control

This is a function for sending commands from a PC to the MS9740B via the Ethernet or GPIB (Option) interface to change the measurement conditions and to send the measurement results from the MS9740B to the PC. Refer to *MS9740B Optical Spectrum Analyzer Remote Control Operation Manual* for details of the remote control function.

Monochromator

This is a device for splitting the light into each wavelength. The MS9740B uses a diffraction grating as a device to split light.

The abbreviations used in this manual and on the analyzer panels and screens are listed in Table 1.3-1.

Table 1.3-1 Abbreviations

Abbreviation	Formal Name
Act-Res	Actual Resolution
Align	Alignment
Amp	Amplifier
APC	Angled Physical Contact
ASE	Amplified Spontaneous Emission
Att	Attenuator
Avg	Average
BPF	Band Pass Filter
BS	Back Space
BW	Band Width
Cal	Calibration
Cal	Calculate
CFR	Code of Federal Regulation
Config	Configuration
CSV	Comma Separated Value
CW	Continuous Wave
D.Range	Dynamic Range
Dens	Density
DFB-LD	Distribution Feedback Laser Diode
Diff	Difference
Div, div	Division
DUT	Device under test
Ext	External
FP-LD	Fabry-Perot Laser Diode
Freq, Frq	Frequency
FWHM	Full Width at Half Maximum
GI	Graded Index
GPIB	General Purpose Interface Bus
IEC	International Electrotechnical Commission
Info	Information
Init	Initialize
Int	Internal
Intvl	Interval
ITU	International Telecommunication Union
LD	Laser Diode
LED	Light Emitting Diode
Lvl	Level

Table 1.3-1 Abbreviation (Cont'd)

Abbreviation	Formal Name
LMker	Level Marker
Log	Logarithm
Max	Maximum
Min	Minimum
Mkr	Marker
Mode Cpl	Mode Coupling
NF	Noise Figure
No	Number
Opt	Optical
OSNR	Optical Signal to Noise Ratio
Ovl	Overlap
PC	Physical Contact
Pk	Peak
PLZN	Polarization
PMD	Polarization Mode Dispersion
Pol	Polarizer
POLY	Polynomial equation
Pow	Power
Prmtr	Parameter
pt	Points
PtAvg	Point Average
Ref	Reference
Res	Resolution
RMS	Root Mean Square
S.Lvl	Slice Level
SM	Single Mode
Smplg	Sampling
SMSR	Side Mode Suppression Ratio
SNR	Signal to Noise Ratio
SwpAvg	Sweep Average
TMkr	Trace Marker
Trig	Trigger
Uncal	Un-calibrated
USB	Universal Serial Bus
Vac	Vacuum
VBW	Video Band Width
WDM	Wavelength Division Multiplexing
Wl	Wavelength
XML	Extended Markup Language
Wri	Write

Chapter 2 Before Use

This chapter describes the procedures from how to unpack the package through how to turn on the power, basic information about parameter and screen names, and function configurations.

2.1	Unpacking and Installation	2-2
2.1.1	Unpacking.....	2-2
2.1.2	Installation.....	2-3
2.2	Part Names.....	2-5
2.2.1	Front Panel	2-5
2.2.2	Rear Panel.....	2-6
2.3	Power Connection.....	2-8
2.3.1	Power Requirements.....	2-8
2.3.2	Connecting Power Cord	2-9
2.4	Connecting Peripheral Devices	2-10
2.5	Connecting Remote Control Devices.....	2-11
2.6	Cautions on Handling Optical Fiber Cables	2-12
2.7	Precautions at Measurement.....	2-14
2.8	Turning Power On/Off	2-18
2.8.1	Power-on	2-18
2.8.2	Power-off	2-19
2.9	Setting Control Panel	2-21
2.9.1	Displaying Windows Desktop	2-21
2.9.2	Confirming Windows Version.....	2-22
2.9.3	Setting Control Panel	2-24
2.9.4	Using external display	2-25
2.10	Windows Security Measures	2-29
2.10.1	Installing Windows Important Update Programs (Windows Update).....	2-30
2.10.2	Using Antivirus Software	2-34
2.10.3	Restoring Hard Disk Drive.....	2-35
2.11	Configuring Storage Media.....	2-44
2.12	Screen Names	2-45

2.1 Unpacking and Installation

2.1.1 Unpacking

Table 2.1.1-1 lists the standard configurations of the MS9740B. At unpacking, check that all items are included. Contact your Anritsu Service and Sales Office or agent if any parts are missing or damaged.

Table 2.1.1-1 Standard Configurations

Item	Model	Product Name	Q'ty	Remarks
Main unit	MS9740B	Optical Spectrum Analyzer	1	
Accessories	Z2024A	Power Cord (2.6 m)	1	Packed in Accessory Box
		MS9740B Operation Manual (CD)*	1	
		TAA-1CT140003 Microsoft Software License Terms (WES7)	1	

*: The CD includes two MS9740B Optical Spectrum Analyzer Operation Manuals: Mainframe and Remote Control.

Options for the MS9740B listed in Table 2.1.1-2 are provided. Select one, as you need. The MS9740B might be returned to Anritsu Service and Sales Office for installing some options. For the specifications, refer to Appendix A "Specifications".

Table 2.1.1-2 Options

Model	Name	Remarks
MS9740B-001 MS9740B-101*1 MS9740B-201*2	GPIO Interface	Interface used at remote control Controls MS9740B via GPIO connector on rear-panel
MS9740B-002 MS9740B-102*1 MS9740B-202*2	Light Source for Waveform Calibration	Light source for wavelength calibration Calibrates wavelength to within ± 20 pm
MS9740B-108*1 MS9740B-208*2	OS Upgrade to Win10 Retrofit	Options to upgrade the OS from Windows Embedded Standard 7 to Windows 10 IoT
MS9740B-037 MS9740B-038 MS9740B-039 MS9740B-040	FC ST DIN SC	Standard option 037 All available as PC types (spherical polishing)

*1: Must be returned to Anritsu (Japan) when installing.

*2: Must be returned to an Anritsu Service office when installing.

The option number of the added option is indicated on the label on the rear panel.

2.1.2 Installation

Install the MS9740B horizontally as shown in Figure 2.1.2-1.

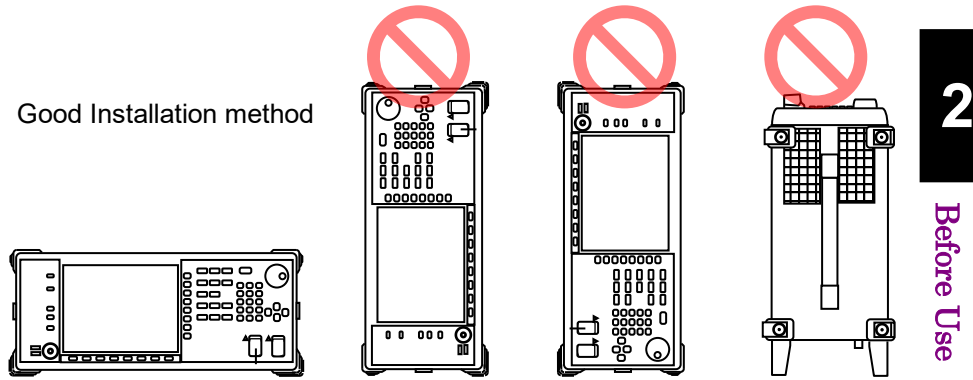

Figure 2.1.2-1 Installation Orientation



CAUTION

If the MS9740B is not installed in a “good” direction as above, a small shock may turn it over and harm the user.

A fan is installed in the MS9740B to prevent the internal temperature from rising. Place the MS9740B in a location with the vents at least 10 cm away from walls, peripherals or other obstructions so as not to block the fan perimeter.

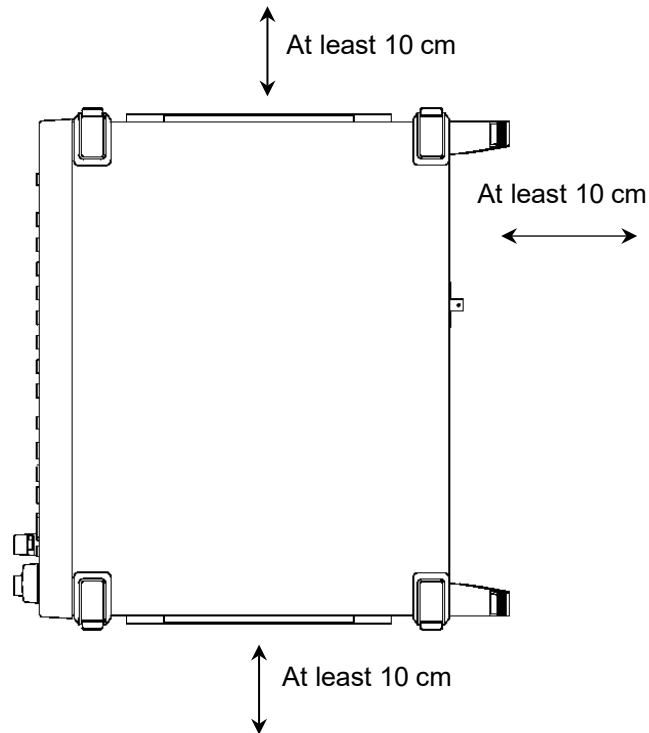

Figure 2.1.2-2 Distance from Surrounding Objects

Although the MS9740B operates at an ambient temperature of 5 to 45°C, avoid using it in locations, such as the following, since it may cause failures.

- Locations with strong vibrations
- Humid and dusty locations
- Locations with direct sunlight
- Locations where there is the risk of exposure to active gases
- Locations where power voltage severely fluctuates
- Locations where there is a risk of equipment toppling over, etc.

2.2 Part Names

2.2.1 Front Panel

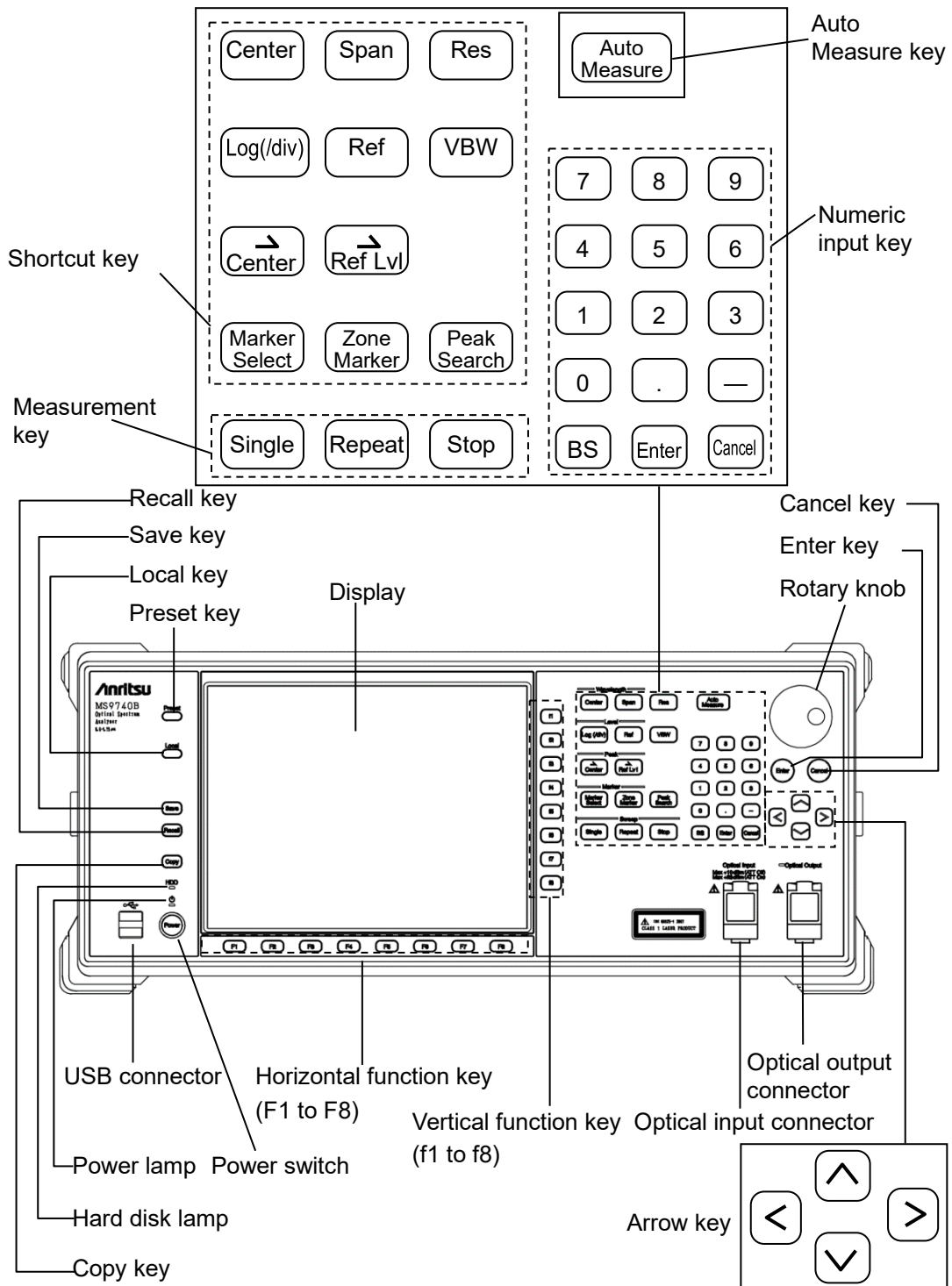
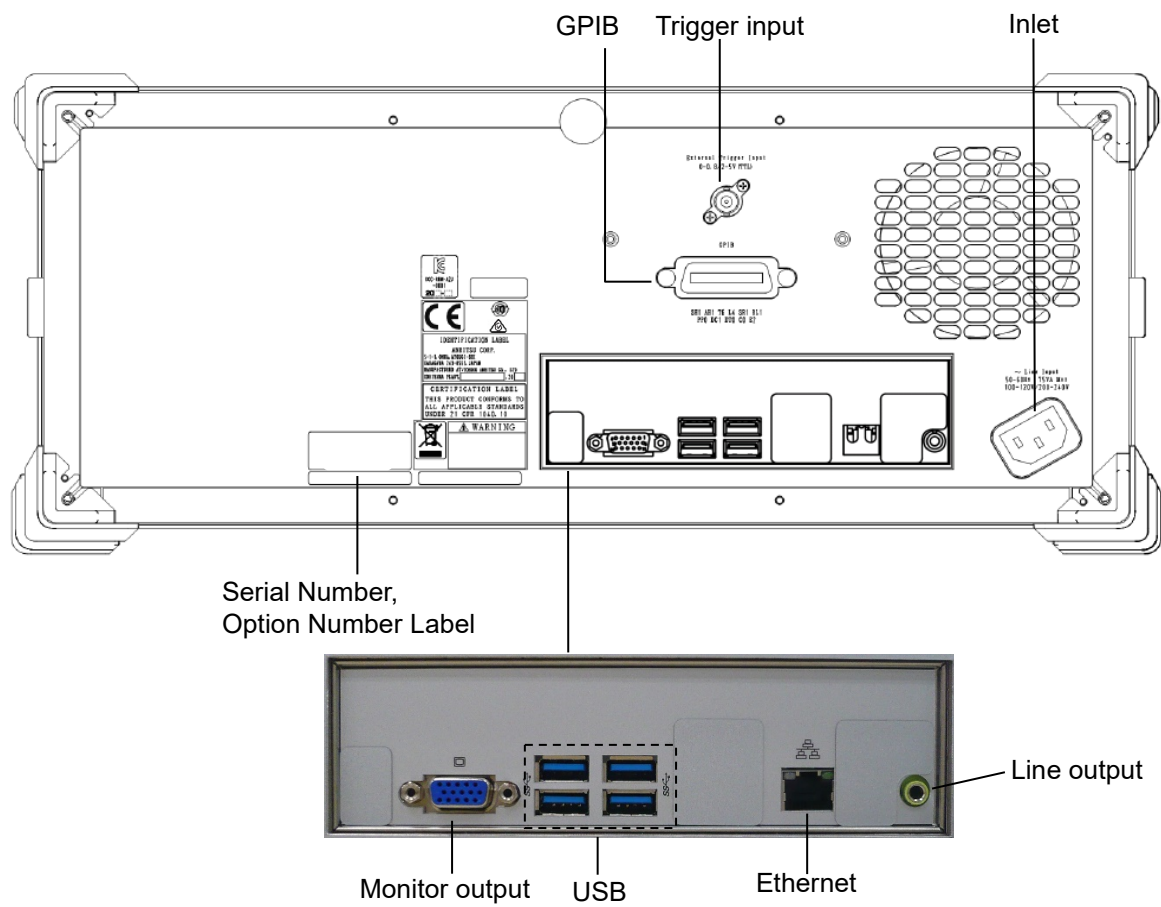

Figure 2.2.1-1 Front Panel

Panel keys can also be operated from the keyboard. Refer to Appendix D “Keyboard and Mouse Operations”.



2

Before Use

Figure 2.2.2-2 Rear Panel (MS9740B-108 and MS9740B-208)

2.3 Power Connection

This section describes the procedures for supplying power.

For your safety, read the following operating procedures before turning on the MS9740B.

2.3.1 Power Requirements

For normal operation of the MS9740B, use the power voltage range described below.

Power source	Voltage range	Frequency
100 Vac system	100 to 120 V	50 to 60 Hz
200 Vac system	200 to 240 V	50 to 60 Hz

Switching between 100 and 200 V systems is automatic.



CAUTION

Supplying power exceeding the above range may result in electrical shock, fire, failure, or malfunction.

2.3.2 Connecting Power Cord

Insert the power plug into an outlet, and connect the other end to the power inlet on the rear panel. To ensure that the instrument is earthed, always use the supplied 3-pin power cord, and insert the plug into an outlet with an earth terminal.

WARNING

Always connect the instrument to a properly grounded outlet. Do not use the instrument with an extension cord or transformer that does not have a ground wire.

If the instrument is connected to an ungrounded outlet, there is a risk of receiving a fatal electric shock. In addition, the peripheral devices connected to the instrument may be damaged.

CAUTION

If an emergency arises causing the instrument to fail or malfunction, disconnect the instrument from the power supply by disconnecting either end of the power cord.

When installing the instrument, arrange the power inlet and outlet so that an operator may easily connect or disconnect the power cord.

If the instrument is mounted in a rack, a power switch for the rack or a circuit breaker may be used for power disconnection.

2.4 Connecting Peripheral Devices

USB devices

USB devices such as mouse, keyboard, storage, etc., can be connected to the front-panel and rear-panel USB connector.

No panel operations are required before removing USB devices from the MS9740B. USB devices can be removed at any time as long as no files are being written to or read from the USB device.

External Monitor

Connect a monitor output to the rear-panel.

The supported monitor resolutions are 800 × 600.

Ethernet

Connect a category-5 or better crossover cable.

Serial

Serial devices are not supported.

Mic input/Line input/Line output

Headsets and audio recording devices cannot be used with the MS9740B.

GPIB

The GPIB devices such as a printer or plotter are not controlled via the MS9740B.

2.5 Connecting Remote Control Devices

Ethernet

Connect the Ethernet cable to the rear-panel left Ethernet connector.

Do not use the right Ethernet connector.

Use a category-5 or better crossover cable.

GPIB

GPIB can be used when the MS9740B-001/101 is installed.

Connect the cable to the rear-panel GPIB connector.

Note:

The MS9740B cannot print directly to a printer with a GPIB interface.

2.6 Cautions on Handling Optical Fiber Cables

Optical fiber cables may degrade in performance or be damaged if handled improperly.

Note the following points when handling them.

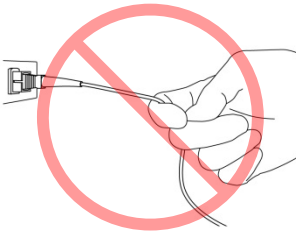

 **CAUTION**

Do not pull the cable when removing the connector.

Doing so may break the optical fiber inside the cable, or remove the cable sheath from the optical connector.

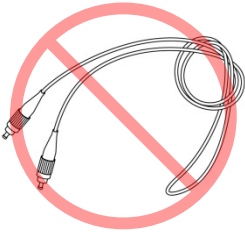

 **CAUTION**

Do not excessively bend, fold, or pinch an optical fiber cable.

Doing so may break the optical fiber inside the cable. Keep the bend radius of an optical fiber cable at 30 mm or more. If the radius is less, optical fiber cable loss will increase.

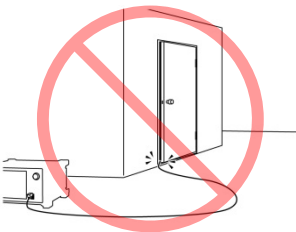
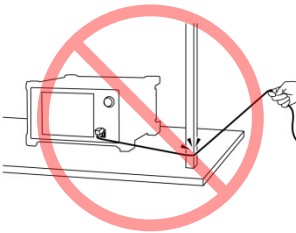



⚠ CAUTION

Do not excessively pull on or twist an optical fiber cable.

Also, do not hang anything by using a cable. Doing so may break the optical fiber inside the cable.

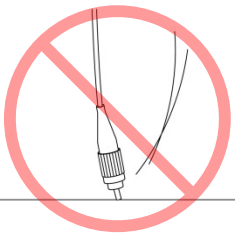

⚠ CAUTION

Be careful not to hit the end of an optical connector against anything hard such as the floor or a desk by dropping the optical fiber cable.

Doing so may damage the connector end and increase connection loss.

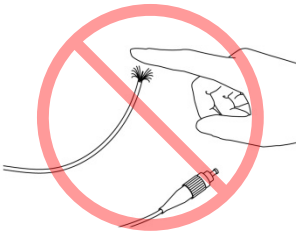

⚠ WARNING

Do not touch the end of a broken optical fiber cable.

The broken optical fiber may pierce the skin, causing injury.

⚠ CAUTION

Do not disassemble optical connectors.

Doing so may cause part to break or the performance to degrade.

2.7 Precautions at Measurement

CAUTION

Never input an optical signal with a level that exceeds the maximum input level of the analyzer. Input of an over-level signal runs the risk of damaging the optical parts and level error will increase due to degraded level linearity.

Effect of Optical Fiber on Measurement Results

The following optical fibers can be used with MS9740B:

- Single-mode fiber (SM) (core diameter of 5 to 9.5 μm)
- Multimode fiber (GI) (core diameter of 50 μm)

When using SM fiber, press **F1 Measure Mode** and set **f5 MM Mode** to Off.

When using GI fiber, press **F1 Measure Mode** and set **f5 MM Mode** to On.

The performance is limited as follows, depending on the fiber used.

(1) Limitations on wavelength resolution

The MS9740B wavelength resolution accuracy meets the specifications using SM fiber with a core diameter of 9.5 μm or less. If a fiber with a core diameter of more than 9.5 μm is used, the specified resolution accuracy may not be met.

(2) Limitations on measurement level

There are limitations depending on the Numerical Aperture (NA) of the optical input fiber.

The MS9740B has a built-in monochromator.

When connecting an SM optical fiber with an NA larger than 9.5/125 μm , not all the light radiated from the fiber is captured by the MS9740B, causing connection loss equivalent to the lost amount of light. As a result, the measured level is smaller than the true level. The NA of multimode fiber is about 0.2 to 0.35 larger than the NA of SM fiber, causing error when measuring level using multimode fiber.

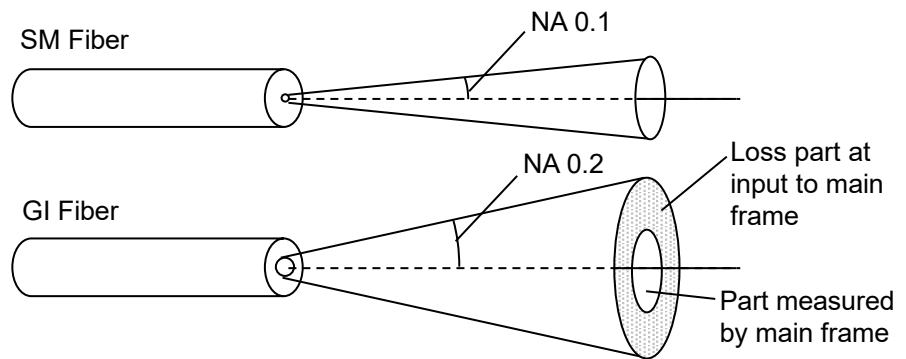

Figure 2.7-1 Difference in light radiated from optical fibers

Effect of Water Vapor on Spectrum Absorption

Water vapor (OH radicals) in air have multiple absorption spectra around 1350 to 1450 nm. If there is water vapor in the MS9740B, ripple will be observed in the measured spectrum due to the water vapor absorption spectra. The size of the ripple changes with humidity. If the measurement results are being impacted by water vapor absorption spectra, use the MS9740B in a low-humidity/dry environment.

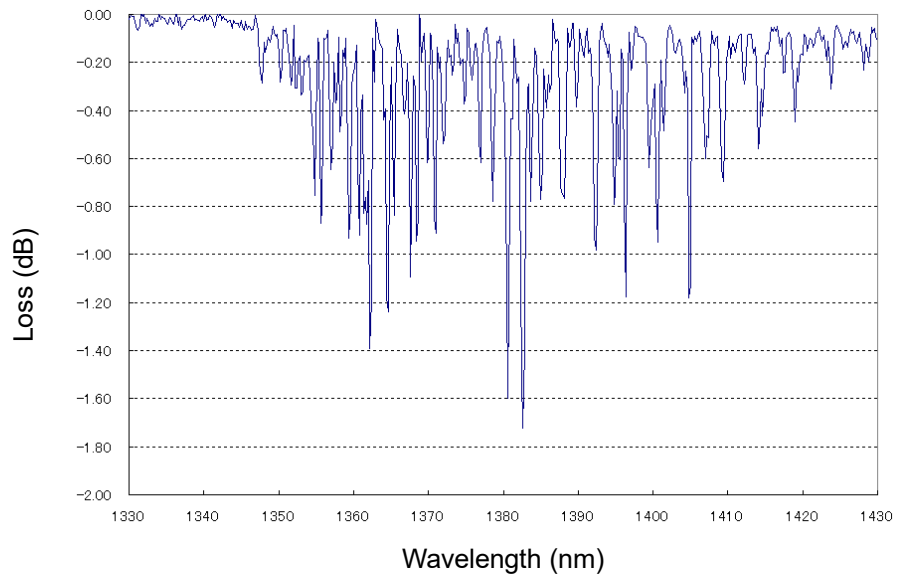

Figure 2.7-2 Water Vapor Absorption Spectrum

2

Before Use

Effect of Secondary Refraction on Measurement Results

The MS9740B uses a diffraction grating that outputs wavelengths simultaneously as integer fractions. The diffraction grating outputs a ghost harmonic wavelength at a position of twice the wavelength of the measured wavelength.

The following figure shows an example of ghosting at the two times (1265 nm) the wavelength of a measured He-Ne laser (632.8 nm).

This ghost does not actually exist in the wavelength spectrum.

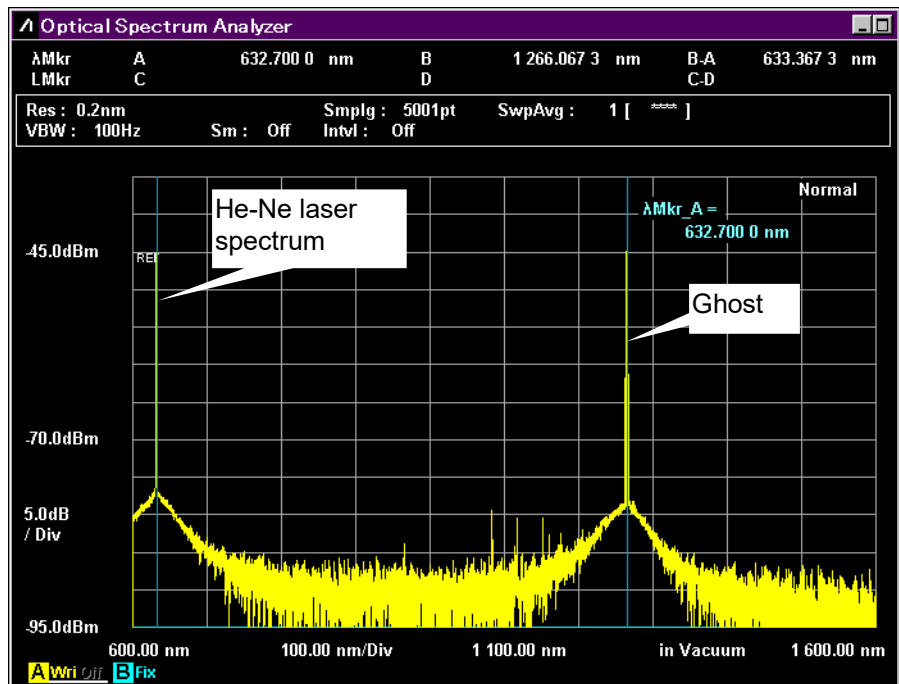

Figure 2.7-3 Ghosting Example

When measuring wavelengths of 900 nm or less, take care about ghosts at the two times the wavelength of a measured result.

Using Multimode (MM) fiber (50 μm core diameter)

There are two insertion methods for multimode fiber: 1. Steady state mode excitation when light from an LED or VCSEL is propagated, and 2. Fixed mode excitation when using an excited fiber (GSGG) for measuring optical loss of an LD. To measure light in these excitation states, press **F1 Measure Mode** and set **f5 MM Mode** to “On”.

When setting **f5 MM Mode** to On for the following measurements:

- When measuring faceted light sources such as LEDs, VCSELs, etc.
- When measuring in the recommended launch mode using a dummy fiber patch cord (GSGG)

When setting **f5 MM Mode** to Off:

To measure light in the limited excitation states, press **F1 Measure Mode** and set **f5 MM Mode** to “Off”.

- When measuring optical output of LD modules without normal distribution (excitation) using dummy fiber patch cord for optical loss measurement (GSGG etc.)

Note:

The GSGG is a device with a fixed multimode fiber excitation condition. It is configured using a combination of different multimode fibers.

The 14 dB loss when connecting 50 μm /125 μm multimode optical fiber degrades the light reception sensitivity.

The MS9740B has an MM mode function to correct loss when connecting 50 μm /125 μm multimode optical fiber and to display the level.

The optical loss level is corrected when the MM mode is On. It corrects the level by 14 dB (sum).

However, level display errors occur if loss is not 14 dB according to the excitation conditions of multimode fiber.

2.8 Turning Power On/Off

2.8.1 Power-on

1. Connect the power cord plug, referring to 2.3 “Power Connection”. The MS9740B enters the standby state and the power switch lamp lights orange.
2. Press the power switch. The power lamp lights green and the Windows start-up begins.
3. After 1 minute has passed, the MS9740B start-up screen is displayed.

Notes:

- Do not press the power switch while the start-up screen is displayed, otherwise the MS9740B software may not start normally.
The time required for startup may be longer at low temperatures.
- After powering off the MS9740B, wait for at least 2 seconds before powering on again. Otherwise, the MS9740B may not boot normally.

2.8.2 Power-off

Power-off using panel keys

Press the Power switch to close applications and start shutdown. The green Power switch lamp goes off, the power lamp lights orange, and the power is turned off.

Notes:

- Do not press the Power switch for more than 4 seconds except where forced shutdown performed, otherwise the system will quit immediately.
- To turn Off MS9740B when it is remote-controlled, stop the remote control operation. Then press the **Local** key and press the power button to turn it Off.
- If the power button is pressed while MS9740B is remote-controlled, a message appears on the screen to prompt you to close the program. To turn Off the power forcibly, select **Force shut down** by the left arrow key and press **Enter**. Then select **Yes** by the left arrow key and press **Enter** to start shutting down.

Power-off using mouse connected to MS9740B

1. Connect the supplied mouse to the MS9740B and click the “Minimize” button located in the upper right corner of the application window of the MS9740B.

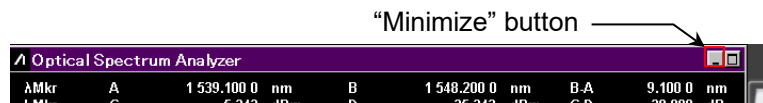

2. Open the **Start** menu on the Windows task bar.
3. Click **Shut down**.
Shutdown begins, the green Power switch lamp goes off, the power lamp lights orange.

Forced shutdown

Press the Power switch for 4 seconds or more.

The green Power switch lamp goes off, the power lamp lights orange, and the power is turned off.

Notes:

- Only use forced shutdown as an emergency operation when key, mouse, and keyboard operations fail. A fault may have occurred if the power cannot be turned off even by pressing the Power switch for 4 or more seconds. Unplug the power cord from the power outlet and contact your Anritsu Service and Sales Office or agent.
- Unplugging the power plug while the hard disk is being accessed may cause failure of the hard disk. Unplug the power plug when the power is off.

2.9 Setting Control Panel

The MS9740B is set to the factory defaults for optimal measurement. Changing the Windows settings is outside the scope of operation warranty. In addition, the performance may drop or functions may not operate correctly if the Windows settings are changed. Read the general notes in this section carefully when changes to the Windows settings are required.



CAUTION

MS9740B is guaranteed to operate properly only with factory defaults.

Proper operation is not guaranteed if there are any changes to Windows settings, or if a program not guaranteed by Anritsu is installed.

Any changes to the registry can cause MS9740B to behave abnormally.

2.9.1 Displaying Windows Desktop

Connect a mouse and a keyboard to operate Windows. Use the accessory USB mouse and a compatible USB keyboard.

Display the Windows Desktop as described below. To display applications of the MS9740B again, press the application switch or select an application in the Windows Taskbar.

Mouse

Click the Minimize button at the top right corner of the application window of the MS9740B. Minimizing all applications displays the Desktop.

Keyboard

Press the Windows key and **D** key to minimize all windows and display the Windows Desktop.

2.9.2 Confirming Windows Version

The MS9740B uses Windows Embedded Standard 7 (WES7) 32 bit version or Windows 10 IoT Enterprise (Win10) 64 bit version (hereinafter, referred to as “Windows”) as the operating system. Settings for Windows and the system can be operated by connecting a mouse and a keyboard.

This section describes how to perform operations on Windows installed to the MS9740B and general notes.

Note:

The setting method varies depending on the CPU. Check your CPU and operating system as below before starting the Windows setting.

How to check your CPU and operating system

Connect the mouse to MS9740B and perform the steps below.

When the OS is WES7

1. Click the **Start** menu on the Windows taskbar.
2. Right-click on **My Computer** or **Computer** to display the menu and select **Properties**.
3. Find out the operating system from the window design and the Processor and System type displayed.

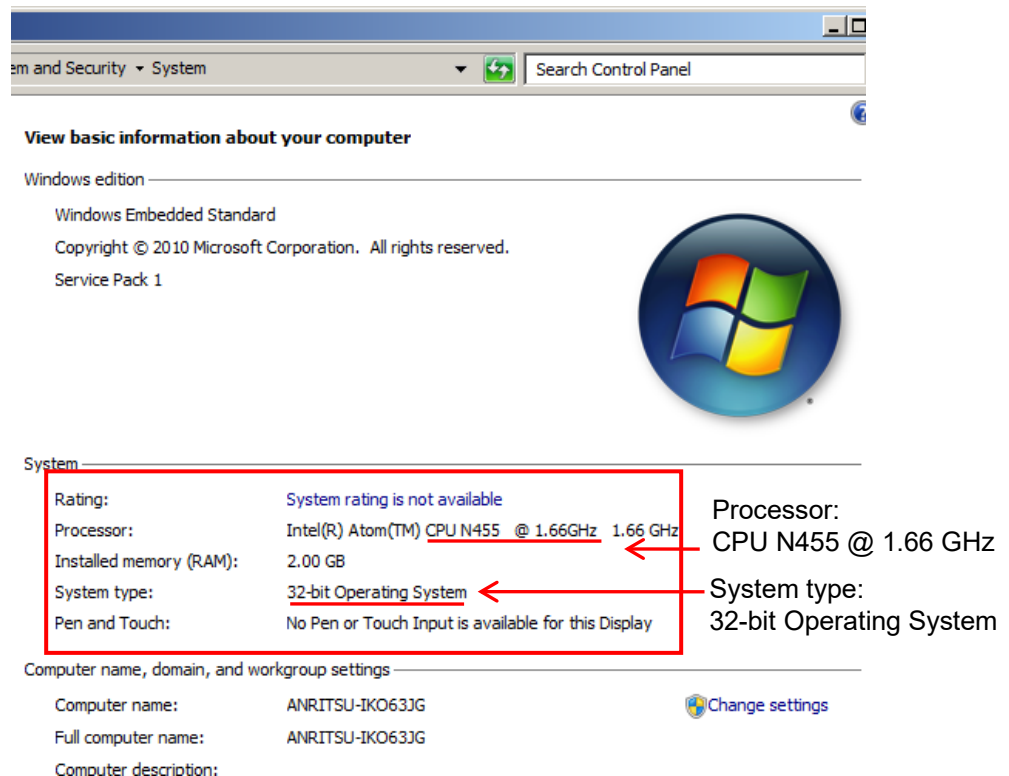

Figure 2.9.2-1 Windows Embedded Standard 7

When the OS is Win10

1. Click the Start (☰), and on the Start menu, click the **Settings** (⚙️).
2. Click **About** to display device information (specifications), and check the processor and edition information.

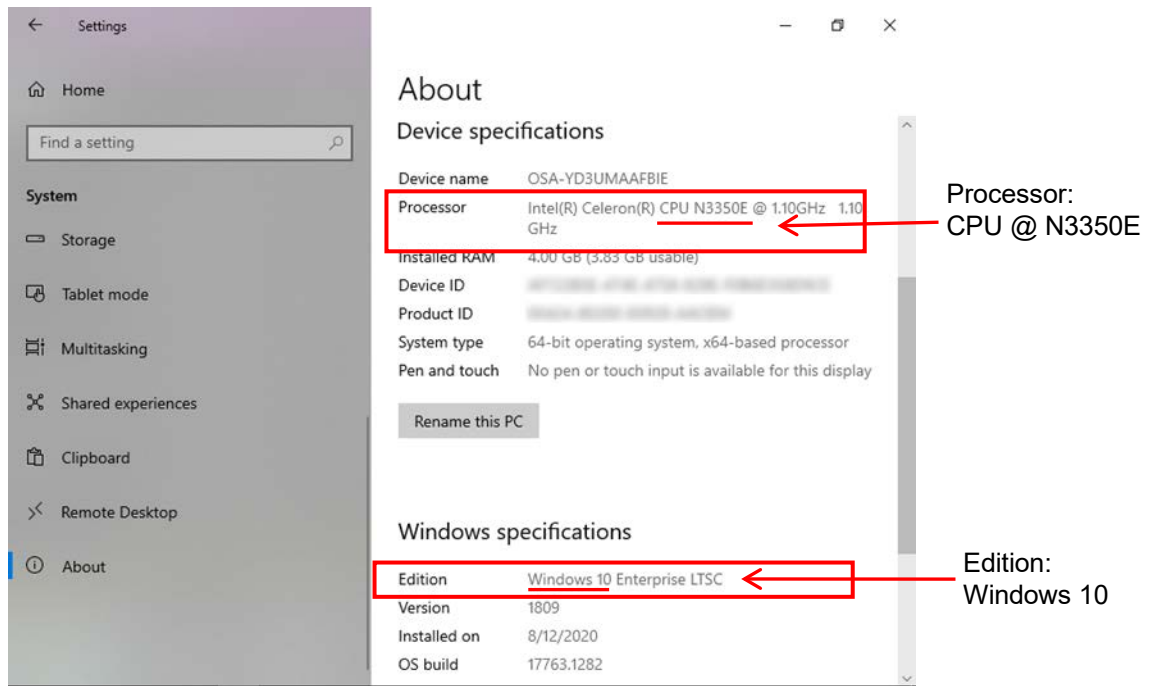

Figure 2.9.2-2 Windows 10 IoT (Win 10)

2.9.3 Setting Control Panel

Various Windows settings (such as time, network address, and external display) are configured at the Control Panel. Do not change any settings except those listed in Table 2.9.3-1.



When using the mouse:

- 1 Open the **Start** menu on the Windows task bar.
- 2 Select **Control Panel** to display the control panel.

When using the keyboard:

- 1 Press the Windows key to display the start menu.
- 2 Press **C** key to display the control panel.

Table 2.9.3-1 Description of Control Panel (Windows Embedded Standard 7)

Setting Type	Description
	<p><u>Date and Time</u></p> <ul style="list-style-type: none"> • Change the date, time and time zone as necessary. • Internet Time is set to off at factory shipment. Operation may be affected if this setting is changed.
	<p><u>Display</u> <u>Intel® GMA Driver for Mobile</u></p> <ul style="list-style-type: none"> • This setting must be changed when connecting an external monitor to the MS9740B VGA connector. See Section 2.9.4 "Using external display" for details. • Changing the screen resolution, refresh rate or power management, or enabling the screen saver may cause abnormal MS9740B operation.
	<p><u>Network and Sharing Center</u></p> <ul style="list-style-type: none"> • TCP/IP settings may change when the MS9740B is remote-controlled via the Ethernet. Refer to the MS9740B Operation Manual (Mainframe Remote Control) for details. • The IP address uses 192.168.0.10 at factory shipment. Ensure that the network settings are appropriate when connecting the MS9740B to a network.

2.9.4 Using external display

An external display can be connected to the VGA connector on the back of the MS9740B to display multiple screens. This operation is described below.

When the OS is WES7

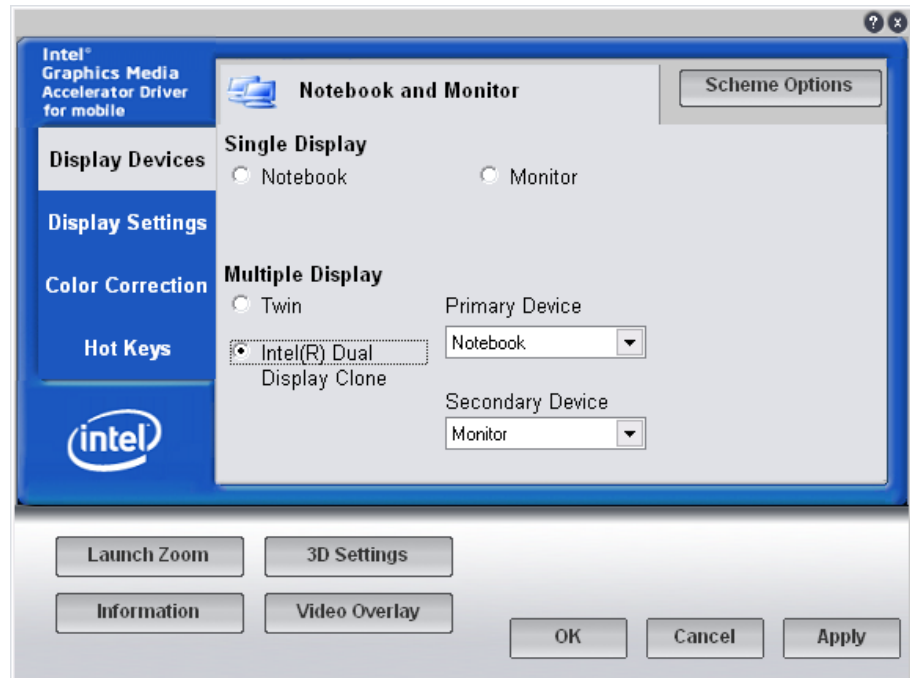

Figure 2.9.4-1 External Display Setting

1. Connect the display to the VGA connector.
2. Display the Intel® GMA Driver Settings screen using any of the following methods.
 - Execute “Intel® GMA Driver for Mobile” from the Windows Control Panel.
 - Press **Ctrl + Alt + F12** on the keyboard.
3. Change the **Display Devices** settings as shown below:
 - Multiple Displays Twin or Intel® Dual Display Clone
 - Primary Device Notebook (MS9740B display)
 - Secondary Device Monitor

Do not select the Monitor of Single Display.

When Twin is set, the analyzer and external screens are displayed at the same settings.

When Dual Display Clone is set, the refresh rate, aspect ratio, color calibration, etc., can be set separately for the screens.

Notes:

- Turning the MS9740B power on with an external display not connected to the VGA connector only initializes the main display.
- When using an external display, keep the external monitor connected.
- Do not change the resolution, refresh rate and power management settings for the main screen.
- The supported monitor resolutions are 800 × 600.

When the OS is Win10

1. Connect the display to the monitor output on the rear panel of the MS9740B.
2. When the MS9740B is powered off, turn on the power to display on the external display.

When the MS9740B is powered on, right-click the VGA icon in the task tray at the bottom right of the screen, select **Enable VGA**, and you can display on the external display.

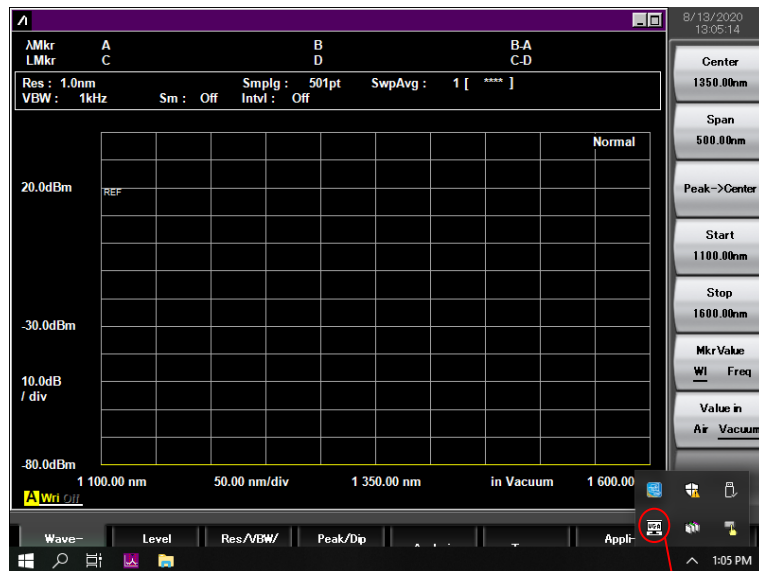

VGA icon

Figure 2.9.4-2 VGA Icon in Task Tray

Note:

If the image displayed on the external screen is skewed, right-click the VGA icon again, and select **Enable VGA**.

- Right-click an empty area of the desktop, and click **Intel® Graphics Settings**.

The Intel® HD Graphics Control Panel is displayed.

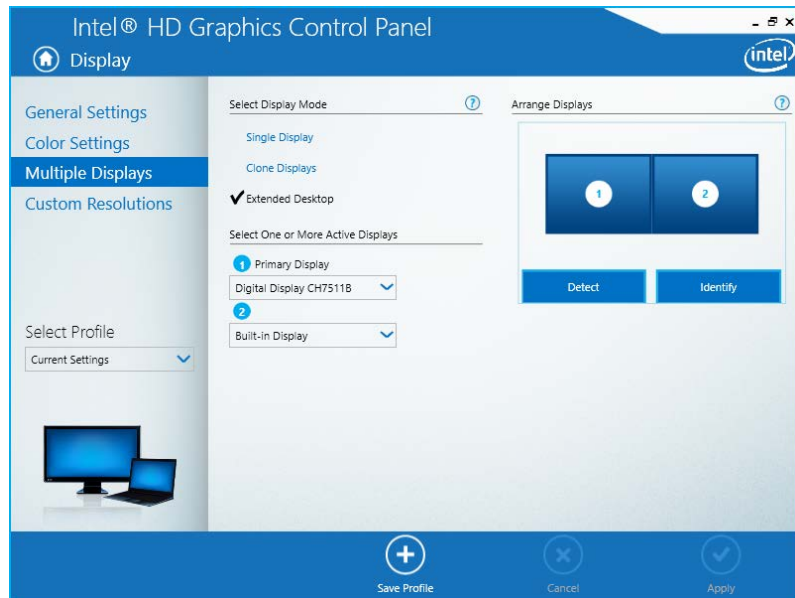

Figure 2.9.4-3 Intel® HD Graphics Control Panel

- Click **Display > Multiple Displays**, and change the settings.

When not using an external display

- Select Display Mode Single Display
- Select One or More Active Displays
 Built-in Display

When using an external display only

- Select Display Mode Single Display
- Select One or More Active Displays
 (Connected external display)

When displaying the same content on the external display as the built-in display

- Select Display Mode Clone Displays
- Select One or More Active Displays
 - Built-in Display
 - (Connected external display)

When displaying with the built-in display and external display connected

- Select Display Mode Extended Desktop
- Select One or More Active Displays
 - Primary Display Built-in Display
 - (Connected external display)

Notes:

- If the MS9740B is powered on without an external display connected to the VGA connector, the settings are initialized so that only the built-in display can be used. When continuously using an external display, it is recommended to keep it connected. Use an external display with a resolution of 800 x 600 dots.
- To replace with another external display, power off the MS9740B before connecting it.
- Do not change the resolution, refresh rate and power management settings for the main screen.

2.10 Windows Security Measures

MS9740B uses Windows Embedded Standard 7 (WES7) 32 bit version or Windows 10 IoT Enterprise (Win10) 64 bit version.

When connecting the MS9740B to a network, in addition to connecting to secure and virus-protected networks, the following procedures are recommended in order to add protection against malware (malicious software) and viruses.

- Activating firewall
- Installing Windows important update programs
- Using antivirus software

The security measure settings condition of MS9740B can be confirmed from the Control Panel of Windows.

When the OS is WES7

1. Click the “Minimize” button located in the upper right corner of the application window to show the Windows desktop.
2. Click **Start** → **Control Panel** from the Windows menu bar hidden in the lower part of the screen.
3. Click **System and Security** → **Action Center**.
4. Click **Security**, and confirm security measures settings condition.

When the OS is Win10

1. Click the **Start** (⊕), and then click **Windows System** > **Control Panel**.
2. With View by: Category, click **System and Security** → **Security and Maintenance**.
3. Click **Security**, and confirm security measures settings condition.

Note:

Security warnings are not displayed by factory default.

CAUTION

When connecting MS9740B to the Internet or to an external network, there is a possibility an unpredictable problem or damage may occur. Anritsu Corporation does not recompense for any damage caused by connecting MS9740B to a network.

2.10.1 Installing Windows Important Update Programs (Windows Update)

It is necessary to regularly check for important Windows update programs and keep them up-to-date. However, since executing update program downloads and installations will decrease the performance of MS9740B, deactivate automatic updates for Windows Update. Instead, it is recommended to check for new updates, execute downloads and installations periodically when MS9740B is not in use for measurement.

When the OS is WES7

1. Click **Start** → **Control Panel** from the Windows menu bar hidden in the lower part of the screen.
2. With View by: Category, click **System and Security** → **Windows Update** to show Windows Update display.
3. To deactivate automatic updates, click **Change settings** found in left side of Windows Update display.



Figure 2.10.1-1 Windows Update display

4. Select **Never check for updates (not recommended)** in Important updates, then click **OK**.

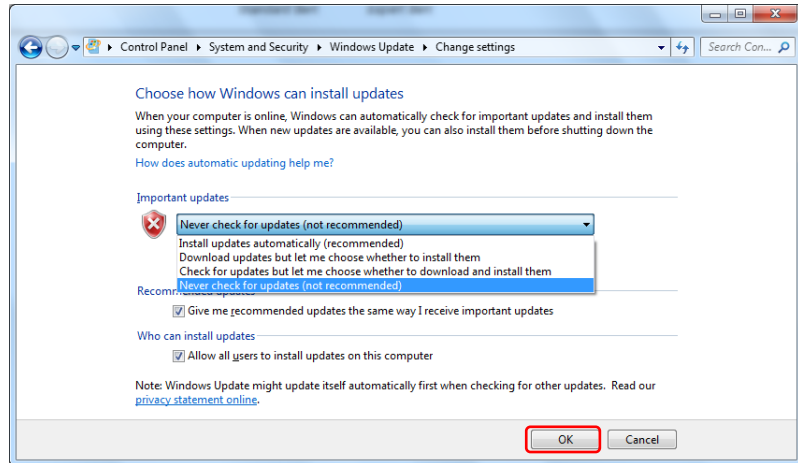

Figure 2.10.1-2 Change settings display

5. To check for newly available update programs (manual update), click **Check for updates** in Windows Update display.



Figure 2.10.1-3 Windows Update display (manual update)

6. When a new update program is found, download and install following the displayed instructions.

2
Before Use

When the OS is Win10

1. Click the **Start** (Windows logo) to open the Start menu, and then click **Settings** (gear icon).
2. Click **Update & Security** to show Windows Update window.
3. To turn off automatic updates, select **Windows Update** found in left side of Windows Update window, and then click **Advanced options**.

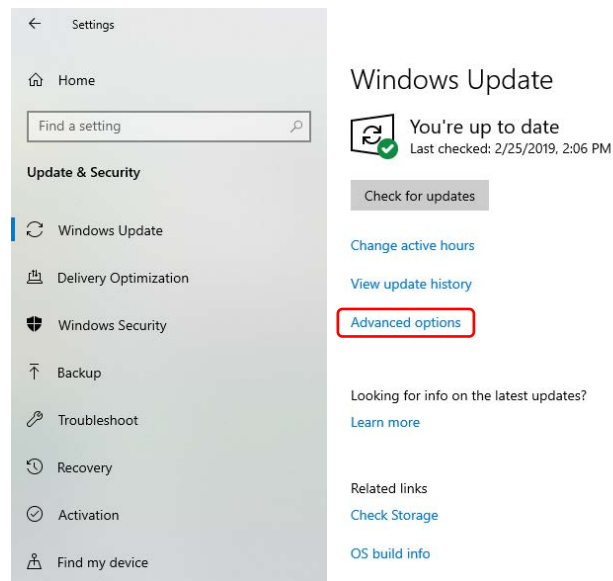

Figure 2.10.1-4 Windows Update Window

4. Advanced options window will be shown. Confirm if **Automatically download updates even over metered data connections (charges may apply)** is set to Off.

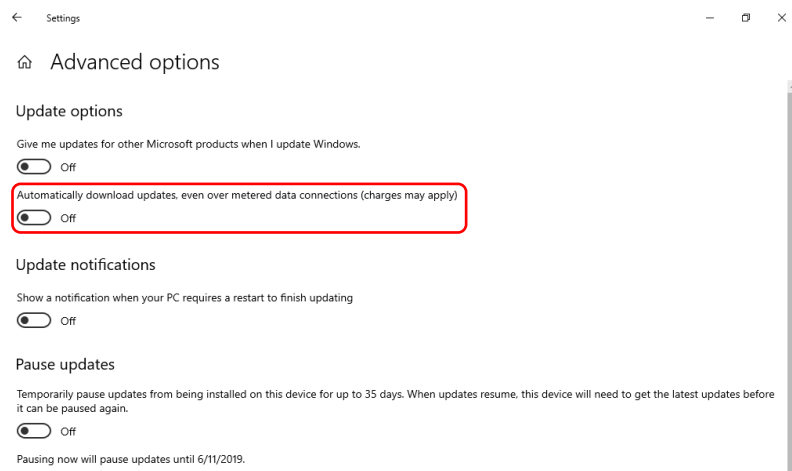

Figure 2.10.1-5 Advanced options Window

- To check for newly available update programs (manual update), click **Check for updates** in Windows Update window.

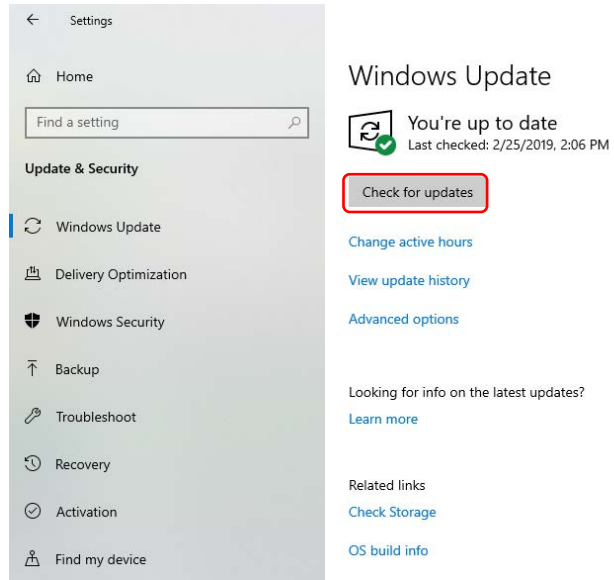

Figure 2.10.1-6 Windows Update Window (manual update)

- When a new update program is found, download and install following the displayed instructions.

2

Before Use

2.10.2 Using Antivirus Software

It is recommended to install antivirus software on MS9740B. However, since the automatic updates for virus data library and the full scans run in the background by the antivirus software will decrease the performance of MS9740B, do not execute them. Instead, it is recommended to run them periodically when MS9740B is not in use for measurement.

The antivirus software that checked operation in MS9740B is shown below.

- McAfee Endpoint Security 10.6

Notes:

- Refer to the antivirus software operation manual for its installation and operation procedures. It is confirmed that no negative effects in the general usage of MS9740B are caused by using the software mentioned above, however, we do not guarantee the behavior of all functions of this antivirus software and other software containing similar functions.
- When activate firewall, configure the access authorization for the following files.

C:\Program Files\Anritsu Corporation\Signal Analyzer\Applications\AppMgr.exe

C:\Program Files\Anritsu Corporation\Signal Analyzer\Applications\OsaAppPlatform.exe

2.10.3 Restoring Hard Disk Drive

When restoring the hard disk drive, the software installed on MS9740B is also restored to early state. Download the latest version of the software from the Anritsu website, and install it. For details on how to install the software, refer to 6.3 “Updating Software”.

Perform the following steps to restore the hard disk drive.

When the OS is WES7

1. Disconnect the MS9740B from the network if connected.
2. Connect the keyboard and mouse to the mainframe, and then turn the MS9740B power On.
3. When the following screen is displayed, press the **F8** key on the keyboard several times at intervals of about one second.

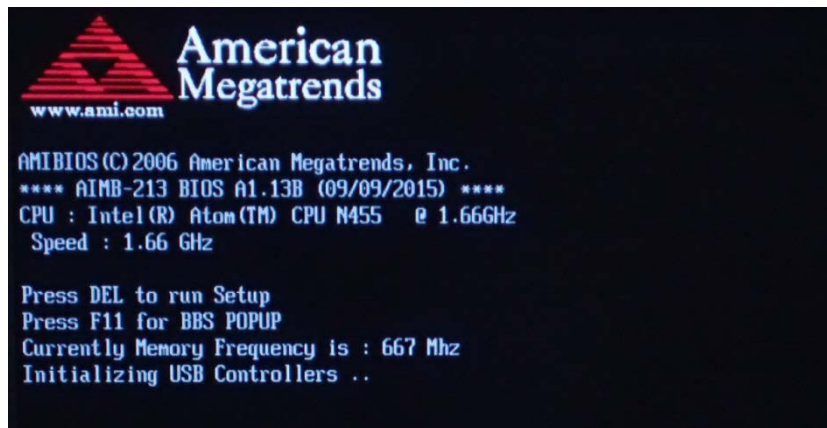

4. Use the keyboard cursor keys to select **Repair Your Computer**, and then press **Enter**.

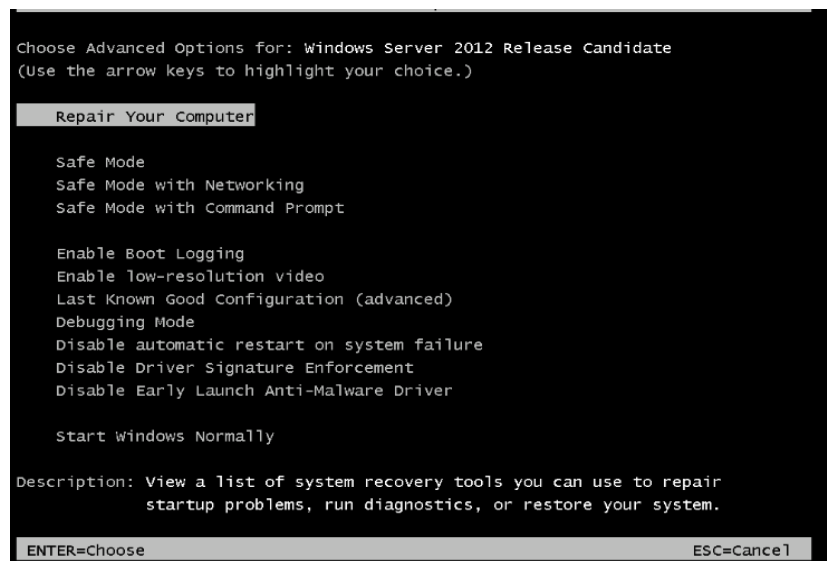

5. Click **Next**.

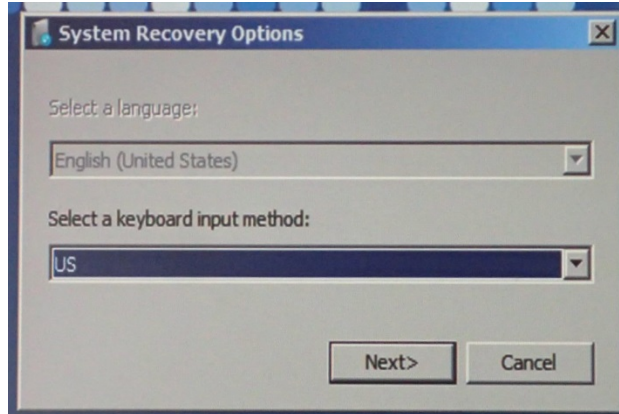

6. Click **OK**, leaving the **Password** box blank.



7. Click **Reinstall Windows**.

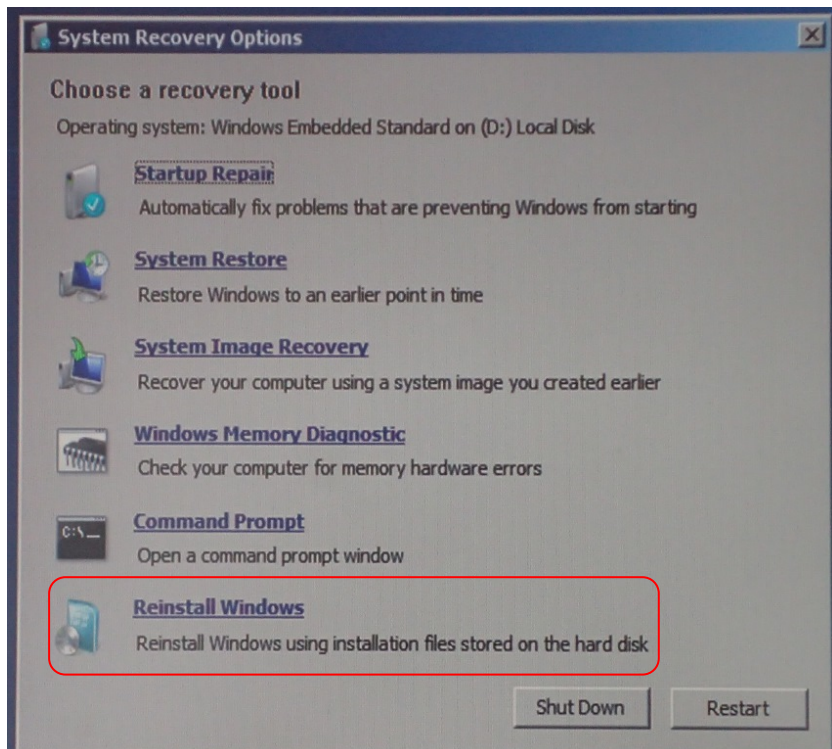

8. Click **Yes**.

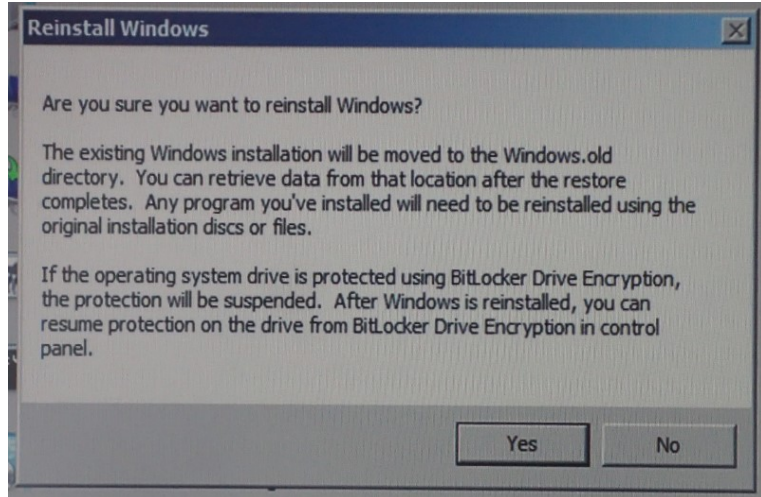

2

Before Use

The Recovery Processing window in Windows is displayed. The recovery processing requires 10 to 30 minutes. After Windows restarts several times, the application window of the MS9740B will appear.

9. Click the “Minimize” button located in the upper right corner of the application window.



10. In Windows Explorer, open the following folder.
C:\Program Files\Anritsu\MS9740A\PreSetup
11. Right-click “Recovery.bat” to select **run as administrator**.
12. After Windows restarts, the application window of MS9740B will appear. Click the “Minimize” button located in the upper right corner of the application window.
13. In Windows Explorer, confirm that the following folder is deleted. If the folder has not been deleted yet, repeat steps 10 through 12.
C:\Windows.old
14. Update Windows according to the procedure in 2.10.1 “Installing Windows Important Update Programs (Windows Update)”.

When the OS is Win10

1. Disconnect the MS9740B from the network if connected.
2. Connect the keyboard and mouse to the mainframe, and then turn the MS9740B power On.
3. When the following screen is displayed, press the **F8** key on the keyboard several times at intervals of about one second.



4. Use the keyboard cursor keys to select **Repair Your Computer**, and then press **Enter**.



5. Click **Troubleshoot**.

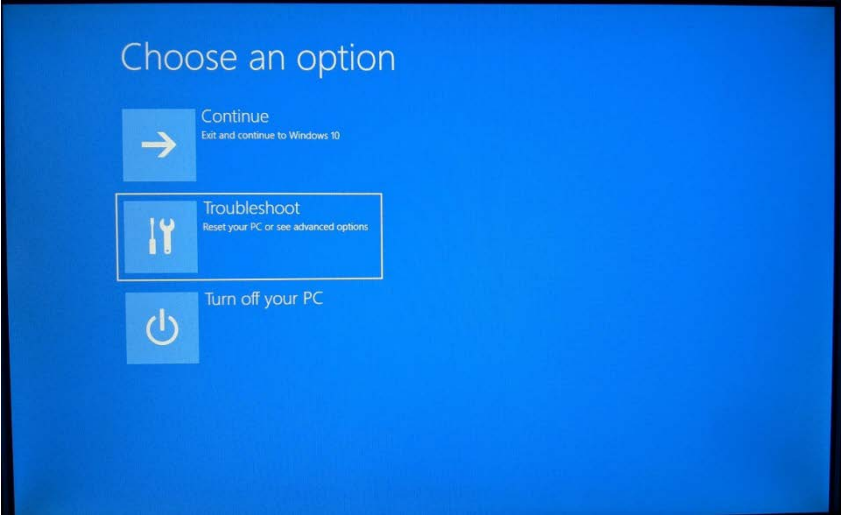

2

Before Use

6. Click **Advanced option**.

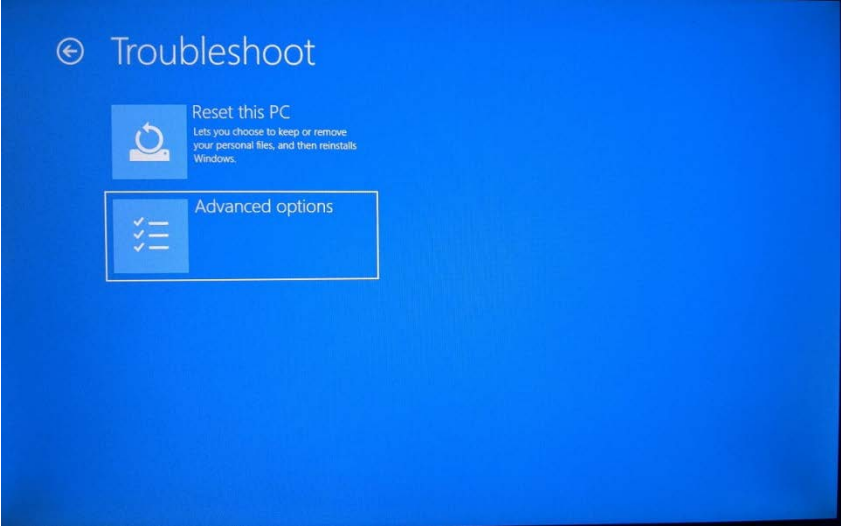

7. Click **System Image Recovery**.

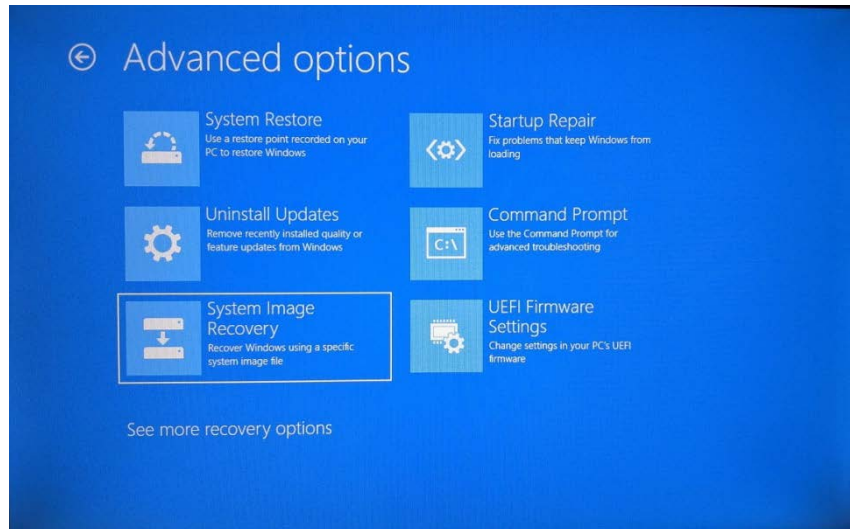

8. Click **AnritsuUser**.

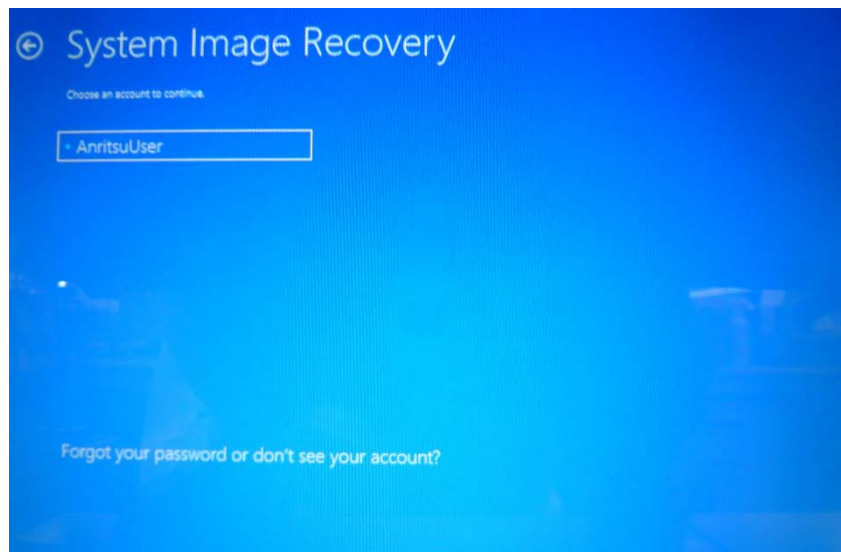

9. In the password box, enter “AnritsuUser”, and click **Continue**.

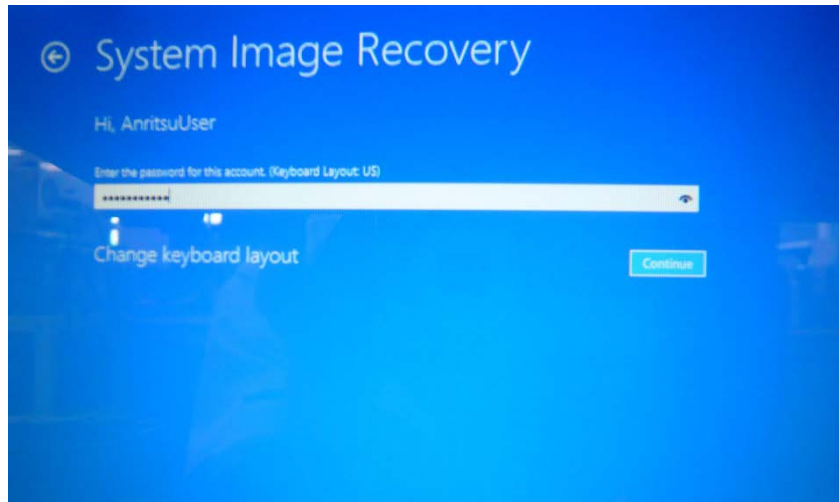

2

Before Use

10. Select **Use the latest available system image**, and click **Next**.

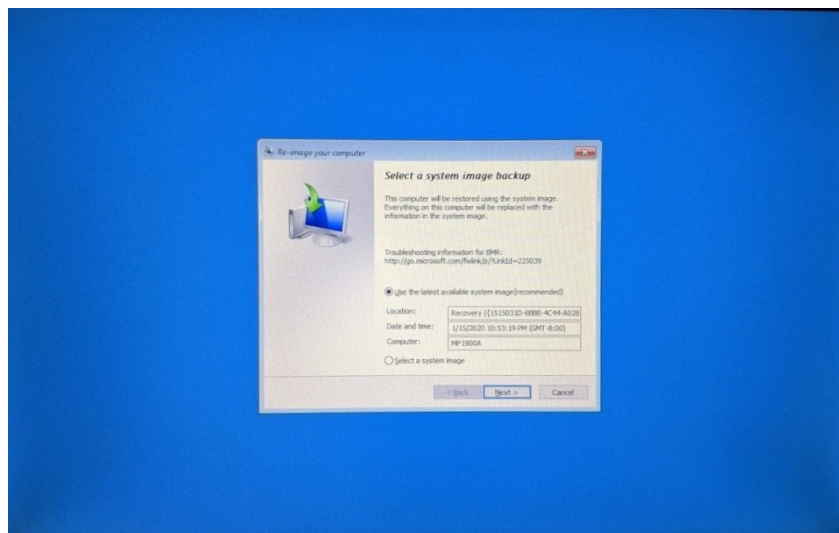

11. Click **N**ext without making any changes.

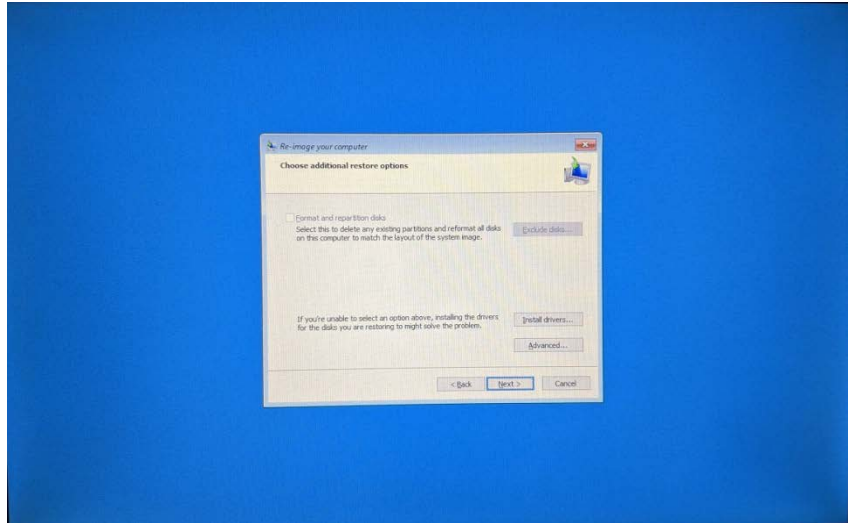

12. Click **F**inish.

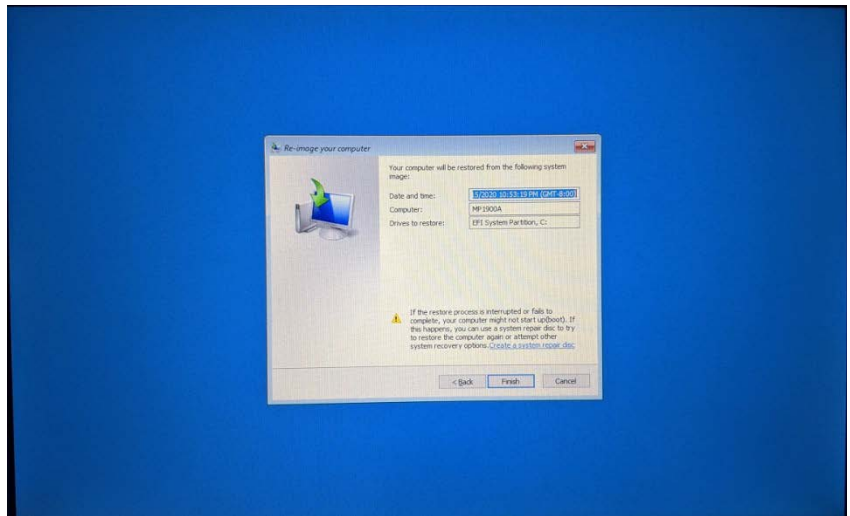

- 13. Click **Yes**.

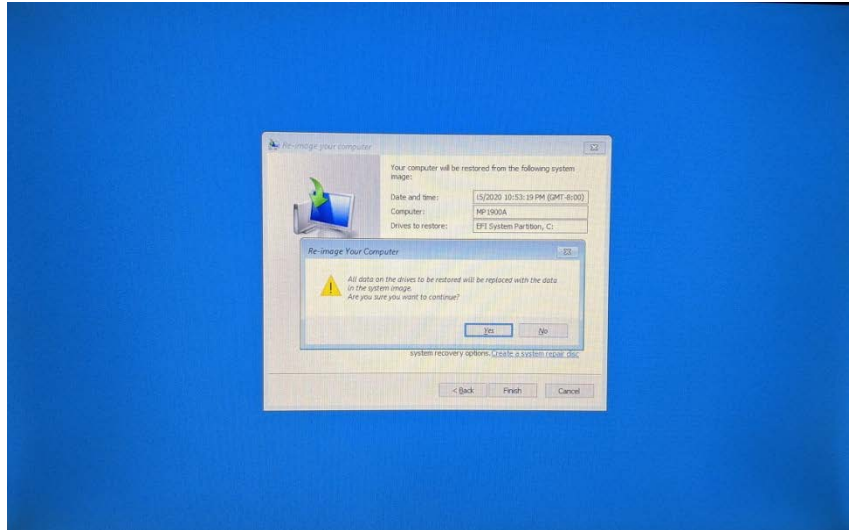

2

Before Use

- 14. After the system recovery is complete, you will see the following message.

Click **Restart now**. If the MS9740B does not restart, it will automatically restart after a certain period of time.

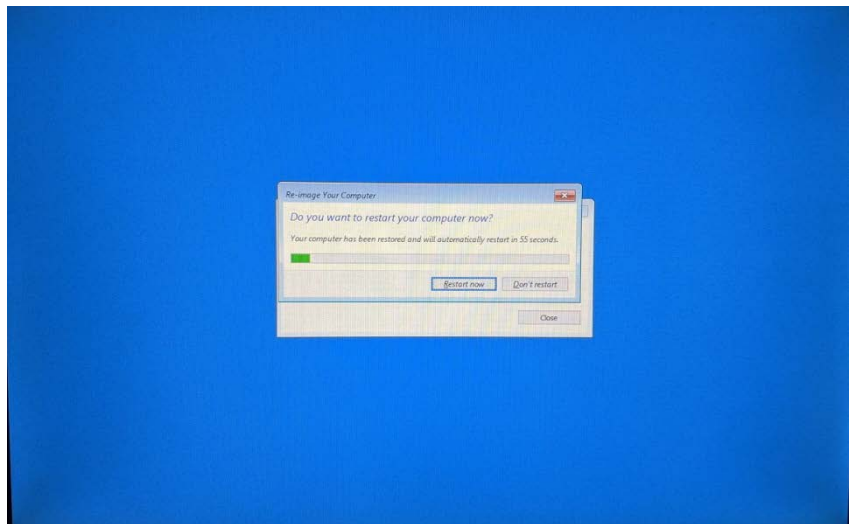

After a few reboots, the application window will appear.

- 15 Update Windows according to the procedure in 2.10.1 “Installing Windows Important Update Programs (Windows Update)”.

2.11 Configuring Storage Media

The MS9740B has a built-in hard disk for storing the operating system, application software, user data, etc.

The MS9740B hard disk is partitioned as follows:

Volume C: System Partition

The following files are saved:

- Windows
- Application software
- File required for operation

The MS9740B may not operate normally if data required for operations are changed or deleted. Normally, do not change data on this volume.

Volume D: Data Partition

This volume is used mainly as the file input and output destination for the waveform data and measurement environment of the MS9740B application software.

The analyzer files are saved to D:\Anritsu Corporation\Optical Spectrum Analyzer\User Data.

This file is created when pressing the **f4 Save CSV** or **f5 Save XML** button. For the operating procedures, refer to 3.8.1 “Saving Measurement Conditions and Waveform Data”.

Note the following when operating the MS9740B:

- Do not change the partition configuration. The MS9740B may not operate normally.
- Do not format the hard disk.

2.12 Screen Names

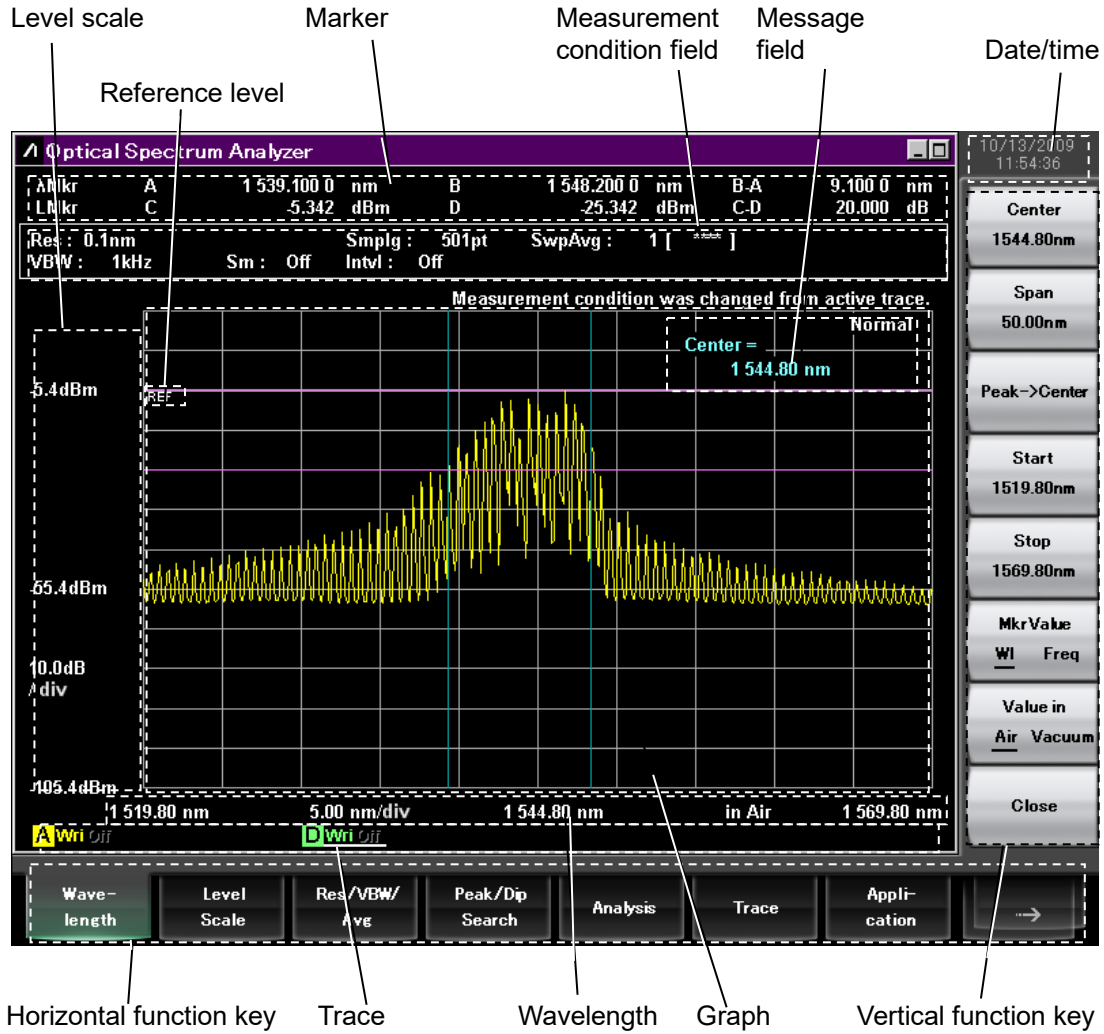

2

Before Use

Figure 2.12-1 Measurement Screen

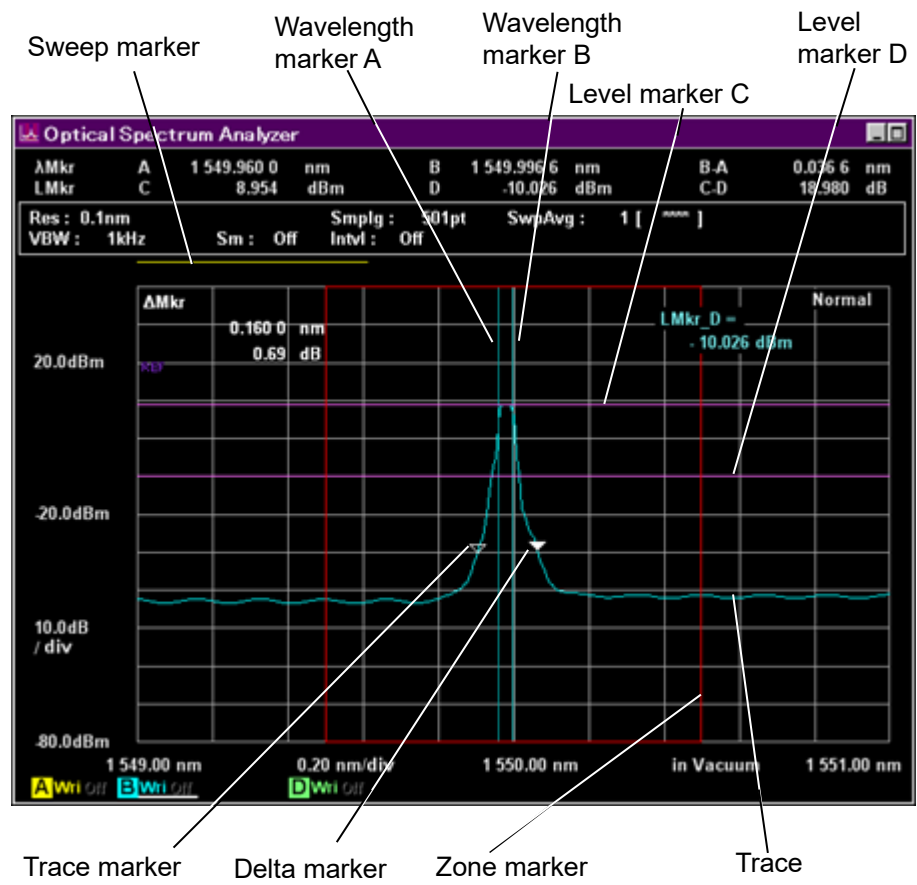

Figure 2.12-2 Names of Trace and Marker

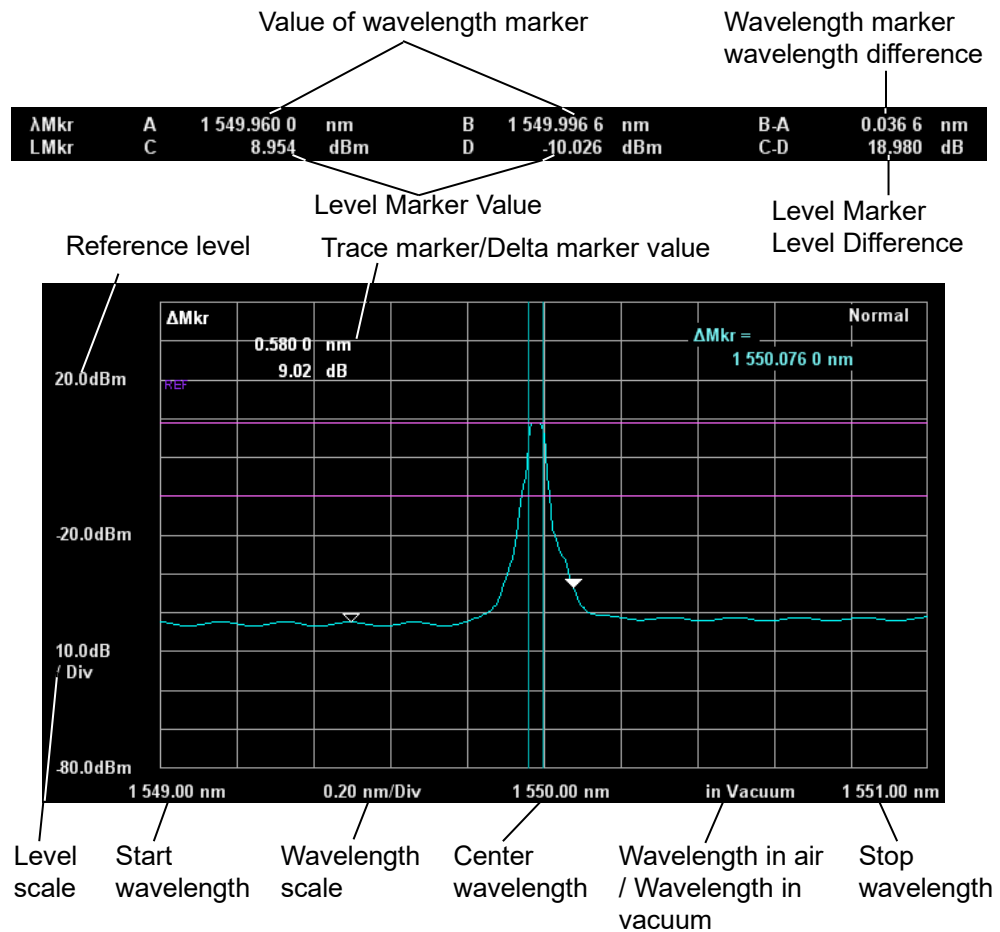

Figure 2.12-3 Marker, Level Scale, Wavelength Displays

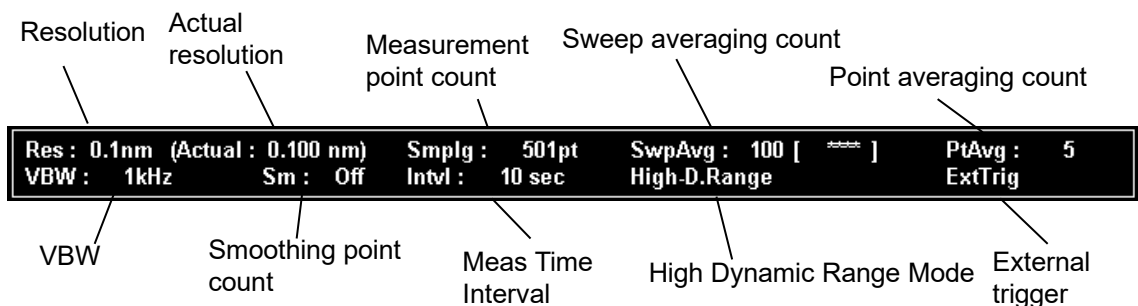

Figure 2.12-4 Measurement Condition Setting Display Field

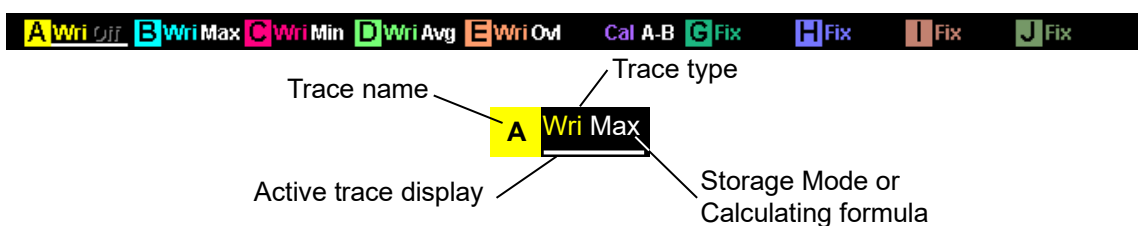

Figure 2.12-5 Trace Display

2

Before Use

Chapter 3 Measurement

This chapter explains how to measure using shortcut and measurement keys, save and read measurement results, and initialize measurement conditions.

3.1	Calibrating Before Measurement.....	3-2
3.1.1	Automatic Alignment of Optical System	3-4
3.1.2	Calibrating Wavelength	3-5
3.1.3	Calibrating Resolution	3-9
3.1.4	Inputting Offset	3-10
3.2	Connecting DUT	3-11
3.3	Inputting Data.....	3-12
3.4	Measurement Types	3-13
3.5	Changing Wavelength and Resolution	3-14
3.5.1	Changing Wavelength	3-14
3.5.2	Changing Resolution	3-14
3.6	Setting Level Scale	3-15
3.6.1	Changing Scale	3-15
3.6.2	Changing Reference Level.....	3-15
3.7	Using Markers.....	3-16
3.7.1	Marker types.....	3-16
3.7.2	Using Wavelength and Level Markers.....	3-20
3.7.3	Using Zone Markers	3-21
3.8	Saving and Reading Data.....	3-22
3.8.1	Saving Measurement Conditions and Waveform Data.....	3-23
3.8.2	Saving Screens	3-25
3.8.3	Reading Data from File.....	3-26
3.9	Initializing Measurement Conditions.....	3-27
3.10	Releasing Panel Lock	3-28

3.1 Calibrating Before Measurement

Calibrating this equipment before measurement assures that it meets the performance standards.

After turning on the power for at least 2 hours, the following items are calibrated before measurement. During warm-up, execute Repeat sweeping with Span of 100 nm or more and VBW of 10 kHz or more.

In addition, if the usage environment experiences sudden changes in temperature, etc., such as during or after equipment transport, perform calibration after allowing sufficient time for the equipment to reach equilibrium with the room temperature and humidity.

Measured wavelength changes with changes in the internal temperature and humidity of the instrument. Consequently, recalibrate the instrument if either the ambient temperature or humidity changes.

The calibration functions of this equipment are listed below.

Table 3.1-1 Calibration Functions

No	Calibration Items	Where:	Button	Description
①	Automatic Alignment of Optical System	3.1.1	Auto Align	Automatically aligns optical axis. Execute as described below: <ul style="list-style-type: none"> • Allow the equipment to warm-up for at least 2 hours after power-on. • Calibrate whenever the equipment is transported or moved between different locations. • Calibrate whenever the ambient temperature or air pressure changes significantly.
②	Wavelength Calibration (External optical light source)	3.1.2	Wl Cal (Ext)	Wavelength calibration is performed using an external light source. Align the optical axis before performing calibration.
③	Wavelength Calibration (MS9740B-002)	3.1.2	Wl Cal (Ref)	Wavelength calibration is performed using a light source of option 002. When Align with cal is On, automatically aligns the optical axis using the light source before performing calibration.
④	Wavelength Calibration (Initialization)	3.1.2	Wl Cal (Init)	Initializes the wavelength calibration data.
⑤	Calibrating Resolution	3.1.3	Res Cal	Measures, recalculates and calibrates effective resolution for current measurement conditions. Align the optical axis before calibrating the resolution.

Table 3.1-1 Calibration Functions (Cont'd)

No	Calibration Items	Where:	Button	Description
⑥	Sets auto offset calibration for temperature change On/Off	3.1.2	Auto Cal On/Off	At On, the internal temperature change is monitored every 10 minutes and the offset is auto-calibrated when temperature changes significantly. At Off, the above-described offset calibration is not performed. (Default: Off)
⑦	Sets auto offset calibration for VBW change On/Off	3.1.2	Auto Offset On/Off	At On, when the Single or Repeat button is pressed immediately after VBW is changed, sweeping starts after offset calibration. (Default: On) At Off, the above-described offset calibration is not performed.
⑧	Zero Calibration	3.1.2	Zero Cal	When Off is set at step ⑥, offset calibration is executed by pressing the Zero Cal button.

Offset calibration is a function for calibrating the offset level for each VBW of the equipment. When the offset level changes, sometimes the measurement results in the level direction are affected. Usually, offset level changes with temperature. To obtain the highest-accuracy measurement results, we recommend performing offset calibration (⑧) once every 2 to 3 hours.

However, offset calibration requires a fixed time period of several seconds (7 seconds). Refer to the following cases and perform setting and calibration according to your usage conditions.

Table 3.1-2 Usage Status and Optimum Calibration

Case	Calibration Condition	Calibration Items
Case 1	Allow the equipment to warm-up for at least 2 hours after power-on. Calibrate whenever the equipment is transported or moved between different locations. Calibrate whenever the ambient temperature or air pressure changes significantly.	Execute ①.
Case 2	When measuring wavelength	Set Align with cal to On and execute ③.
Case 3	When measuring continuous spectrum, such as optical amplifier ASE level and laser diodes	Execute ① and ⑤.
Case 4	When wanting to increase measurement throughput (Shortening the offset calibration time when using applications that switch VBW frequently can increase the measurement system throughput.)	Set ⑥ and ⑦ to Off. Moreover, execute ⑧ when the ambient temperature changes.
Case 5	When performing measurements requiring a long time, such as setting VBW (e.g. measuring DUT optical level and OSNR drift)	Set ⑥ to On.
Case 6	When performing long-term measurements while switching multiple VBW settings	Set ⑥ and ⑦ to On.

3.1.1 Automatic Alignment of Optical System

Adjust the optical system to satisfy the specifications for wavelength accuracy, level accuracy, and dynamic range, using the following procedures. The automatic alignment of optical system should be performed before performing other calibration functions.

For this alignment, the external light source that meets the specification is required. Also, if MS9740B-002 Light Source for Wavelength Calibration is installed, the function of Automatic Alignment of Optical System is added. To align the optical axis automatically using this function, refer to 3.1.2 “Calibrating Wavelength”.

To calibrate using external light source:

1. Input the following optical specifications in the MS9740B.

Level	-20 dBm or more
Wavelength	600 to 1700 nm
Spectrum	single mode
2. Press **F8** to display Cal on the horizontal function keys.
3. Press **F2 Cal**.
4. Press **f6 Auto Align**.
5. Press **f1 Execute**. The “Calibrating” message is displayed. Press **f2 Cancel** to cancel adjustment and return to the status before executing adjustment.
6. Adjustment of the optical axis is finished when the Calibrating...message disappears from the screen.

Note:

Use a single mode oscillation light source such as a DFB laser diode or gas laser.

In addition, always use a light source that meets the specifications. If the light source spectrum is not single mode or the level is too low, calibration may not be performed correctly when performing auto-alignment of the optical system.

Cancel processing takes about 10 s.

To initialize Adjustment Data

Initialize the automatic optical axis adjustment data using the following procedures.

1. Press **F8** to display Cal on the horizontal function keys.
2. Press **F2 Cal**.
3. Press **f6 Auto Align**.
4. Press **f3 Init** to initialize the optical axis adjustment data.

3.1.2 Calibrating Wavelength

Wavelength can be calibrated using either an external or wavelength calibration light source (MS9740B-002). High-accuracy measurement is supported by the wavelength calibration light source of MS9740B-002.

Before calibrating wavelength, always refer to 3.1.1 “Automatic Alignment of Optical System”, and then perform automatic alignment of the optical system. Before measuring wavelength, calibrate the wavelength as described below.

To calibrate using external optical light source:

1. Input the following optical specifications in the MS9740B.

Level	–20 dBm or more
Wavelength	600 to 1700 nm
Spectrum	single mode
2. Press **F8** to display Cal on the horizontal function keys.
3. Press **F2 Cal**.
4. Press **f3 WI Cal (Ext)**.
5. Press **f1 Execute**. The “Calibrating” message is displayed. Press **f2 Cancel** to cancel calibration and return to the status before executing calibration.
6. Calibration of the wavelength is finished when the Calibrating...message disappears from the screen.

Note:

Use a single mode oscillation light source such as a DFB laser diode or gas laser.

In addition, always use a light source that meets the specifications. If the light source spectrum is not single mode or the level is too low, calibration may not be performed correctly when performing auto-alignment of the optical system.

To calibrate using option wavelength calibration light source

Calibrate using the following procedures when MS9740B-002 has been installed.

1. Connect the front-panel Optical Output connector to the Optical Input connector using an SM fiber.
2. Press **F8** to display Others on the horizontal function keys.
3. Press **F5 Others**.
4. Press **f1 Optical Output** to set the light source to On. The front-panel Optical Output lamp lights.
5. Press **F2 Cal**.
6. Press **f4 WI Cal (Ref)**.
7. For MS9740B, optical axis alignment and waveform calibration can be executed simultaneously. Press **f3 Align with cal** to turn it On. When Align with cal is Off, only wavelength calibration is performed.
8. Press **f1 Execute** to display the message indicating calibration in progress.
When Align with cal is On: (Aligning and Calibrating...)
When Align with cal is Off: (Calibrating...)
Press **f2 Cancel** to cancel the calibration.
9. Calibration of the wavelength is finished when Calibrating...message disappears from the screen.

Note:

The performance of the high wavelength accuracy is not guaranteed even when following the above procedures with light sources other than options.

To initialize the calibration data

Return the wavelength calibration data to the factory setting using the following procedures.

1. Press **F8** to display Cal on the horizontal function keys.
2. Press **F2 Cal**.
3. Press **f5 WI Cal (Init)**.
4. Press **f1 Execute** to initialize the wavelength calibration data.

To set automatic calibration:

This function suppresses level and wavelength errors by automatically calibrating the offset in the optical module after measuring the ambient temperature and air pressure.

Use this function as per the following procedures.

1. Press **F8** to display Cal on the horizontal function keys.
2. Press **F2 Cal**.
3. Press **f7 More 1/2**.
4. Press **f2 Auto Cal** to set On.

Subsequently, the level is calibrated automatically after the ambient temperature or pressure changes.

During automatic calibration, the message “Auto Cal in progress” is displayed.

Note:

This auto-calibration function suppresses measurement errors caused by changes in ambient temperature and pressure.

Wavelength calibration may need to be executed manually.

If remote control is used, this function turns Off.

To set Auto Offset adjustment:

When Auto Offset is set to On and a Single (Repeat) sweep is executed, sweeping is executed when offset is calibrated to adjust the offset when VBW is switched.

When Auto Offset is set to Off and a Single (Repeat) sweep is executed, measurement can be performed at high speed because sweeping is performed without executing offset calibration when VBW is switched.

Usually, the offset level changes with temperature. To obtain the highest-accuracy measurement results, we recommend performing offset calibration once every 2 to 3 hours. Execute Zero Cal at this time.

1. Press **F8** to display Cal on the horizontal function keys.
2. Press **F2 Cal**.
3. Press **f7 More 1/2**.
4. Press **f3 Auto Offset** to set On.

When this function is turned off, the message “Auto Offset Off” displays on the screen.

To execute Zero Cal:

Zero Cal performs the same offset calibration as Auto Cal. Run Auto Cal periodically to perform offset calibration when the temperature conditions are met. Press the Zero Cal button to execute offset calibration.

Note:

Zero Cal cannot be executed when Auto Cal is set to On.

1. Press **F8** to display Cal on the horizontal function keys.
2. Press **F2 Cal**.
3. Press **f7 More 1/2**.
4. Press **f4 Zero Cal**.
5. Press **f1 Execute**. The “Calibrating...” message is displayed.
Press **f2 Cancel** to cancel adjustment and return to the status before executing adjustment.
6. Calibration is finished when the “Calibrating...” message disappears from the screen.

3.1.3 Calibrating Resolution

When measuring the level of a continuous spectrum such as the ASE level of an optical fiber amplifier or the noise level of an LD, the measured level is affected by the actual resolution.

The resolution is calibrated to improve the level accuracy of this type of level measurement.

The actual resolution is adjusted using an Anritsu reference light source before shipment. Calibration of the resolution determines the actual resolution matching the light source being used.

Always perform auto-alignment of the optical system before calibrating resolution.

For the definition of actual resolution, refer to 1.3 “Glossary”.

To calibrate resolution

Calibrate resolution using the following procedure.

1. Input light from a light source with the following specifications at the wavelength used at measurement to the main frame.
Level: more than -20 dBm or more
Spectrum: single mode
2. Set the main frame as follows:
Center wavelength: wavelength of the light source
Smplg: 1001
3. Press **F8** to display Cal on the horizontal function keys.
4. Press **F2 Cal**.
5. Press **f7 More 1/2**.
6. Press **f1 Res Cal**.
7. Press **f1 Execute** to display the message “Resolution Cal in progress”.

Note:

Use a single mode oscillation light source such as a DFB laser diode or gas laser.

In addition, always use a light source that meets the specifications. If the light source spectrum is not single mode or the level is too low, calibration may not be performed correctly when performing auto-alignment of the optical system.

Calibrating resolution cannot be interrupted.

The calibration value for resolution is initialized automatically when the measurement conditions are changed.

To initialize the calibrating data

Initialize the actual resolution using the following procedure

1. Press **F8** to display Cal on the horizontal function keys.
2. Press **F2 Cal**.
3. Press **f7 More 1/2**.
4. Press **f1 Res Cal**.
5. Press **f3 Init** to initialize the calibrating resolution data.

3.1.4 Inputting Offset

An offset value can be added to each wavelength and level display.

The offset value is used for the following purposes.

- Correcting wavelength error
- Correcting level error
- Correcting loss of devices such as optical couplers and attenuators inserted between the DUT and main frame

To input wavelength offset

1. Press **F8** to display Cal on the horizontal function keys.
2. Press **F2 Cal**.
3. Press **f1 WI Offset**.
4. Enter the offset value using the keypad or rotary knob.
The wavelength offset value setting range is -1.00 to 1.00 nm.
5. When the wavelength offset is a value other than 0, WI Offset is displayed at the bottom left of the screen.

To input level offset value

1. Press **F8** to display Cal on the horizontal function keys.
2. Press **F2 Cal**.
3. Press **f2 Level Offset**.
4. Enter the offset value using the keypad or rotary knob.
The level offset value setting range is -30.0 to 30.0 dB.
5. When the level offset is a value other than 0, Level Offset is displayed at the bottom left of the screen.

Irrespective of the trace type, level offset can be applied to 10 traces max.

3.2 Connecting DUT

Use an optical fiber cord to connect the optical source for measurement to the optical input connector of the instrument.

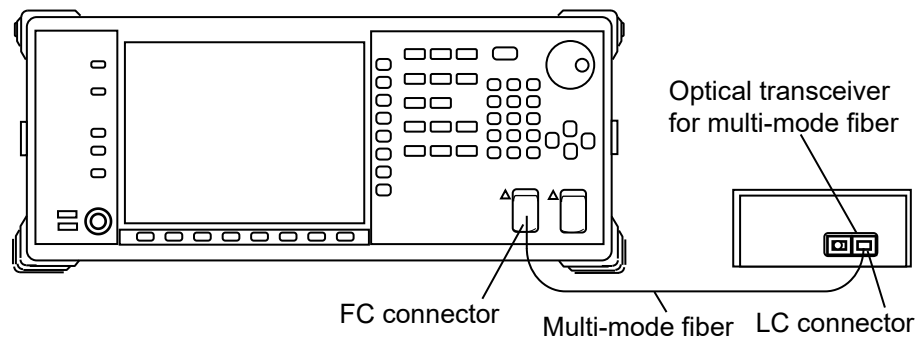

Figure 3.2-1 Connection Example of Optical Transceiver

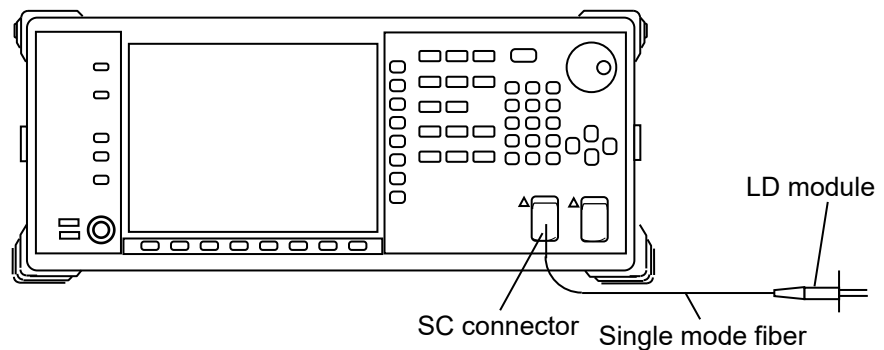

Figure 3.2-2 Connection Example of Laser Diode Module

Notes:

- Accurate measurement is impossible if the optical connectors are dirty. Refer to 7.4 “Optical Connector/Optical Adapter Cleaning”.
- Use an optical fiber cord matching the light source. If a multi-mode light source is connected using single-mode fiber, optical loss will prevent accurate measurement.
- The optical input connector can be changed to match the connector of the fiber used for connection. To replace the optical connector, refer to 7.3 “Replacement of Optical Connector”.

3.3 Inputting Data

The following keys are used to input data.

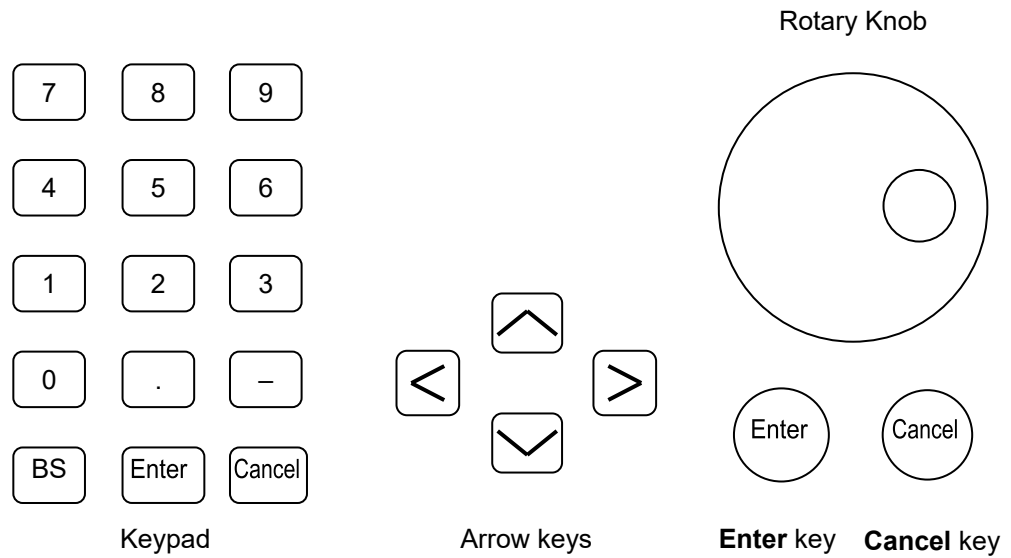

Figure 3.3-1 Data Input Keys and Rotary Knob

Keypad

- (Minus) Changes sign of numeric value
- BS** (Back space) Deletes preceding character at the left side of the cursor
- Enter** Sets input
- Cancel** Cancels input

Arrow key

Moves cursor and changes numeric values

Rotary knob

Moves cursor and changes numeric values

Enter and **Cancel** under the rotary knob have the same functions as the **Enter** and **Cancel** keys in the keypad.

3.4 Measurement Types

There are three kinds of the measurement methods.

Automatic measurement

Automatically sets wavelength, resolution and level and performs measurement

Single measurement

Sweeps waveform once

When the trace Storage Mode is set to Sweep Average, Min Hold, or Max Hold, waveform sweeping is performed for the number of times set at Sweep Average.

Repeat measurement

Waveform sweeping is repeated until the **Stop** is pressed.

Perform the automatic measurement:

Press **Auto Measure** to perform automatic measurement.

The following processes are performed during automatic measurement:

- Peak wavelength, peak level and spectrum half-width of optical input detected
- Wavelength range and resolution adjusted
- Level scale adjusted and results displayed

Note:

The automatic measurement may not be performed correctly in the following cases.

- The peak level of the input light is too low.
- The level or wavelength of the input light is unstable.

Perform the single measurement:

Press **Single** to perform the single measurement.

Perform the repeat measurement;

Press **Repeat** to perform the repeat measurement.

Stop the measurement:

Press **Stop** to stop the measurement.

3.5 Changing Wavelength and Resolution

This section explains how to change the wavelength and resolution on the horizontal axis of the screen.

3.5.1 Changing Wavelength

To change the screen center wavelength

1. Press **Center**.
2. Enter the center wavelength using the rotary knob or keypad. The input setting range is from 600 to 1750 nm.

To set the wavelength with the maximum level at the screen center:

1. Press \rightarrow **Center**.

To change the range of the screen width:

1. Press **Span**.
2. Input the value using **f1** through **f7**, rotary knob, or keypad. The input setting range is 0 and from 0.2 to 1200 nm.

3.5.2 Changing Resolution

1. Press **Res**.
2. Enter the resolution using **f1** through **f5**.

3.6 Setting Level Scale

To set the level scale, the vertical axis on the screen is set.

3.6.1 Changing Scale

1. Press **Log (/div)**.
2. Input the scale per division using **f1** through **f7** keys or the rotary knob. The input setting range is 0.1 to 10 dB.

3.6.2 Changing Reference Level

1. Press **Ref**.
2. Input the reference level using the rotary knob or keypad. The input setting range is +30 to -90 dBm.

Note:

When the **Ref** key is pressed when the scale is linear display, a message dialog box indicating that the reference level cannot be set is displayed. Press **Log (/div)** to change the display item to the log.

To set the wavelength peak level at the reference level, press \rightarrow **Ref Lvl**.

3.7 Using Markers

The trace data can be read using markers.

3.7.1 Marker types

There are following markers in the MS9740B.

Wavelength marker

Used to read waveform, wavelength and wavelength difference

The following data can be read.

- Wavelength at waveform peaks and dips
- Difference in wavelength between peaks for waveforms with several peaks
- Spectrum width

Level marker

Used to read waveform, level and level difference

The following data can be read.

- Level at waveform peaks and dips
- Difference in level between peaks for waveforms with several peaks
- Difference in level of two waveforms

Trace marker

Used to read wavelength and level of any point

The following data can be read.

- Wavelength and level at waveform peaks and dips

Delta marker

Used to read difference in wavelength and level from trace marker position.

The following data can be read.

- Difference in wavelength and level between peaks for waveforms with several peaks

Zone marker

The zone marker can be used for the following purposes.

- Limit wavelength range for analysis such as peak point search
The zone marker analyze and process the part surrounded with the red frame (refer to Figure 3.7.1-5).
- Zooming in waveform wavelength direction
The zone marker enlarge the display of the range surrounded with the red frame (refer to Figure 3.7.1-6).

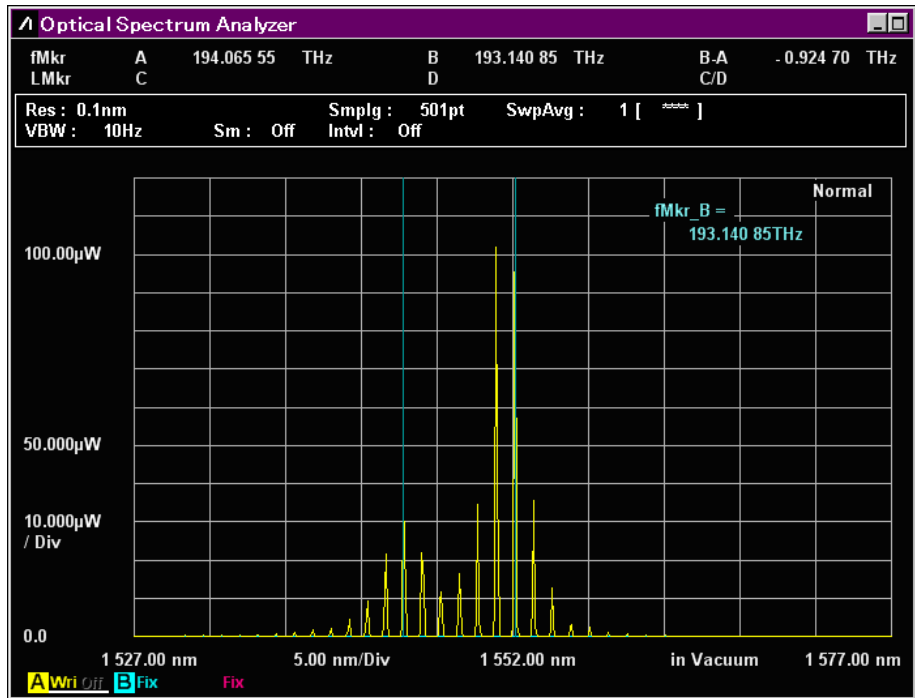

Figure 3.7.1-1 Waveform Marker Display

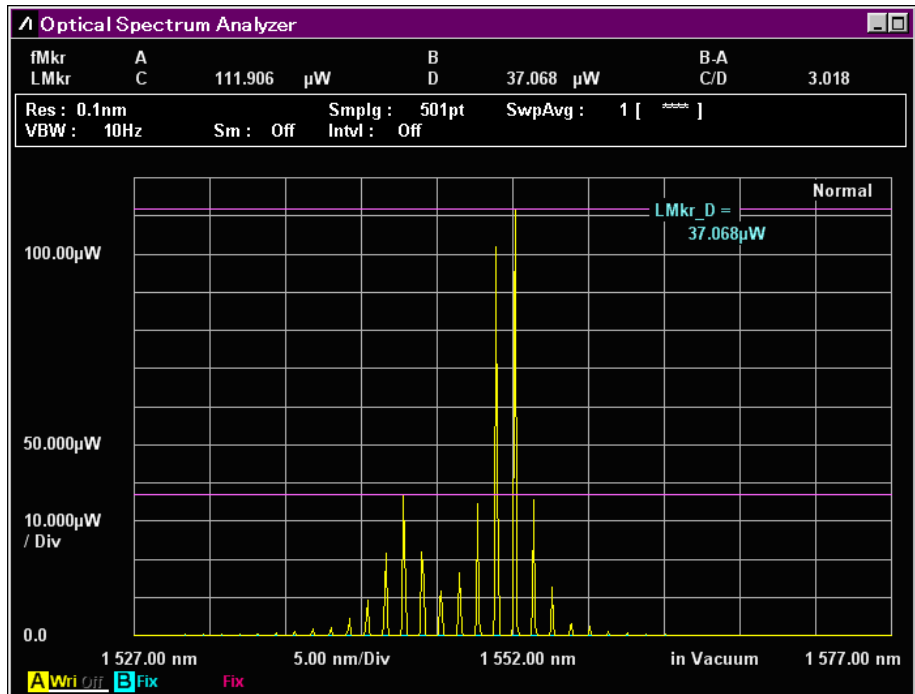

Figure 3.7.1-2 Level Marker Display

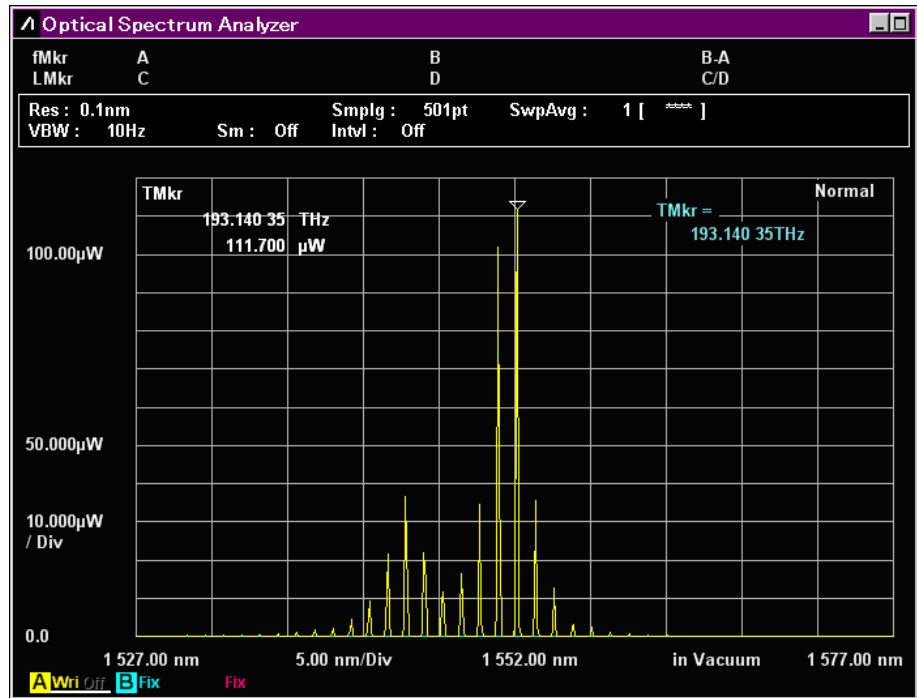

Figure 3.7.1-3 Trace Marker Display

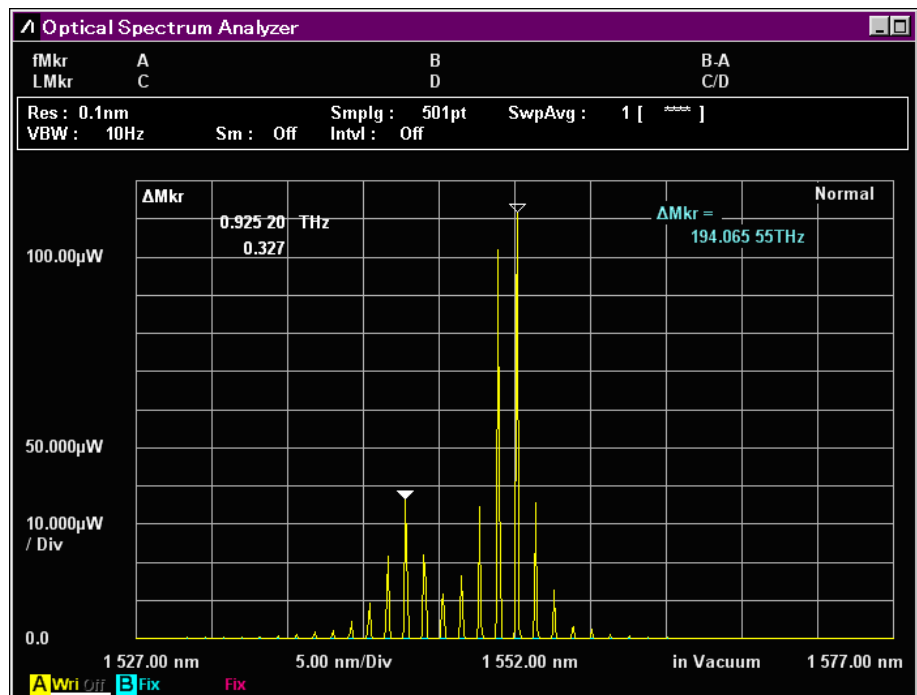

Figure 3.7.1-4 Delta Marker Display

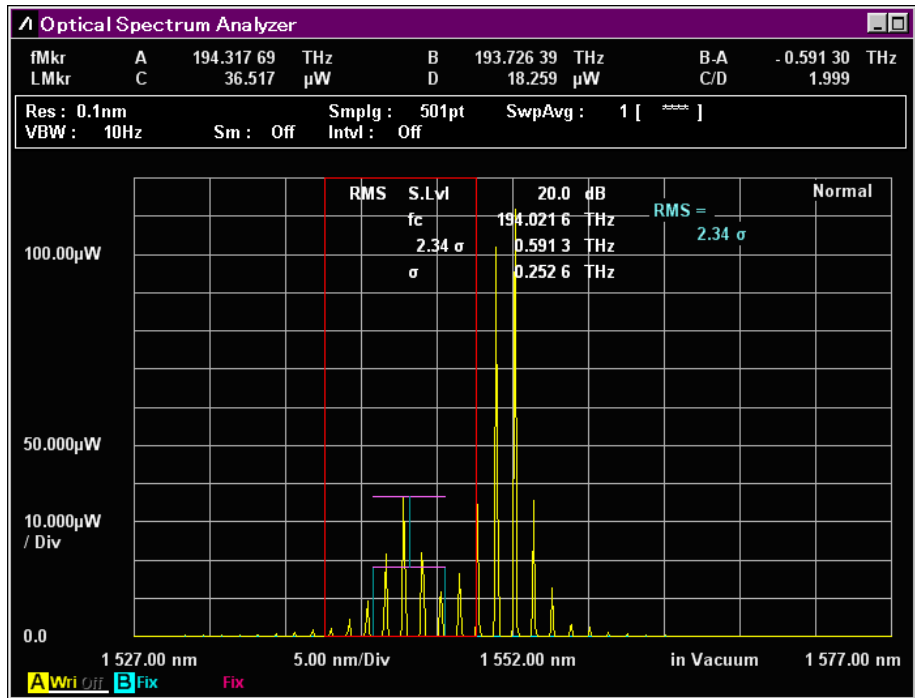
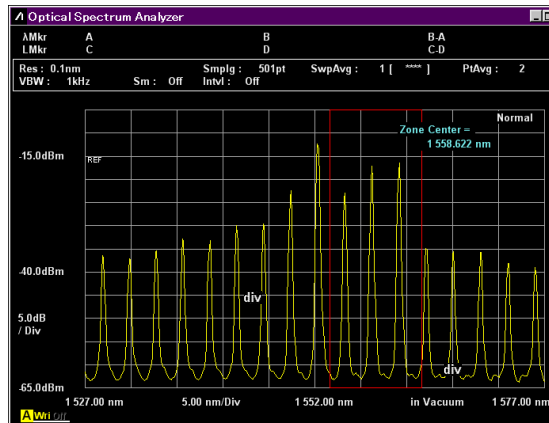

Figure 3.7.1-5 Analysis Range Limited By Zone Markers



Zoom In

Zoom Out

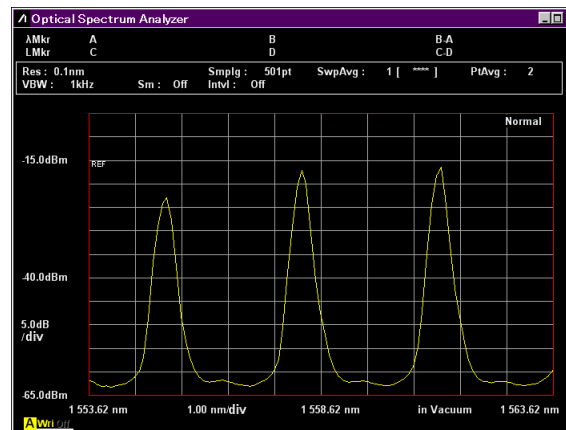

Figure 3.7.1-6 Enlarged Zone Marker Display

3.7.2 Using Wavelength and Level Markers

To display the markers reading wavelength and level:

1. Press **Marker Select**.
2. Select the marker with **f1** through **f6**.
f1 λ Mkr_A: wavelength marker A
f2 λ Mkr_B: wavelength marker B
f3 LMkr_C: level marker C
f4 LMkr_D: level marker D
f5 TMkr: trace marker
f6 Δ Mkr: delta marker
3. Turn the rotary knob to move the marker.
4. The marker wavelength and level is displayed in the marker display field.
5. Press **Marker Select** and select **f7 Erase** to delete the marker.

Note:

f5 TMkr and **f6 Δ Mkr** can be used when the active trace is displayed.
The marker is not displayed when the power monitor is displayed.
Instead of **λ Mkr**, **fMkr** is displayed at the frequency display.

To display the marker at the peak level position:

Press **Peak Search**.

The trace marker is displayed at the peak level position.

3.7.3 Using Zone Markers

Setting zone markers restricts the peak and dip point search range (4.4 “Displaying Level Peaks and Dips”) and the waveform analysis range (4.5 “Analyzing Waveform”) and expands the on-screen display.

1. Press **Zone Marker**.
2. Press **f1 Zone Center**.
3. Enter the center wavelength of the zone marker using the rotary knob and keypad.
4. Press **f2 Zone Width**.
5. Enter the zone marker width using the **f1** through **f5**, rotary knob and keypad.
6. Press **f4 Zoom Out/In** to enlarge the display of the zone marker range. Press **f4 Zoom Out/In** again to return the previous display.
7. When pressing **f3 Zone** → **Span**, the zone marker width is set to Span. In this case, the display cannot be returned the non-enlarged previous one.
8. Press **f7 Erase** to delete the zone marker.

3.8 Saving and Reading Data

The following data is saved to the file:

- Measured data and measurement condition
- Measured data
- Screen display

The files saving the measured data and measurement condition can be read.

Files can be saved in the following three formats.

- CSV text files with comma separators. This file type is ideal for reading with spreadsheet software and text editors. Files saved in CSV format cannot be read using the **Recall** function.
With **Save CSV**, only the active trace is saved. With **Save CSV All**, all traces are saved.
- XML(Extended Markup Language) text files with syntax. These files can be both saved and read.
- Image files with either the bmp or png extensions. These files are ideal for reading with word-processing or graphics-editing software.
Files saved in the Image format cannot be read using the **Recall** function.

Note:

The data saved by MS9740B cannot be read out by MS9740A of V1.06.02 or older.

3.8.1 Saving Measurement Conditions and Waveform Data

To input the file name and save the file:

1. Press **F6 Config** at the horizontal menu.
2. Press **f2 Copy Setting** to set File Name Settings to **User-Specified Name**.
3. Press **f7 Set**.
4. Press **Save**.
5. Press **f1 Device** to open the device selection window.
6. Select the destination device using the arrow key.
7. Press **f7 Set**.
8. Select the file format using **f3 Save CSV All**, **f4 Save CSV**, or **f5 Save XML**.
9. Enter the file name using the following procedures:
 - a. Select the displayed characters on the dialog box using the rotary knob.
 - b. Press **Enter** to confirm the characters.
 - c. Move the cursor using the arrow key to change the characters. Select the displayed characters on the dialog box using the rotary knob.
 - d. Press **f7 Set** to confirm the file name.

Steps 1 and 2 are not required for second and subsequent operations.

Note:

If the save destination is external USB flash drive, the path [\Anritsu Corporation\Optical Spectrum Analyzer\User Data] is created automatically in the USB flash drive root directory.

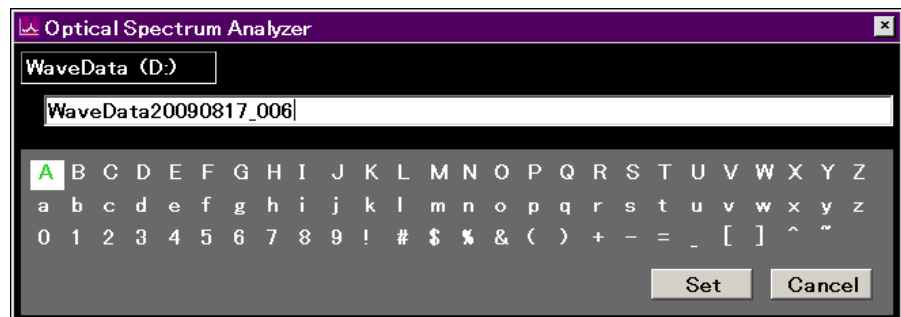

Figure 3.8.1-1 File Name Input Dialog Box

Select the characters on the dialog box to enter the file name. A copied file name cannot be pasted into the dialog box.

Automatically Creating File Name and Saving File

If the file name is created automatically, inputting the file name at the dialog box can be omitted.

Select Data + sequence number (000-999) at step 2 of the Input File Name and Save File procedures. When **Save** is pressed at this time, the dialog box of step 6 is not displayed and the automatically created file name is saved.

The saved file name is as follows:

XML format file:

AllWaveData + date + "_" + consecutive-number.xml

Example: AllWaveData20190409_004.xml

CSV format file:

WaveData + date + "_" + consecutive-number.csv

Example: WaveData20190410_001.csv

Note:

The level of waveform data saved to a CSV file is a linear value in mW units. Low levels may be displayed prefixed by a negative (–) sign.

In this equipment, the average value of measured noise is level 0 so any noise level lower than the average value is displayed as a negative value. The level of the optical input to the equipment is not negative.

Only the analysis result described in the following section is output to the csv.files saved with **f3 Save CSV All**.

- 5.5 “Measuring WDM (Wavelength Division Multiplexed) Signals”
- 5.8 “Measuring Optical Amplifier (Wavelength Division Multiplex)”

Only the analysis result described in the following section is output to the csv.files saved with **f4 Save CSV**.

- 5.5 “Measuring WDM (Wavelength Division Multiplexed) Signals”

3.8.2 Saving Screens

Pressing **Copy** saves the screen display to a file.

The file extension, name and save destination folder can be set at the **Copy Settings** described in Section 6.1.1 “Setting Interfaces and File Operating Environment”.

When a USB flash drive is connected, you can specify it as a save destination. Refer to 6.2 “Managing Files” for details.

The procedure is the same as described in Section 3.8.1 “Saving Measurement Conditions and Waveform Data” where automatic or manual input of the file name can be selected. When automatic is set, the file name has the following structure:

Copy + date + "_" + consecutive-number.bmp

Example: Copy20190410_000.bmp

3.9 Initializing Measurement Conditions

Initialize the MS9740B measurement conditions.

1. Press **Preset** .
2. Press **f1 Preset**.

For the initialized conditions and values, refer to Appendix B “Initial Values”.

At the same time that measurement conditions are initialized, waveforms are erased from display. Measurement results described in Chapter 5 “Measurement Functions” are cleared as well.

Waveform data saved to a file is not deleted when the measurement conditions are initialized.

3.10 Releasing Panel Lock

When this instrument is under remote control, panel keys except the **Power** and **Local** keys are disabled. This is called the panel lock state.

Press **Local** to disable the panel lock.

The panel is locked again at remote control after the panel lock has been previously released.

Chapter 4 *Changing Measurement Conditions*

This chapter explains how to change the measurement conditions using the function keys.

4.1	Wavelength-related Settings.....	4-2
4.2	Setting Level Display	4-5
4.3	Changing Data Capturing Method	4-7
4.4	Displaying Level Peaks and Dips	4-11
4.5	Analyzing Waveform.....	4-13
4.5.1	Analyzing Single Spectrum Center Wavelength and Spectrum Width.....	4-14
4.5.2	Analyzing Single Spectrum SMSR.....	4-15
4.5.3	Analyzing Multiple Spectrum Center Wavelength and Spectrum Width (ndB Loss Method)	4-16
4.5.4	Analyzing Multiple Spectrum Center Wavelength and Spectrum Width (Envelope Method).....	4-17
4.5.5	Analyzing Multiple Spectrum Center Wavelength and Spectrum Width (RMS Method)	4-18
4.5.6	Measuring Spectrum Power by Integration	4-20
4.5.7	Erasing Analysis Results.....	4-21
4.6	Changing Waveform Memory Settings and Calculation between Memories	4-22
4.7	Changing Measurement Mode	4-27
4.8	Inputting Title to Waveform Data	4-31
4.9	Using Light Source Option.....	4-32

4.1 Wavelength-related Settings

Press **F1 Wavelength** key to set the wavelength related to Figure 4.1-1.

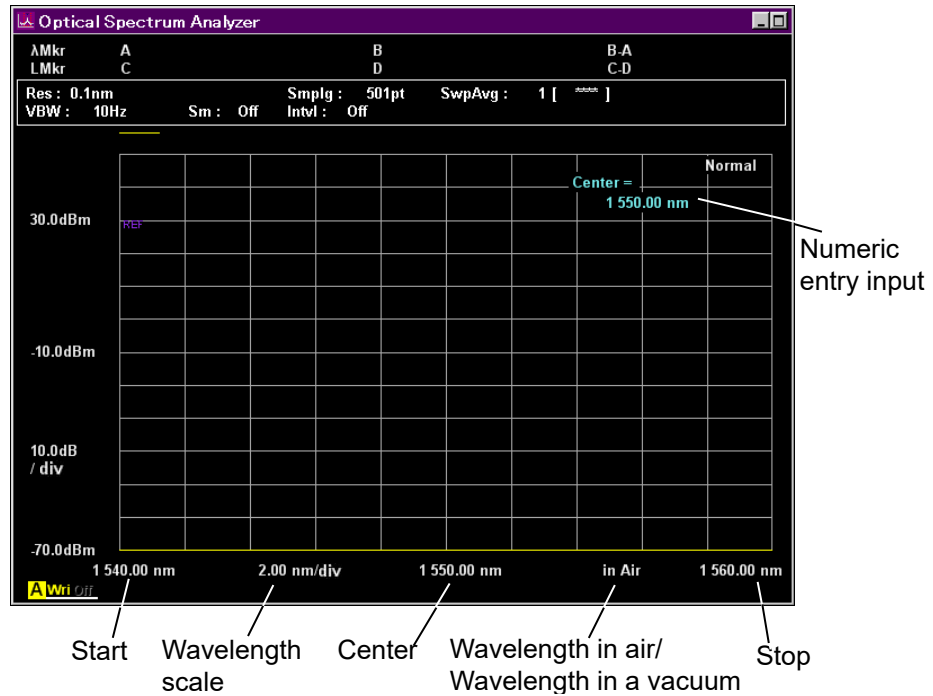

Figure 4.1-1 Names of Wavelength Display

To set screen display Center wavelength:

1. Press **f1 Center** or **Center**.
The current Center is displayed in the setting value input field.
2. Enter the wavelength using the rotary knob or keypad.
The Center setting range is 600 to 1750 nm.

Note:

The Start and Stop are also changed when the Center is changed.

To set screen wavelength sweep or span:

1. Press **f2 Span** or **Span**.
The current Span is displayed in the setting value input field.
2. Select the numeric value from **f1** to **f6** or enter the value using the rotary knob or keypad.
The Span setting range is 0 nm, or from 0.2 nm to 1200 nm.

Note:

The Start and Stop are also changed when the Span is changed.
When Span is set to 0 nm, the same wavelength data is displayed as a graph in the time domain.

To set left screen wavelength start:

1. Press **f4 Start**.
2. Enter the wavelength using the rotary knob and keypad.

The Start setting range is from 600 to 1750 nm.

Input a smaller wavelength than the Stop value.

Note:

The Center and Span are also changed when the Start is changed.

To set right screen wavelength stop:

1. Press **f5 Stop**.
2. Enter the wavelength using the rotary knob and keypad.

The Stop setting range is from 600 to 1800 nm.

Input a larger wavelength than the Start value.

Note:

The Center and Span are also changed when the Stop is changed.

To change position of wavelength displayed at marker:

This function switches the wavelength of the trace markers, delta markers and analysis part to frequency display.

1. Press **f6 MkrValue Wl/Freq**.
2. At wavelength display, λ Mkr is displayed at the screen top left.
At frequency display, fMkr is displayed at the screen top left.

The frequency f (Hz) is calculated using the following equation:

$$f = c/\lambda$$

c : Speed of light 2.99792458×10^8 (m/s)

λ : Wavelength in vacuum (m)

Note:

The following items are not displayed in the Frequency unit.

- Zone marker
- Application result
- Graph x-axis
- Center/Span/Start/Stop setting

To switch wavelength display:

The wavelength in a vacuum can be displayed using the index of refraction in air determined by the MS9740B internal temperature and pressure.

1. Press **f7 Value in Air/Vacuum**.
2. When displaying the wavelength in air, **in Air** is displayed between **Center** and **Stop**. When displaying the wavelength in vacuum, **in Vacuum** is displayed between **Center** and **Stop**.

Note:

When selecting frequency at marker frequency display, the waveform display switches to the value in vacuum (**in Vacuum**).

4.2 Setting Level Display

Press **F2 Level Scale** key to set the level display.

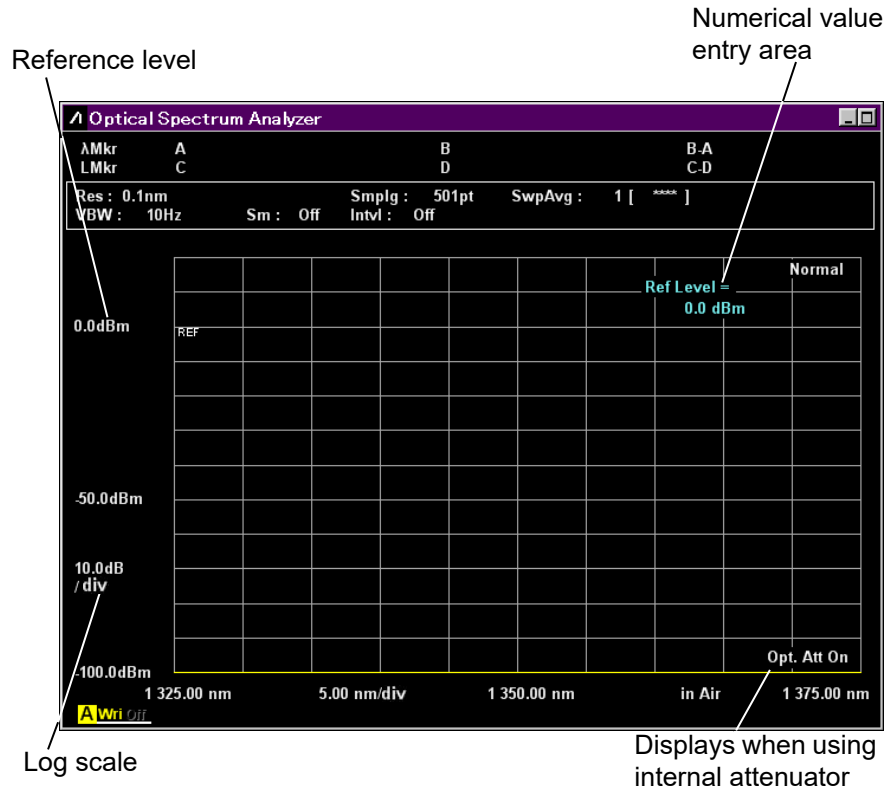

Figure 4.2-1 Name of Level Display

To set log scale:

Set Level Scale to Log Scale and set the scale ratio to dB units.

1. Press **f1 Log (/div)** or **Log (/div)**.
The current log scale is displayed in the setting value input field.
2. Select the numeric value from **f1** to **f7** or enter the value using the rotary knob or keypad.
The log scale setting range is 0.1 to 10 dB.

To set reference level:

When Level Scale is set to Log Scale, the reference level is called Reference Level.

Note:

When Linear Scale is set, the bottom of the vertical axis become 0 W and cannot be changed.

1. Press **f2 Ref Level** or **Ref**.
The current reference level is displayed in the setting value input field.
2. Enter the value using the rotary knob or keypad.

Press \rightarrow **Ref Lvl** to set the maximum level of waveform to the reference level.

The setting reference level range is as follows.

Normal display: -90 to +30 dBm
Relative display: -100 to +100 dB

To set linear scale

1. Press **f4 Linear Level**.
The current settings are displayed in the setting value input field.
2. Select the value from **f1** to **f6**, or enter the value using the rotary knob or keypad.

The setting linear scale range is as follows.

Normal display: 1 pW to 1 W
Relative display: 1 to 200 %

To set internal optical attenuator:

When the optical level is 10 mW (+10 dBm) or more, set the internal optical attenuator as follows:

1. Press **f6 Opt.Att On/Off**.
2. When using the optical attenuator, **Opt. ATT On** is displayed in the lower right of the screen.
3. Press **f6 Opt.Att On/Off** again to release the settings of the optical attenuator.

4.3 Changing Data Capturing Method

The following measurement conditions can be set.

Resolution

This sets the optical wavelength resolution for measuring the optical spectrum (wavelength resolution determined by built-in grating). The actual resolution at the Center wavelength can be displayed. For the resolution and actual resolution, refer to 1.3 “Glossary”.

VBW

This sets the bandwidth of the internal optical receiver amplifier. A narrower VBW reduces noise. Set a wider bandwidth when measuring modulated light.

Averaging

This suppresses randomly generated noise. There are three types of averaging processing: point average, sweep average, and smoothing. Point and sweep averaging suppress noise by performing repeated measurements and averaging the results.

- Point average:
Performs measurement for set number of times at each sampling point and finds average
- Sweep average
Performs wavelength sweeping for set number of times and finds average from each measured data

The sweep average is calculated by the following formula.

When sweep count < sweep average set count:

$$Y(n) = \frac{(n-1) \times Y(n-1) + M(n)}{n}$$

When sweep count \geq sweep average set count:

$$Y(n) = \frac{(N-1) \times Y(n-1) + M(n)}{N}$$

Y (n): Average value, M(n): Measurement value, N: Sweep average setting count, n: Sweep count

Smoothing suppresses noise by averaging multiple data in the wavelength direction.

Two or more average processing can be performed simultaneously.

Sampling Point

This sets the data points captured at one measurement. When there are many sampling points, the measured data wavelength interval becomes smaller and the measurement time becomes longer.

The data capture method is displayed in the measurement condition display field.

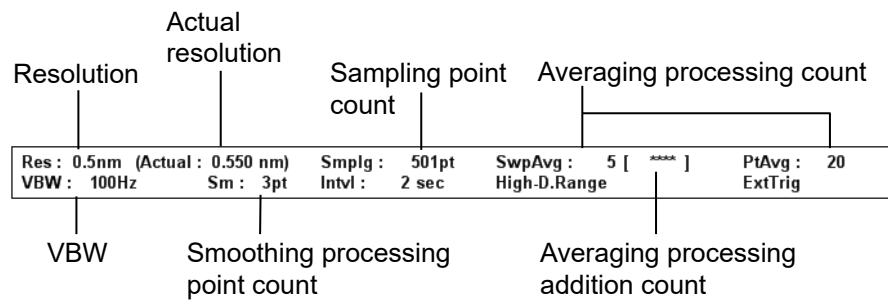

Figure 4.3-1 Measurement Condition Display Field

Press **F3 Res/VBW/Avg** key to set the data acquiring method.

To set resolution (Res):

1. Press **f1 Res**.
2. Select the value from **f1** to **f7**.

To set VBW:

1. Press **f2 VBW**.
2. Select the value from **f1** to **f6**. Alternatively, press **f8 More 1/2**, and select a value from **f1** to **f4**.

When the VBW is narrow, the waveform noise is reduced but the measurement time becomes longer. The relationship between VBW and measurement time is shown in Appendix E VBW Band Width and Sweep Speed.

To set Point Average:

1. Press **f3 Point Average**.
2. Enter the value using the rotary knob and keypad and press **f7 Set**. The averaging count is 2 to 1000.
3. Press **f2 Off** to release the averaging processing.

When Point Average is changed, the change results are reflected in the measurement method even during sweeping.

To set Sweep Average:

1. Press **f4 Sweep Average**.
2. Input the value using the rotary knob and keypad and press **f7 Set**.
The averaging count is 1 to 1000.
Averaging is not performed when 1 is set.
3. Press **F6 Trace**.
4. Press **f1 Active Trace**.
5. Select the trace to be averaged.
6. Press **f2. Trace Type**.
7. Select **f1 Write**.
8. Press **f3 Storage Mode**.
9. Select **Sweep Average**.

If the following items are changed during measurement, the averaging count returns to 1.

- Center
- D.Range
- Ext.Trig
- Opt.Att
- Sampling Points
- Res
- Span
- Start
- Stop
- VBW

To set smoothing process:

1. Press **f5 Smooth**.
2. Select the numeric value from **f2** to **f6**.
3. Press **f1 Off** to release the smoothing processing.

In the smoothing processing, the graph line is smoothed using the exact smoothing points and the averaging points of before and after the smoothing points. The MS9740B can set the number of the exact smoothing points and before and after its smoothing points; increasing the smoothing points increases the deformation of the measured waveform.

To set sampling point count:

1. Press **f6 Sampling Points**.
2. Select the numeric value from **f1** to **f6**.

The sampling point count is the number of points within the sweep width where data is captured. When the number of sampling points is small, the measurement time is shorter. However, sometimes the measurement may be inaccurate, depending on the relationship between the sweep width and the resolution. Set the number of sampling points so that the following relationship is satisfied.

If the number of sampling points is smaller than the right-hand value, "Res Uncal" is displayed on the right lower side of the screen.

$$P \geq \text{Span} / \text{Res} + 1$$

P: Sampling point count
Span: Sweep width (nm)
Res: Resolution (nm)

Example: When the resolution is 0.1 nm at a sweep width of 50 nm,
 $P \geq 50/0.1 + 1 = 501$.
Set 501 or more sampling points at this time.

The internal minimum resolution is 1 pm. If a smaller resolution is set, the waveform will be displayed at a resolution of 1 pm.

To display actual resolution:

1. Press **f7 Act-Res On/Off**.
The measurement condition field displays the actual resolution at the Center wavelength.

4.4 Displaying Level Peaks and Dips

The MS9740B has search functions for finding the maximum and minimum waveform levels and peak and dip points. These functions are executed at the Active Trace.

Additionally, if the zone markers are displayed, the data between the zone markers is the target data for searching position. The target of analysis is data displayed on the screen. Changing Span may sometimes mean some data is not displayed and peak and dip points in this non-displayed data will not be searched.

Press **F4 Peak/Dip Search** key to use this function.

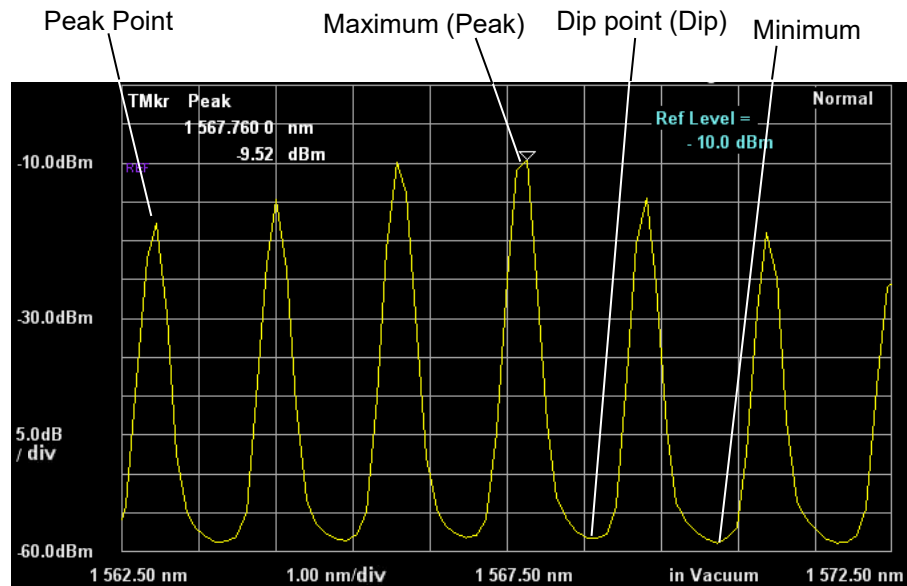

Figure 4.4-1 Waveform Peaks and Dips

To display peak point:

Press **f1 Peak Search**.

The position on the waveform with the maximum level is indicated by the trace marker.

To display dip point

Press **f2 Dip Search**.

The position on the waveform with the minimum level is indicated by the trace marker.

To display peak point in ascending order or dip point in descending order:
Press **f4 Next**.

At peak point display, the trace marker moves to the next peak level. At dip point display, the trace marker moves to the next dip level.

To display peak point in descending order or dip point in ascending order:
Press **f5 Last**

At peak point display, the trace marker moves to the previous peak level. At dip point display, the trace marker moves to the previous dip level.

To display peaks and dips to left of current position:
Press **f6 Left**.

The trace marker moves to the next peak or dip on the left.

To display peaks and dips to right of current position:
Press **f7 Right**.

The trace marker moves to the next peak or dip on the right.

To release peak/dip display:
Press **f3 Off**.

To set threshold that detects peak and dip points.

1. Press **f8 More 1/2**.
2. Press **f1 Search Threshold Auto Manual**, select **Manual**.
3. Set **f2 Search Threshold**.
Peak and dip points are detected with the specified threshold.

Notes:

- Peak and dip points are detected automatically, regardless of Search Threshold setting values.
- Search Threshold setting values are used for the threshold to detect next higher peak point or next lower dip point.

To display Peak to Peak of peak/dip points.

1. Press **f8 More 1/2**.
2. Set **f4 Peak to Peak Calculation** to On.
Peak to Peak level is displayed on the screen, and the color of peak/dip points change.

4.5 Analyzing Waveform

The spectrum waveform center wavelength, half width, side mode suppression ratio and spectrum integrated power can be analyzed.

This function is executed at the Active Trace. In addition, when the zone markers are displayed, data between the zone markers is searched. The target of analysis is data displayed on the screen. Changing Span may sometimes mean some data is not displayed and this non-displayed data cannot be analyzed.

Press **F5 Analysis** key to use this function.

4.5.1 Analyzing Single Spectrum Center Wavelength and Spectrum Width

1. Press **f1 Threshold**.
2. Select the cut level from **f1** to **f4** and enter the value using the rotary knob or keypad. The cut level, which is an attenuator from the peak level, can be used to calculate the spectrum width.
The cut level input range is 0.1 to 50 dB.
3. The cut level, center wavelength (λ_c) and spectrum width ($\Delta\lambda$) are displayed.

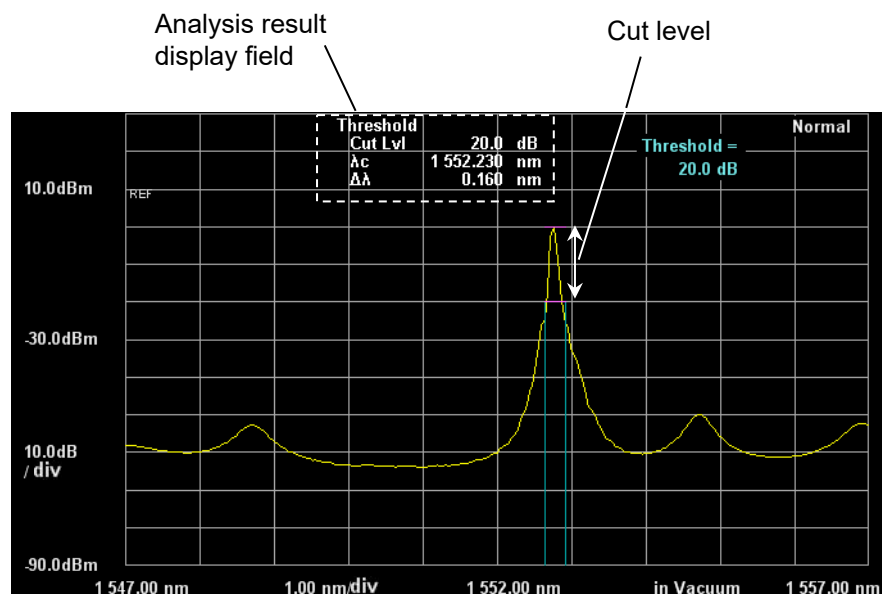

Figure 4.5.1-1 Threshold Analysis

The center wavelength (λ_c) and spectrum width ($\Delta\lambda$) are calculated by the following formula.

$$\lambda_c = (\lambda_1 + \lambda_2)/2$$

$$\Delta\lambda = \lambda_2 - \lambda_1$$

- λ_1 : Shortest wavelength in all wavelengths crossed with the level lowered cut level from the peak level
- λ_2 : Longest wavelength in all wavelengths crossed with the level lowered cut level from the peak level

If there are no crossing wavelengths with the cut level, the following values are displayed:

λ_c : Center wavelength (Center)

$\Delta\lambda$: Wavelength difference between right and left sides (Span)

4.5.2 Analyzing Single Spectrum SMSR

The Side Mode Suppression Ratio (SMSR) is the ratio of the spectrum peak and adjacent mode spectrum levels.

1. Press **f3 SMSR**.
2. Select the side mode from **f1** to **f3**.
 2nd Peak: Next highest side mode from maximum level
 Left: Peak point at short-wavelength side of max. level
 Right: Peak point at long-wavelength side of max. level
3. The selected side mode search method, wavelength difference $\Delta\lambda$ and level difference ΔI are displayed. ΔI is the SMSR.

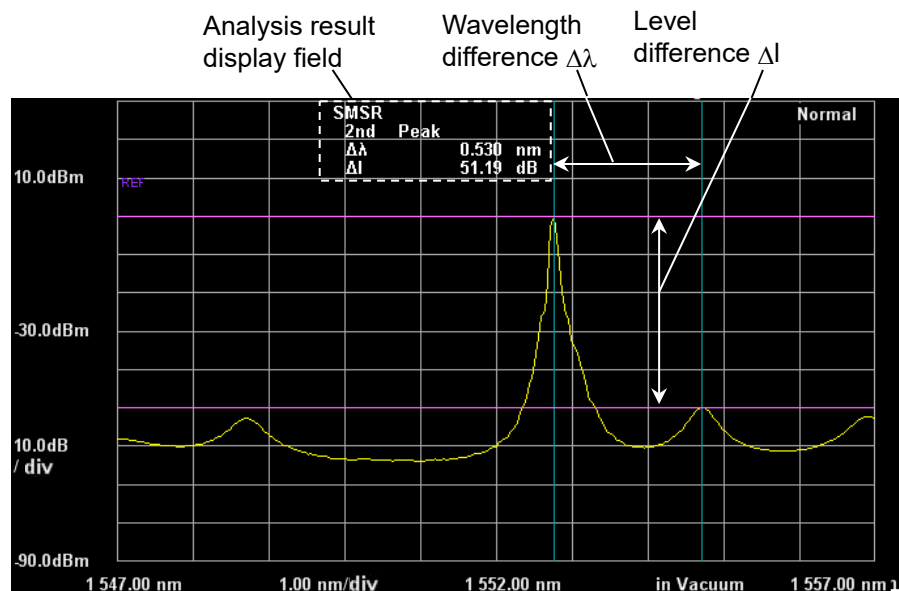

Figure 4.5.2-1 SMSR Analysis

The peak wavelength and side mode wavelength at marker A and B are displayed.

The wavelength difference between marker B and A is displayed as the wavelength difference $\Delta\lambda$.

The peak level and side mode level at marker C and D are displayed.

The level difference between marker C and D is displayed as the wavelength difference ΔI .

4.5.3 Analyzing Multiple Spectrum Center Wavelength and Spectrum Width (ndB Loss Method)

In the ndB Loss method, the level of the part that is ndB loss below the peak level is the threshold level. The center wavelength, spectrum width and vertical oscillation mode count from the spectrum of the vertical oscillation mode exceeding the threshold level is analyzed.

1. Press **f2 ndB Loss**.
2. Select the loss from **f1** to **f4** and enter the value using the rotary knob and keypad.
The loss input range is 0.1 to 50 dB.
3. The loss, center wavelength λ_c , spectrum width $\Delta\lambda$ and vertical oscillation mode count N are displayed.

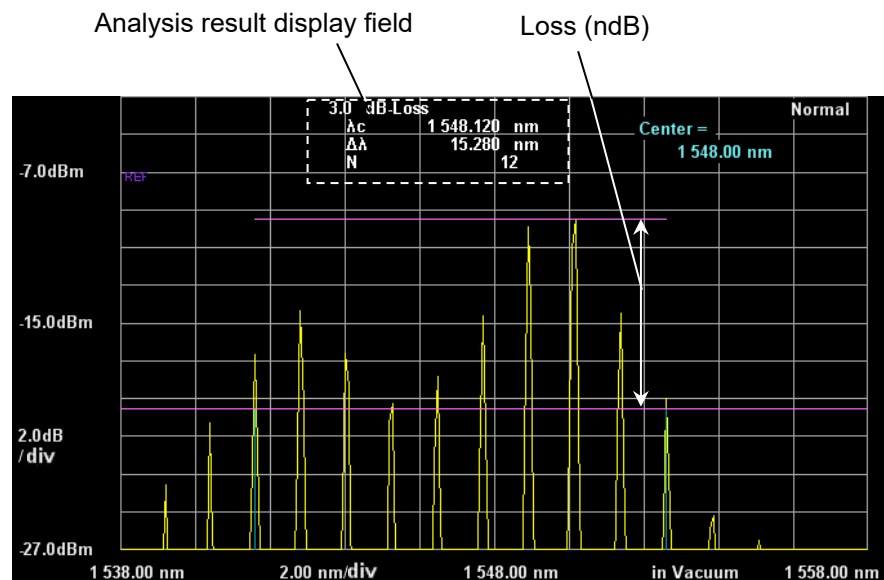

Figure 4.5.3-1 ndB Loss Analysis

The center wavelength (λ_c) and spectrum width ($\Delta\lambda$) are calculated by the following formula.

$$\lambda_c = (\lambda_1 + \lambda_2)/2$$

$$\Delta\lambda = \lambda_2 - \lambda_1$$

λ_1 : Peak point wavelength counted from the shortest wavelength in all wavelengths crossed with the level lowered loss from the peak level

λ_2 : Peak point wavelength counted from the longest wavelength in all wavelengths crossed with the level lowered loss from the peak level

The vertical oscillation mode count N is the number spectra for levels higher than Level Marker D.

4.5.4 Analyzing Multiple Spectrum Center Wavelength and Spectrum Width (Envelope Method)

In the Envelope method, an envelope is drawn linking the spectrum peak points. The center wavelength and spectrum width are analyzed from the wavelength of the intersection between the envelope line and the cut level part lower than the peak level as well as the spectrum width are analyzed.

The envelope is displayed when the vertical axis is linear scale.

1. Press **f4 Envelope**.
2. Select the cut level from **f1** to **f4** or enter the value using the rotary knob or keypad.
The cut level input range is 0.1 to 20 dB.
3. The cut level, center wavelength λ_c , spectrum width $\Delta\lambda$ are displayed.

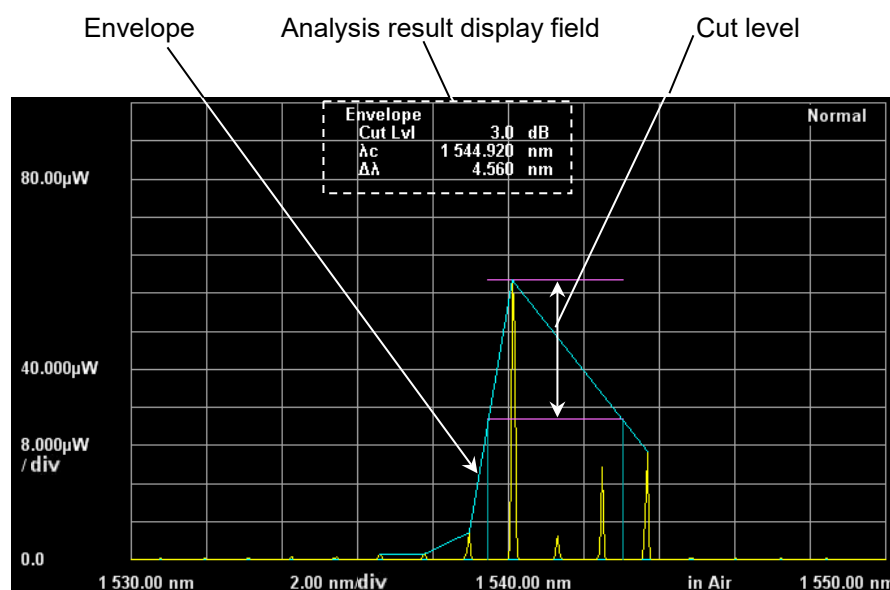

Figure 4.5.4-1 Envelope Analysis

The center wavelength (λ_c) and spectrum width ($\Delta\lambda$) are calculated by the following formula.

$$\lambda_c = (\lambda_1 + \lambda_2)/2$$

$$\Delta\lambda = \lambda_2 - \lambda_1$$

- λ_1 : Shortest wavelength in all wavelengths crossing the level with the level lowered cut level from the peak level and the envelope
- λ_2 : Longest wavelength in all wavelengths crossing the level with the level lowered cut level from the peak level and the envelope

4.5.5 Analyzing Multiple Spectrum Center Wavelength and Spectrum Width (RMS Method)

In the RMS method, the center wavelength and standard deviation (σ) are found from the spectrum with a level exceeding the slice level. The value of the standard deviation (σ) multiplier (k) is displayed as the spectrum half width.

1. Press **f5 RMS**.
2. Either select the k multiplier for the standard deviation (σ) using the **f1** to **f5** keys or input the value using the rotary knob or keypad. The input multipliers are 1.00 to 10.00.
3. Press **f6 S.Level**.
4. Enter the slice level value using the rotary knob or keypad. The cut level input range is 0.1 to 50 dB.
5. The ratio, center wavelength λ_c , spectrum width $k\sigma$ are displayed.

Analysis Result Display Field

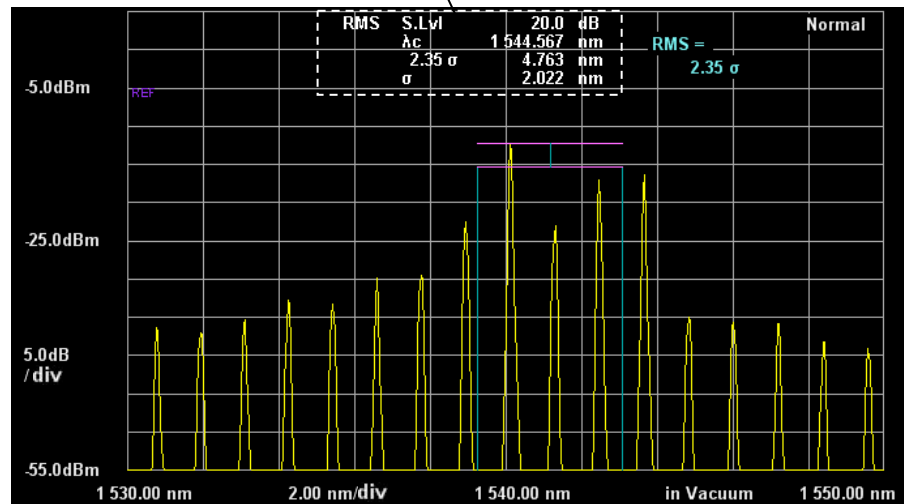

Figure 4.5.5-1 RMS Analysis

The center wavelength (λ_c) and standard deviation (σ) are calculated by the following formula.

$$\lambda_c = \frac{\sum_{i=1}^n A_i \lambda_i}{\sum_{i=1}^n A_i} = \frac{A_1 \lambda_1 + A_2 \lambda_2 + \dots + A_n \lambda_n}{A_1 + A_2 + \dots + A_n}$$

$$\sigma = \sqrt{\frac{\sum_{i=1}^n \{A_i \times (\lambda_i - \lambda_c)\}^2}{\sum_{i=1}^n A_i}}$$

- A_i: Level of i-th peak point of spectrum exceeding the level lowered slice level from peak level. The setting unit is W.
- λ_i: Wavelength of i-th peak point of spectrum exceeding the level lowered slice level from peak level
- n: Peak level count

The wavelength marker is displayed at the spectrum width.

Level Marker C indicates the spectrum peak level and Level Marker D indicates the half value of the peak level.

The relationship between the multiplier k and level difference of the Gaussian distribution function is shown in the following diagram.

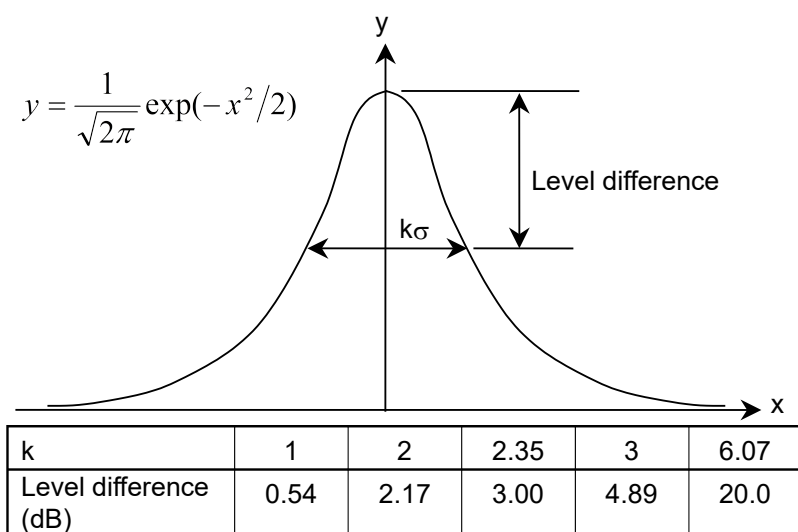

Figure 4.5.5-2 Multiplier k and Gaussian Distribution Function Level Difference

4.5.6 Measuring Spectrum Power by Integration

1. Press **f6 Spectrum Power**.
2. The integrated power of the spectrum data on the screen and the center wavelength λ_c obtained from the weighted average of the level are displayed.

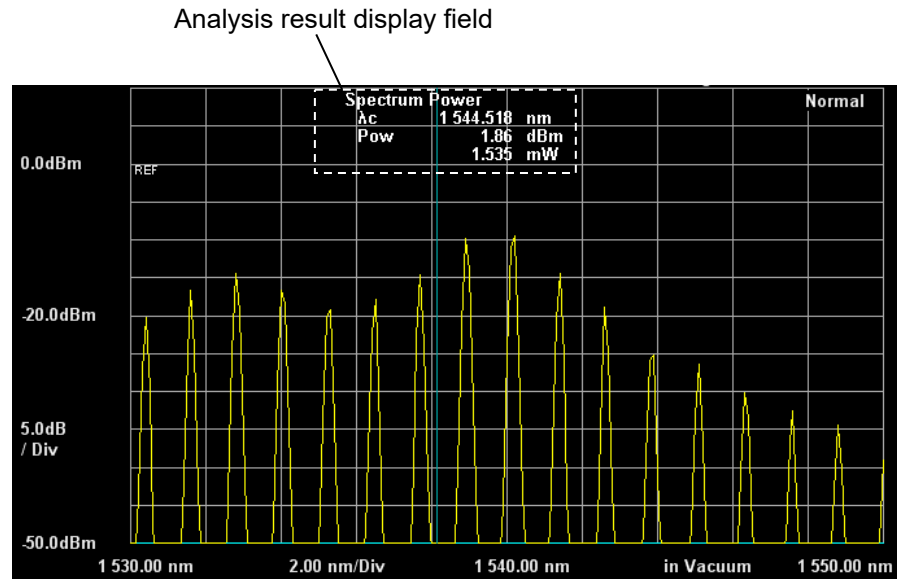

Figure 4.5.6-1 Spectrum Power Example

The center wavelength (λ_c) and power (p) are calculated by the following formula.

$$\lambda_c = \frac{\sum_{i=1}^n A_i \lambda_i}{\sum_{i=1}^n A_i} = \frac{A_1 \lambda_1 + A_2 \lambda_2 + \dots + A_n \lambda_n}{A_1 + A_2 + \dots + A_n}$$

$$P = \frac{\alpha \times \Delta\lambda \times \sum_{i=1}^n A_i}{ActRes}$$

- A_i : Level of i th measurement point in W units
- λ_i : Wavelength of i th measurement point
- $\Delta\lambda$: Measurement point wavelength interval
- ActRes: Actual resolution
- n : Sampling points
- α : Equipment dependent power correction coefficient

4.5.7 Erasing Analysis Results

1. Press **f7 Off**.
2. The analysis results display is erased. Both the Wavelength Marker and Level Marker can be used as markers for analysis.

4.6 Changing Waveform Memory Settings and Calculation between Memories

The MS9740B has 10 waveform memories called trace memories. The trace display and store methods can be changed. Also, the calculation can be performed between traces. Press the **F6 Trace** key to use this function.

Notes:

- The calculated wavelength and other wavelength cannot be displayed at the same time.
- Only traces with the same display mode as the Active Trace are displayed. Traces using other display modes are not displayed.

The trace information is displayed on the screen as shown below.

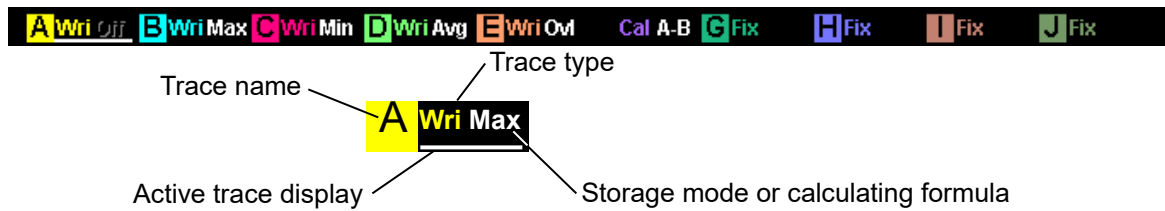

Figure 4.6-1 Trace Display

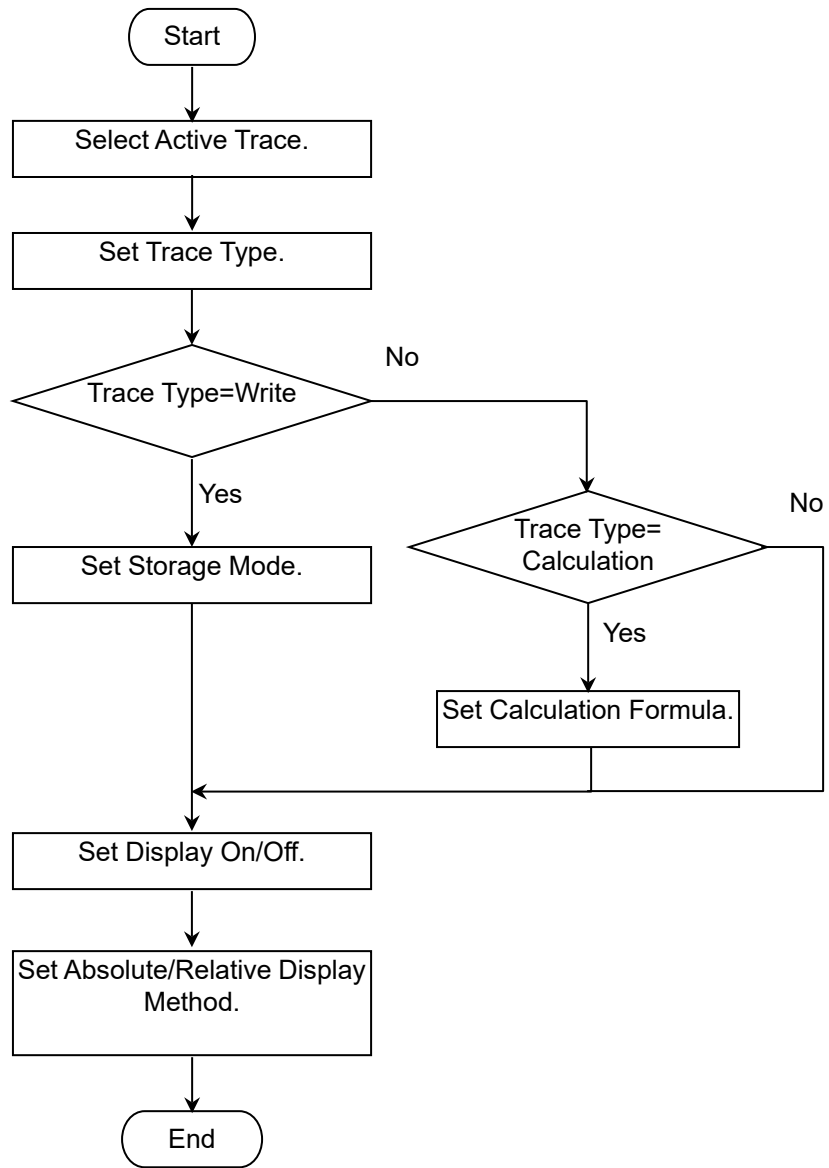

Figure 4.6-2 Trace Setting Flowchart

Selecting Active Trace

The trace setting target is called the Active Trace. First, select the Active trace from A to J.

1. Press **f1 Active Trace**.
2. Select an active trace, by selecting one of A (**f1**) to F (**f6**), or by pressing **f7 More 1/2** and selecting one of G (**f1**) to J (**f4**).

Setting Trace Type

The trace data updating method is called the Trace Type. Set the Trace type for the Active trace.

1. Press **f2 Trace Type**.
2. Select the data update method from **f1** to **f4**.
 - Write: Writes data after measurement completed
 - Fix: Keeps data; data not overwritten after measurement
 - Calculate: Calculates between traces
 - Blank: Discards data and erases waveform from display
Measured data not saved

When Write, Fix or Calculate are selected, Wri, Fix, and Cal, are displayed on the trace respectively.

Note:

The trace type cannot be set to Calculate when executing **F7 Application** functions other than PMD.

Setting Storage Mode

When Write is set at the trace type, the data save method can be set.

1. Press **f3 Storage Mode**.
2. Select the data save method from **f1** to **f5**.
 - f1 Off**: Stores measured data as is
 - f2 Sweep Average**: Calculates average from values in waveform memory and measured value
 - f3 Max Hold**: Only overwrites measured values bigger than values in waveform memory
 - f4 Min Hold**: Only overwrites measured values smaller than values in waveform memory
 - f5 Overlap**: Overwrites most recent trace over the previous trace in each sweep.

Note:

When storage mode is set to Overlap, Traces are overwritten on the display. However, only the most recent trace becomes the target traces to be measured. They are:

- Trace whose data can be read out by marker
- Trace to be stored to memory
- Trace whose spectrum width or center wavelength is measured by Spectrum Analysis

Setting Calculating Formula

When Calculate is set at the trace type, the data calculating method can be set.

1. Press **f4 Calculation**.
2. Select the calculation-target trace from the dialog box using the arrow keys.

Grayed-out traces cannot be selected.

The calculation method is displayed in the trace.

Note:

Only traces made with the same measurement conditions (wavelength range, resolution, number of sampling points) can be calculated.

Err is displayed when the trace calculation cannot be performed because the measurement conditions are different between traces.

When the selected trace type is changed to Calculate or Blank, the calculation equation is erased and the trace type becomes Blank.

When Calculate is selected, only traces with the Calculate trace type are displayed.

Setting Trace Display

Set whether to display the Active Trace on the screen.

1. Press **f5 Display**. When the trace is displayed on the screen, set to On.
2. When **f5 Display** is pressed to set Off, the trace display is erased from the screen.

The names of traces that are not displayed on the screen are erased from the trace display.

Note:

When display of the Active Trace is set to Off, the analysis functions and trace markers cannot be used.

Setting Relative or Absolute Value Display

The Active Trace level display can be set to relative or absolute level.

When relative level is set, the spectrum peak level is displayed as 100% or 0 dBm and the units are either % or dB.

1. Press **f6 Graph**.
2. Select the display method from **f1** and **f2**.
Normal: The vertical axis units are either W or dBm.
Normalize: The vertical axis units are either % or dBm.

Erasing Overlap Display

Erase Overlap Traces on the screen.

1. Press **f7 Erase Overlap**.

4.7 Changing Measurement Mode

The spectrum measurement modes are listed below.

- High dynamic range mode (High D.Range)
- Sweep start using external trigger (Ext Trigger)
- Sweep repeat at fixed time interval (Interval Time)
- Power measurement (Power Monitor)
- Multi-mode fiber mode (MM Mode)

To use these functions, press **F8** to display the **Measure Mode** and press **F1**.

Measurement modes such as the interval measurement mode, dynamic range mode, and external trigger mode are displayed in the measurement settings display field.

4

Changing Measurement Conditions

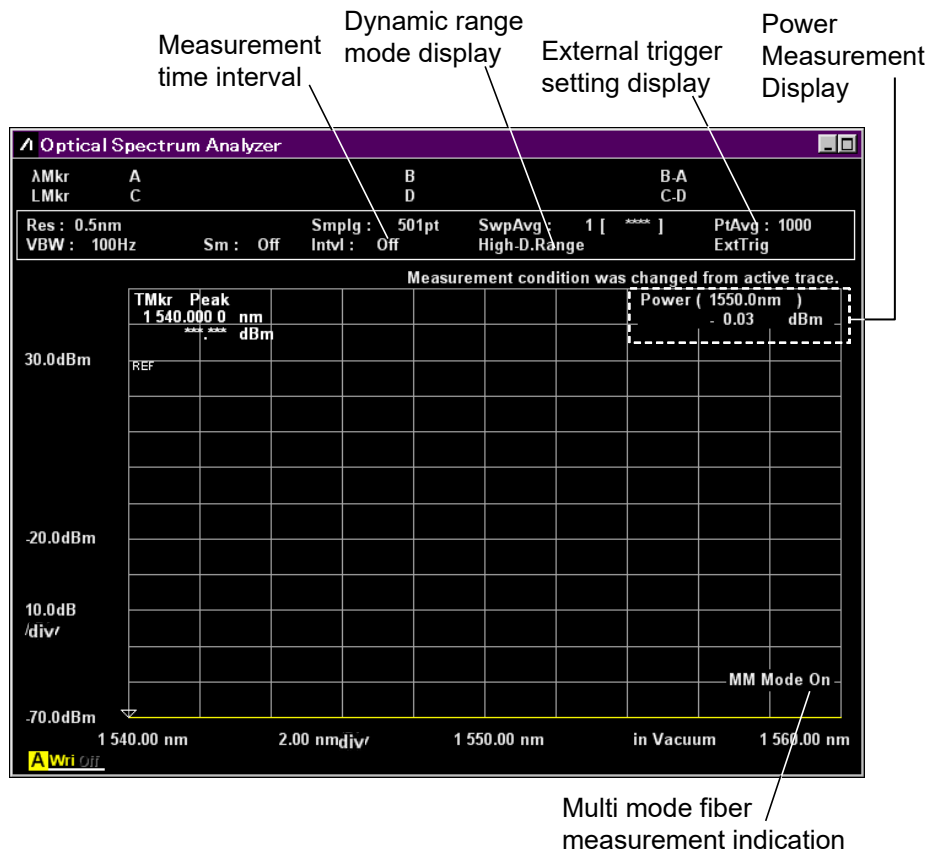

Figure 4.7-1 Measurement Settings Field and Power Measurement Display

To change to High dynamic range mode (High D.Range)

The measurement time is longer in the high dynamic range mode but the dynamic range performance is improved.

1. Press **f1 Dynamic Range** to switch to High.
The High-D.Range is displayed in the measurement settings display field.
2. To release the high-dynamic range mode and return to the Normal mode, press **f1 Dynamic Range**.
The High-D.Range display in the measurement settings display field is erased.

To use External Trigger (Ext Trigger)

When the level of the external trigger at the back-panel Trigger connector changes from low to high, the data for one sampling points is measured.

1. Press **f2 Ext. Trigger Delay**.
The ExtTrig is displayed in the measurement condition display field.
2. Enter the delay time using the keypad or rotary knob.
The delay time is from the trigger input until measurement is started.
The delay time can be entered from 0 to 5 s.
The ExtTrig is displayed in the measurement condition display field.
3. Press **Single** or **Repeat**.
When the signal level at the Trigger connector is changed, the data for one sampling point is captured.

Notes:

- If the signal level at the Trigger connector is changed before the delay time has elapsed, that signal is ignored.
- Set VBW to be larger than the reciprocal of the delay time.
- Input the TTL level when setting the external trigger signal.
- Set the frequency of the external trigger signal to 500 kHz or less.

To release external trigger

1. Press **f2 Ext. Trigger Delay**.
2. Press **f1 Off**.

To set measurement time interval (Interval Time)

1. Press **f3 Interval Time**.
2. Enter the time using the keypad or rotary knob.
The delay time can be entered from 0 s to 5940 s (99 m).

Note:

The measurement time interval is from the start of one sweep until the start of the next sweep. If the time for one sweep is longer than the measurement time interval, that setting is ignored.

To perform power measurement (Power Monitor)

At power measurement, the value of the optical power input to the MS9740B is displayed.

1. Press **f4 Power Monitor**.
2. Press **f1 Wavelength**.
3. Select the wavelength from **f1** to **f4**.
It may take about 10 seconds to display the power measurement data.

Note:

Power Monitor can not be selected when Application functions are running.

To release power measurement

1. Press **f4 Power Monitor**.
2. Press **f7 Off**.

To set Multimode Fiber Mode (MM mode)

When using multimode fiber, read the precautions in Section 2.7.

Use multimode fiber in the following conditions:

- When measuring faceted light sources such as LEDs, VCSELs, etc.
- When measuring in recommended launch mode using dummy fiber patch cord (GSGG) for optical loss measurement

1. Press **f5 MM Mode**.
2. Set to On.
3. MM Mode On is displayed at the bottom right of the screen.

To release MM Mode

The MM mode is released under the following conditions:

- When connecting single mode fiber.
- When measuring optical output of LD module not in recommended launch mode using dummy fiber patch cord (GSGG) for optical loss measurement

1. Press **f5 MM Mode**.
2. Set to Off.

4.8 Inputting Title to Waveform Data

The character strings displayed in the title bar is called title. The title can include up to 32 alphanumeric characters and symbols.

To input title:

1. Press **F8** to display Others in the horizontal function keys.
2. Press **F5 Others**.
3. Press **f2 Title**.
4. If the title input dialog box is displayed, input the characters using the rotary knob.
5. Press **Enter** to set the characters.
6. When title input is completed, press **f7 Set**.
When title input is cancelled, press **f8 Cancel**.

Characters can also be input from a connected external keyboard.

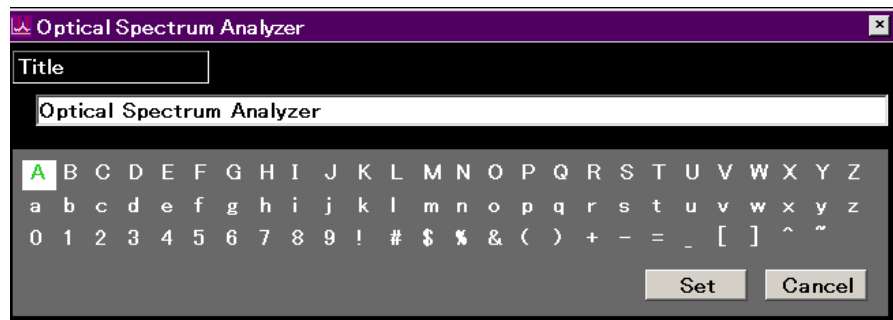

Figure 4.8-1 Title Input Dialog box

4.9 Using Light Source Option

Perform the following operations to use the installed Light Source For Wavelength Calibration MS9740B-002.

1. Press **F8** to display **Others** on the vertical function key.
2. Press **F5 Others**.
3. Press **f1 Optical Output** to set to On.

The Optical Output LED on the front panel lights.

If MS9740B-002 has not been installed, **f1 Optical Output** is not displayed.

Chapter 5 Measurement Functions

MS9740B has various dedicated measurement functions for measuring optical elements, optical amplifiers, wavelength multiplexers, etc. This chapter explains how to use these functions.

Before using the measurement functions described in this chapter, perform the following actions:

- Set measured levels to be displayed in absolute values.
Select F6 Trace – f6 Graph – f1 Normal.
- Set the trace type to Write or Fix.
Select F6 Trace – f2 Trace Type – f1 Write / f2 Fix.

The functions described in this chapter cannot be used when levels are displayed in relative values.

Also, by setting the trace type to Calculate (**F6 Trace – f2 Trace Type – f3 Calculate**), you can use only the functions described in 5.4, “Measuring PMD (Polarization Mode Dispersion)” and 5.9, “Measuring WDM Filter”.

5.1	Measuring DFB-LD (Distributed Feedback Laser Diode)	5-3
	5-3
5.1.1	Setting Items.....	5-4
5.1.2	Calculation Method.....	5-5
5.1.3	Procedure	5-6
5.2	Measuring FP-LD (Fabry-Perot Laser Diode).....	5-7
5.2.1	Setting Items.....	5-8
5.2.2	Calculation Method.....	5-8
5.2.3	Procedure	5-9
5.3	Measuring LED (Light Emitting Diode)	5-10
5.3.1	Setting Items.....	5-11
5.3.2	Calculation Method.....	5-11
5.3.3	Procedure	5-12
5.4	Measuring PMD (Polarization Mode Dispersion).....	5-13
5.4.1	Setting Items.....	5-14
5.4.2	Calculation Method.....	5-15
5.4.3	Procedures	5-15
5.5	Measuring WDM (Wavelength Division Multiplexed)	
	Signals	5-17
5.5.1	WDM Measurement Screen Display	5-18
5.5.2	How to Set the Signal Measurement Method.	5-21
5.5.3	How to Set the Noise Measurement Method .	5-24
5.5.4	Calculation Method.....	5-28
5.5.5	Procedures	5-31
5.6	Measuring Laser Diode Modules	5-33
5.6.1	How to Set the Signal Measurement Method.	5-35
5.6.2	How to Set the Noise Measurement Method .	5-39

	5.6.3	Calculation Method.....	5-43
	5.6.4	Procedures	5-45
5.7		Measuring Optical Amplifier.....	5-47
	5.7.1	Optical Amplifier Measurement Method	5-47
	5.7.2	Optical Amplifier Measurement Screen Display	5-53
	5.7.3	Measurement With/Without Spectrum Division Method.....	5-54
	5.7.4	Measurement Using Polarization Nulling Method.....	5-56
	5.7.5	Measurement Using Pulse Method	5-58
	5.7.6	Measuring Performance with Respect to Wavelength Multiplexed Light	5-61
	5.7.7	Calculation Method.....	5-64
5.8		Measuring Optical Amplifier (Wavelength Division Multiplex).....	5-67
	5.8.1	Optical Amplifier (WDM) Screen Display.....	5-69
	5.8.2	How to Set the Signal Measurement Method.	5-71
	5.8.3	How to Set the Estimated Noise Measurement Method.....	5-74
	5.8.4	Calculation Method.....	5-79
	5.8.5	Procedure	5-83
5.9		Measuring WDM Filter	5-86
	5.9.1	WDM Filter Transmission Characteristics Measurement Method.....	5-87
	5.9.2	WDM Filter Screen Display	5-88
	5.9.3	How to Set the WDM Filter Measurement Method.....	5-90
	5.9.4	Procedures	5-94

5.1 Measuring DFB-LD (Distributed Feedback Laser Diode)

A DFB-LD is a semiconductor laser diode that generates a single spectrum.

The following items can be measured by the DFB-LD measurement functions.

- Peak: Peak wavelength and peak level
- 2nd Peak: Side mode wavelength and level
- SMSR: Side Mode Suppression Ratio
- Mode Offset: Difference between side mode wavelength and peak wavelength
- Stop Band: Difference between peak wavelength and both side mode wavelengths
- Center Offset: Difference between peak wavelength and average of both side mode wavelengths
- σ : Standard deviation
- K σ : Spectrum width using RMS method
- ndB Width: Spectrum width at specified cut level

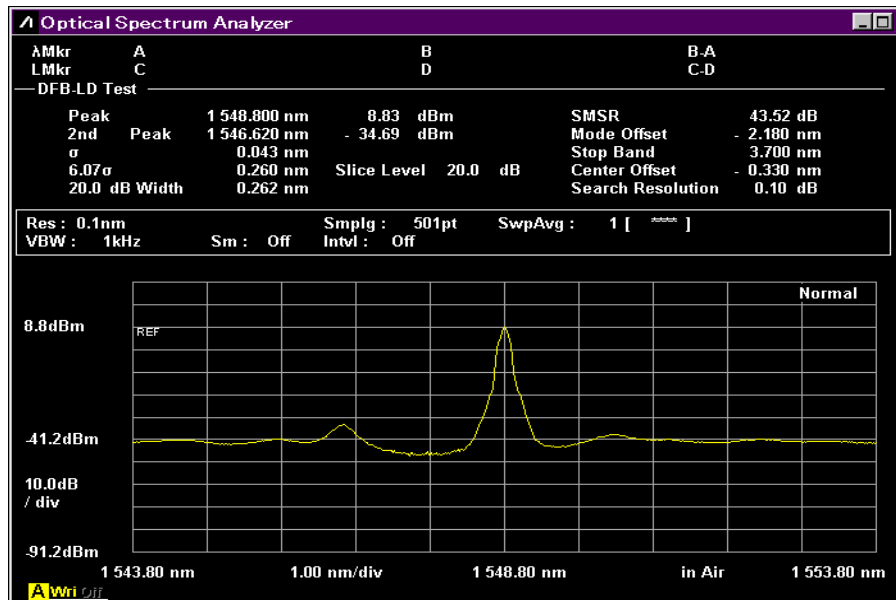

Figure 5.1-1 DFB-Test Example

5.1.1 Setting Items

This function has following setting items.

- Slice Level
This is the threshold value for calculating standard deviation σ .
- Side Mode
This selects the detected side mode.
2nd Peak: Next highest peak after maximum peak as side mode
Left: Peak at left side of maximum peak as side mode
Right: Peak at right side of maximum peak as side mode
- $K\sigma$
This sets constant for standard deviation σ
 $K = 2.35$ is equivalent to 3 dB down, and $K = 6.07$ is equivalent to 20 dB down.
- ndB Width
This specifies the cut level used for spectrum width measurement. The cut level is an attenuator from the peak level.
- Search Resolution
This sets the level resolution (dB) to define the side mode.
Peak P_1 in the following diagram has ripple P_4 of ΔI_4 dB. If this ripple is evaluated as a side mode, the SMSR is not measured correctly. In this case, if the level resolution is set to a larger value than ΔI_4 dB, the P_4 ripple is not detected and SMSR can be measured.

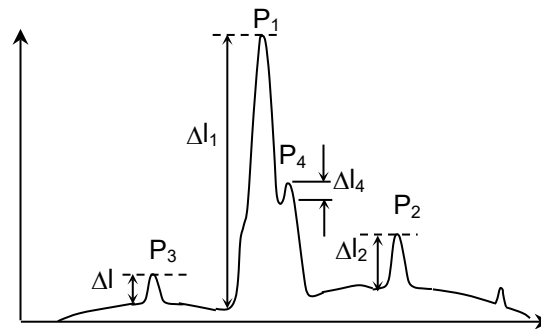

Figure 5.1.1-1 Example of Waveform where 2nd Peak Not Measured Correctly

5.1.2 Calculation Method

- σ

This is calculated using the following formula:

$$\sigma = \sqrt{\frac{\sum B_n \times \lambda_n^2}{\sum B_n} - \lambda_c^2}$$

$$\lambda_c = \frac{\sum B_n \times \lambda_n}{\sum B_n} = \frac{B_1 \lambda_1 + B_2 \lambda_2 + \dots + B_i \lambda_i}{B_1 + B_2 + \dots + B_i}$$

where, B_n and λ_n ($n = 1, 2, 3 \dots i$) is calculated as level and wavelength at the point with a level more than a slice level down from the peak.

- Mode Offset, Stop Band, Center Offset

These are calculated using the following formulae:

$$\text{Mode Offset} = \lambda_{\text{side}} - \lambda_{\text{max}}$$

$$\text{Stop Band} = \lambda_{\text{right}} - \lambda_{\text{left}}$$

$$\text{Center Offset} = \lambda_{\text{max}} - \frac{\lambda_{\text{right}} + \lambda_{\text{left}}}{2}$$

where, λ_{max} is the wavelength at the maximum peak, λ_{left} is the wavelength at the left side of the maximum peak, λ_{right} is the wavelength at the right side of the maximum peak, and λ_{side} is the side mode wavelength.

However, λ_{side} is the side mode selected from the side mode settings, 2nd Peak, Left or Right.

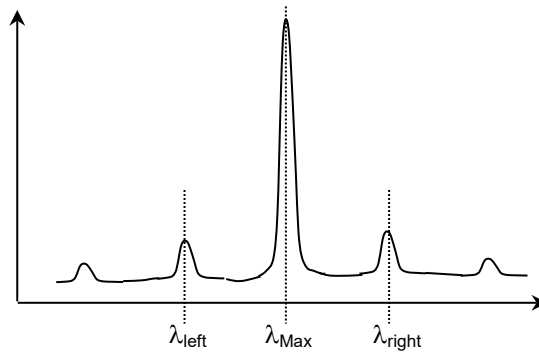

Figure 5.1.2-1 Position of Peak Wavelength and Side Mode

5.1.3 Procedure

To measure DFB-LD:

1. Input the optical signal.
2. Set the wavelength, resolution, and level scale.
3. Press **Single** to start the measurement.
4. When the name of the **F7** horizontal key is not **Application**, press **F8**, and then press **F7**.
5. Press **f1 DFB-LD Test**. The measurement result display field is displayed.
6. Press **f1 Slice Level** and input the value using the keypad or rotary knob. The Slice Level setting range is from 0.1 to 50.0 dB.
7. Press **f2 Side Mode** and select the side mode from **f1** to **f3**.
8. Press **f3 K σ** and select the factor of reference deviation using **f1** to **f5** keys, keypad, or rotary knob. The factor can be entered from 1.00 to 10.00.

For the relationship between factor and level differences, refer to Section 4.5.5 “Analyzing Multiple Spectrum Center Wavelength and Spectrum Width (RMS method)”.

9. Press **f4 ndB Width**. Input the cut level (in ndB), using the keypad or rotary knob.
10. When not detecting a side mode properly, press **f5 Search Resolution**. Search Resolution can be input in the range of 0.10 to 10.00 dB. The level resolution detecting the side mode is set using keypad or rotary knob.
11. Press **f7 Off** to finish the DFB-LD measurement.

5.2 Measuring FP-LD (Fabry-Perot Laser Diode)

A Fabry-Perot laser diode is a semiconductor laser diode with a multi mode oscillation in the spectrum.

The following items can be measured by the FP-LD measurement functions.

- Peak: Peak wavelength and peak level
- Mean Wl: Center wavelength
- FWHM: Spectral width using RMS method (2.35σ)
- Total Power: Spectrum integration power
- Mode (n dB): Number of longitudinal modes
- Mode Spacing: Interval between longitudinal modes
- σ : Standard deviation of spectrum using RMS method

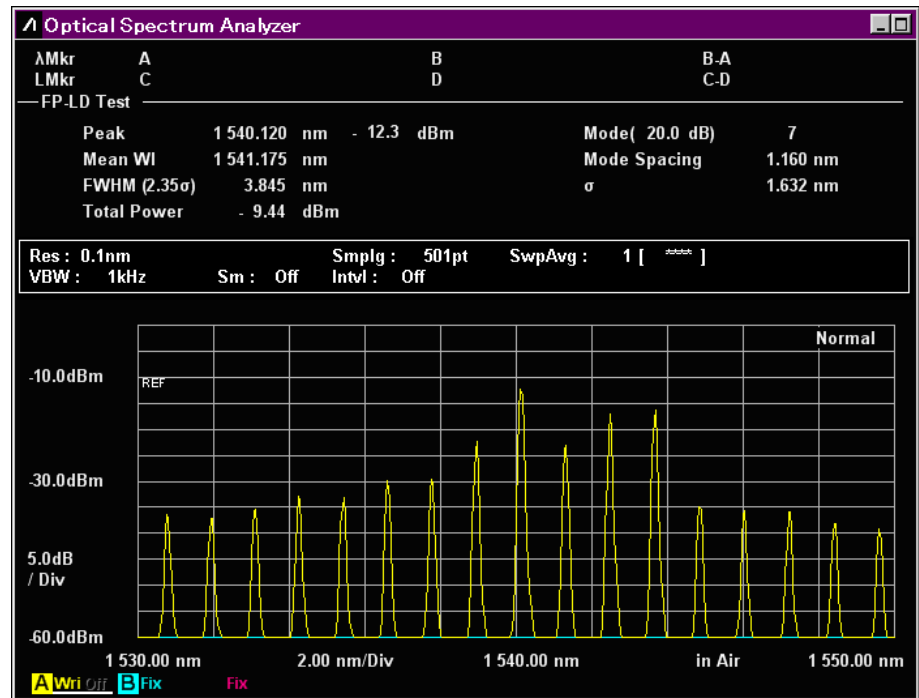

Figure 5.2-1 FP-LD Test Example

5.2.1 Setting Items

This function has following setting items.

- Slice Level
This sets whether or not to find the number of longitudinal modes at levels lowered some dB (Slice level) from the peak.

5.2.2 Calculation Method

The following equation is used to calculate the level $L_1, L_2, L_3 \dots L_n$ for all measured wavelengths $\lambda_1, \lambda_2, \lambda_3 \dots \lambda_n$ in the spectrum. Here the peak wavelength is bigger than the level lowered the level at Slice Level from the peak of the measurement spectrum.

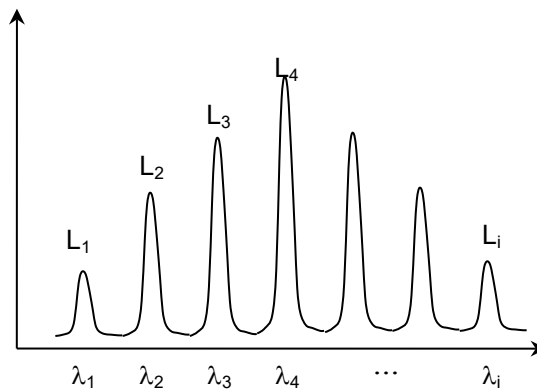

Figure 5.2.2-1 Wavelength and Level Used for Calculation

- Mean Wl

$$\lambda_c = \frac{\sum(L_i \cdot \lambda_i)}{\sum L_i}$$

- FWHM

$$\Delta\lambda = 2.35\sigma = 2.35 \sqrt{\frac{\sum L_i (\lambda_i - \lambda_c)^2}{\sum L_i}}$$

- Total Power

$$Pow = \sum L_i$$

5.2.3 Procedure

To measure Fabry-Perot LD:

1. Input the optical signal.
2. Set the wavelength, resolution, and level scale.
3. Press **Single** to start the measurement.
4. When the name of the **F7** horizontal key is not **Application**, press **F8**, and then press **F7**.
5. Press **f2 FP-LD Test** to display the measurement result display field.
6. Press **f1 Slice Level** and input the value using the keypad or rotary knob.
The Slice Level setting range is from 0.1 to 50.0 dB.
7. Press **f7 Off** to finish the FP-LD measurement.

5.3 Measuring LED (Light Emitting Diode)

A light emitting diode is an optical element with a continuous spectrum.

The following items can be measured by the LED measurement functions.

- Peak: Peak wavelength at peak level
- Mean Wl (n dB): Center wavelength using ndB Loss method
- Mean Wl (FWHM): Center wavelength of spectrum half width
- n dB Width: Spectrum width using ndB Loss method
- FWHM (2.35 σ): Spectrum half width using RMS method
- PkDens (/1nm): Maximum spectrum density
- Total Power: Spectrum integral power
- Ko: Spectrum width using RMS method
- σ : Standard deviation of spectrum using RMS method

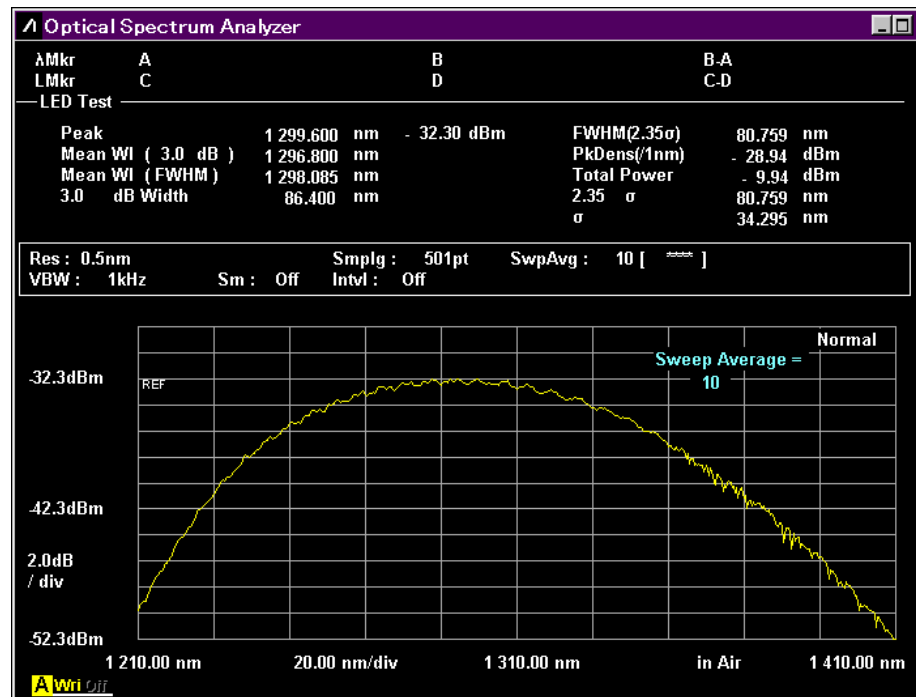

Figure 5.3-1 LED-Test Example

5.3.1 Setting Items

This function has following setting items.

- **Cut Level**
This sets the threshold level used to calculate Mean Wl (n dB), ndB Width, and PkDens (/1nm).
When calculating Mean Wl (FWHM), FWHM (2.35 σ), Total Power, and σ, all data are used irrespective of Cut Level.
- **Power Cal**
This is the calibration factor used at Total Power calculation.
- **Kσ**
This is the constant for the standard deviation σ.

5.3.2 Calculation Method

The following equation is used to calculate the level L₁, L₂, L₃...L_n for all measured wavelengths λ₁, λ₂, λ₃...λ_n in the spectrum. Here the peak wavelength is bigger than the level lowered the level at Slice Level from the peak of the measurement spectrum.

- **Mean Wl (ndB)**

$$\lambda_c = \frac{\lambda_a + \lambda_b}{2}$$

λ_a, λ_b (λ_a<λ_b) are the wavelengths for the levels at the Cut level below the peak.

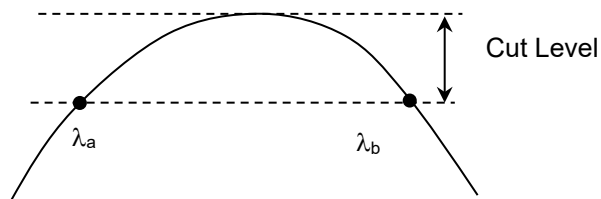

Figure 5.3.2-1 Definition of λ_a, and λ_b

- **Mean WL (FWHM)**

$$\lambda_c = \frac{\sum L_n \cdot \lambda_n}{\sum L_n}$$

- **ndB Width**

$$\Delta\lambda = \lambda_b - \lambda_a$$

- **FWHM (2.35 σ)**

$$\Delta\lambda = 2.35\sigma = 2.35\sqrt{\frac{\sum L_n \cdot \lambda_n^2}{\sum L_n} - \lambda_c^2}$$

- Total Power

$$Pow = PowerCal \cdot \frac{Span}{(Sampl - 1)} \cdot \frac{\alpha}{ActRes} \cdot \sum L_n$$

Span: Span (nm)

Sampl: Sampling point

ActRes: Actual Resolution

α : Equipment dependent power correction coefficient

- PkDens (1nm)

$$PkDens(1nm) = PowerCal \cdot \frac{Span}{(Sampl - 1)} \cdot \frac{\alpha}{ActRes} \cdot \sum_{\lambda_p - 0.5nm}^{\lambda_p + 0.5nm} L_n$$

λ_p : Mean Wl (n dB) wavelength

- σ

$$\sigma = \sqrt{\frac{\sum L_n \cdot \lambda_c^2}{\sum L_n} - \lambda_c^2}$$

- $K\sigma$

$$K\sigma = K \cdot \sigma$$

5.3.3 Procedure

1. Input the optical signal.
2. Set the wavelength, resolution, and level scale.
3. Press **Single** to start the measurement.
4. When the name of the **F7** horizontal key is not **Application**, press **F8**, and then press **F7**.
5. Press **f3 LED Test** to display the measurement result display field.
6. Press **f1 Cut Level** and input the value using the keypad or rotary knob.
The Cut Level setting range is from 0.1 to 50.0 dB.
7. Press **f2 Power Cal** and input the corrected value of the total power using the keypad and rotary knob.
The Power Cal setting range is from -10.00 to 10.00 dB.
8. Press **f3 K σ** and select the factor of reference deviation using **f1** to **f5** keys, keypad, or rotary knob. The factor can be entered from 1.00 to 10.00.
When measuring the full half width (FWHM), set 2.35 σ .
9. Press **f7 Off** to finish the optical diode measurement.

5.4 Measuring PMD (Polarization Mode Dispersion)

Polarization Mode Dispersion is a phenomenon that widens the width of optical pulses due to differences in transmission speed between two polarization modes when an optical pulse is passed through optical fiber and optical equipment.

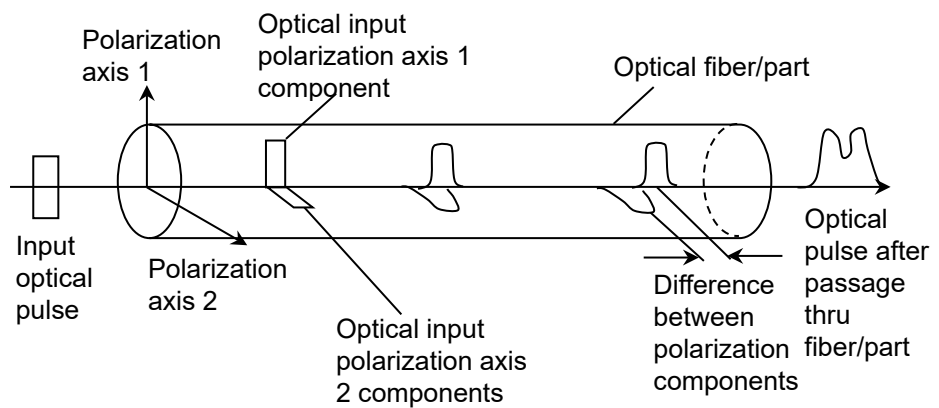

Figure 5.4-1 Outline of PMD

The PMD measurement function measures the Diff Group Delay (differential group delay).

Note:

Accurate measurement is not possible for fiber installations in unstable environments, such as in air.

The Diff Group Delay cannot be measured, if the multiplex peak wavelengths do not exist in the spectrum as shown in Figure 5.4-2.

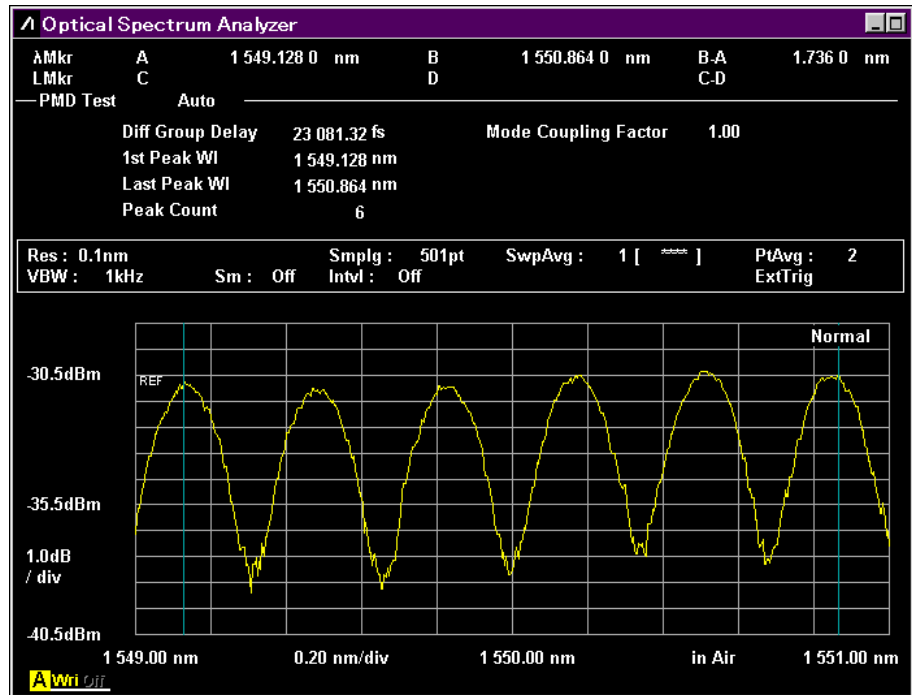

Figure 5.4-2 PMD-Test Example

5.4.1 Setting Items

This function has following setting items.

- Auto/Manual

This sets the method for capturing the following values used in the calculation.

- First Peak Wavelength in analysis range (1st Peak Wavelength)
- Last Peak Wavelength in analysis range (Last Peak Wavelength)
- Peak Count included in analysis range (Peak Count)

Auto: Detects 1st Peak, Last Peak, and Peak Count automatically

Manual: Sets 1st Peak, Last Peak, and Peak Count manually.

- Mode Cpl Factor

This sets the mode connection factor.

- 1st Peak Marker

This sets the position of the 1st Peak Marker at Manual measurement.

- Last Peak Marker

This sets the position of Last Peak Marker at Manual setting.

- Peak Count

This sets the number of peaks included between the 1st Peak Marker and Last Peak Marker at Manual measurement.

5.4.2 Calculation Method

The differential group delay $\Delta\tau$ is calculated using the following equation.

$$\Delta\tau = k \times (n - 1) \times \frac{\lambda_1 \times \lambda_2}{c \times (\lambda_2 - \lambda_1)}$$

- k: Mode coupling factor
- c: Light Velocity 2.99792458×10^8 m/s
- n: Peak Count
- λ_1 : 1st Peak Marker wavelength
- λ_2 : Last Peak Marker wavelength

The measurement system is shown in the following diagram. A SLD (Super Luminescent Diode) light source or an ASE (Amplified Spontaneous Emission) light source can be used as the wideband light source.

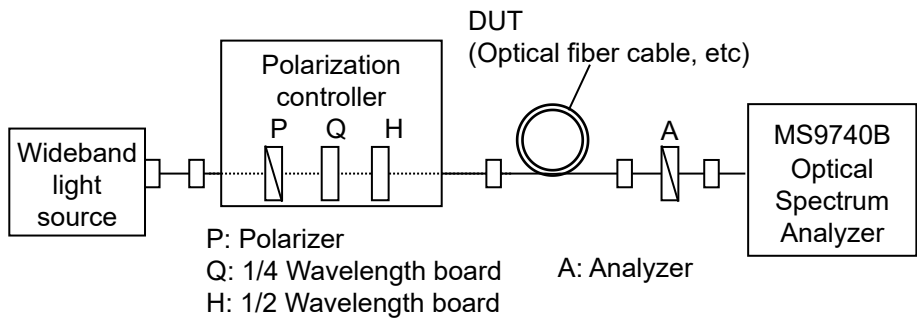

Figure 5.4.2-1 PMD Measurement System

5.4.3 Procedures

To display polarization mode measurement

1. When the name of the **F7** horizontal key is not **Application**, press **F8**, and then press **F7**.
2. Press **f4 PMD Test** to display the measurement result display field.

To calculate automatically

1. Press **f1 Auto/Manual** and select Auto.
2. Input the optical signal.
3. Set the wavelength, resolution, and level scale.
4. Press **Repeat**.
5. Adjust the polarization controller to maximize the difference between the measured spectrum maximum and minimum values.
6. Press **f2 Mode Cpl Factor** and input the mode coupling factor in the range 0.01 to 1.00.

7. The measurement results are updated at each measurement.
8. Press **f7 Off** to finish the polarization mode dispersion measurement.

To calculate manually

1. Press **f1 Auto/Manual** and select Manual.
2. Input the optical signal.
3. Set the wavelength, resolution, and level scale.
4. Press **Repeat**.
5. Adjust the polarization controller to maximize the difference between the measured spectrum maximum and minimum values.
6. Press **f2 Mode Cpl Factor** and input the mode coupling factor in the range 0.01 to 1.00.
7. Press **f3 1st Peak Marker** and use the keypad or rotary knob to move Wavelength Marker A to the peak point.
8. Press **f4 Last Peak Marker** and use the keypad or rotary knob to move Wavelength Marker B to the peak point.
9. Press **f5 Peak Count** and input the number of peak points between the First Peak Marker and Last Peak Marker. This value includes the peaks at the markers.
10. The measurement results (Diff Group Delay) are updated at each measurement.
11. Press **f7 Off** to finish the polarization mode dispersion measurement.

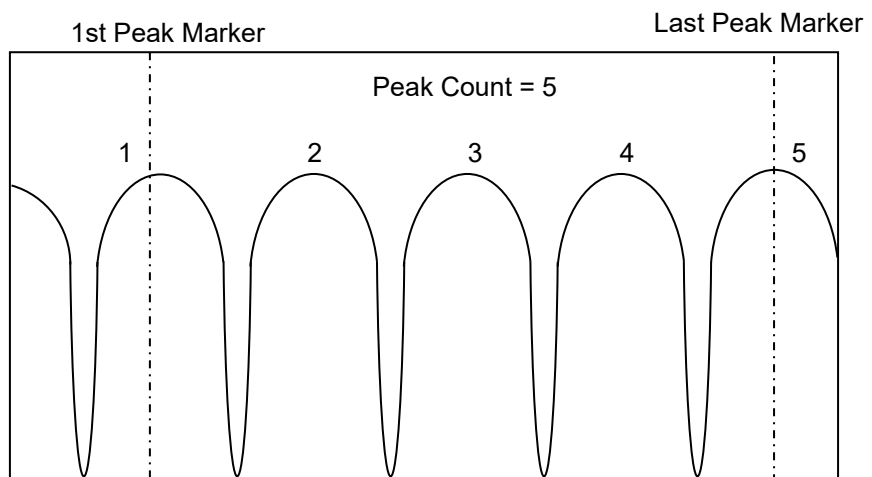

Figure 5.4.3-1 Peak Count Example

5.5 Measuring WDM (Wavelength Division Multiplexed) Signals

Wavelength Division Multiplexing (WDM) is a method for increasing the communication capacity of an optical fiber by using multiple wavelengths in one fiber. The WDM light is composed of multiple optical signals. At WDM measurement, the following items are measured simultaneously for the multiple optical signals.

Table 5.5-1 WDM Measurement Items

Measurement Item	Screen Display	Description
Signal	Gain Vari	Level difference maximum and minimum signal levels
	Level (dBm)	Level
	Lvl-Ref (dB)	Ratio of level difference to reference signal
	No	Number of signal (sequential number added from short wavelength)
	Peak Count	Signal count
	Signal Wl (nm) /Wl (nm)	Wavelength
	Spacing Frq (GHz)	Frequency difference between signals
	Spacing (nm) Spacing Wl (nm)	Wavelength difference between signals
	Wl-Ref (nm)	Ratio of wavelength difference to reference signal
SNR	SNR	Signal Noise Ratio
	SNR (/*. *nm)	Signal noise ratio for the noise level per noise BW
Noise	L/R or Blank	SNR Noise detection direction (L = left, R = right A = mean.) No display when Noise Detection Type set to Area

5.5.1 WDM Measurement Screen Display

WDM measurement has four types of measurement screens.

The displayed measurement result items differ according to the screen display.

✓: Displays

–: Does not display

Table 5.5.1-1 Items Displayed on the WDM Screen

Item	Screen Display			
	Multi Peak	SNR	Relative	Table
Gain Vari	–	✓	–	✓
L/R	–	✓*1	–	✓*1
Level (dBm)	✓	✓	–	✓
Lvl-Ref (dB)	–	–	✓	–
No.	✓	✓	✓	✓
Peak Count	✓	✓	✓	✓
Signal Frq (GHz)	–	–	–	✓
Signal Wl (nm)	–	–	–	✓
SNR	–	✓*2	–	✓*2
SNR (/*. *nm)	–	✓*3	–	✓*3
Spacing (nm)	–	–	✓	–
Spacing Wl (nm)	–	–	✓	✓
Spacing Frq (GHz)	–	–	–	✓
Wl (nm)	✓	✓	✓	✓
Wl-Ref (nm)	–	–	✓	–

*1: When Noise Detection Type set to Point

*2: When Noise Normalization set to Off

*3: When Noise Normalization set to On

Note:

Note that for Level (dBm) at SNR and Table, noise level is subtracted. When a marker is set to Peak, the values of marker level and Level (dBm) may not match.

Level (dBm) at MultiPeak is peak maker level.

Level (dBm) at Relative is the relative value from peak maker level.

Multi Peak:

Up to 15 wavelengths and levels are displayed on one screen.

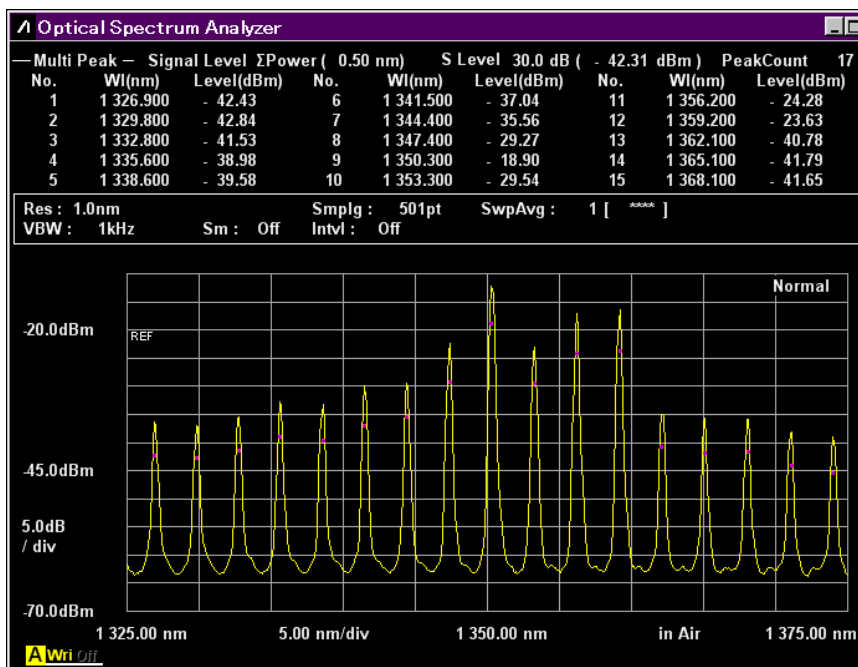

Figure 5.5.1-1 Multi Peak Display Example

SNR:

Up to 8 wavelengths, levels and signal noises are displayed on one screen.

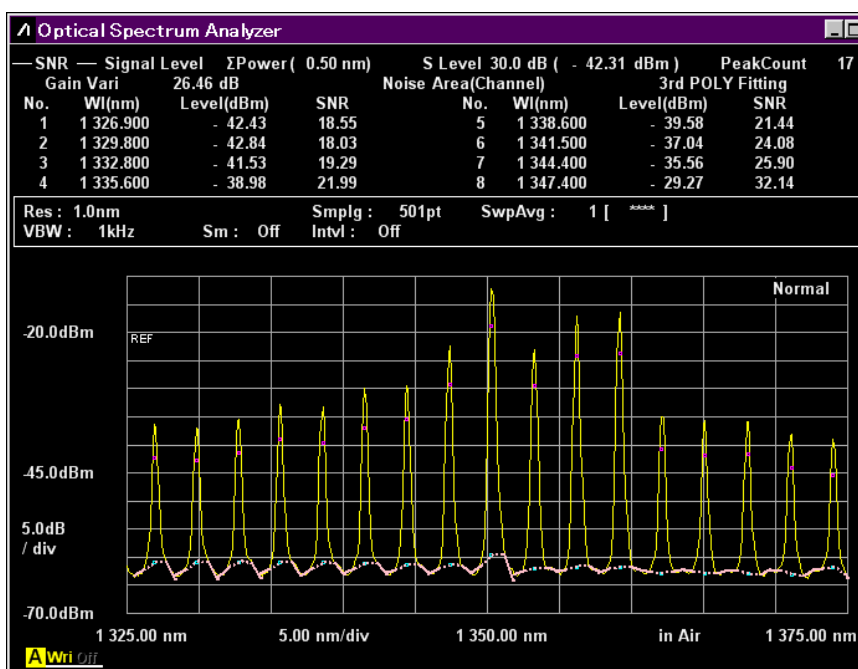

Figure 5.5.1-2 SNR Display Example

Relative:

Up to 5 wavelengths, spacing, wavelength-references, levels, and Level-references are displayed on one screen.

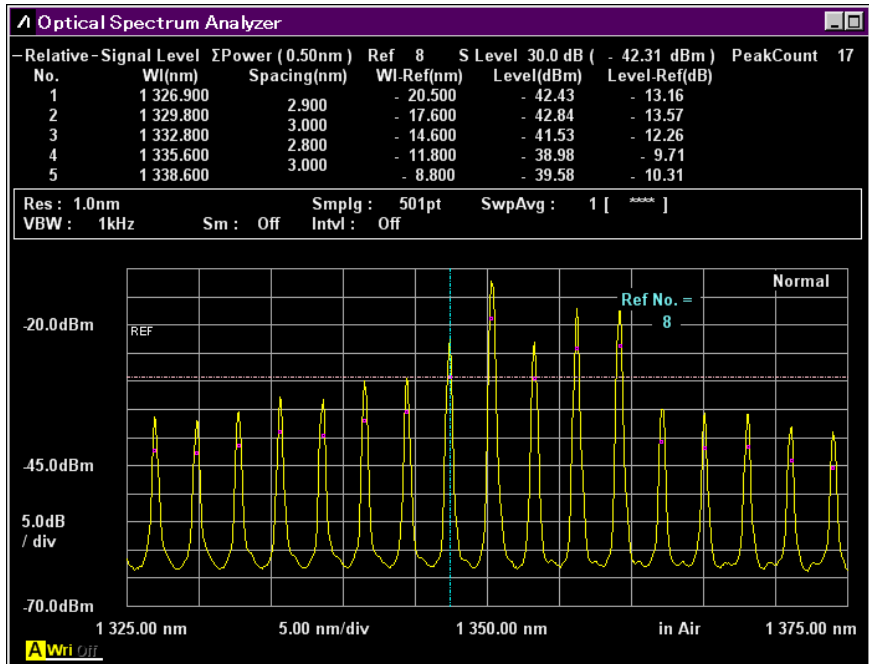

Figure 5.5.1-3 WDM Relative Display Example

Table:

Up to 16 wavelengths, frequencies, levels, signal noises, wavelength intervals and spacing intervals are displayed on one screen.

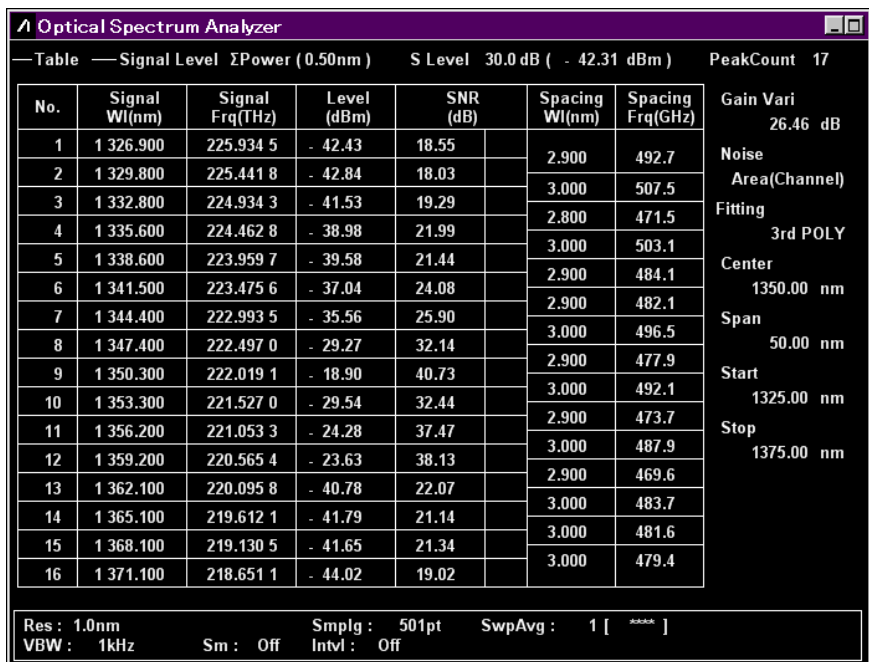

Figure 5.5.1-4 WDM Table Display Example

5.5.2 How to Set the Signal Measurement Method

In the Signal Parameter dialog box, set the signal detection range (S.Level) and wavelength/level detection method.

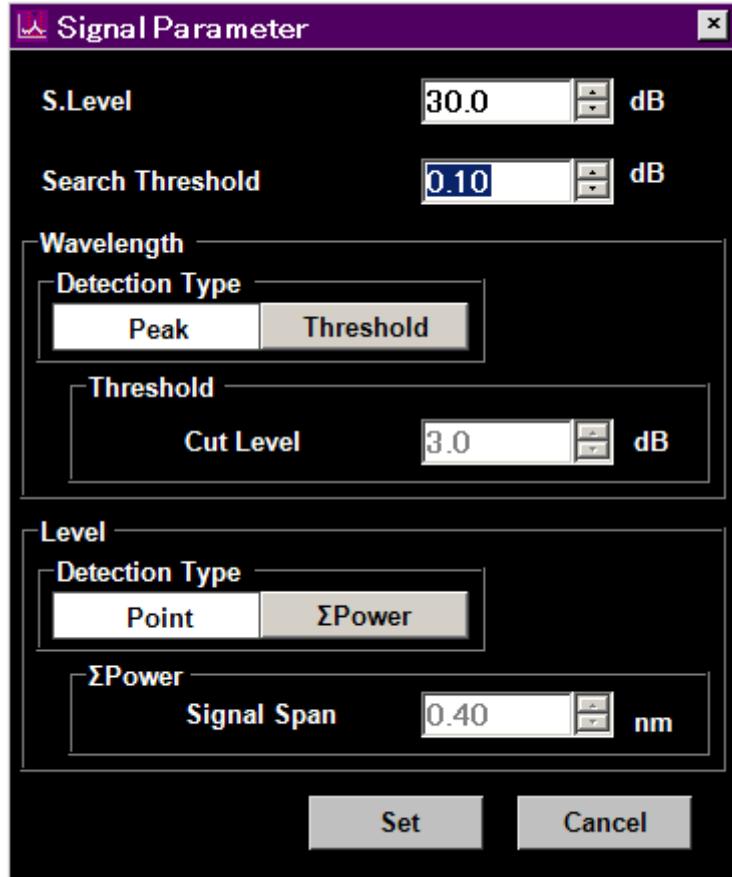

Figure 5.5.2-1 Signal Parameter Dialog Box

Table 5.5.2-1 Setting Range of the Parameters in the Signal Parameter Dialog Box

Item	Min.	Max.	Unit
Cut Level	0.1	50.0	dB
Search Threshold	0.01	10.0	dB
Signal Span	0.01	50.00	nm
S.Level	0.1	50.0	dB

- S.Level (Slice Level)

This sets the optical signal detection level range and detects peaks above the lower level of the S. Level band below the Peak level as WDM signals. Peaks b, c, d, and e in the following diagram are detected.

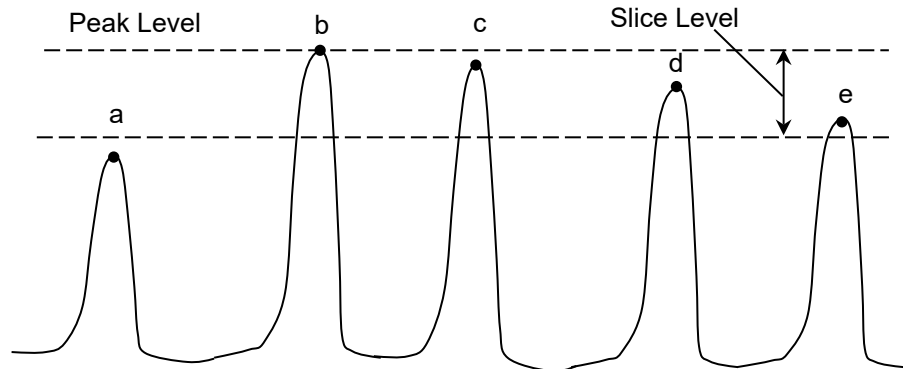

Figure 5.5.2-2 WDM Analysis Target Peaks

Note:

Peak level is the sum of optical signal level and noise level.

- Wavelength

Detection Type: Detection type of Signal wavelength
 Peak: Wavelength peaks
 Threshold: Center wavelength analyzed Threshold
 Threshold Cut Level: Detects peak as signal and level range from maximum.
 This parameter is enabled when Threshold is selected.
 Threshold Cut Level is set in the range of 0.1 to 50.0.

Note:

If no wavelength is detected within the level range specified by Threshold Cut Level, the screen center wavelength becomes the detected wavelength.

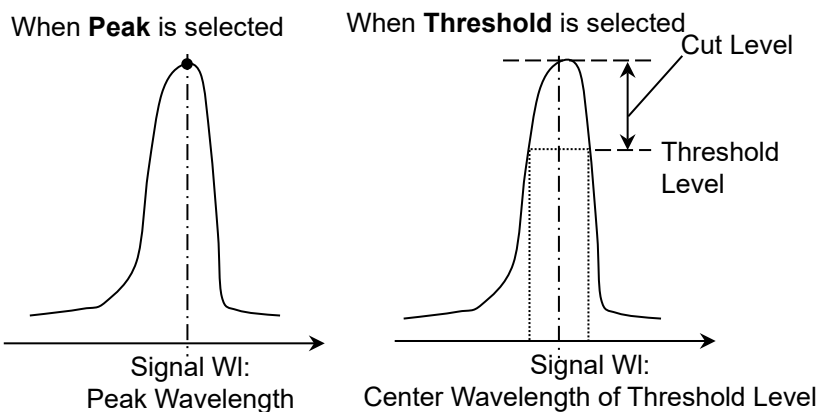

Figure 5.5.2-3 Measurement Method for Signal Wavelength

- Level

Detection Type: Detection type of Signal level
 Point: Point level for Signal wavelength
 ΣPower: Total level for Signal Span wavelength range
 Signal Span is set in the range of 0.01 to 50.00.

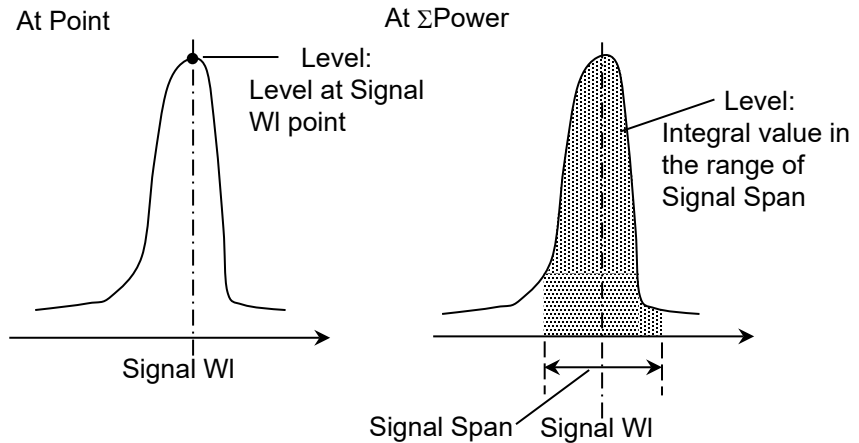

Figure 5.5.2-4 Measurement Method for Signal Level

The optical signal level when Point is set ($L_{S, Lin}$) is calculated by the following formula:

$$L_{S, Lin} = P(\lambda_{sig}) - N(\lambda_{sig}) \quad (W)$$

$P(\lambda_{sig})$: Level at detected optical signal wavelength
 $N(\lambda_{sig})$: Noise level at detected optical signal wavelength

When ΣPower is set, the optical signal level is calculated by the following formula:

$$L_{S, Lin} = \sum_{i=1}^n \{P(i) - N(\lambda_{sig})\} * \frac{Span}{Sampl - 1} * \frac{\alpha}{ActRes(i)} \quad (W)$$

n : Data count in the range of Signal Span
 Span: Span (nm)
 Sampl: Sampling point
 $P(i)$: i th data level (W)
 $ActRes(i)$: i th data Actual Resolution
 α : Equipment dependent power correction coefficient

Note:

When the wavelength range set at Signal Span does not fit within the screen, only the data for the on-screen wavelength range is totaled.

5.5.3 How to Set the Noise Measurement Method

In the Noise Parameter dialog box, set the noise level for the SNR measurement and display/detection method.

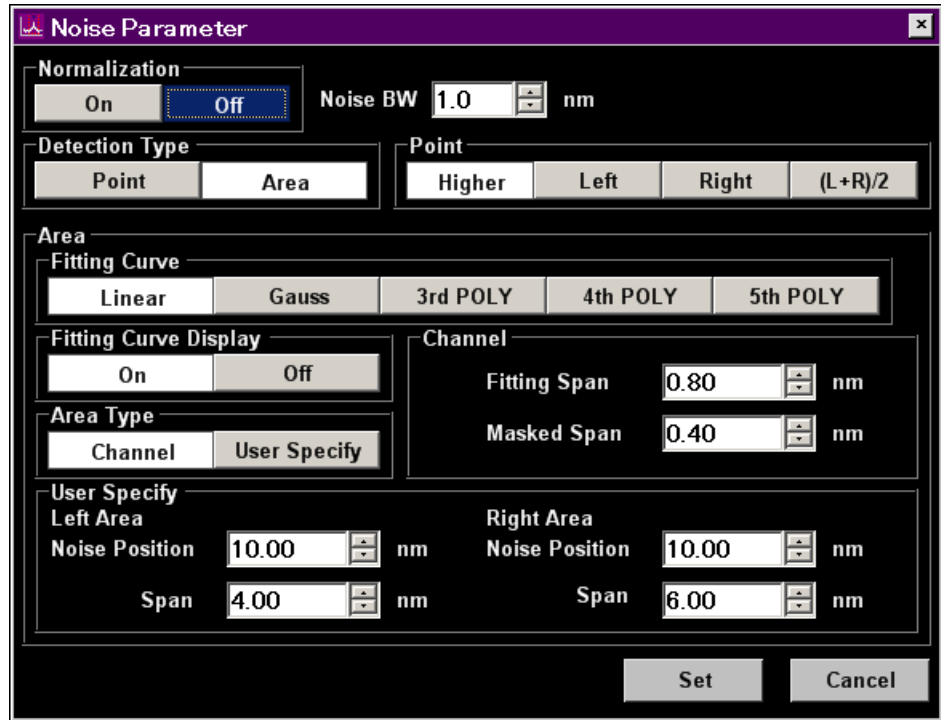

Figure 5.5.3-1 Noise Parameter Dialog Box

Table 5.5.3-1 Setting Range of the Parameters in the Noise Parameter Dialog Box

Item	Min.	Max.	Unit
Fitting Span	0.01	20.00	nm
Masked Span	0.01	20.00	nm
Noise BW	0.1	1.0	nm
Noise Position	0.01	100.00	nm
Span	0.01	100.00	nm

- Normalization: Calculation method for noise level
 - Off: Level in the wavelength range for the actual resolution
 - On: Normalized level in the wavelength range of the Noise BW
 - Noise BW: Band width used for noise level calculation.
- Detection Type: Detection method for noise level
 - Area: The noise obtained from the value of fitting curve at signal wavelength. The fitting curve is calculated from the noise waveform in the Noise Area
 - Point: Noise measured at point specified at Noise Point

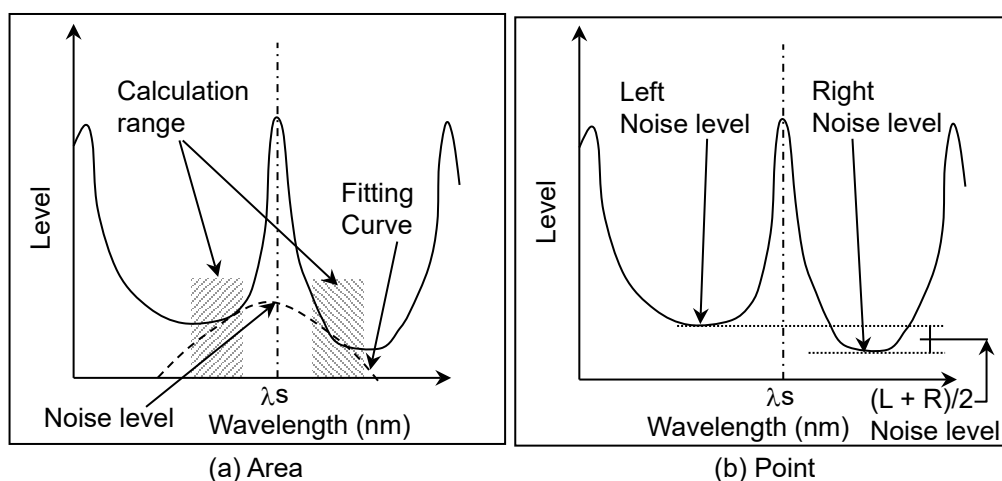

Figure 5.5.3-2 Detection Method for Noise Level

When Detection Type is set to Point, the position for measuring noise level can be set by **f6 Noise Position**.

- Noise Position

On: When the Noise Parameter Point is set to Left, the position is separated by wavelength difference $\Delta\lambda$ on the shorter wavelength side of the optical signal wavelength λ_s .

When Point is set to Right, the position is separated by wavelength difference $\Delta\lambda$ on the longer wavelength side of the optical signal wavelength λ_s .

When Point is set to Higher, the position is at the higher level of the wavelength difference $\Delta\lambda$ on the left or right side of the optical signal wavelength λ_s (left side in Figure 5.5.3-3 (b)).

When Point is set to $(L+R)/2$, the position is at the average of the levels of the wavelength difference $\Delta\lambda$ on the left and right sides of the optical signal wavelength λ_s .

Off: When the Noise Parameter Point is set to Left, the position is at the dip level on the shorter wavelength side of the optical signal.

When Point is set to Right, the position is at the dip level on the longer wavelength side of the optical signal.

When Point is set to Higher, the position is at the higher level of the dip points on the left or right side of the optical signal (left in Figure 5.5.3-3 (a)).

When Point is set to (L+R)/2, the position is at the average of the levels of the dip points on the left and right sides of the optical signal.

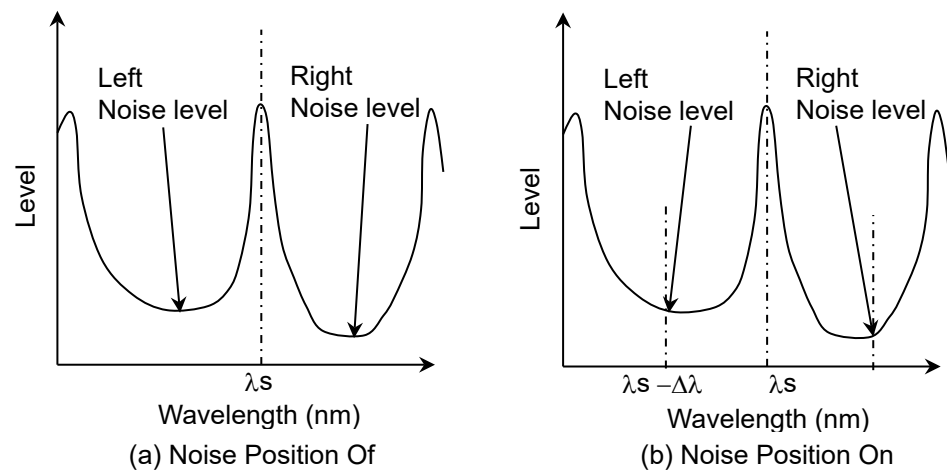

Figure 5.5.3-3 Measurement of Noise at Noise Position

- Point:
 - Noise level detection position when Detection Type is Point
 - Higher: Higher level at left or right side of signal wavelength
 - Left: Signal left side (short wavelength side)
 - Right: Signal right side (long wavelength side)
 - (L+R)/2: Average level of Signal left and right sides

- Area:
 - Fitting curve calculation range when Detection Type is Area
 - Fitting Curve: Type of fitting curve
 - Linear: Linear equation for noise linear data
 $f(\lambda) = a\lambda + b$
 - Gauss: Binomial equation for noise log data
 $f(\lambda) = a\lambda^2 + b\lambda + c$
 - 3rd POLY: Third-order polynomial equation for noise linear data
 $f(\lambda) = a\lambda^3 + b\lambda^2 + c\lambda + d$
 - 4th POLY: Forth-order polynomial equation for noise linear data
 $f(\lambda) = a\lambda^4 + b\lambda^3 + c\lambda^2 + d\lambda + e$

5th POLY:	Fifth-order polynomial equation for noise linear data $f(\lambda) = a\lambda^5 + b\lambda^4 + c\lambda^3 + d\lambda^2 + e\lambda + f$
Fitting Curve Display:	Fitting curve display setting
Off:	Does not display fitting curve on screen
On:	Displays fitting curve on screen
Area Type:	Area setting method for calculating fitting curve
Channel:	Both sides of each Signal wavelength
User Specify:	User specified range
Channel:	Area setting when Noise Area is Channel
Fitting Span:	Wavelength range for calculating fitting curve
Masked Span:	Wavelength range excluded from fitting curve calculation
User Specify:	Area setting when Noise Area is User Specify
Noise Position:	Wavelength difference between screen center wavelength and area center wavelength
Span:	Area wavelength range

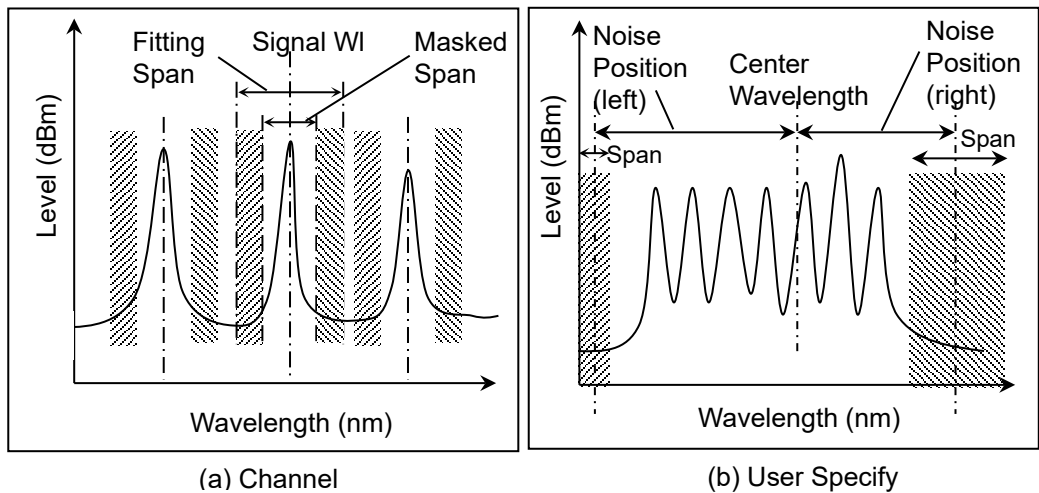

Figure 5.5.3-4 Noise Level Measurement Range Set at Area Type

Note:

When the wavelength range set at Channel or User Specify cannot be accommodated within the measured wavelength range, the fitting curve is calculated using only the measured wavelength range data.

When the wavelength range set at Channel or User Specify is outside the measured wavelength range, SNR is displayed as *** and no fitting curve is displayed.

5.5.4 Calculation Method

1. Peaks with a level higher than the level set by S. Level setting of Signal Parameter are detected and analyzed.
2. The WDM signal wavelength is measured in accordance with the Wavelength-Detection Type setting of Signal Parameter.
3. The WDM signal peak level is measured in accordance with the Level-Detection Type of Signal Parameter. WDM signal peak level is the sum of signal level and noise level. WDM signal level is determined by “WDM signal peak level – Noise level (the level determined in step 5)”. See Figure 5.5.4-1, and Figure 5.5.4-2.
4. The noise measurement position and range are determined in accordance with the Noise Parameter Detection Type and Noise Position settings.

Table 5.5.4-1 Noise Measuring Point

Noise Parameter Detection Type	Noise Position	Noise Parameter Area Type	Position or Area
Point	Off	–	Figure 5.5.3-3 (a)
	On	–	Figure 5.5.3-3 (b)
Area	–	Channel	Figure 5.5.3-4 (a)
	–	User Specify	Figure 5.5.3-4 (b)

5. When the Noise Parameter Detection Type is Point, the level at the position set at Noise Position is measured.
When the Noise Parameter Detection Type is Area, the fitting curve specified at Fitting Curve is calculated. The level at the fitting curve WDM signal wavelength is measured.

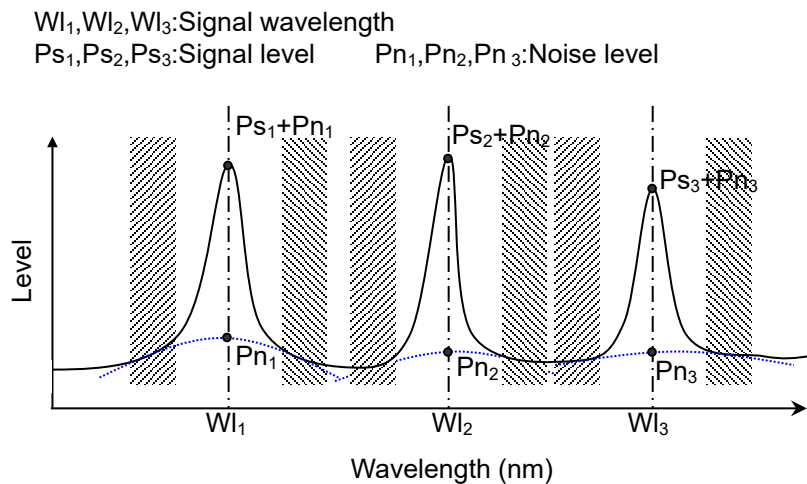

Figure 5.5.4-1 Fitting Curve and Noise Level When Area Type is Channel

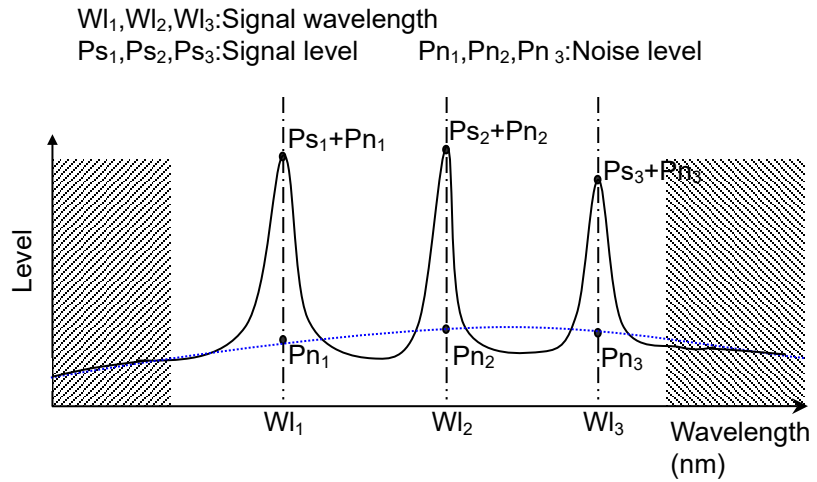

Figure 5.5.4-2 Fitting Curve and Noise Level when Area Type is User Specify

6. SNR is calculated using the following equation.

$$SNR = 10 \log \left(\frac{L_{S, Lin}}{N(\lambda_{sig})} \right) \text{ (dB)}$$

where, $L_{S, Lin}$ is linear value (W) of level at signal and $N(\lambda_{sig})$ is linear value (W) of noise level at optical signal wavelength.

When Level Detection Type is set to Point, the optical signal level is calculated by the following formula:

$$L_{S, Lin} = P(\lambda_{sig}) - N(\lambda_{sig}) \text{ (W)}$$

$P(\lambda_{sig})$: linear value (W) of level at optical signal wavelength

When Level Detection Type is set to Σ Power, the optical signal level is calculated by the following formula:

$$L_{S, Lin} = \sum_{i=1}^n \{P(i) - N(\lambda_{sig})\} * \frac{Span}{Sampl - 1} * \frac{\alpha}{ActRes(i)} \text{ (W)}$$

n: Data count in the range of Signal Span

Span: Span (nm)

Sampl: Sampling point

P(i): ith data level (W)

ActRes(i): ith data Actual Resolution

α : Equipment dependent power correction coefficient

7. When Normalization at Noise Parameter is set to On, the noise level is normalized in the wavelength range set at Noise BW to calculate the noise level per *.* nm. SNR is calculated for this noise level.

$$SNR = 10 \log \left(\frac{L_{S, Lin}}{N'(\lambda_{sig})} \right) \text{ (dB-nm)}$$

$N'(\lambda_{sig})$: Linear value of noise normalized by Noise BW (W/nm)

$$N'(\lambda_{sig}) = \frac{N(\lambda_{sig}) \alpha}{ActRes(\lambda_{sig})} \cdot NBW \text{ (W/nm)}$$

$ActRes(\lambda_{sig})$: Actual resolution (nm) at optical signal wavelength

NBW: Noise BW

5.5.5 Procedures

To measure WDM

1. When the name of the **F7** horizontal key is not **Application**, press **F8**, and then press **F7**.
2. Press **f5 WDM Test** to display the measurement result display field.
3. Input the optical signal.
4. Set the wavelength, resolution, and level scale.
5. Press **Single** to start the measurement.
6. Press **f3 Display Mode**.
7. Set the display method using **f1** to **f4**.
8. Press **f4 Signal Parameter**.
9. Set the following items in the dialog box:
S.Level: A range of 0.1 to 50.0 dB can be input.
Search Threshold: A range of 0.01 to 10.0 dB can be input.
Wavelength-Detection Type: When Threshold is set, Threshold Cut Level is used to detect wavelength. Input the Threshold Cut Level in the range of 0.1 to 50 dB.
Level-Detection Type: When Σ Power is set, Signal Span is used to calculate power. Input Signal Span in the range of 0.01 to 50.00 nm.
10. Press **f7 Set** to update the value in the measurement result field.
11. When not wanting to display any wavelength data on the screen, press **f1 Next Page** or **f2 Last Page**.
12. Press **f7 Off** to finish the WDM measurement.

To set Noise Level when SNR displayed

1. Press **f5 Noise Parameter**.
2. Set the following items in the dialog box:
 - Normalization: When On is set, Noise BW is used to calculate noise level. Input a value for Noise BW in the range of 0.1 to 1.0 nm.
 - Detection Type: Sets Area or Point.
 - Area: When Area is set at Detection Type, set the fitting curve and measurement area.
 - Point: When Point is set at Detection Type, set the measurement position.
3. Press **f7 Set** to update the value in the measurement result display field.
4. When Point is set at Detection Type in step 2, press **f6 Noise Position** when setting the wavelength difference for measuring noise.
When Area is set at Detection Type, **f6 Noise Position** cannot be set.
5. Input the wavelength difference (Noise Position) using the keypad or the rotary knob. The setting range is 0.01 to 20.0 nm.
The value in the measurement display field is displayed.
6. When setting the wavelength difference, press **f1 On**.
When not setting the wavelength difference, press **f2 Off**.

To set reference wavelength and display range when Relative displayed

1. Press **f5 Ref No**.
2. Set the reference wavelength number using the keypad or the rotary knob. Input a value from 1 to the Peak Count.
When setting the wavelength number, the marker moves to the wavelength and level for that number and the values in the measurement results display field are updated.
3. Press **f6 Top Page No**.
4. Set the wavelength number to be displayed in the top line of the measurement results using the keypad or the rotary knob. Input a value from 1 to the Peak Count.
When setting the wavelength number, up to five measurement results from that number are displayed.

5.6 Measuring Laser Diode Modules

When using the laser diode module measurement function, the following items are measured.

- **Signal:** Signal wavelength and signal level
Signal level varies according to the SignalLevel settings made in the Signal Parameter dialog box.
- **Peak:** Peak signal wavelength and peak signal level
- **Slice Level:** This is the threshold value for calculating standard deviation σ .
- **SMSR:** Side mode wavelength and level
- **2nd Peak:** SMSR (Side Mode Suppression Ratio)
- **Mode Offset:** Difference between side mode wavelength and peak wavelength (Mode Offset)
- **SNR (Res **nm):** Signal to noise ratio (actual measured value)
The measured noise level is used to calculate SNR.
- **SNR (/*. *nm):** SNR (Conversion value per Noise Span)
Uses noise level per noise bandwidth in SNR calculation
- **σ :** Standard deviation of spectrum using RMS method
- **K σ :** Spectrum width
K = 2.35 is equivalent to 3 dB down and K = 6.07 is equivalent to 20 dB down.
- **ndB Width:** Spectrum width at specified cut level
- **Stop Band:** Difference between peak wavelength and both side mode wavelengths
- **Center Offset:** Difference between peak wavelength and average of both side mode wavelengths

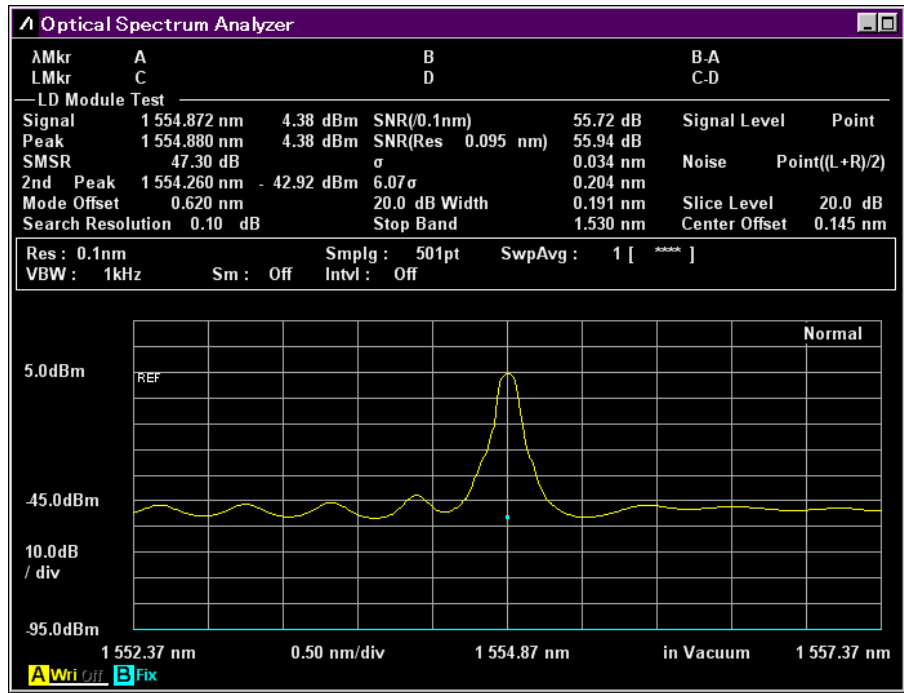

Figure 5.6-1 LD Module-Test Example

5.6.1 How to Set the Signal Measurement Method

In the Signal Parameter dialog box, set the level range and wavelength/level detection method.

- SMSR Parameter

This selects the detection method for the Side Mode.

2nd Peak: Peak with next highest level after maximum peak becomes side mode

Left: Peak to left adjacent side of maximum peak becomes side mode

Right: Peak to right adjacent side of maximum peak becomes side mode

- $K\sigma$

This sets constant for standard deviation σ

$K = 2.35$ is equivalent to 3 dB down, and $K = 6.07$ is equivalent to 20 dB down.

- ndB Width

This specifies the cut level used for spectrum width measurement. The cut level is an attenuator from the peak level.

- Search Resolution

This sets the level resolution (dB) to define the side mode.

Peak P1 in the following diagram has ripple P4 of ΔI_4 dB. If this ripple is evaluated as a side mode, the SMSR is not measured correctly. In this case, if the level resolution is set to a larger value than ΔI_4 dB, the P4 ripple is not detected and SMSR can be measured.

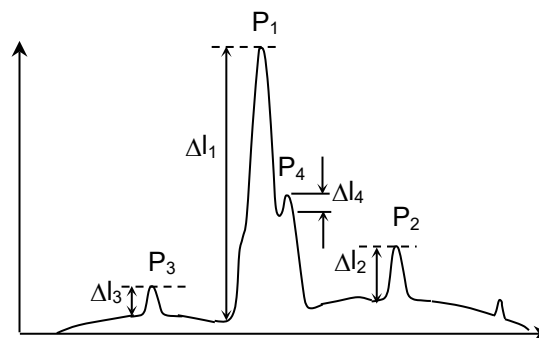

Figure 5.6.1-1 Example of Waveform where 2nd Peak Not Measured Correctly

- Signal Parameter

The Signal Parameter dialog box sets the level range to calculate standard deviation (Slice Level), and wavelength/level detection method.

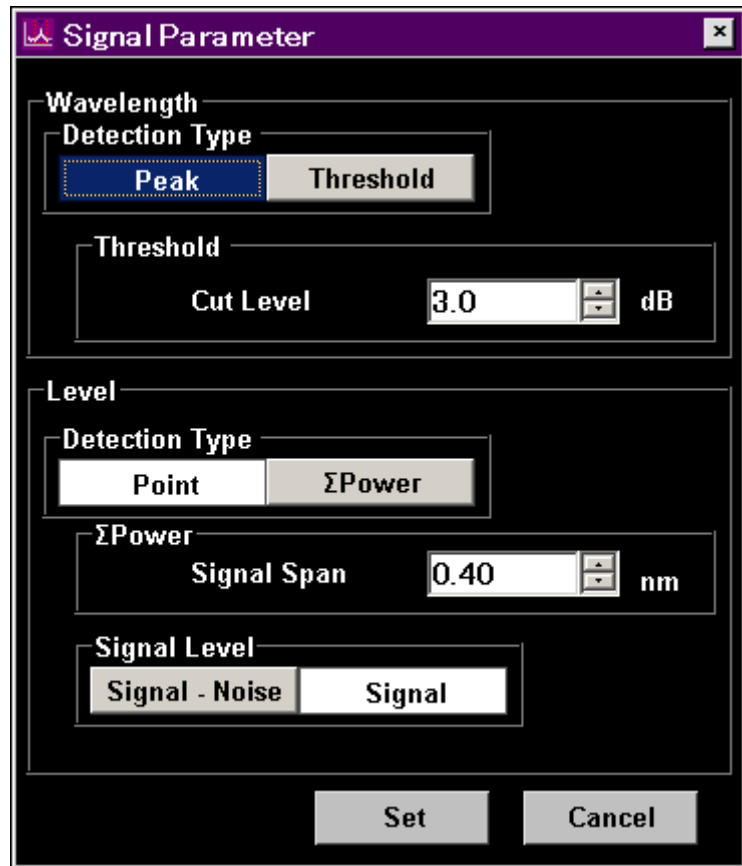

Figure 5.6.1-2 Signal Parameter Dialog Box

Table 5.6.1-1 Setting Range of the Parameters in the Signal Parameter Dialog Box

Item	Min.	Max.	Unit
Cut Level	0.1	50.0	dB
Signal Span	0.01	50.00	nm

Wavelength

Detection Type: Detection method for Signal wavelength

Peak: Wavelength peaks

Threshold: Center wavelength for Threshold analysis

Threshold Cut Level: Level differential from maximum which peaks are detected as signal.

This value is effective when selecting Threshold at Detection Type.

Threshold Cut Level can be set in the range from 0.1 to 50.0.

Note:

The center wavelength on the screen becomes the detection wavelength if the wavelength is not detected in the range of level set at Threshold Cut Level.

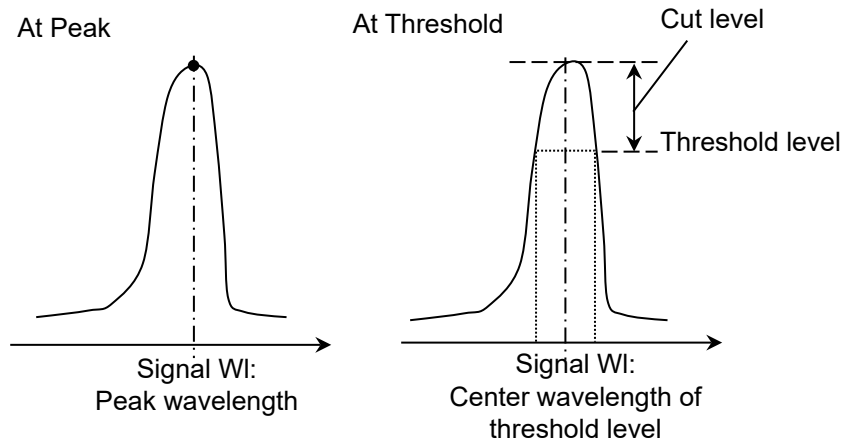

Figure 5.6.1-3 Measurement Method for Wavelength

Level	
Detection Type:	Detection method for signal level
Point:	Point level for Signal wavelength
Σ Power:	Detects Integrated level for Signal Span wavelength range
Signal Span can be set in the range from 0.01 to 50.00.	
Signal Level:	Calculation method of signal level (See below.)
[Signal – Noise]:	Measurement Level* – Noise Level
[Signal]:	Measurement Level*

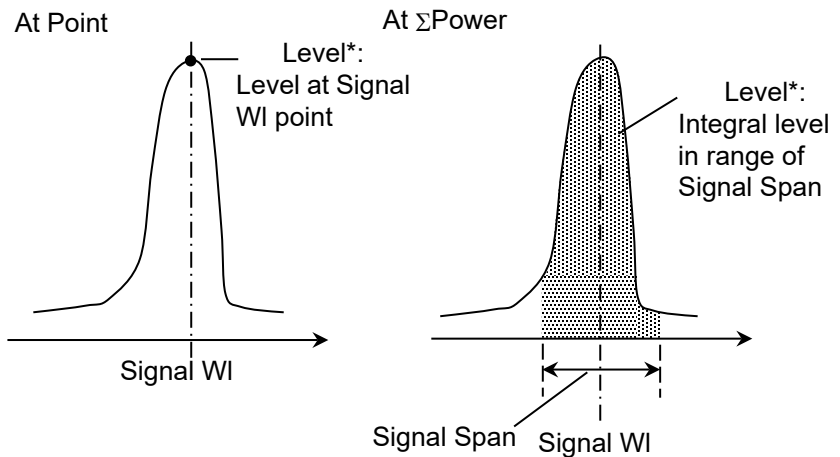

Figure 5.6.1-4 Measurement Method for Level

When Level Detection Type is set to Point, the optical signal level ($L_{S, Lin}$) is calculated by the following formula:

When the Signal Level is set at [Signal],

$$L_{S, Lin} = P(\lambda_{sig}) \quad (W)$$

When the Signal Level is set at [Signal–Noise],

$$L_{S, Lin} = P(\lambda_{sig}) - N(\lambda_{sig}) \quad (W)$$

$P(\lambda_{sig})$: level at detected optical signal wavelength

$N(\lambda_{sig})$: noise level at optical signal wavelength

When Level Detection Type is set to Σ Power, the optical signal level is calculated by the following formula:

When the Signal Level is set at [Signal],

$$L_{S, Lin} = \sum_{i=1}^n \{P(i)\} * \frac{Span}{Sampl - 1} * \frac{\alpha}{ActRes(i)} \quad (W)$$

When the Signal Level is set at [Signal–Noise],

$$L_{S, Lin} = \sum_{i=1}^n \{P(i) - N(\lambda_{sig})\} * \frac{Span}{Sampl - 1} * \frac{\alpha}{ActRes(i)} \quad (W)$$

n: Data count in the range of Signal Span

Span: Span (nm)

Sampl: Sampling point

$P(i)$: ith data level (W)

$ActRes(i)$: ith data Actual Resolution

α : Equipment dependent power correction coefficient

Note:

When the wavelength range set at Signal Span cannot be accommodated within the screen, only the data for the on-screen wavelength range is totaled.

5.6.2 How to Set the Noise Measurement Method

In the Noise Parameter dialog box, set the noise level for the SNR measurement and detection method.

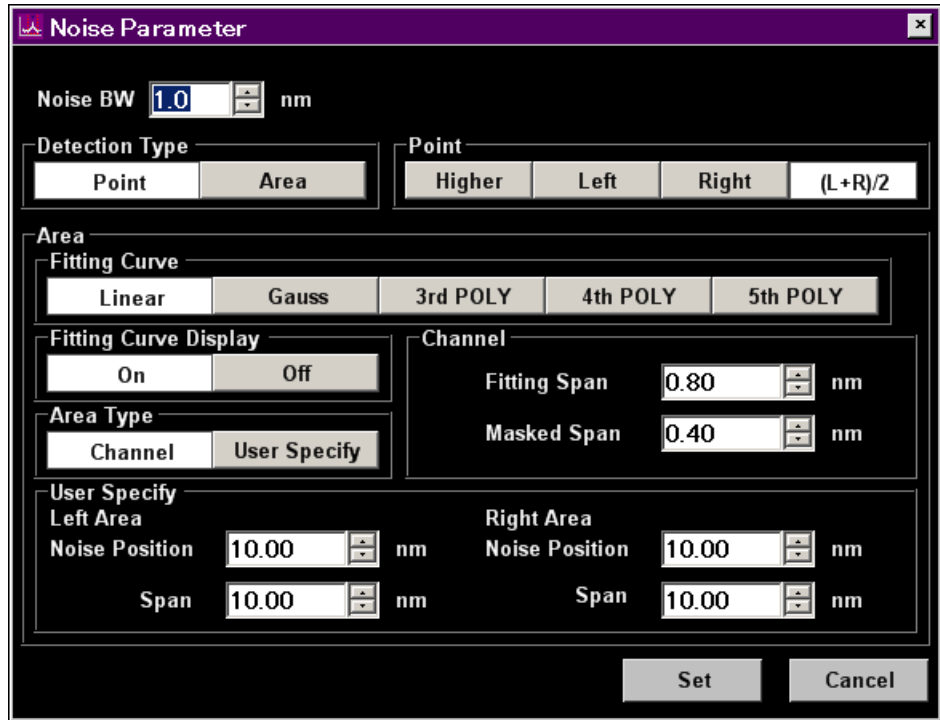

Figure 5.6.2-1 Noise Parameter Dialog Box

Table 5.6.2-1 Setting Range of the Parameters in the Noise Parameter Dialog Box

Item	Min.	Max.	Unit
Fitting Span	0.01	20.00	nm
Masked Span	0.01	20.00	nm
Noise BW	0.1	1.0	nm
Noise Position	0.01	100.00	nm
Span	0.01	100.00	nm

Noise BW :

Band width used for noise level calculation

Detection Type:

Detection method for noise level

Area: Noise obtained from value of fitting curve at signal wavelength. The fitting curve is calculated from the noise waveform in the Noise Area

Point: Noise measured at position specified at Noise Point

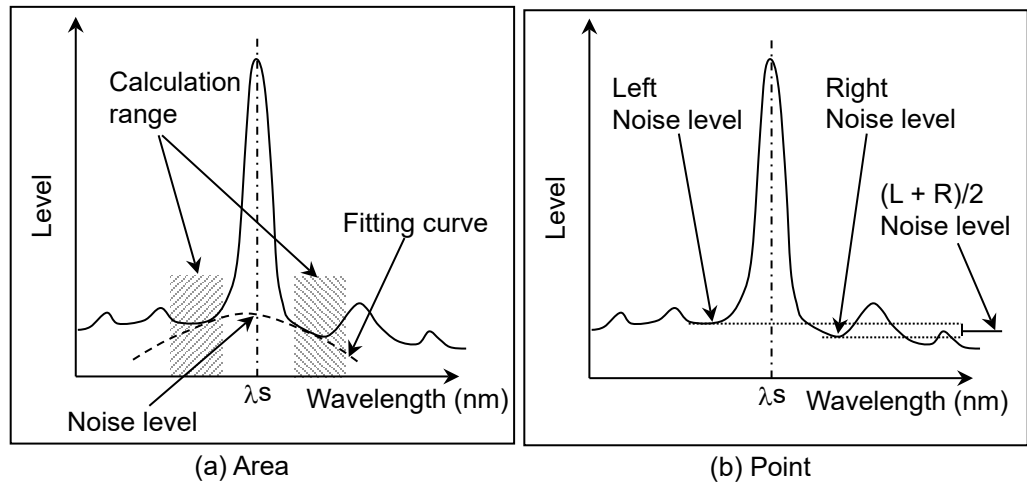

Figure 5.6.2-2 Detection Method for Noise Level

When Detection Type is set to Point, the position for measuring noise level can be set by **f3 Noise Position**.

Noise Position

On: When the Noise Parameter Point is set to Left, the position is separated by wavelength difference $\Delta\lambda$ on the shorter wavelength side of the optical signal wavelength λ_s .

When Point is set to Right, the position is separated by wavelength difference $\Delta\lambda$ on the longer wavelength side of the optical signal wavelength λ_s .

When Point is set to Higher, the position is at the higher level of the wavelength difference $\Delta\lambda$ on the left or right side of the optical signal wavelength λ_s (left side in Figure 5.6.2-3 (b)).

When Point is set to $(L+R)/2$, the position is at the average of the levels of the wavelength difference $\Delta\lambda$ on the left and right sides of the optical signal wavelength λ_s .

Off: When the Noise Parameter Point is set to Left, the position is at the dip level on the shorter wavelength side of the optical signal.

When Point is set to Right, the position is at the dip level on the longer wavelength side of the optical signal.

When Point is set to Higher, the position is at the higher level of the dip points on the left or right side of the optical signal (left in Figure 5.6.2-3 (a)).

When Point is set to $(L+R)/2$, the position is at the average of the levels of the dip points on the left and right sides of the optical signal.

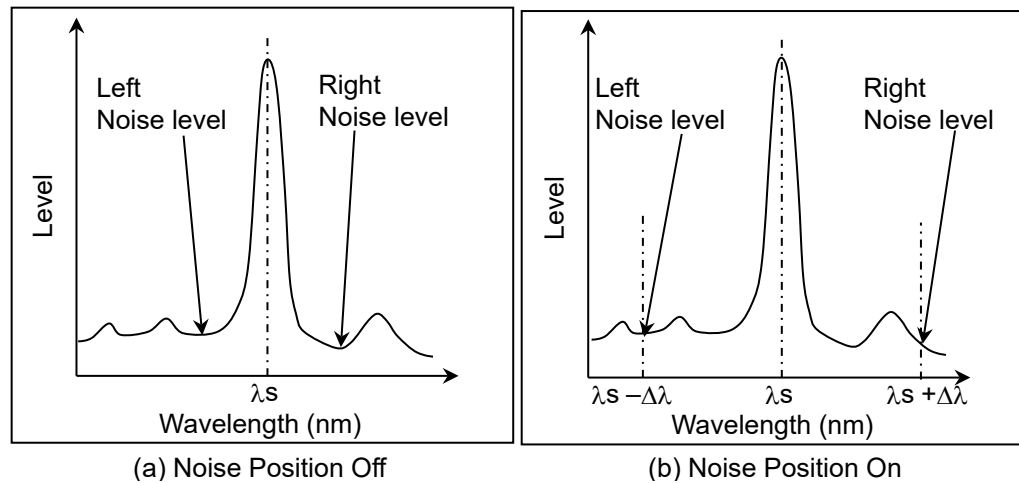

Figure 5.6.2-3 Measurement of Noise at Noise Position

Point:

Noise level detection point when Detection Type is Point

Higher: Higher level at left side or right side of signal wavelength

Left: Signal left side (short wavelength side)

Right: Signal right side (long wavelength side)

(L+R)/2: Average level of Signal left and right sides

Area:

Fitting curve calculation range when Detection Type is Area

Fitting Curve: Type of fitting curve

Linear: Linear equation for noise linear data

$$f(\lambda) = a\lambda + b$$

Gauss: Binomial equation for noise log data

$$f(\lambda) = a\lambda^2 + b\lambda + c$$

3rd POLY: Third-order polynomial equation for noise linear data

$$f(\lambda) = a\lambda^3 + b\lambda^2 + c\lambda + d$$

4th POLY: Forth-order polynomial equation for noise linear data

$$f(\lambda) = a\lambda^4 + b\lambda^3 + c\lambda^2 + d\lambda + e$$

5th POLY: Fifth-order polynomial equation for noise linear data

$$f(\lambda) = a\lambda^5 + b\lambda^4 + c\lambda^3 + d\lambda^2 + e\lambda + f$$

Fitting Curve Display:

Fitting curve display setting

Off: Does not display fitting curve on screen

On: Displays fitting curve on screen

Area Type Area setting method for calculating fitting curve

Channel: Symmetrical area to Signal wavelength

User Specify: User specified range by left and right side of Signal Wavelength

- Channel: Area setting when Noise Area is Channel
- Fitting Span: Wavelength range for calculating fitting curve
- Masked Span: Wavelength range excluded from fitting curve calculation
- User Specify: Area setting when Noise Area is User Specify
- Noise Position: Wavelength difference between screen center wavelength and area center wavelength
- Span: Area wavelength range

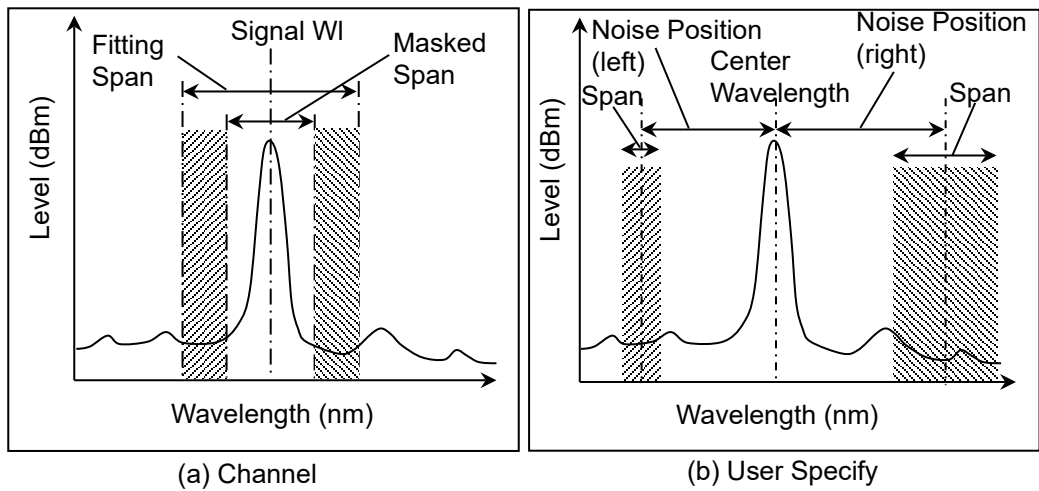

Figure 5.6.2-4 Noise Level Measurement Range Set at Area Type

Note:

When the wavelength range set at Channel or User Specify cannot be accommodated within the measured wavelength range, the fitting curve is calculated using only the measured wavelength range data.

When the wavelength range set at Channel or User Specify is outside the measured wavelength range, SNR is displayed as *** and no fitting curve is displayed.

5.6.3 Calculation Method

1. The peak level of waveform is detected.
2. The side mode wavelength and level are measured in accordance with the Search Resolution.
3. SMSR is measured in accordance with the SMSR Parameter.
4. Mode Offset, Stop Band, Center Offset are calculated.

Processing is performed as follows where the wavelength of the maximum peak is λ_{max} , the wavelengths on both sides of the maximum peak are λ_{left} and λ_{right} , and the side mode wavelength is λ_{side} .

$$\text{Mode Offset} = \lambda_{side} - \lambda_{max}$$

$$\text{Stop Band} = \lambda_{right} - \lambda_{left}$$

$$\text{Center Offset} = \lambda_{max} - \frac{\lambda_{right} + \lambda_{left}}{2}$$

However, λ_{side} is the side mode selected at Side Mode 2nd Peak, Left, or Right.

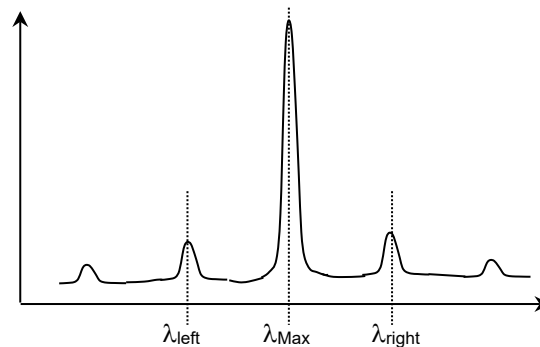

Figure 5.6.3-1 Position of Peak Wavelength and Side Modes

5. σ is calculated as follows where B_n and λ_n ($n = 1, 2, 3 \dots i$) is measured level and wavelength at the point with a level more than a slice level down from the peak.

$$\sigma = \sqrt{\frac{\sum B_n \times \lambda_n^2}{\sum B_n} - \lambda_c^2}$$

$$\lambda_c = \frac{\sum B_n \times \lambda_n}{\sum B_n} = \frac{B_1 \lambda_1 + B_2 \lambda_2 + \dots + B_i \lambda_i}{B_1 + B_2 + \dots + B_i}$$

6. Spectrum width is calculated in accordance with the $K\sigma$.
7. The Signal wavelength is measured in accordance with the Wavelength-Detection Type setting of Signal Parameter.
8. The Signal level is measured in accordance with the Level-Detection Type of Signal Parameter.

9. The noise measurement position and range are determined in accordance with the Noise Parameter Detection Type and Noise Position settings.

Table 5.6.3-1 Noise Measuring Point

Noise Parameter Detection Type	Noise Position	Noise Parameter Area Type	Position or Area
Point	Off	–	Figure 5.6.2-3 (a)
	On	–	Figure 5.6.2-3 (b)
Area	–	Channel	Figure 5.6.2-4 (a)
	–	User Specify	Figure 5.6.2-4 (b)

10. When the Noise Parameter Detection Type is Point, the level at the position set at Noise Position is measured.
When the Noise Parameter Detection Type is Area, the fitting curve specified at Fitting Curve is calculated. The level at the fitting curve WDM signal wavelength is measured.

11. SNR (signal to noise ratio) is calculated by the following formula.
SNR (Res ***nm) is calculated by the following formula.

$$SNR = 10 \log \left(\frac{L_{S, Lin}}{N(\lambda_{sig})} \right) \text{ (dB)}$$

When the Noise Parameter Detection Type is set to Point,

$$L_{S, Lin} = P(\lambda_{sig}) - N(\lambda_{sig}) \text{ (W)}$$

P(λsig): level at detected optical signal wavelength

N(λsig): noise level at optical signal wavelength

When the Noise Parameter Detection Type is set to ΣPower,

$$L_{S, Lin} = \sum_{i=1}^n \{P(i) - N(\lambda_{sig})\} * \frac{Span}{Sampl - 1} * \frac{\alpha}{ActRes(i)}$$

n: Data count in the range of Signal Span

Span: Span (nm)

Sampl: Sampling point

P (i): ith data level (W)

ActRes (i): ith data Actual Resolution

α: Equipment dependent power correction coefficient

N (λsig): Linear value (W) of noise level at optical signal wavelength

SNR (/*.*nm) means Signal to Noise Ratio per Noise BW.

SNR (/*.*nm) is calculated using the following equation:

$$SNR = 10 \log \left(\frac{L_{S, Lin}}{N'(\lambda_{sig})} \right) \text{ (dB}\cdot\text{nm)}$$

$N'(\lambda_{sig})$: Linear value (W) of noise level normalized by Noise BW

$$N'(\lambda_{sig}) = \frac{N(\lambda_{sig}) \alpha}{ActRes(\lambda_{sig})} \cdot NBW \text{ (W/nm)}$$

$ActRes(\lambda_{sig})$: Actual resolution (nm) at optical signal wavelength

NBW: Noise BW

Note:

With the SNR measurement, $L_{s, Lin}$ in the SNR calculation formula is the value subtracting the noise level, regardless of the Signal Level settings of Signal Parameter.

5.6.4 Procedures

To measure laser diode module

1. Input the optical signal in the MS9740B.
2. Set the wavelength, resolution, and level scale.
3. Press **Single** to start the measurement.
4. When the name of the **F7** horizontal key is not **Application**, press **F8**, and then press **F7**.
5. Press **f6 LD Module Test** to display the measurement result display field.
6. Press **f1 Signal Parameter**.
7. Specify the wavelength and level measurement method using the arrow keys or rotary knob.
8. Press **f7 Set** to update the value in the measurement result display field.
9. Press **f2 Noise Parameter**.
10. Specify the noise measurement method using the arrow keys or rotary knob.
11. Press **f7 Set** to update the value in the measurement result display field.
12. Press **f3 Noise Position**.
13. Set the difference in wavelength between the wavelength where the noise level is measured and the wavelength of the optical signal. For the measurement location of noise level, refer to Figure 5.6.2-3.

14. **f1 On:** Sets wavelength difference On.
Use the rotary knob or the ten numeric keys to input the wavelength difference for noise measurement. The wavelength difference is input in the range 0.01 to 20 nm.
f2 Off: Sets wavelength difference Off.
The position for measuring noise level is set automatically.
The minimum level between adjacent optical signals is the noise.
15. Press **f7 More 1/2**.
16. Press **f1 Slice Level**. Enter the slice level value using the rotary knob or keypad. The slice level input range is 0.1 to 50 dB.
17. Press **f2 SMSR Parameter**.
18. Select the side mode searching method using **f1** to **f3**:
 - 2nd Peak: High side mode with next highest level after maximum level
 - Left Peak point at maximum level shorter wavelength side
 - Right Peak point at maximum level longer wavelength side
19. Press **f3 K σ** and input the ratio of reference deviation using **f1** to **f5** keys, the keypad, or rotary knob. The factor can be entered from 1 to 10.

For the relationship between factor and level differences, refer to 4.5.5 “Analyzing Multiple Spectrum Center Wavelength and Spectrum Width (RMS Method).”
20. Press **f4 ndB Width**. Input the cut level (in ndB), using the keypad or rotary knob.
21. Press **f5 Search Resolution**. Enter the value using the rotary knob or keypad.
Search Resolution can be input in the range of 0.1 to 10.0 dB.
22. Press **f6 Off** to finish the laser diode module measurement.

Note:

When measuring faceted light sources such as LEDs, VCSELs, etc., set MM Mode to On.

For the precautions when using multimode fiber, refer to 2.7 “Precautions at Measurement”.

5.7 Measuring Optical Amplifier

5.7.1 Optical Amplifier Measurement Method

The following items can be measured by the optical amplifier functions.

- NF: Noise figure
- Gain: Gain
- Signal Wl: Amplified optical peak wavelength
- ASE Lvl/(Res): ASE level for amplified light
- Pin Lvl: Signal level input
- Pout Lvl: Signal level output

The noise figure and gain are calculated from the power of the optical input to the optical amplifier (Pin), the power of the optical signal output from the optical amplifier (Pout), and the ASE level (Pase).

For the calculation formula, refer to 5.7.7 “Calculation Method”.

Pin, Pout, and Pase are measured from the optical input to the optical amplifier and the spectrum of the optical output of the optical amplifier.

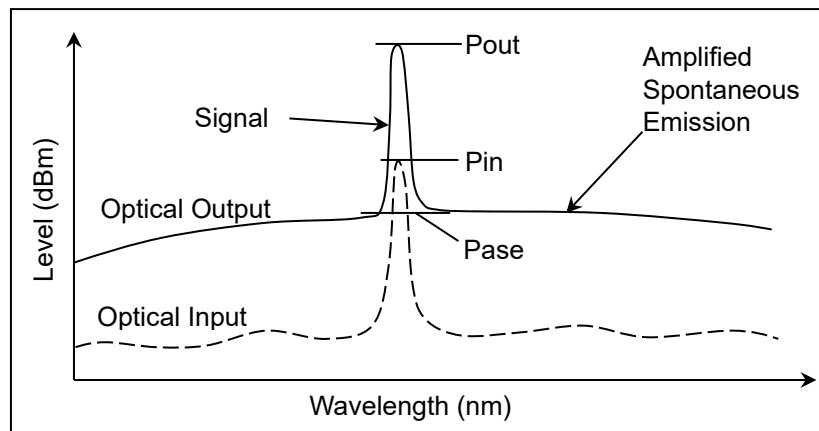

Figure 5.7.1-1 Level Measured with Optical Amplifier Measurement Function

This function has following setting items.

- Method
Selects the measurement method.

Spect Div Off:

Not using spectrum division method, Pout and Pase are measured by the measured optical output spectrum.

Spect Div On:

Uses the spectrum division method.

Pout and Pase are obtained by subtracting the level of the optical input spectrum from the level of the measured output spectrum.

PLZN Nulling:

Polarization Nulling Method

With the polarization nulling method, Pout and Pase are obtained by assuming that the state of polarization of the optical output from the optical amplifier is as follows:

- The signal is polarized.
- The ASE is unpolarized.

If the signal is blocked by the polarizer, then the ASE level can be measured. Pout is the level when the optical signal is passed by the polarizer and Pase is the level when it is blocked by the polarizer.

Pulse Method:

Pulse Method

The ASE level of the optical amplifier is the level that is held for an instant after the optical signal level is blocked. The pulse modulated optical signal is input to the optical amplifier and Pout and Pase are measured by making use of this property.

Pout is the output level when the optical signal is on and Pase is the output level when the optical signal is off.

WDM Measure:

Measurement of wavelength multiplexed light

The gain and noise figure are measured for the wavelength multiplexed light. Pout and Pase are measured using the pulse method described above for the target wavelength.

- **ASE Fitting**

At Spect Div Off and Spect Div On, Pase is obtained from the spectrum through an approximation method by a fitting method.

There are two types of fitting method as follows:

Gauss Fitting:

Fitting Method Using a Gaussian Function

Fitting is performed using the second-order approximation

$L(\lambda)=a\lambda^2+b\lambda+c$ from data in the range of λ_1 to λ_2 (dBm units) and λ_3 to λ_4 in Figure 5.7.1-2 (a). The level of the optical signal wavelength λ_s found from this function is Pase.

Mean Fitting:

Fitting Method Utilizing a Linear Function

The mean of the data for λ_2 and λ_3 in Figure 5.7.1-2 (b) is found (mW units). The product of this value and optical band filter correction value is Pase.

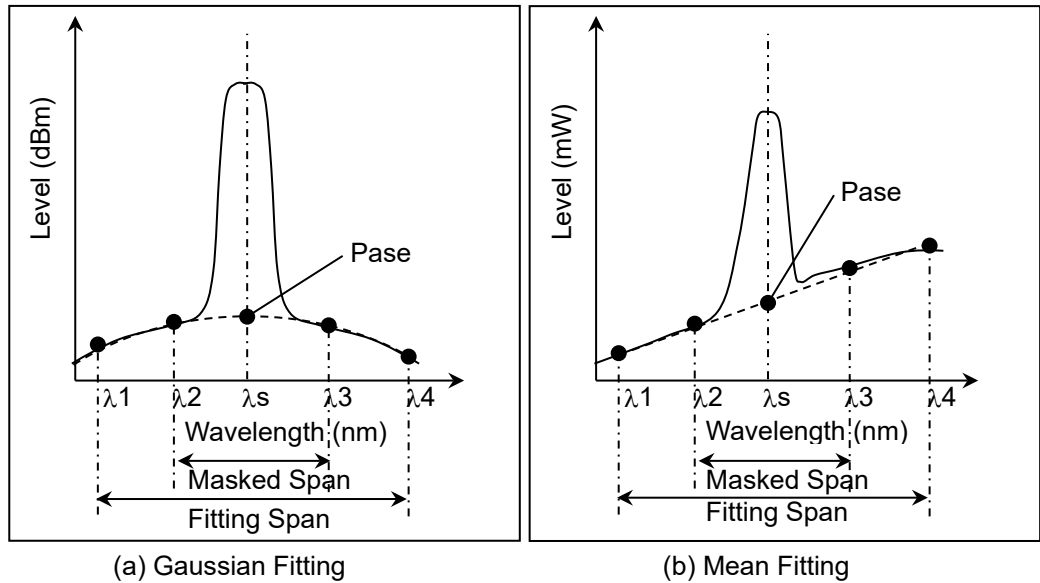

Figure 5.7.1-2 Finding Pase

The input range and the data set with the optical amplifier measurement are as follows.

This data is input in the Parameter dialog box.

Table 5.7.1-1 Setting Range of the Parameters in the Parameter Dialog Box

Item	Min.	Max.	Unit
Fitting Span*1	0.10	100.00	nm
Masked Span*2	0.10	100.00	nm
Pin Loss	-10.00	10.00	dB
Pout Loss	-10.00	10.00	dB
NF Cal	0.100	10.000	None
O.BPF Lvl Cal	0.00	30.00	dB
O.BPF BW	0.00	999.99	nm
Pol Loss*3	-10.00	10.00	dB

*1: The Fitting Span is set within the following range so as to fit within the screen's wavelength range.

$$\text{Signal Wl} + \text{Fitting Span}/2 = < \text{Stop}$$

$$\text{Signal Wl} - \text{Fitting Span}/2 > = \text{Start}$$

If Fitting Span is set outside the screen wavelength range, the ASE level cannot be calculated.

*2: Masked Span is smaller than Fitting Span.

*3: Pol Loss is used by the polarization nulling method.

- Fitting Span

This sets the target data range for ASE Fitting as the width centered around the peak wavelength.

- Masked Span

This sets the target data range excluded from ASE Fitting as the width centered around the peak wavelength.

- NF Select

This selects the NF calculation method.

S-ASE:

The noise figure is calculated from the beat noise between the optical signal and the ASE.

Total:

The noise figure is calculated from the sum of the following noise values.

- Beat noise between optical signal and ASE optical output
- Beat noise between ASE optical output
- Optical signal shot noise
- ASE optical output shot noise

- NF Cal

This sets the calibration factor used at NF calculation.

- O.BPF Lvl Cal

This sets the pass and filter levels for the optical bandpass filter inserted between the optical amplifier and MS9740B. Set 0 dB when no filter is inserted or when the characteristics of an optical amplifier with built-in filter are evaluated.

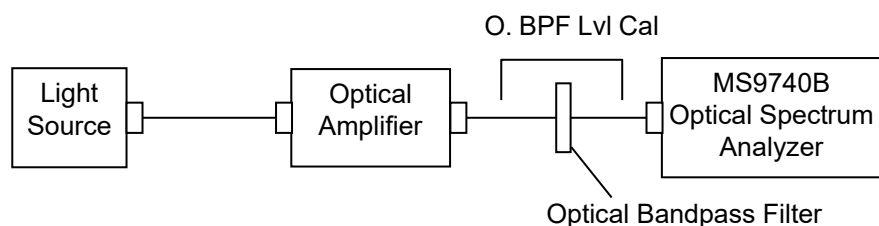

- O.BPF BW

O.BPF.BW sets the ASE bandwidth when NF Select is Total. When determining the noise figure when a narrow optical bandpass filter is installed, set the filter bandwidth.

When determining the noise figure when a filter is not inserted, set the ASE bandwidth.

The value set by O.BPF.BW uses items F_2 and F_4 of the NF (Total) equation described in section 5.7.7.

When O.BPF.BW is set to 0 nm, the noise figure does not include beat noise (F_2) between ASE nor the ASE shot noise (F_4).

- Pin Loss

This sets the level difference that is the level of the optical signal input to MS9740B subtracted from the level of the optical signal actually input to the optical amplifier.

This is used when measuring the optical input (Pin).

- Pout Loss

This sets the level difference that is the level of the amplified optical signal input to MS9740B subtracted from the level of the amplified optical signal actually output by the optical amplifier.

This is used when measuring the optical output (Pout).

When the optical bandpass filter is installed, Pin and Pout are as shown below.

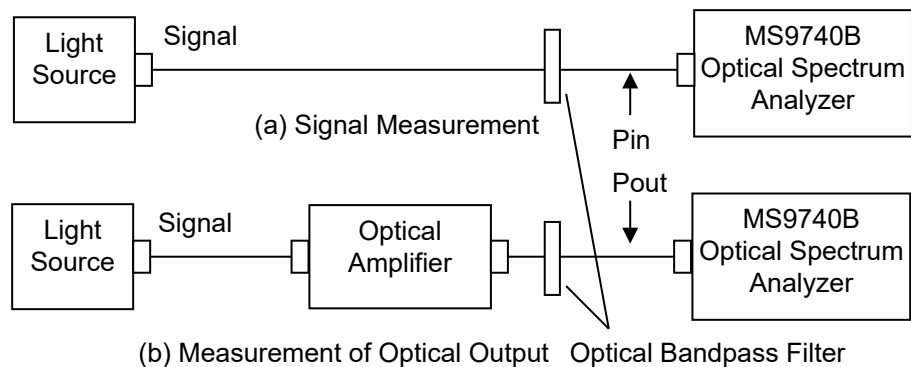

- Pol Loss

This sets the analyzer loss using the polarization nulling method.

This is used when measuring the ASE output (Pase).

If the optical polarization is changed using the polarization controller, the output level from the analyzer is changed as well. The analyzer loss is the difference between the maximum value of the analyzer output level and the output level from the polarization controller.

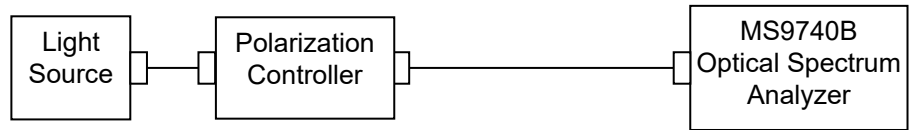

(a) Measurement of the Output Level of the Polarization Controller

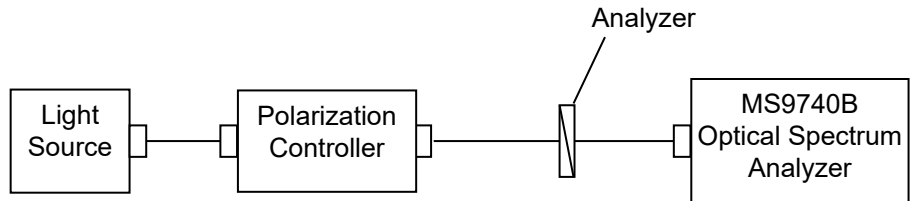

(b) Measurement of Analyzer Output Level

- Ext. Trigger Delay

This sets the delay time for external sync measurement at pulse or multiple division wavelength measurements. This function button is not displayed in the measurements other than pulse or multiple division wavelength measurements.

- Write to

This selects the signal to be measured.

Pin:

This measures the optical input.

Pout:

This measures the optical output.

Pase:

This measures the amplified spontaneous emission. It can be selected at the polarization nulling method.

- Pin

This selects the traces A to J to store the input waveform.

- Pout

This selects the traces A to J to store the output waveform.

- Pase

This selects the traces A to J to store the ASE waveform.

See 5.7.7 “Calculation Method” for the formulas for each measurement method.

5.7.2 Optical Amplifier Measurement Screen Display

To display the optical amplifier measurement functions,

1. When the name of the **F7** horizontal key is not **Application**, press **F8**, and then press **F7**.
2. Press **f7 More 1/2**.
3. Press **f1 Opt.AmpTest** to display the measurement result display field.
4. Press **f6 Off** to finish the optical amplifier measurement.

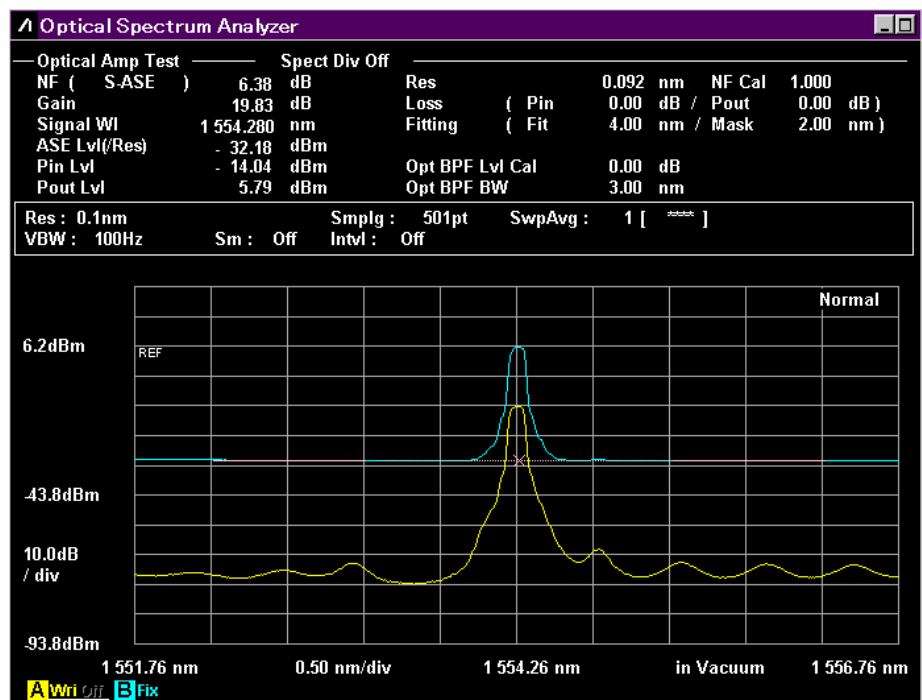

Figure 5.7.2-1 Sample Opt.Amp-Test

Note:

The optical signal power (Pin), power of the signal output from optical amplifier (Pout), and level of the ASE (Pase) are measured at the same wavelength range. When measurement is executed or this function is started, some traces are forcibly deleted if those wavelength ranges are different from the ones displayed by **f3 Write to**.

5.7.3 Measurement With/Without Spectrum Division Method

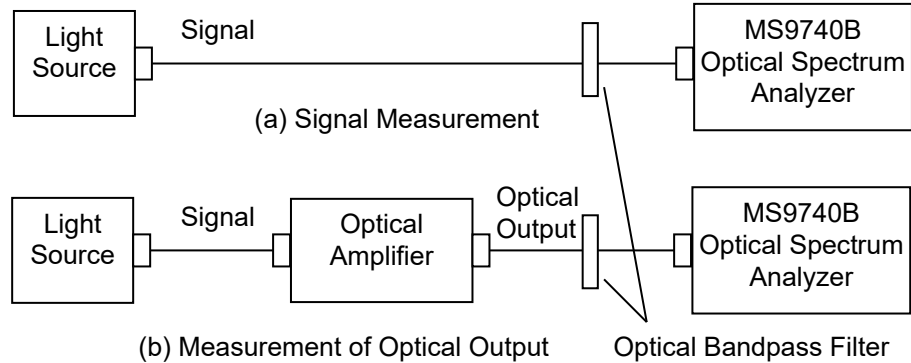

Figure 5.7.3-1 Optical Amplifier Measurement System

To perform measurements using the spectrum division method,

1. Press **f1 Method**.
2. Press **f1 Spect Div On**.
3. Press **f7 More 1/2**.
4. Press **f1 Pin**. Select the traces A to J to store the signal waveform.
5. Press **f2 Pout**. Select the traces A to J to store the optical output waveform.
6. Press **f7 More 2/2**.
7. Input the output light of the optical amplifier to MS9740B as shown by the connection in Figure 5.7.3-1 (a).
8. Set the wavelength, resolution, and level scale.
9. Press **f5 Res Cal**.
10. Press **f1 Execute**, and then the message indicating the resolution calibration in progress is displayed.
11. Press **f3 Write to**.
12. Press **f1 Pin**.
13. Press **Single** or **Repeat**.
The data for the trace specified at step 4 is stored.
14. Press **f3 Write to**.
15. Press **f2 Pout**.
16. Input the output light of the optical amplifier to MS9740B as shown by the connection in Figure 5.7.3-1 (b).
If necessary, insert an optical bandpass filter between the optical amplifier and MS9740B to remove the ASE.
17. Press **Single** or **Repeat**.
The data for the trace specified at step 5 is stored.
18. Press **f2 Parameter**.

19. Set the following items in the dialog box:
- | | |
|----------------|--|
| NF Select: | Noise figure calculation method |
| ASE Fitting: | Fitting method for the ASE level |
| Fitting Span: | Wavelength width targeted for the ASE level calculation |
| Masked Span: | Wavelength width excluded from the ASE level calculation |
| Pin Loss: | Calibration factor for the optical level input |
| Pout Loss: | Calibration factor for the optical level output |
| NF Cal: | Calibration factor for the noise figure |
| O.BPF Lvl Cal: | Attenuation of the optical bandpass filter |
| O.BPF BW: | Optical bandpass filter bandwidth |
- For the input range, refer to Table 5.7.1-1.
20. Press **f7 Set** to update the value in the measurement result display field.

To perform measurements without using the spectrum division method

1. Press **f1 Method**.
2. Press **f2 Spect Div Off**.
3. Perform operations 3 to 20 in the “To perform measurements using the spectrum division method” procedures.

5.7.4 Measurement Using Polarization Nulling Method

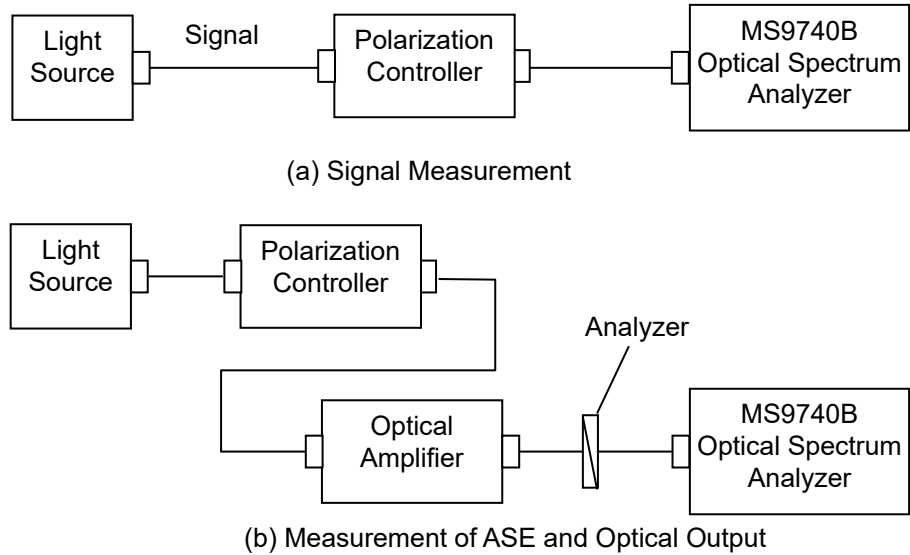

Figure 5.7.4-1 Measurement System for Polarization Nulling Method

To perform measurements using the polarization nulling method

1. Press **f1 Method**.
2. Press **f3 PLZN Nulling**.
3. Press **f7 More 1/2**.
4. Press **f1 Pin**. Select the traces A to J to store the signal waveform.
5. Press **f2 Pout**. Select the traces A to J to store the optical output waveform.
6. Press **f3 Pase**. Select the traces A to J to store the ASE waveform.
7. Press **f7 More 2/2**.
8. Input the output light of the optical amplifier to MS9740B as shown by the connection in Figure 5.7.4-1 (a).
9. Set the wavelength, resolution, and level scale.
10. Press **f5 Res Cal**.
11. Press **f1 Execute**. The message indicating the resolution calibration in progress is displayed.
12. Press **f3 Write to**.
13. Press **f1 Pin**.
14. Press **Single** or **Repeat**.
The data for the trace specified at step 4 is stored.
15. Press **f3 Write to**.
16. Press **f2 Pout**.

17. Input the output light of the optical amplifier to MS9740B as shown by the connection in Figure 5.7.4-1 (b).
18. Adjust the polarization controller to maximize the optical output level.
19. Press **Single** or **Repeat**.
The data for the trace specified at step 5 is stored.
20. Press **f3 Write to**.
21. Press **f3 Pase**.
22. Adjust the polarization controller to minimize the optical output level.
23. Press **Single** or **Repeat**.
The data for the trace specified at step 6 is stored.
24. Press **f2 Parameter**.
25. Set the following items in the dialog box:

NF Select:	Noise figure calculation method
ASE Fitting:	Fitting method for the ASE level
Fitting Span:	Wavelength width targeted for the ASE level calculation
Masked Span:	Wavelength width excluded from the ASE level calculation
Pin Loss:	Calibration factor for the signal level
Pout Loss:	Calibration factor for the optical level output
NF Cal:	Calibration factor for the noise figure
O.BPF Lvl Cal:	Attenuation from the optical bandpass filter
O.BPF BW:	Optical bandpass filter bandwidth
Pol Loss:	Attenuation from the analyzer

For the input range, refer to Table 5.7.1-1.
26. Press **f7 Set** to update the value in the measurement result display field.

5.7.5 Measurement Using Pulse Method

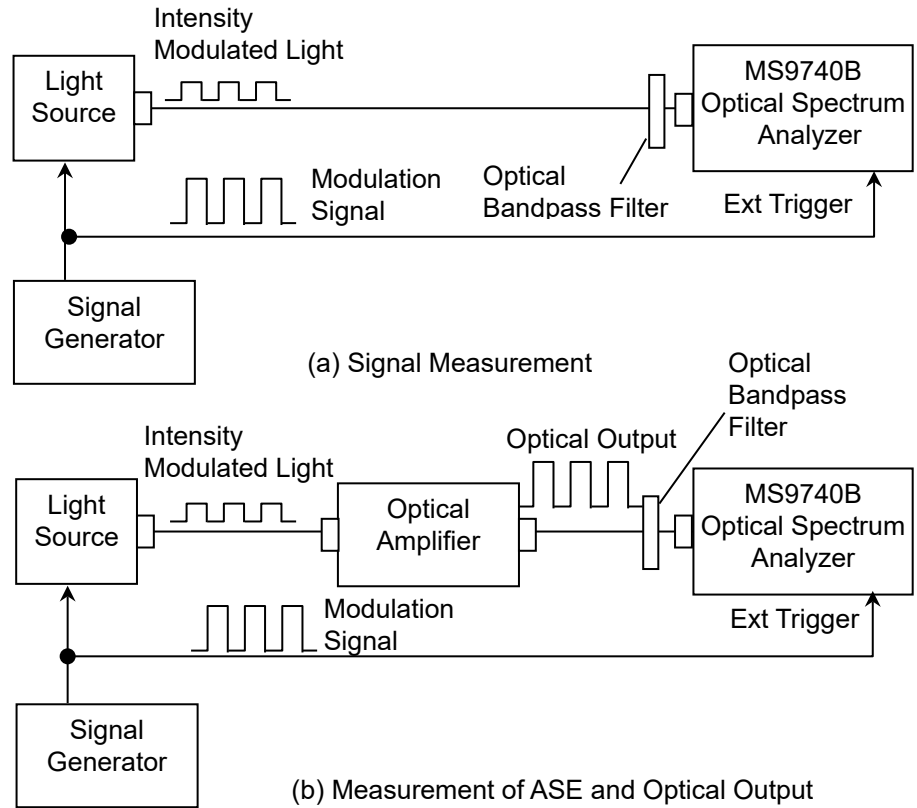

Figure 5.7.5-1 Pulse Method Measurement System

The light source used by pulse method is digitally modulated at a higher frequency (≤ 500 kHz) than the optical amplifier power control frequency. Normally, the modulation signal duty ratio is 50%.

Adjust the output level of the signal generator to maximize the extinction ratio of the light source.

Set the difference between the time when the signal input to the Ext Trigger connector changes and the time when sampling the optical signal input to MS9740B as the Ext Trigger Delay.

Measure the signal level P_{out} after elapse of the Ext Trigger Delay starting from the Ext Trigger rise, and measure the ASE level P_{ase} after elapse of the Ext Trigger Delay starting from the Ext Trigger fall.

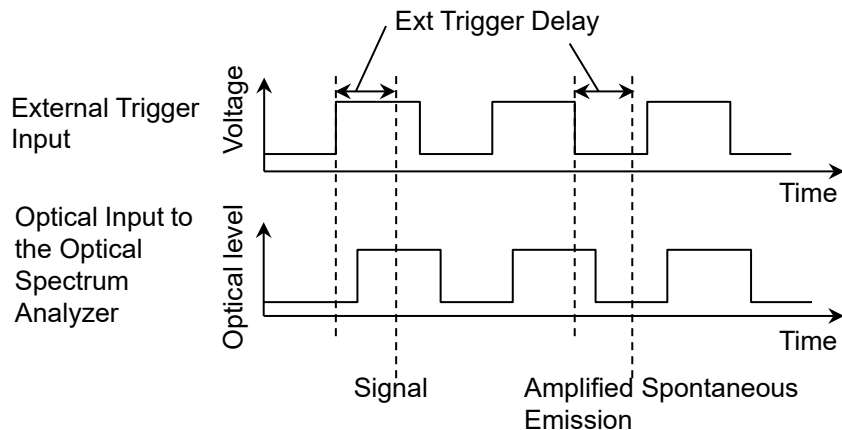

Figure 5.7.5-2 Definition of Ext Trigger Delay

To perform measurements using the pulse method

1. Press **f1 Method**.
2. Press **f4 Pulse Method**.
3. Press **f7 More 1/2**.
4. Press **f1 Pin**. Select the traces A to J to store the signal waveform.
5. Press **f2 Pout**. Select the traces A to J to store the optical output waveform.
6. Press **f3 Pase**. Select the traces A to J to store the ASE waveform.
7. Press **f7 More 2/2**.
8. Input the output light of the optical amplifier to MS9740B as shown by the connection in Figure 5.7.5-1 (a).
Input the modulation signal to the Ext Trigger connector on the rear panel.
9. Set VBW to a larger value than the modulation frequency.
10. Set the wavelength, resolution, and level scale.
11. Press **f5 Res Cal**.
12. Press **f1 Execute**. The message indicating the resolution calibration in progress is displayed.
13. Press **f4 Ext. Trigger Delay**.
14. Adjust the delay time to maximize the optical signal level and press **f8 Back**.

15. Press **f3 Write to**.
16. Press **f1 Pin**.
17. Press **Single** or **Repeat**.
The data for the trace specified at step 4 is stored.
18. Press **f3 Write to**.
19. Press **f2 Pout**.
20. Input the output light of the optical amplifier to MS9740B as shown by the connection in Figure 5.7.5-1 (b).
If necessary, insert an optical bandpass filter between the optical amplifier and MS9740B to remove the ASE.
21. Press **f4 Ext. Trigger Delay**.
22. Adjust the delay time to maximize the optical signal level.
23. Press **Single** or **Repeat**.
The optical amplifier optical signal and the ASE optical output data are each stored at the trace specified at steps 5 and 6.
24. Press **f2 Parameter**.
25. Set the following items in the dialog box:

NF Select:	Noise figure calculation method
Pin Loss:	Calibration factor for the signal level
Pout Loss:	Calibration factor for the optical level output
NF Cal:	Calibration factor for the noise figure
O.BPF Lvl Cal:	Attenuation from the optical bandpass filter
O.BPF BW:	Optical bandpass filter bandwidth

For the input range, refer to Table 5.7.1-1.
26. Press **f7 Set** to update the value in the measurement result display field.

5.7.6 Measuring Performance with Respect to Wavelength Multiplexed Light

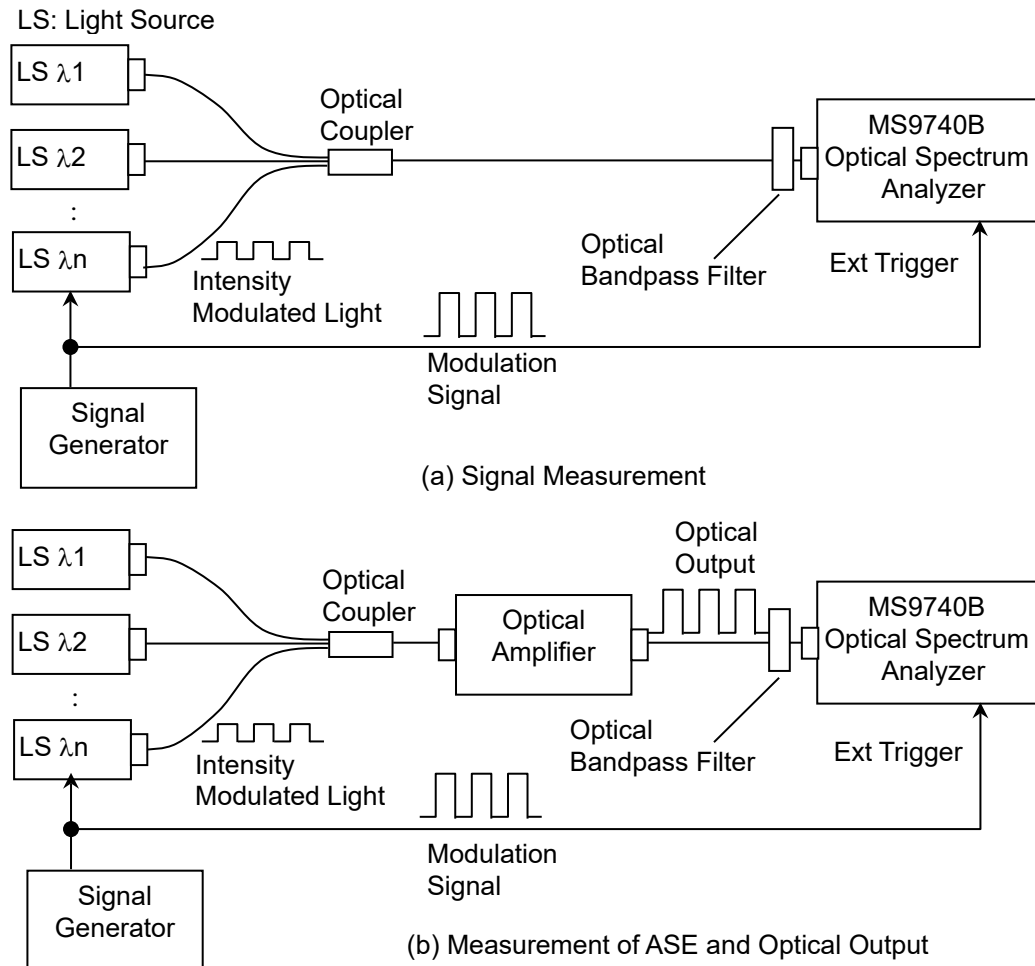

Figure 5.7.6-1 Measurement System When Optical Input is Wavelength Multiplexed

The pulse method is used to measure the performance of optical amplifiers for wavelength division multiplexing optical signals. In this system, the light source is pulse modulated and the gain and noise figure of the wavelength are measured.

The MS9740B identifies the pulse-modulated optical signal and detects the wavelength for measuring the optical amplifier performance.

To measure the performance of the optical amplifier when the optical input is wavelength multiplexed

1. Press **f1 Method**.
2. Press **f5 WDM Measure**.
3. Press **f7 More 1/2**.

4. Press **f1 Pin**. Select the traces A to J to store the signal waveform.
5. Press **f2 Pout**. Select the traces A to J to store the optical output waveform.
6. Press **f3 Pase**. Select the traces A to J to store the ASE waveform.
7. Press **f7 More 2/2**.
8. Input the output light of the optical amplifier to MS9740B as shown by the connection in Figure 5.7.6-1 (a).
Input the modulation signal to the Ext Trigger connector on the rear panel.
9. Set VBW to a larger value than the modulation frequency.
10. Set the wavelength, resolution, and level scale.
11. To calibrate the resolution, input single spectrum light into the optical spectrum analyzer.
To achieve this, set the optical output for just one light source to on and the output of the other light sources to off.
12. Press **f5 Res Cal**.
13. Press **f1 Execute**. The message indicating the resolution calibration in progress is displayed.
14. Set the optical output of the light source set to off at step 11 to on.
15. Press **f4 Ext Trigger Delay**.
16. Adjust the delay time to maximize the optical signal level and press **f8 Back**.
17. Press **f3 Write to**.
18. Press **f1 Pin**.
19. Press **Single** or **Repeat**.
The data for the trace specified at step 4 is stored.
20. Press **f3 Write to**.
21. Press **f2 Pout**.
22. Connect as shown by the connection in Figure 5.7.6-1 (b) and input the output light of the optical amplifier to MS9740B.
If necessary, insert an optical bandpass filter between the optical amplifier and MS9740B to remove the ASE.
23. Press **f4 Ext Trigger Delay**.
24. Adjust the delay time to maximize the optical signal level and press **f8 Back**.
25. Press **Single** or **Repeat**.
The optical amplifier optical signal and the ASE optical output data are each stored at the trace specified at steps 5 and 6.
26. Press **f2 Parameter**.

27. Set the following items in the dialog box:
- | | |
|----------------|--|
| NF Select: | Noise figure calculation method |
| Pin Loss: | Calibration factor for the signal level |
| Pout Loss: | Calibration factor for the optical level output |
| NF Cal: | Calibration factor for the noise figure |
| O.BPF Lvl Cal: | Ratio of pass level and filter level of optical bandpass filter inserted between the optical amplifier and MS9740B |
| O.BPF BW: | Optical bandpass filter bandwidth |
- For the input range, refer to Table 5.7.1-1.
28. Press **f7 Set** to update the value in the measurement result display field.

5.7.7 Calculation Method

This section explains the method for calculating the optical amplifier gain and noise figure.

The noise figure calculation method differs according to the NF Select setting.

Gain (dB) Calculation Method

Gain is a comparison of the optical signal level and the amplified signal level. The optical amplifier output optical signal level includes the level of the ASE generated in the optical amplifier. Consequently, the amplified optical signal level is level of the optical output minus the level of the ASE.

$$Gain = 10 \log(G)$$

$$G = \frac{P_{out}(\lambda_s) - P_{ase}}{P_{in}(\lambda_s)}$$

G : Gain

λ_s : Optical signal wavelength (nm)

$P_{in}(\lambda_s)$: Level of optical input to optical amplifier at optical signal wavelength (W)

$P_{out}(\lambda_s)$: Level of optical output to optical amplifier at optical signal wavelength (W)

P_{ase} : Level of ASE output level at optical signal wavelength (W)

NF (dB) Calculation Method

When NF Select is S-ASE

The noise figure is calculated from the beat noise between the optical signal and the ASE optical output.

$$NF = 10 \log\left(k \cdot \frac{P_{ase}}{h \cdot \nu \cdot G \cdot \Delta \nu_s}\right)$$

$$\Delta \nu_s = \left(\frac{1}{\lambda_{sv} - Res_{real}/2} - \frac{1}{\lambda_{sv} + Res_{real}/2} \right) \cdot c \cdot 10^9$$

$$\nu = \frac{c}{\lambda_{sv}} \cdot 10^9$$

k : Correction value set by NF Cal

λ_{sv} : Wavelength of optical signal in vacuum (nm)

$\Delta \nu_s$: Frequency bandwidth of actual resolution at P_{ase} measurement (Hz)

h : Planck's Constant 6.626×10^{-34} (J·s)

ν :	Frequency of optical signal (Hz)
Res_{real} :	Resolution calibrated by Res Cal (nm)
c :	Light Velocity 2.9979×10^8 (m/s)

When NF Select is Total

The noise figure is calculated from the sum of noises due to four noise sources.

$$NF = 10 \log(k(F_1 + F_2 + F_3 + F_4))$$

$$F_1 = \frac{P_{ase}}{h \cdot \nu \cdot G \cdot \Delta \nu_s}$$

$$F_2 = \frac{P_{aset}^2}{2h \cdot \nu \cdot G^2 \cdot Pin(\lambda_s) \cdot \Delta \nu_a}$$

$$F_3 = \frac{1}{G}$$

$$F_4 = \frac{P_{aset}}{G^2 \cdot Pin(\lambda_s)}$$

F_1 : Beat noise between optical signal and ASE optical output

F_2 : Beat noise between ASE optical output

F_3 : Optical signal shot noise

F_4 : ASE optical output shot noise

P_{aset} : ASE optical output total power (W)

$$P_{aset} = P_{ase} \cdot \frac{\Delta \nu_a}{\Delta \nu_s}$$

$$\Delta \nu_a = \left(\frac{1}{\lambda_{sv} - BPFBW/2} - \frac{1}{\lambda_{sv} + BPFBW/2} \right) \cdot c \cdot 10^9$$

BPFBW: Optical bandpass filter bandwidth (nm)

Spectrum Division Calculation Method

The level of the ASE output from the optical amplifier is the sum of the following levels:

- Noise Level generated in optical amplifier
- Noise level for amplified optical signal

The spectrum division method finds the noise level generated in the optical amplifier (spectrum correction value) by subtracting the amplified optical signal level from the optical amplifier output level.

The ASE optical output level P_{ase} is measured from the spectrum correction value, which is calculated using the spectral division method.

The formula for the spectrum correction value $P_{corr}(\lambda)$ is as follows.

The spectrum correction value is calculated after first calculating the provisional gain G_1 .

$$P_{corr}(\lambda) = P_{out}(\lambda) \cdot P_{outloss} - \frac{G_1 \cdot Pin(\lambda) \cdot Pinloss}{BPFLcal}$$

$$G_1 = \frac{P_{out}(\lambda_s) \cdot P_{outloss}}{Pin(\lambda_s) \cdot Pinloss}$$

$P_{corr}(\lambda) = 0$ when $P_{corr}(\lambda) < 0$

$Pin(\lambda)$: Level at optical input wavelength λ (W)

$P_{out}(\lambda)$: Level at optical output wavelength λ (W)

$Pinloss$: Linear value for Pin Loss entry

$P_{outloss}$: Linear value for Pout Loss entry

G_1 : Gain

$BPFLcal$: Linear value set at O.BPF Lvl Cal

Calculation using polarization nulling method

The polarization nulling method removes the optical signal from the optical output using a detector. Consequently, it is not necessary to subtract the optical signal level from the ASE optical output level.

However, correction is required because the ASE optical output level is halved by the detector.

In the polarization nulling method, Pin , P_{out} , and P_{ase} are obtained from the following equation using the gain and noise figure calculation.

$$P_{ase} = 2 \cdot P_{sp-ase} \cdot P_{olloss}$$

$$Pin(\lambda) = P_{sp-in}(\lambda) \cdot Pinloss$$

$$P_{out}(\lambda) = P_{ap-out}(\lambda) \cdot P_{outloss}$$

P_{sp-ase} : ASE level (W) calculated by fitting curve

P_{olloss} : Linear value of value input at Pol Loss

$P_{sp-in}(\lambda)$: Level at optical input wavelength λ (W)

$P_{ap-out}(\lambda)$: Level at optical output wavelength λ (W)

5.8 Measuring Optical Amplifier (Wavelength Division Multiplex)

With the optical amplifier (WDM), the following items are measured simultaneously for the multiple optical signals.

Table 5.8-1 Opt. Amp Multi Measurement Items

Screen Display	Description
Peak Count	Signal count
Gain Slope	Slope when a straight line approximation is performed based on the gain obtained for each optical signal.
Gain Vari	Ratio between the maximum gain and the minimum gain
No	Number of signal (sequential number added from short wavelength)
Wl (nm)	Wavelength of signal
Pin (dBm)	Optical signal level input
Pout (dBm)	Optical signal level output
ASE (dBm)	ASE level for signal
Res (nm)	Actual resolution
Gain (dB)	Gain
NF (dB)	Noise figure

The noise figure and gain are calculated from the power of the optical input to the optical amplifier (Pin), the power of the optical signal output from the optical amplifier (Pout), and the ASE level.

Refer to 5.8.4 “Calculation Method” for details.

Pin, Pout, and ASE are measured from the optical input to the optical amplifier and the spectrum of the optical output of the optical amplifier.

This function has following setting items.

- ISS Method

This selects measurement method.

IEC:

This measurement method conforms to IEC standards.

Advanced:

This measurement method has less error due to optical input ASE noise than IEC or Off.

Off:

This measurement method is equivalent to “5.7.1 Optical Amplifier Measurement Method”, Spect Div Off.

- Channel Parameter

This sets the optical signal level range and the wavelength detection method.

For details, see 5.8.2 “How to Set the Signal Measurement Method”.

- Opt Amp Test Parameter

This sets the Opt Amp Multi measurement’s ASE display, detection method, NF calculation method, and the actual resolution calculation method.

For details, see 5.8.3 “How to Set the Estimated Noise Measurement Method”.

- Write to

This selects the signal to be measured.

Pin:

This measures the optical input.

Pout:

This measures the optical output.

- Display Mode

This selects the measurement results display method.

For details, see 5.8.1 “Optical Amplifier (WDM) Screen Display”.

- Pin

This selects the traces A to J to store the input waveform.

- Pout

This selects the traces A to J to store the output waveform.

5.8.1 Optical Amplifier (WDM) Screen Display

To display the optical amplifier (WDM) measurement functions,

1. When the name of the **F7** horizontal key is not **Application**, press **F8**, and then press **F7**.
2. Press **f7 More 1/2**.
3. Press **f2 Opt.Amp (Multi Channel) Test** to display the measurement result display field.
4. Press **f6 Off** to finish the optical amplifier (WDM) measurement.

The optical amplifier (WDM) measurement has two types of measurement screens.

The displayed measurement results for each screen display are the same.

Trace & Table:

Up to four measurement results for each optical signal are displayed in one screen.

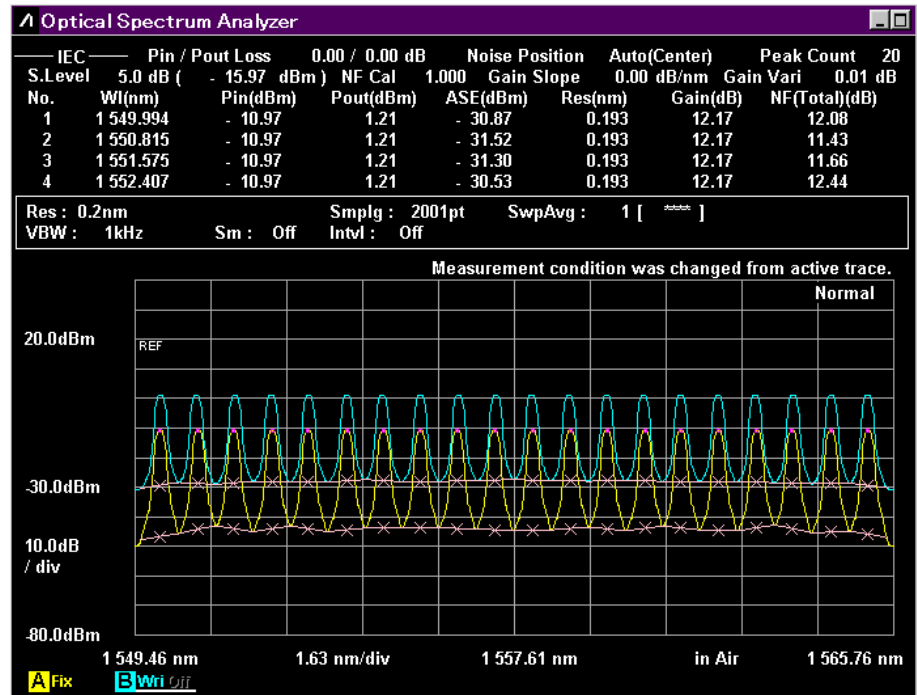

Figure 5.8.1-1 Trace & Table Display Example

Table:

Up to 16 measurement results for each optical signal are displayed in one screen.

Optical Spectrum Analyzer									
IEC		Pin / Pout Loss		0.00 / 0.00 dB		Noise Position	Auto(Center)	Peak Count	20
No.	Wl (nm)	Pin (dBm)	Pout (dBm)	ASE (dBm)	Res (nm)	Gain (dB)	NF(Total) (dB)	S.Level (- 15.97 dBm)	5.0 dB
1	1 549.994	- 10.97	1.21	- 30.87	0.193	12.17	12.08		
2	1 550.815	- 10.97	1.21	- 31.52	0.193	12.17	11.43	NF Cal	1.000
3	1 551.575	- 10.97	1.21	- 31.30	0.193	12.17	11.66	Gain Slope	0.00 dB/nm
4	1 552.407	- 10.97	1.21	- 30.53	0.193	12.17	12.44	Gain Vari	0.01 dB
5	1 553.176	- 10.97	1.21	- 30.80	0.193	12.17	12.18		
6	1 554.008	- 10.97	1.21	- 29.82	0.193	12.17	13.16		
7	1 554.799	- 10.97	1.21	- 30.05	0.193	12.17	12.94		
8	1 555.589	- 10.97	1.21	- 30.65	0.193	12.17	12.35		
9	1 556.379	- 10.97	1.21	- 30.17	0.193	12.17	12.83		
10	1 557.180	- 10.97	1.21	- 29.38	0.193	12.17	13.63		
11	1 558.002	- 10.97	1.21	- 29.32	0.193	12.17	13.69		
12	1 558.813	- 10.97	1.21	- 30.15	0.193	12.17	12.87		
13	1 559.593	- 10.97	1.21	- 30.10	0.193	12.17	12.93		
14	1 560.415	- 10.97	1.21	- 30.26	0.193	12.16	12.78		
15	1 561.184	- 10.97	1.20	- 30.59	0.193	12.16	12.46		
16	1 561.995	- 10.97	1.20	- 30.14	0.193	12.16	12.91		

Measurement condition was changed from active trace.

Res : 0.2nm	Smplg : 2001pt	SwpAvg : 1 [<input type="checkbox"/>]
VBW : 1kHz	Sm : Off	Intvl : Off

Figure 5.8.1-2 Table Display Example

5.8.2 How to Set the Signal Measurement Method

In the Channel Parameter dialog box, set the optical signal level range and the wavelength detection method.

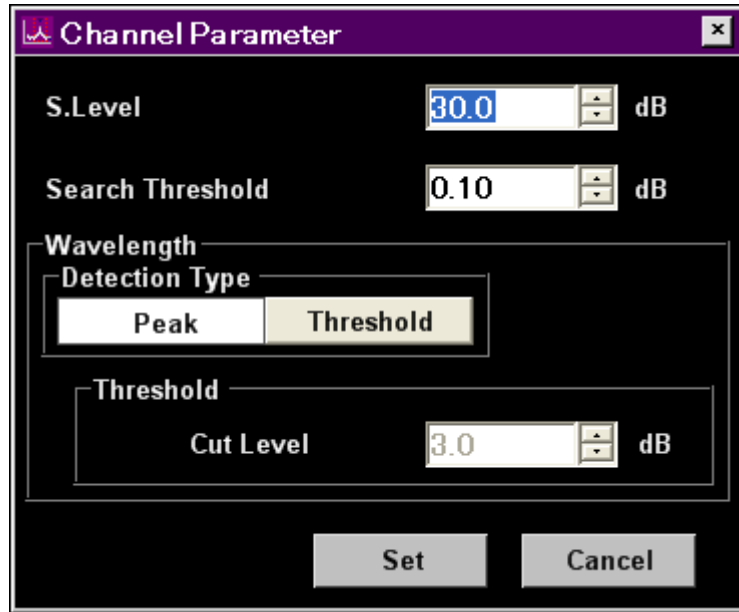

Figure 5.8.2-1 Channel Parameter Dialog Box

Table 5.8.2-1 Setting Range of the Parameters in the Channel Parameter Dialog Box

Item	Min.	Max.	Unit
S.Level	0.1	50.0	dB
Search Threshold	0.01	10.00	dB
Cut Level	0.1	50.0	dB

- S.Level

Level difference (dB) from the maximum level, which sets the level range for detecting the signal.

Peaks with values above the lowest value in the S. Level portion below the maximum peak are detected as the signal. In the following figure, the peaks detected are points b, c, d, and e.

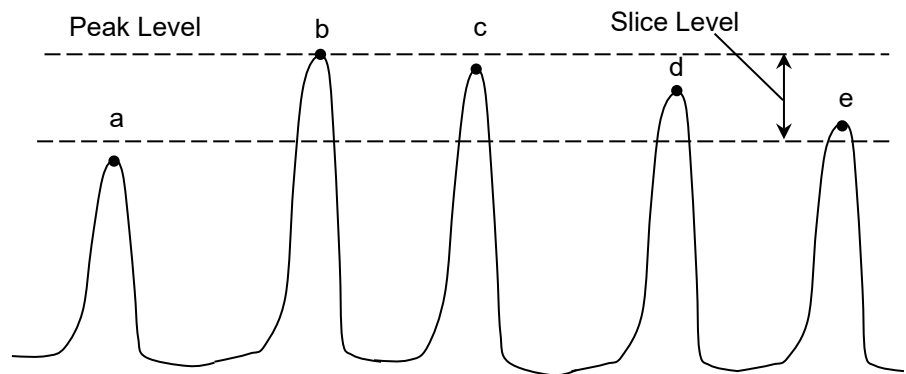

Figure 5.8.2-2 Peaks Targeted for Analysis

Note:

Peak level is the sum of signal level and noise level.

- Search Threshold

This sets the threshold value for detecting the peak for the next highest and subsequent levels after the maximum level peak.

- Wavelength

Detection Type: Signal wavelength detection method

Peak: Wavelength peaks

Threshold: Center wavelength analyzed Threshold

Threshold Cut Level: Detects peak as signal and level range from maximum.

This parameter is enabled when Threshold is selected.

Threshold Cut Level is set in the range of 0.1 to 50.0.

Note:

If no wavelength is detected within the level range specified by Threshold Cut Level, the screen center wavelength becomes the detected wavelength.

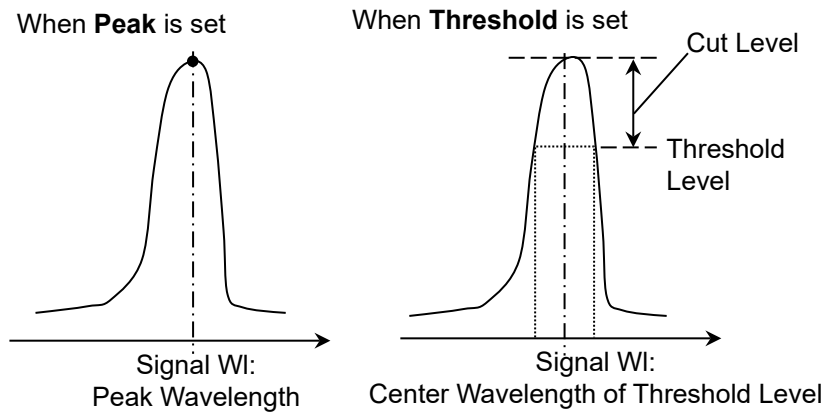

Figure 5.8.2-3 Signal Wavelength Measurement Method

5.8.3 How to Set the Estimated Noise Measurement Method

In the Opt Amp Test Parameter dialog box, set the Opt Amp Multi measurement's fitting curve display, detection method, NF calculation method, and the actual resolution calculation method.

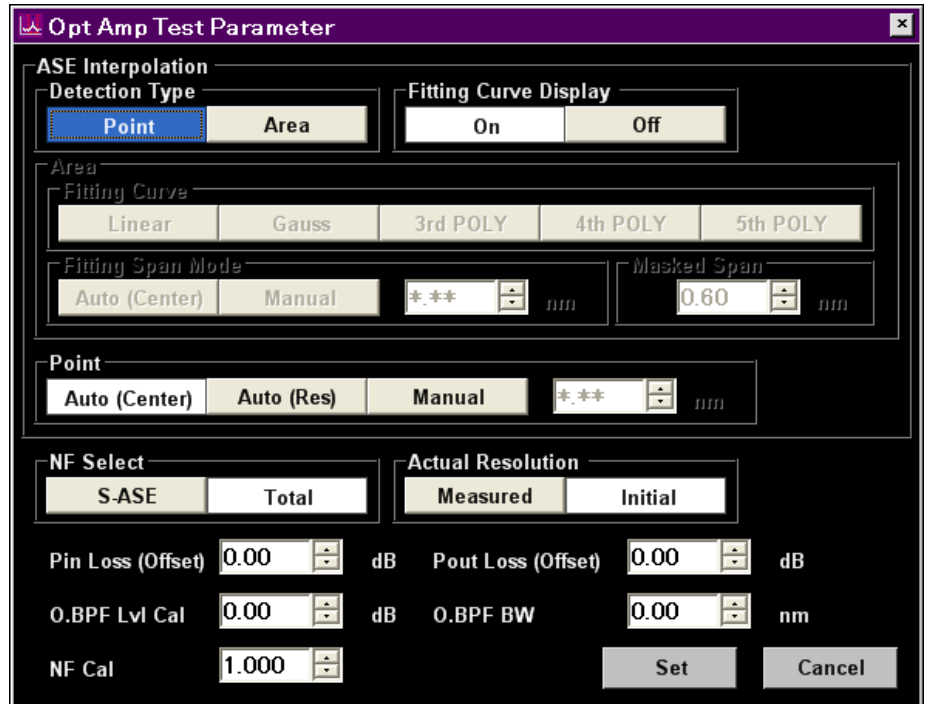

Figure 5.8.3-1 Opt Amp Test Parameter Dialog Box

Table 5.8.3-1 Setting Range of the Parameters in the Opt Amp Test Parameter Dialog Box

Item	Min.	Max.	Unit
Fitting Span (Manual)*1	0.10	100.00	nm
Masked Span*1	0.10	100.00	nm
Point (Manual)*2	0.10	100.00	nm
Pin Loss (Offset)	-10.00	10.00	dB
Pout Loss (Offset)	-10.00	10.00	dB
O.BPF Lvl Cal	0.00	30.00	dB
O.BPF BW	0.00	999.99	nm
NF Cal	0.100	10.000	None

*1: The Fitting Span is set with Signal W1 as a center. The noise location of Fitting Span and Masked Span is Signal W1 ± Fitting Span/2. Note that the calculation method is different from that of Point.

*2: Point is the location using Signal W1 as a reference. The noise location is Signal W1 ± Point. Note that the calculation method is different from that of Fitting Span and Masked Span.

- Detection Type

Area: The noise level is estimated from the value of fitting curve at signal wavelength. The fitting curve is calculated from the noise wavelength in the Area

Point: The noise level is estimated by linear interpolation from the position set for the Point.

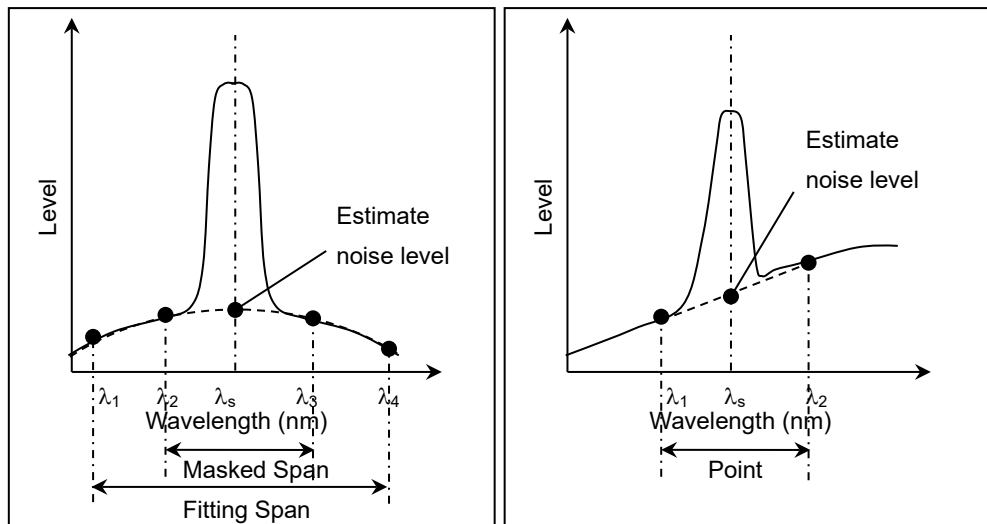

(a) Area

(b) Point

Figure 5.8.3-2 Detection Method for Estimated Noise Level

- Fitting Display
 - Off: The fitting curve is not displayed
 - On: The fitting curve is displayed

- Area:

Set the fitting curve calculation range when Detection Type is Area Fitting Curve:

Selects the type of fitting curve.

 - Linear: Linear equation for noise linear data
 $f(\lambda) = a\lambda + b$
 - Gauss: Binomial equation for noise log data
 $f(\lambda) = a\lambda^2 + b\lambda + c$
 - 3rd POLY: Third-order polynomial equation for noise linear data
 $F(\lambda) = a\lambda^3 + b\lambda^2 + c\lambda + d$
 - 4th POLY: Fourth-order polynomial equation for noise linear data
 $f(\lambda) = a\lambda^4 + b\lambda^3 + c\lambda^2 + d\lambda + e$
 - 5th POLY: Fifth-order polynomial equation for noise linear data
 $f(\lambda) = a\lambda^5 + b\lambda^4 + c\lambda^3 + d\lambda^2 + e\lambda + f$

Fitting Span Mode:

Select the range for calculating the fitting curve.

 - Auto (Center):

Use the halfway point to the neighboring signal as the wavelength range calculated. (See Figure 5.8.3-3)
 - Manual: Use a manually set value as the wavelength range calculated.
 - Masked Span:

Set the wavelength range excluded from fitting curve calculation.

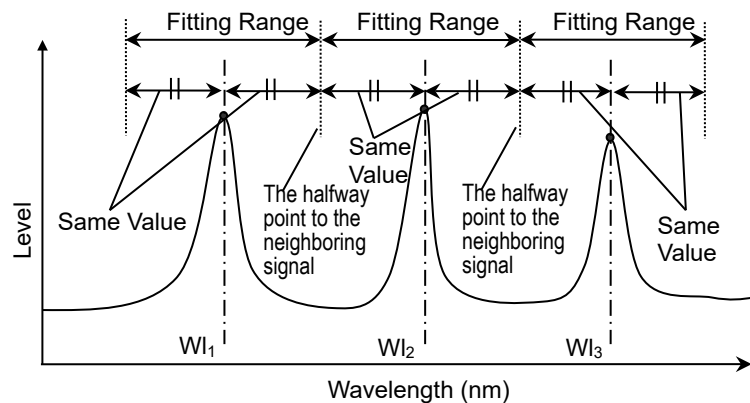

Figure 5.8.3-3 Auto (Center) Fitting Range

5.8 Measuring Optical Amplifier (Wavelength Division Multiplex)

- Point:

Select the noise level detection position when Detection Type is Point Auto (Center):

The halfway point to the neighboring signal is used as the noise level detection position. (See Figure 5.8.3-3) If there is only one signal, then the noise level dependent on Resolution during waveform measurement is used as the detection position. (See Table 5.8.3-2)

Auto (Res): A value dependent on Resolution during waveform measurement is used as the noise level detection position. (See Table 5.8.3-2)

Manual: Use a manually set value as the noise level detection position.

Table 5.8.3-2 Values Dependent on Resolution

Set Resolution (nm)	Noise Point (nm)*
0.03	0.50
0.05	0.53
0.07	0.60
0.1	0.65
0.2	0.8
0.5	1.3
1.0	2.2

*: Distance (not span) from the signal wavelength

- NF Select

This selects the NF calculation method.

S-ASE: The noise figure is calculated from the beat noise between the optical signal and the ASE.

Total: The noise figure is calculated from the sum of the following noise values.

- Beat noise between optical signal and ASE optical output
- Beat noise between ASE optical output
- Optical signal shot noise
- ASE optical output shot noise

- Actual Resolution

This selects the Actual Resolution used in the NF calculation.

Measured: This uses a value calculated from a formula. (See 5.8.4 “Calculation Method”)

Initial: This uses a value set at time of shipment.

- Pin Loss (Offset)
This sets the level difference that is the level of the optical signal input to MS9740B subtracted from the level of the optical signal actually input to the optical amplifier.
This is used when measuring the optical input (Pin).
- Pout Loss (Offset)
This sets the level difference that is the level of the amplified optical signal input to MS9740B subtracted from the level of the amplified optical signal actually output by the optical amplifier.
This is used when measuring the optical output (Pout).
- O.BPF Lvl Cal
This sets the pass and filter levels for the optical bandpass filter inserted between the optical amplifier and MS9740B. Set 0 dB when no filter is inserted or when the characteristics of an optical amplifier with built-in filter are evaluated.

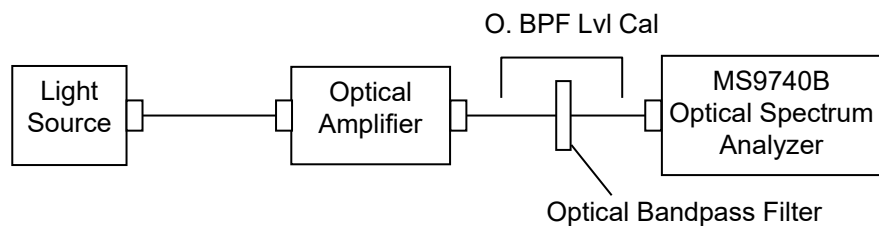

- O.BPF BW
O.BPF.BW sets the ASE bandwidth when NF Select is Total. When determining the noise figure when a narrow optical bandpass filter is installed, set the filter bandwidth. When determining the noise figure when a filter is not inserted, set the ASE bandwidth.
The value set by O.BPF.BW uses items F_2 and F_4 of the NF (Total) equation described in section 5.8.4.
When O.BPF.BW is set to 0 nm, the noise figure does not include beat noise (F_2) between ASE nor the ASE shot noise (F_4).
- NF Cal
This sets the calibration factor used at NF calculation.

5.8.4 Calculation Method

This section explains the method for calculating the optical amplifier gain and noise figure. The noise figure calculation method differs according to the NF Select setting.

ISS Method: IEC calculation method

This performs the following calculation when the IN waveform ($P_{in}(\lambda)$) and OUT waveform ($P_{out}(\lambda)$) are gathered, to calculate the gain and noise figure.

- (1) For the IN waveform
 - (a) The peak is detected in accordance with the peak detection setting (S.Level, Search Threshold), and the peak wavelengths ($W_{i..n}$) and peak levels ($P_{in_{i..n}}$) are obtained.
 - (b) Fitting is applied in accordance with the fitting conditions (Fitting Span, Masked Span, Fitting Curve or Point) for the IN waveform, and the noise level's estimated values ($N_{in_{i..n}}$) are obtained.
- (2) For the OUT waveform
 - (a) The peak levels ($P_{out_{i..n}}$) are obtained at the peak wavelengths ($W_{i..n}$).
 - (b) Fitting is applied in accordance with the fitting conditions (Fitting Span, Masked Span, Fitting Curve or Point) for the OUT waveform, and the noise level's estimated values ($N_{out_{i..n}}$) are obtained.

Gain (G_i) and ASE (P_{ase_i}) are obtained as follows, and the noise figure is calculated with the NF formula.

$$G_i = \frac{P_{out_i} - N_{out_i}}{P_{in_i}}$$

$$P_{ase_i} = N_{out_i} - G_i \cdot N_{in_i}$$

ISS Method: Advanced Calculation Method

The steps up to obtaining the peak levels (P_{in_i} , P_{out_i}) and estimated values for noise levels (N_{in_i} , N_{out_i}) for the IN and OUT waveforms are the same as with IEC.

However the formulas for obtaining gain (G_i) and ASE (P_{ase_i}) are as follows, and the noise figure is calculated with the NF formula.

$$G_i = \frac{P_{out_i} - N_{out_i}}{P_{in_i} - N_{in_i}}$$

$$P_{ase_i} = \frac{P_{in_i} \cdot P_{out_i} - N_{in_i} \cdot P_{out_i}}{P_{in_i} - N_{in_i}}$$

ISS Method: Off Calculation Method

This performs the following calculation when the IN waveform (Pin(λ)) and OUT waveform (Pout(λ)) are gathered, to calculate the gain and noise figure.

(1) For the IN waveform

The peak is detected in accordance with the peak detection setting (S.Level, Search Threshold), and the peak wavelengths (W_{i..n}) and peak levels (Pin_{i..n}) are obtained.

(2) For the OUT waveform

(a) The peak levels (Pout_{i..n}) are obtained at the peak wavelengths (W_{i..n}) obtained in (1).

(b) Fitting is applied in accordance with the fitting conditions (Fitting Span, Masked Span, Fitting Curve or Point) for the OUT waveform, and the ASE values (Pase_{i..n}) are obtained.

Gain (G_i) and ASE (Pase_i) are obtained as follows, and the noise figure is calculated with the NF formula.

$$G_i = \frac{Pout_i - Nout_i}{Pin_i}$$

Pase_i = ASE obtained in (2)

Actual Resolution (Actual Resolution (nm)) calculation method

When the Actual Resolution is Measured

1. Peak levels (P_p; (i=1..N)) are obtained for each signal.
2. Half the range with respect to the neighboring channel is integrated centered on the peak wavelength for each signal. If there is only one signal, the Auto(Res) value (see Table 5.8.3-2) is used. These integration values are used as S_p; (i=1..N).

The integration value is obtained with the following formula.

$$Sp_i = \frac{Span}{Smpl - 1} \sum P_i$$

Span: Span (nm)

Smpl: Sampling point

P_i: ith data level (W) in the integration range

5.8 Measuring Optical Amplifier (Wavelength Division Multiplex)

The actual resolution for each signal is obtained as follows based on the values obtained in 1. and 2.

$$Actual\ Resolution = \frac{Sp_i}{Pp_i}$$

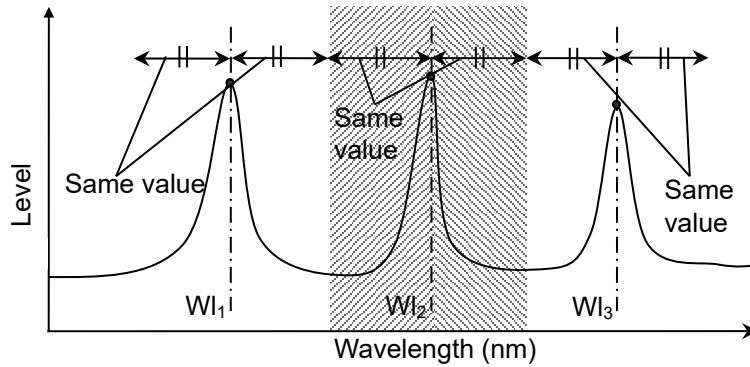

Figure 5.8.4-1 Integration Range for Signals in Multiple Channels

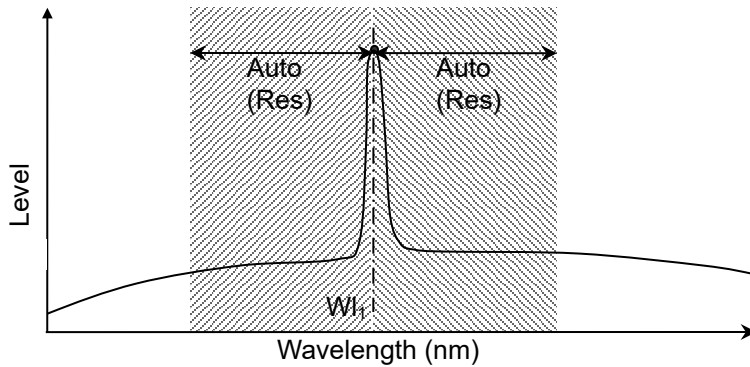

Figure 5.8.4-2 Integration Range for Only One Signal

When the Actual Resolution is Initial
This uses a value set at time of shipment.

Noise figure NF (dB) Calculation Method

When NF Select is S-ASE

The noise figure is calculated from the beat noise between the optical signal and the ASE optical output.

$$NF = 10 \log \left(k \cdot \frac{P_{ase}}{h \cdot \nu \cdot G \cdot \Delta \nu_s} \right)$$

$$\Delta \nu_s = \left(\frac{1}{\lambda_{sv} - Re s_{real}/2} - \frac{1}{\lambda_{sv} + Re s_{real}/2} \right) \cdot c \cdot 10^9$$

$$\nu = \frac{c}{\lambda_{sv}} \cdot 10^9$$

k :	Correction value set by NF Cal
λ_{sv} :	Wavelength of optical signal in vacuum (nm)
$\Delta\nu_s$:	Frequency bandwidth of actual resolution at Pase measurement (Hz)
h :	Planck's Constant 6.626×10^{-34} (J-s)
ν :	Frequency of optical signal (Hz)
Res_{real} :	Actual resolution (nm)
c :	Light velocity 2.9979×10^8 (m/s)

When NF Select is Total

The noise figure is calculated from the sum of noises due to four noise sources.

$$NF = 10 \log(k(F_1 + F_2 + F_3 + F_4))$$

$$F_1 = \frac{Pase}{h \cdot \nu \cdot G \cdot \Delta\nu_s}$$

$$F_2 = \frac{Paset^2}{2h \cdot \nu \cdot G^2 \cdot Pin(\lambda_s) \cdot \Delta\nu_a}$$

$$F_3 = \frac{1}{G}$$

$$F_4 = \frac{Paset}{G^2 \cdot Pin(\lambda_s)}$$

F_1 : Beat noise between optical signal and ASE optical output

F_2 : Beat noise between ASE optical output

F_3 : Optical signal shot noise

F_4 : ASE optical output shot noise

$Paset$: ASE optical output total power (W)

$$Paset = Pase \cdot \frac{\Delta\nu_a}{\Delta\nu_s}$$

$$\Delta\nu_a = \left(\frac{1}{\lambda_{sv} - BPFBW/2} - \frac{1}{\lambda_{sv} + BPFBW/2} \right) \cdot c \cdot 10^9$$

BPFBW: Optical bandpass filter bandwidth (nm)

5.8.5 Procedure

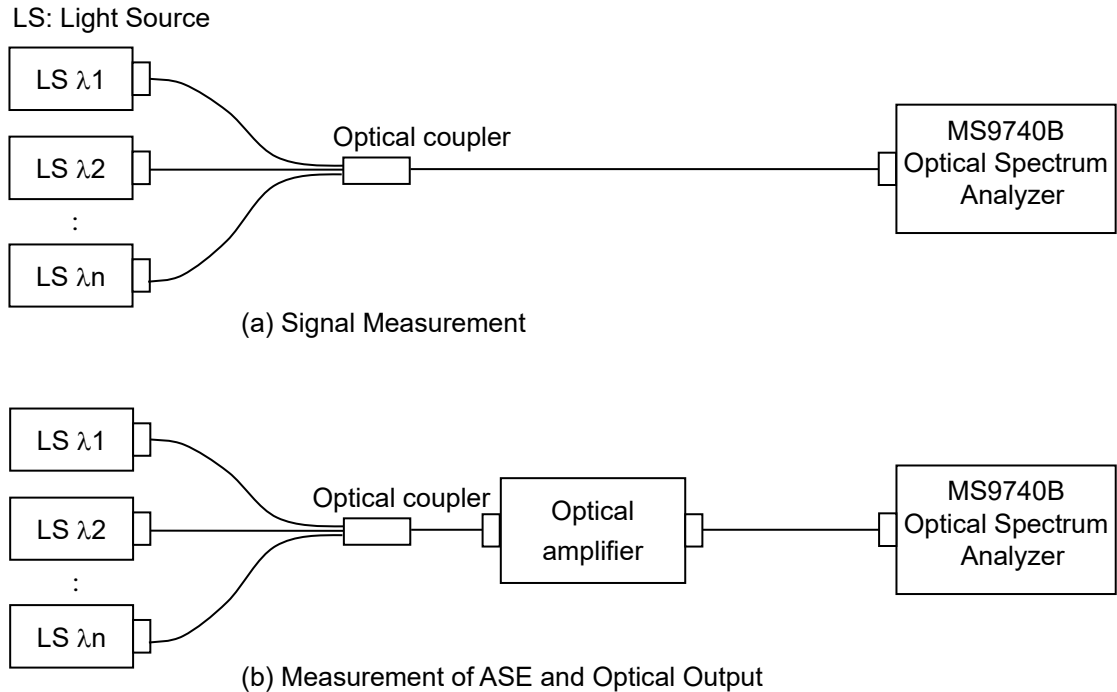

Figure 5.8.5-1 Measurement System When the Optical Input is Wavelength Multiplexed

To measure the Optical Amplifier (WDM)

1. Press **f1 ISS Method**.
2. Press **f1** to **f3** to select an **ISS Method**.
3. Press **f7 More 1/2**.
4. Press **f1 Pin**. Select the traces A to J to store the signal waveform.
5. Press **f2 Pout**. Select the traces A to J to store the optical output waveform.
6. Press **f7 More 2/2**.
7. Input the output light of the optical amplifier to MS9740B as shown by the connection in Figure 5.8.5-1 (a).
8. Set the wavelength, resolution, and level scale.
9. Press **f4 Write to**.
10. Press **f1 Pin**.
11. Press **Single** or **Repeat**.
The data for the trace specified at step 4 is stored.
12. Press **f4 Write to**.
13. Press **f2 Pout**.

14. Input the output light of the optical amplifier to MS9740B as shown by the connection in Figure 5.8.5-1 (b).
15. Press **Single** or **Repeat**.
The data for the trace specified at step 5 is stored.
16. Press **f2 Channel Parameter**.
17. Set the following items in the dialog box:
 - S.Level: Set the level range for detecting the signal.
 - Search Threshold: Set the threshold value for detecting the peak for the next highest and subsequent levels after the maximum level's peak.
 - Wavelength-Detection Type: Set the detection method for the signal wavelength.
 - Wavelength-Threshold Cut Level: Set the level range from the maximum peak for detecting peaks in a signal.
For the setting range, refer to Table 5.8.2-1.
18. Press **f7 Set**.
19. Press **f3 Opt Amp Test Parameter**.
20. Set the following items in the dialog box:
 - Detection Type: Sets Area or Point.
 - Area: When Area is set at Detection Type, sets the fitting curve and measurement area.
 - Point: When Point is set at Detection Type, sets the measurement position.
 - Fitting Curve Display: This sets whether to display or not display the fitting curve.
 - NF Select: This sets the NF calculation method.
 - Actual Resolution: This sets the NF calculation method.
 - Pin Loss(Offset): This sets the calibration factor for signal level.
 - Pout Loss(Offset): This sets the calibration factor for the optical signal output level.
 - O.BPF Lvl Cal: This sets Attenuation from the optical bandpass filter.
 - O.BPF BW: This sets optical bandpass filter bandwidth.
 - NF Cal: This sets the NF calibration factor.

For the input range, refer to Table 5.8.3-1.

5.8 Measuring Optical Amplifier (Wavelength Division Multiplex)

21. Press **f7 Set** to update the value in the measurement result display field.
22. If all of the wavelength data cannot be displayed onscreen, press **f7 More 1/2**, and **f4 Next Page** or **f5 Last Page**.
23. Press **f6 Off** to finish the optical amplifier (WDM) measurement.

5.9 Measuring WDM Filter

The WDM filter is an optical filter that passes light having a wavelength defined in ITU-T. The WDM filter function is used to measure the following items:

- CH Wl (nm): Reference wavelength of signal*1
- Spacing (nm): Wavelength difference between signals
- PK Wl (nm): Peak wavelength of signal
- CH Lvl (dB): Filter loss at the reference wavelength of each signal*2
- CH Lvl (dBm): Signal level at the reference wavelength*3
- x dB BW (nm): Signal bandwidth at a level difference of x dB*4
- PK Lvl (dB): Minimum filter loss in signal*2
- PK Lvl (dBm): Peak signal level*3
- Ripple (dB): Difference between maximum and minimum levels in the specified wavelength range
- n dB Wl (nm): Signal wavelength using n dB Threshold method
- Total Power (dBm): Integrated power of displayed waveform*3
- Peak Count: Signal count

*1: The wavelength detected by the method selected at Channel – Detection Type in Figure 5.9.3-1 is displayed.

*2: This item is measured only when the active trace type is “Calculate”.

*3: This item is measured only when the active trace type is other than “Calculate”.

*4: The bandwidth detected by the method selected at Analysis Type in Figure 5.9.3-1 is displayed.

5.9.1 WDM Filter Transmission Characteristics Measurement Method

A light source with a continuous spectrum, (for example, SLD (Super luminescent diode)), is required to measure the transmission characteristics of the WDM filter. The spectra of both of the light source and the light passed through the WDM filter are measured. The transmission characteristics of the WDM filter are obtained from the difference between measured waveforms.

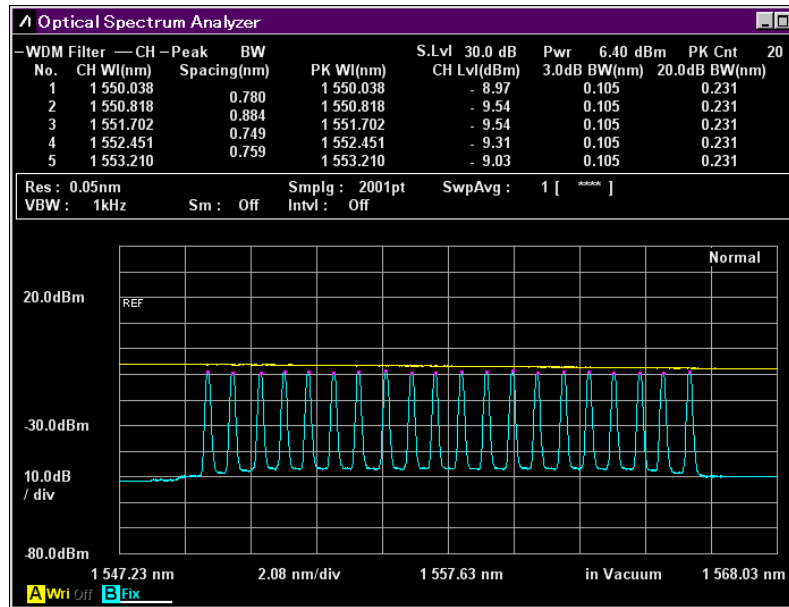

Figure 5.9.1-1 Example Spectra of Light Source and Light Passed Through Filter—1

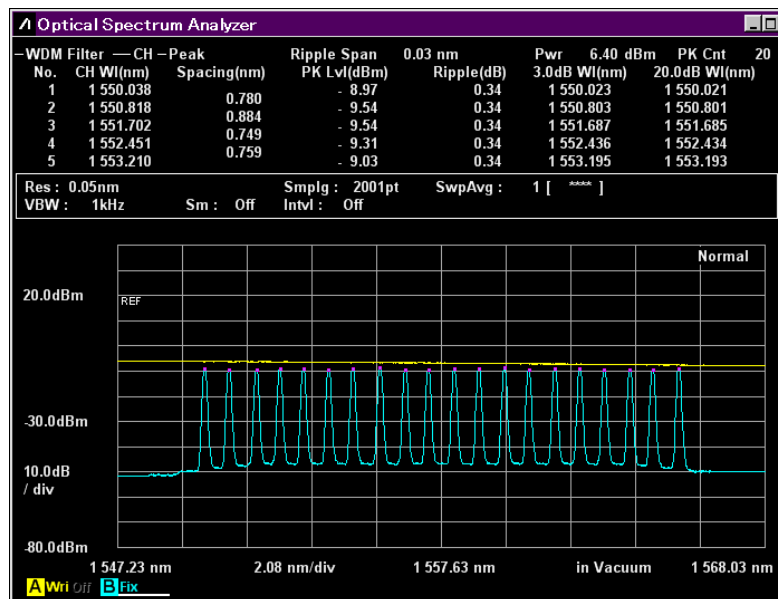

Figure 5.9.1-2 Example Spectra of Light Source and Light Passed Through Filter—2

5.9.2 WDM Filter Screen Display

To display the WDM filter measurement functions,

1. When the name of the **F7** horizontal key is not **Application**, press **F8**, and then press **F7**.
2. Press **f7 More 1/2**.
3. Press **f3 WDM Filter Test** to display the WDM Filter Measurement screen.
4. Press **f1 MEAS Item** to show/hide a graph.
5. Press **f3 CH No. Next Page** or **f4 CH No. Last Page** to switch the filter numbers to be displayed.
6. Press **f5 Display Mode** to show/hide a waveform.
7. Press **f7 Off** to finish the WDM filter measurement.

The WDM filter measurement has two types of measurement screens. The displayed measurement results are the same between the two types.

Trace & Table:

Both waveform and measurement results are displayed in one screen.

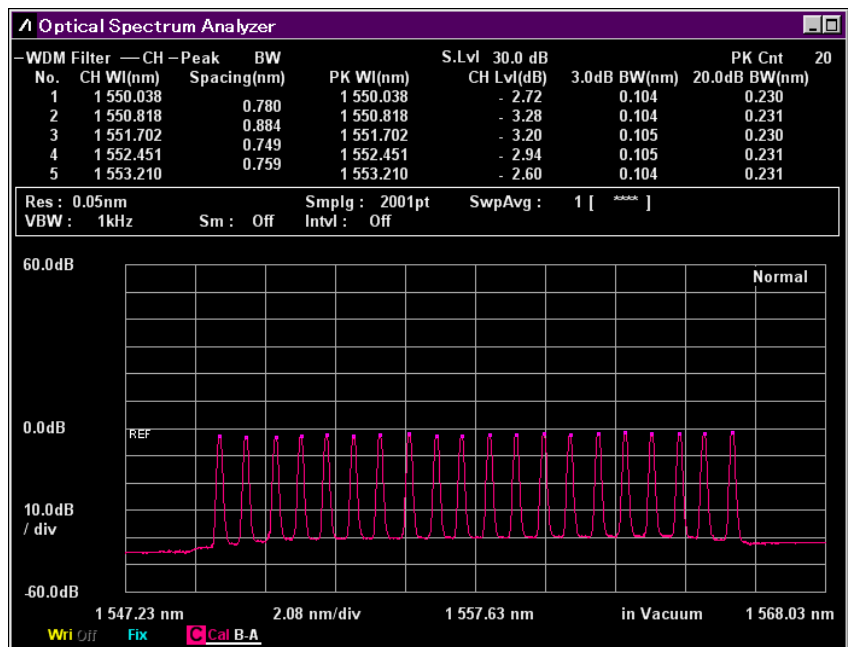

Figure 5.9.2-1 Trace & Table Display Example

Table:

Up to 16 measurement results for each waveform are displayed in one screen.

Optical Spectrum Analyzer							PK Cnt	20
-WDM Filter		—CH—Peak	BW	S.Lvl 30.0 dB				
No.	CH Wl (nm)	Spacing (nm)	PK Wl (nm)	CH Lvl (dB)	3.0dB BW(nm)	20.0dB BW(nm)		
1	1 550.038	0.780	1 550.038	- 2.72	0.104	0.230	Center 1557.63 nm	
2	1 550.818		1 550.818	- 3.28	0.104	0.231	Span 20.80 nm	
3	1 551.702	0.884	1 551.702	- 3.20	0.105	0.230		Start 1547.23 nm
4	1 552.451		1 552.451	- 2.94	0.105	0.231		
5	1 553.210	0.749	1 553.210	- 2.60	0.104	0.231	Stop 1568.03 nm	
6	1 554.021		1 554.021	- 3.09	0.106	0.232		
7	1 554.801	0.780	1 554.801	- 2.64	0.105	0.231		
8	1 555.675		1 555.675	- 2.18	0.104	0.230		
9	1 556.486	0.874	1 556.486	- 2.92	0.105	0.231		
10	1 557.224		1 557.224	- 2.67	0.105	0.231		
11	1 558.056	0.811	1 558.056	- 2.49	0.105	0.232		
12	1 558.847		1 558.847	- 2.41	0.105	0.230		
13	1 559.668	0.738	1 559.668	- 2.00	0.105	0.232		
14	1 560.448		1 560.448	- 2.46	0.105	0.231		
15	1 561.291	0.832	1 561.291	- 1.93	0.103	0.230		
16	1 562.092		1 562.092	- 1.71	0.105	0.230		

Res : 0.05nm	Smplg : 2001pt	SwpAvg : 1 [****]
VBW : 1kHz	Sm : Off	Intvl : Off

Figure 5.9.2-2 Table Display Example

5.9.3 How to Set the WDM Filter Measurement Method

Press **f6 Test Parameter** to display the Test Parameter dialog box. In the Test Parameter dialog box, set the detection method for WDM filter wavelength, and the detection level.

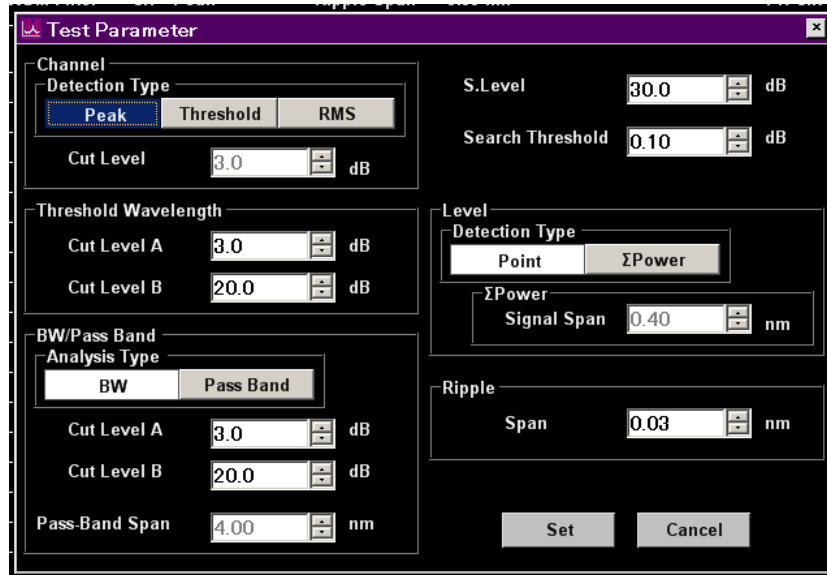

Figure 5.9.3-1 Test Parameter Dialog Box

Table 5.9.3-1 Setting Range of the Parameters in the Test Parameter Dialog Box

Item	Min.	Max.	Unit
S.Level	0.1	50.0	dB
Search Threshold	0.01	10.00	dB
Channel			
Cut Level	0.1	50.0	dB
Threshold Wavelength			
Cut Level A	0.1	50.0	dB
Cut Level B	0.1	50.0	dB
BW/Pass Band			
Cut Level A	0.1	50.0	dB
Cut Level B	0.1	50.0	dB
Pass-Band Span	0.01	999.99	nm
Level			
Signal Span	0.01	50.00	nm
Ripple			
Span	0.01	999.99	nm

- S.Level

Set the range (dB) from the peak for detecting the signal passed through the WDM filter.

Peaks having a level equal to or higher than the level lower than the maximum peak by the amount of the S.Level value are detected as the WDM filter signal. In the following example, peaks b, c, d and e are detected.

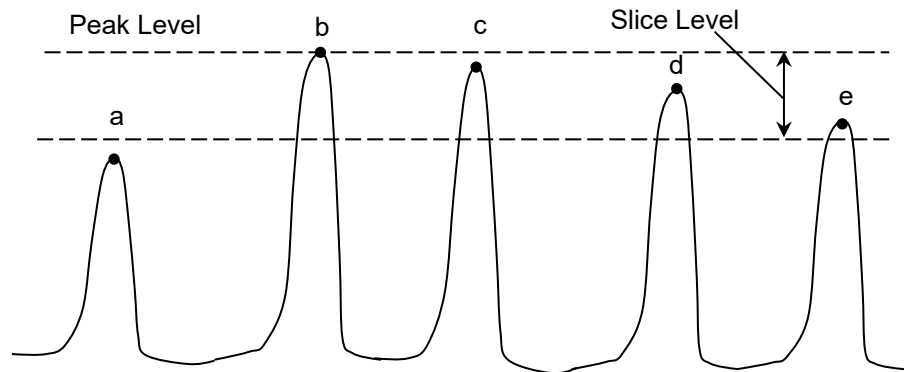

Figure 5.9.3-2 Signal Subject to Analysis

- Search Threshold

Set the threshold value for detecting the peak for the next highest and subsequent levels after the maximum level's peak.

- Channel

Detection Type: Detection method for signal wavelength (CH Wl)

Peak: Wavelength peaks

Threshold: Mean value of the wavelength that is lower than the peak level by the amount of Cut Level

RMS: This is calculated by using the data with a lower level than the peak by the amount of Cut Level, by using the following equation:

$$\lambda_c = \frac{\sum_{i=1}^n \{P(i) \times \lambda_i\}}{\sum_{i=1}^n P(i)} = \frac{P(1)\lambda_1 + P(2)\lambda_2 + \dots + P(n)\lambda_n}{P(1) + P(2) + \dots + P(n)}$$

λ_c : Signal wavelength

$P(i)$: i^{th} data level

$\lambda(i)$: i^{th} wavelength

When **Threshold** or **RMS** is selected, set the Cut Level in the range of 0.1 to 50.0.

Note:

If no wavelength is detected within the level range specified by Cut Level, the screen center wavelength becomes the detected wavelength.

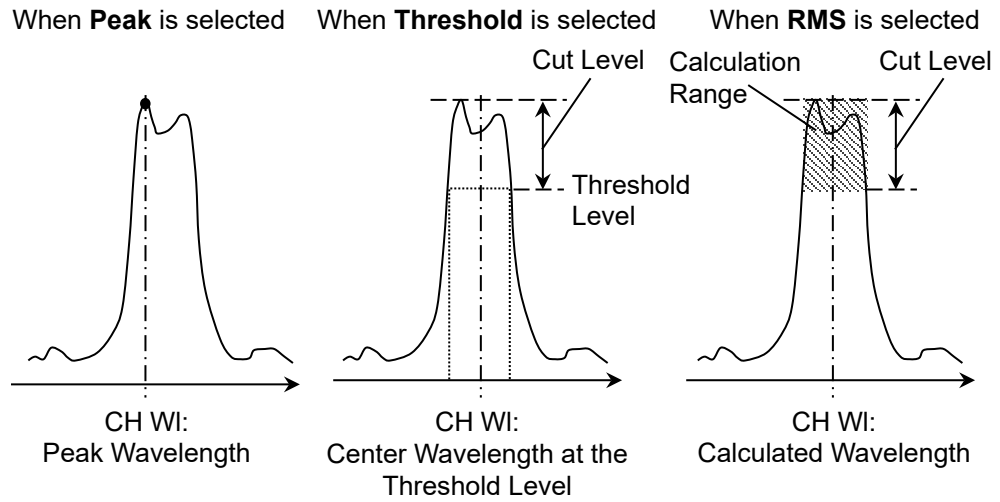

Figure 5.9.3-3 Measurement Method for Signal Wavelength

- **Threshold Wavelength**

Set two threshold levels (**Cut Level A** and **Cut Level B**) for obtaining the signal wavelength (*n* dB WI) by using the *n* dB Threshold method.

- **BW/Pass Band**

Analysis Type:

Analysis method for the bandwidth (*x* dB BW) centered around the signal wavelength

BW:

Spectrum width at the level that is lower than the peak level by the amount of the value specified by **Cut Level A** and **Cut Level B**

Pass Band:

Spectrum width at the level that is lower than the dip point in the Pass-Band Span range centered around the signal wavelength, by the amount of the value specified by **Cut Level A** and **Cut Level B**

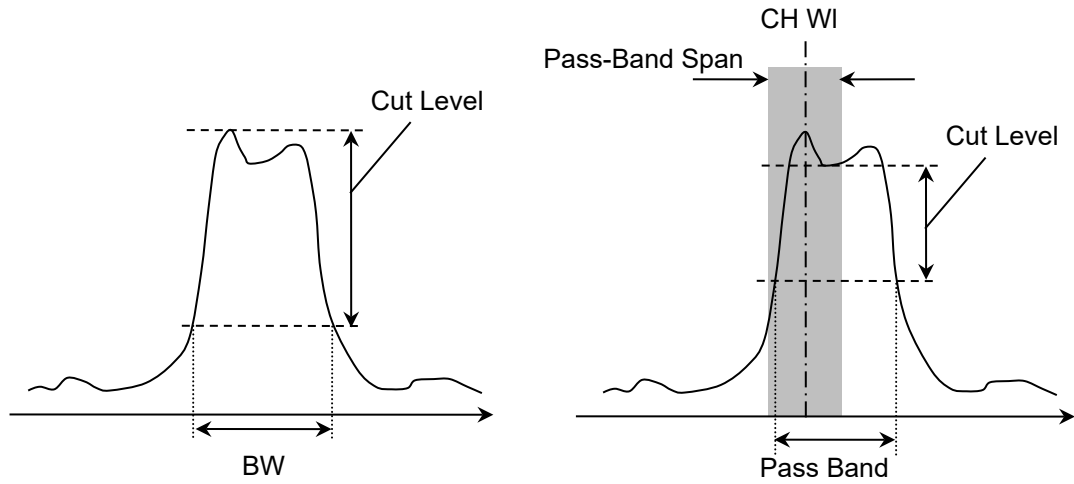

Figure 5.9.3-4 Measurement Method for Bandwidth

- **Level**
Set the level measurement method for signal spectrum. For details, refer to “Level” in 5.5.2, “How to Set the Signal Measurement Method”.
- **Ripple**
The wavelength range for ripple measurement is set to Span. Ripple is a difference between maximum and minimum levels that are in the wavelength range set to Span.

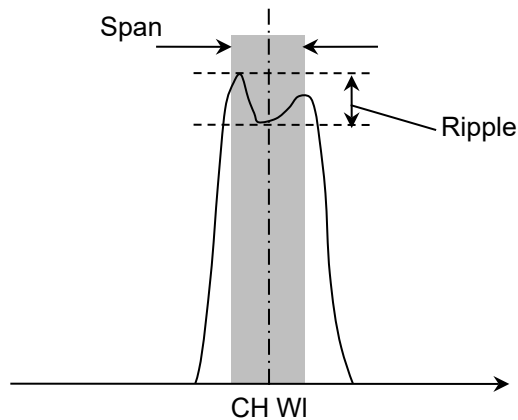

Figure 5.9.3-5 Measurement Method for Ripple

5.9.4 Procedures

In this example, Trace A is used to measure the spectrum of the light source, and Trace B is used to measure the spectrum of the light passed through the WDM filter. The waveform obtained by subtracting Trace A from Trace B is saved as Trace C. The WDM filter analysis is performed on the waveform of Trace C.

When measuring the WDM filter, use a light source having a broadband spectrum and a good level stability.

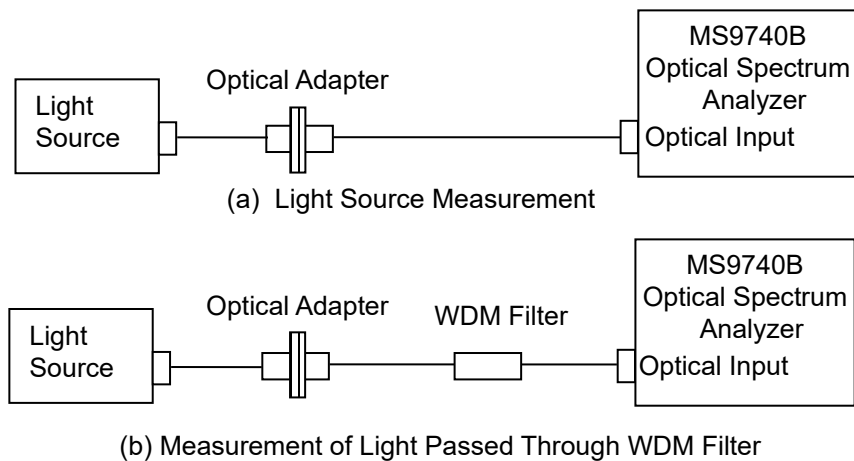

Figure 5.9.4-1 Measuring System for the WDM Filter

To obtain the waveform data of the WDM filter

1. Power on the light source and warm it up until the level stabilizes.
2. Connect two optical fiber cords and an optical adapter, as shown in Figure 5.9.4-1 (a).
3. Press **F6 Trace**, **f1 Active Trace**, and **f1 A**, in this order, and Trace A becomes the active trace.
4. Set the wavelength, resolution, and level scale.
5. Press **Single** or **Repeat**. The data is saved to Trace A.
6. Press **F6 Trace**, **f2 Trace Type** and **f2 Fix**, in this order.
7. Connect the WDM filter as shown in Figure 5.9.4-1 (b).
8. Press **f1 Active Trace** and **f2 B**, in this order, and Trace B becomes the active trace.
9. Press **Single** or **Repeat**. The data is saved to Trace B.
10. Press **f1 Active Trace** and **f3 C**, in this order, and Trace C becomes the active trace.
11. Press **F6 Trace**, **f2 Trace Type**, and **f3 Calculate**, in this order.
12. Press **F6 Trace** and **f4 Calculation**, in this order.

13. Specify the formula for calculating Trace C as follows: Trace B - Trace A. The data of the WDM-filtered waveform is saved to Trace C.

To measure the WDM filter

1. When the name of the **F7** horizontal key is not **Application**, press **F8**, and then press **F7**.
2. Press **f7 More 1/2**.
3. Press **f3 WDM Filter Test** to display the WDM Filter Measurement screen.
4. Press **f6 Test Parameter**.
5. Set the parameters in the dialog box. For the input range, refer to Table 5.9.3-1.
6. Press **f7 Set** to update the values in the WDM Filter Measurement screen.
7. Press **f1 MEAS Item**, **f3 CH No. Next Page**, **f4 CH No. Last Page** or **f5 Display Mode** to change the display range.
8. Press **f6 Off** to finish the WDM filter measurement.

Chapter 6 Setting Operating Environment

This chapter explains the methods for setting and checking the instrument data as well as managing files and updating software.

6.1	Setting and Checking Instrument Data	6-2
6.1.1	Setting Interfaces and File Operating Environment.....	6-2
6.1.2	Checking Instrument Data.....	6-7
6.1.3	Resetting System Data.....	6-8
6.2	Managing Files	6-9
6.3	Updating Software	6-11

6.1 Setting and Checking Instrument Data

6.1.1 Setting Interfaces and File Operating Environment

The following operations and information can be checked.

- Remote control interfaces
- Saving screen files
- Operation sounds

To set or check these data, press **F8** to display Config to the horizontal function key, and then press **F6**.

To set and confirm interface for remote control

1. Press **f1 Interface Settings**.
2. The dialog box shown in Figure 6.1.1-1 is displayed.
Move between setting items using the arrow keys and select the setting.

GPIB Settings:

This is displayed when the GPIB option is added.

The MS9740B GPIB address can set in the range of 1 to 30 using a rotary knob.

Ethernet Settings:

IP Address: Displays MS9740B IP address

Subnet Mask: Displays sub-net mask

Host Name: Displays computer name of MS9740B

The value displayed in Ethernet Settings cannot be changed at this screen.

These values are changed from the Windows Control Panel.

Note:

If MS9740B is not linked up to the network (LAN), its IP address is not displayed.

Terminator Settings:

This character string is handled as the terminator of the communication data.

CR/LF: ASCII code carriage return and line feed

LF: ASCII code line feed

None (EOI Only): Does not use terminator. The data end is detected using the GPIB signal line EOI (End Or Identify).

- Press **f7 Set** to change the GPIB address and communication data terminator to the values set at step 2.

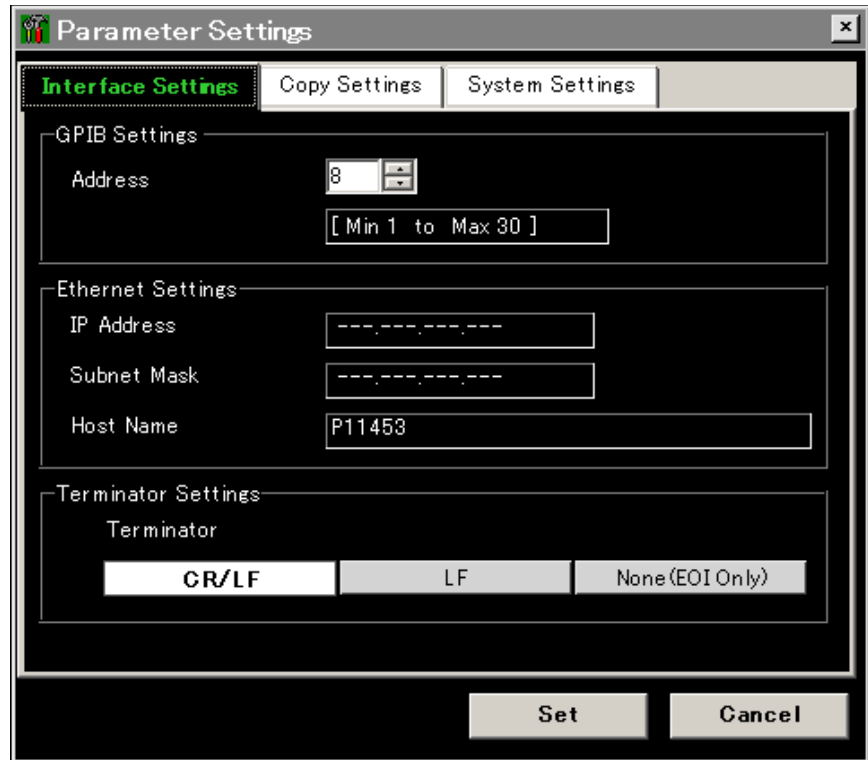

Figure 6.1.1-1 Interface Settings Dialog Box

To set and check the method for saving the display file saved by the **Copy** key:

1. Press **f2 Copy Settings**.

The dialog box shown in Figure 6.1.1-2 is displayed.

Move between setting items using the arrow keys and select the setting.

File Type Settings:

This sets the extension of the display file.

BMP: Saves as bitmap file that can be read by most graphics editing software

PNG: Saves as Portable Network Graphic file, which has a smaller file size than a bmp file.

Color Settings:

This sets the screen color to be saved.

Normal: Saves as screen display image color.

Reverse: Saves as reverse-displays image

File Name Settings:

This sets the method for naming the file each time the Copy key is pressed.

Data + sequential number (000-999):

Appends sequential number in range 000 to 999 to

Data string

User-Specified Name:

Displays file name input dialog box and input file name

2. Press **f7 Set** to change the display file save method to the value set at step 1.

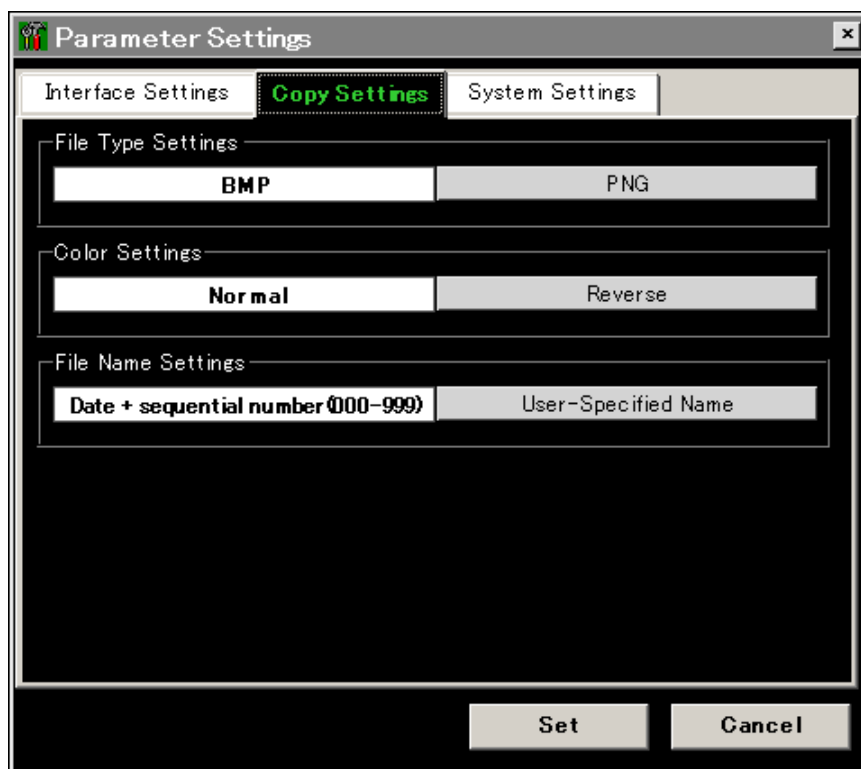

Figure 6.1.1-2 Copy Setting Dialog Box

To set and check the operation sounds:

1. Press **f3 System Settings**.

The dialog box shown in Figure 6.1.1-3 is displayed.

Beep Sound Settings:

This sets the operation sounds on and off using arrow keys.

On: Operation sound at message display

Off: No operation sound at message display

2. Press **f7 Set** to change the operation sounds.

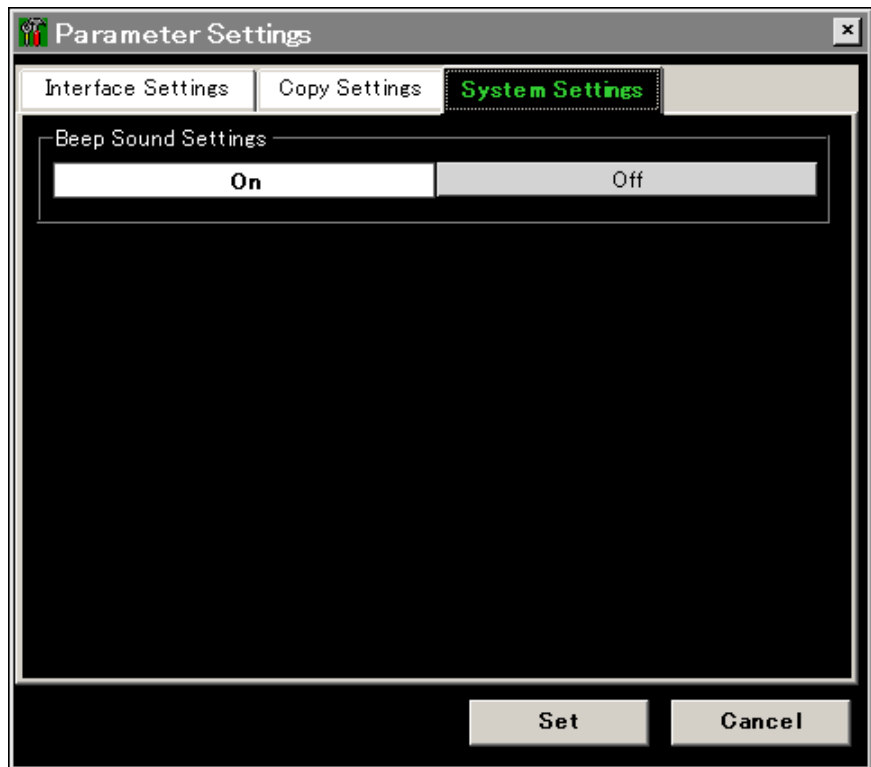

Figure 6.1.1-3 System Settings Dialog Box

6.1.2 Checking Instrument Data

The following information can be checked.

- Serial number
- Software version
- Optical unit version
- Package version
- Software license
- Option

To confirm this information, press **F8** to display Config to the horizontal function key, and then press **F6**.

To display serial number, software version, package version and optical unit version

1. Press **f5 System Info**.
2. Press **f1 System Info View**. The following values are displayed on the screen.

Serial Number

Package Version

Software Version

Optical Unit Version

3. Press **f8 Close** to close the screen.

To display software license

1. Press **f5 System Info**.
2. Press **f4 Software License View**. The license name is displayed on the screen.
3. Press **f8 Close** to close the screen.

To display option information

1. Press **f6 Option Info**. The following values are displayed on the screen.
Option Number
Option Switch
Option Name
2. Press **f8 Close** to close the screen.

To save product information file

The option information and software version can be saved in the file. This saved file calls “system information file”.

1. Press **F8** to display Config on the horizontal function key.
2. Press **F6**.
3. Press **f5 System Info**.
4. Press **f7 More 1/2**.
5. Press **f6 System Information Save**, and then the system information file is saved.

The system information file is required when contacting our sales representatives.

6.1.3 Resetting System Data

The following settings can be changed to the defaults listed in Appendix B. During the changing process, the user data saved to the internal hard disk is deleted. This processing is called Resetting System Settings.

- Setting values for Information Settings
- Setting values for Copy Settings
- Setting values for System Settings

 **CAUTION**

User data deleted at system reset cannot be recovered. Before resetting the system settings, always save the user data to another external drive.

1. Press **f5 System Info**.
2. Press **f7 More 1/2** to display System Reset.
3. Press **f1 System Reset** to display the dialog on the screen.
4. A system reset is executed by selecting **Reset** with the arrow keys and pressing **Enter**.
Select **Cancel** and press **Enter** to cancel System Reset.
5. The MS9740B shuts down after resetting the system.
6. Turn on the power again to continue measurement.

6.2 Managing Files

The following operations can be performed on measurement result files and system data files.

- Copy
- Move
- Delete
- Setting and releasing write protection

To display file operation screen, press **F8** and display Config on the horizontal function keys. And then, press **F6** and **f7 File Operation**, respectively.

To operate file

1. Select the drive to operate the file.
 - (a) Press **f1 Device** to display the dialog box.
 - (b) Select the drive in the dialog box using arrow keys, and press **f7 Set**.
2. Select the file type to be operated.
 - (a) Press **f3 Image** to select the image file.
 - (b) Press **f4 XML** to select the XML file.
 - (c) Press **f5 CSV** to select the CSV file.
 - (d) Press **f7 System Info** to select the system information file.
3. Select the file.
 - (a) If the file name is displayed in the dialog box, move the cursor to the file with the arrow keys.
 - (b) Press **Enter** to check the check box.

The message is displayed when the file does not exist in the drive.

To select or release all displayed files, press **f3 Select All**.

4. Select the operation for the file.
 - (a) Press **f4 File Protect** to protect writing the file.
A message is displayed to confirm the file save change. Select **Change** with the arrow keys and press the **Enter** key to change the file protect settings
 - (b) To move a file on drive D, press **f5 Move to USB**.
A message is displayed to confirm the file move and destination device name.
Select **Move** with the arrow keys and press the **Enter** key to move the file to the moved device destination.

6.3 Updating Software

Software can be updated using the following procedures.

- Prepare a USB memory stick for the installation.
- Update the software.
- Update the software license.

Notes:

- Do not remove the USB memory while installing the software. When the software is updated, the wavelength calibration data resets to the default value.
- Do not install the MS9740A software. If you have installed the MS9740A software by mistake, restore the hard disk drive referring to 2.10.3 “Restoring Hard Disk Drive”. Then install the MS9740B software.

To prepare USB memory for installation

1. Download this software from the Anritsu website.
(<https://www.anritsu.com/en-US/test-measurement/support/downloads>)
2. Extract the downloaded file.
3. Copy the extracted file to the USB memory. If the USB memory stick is drive E:, the file is copied to the following folder
"E:\Anritsu Corporation\Optical Spectrum Analyzer\Install"

The installation instructions are included in the extracted file. For detailed information, refer to the installation instructions.

To display updating software screen

1. Press **F8** to display Config on the horizontal function keys, and press **F6**.
2. Press **f8 More 1/2**.
3. Press **f1 Software Install**.

To update software

1. Connect the USB memory for installation to the MS9740B.
2. The updating software window is displayed.
3. Press **f1 Software Install** to open the drive selection screen.
4. Select the USB memory drive using the arrow keys, and press **f7 Set**.
5. The install confirmation dialog opens.

The software to be installed is displayed on the upper field and the installed software is displayed on the lower field. If the installed software is not displayed on the screen, press **f3 Focus Change** to select the lower field and scroll the screen using the arrow keys.

6. Press **f1 Install**.
7. When “Do you install an application software?” is displayed, select **Yes** using the arrow keys or rotary knob, and then press **Enter**. If you want to stop installing the software, select **No** and press **Enter**.
8. When the software installation is complete, the power is turned off automatically.
9. Turn on the power again.
10. Check the version changed.

For how to confirm the version, refer to 6.1.2 “Checking Instrument Data”.

The measurement conditions and calibration value are initialized when the software is updated. Files saved to drive D: are not erased or changed by updating software.

To update software license

1. Connect the USB memory for installation to MS9740B.
2. The updating software window is displayed.
3. Press **f3 Software License Install** to open the drive selection window.
4. Select the USB memory drive using the arrow keys, and then press **f7 Set**.
5. When the file name is displayed in the dialog box, move the cursor using the arrow keys. Press **f2 Select All** to select all files displayed.
6. When the confirmation dialog box for the installation is opened, press **f1 Install**.
7. Restart Windows after finishing the installation to validate the license.

Note:

1. When the software version saved in the USB memory for installation is the same as the currently installed software version, pressing **F1 Install** displays the password inputting window.

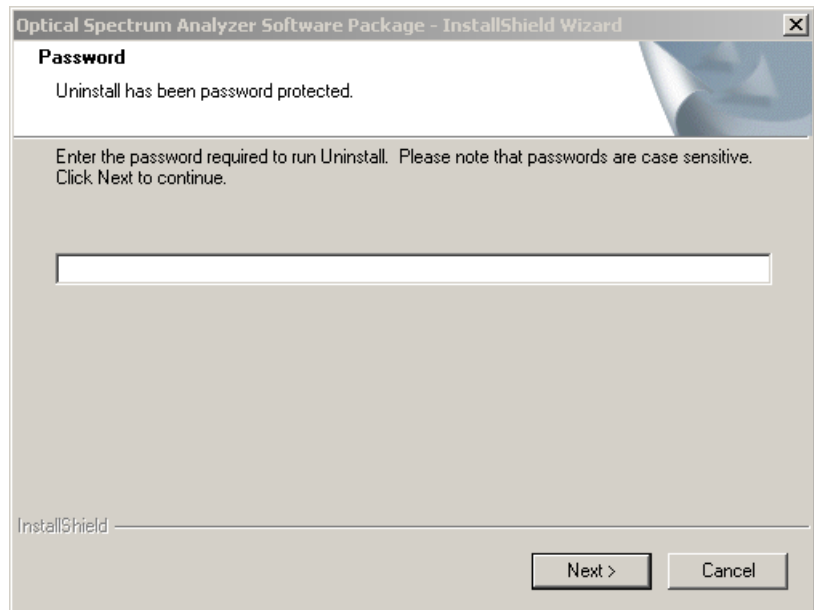

2. When installation is continued, enter “ms9740a_osa” using the key board. Select **Next** using the key board or mouse and press **Enter**.
When terminating installation, select **Cancel** and press **Enter**.
3. The confirmation window for software uninstallation is displayed. Select **Yes** and press **Enter**.

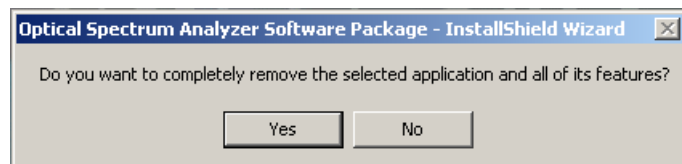

4. The message is displayed after uninstallation is completed. Select **Finish** and press **Enter**.

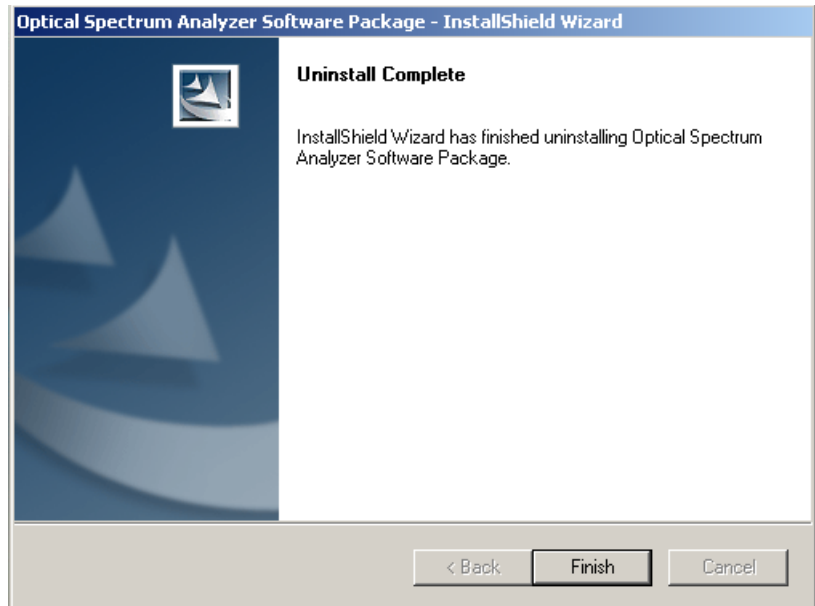

5. Display the USB memory folder (E:\Anritsu Corporation\Optical Spectrum Analyzer\Install).
6. Double-clicking Setup.exe starts installation.
7. After installation is complete, the power is turned off automatically.
8. Turn on the power again.

Chapter 7 Performance Test and Maintenance

This chapter describes calibration, performance tests, and maintenance procedures.

7.1	Calibration	7-2
7.2	Performance Test	7-3
	7.2.1 Wavelength Accuracy.....	7-5
	7.2.2 Level Accuracy.....	7-6
	7.2.3 Dynamic Range	7-7
7.3	Replacement of Optical Connector.....	7-8
7.4	Optical Connector/Optical Adapter Cleaning.....	7-10
7.5	Daily Maintenance	7-14
7.6	Cautions on Storage MS9740B for Extended Period .	7-15
7.7	Transporting and Disposal	7-16
7.8	Troubleshooting	7-17

7.1 Calibration

There are two calibration systems.

- Calibration before use

Refer to 3.1 “Calibrating Before Measurement”.

- Calibration of equipment performance

Use an instrument with guaranteed optical wavelength and level to assure that the MS9740B meets the performance specification. Even though the MS9740B is operating normally, calibrate periodically at regular intervals to maintain the performance specification. The following two items should be calibrated by the user:

- Wavelength accuracy
- Level accuracy

The MS9740B requires calibration of performance once or twice a year. Contact Anritsu Customer Service for periodic calibration of performance.

7.2 Performance Test

The following items are tested to confirm the performance of MS9740B.

- Wavelength Accuracy (Refer to 7.2.1)
- Level Accuracy (Refer to 7.2.2)
- Dynamic Range (Refer to 7.2.3)

Clean all optical connectors before testing performance.

Warm MS9740B up for at least two hours, and then calibrate it, before running performance tests. For details on the calibration, refer to 3.1 “Calibrating Before Measurement”. The Repeat sweeping should be performed at Span 100 nm or more and VBW 10 kHz or more during the warm-up operation.

After turning on measuring instruments to be used for the performance tests, wait for a while until they satisfy their performances.

Run the performance tests within the operating temperatures for MS9740B and the measuring instruments to be used.

For the specifications of wavelength and level accuracy, refer to Appendix A “Specifications”. Furthermore, to record the test result, use Appendix F “Performance Test Result Form”.

Table 7.2-1 Measurement Instrument List for Performance Test

Test Item	Measurement Instrument	Required Performance	Recommended Model (Model Name)
Wavelength accuracy	Wavelength tunable laser source	Wavelength range: 1520 to 1620 nm Setting resolution: 1 pm Wavelength stability: ± 1 pm	8164B+81606A (Keysight Technologies)
	Wavelength meter	Wavelength range: 1250 to 1650 nm Wavelength accuracy: ± 0.5 ppm	671BNIR (Bristol Instruments)
	Single mode Optical fiber coupler	Wavelength range: 1520 to 1620 nm Branch ratio: 50:50 Fiber: SM fiber	
Level accuracy	Light source	Light emitting device: DFB-LD wavelength: 1310 \pm 10 nm Level: -3 dBm or more Level stability: 0.05 dB or more	S3FC1310 (Thorlabs)
	Wavelength tunable laser source	Level: -3 dBm or more Level stability: 0.05 dB or more	8164B+81606A (Keysight Technologies)
	Optical power meter	Wavelength range: 1250 to 1600 nm Level range: ± 10 to -60 dBm Level linearity: ± 0.015 dB Level accuracy: $\pm 4.5\%$	8163B + 81634B (Keysight Technologies)
	Optical attenuator	Wavelength range: 1200 to 1700 nm Input loss: 5 dB or less Maximum attenuation: 60 dB	8163B + 81570A (Keysight Technologies)
	Optical fiber	Single mode fiber (ITU-T G652) /Master FC connector	
Dynamic range	Wavelength tunable laser source	Wavelength range: 1520 to 1620 nm Setting resolution: 1 pm SMSR: ≥ 60 dB Rate between signal and ASE ≥ 70 dB/nm	8164B+81606A (Keysight Technologies)
	Wavelength filter	3 dB bandwidth: 0.5 nm 20 dB bandwidth: 1.6 nm	
	Optical fiber	Single mode fiber (ITU-T G.652)	

7.2.1 Wavelength Accuracy

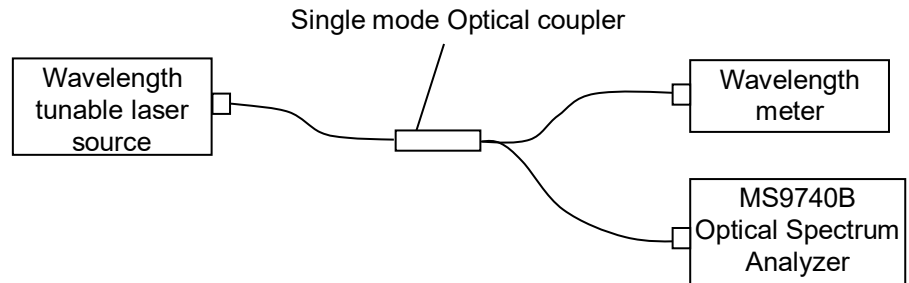

Figure 7.2.1-1 Wavelength Accuracy Test Setup

Be sure to perform the optical axis automatic adjustment and wavelength calibration. Follow the test procedures below.

1. Setup and connect as shown in Figure 7.2.1-1.
2. Set the output of the tunable laser source to CW.
3. Set the wavelength of the tunable laser source to 1550.00 nm.
4. Measure the wavelength with a wavelength meter and record it.
5. Set the following values to the MS9740B, and press **Single**.
Center 1550 nm, Span 1 nm, Res 0.05 nm Sampling Points 1001
6. Press **Peak Search**. Record the peak wavelength.
7. Repeat steps (3) thru (6) for the following wavelengths. Set the following wavelengths for Center in step 5.
1520.00 nm, 1530.00 nm, 1540.00 nm, 1560.00 nm, 1570.00 nm,
1580.00 nm, 1590.00 nm, 1600.00 nm, 1610.00 nm, 1620.00 nm
8. Calculate the difference between the values measured at step 4 and step 6.
9. Check that the value calculated in step 8 satisfies the following specifications for wavelength accuracy.

7.2.2 Level Accuracy

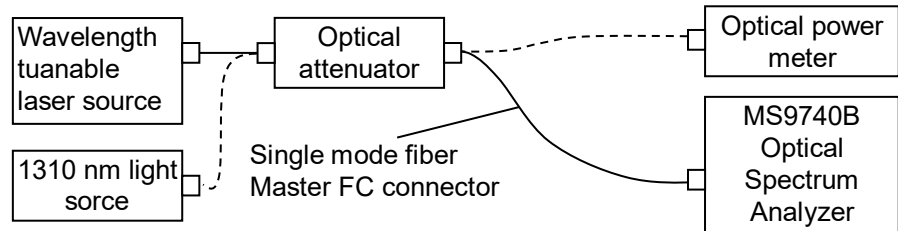

Figure 7.2.2-1 Level Accuracy Test Setup

Test using the following procedures.

1. Connect the MS9740B and the wavelength tunable laser source as shown in Figure 7.2.2-1.
2. Set the wavelength of the light source and optical power meter to 1550 nm.
3. Set the output of the light source to CW and On.
4. Connect the output of the optical attenuator to the optical power meter.
5. Adjust the attenuation of the optical attenuator to display -10 ± 0.1 dBm at the optical power meter display. Record the display value.
6. Connect the output of the optical attenuator to the main frame.
7. Set the following values to the MS9740B, and press **Single**.
Center 1550 nm, Span 0.3 nm, Res 0.1 nm, VBW 100 Hz, Sampling Points 501
8. Press **Peak Search**. Record the wavelength and level.
9. Connect to the 1310 nm light source and set the wavelength of the optical power meter to 1310 nm.
10. Repeat steps 3 thru 8 for the following wavelengths. Set to wavelength of 1310 nm light source for Center in step 7.
11. Calculate the difference between the values measured at step 5 and step 8.
12. Check that the value calculated in step 11 satisfies the following specifications for level accuracy.

7.2.3 Dynamic Range

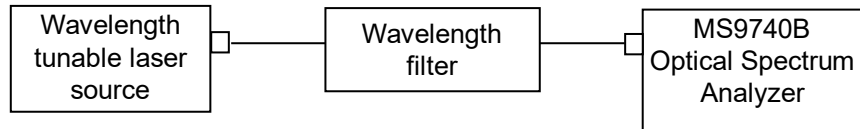

Figure 7.2.3-1 Dynamic Range Performance Test Setup

Perform the test as follows:

1. Connect the test equipment to the MS9740B as shown in Figure 7.2.3-1.
2. Adjust the wavelength tunable laser source to 1550 nm.
3. Set the output of the wavelength tunable laser source to On.
4. Set the following values to the MS9740B and press **Single**.
Res 0.05 nm, VBW100 Hz, Span 2.5 nm, Sampling Points 2001
5. Press **Peak Search**.
6. Press **Marker Select**.
7. Press **f6 ΔMkr**. Display the Δ markers and move the markers to the positions for measuring the wavelength difference.
8. Record the level of the Δ markers.
9. Switch to the high dynamic range mode and repeat steps 1 to 8.
10. Evaluate whether the measurement results satisfy the specifications.

7.3 Replacement of Optical Connector

The standard optical connector is the FC type. The optical connector of the plug-in unit and pull-out type optical sensor can be removed and replaced with another connector (sold separately), and its interior can be cleaned. For more information about the connector type, refer to Figure 7.3-1 Connector Type.

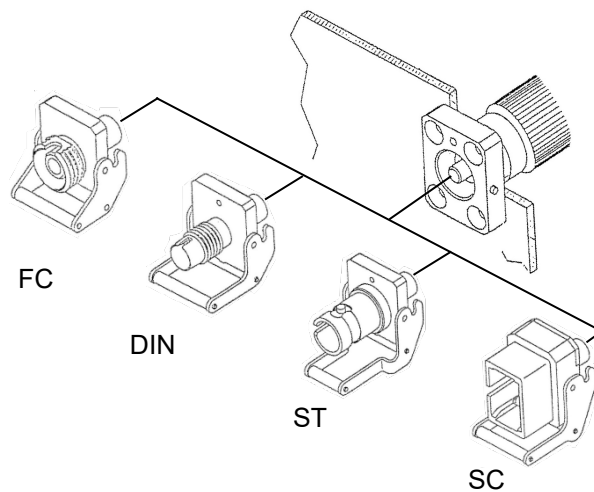

Figure 7.3-1 Connector Type

⚠ WARNING

Do not look into the connection surface of the optical fiber cable of the light source optical connector or the end face of the optical fiber cable connected to the light source as invisible laser light output may cause visual deficits and other problems.

⚠ CAUTION

Before replacing the optical fiber cable, be sure not to damage the connector and connection surface with connector.

To remove the optical connector:

1. Open the cover.
2. Pull up the connector lever toward you.
3. Check that the latch has been released, and then gently pull the connector out straight toward you.

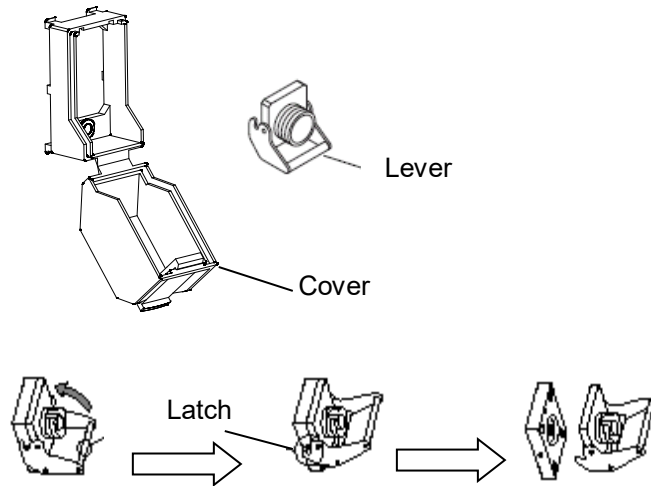

Figure 7.3-2 How to Remove the Optical Connector

7.4 Optical Connector/Optical Adapter Cleaning

Cleaning the Ferrule End Surface

Use an approved adapter cleaner to clean the ferrule end surface in the optical connector. The ferrule in the optical connectors needs periodic cleaning. Although the following procedures use the FC connector and adapter as an example, use the same methods when cleaning other connector and adapter types.

1. Remove the currently connected adapter by raising the adapter lever (you will hear a “click” when the latch disengages) and then gently pull the adapter straight towards you.

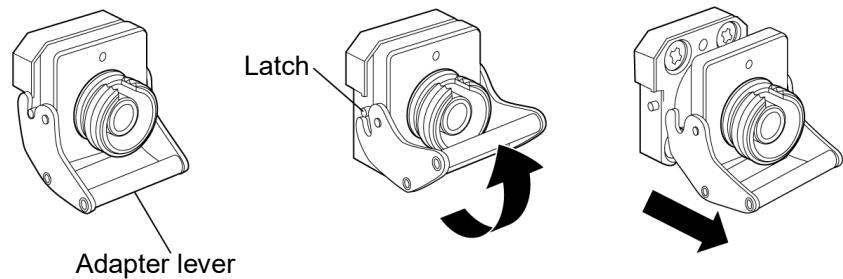

Figure 7.4-1 Cleaning the Ferrule End Surface 1

2. Moisten an adapter cleaner with isopropyl alcohol and then use it to clean the end surface and sides of the ferrule.

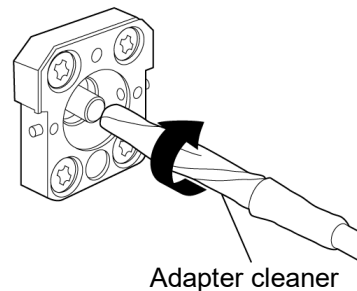

Figure 7.4-2 Cleaning the Ferrule End Surface 2

3. Press the tip of a new (dry) adapter cleaner into the ferrule end surface and then wipe in one direction 2 or 3 times to dry the surface.

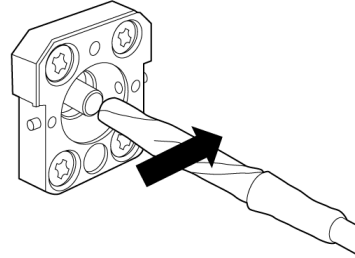

Figure 7.4-3 Cleaning the Ferrule End Surface 3

4. Clean the adapter interior with adapter cleaner. (Refer to “Cleaning the Optical Adapter” below.)
5. Attach the adapter in the reverse order. Be careful not to scratch the ferrule end surface.

Cleaning the Optical Adapter

Use an approved adapter cleaner to clean the optical adapter for connecting to the optical fiber cable. Although the following procedures use the FC connector and adapter as an example, use the same methods when cleaning other connector and adapter types.

Insert adapter cleaner into the split sleeve of the optical adapter. Rotate the adapter cleaner in one direction while moving it back and forth.

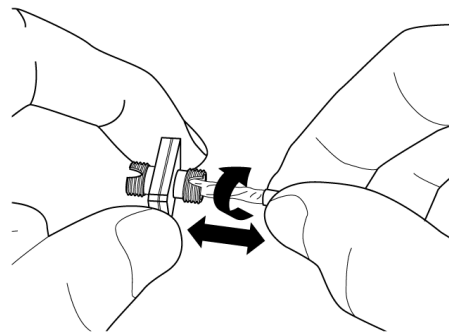

Figure 7.4-4 Cleaning the Ferrule End Surface 4

Note:

Check the ferrule diameter and use a cleaner only for the 1.25 mm or 2.5 mm adapter.

Cleaning the Optical Fiber Cable Ferrule End Surface

Use an approved ferrule cleaner to clean the optical fiber cable ferrule of the end surface. Although the following procedures use the FC connector and adapter as an example, use the same methods when cleaning other connector and adapter types.

1. Pull the ferrule cleaner lever to expose the cleaning surface.

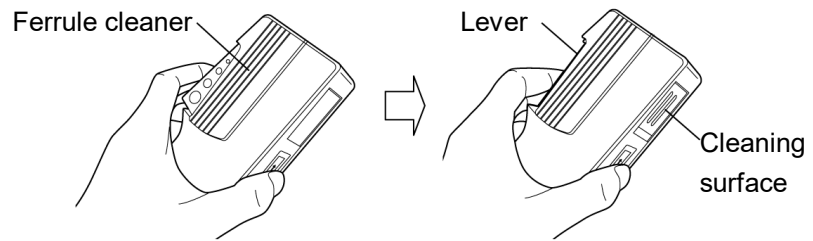

Figure 7.4-5 Ferrule Cleaner – details 1

2. Hold the lever in the opened position, press the optical connector ferrule end into the cleaning surface, and then rub in one direction as shown in the following figure.

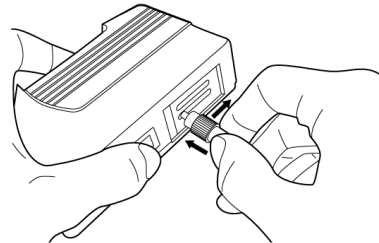

Figure 7.4-6 Ferrule Cleaner – details 2

General Notes on Cleaning

- Do not clean with a used ferrule cleaner.
- Do not finish cleaning with a swab as the swab fibers may adhere.
- Cap the cleaned connector.

 **WARNING**

Check that no light is being emitted when cleaning and checking the ferrule end surface.

 **CAUTION**

The MS9740B may not satisfy performance when used with dirt or dust adhering to the ferrule end surface. In addition, the connected fiber and/or the MS9740B ferrule end surface may be burned if high output light is emitted in this state. Fully clean the fiber to be connected and the MS9740B ferrule end surface before measurement.

7.5 Daily Maintenance

Before daily maintenance of the MS9740B, be sure to turn the power off and unplug it from the AC outlet.

Panel surface dirt

When surface dirt is noticeable, after the MS9740B has been used in a dusty environment, or when the MS9740B has not been used for an extended period of time, wipe its surface with a cloth moistened in detergent and wrung enough.

Screen surface dirt

If the screen surface is dirty, first wipe it dry with a soft cloth. If the dirt persists, wipe the surface gently with a cloth dipped in detergent and wrung enough.

Loose screws

Use a Phillips screwdriver to tighten screws.

7.6 Cautions on Storage MS9740B for Extended Period

Wipe off dust, fingerprint marks, stains, spots, etc. from the surface of the MS9740B before storing it.

Fit the protective front cover before storage. Put the power cord, CD-ROM and other accessories in the accessory box and store it with the main frame.

Avoid storing the MS9740B in these places:

- Places that are exposed to direct sunlight
- Dusty places
- Damp places where condensation may occur on the MS9740B surface
- Places where the MS9740B may be corroded by active gases
- Places where the MS9740B may be oxidized
- Places where the MS9740B may be exposed to strong vibration and shock
- Places where the MS9740B might topple over.
- Places with temperatures and relative humidity in the following ranges:

Temperature:	lower than -20°C or higher than 60°C
Humidity:	90% or more

Recommended storage conditions

It is recommended that the MS9740B be stored in a place that meets the ambient conditions suggested above, plus the following conditions, if it is not to be used for a long period of time:

- Temperature: 5 to 45°C
- Humidity: 40 to 80%
- Little temperature and humidity fluctuations within one day

7.7 Transporting and Disposal

The following describes precautions for transporting and disposing of the MS9740B.

Repackaging

Repack the MS9740B in the packing material (box) in which it was delivered. If the packing material has been thrown away or damaged, repack the MS9740B in the following manner:

1. Get a corrugated cardboard, wooden, or aluminum box large enough to pack cushioning material in around the MS9740B.
2. Wrap the MS9740B in plastic or a similar material to avoid water droplets and dust.
3. Put the MS9740B in the box.
4. Pack the MS9740B in cushioning material so it does not move in the box.
5. Secure the outside of the box with packing cord, adhesive tape, bands, or other similar materials.

Transporting

Avoid vibrations as much as possible and meet the recommended storage conditions during transport.

When transporting using the application part B0640A Carrying Case, make sure to attach the front protection cover that accompanied the Carrying Case to the MS9740B.

Disposal

Follow the instructions of your local waste disposal office when disposing of the MS9740B.

7.8 Troubleshooting

Check the items in Table 7.8-1 if a failure occurs during operation of the MS9740B.

If the failure is not improved, contact an Anritsu Service and Sales office immediately. Contact information can be found on the last page of the printed version of this manual, and is available in a separate file on the PDF version.

Table 7.8-1 Check Items

Phenomenon	Possible cause	Action
Power switch lamp not lit orange	Abnormal/no voltage at power outlet	Check power supply circuit breakers and board.
	Power cord not fully inserted into power outlet or inlet	Connect the power cord correctly. Change a damaged power cord.
Cannot connect optical fiber cord	Fiber and main frame have incompatible connectors	Change the fiber type or change the optical connector of the main frame.
	Optical fiber cord not connected correctly	Check the connector insertion.
Waveform does not change when Single or Repeat pressed	Trace set to not display at Write	Change the trace display settings.
	When external pulse trigger set to ON, pulse not input to Ext Trigger connector	Set Ext Trigger Delay to Off or check the waveform of the signal input to Ext Trigger.
Waveform not displayed	When using external trigger, measures at optical level Off timing	Set Ext Trigger Delay to Off.
	Dirty optical connector	Clean the optical connector.
	All traces set to Display Off	Set the trace display to On.
	Trace type set to Blank	Set at least one trace type to Write.
Long sweep time	Rx optical bandwidth set too narrow	For a short sweep time, refer to Appendix E "Video Band Width and Sweep Time" and increase the Rx optical bandwidth.
	Point averaging set	For a short sweep time, decrease the point average count.
	Large sampling points set	For a short sweep time, decrease the sampling points.
	High dynamic range mode set	For a short sweep time, change the dynamic range mode to Normal.

Table 7.8-1 Check Item (Cont'd)

Phenomenon	Possible cause	Action
Incorrect measured spectrum waveform	Incorrect resolution	Set a small resolution for light sources with a narrow spectrum like LDs.
	Too many smoothing points	Set smoothing to Off or reduce the number of smoothing points
	Displaying memory calculation	Set the trace display to Wri.
	MM Mode set to On	Set MM Mode to Off.
Incorrect measured spectrum wavelength	Wavelength not calibrated	Calibrate as described in 3.1 “Calibrating Before Measurement”.
	Wavelength display in air/vacuum incorrect	Set the desired wavelength display.
Low measured spectrum level	Fiber cord or optical connector dirty	Clean as described in 7.4 “Optical Connector/Optical Adapter Cleaning”.
	SM fiber connected instead of MM fiber	Use MM fiber for light sources requiring MM fiber.
	Fiber cord damaged or under excessive tension, etc.	Do not bend the fiber cord or put heavy objects on it.
	Fiber cord not inserted into connector correctly	Insert the fiber cord into the connector correctly.
Noisy optical waveform at low level measurement	Wide Rx optical bandwidth	Set a narrower Rx bandwidth.
	Resolution too narrow for wideband spectrum light source such as LD	Set an appropriate resolution
	ATT set to On	Set ATT to Off.
Peak point not found by Peak Search	Peak point outside zone markers	Set the zone markers to Off or move the peak point into the range of the zone markers.
Analysis processing not executed for entire waveform	Zone markers set	Set the zone markers to Off or change Zone Center so that the part to be analyzed is between the zone markers.
	Analysis cut or slice level too small	Set the cut or slice level to include the range to be analyzed.
Measurement data not saved	Storage device write-protected	Remove the write protection.
	Storage device full	Change the storage device or delete some files.
	Destination folder set to read only	Change the folder properties.

Table 7.8-1 Check Item (Cont'd)

Phenomenon	Possible cause	Action
Cannot save measurement data	File set to read only	Change the file properties.
	Storage device write-protected	Remove the write protection.
	Destination folder set to read only	Change the folder properties.
Incorrect date and time	Windows time clock set incorrectly	Open the Windows Control Panel, double-click the Time and Date icon and set the correct time and date.
Unable to control remotely	Incorrect Ethernet or GPIB address	Set the Ethernet or GPIB address as described in 6.1 "Setting and Checking Instrument Data".
	Another device with same GPIB address connected	Set a unique GPIB address as described in 6.1 "Setting and Checking Instrument Data".
	Used 2-byte character (space, comma, hyphen) in command	Check commands for illegal characters. 2-byte spaces cannot be used.

Appendix A Specifications

A.1 Specifications

Table A.1-1 Configurations

Item	Specifications		
Model Name	MS9740B Optical Spectrum Analyzer		
Configuration	-Main Frame-		
	MS9740B	Optical Spectrum Analyzer	
	-Option-		
	MS9740B-001/101/201	GPIB Interface	
	MS9740B-002/102/202	Light Source for Wavelength Calibration	
	MS9740B-108/208	OS Upgrade to Win10 Retrofit	
	-Connector Options-		
	MS9740B-037	FC Connector	
	MS9740B-038	ST Connector	
	MS9740B-039	DIN Connector	
	MS9740B-040	SC Connector	
	Standard Accessories -		
		Power Cord	1
	Z2024A	MS9740B Operation Manual (CD) *	1
TAA-1CT140003	Microsoft Software License Terms (WES7)	1	

* The mainframe and remote control manuals are included in the MS9740B Operation Manual CD.

Table A.1-2 Optical Characteristics*¹

Item	Specifications
Applicable optical fiber	SM fiber (ITU-T G.652), GI fiber (50/125 μm), PC Connector (return loss 40 dB or more when connected) SM/GI fiber described hereafter means this specified fiber.
Wavelength Wavelength range Wavelength sweep width Wavelength accuracy Wavelength stability Wavelength linearity	600 nm to 1750 nm 0.2 nm to 1200 nm, 0 nm After WI Cal (Ext) execution ±300 pm (600 to 1520 nm) ±200 pm (1520 to 1570 nm) ±300 pm (1570 to 1750 nm) When installing the light source for wavelength calibration (option): Using SM fiber after WI Cal (Ref) Resolution 0.5, 1.0 nm: ±100 pm (1520 to 1620 nm) Resolution other than 0.5, 1.0 nm: ±20 pm (1520 to 1620 nm) ±5 pm or less Using SM fiber with half-width of center wavelength and 11 pt smoothing during 1-minute period ±20 pm (1520 to 1620 nm)
Resolution Setting resolution Resolution accuracy	0.03, 0.05, 0.07, 0.1, 0.2, 0.5, 1.0 nm (0.03, 0.05 nm only 1550-nm band and room temperature) Resolution accuracy at Center wavelength for displayed Actual resolution 1) Using SM fiber after Res-Cal at 1520 to 1620 nm ±7% (Resolution 0.1 nm) ±3% (Resolution 0.2 nm) ±2.2% (Resolution 0.5 nm) 2) Using SM fiber after Res-Cal at 600 to 1520 nm and 1620 to 1750 nm ±30% (Resolution 0.1 nm) ±15% (Resolution 0.2 nm) ±7% (Resolution 0.5 nm)

*1: After warming up for at least 2 hours after power-on (the Repeat sweeping performed at Span 100 nm or more and VBW 10 kHz or more during the warm-up operation) and performing automatic adjustment of optical axis, with wavelength calibration (hereafter, WI Cal), and constant temperature

Table A.1-2 Optical Characteristics*¹ (Cont'd)

Item	Specifications
Level Measurement level* ²	When optical attenuation is Off: 5 to 30°C -65 to +10 dBm (600 to 1000 nm) -85 to +10 dBm (1000 to 1250 nm) -90 to +10 dBm (1250 to 1600 nm) -85 to +10 dBm (1600 to 1650 nm) -65 to +10 dBm (1650 to 1700 nm) -55 to +10 dBm (1700 to 1750 nm) 30 to 45°C -60 to +10 dBm (600 to 1000 nm) -80 to +10 dBm (1000 to 1250 nm) -85 to +10 dBm (1250 to 1600 nm) -80 to +10 dBm (1600 to 1650 nm) -60 to +10 dBm (1650 to 1700 nm) -50 to +10 dBm (1700 to 1750 nm) When optical attenuation is On: 5 to 30°C -70 to +23 dBm (1100 to 1600 nm) 30 to 45°C -65 to +23 dBm (1100 to 1600 nm)
Measurement level accuracy	±0.4 dB At min. setting resolution of 0.1 nm with -10 dBm input, using SM fiber (master connector) with wavelength of 1310 or 1550 nm and 23 ±5°C
Measurement level stability	±0.02 dB During 1-minute period at min. setting resolution of 0.1 nm with -23 dBm input, using SM fiber with wavelength of 1550 nm, no change in polarization
Level linearity	When optical attenuation is Off: ±0.05 dB Using SM fiber with wavelength of 1550 nm at -50 to 0 dBm When optical attenuation = On: ±0.05 dB Using SM fiber with wavelength of 1550 nm at -30 to +20 dBm
Flatness	±0.1 dB With optical attenuator Off, using SM fiber, at setting resolution of 0.5 nm with wavelength of 1520 to 1620 nm and 10 to 30°C
Polarization dependency	±0.05 dB (1550 nm, 1600 nm) ±0.1 dB (1310 nm) Using SM fiber at setting resolution of 0.5 nm or more.

*2: VBW = 10 Hz, Sweep average = 10, Resolution = 0.07 nm or more (when using SM fiber)

Table A.1-2 Optical Characteristics*¹ (Cont'd)

Item	Specifications
Level (Cont'd) Dynamic range* ³ High dynamic range mode Normal dynamic range mode Return loss	70 dB At ±1 nm from peak wavelength 60 dB At ±0.4 nm from peak wavelength 42 dB At ±0.2 nm from peak wavelength 62 dB At ±1 nm from peak wavelength 58 dB At ±0.4 nm from peak wavelength 42 dB At ±0.2 nm from peak wavelength 35 dB Using SM fiber with wavelength of 1310 and 1550 nm
Sweep time	0.3 s or less /500 nm * ^{4,5} Center wavelength 1200 nm 0.2 s or less /5 nm * ^{4,5} Center wavelength 1550 nm, resolution 0.1 nm 0.35 s /30 nm * ^{6,7} Typical, center wavelength 1550 nm, resolution 0.1 nm 1.65 s /30 nm * ^{7,8} Typical, center wavelength 1550 nm, resolution 0.1 nm

*3: With optical attenuator Off, at setting resolution of 0.05 nm and wavelength of 1550 nm and temperature of 20 to 30°C, excluding diffraction of other order of diffraction

*4: At VBW = 10 kHz, normal dynamic range mode, from sweep start to stop

*5: No optical input, and 501 sampling points or under

*6: At VBW = 1 kHz Fast, from sweep start to stop

*7: With optical input (Tunable Laser Source, -10 dBm, one wavelength), and 1001 sampling points or under, normal dynamic range mode

*8: At VBW = 200 Hz Fast, from sweep start to stop

Table A.1-3 Light Source for Wavelength Calibration (MS9740B-002)

Item	Specifications
Applicable optical fiber	SM fiber (ITU-T G.652)
Optical output level	-40 dBm/nm or more Reference wavelength light, reference light, 10 to 30°C, 1550 ±20 nm, 1 nm setting resolution
Output level stability	±0.04 dB 10 minutes after setting output On using MS9740B and measured under following conditions: Measurement Wavelength: 1550 nm Measurement Resolution: 1 nm VBW 100 Hz Point Avg 20 Measurement time: 1 minute

Table A.1-4 Function

Item	Specification
Measurement function	Automatic measure, Pulse light measurement (external trigger), Power monitor
Display functions	Overlap, Normalized, Max Hold, Value in Air/Vacuum, Effective Resolution
Analysis functions	Wavelength Subtraction, Marker, Wavelength Analysis (Threshold, ndB-Loss, Envelope, RMS, SMSR, Spectrum Power), Light Source Evaluation (FP-LD, DFB-LD, LED), Optical AMP NF Evaluation, PMD Measurement, WDM Signal Evaluation, Optical BPF Bandwidth Analysis
Calibration function	Automatic alignment (optical axis), Wavelength calibration, Level offset function, Wavelength offset function
Memory function	Measurement data Memory A to J (10 waveforms)
External control function	Ethernet, GPIB (option)
Input/Output function	Input/Output: Read and save files from/to USB flash drive Input: External trigger terminal (0 to 0.8/2 to 5 V, high impedance), keyboard, mouse Output: Measured data text file output, measurement screen file output, VGA output
Display device	800 × 600 dots, 8.4-inch SVGA color LCD

Table A.1-5 Mechanical and Environmental Performance

Item	Specification
Dimensions	177 (H), 426 (W), 350 (D) mm, not including projection portion
Mass	15.0 kg max., excluding options
Power	Rated voltage: AC 100 to 120/200 to 240 V Frequency: 50/ 60 Hz
Power source (capacity)	75 VA max.
Temperature/ Humidity	Operating temperature: 5 to 45°C Storage Temperature: -20 to 60°C Humidity: 0 to 90% (no condensation)
Laser safety*	IEC 60825-1/JISC6802 Class 1 FDA 21 CFR 1040.10 Class I

*: When MS9740B-002 Light Source for Wavelength Calibration is installed.

A.2 Application Parts

Table A.2-1 Application Parts

Model	Model Name	Remarks
J0008	GPIB cable, 2m	
J0127A	Coaxial Cord (BNC·P·RG58A/U·BNC·P)	1 m
J0127B	Coaxial Cord (BNC·P·RG58A/U·BNC·P)	2 m
J0617B	Replaceable optical connector (FC)	
J0618D	Replaceable optical connector (ST)	
J0618E	Replaceable optical connector (DIN)	
J0619B	Replaceable optical connector (SC)	
J1534A	LC-SC plug-in Converter (for SM, SC(P)-LC(J))	
J0635A/B/C	Optical Fiber Cord (FC·PC-FC·PC-□M-SM)	1/2/3 m
J0660A/B/C	Optical Fiber Cord (SC·PC-SC·PC-□M-SM)	1/2/3 m
J0893A/B	Optical Fiber Cord (FC·PC-FC·PC-□M-GI)	1/2 m, 50/125 μm
J0839A/B	Optical Fiber Cord (FC·PC-SC·PC-□M-GI)	1/2 m, 50/125 μm
Z0914A	Ferrule cleaner (Clip:1)	
Z0915B	Ferrule Cleaner Replacement Tape (six)	
Z0284	Adapter Cleaner (Stick type:200)	
Z0975A	Keyboard (USB)	
Z0541A	USB mouse	
B0640C*	Carrying Case	
B0641A	Rack Mount Kit	
B0671A	Front Cover for 1MW4U	
W3998AE	MS9740B Optical Spectrum Analyzer Operation Manual	Printed version (English)
W3999AE	MS9740B Optical Spectrum Analyzer Remote Control Operation Manual	Printed version (English)

*: Front panel protective cover attached

Appendix B Initial Values

Table B-1 Wavelength

Item	Initial value
Center	1350.00 nm
Span	500.0 nm
Start	1100.00 nm
Stop	1600.00 nm
Mkr Value Wl/Freq	Wl
Value in Air/Vacuum	Vacuum

Table B-2 Level Scale

Item	Initial value
Scale Select	Log
Log (/div.)	10.0 dB/div.
Reference Level	20.0 dBm
Linear Scale	100.0 mW
Optical Att.	Off

Table B-3 Res/VBW/Avg

Item	Initial value
Res	1.0 nm
VBW	1 kHz
Point Average	Off
Sweep Average	1
Smooth	Off
Sampling Points	501 pt
Actual Res	Off

Table B-4 Peak/Dip Search

Item	Initial value
Status	Off
Search Threshold Auto/Manual	Auto
Peak to Peak Calculation On/Off	Off
Search Threshold	0.10 dB

Table B-5 Analysis

Item	Initial value
Status	Off
Threshold	Cut Lvl: 3.0 dB
ndB Loss	ndB: 3.0 dB
SMSR	Side mode: 2nd Peak
Envelope	Cut Lvl: 3.0 dB
RMS	Ko: 2.35 σ S-Level: 20.0 dB

Table B-6 Trace

Item	Initial value
Active Trace	A
Trace Type	Trace A: Write Trace B-J: Blank
Storage Mode	Off
Calculation	Trace A = B – C Trace B = C – D Trace C = D – E Trace D = E – F Trace E = F – G Trace F = G – H Trace G = H – I Trace H = I – J Trace I = J – A Trace J = A – B
Display On/Off	On
Graph	Normal

Table B-7 Application - DFB-LD Test

Item	Initial value
Slice Level	20.0 dB
Side Mode	2nd Peak
Search Resolution	2.0 dB
K σ	6.07 σ
ndB Width	20.0 dB

Table B-8 Application - FP-LD Test

Item	Initial value
Slice Level	3.0 dB

Table B-9 Application - LED Test

Item	Initial value
Cut Level	3.0 dB
Power Cal	0.00 dB
K σ	2.35 σ

Table B-10 Application - PMD Test

Item	Initial value
Auto/Manual	Auto
Mode Cpl Factor	1
Peak Count	2

Table B-11 Application - WDM Test – Multi Peak

Item	Initial value
Display Mode	SNR
Signal Parameter	
S.Level	30.0 dB
Search Threshold	0.10 dB
Wavelength Detection Type	Peak
Threshold Cut Level	3.0 dB
Level Detection Type	Point
Signal Span	0.40 nm
Noise Parameter	
Area Type	Channel
Channel	
Fitting Span	0.80 nm
Masked Span	0.40 nm
Fitting Curve	Linear
Fitting Curve Display	On
Normalization	Off
Noise BW	0.1 nm
Detection Type	Point
Point	(L+R)/2
User Specify	
Left	
Noise Position	10.00 nm
Span	10.00 nm
Right	
Noise Position	10.00 nm
Span	10.00 nm
Noise Position	Off, 0.40 nm
Ref No.	1
Page Top No.	1

Table B-12 Application - LD Module Test

Item	Initial value
Slice Level	20.0 dB
SMSR Parameter	2nd Peak
K σ	6.07 σ
Search Resolution	2.0 dB
ndB Width	20.0 dB
Signal Parameter	
Wavelength Detection Type	Peak
Threshold Cut Level	3.0 dB
Level Detection Type	Point
Signal Span	0.40 nm
Signal Level	Signal
Noise Parameter	
Area Type	Channel
Channel Fitting Span Masked Span	0.80 nm 0.40 nm
Fitting Curve	Linear
Fitting Curve Display	On
Noise BW	0.1 nm
Detection Type	Point
Point	(L+R)/2
User Specify Left Noise Position Span Right Noise Position Span	10.00 nm 10.00 nm 10.00 nm 10.00 nm
Noise Position	Off, 0.40 nm

Table B-13 Application - Opt .AMP Test

Item	Initial value
Method	Spect Div On
Write to Pin/Pout	Pin
Pin	A
Pout	B
Pase	C
NF Select	S-ASE
ASE Fitting	Gauss Fit
Fitting Span	5.00 nm
Masked Span	2.00 nm
Pin Loss	0.00 dB
Test Pout Loss	0.00 dB
NF Calibration	1.000
O.BPF Level Calibration	0.00 dB
O.BPF Band Width	3.00 nm
Pol Loss	0.00 dB

Table B-14 Application - Opt .AMP Multi Test

Item	Initial value
ISS Method	IEC
Channel Parameter	
S.Level	30.0 dB
Search Threshold	0.10 dB
Wavelength	Peak
Detection Type	
Threshold Cut Level	3.0 dB
Opt .Amp Test Parameter	
Detection Type	Point
Fitting Curve Display	On
Area	
Fitting Curve	Linear
Fitting Span Mode	Auto (Center)
Fitting Span(Manual)	0.80 nm
Masked Span	0.60 nm
Point	
Fitting Span Mode	Auto (Center)
Fitting Span(Manual)	0.80 nm
NF Select	S-ASE
Actual Resolution	Initial
Pin Loss	0.00 dB
Pout Loss	0.00 dB
O.BPF Lvl Cal	0.00 dB
O.BPF BW	0.00 nm
NF Calibration	1.000
Write to Pin/Pout	Pin
Display Mode	Trace & Table
Pin	A
Pout	B

Table B-15 Application – WDM Filter

Item	Initial value
S.Level	30.0 dB
Search Threshold	0.10 dB
Channel	
Detection Type	Peak
Cut Level	3.0 dB
Threshold Wavelength	
Cut Level A	3.0 dB
Cut Level B	20.0 dB
BW/Pass Band	
Analysis Type	BW
Cut Level A	3.0 dB
Cut Level B	20.0 dB
Pass-Band Span	4.00 nm
Level	
Detection Type	Point
Σ Power Signal Span	0.40 nm
Ripple Span	0.20 nm

Table B-16 Measure Mode

Item	Initial value
Dynamic Range Norm/Hi	Norm
Ext Trigger Delay	Off
Interval Time	0
Power Monitor	Off
MM Mode	Off

Table B-17 Others

Item	Initial value
Optical Output On/Off	Off
Title	Optical Spectrum Analyzer

Table B-18 Cal

Item	Initial value
W1 Offset	0 nm
Level Offset	0 dB
Align with cal	Off
Auto Cal On/Off	Off
Auto Offset On/Off	On

Table B-19 Config

Item	Initial value
GPIB Address	1
IP Address	192.168.0.10
Subnet Mask	255.255.255.0
Terminator Settings	CR/LF
File Type Settings	BMP
Color Settings	Normal
File Name Settings	Data + sequential number (000-999)
Beep Sound Settings	On

Table B-20 Marker

Item	Initial value
λ Mkr_A	Off, 1100.0000 nm
λ Mkr_B	Off, 1600.0000 nm
LMkr_C	Off, 20.000 dBm
LMkr_D	Off, -30.000 dBm
TMkr	Off, 1100.0000 nm
Δ Mkr	Off, 1100.0000 nm

Table B-21 Zone Marker

Item	Initial value
Zone Center	Off, 1350.000 nm
Zone Width	Off, 100.000 nm
Zone Out/In	Out

Appendix C Message Lists

Table C-1 Error Message List

Message	Phenomenon
Auto CAL failed	Automatic wavelength calibration failed due to changes in temperature and pressure.
Auto Cal in progress	Automatic wavelength calibration is executing.
Auto Measure finished unsuccessfully	Automatic wavelength calibration was not completed successfully.
Auto-measuring	Automatic measurement is being performed.
Block data error	The binary data format is incorrect.
Calculation enabled only when calculation set for Trace Type of active trace	An attempt was made to set the calculation equation when the active trace type is not Calculate.
Calibrating	Calibration is executing.
Character data error	Some unusable characters are entered.
Character string too long	There are too many characters in the input string.
Control CPU application error File not found	A required file was not found.
Control CPU Boot Error	An error occurred during boot processing at start-up.
Control CPU Shutdown Error	An error occurred during shutdown processing at power-off.
Copying	An image file is being saved.
Dip point not found	There is no dip point. Check that the input optical level is sufficient.
Error in Optical Unit	An error occurred in optical unit at start-up.
Either the device has insufficient free space or the 9999 limit on saved files has been reached.	Either the disk is nearly full and has insufficient free space or the maximum number of files (9999) has been saved to disk.
Execution error	An error other than parameter settings occurs.
File already exists. Overwrite?	There is already a file with the same name. Overwrite the file?
File not found	The file was not found.
File read failed	The file was not read.
File read failed (incorrect model)	There was an error when reading the file (number conflict).
File read failed (incorrect option configuration)	There was an error when reading the file (option configuration conflict).
File write failed	The file was not written.
Folder not found	The file was not found.
FPGA Config Error	A FPGA Config error occurred at start-up.
Illegal character in input string	There is a forbidden character in the file name.

Table C-1 Error Message List (Cont'd)

Message	Phenomenon
Input title	There is no file name. Input the file name.
Input value out of range	The input value is outside the setting range.
Invalid In Sweep-Average	Execution is not supported while the Sweep Average function is selected.
Invalid wavelength	The input wavelength is out of range.
Item not selected	A file is not selected for reading at Recall.
Mass storage error	A file operation error occurs. The following errors occur when the file operation is performed in the Config: <ul style="list-style-type: none"> ● no specified driver ● format error ● media file full ● no file ● write-protect drive
No external storage device	There is no external storage device (drive E to Z).
No file selected	No file has been selected for operation.
Operation failed because write protected	Unable to execute operation because the file is write-protected.
Operation prohibited at Analysis	The operation cannot be executed while the Analysis function is in use.
Operation prohibited at Auto search threshold. Change search threshold from auto to manual.	The operation cannot be executed while the Search threshold is Auto. Change the Search threshold from Auto to Manual.
Operation prohibited at Calibration.	The operation cannot be executed while calibration is in progress.
Operation prohibited at frequency unit Change unit from frequency to wavelength.	The operation cannot be executed while the marker display units are Frequency. Change the units from Frequency to Wavelength.
Operation prohibited at Linear Scale Change Linear Scale to Log Scale.	The operation cannot be executed while the level scale is set. Change from Linear scale to Log scale.
Operation prohibited at Peak Search and Dip Search	The operation cannot be executed while Peak Search and Dip Search are in progress.
Operation prohibited at Wavelength Calibration Operation prohibited at Auto Alignment	The operation cannot be executed while the wavelength calibration and auto alignment are in progress.
Operation prohibited during Auto Measure	The operation cannot be executed while the auto measurement is in progress.
Operation prohibited during measurement	The operation cannot be executed while the measurement is in progress.
Operation prohibited when Application selected	The operation cannot be executed while the application measurement is in progress.

Table C-1 Error Message List (Cont'd)

Message	Phenomenon
Operation prohibited when Area specified as Noise Detection Type.	The operation cannot be executed while Detection Type for Noise Parameter is Area
Operation prohibited when Auto Cal is On. Zero Cal cannot be executed.	The operation cannot be executed while Auto Cal is On. Zero Cal cannot be executed.
Operation prohibited when Auto PMD selected	The operation cannot be executed while the PMD setting is Auto.
Operation prohibited when Calculation set for Trace Type Change Trace Type to setting other than Calculation.	The following operations cannot be executed when Trace Type is set to Calculate. <ul style="list-style-type: none"> • Analysis – Spectrum Power display • Application Analysis function display Change the Trace Type to some setting other than Calculate.
Operation prohibited when Overlap is NOT selected in Storage Mode.	The following operations cannot be executed when Trace Type is not set to Overlap. <ul style="list-style-type: none"> • Erase Overlap
Operation prohibited when Overlap is selected in Storage Mode.	The following command settings to Active Trace cannot be executed when Trace Type is set to Overlap. <ul style="list-style-type: none"> • Setting Trace Type to Calculate
Operation prohibited when Normalize Disp displayed	The operation cannot be executed while Normalize Disp is displayed.
Operation prohibited when Opt. Amp Application selected	The following operations cannot be executed when F6 Trace is pressed during optical amplifier evaluation. <ul style="list-style-type: none"> • Active Trace setting • Trace type setting • Calculation setting • Trace display On/Off setting • Regular /Normalized display switching
Operation prohibited when Peak/Dip Search is not performed.	Operation is prohibited when either Peak or Dip search has not been executed.
Operation prohibited when Pulse Method or WDM Method in Opt. Amp Application is selected.	Operation is prohibited when either Pulse Method or WDM Method is selected at the optical amplifier application.
Operation prohibited when Spectrum Power is selected.	Operation is prohibited when the spectrum power is measured using the analysis function.
Operation prohibited when TMkr not displayed Turn TMkr on.	This operation cannot be performed when trace mask is not displayed. Set the trace mask display.
Operation prohibited when WDM Application selected	This operation cannot be performed while the WDM test is measured.
Operation prohibited when Zone Marker displayed Turn Zone Marker off.	This operation cannot be performed while the zone marker is displayed. Delete the zone marker.

Table C-1 Error Message List (Cont'd)

Message	Phenomenon
Operation prohibited while Ext.Trig. displayed	This operation cannot be performed while the external synchronized measurement is in progress.
Operation prohibited while Power Monitor displayed	This operation cannot be performed while the power monitor measurement is in progress.
Optical attenuator error	An abnormality occurred in the optical attenuator at start-up.
Optical input power too high Insert attenuator or decrease input level.	The optical input level is too high. Use an optical attenuator or reduce the optical level.
Optical power too low for Optical Unit auto-adjustment. Adjust input level.	The optical input level is too low for accurate optical axis adjustment.
Optical power too low to calibrate wavelength Adjust input level.	The optical input level is too low for wavelength calibration.
Optical Unit failed alignment adjustment	Optical axis adjustment cannot be performed during start-up.
Optical Unit failed auto alignment	An abnormality occurred at optical axis auto adjustment at start-up.
Optical Unit failed calibration data test Contact Anritsu or representative.	There was a fault in the calibration data at start-up.
Optical Unit failed FPGA data test Contact Anritsu or representative.	There was a fault in the FPGA data at start-up.
Optical Unit failed grating control	There was a fault in the grating control at start-up.
Optical Unit failed memory test at boot	There was a fault in the memory test at start-up.
Optical Unit failed offset adjustment Check no optical power input.	Offset adjustment failed at start-up. Check that there is no optical input.
Optical Unit failed program test Contact Anritsu or representative.	An abnormality was detected in the program test at start-up.
Option Error (**)	There is an error in option xxx.
Optional light source error	An abnormality was detected in the light source option at start-up.
Pase enabled only when PLZN Nulling set for Method.	Pase was selected at Write to when a method other than PLZN Nulling was selected at the PMD measurement method.
Peak->Level disabled when Calculated set for Trace Type Change Trace Type to setting other than Calculation.	Peak → Level processing is not supported when Trace Type is set to Calculate. Change Trace Type to something other than Calculate.
Peak point not found	There is no peak point.
The recall processing was completed.	Reading of the file is completed.
Recalling	The file is being read.
Resolution bandwidth calibration failed	The resolution calibration is failed.
Resolution Cal in progress	The resolution calibration is in progress.
The save processing was completed.	Saving of the file is completed.

Table C-1 Error Message List (Cont'd)

Message	Phenomenon
Save file name not specified	The file name to be saved is not specified.
Selected item is empty.	There is no file on the specified device.
Selected TCP Port Number busy Change TCP Port Number.	The selected TCP port number is in use. Change the TCP port number.
Set Display of Active Trace to On.	Peak Search or Dip Search was executed while Active Trace was set to Display Off. Set to display the Active Trace.
Set Span larger than 0.	Set the span during Zone Marker display to a value larger than 0 nm.
Slit 1 error in Optical Unit	An abnormality occurred in Slit 1 at start-up.
Slit 2 error in Optical Unit	An abnormality occurred in Slit 2 at start-up.
Specified file already exists	There is already a file with the same name.
Storage Mode enabled only when Write set for Trace Type of active trace	Storage Mode can only be set when Trace Type of Active Trace is Write.
Target device full	The output target device is full.
The file has not been selected.	No file has been selected for operation.
The installation execution file is not found.	There is no installation file on the specified device.
The license file is not found.	There is no license file on the specified device.
This application has performed an illegal operation and will be shut down.	An error has caused shutdown.
This operation is not acceptable when unit of wavelength is frequency. Change unit from frequency to wavelength.	This operation cannot be performed while the displayed wavelength unit is set to frequency. Change the unit from frequency to wavelength.
Trace already in use	The same trace cannot be set at Opt Amp Pin, Pout, and Pase.
Trace measurement parameters must be same to calculate between traces	Different trace measurement conditions have been set at the trace Calculation input.
Undefined error.	Undefined message has occurred.
Warning	Warning
Warning-Auto Measure clears all trace data. Continue operation?	All wavelengths are deleted when performing the automatic measurement.
Warning-changing sampling points clears all trace data. Change sampling points?	All trace data is deleted when sampling points are changed. Change sampling points?
Warning-operation sets Trace Type of Trace X to Blank. Continue operation?	Executing this processing sets the Trace X (X:A to J) trace type to Blank. Execute processing?
Warning-system reset deletes user data in D: Execute system reset?	Executing system reset deletes all data on drive D:/. Execute system reset?
Wavelength calibration failed	Wavelength could not be calibrated.

Appendix D Keyboard and Mouse Operations

A keyboard and mouse can be connected to this equipment.

Table D-1 shows the responses of the panel keys and keyboard.

Table D-2 shows the response of the panel keys and mouse.

Table D-3 shows the response of the rotary knob and mouse.

Shift + F1 in the table means that the **Shift** key and **F1** key are pressed simultaneously.

Table D-1 Responses of the Panel Keys and Keyboard

Panel key	Keyboard	Remarks
∧	↑	
∨	↓	
<	←	
>	→	
.	. (Period)	
-	- (Minus)	
0	0	
1	1	
2	2	
3	3	
4	4	
5	5	
6	6	
7	7	
8	8	
9	9	
↵ Center	Ctrl + Alt + H	
↵ Ref	Ctrl + Alt + I	
Auto Measure	Ctrl + Alt + A	
BS	BS (Back Space)	
Cancel	Esc	
Center	Ctrl + Alt + B	
Copy	Ctrl + Shift + T	
Enter	Enter	

Table D-1 Responses of the Panel Keys and Keyboard(Cont'd)

Panel key	Keyboard	Remarks
F1	Shift + F1	
F2	Shift + F2	
F3	Shift + F3	
F4	Shift + F4	
F5	Shift + F5	
F6	Shift + F6	
F7	Shift + F7	
F8	Shift + F8	
f1	F1	
f2	F2	
f3	F3	
f4	F4	
f5	F5	
f6	F6	
f7	F7	
f8	F8	
Local	Ctrl + Alt + Q	
Log(/div.)	Ctrl + Alt + E	
Marker Select	Ctrl + Alt + J	
Peak Search	Ctrl + Alt + L	
Preset	Ctrl + Alt + P	
Ref	Ctrl + Alt + F	
Recall	Ctrl + Alt + S	
Repeat	Ctrl + Alt + N	
Res	Ctrl + Alt + D	
Save	Ctrl + Alt + R	
Single	Ctrl + Alt + M	
Span	Ctrl + Alt + C	
Stop	Ctrl + Alt + O	
VBW	Ctrl + Alt + G	
Zone Marker	Ctrl + Alt + K	

Table D-2 Response of the Panel Keys and Mouse

Panel key	Mouse	Remarks
Auto Measure	Right-click	Select from menu
Local	Right-click	Select from menu
Preset	Right-click	Select from menu
Recall	Right-click	Select from menu
Repeat	Right-click	Select from menu
Save	Right-click	Select from menu
Single	Right-click	Select from menu
Stop	Right-click	Select from menu

Table D-3 Response of the rotary knob and mouse

Rotary knob	Mouse wheel	Remarks
Counterclockwise	Wheel up	
Clockwise	Wheel pressed	

Appendix E Video Band Width and Sweep Time

Table E-1 shows the relationship between VBW, sweep time and minimum optical reception sensitivity.

Table E-1 shows the reference value. These values are not guaranteed in the specification values.

Table E-1 Relationship between VBW, Sweep Time and Minimum Optical Reception

VBW	Sweep Time (typ.)* ¹	Min. Optical Reception Sensitivity* ²
1 MHz	0.2 s	-40 dBm
100 kHz	0.2 s	-50 dBm
10 kHz	0.2 s	-60 dBm
2 kHz	0.3 s	-66 dBm
1 kHz	0.5 s	-70 dBm
200 Hz	2.0 s	-76 dBm
100 Hz	3.5 s	-80 dBm
10 Hz	32 s	-90 dBm
1 kHz Fast	0.25 s	-70 dBm
200 Hz Fast	1.0 s	-76 dBm

*1: Wavelength range: Center 1200 nm, Span 200 nm
 Sampling points: 501 pt
 Dynamic range mode: Normal
 Averaging processing: Point Average 1
 Optical input: None
 From starting to ending sweep (Measured using remote commands.)

*2: Wavelength range: 1250 nm to 1600 nm
 Optical attenuation: Off
 Averaging processing: Sweep Average 10
 Ambient temperature: 5 to 30°C
 Resolution : 0.07 nm or more
 When using a SM fiber

Setting VBW at 1 kHz Fast or 200 Hz Fast enables a faster sweep than when setting VBW at 1 kHz or 200 Hz. However, when measuring a signal of which spectral width is narrow, such as ITLA (Integrable Tunable Laser Assembly) or DFB-LD (Distribution Feedback Laser Diode), the accuracy of the wavelength and level measured at 1 kHz Fast or 200 Hz Fast may be lower than when measured at 1 kHz or 200 Hz. Therefore, before measuring a signal, confirm the waveform.

Note:

Even if VBW is set at 1 kHz Fast or 200 Hz Fast, when one of the following conditions is met, the sweep speed is the same as when VBW is set at 1 kHz or 200 Hz:

- Point Average is set to On.
- Dynamic Range is set to High.
- The external trigger (Ext. Trigger) is set to On.
- The settings are other than the above, but the wavelength per point is less than 4 pm.

Appendix F Performance Test Result Form

Document number: _____

Test Location: _____

Date: _____

Test person in charge: _____

Product name: MS9740B Optical Spectrum Analyzer _____

Serial number: _____

Software version: _____

Option: _____

Power voltage: _____ V

Power frequency: _____ Hz

Ambient temperature _____ °C

Relative humidity _____ %

Instruments used: Model name _____ Serial number _____

Model name _____ Serial number _____

Model name _____ Serial number _____

Model name _____ Serial number _____

Remarks _____

Appendix

Appendix F

F.1 Wavelength Accuracy

Table F.1-1 Wavelength Accuracy (When installing MS9740B-002)

Setting Resolution: nm

Light Source Settings Wavelength	Wavelength meter Display value	Measurement value	Minimum value	Result	Maximum value
1520.00 nm	nm	nm	-20 pm	pm	+20 pm
1530.00 nm	nm	nm	-20 pm	pm	+20 pm
1540.00 nm	nm	nm	-20 pm	pm	+20 pm
1550.00 nm	nm	nm	-20 pm	pm	+20 pm
1560.00 nm	nm	nm	-20 pm	pm	+20 pm
1570.00 nm	nm	nm	-20 pm	pm	+20 pm
1580.00 nm	nm	nm	-20 pm	pm	+20 pm
1590.00 nm	nm	nm	-20 pm	pm	+20 pm
1600.00 nm	nm	nm	-20 pm	pm	+20 pm
1610.00 nm	nm	nm	-20 pm	pm	+20 pm
1620.00 nm	nm	nm	-20 pm	pm	+20 pm

Table F.1-2 Wavelength Accuracy (When not installing MS9740B-002)

Setting Resolution: nm

Light Source Settings Wavelength	Wavelength meter Display value	Measurement value	Minimum value	Result	Maximum value
1520.00 nm	nm	nm	-200 pm	pm	+200 pm
1530.00 nm	nm	nm	-200 pm	pm	+200 pm
1540.00 nm	nm	nm	-200 pm	pm	+200 pm
1550.00 nm	nm	nm	-200 pm	pm	+200 pm
1560.00 nm	nm	nm	-200 pm	pm	+200 pm
1570.00 nm	nm	nm	-200 pm	pm	+200 pm
1580.00 nm	nm	nm	-300 pm	pm	+300 pm
1590.00 nm	nm	nm	-300 pm	pm	+300 pm
1600.00 nm	nm	nm	-300 pm	pm	+300 pm
1610.00 nm	nm	nm	-300 pm	pm	+300 pm
1620.00 nm	nm	nm	-300 pm	pm	+300 pm

F.2 Level Accuracy

Table F.2-1 Level Accuracy

Setting Resolution: nm

Light Source Wavelength	Power Meter Display Value	Measurement Value	Minimum value	Result	Maximum value
nm	dBm	dBm	-0.4 dB	dB	+0.4 dB
nm	dBm	dBm	-0.4 dB	dB	+0.4 dB

F.3 Dynamic Range

Table F.3-1 Normal Dynamic Range Mode

Δ Marker Setting Wavelength	Measurement Value	Minimum Value	Result	Measurement Uncertainty
+0.2 nm	dB	42 dB	dB	1 dB
+0.4 nm	dB	58 dB	dB	1 dB
+1.0 nm	dB	62 dB	dB	1 dB
-0.2 nm	dB	42 dB	dB	1 dB
-0.4 nm	dB	58 dB	dB	1 dB
-1.0 nm	dB	62 dB	dB	1 dB

Table F.3-2 High Dynamic Range Mode

Δ Marker Setting Wavelength	Measurement Value	Minimum Value	Result	Measurement Uncertainty
+0.2 nm	dB	42 dB	dB	1 dB
+0.4 nm	dB	60 dB	dB	1 dB
+1.0 nm	dB	70 dB	dB	1 dB
-0.2 nm	dB	42 dB	dB	1 dB
-0.4 nm	dB	60 dB	dB	1 dB
-1.0 nm	dB	70 dB	dB	1 dB

Appendix G Excel Macro

from files saved in csv format.

This macro has been confirmed to work with Microsoft Excel 2010.

1. Reading csv file
 - (a) Click **File – Open...** at the Excel menu.
 - (b) Change the file type at the Open File window to a text file.
 - (c) Choose the saved csv file and click **Open**.

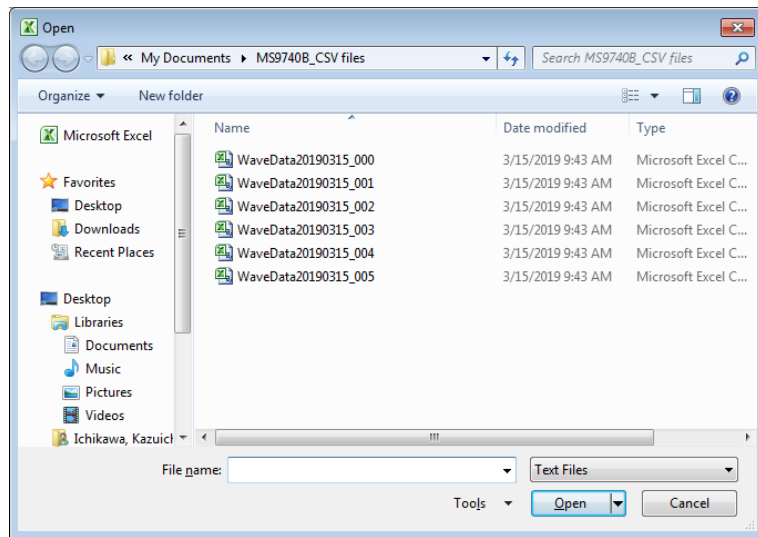

Figure G-1 Open the File Dialog Box

2. Change the work sheet name.
Change the file worksheet name to Sheet 1.

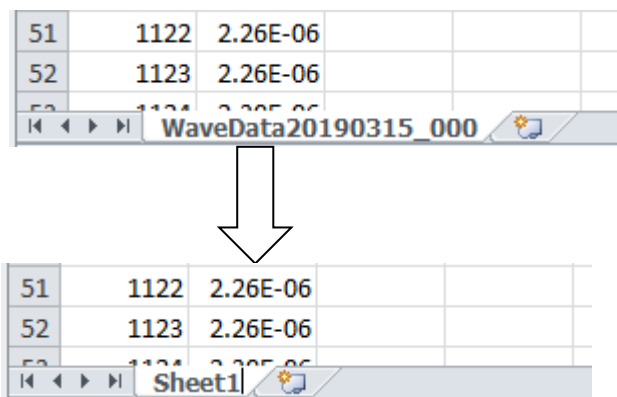
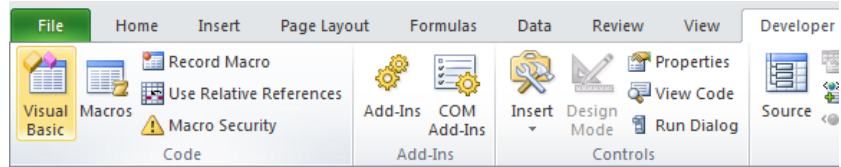
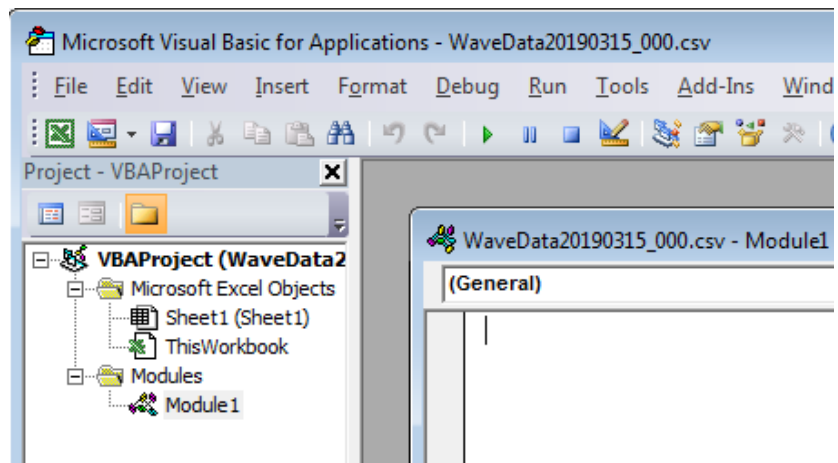

Figure G-2 Chang the File Worksheet Name

3. Input the macro.
 - (a) Click **Developer – Visual Basic** at the Excel menu.



- (b) Click **Insert – Module** from the Visual Basic for Applications menu. Module1 is added.



- (c) Copy the macro from the following pages and paste it into the Module1 (code) window.
 - (d) Click **File – Close and Return to Microsoft Excel** from the Visual Basic for Applications menu.
4. Save the file.
 - (a) Click **File – Save As...** at the Excel menu.
 - (b) At the Save As... dialog box, change the file type to **Excel Macro-Enabled Workbook (*.xlsm)**.
 - (c) Click **Save**.
5. Run the Macro.
 - (a) Click **Developer – Macros** at the Excel menu.
 - (b) Select Macro1 and click **Run** at the opened macro dialog box.

A graph sheet is created and a graph is drawn. An example is shown in Figure G-3.

```

Sub Macrol ()
'
'Define variables
'
Dim Start_Wl, Stop_Wl, Smple_Cnt, VB_Val As Single
Dim Data_Area, File_name, Date_time, Row_shift As String
Dim Value_Sw, RBW, Act_RBW, VBW, Smpl_Num As String
Dim Avr_Sw, Smooth_Sw, OptATT_Sw, D_Range_SW As String
Dim Trc_Type, Trc_Mode, Ext_trg, Interval_t As String
Dim Trc_Cal, Trc_num, MM_mod As String
'
' Storing value to variables
'
File_name = Sheets("Sheet1").Range("B1")
Date_time = Sheets("Sheet1").Range("B2")

If Sheets("Sheet1").Range("A4") = "Trace" Then
Start_Wl = Sheets("Sheet1").Range("B7")
Stop_Wl = Sheets("Sheet1").Range("B8")

Value_Sw = Sheets("Sheet1").Range("A9") & " " & Sheets("Sheet1").Range("B9")
OptATT_Sw = Sheets("Sheet1").Range("A10") & " " & _
Sheets("Sheet1").Range("B10")
RBW = Sheets("Sheet1").Range("A11") & " " & Sheets("Sheet1").Range("B11")
Act_RBW = Sheets("Sheet1").Range("A12") & " " & _
Sheets("Sheet1").Range("B12") & " " & Sheets("Sheet1").Range("C12")

VBW = Sheets("Sheet1").Range("A13") & " " & _
Sheets("Sheet1").Range("B13") & " " & Sheets("Sheet1").Range("D13")
'VB_Val = Sheets("Sheet1").Range("B12")
Avr_Sw = Sheets("Sheet1").Range("A14") & " " & Sheets("Sheet1").Range("B14")
Smooth_Sw = Sheets("Sheet1").Range("A15") & " " & _
Sheets("Sheet1").Range("B15")
Smpl_Num = Sheets("Sheet1").Range("A16") & " " & _
Sheets("Sheet1").Range("B16")
Smple_Cnt = Val(Sheets("Sheet1").Range("B17"))

Trc_Type = Sheets("Sheet1").Range("A18") & " " & _
Sheets("Sheet1").Range("B18")
Trc_Mode = Sheets("Sheet1").Range("A19") & " " & _
Sheets("Sheet1").Range("B19")
Trc_Cal = Sheets("Sheet1").Range("B20") & " - " & _
Sheets("Sheet1").Range("B21")

D_Range_SW = Sheets("Sheet1").Range("A22") & " " & _
Sheets("Sheet1").Range("B22")
Ext_trg = Sheets("Sheet1").Range("A23") & " " & Sheets("Sheet1").Range("B23")

```

```
Interval_t = Sheets("Sheet1").Range("A24") & " " & _
Sheets("Sheet1").Range("B24")
MM_mod = Sheets("Sheet1").Range("A25") & " " & Sheets("Sheet1").Range("B25")
Trc_num = Sheets("Sheet1").Range("A4") & " " & Sheets("Sheet1").Range("B4")

Set FoundCell = Cells.Find(What:="Level(?)")
Row_shift = FoundCell.Row

'MsgBox "Level(?) is row " & FoundCell.Row & ".", vbInformation

Data_Area = "A" & LTrim(Str(Row_shift + 1)) & _
"B" & LTrim(Str(Row_shift + Smple_Cnt))
Else
Start_Wl = Sheets("Sheet1").Range("B6")
Stop_Wl = Sheets("Sheet1").Range("B7")

Value_Sw = Sheets("Sheet1").Range("A8") & " " & Sheets("Sheet1").Range("B8")
OptATT_Sw = Sheets("Sheet1").Range("A9") & " " & Sheets("Sheet1").Range("B9")
RBW = Sheets("Sheet1").Range("A10") & " " & Sheets("Sheet1").Range("B10")
Act_RBW = Sheets("Sheet1").Range("A11") & " " & _
& Sheets("Sheet1").Range("B11") & " " & Sheets("Sheet1").Range("C11")

VBW = Sheets("Sheet1").Range("A12") & " " & _
& Sheets("Sheet1").Range("B12") & " " & Sheets("Sheet1").Range("D12")
'VB_Val = Sheets("Sheet1").Range("B12")
Avr_Sw = Sheets("Sheet1").Range("A13") & " " & Sheets("Sheet1").Range("B13")
Smooth_Sw = Sheets("Sheet1").Range("A14") & " " & _
Sheets("Sheet1").Range("B14")
Smpl_Num = Sheets("Sheet1").Range("A15") & " " & _
Sheets("Sheet1").Range("B15")
Smple_Cnt = Val(Sheets("Sheet1").Range("B16"))

Trc_Type = Sheets("Sheet1").Range("A17") & " " & _
Sheets("Sheet1").Range("B17")
Trc_Mode = Sheets("Sheet1").Range("A18") & " " & _
Sheets("Sheet1").Range("B18")
Trc_Cal = Sheets("Sheet1").Range("B19") & " - " & _
Sheets("Sheet1").Range("B20")

D_Range_SW = Sheets("Sheet1").Range("A21") & " " & _
Sheets("Sheet1").Range("B21")
Ext_trg = Sheets("Sheet1").Range("A22") & " " & Sheets("Sheet1").Range("B22")
Interval_t = Sheets("Sheet1").Range("A23") & " " & _
Sheets("Sheet1").Range("B23")
MM_mod = Sheets("Sheet1").Range("A24") & " " & Sheets("Sheet1").Range("B24")
Trc_num = Sheets("Sheet1").Range("A26") & " " & Sheets("Sheet1").Range("B26")
```



```

    Data_Area = "A29:B" & LTrim(Str(28 + Smple_Cnt))
End If

'
' Creating Graph
'
Charts.Add
ActiveChart.ChartType = xlXYScatterLinesNoMarkers
ActiveChart.SetSourceData Source:=Sheets("Sheet1").Range(Data_Area), PlotBy _
    :=xlColumns
ActiveChart.Location Where:=xlLocationAsNewSheet
ActiveChart.SeriesCollection(1).Name = Trc_num
ActiveChart.PlotArea.Select
Selection.Width = 600
Selection.Height = 370
Selection.Left = 50
Selection.Top = 55

With ActiveChart
    .HasTitle = True
    .ChartTitle.Characters.Text = File_name
    .Axes(xlCategory, xlPrimary).HasTitle = True
    .Axes(xlCategory, xlPrimary).AxisTitle.Characters.Text = "Wavelength [nm]"
    .Axes(xlValue, xlPrimary).HasTitle = True
    .Axes(xlValue, xlPrimary).AxisTitle.Characters.Text = "Power [mW]"
End With

With ActiveChart.Axes(xlCategory)
    .HasMajorGridlines = True
    .HasMinorGridlines = True
    .MinimumScale = Start_Wl
    .MaximumScale = Stop_Wl
    .MinorUnit = (Stop_Wl - Start_Wl) / 10
    .MajorUnit = (Stop_Wl - Start_Wl) / 2
    .Crosses = xlAutomatic
    .ReversePlotOrder = False
    .ScaleType = xlLinear
    .DisplayUnit = xlNone
End With

With ActiveChart.Axes(xlValue)
    .HasMajorGridlines = True
    .HasMinorGridlines = True
    .MinimumScale = 0
    .MaximumScaleIsAuto = True
    .MinorUnit = .MaximumScale / 10

```

```
.MajorUnit = .MaximumScale / 2
.Crosses = xlCustom
.CrossesAt = 0
.ReversePlotOrder = False
.ScaleType = xlLinear
.DisplayUnit = xlNone
End With

ActiveChart.Axes(xlCategory).Select
ActiveChart.PlotArea.Select
With Selection.Border
    .ColorIndex = 16
    .Weight = xlThin
    .LineStyle = xlContinuous
End With

Selection.Interior.ColorIndex = xlNone
Application.CalculateFull

ActiveChart.Axes(xlValue).MinorGridlines.Select
With Selection.Border
    .ColorIndex = 57
    .Weight = xlHairline
    .LineStyle = xlDot
End With

ActiveChart.Axes(xlCategory).MinorGridlines.Select
With Selection.Border
    .ColorIndex = 57
    .Weight = xlHairline
    .LineStyle = xlDot
End With

'
'   Insert Conditions of measurement
'
ActiveChart.ChartArea.Select

'   "Text 1"
With ActiveChart.TextBoxes.Add(610, 10, 56, 15)
    .Select
    .AutoSize = True
    .Text = Date_time
End With

'   "Text 2"
```

```
With ActiveChart.TextBoxes.Add(10, 420, 56, 15)
    .Select
    .AutoSize = True
    .Text = RBW
End With

' "Text 3"
With ActiveChart.TextBoxes.Add(140, 420, 56, 15)
    .Select
    .AutoSize = True
    .Text = Act_RBW
End With

' "Text 4"
With ActiveChart.TextBoxes.Add(480, 420, 55, 15)
    .Select
    .AutoSize = True
    .Text = Value_Sw
End With

' "Text 5"
With ActiveChart.TextBoxes.Add(630, 420, 55, 15)
    .Select
    .AutoSize = True
    .Text = VBW
End With

' "Text 6"
With ActiveChart.TextBoxes.Add(10, 24, 54, 15)
    .Select
    .AutoSize = True
    .Text = Smpl_Num
End With

' "Text 7"
With ActiveChart.TextBoxes.Add(90, 24, 56, 15)
    .Select
    .AutoSize = True
    .Text = Avr_Sw
End With

' "Text 8"
With ActiveChart.TextBoxes.Add(190, 24, 55, 15)
    .Select
    .AutoSize = True
    .Text = Smooth_Sw
End With
```

```
' "Text 9"
With ActiveChart.TextBoxes.Add(290, 24, 54, 15)
    .Select
    .AutoSize = True
    .Text = OptATT_Sw
End With

' "Text 10"
With ActiveChart.TextBoxes.Add(410, 24, 54, 15)
    .Select
    .AutoSize = True
    .Text = D_Range_SW
End With

' "Text 11"
With ActiveChart.TextBoxes.Add(530, 24, 56, 15)
    .Select
    .AutoSize = True
    .Text = Ext_trg
End With

' "Text 12"
With ActiveChart.TextBoxes.Add(620, 24, 54, 15)
    .Select
    .AutoSize = True
    .Text = Interval_t
End With

' "Text 13"
With ActiveChart.TextBoxes.Add(635, 220, 55, 15)
    .Select
    .AutoSize = True
    .Text = Trc_Type
End With

' "Text 14"
With ActiveChart.TextBoxes.Add(635, 260, 80, 30)
    .Select
    .AutoSize = False
    .Text = Trc_Mode
End With

If Trc_Type = "Trace Type Calculate" Then

    ' "Text 15"
```

```
    With ActiveChart.TextBoxes.Add(635, 295, 54, 15)
        .Select
        .AutoSize = True
        .Text = Trc_Cal
    End With

End If

' "Text 16"
With ActiveChart.TextBoxes.Add(635, 320, 80, 30)
    .Select
    .AutoSize = False
    .Text = MM_mod
End With

End Sub
```

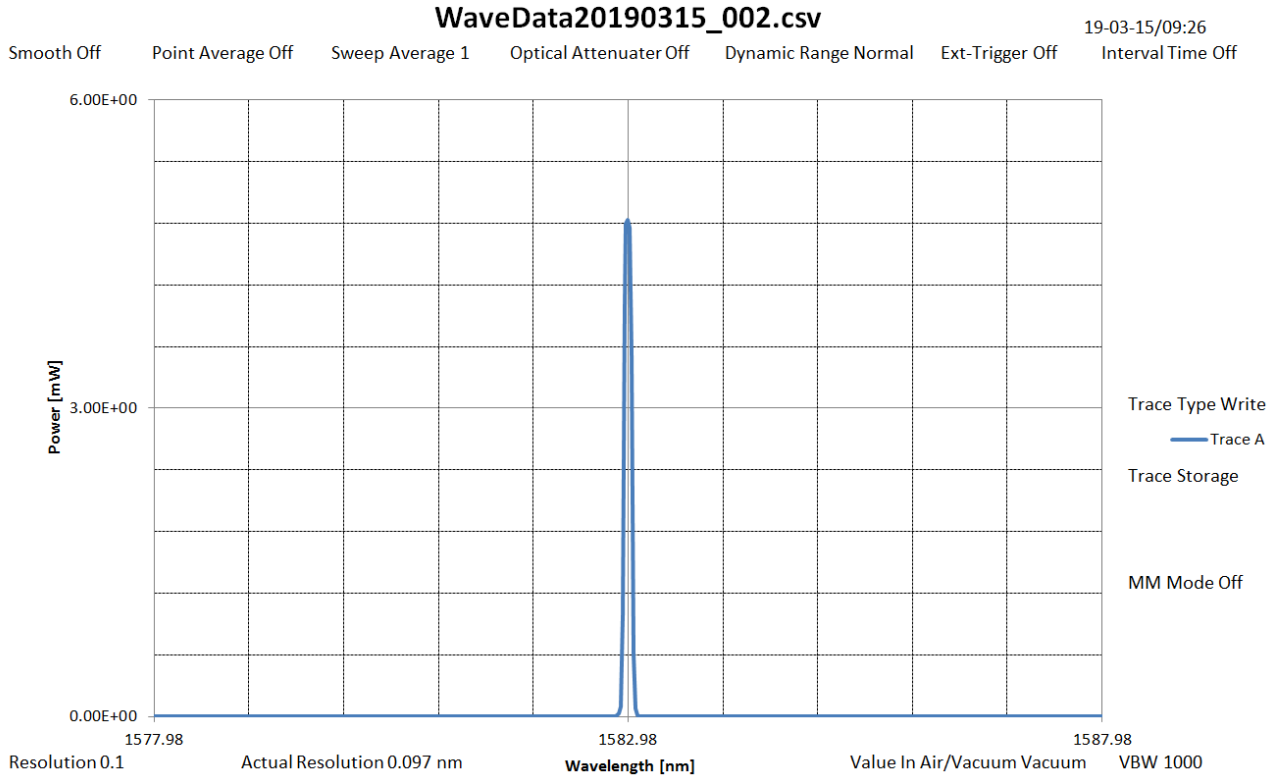

Figure G-3 Macro Performance Result

Appendix H Bibliography

- (1) IEC11801 *Information technology - Generic cabling for customer premises*
- (2) IEC60747-5-3 *Discrete semiconductor devices and integrated circuits - Part 5-3: Optoelectronic devices - Measuring methods*
- (3) IEC60793-1-44 *Optical fibres - Part 1-44: Measurement methods and test procedures - Cut-off wavelength*
- (4) IEC60793-1-48 *Optical fibres - Part 1-48: Measurement methods and test procedures - Polarization mode dispersion*
- (5) IEC60825-1 *Safety of laser products. Part 1: Equipment classification, requirements and user's guide*
- (6) IEC61010-1 *Safety requirements for electrical equipment for measurement, control, and laboratory use - Part 1: General requirements*
- (7) IEC61280-1-3 *Fibre optic communication subsystem basic test procedures - Part 1-3: Test procedures for general communication subsystems - Central wavelength and spectral width measurement*
- (8) IEC61280-2-9 *Fibre optic communication subsystem test procedures - Part 2-9: Digital systems - Optical signal-to-noise ratio measurement for dense wavelength-division multiplexed systems*
- (9) IEC61280-4-4 *Fibre optic communication subsystem test procedures - Part 4-4: Cable plants and links - Polarization mode dispersion measurement for installed links*
- (10) IEC61290-1-1 *Optical amplifiers - Test methods - Part 1-1: Power and gain parameters - Optical spectrum analyzer method*
- (11) IEC61290-3-1 *Optical amplifiers - Test methods - Part 3-1: Noise figure parameters - Optical spectrum analyzer method*
- (12) IEC61290-10-1 *Optical amplifiers - Test methods - Part 10-1: Multichannel parameters - Pulse method using an optical switch and optical spectrum analyzer*
- (13) IEC61290-10-4 *Optical amplifiers - Test methods - Part 10-4: Multichannel parameters – Interpolated source subtraction method using an optical spectrum analyzer*
- (14) IEC62007-2 *Semiconductor optoelectronic devices for fibre optic system applications - Part 2: Measuring methods*
- (15) IEC62129 *Calibration of optical spectrum analyzers*
- (16) IEC62150-2 *Fibre optic active components and devices - Test and measurement procedures - Part 2: ATM-PON transceivers*

- (17) ISO31-0 *Quantities and units - Part0 : General principles*
- (18) ISO31-6 *Quantities and units. Light and related electromagnetic radiations*
- (19) ITU-T G.651.1 *Characteristics of a 50/125 μm multimode graded index optical fibre cable for the optical access network*
- (20) ITU-T G.652 *Characteristics of a single-mode optical fibre and cable*
- (21) ITU-T G.694.1 *Spectral grids for WDM applications: DWDM frequency grid*
- (22) ITU-T G.694.2 *Spectral grids for WDM applications: CWDM wavelength grid*
- (23) ITU-T G.697 *Optical monitoring for dense wavelength division multiplex systems*
- (24) Anritsu Corporation *Optical Amplifier (EDFA) Characteristics Evaluation*
<https://www.anritsu.com/en-us/test-measurement/support/downloads/application-notes/dw1009208>

References are to page numbers.

Symbol and Numbers

Σ

ΣPower.....5-23, 5-37

μ

μW 1-3

1

1st Peak Marker.....5-14

1st Peak Wavelength.....5-14

A

Abbreviations1-13

Accuracy 1-7

Active Trace.....4-24

Act-Res4-10

Actual Resolution Calculation Method.....5-80

Adjusting Optical System..... 3-4

Analysis 4-13, B-2

Analyzing Waveform4-13

Application Parts.....A-8

Arrow key3-12

ASE Fitting.....5-48

ASE Lvl/(Res)ASE Lvl/(Res).....5-47

Auto Align..... 3-4

Auto Cal(Init) 3-7

Auto Measure3-13

Auto Offset3-7

Automatic measurement.....3-13

B

Beep Sound Setting 6-5

C

CalB-9

Calculation4-25

Calculation Method.....5-28

Calculation using polarization nulling method
.....5-66

Calibrating Before Measurement..... 3-2

Calibrating Resolution 3-9

Calibrating Wavelength 3-5

Calibration..... 1-7, 7-2

Cautions on Handling Optical Fiber Cables 2-12

Cautions on Storage 7-15

Center 4-2

Center Offset 5-43

CH Lvl 5-86

CH Wl 5-86

Changing Data Capturing Method..... 4-7

Changing Measurement Mode 4-27

Changing Resolution 3-14

Changing Scale..... 3-15

Changing Waveform Memory Settings and
Calculation between Memories..... 4-22

Changing Wavelength 3-14

Channel Parameter5-68, 5-71

S.Level..... 5-72

Search Threshold 5-72

Wavelength 5-72

Checking Instrument Data..... 6-7

Cleaning the Ferrule End Surface..... 7-10

Cleaning the Optical Adapter..... 7-11

Cleaning the Optical Fiber Cable Ferrule End
Surface 7-12

Color Setting..... 6-4

ConfigB-9

Configuring Storage Media 2-44

Connecting Power Cord..... 2-9

Copy 3-25

Copy Setting 6-4

Copy to HDD..... 6-10

CSV..... 3-22

D

Daily Maintenance 7-14

dBm 1-3

Delete..... 6-10

Delta marker 3-16

Description of Optical Spectrum Analyzer.... 1-2

Detection Type.....5-22, 5-36, 5-72

Device 6-9

DFB-LD Test5-6, B-3

Diff Group Delay..... 5-13

Dip Search 4-11

Index

Display.....4-25
Display Mode.....5-68
Displaying Level Peaks and Dips.....4-11
Displaying Windows Desktop.....2-21
Disposal.....7-16
Dynamic Range 1-10, 4-28, 7-7

E

Envelope.....4-17
Erase Overlap.....4-26
Erasing Analysis Results4-21
Ethernet Setting..... 6-2
Ext Trigger Delay.....4-28
Ext. Trigger Delay.....5-52
External Trigger..... 1-7

F

File Name Input dialog box.....3-23
File Name Setting 6-4
File Operation 6-9
File Protect 6-9
File Selection Dialog box.....3-26
File Type Setting 6-4
Fitting Span5-50
Focus Change6-11
FP-LD Test..... 5-9, B-3
Front Panel..... 2-5

G

Gain Slope5-67
Gain Variation.....5-17, 5-67
Gain(dB) Calculation Method.....5-64
Gauss Fitting.....5-48
Gaussian distribution function.....4-19
General Notes on Cleaning.....7-12
Glossary..... 1-7
GPIB Setting 6-2
Graph.....4-26

I

Image.....3-22
Labels on Product..... viii
Initializing Measurement Conditions3-27
Inputting Data.....3-12
Inputting Offset.....3-10

Inputting Title to Waveform Data..... 4-31
Installation 2-3
Intended Use 1-6
Interface Setting..... 6-2
Interval Time..... 4-29
ISS Method..... 5-83
 Advanced..... 5-68
 Advanced Calculation Method 5-79
 IEC 5-68
 IEC Calculation Method 5-79
 Off 5-68
 Off Calculation Method..... 5-80

K

Keypad..... 3-12

L

Laser Radiation Markings..... viii
Laser Safety Classifications vii
Last Page.....5-31, 5-85
Last Peak Marker..... 5-14
Last Peak Wavelength..... 5-14
LD Module Test..... 5-45, B-5
LED Test 5-12, B-3
Level Accuracy..... 7-6
Level marker 3-16
Level Offset..... 3-10
Level Scale.....4-5, B-1
Light Source for waveform calibration..... 2-2
Linear Level..... 4-6
Local 3-28
Log(/div)..... 4-5
Log(/div.)..... 3-15

M

Managing Files..... 6-9
Marker..... B-10
Marker Select 3-20
Masked Span 5-50
Max Hold 4-24
Mean Fitting..... 5-49
Measure Mode 4-27, B-9
Measured Level Range 1-9
Measuring DFB-LD 5-3

- Measuring FP-LD 5-7
- Measuring Laser Diode Modules 5-33
- Measuring LED 5-10
- Measuring Optical Amplifier 5-47
- (Wavelength Division Multiplex) 5-67
- Calculation Method 5-64
- Polarization Nulling Method 5-56
- Pulse Method 5-58
- Spectrum Division Methods 5-54
- Measuring PMD 5-13
- Measuring the Optical Amplifier (Wavelength
Division Multiplex)
- Calculation Method 5-79
- Measuring WDM 5-17
- Min Hold 4-24
- MkrValue Wl/Freq 4-3
- MM Mode 4-29
- Mode Cpl Factor 5-14
- Mode Offset 5-43
- Mode Spacing 5-7
- Mode(n dB) 5-7
- Move to USB 6-9
- Multi Peak 5-19
- Multimode Fiber Mode 4-29
- mW 1-3
- N**
- ndB Loss 4-16
- ndB Width 5-4, 5-35
- Next Page 5-31, 5-85
- NF (dB) Calculation Method 5-64
- NF Cal 5-50
- NF Select 5-50
- nm 1-3
- Noise Factor NF (dB) Calculation Method 5-81
- Noise Measureing Point 5-28, 5-44
- Noise Parameter 5-24, 5-39
- Area 5-26, 5-41
- Area Type 5-27, 5-41
- Channel 5-27, 5-42
- Detection Type 5-39
- Detection Type 5-25
- Fitting Curve 5-26, 5-41
- Fitting Curve Display 5-27, 5-41
- Noise BW 5-25
- Noise Span 5-39
- Normalization 5-25
- Point 5-26, 5-41
- User Specify 5-27, 5-42
- Noise Position 5-25, 5-40
- Normal 4-26
- Normalize 4-26
- nW 1-3
- O**
- O.BPF BW 5-51, 5-78
- O.BPF Lvl Cal 5-50, 5-78
- Opt .AMP Multi Test B-7
- Opt .AMP Test B-6
- Opt Amp Test Parameter 5-68, 5-74
- Actual Resolution 5-77
- Area 5-76
- Detection Type 5-75
- Fitting Curve 5-76
- Fitting Display 5-76
- Fitting Span Mode 5-76
- Initial 5-77
- Masked Span 5-76
- Measured 5-77
- NF Cal 5-78
- NF Select 5-77
- Pin Loss(Offset) 5-78
- Point 5-77
- Pout Loss(Offset) 5-78
- S-ASE 5-77
- Total 5-77
- Opt.Att 4-6
- Optical Connector/Optical Adapter Cleaning
..... 7-10
- Optical Output 4-32
- Option Info 6-7
- Others 4-31, 4-32, B-9
- Overlap 4-24
- P**
- panel lock 3-28
- Parameter Dialog Box Input Range
 Parameter Dialog Box Input Range 5-49

Index

Peak Count5-14, 5-86
Peak Search.....3-20, 4-11
Peak/Dip Search 4-11, B-1
Peak->Ref Lvl.....3-15
Peaks Targeted for Analysis.....5-72
Performance Test 7-3
Pin Loss5-51
PK Lvl.....5-86
PkDens(/1nm).....5-10
PLZN Nulling5-48
PLZN NullingPLZN Nulling5-56
PMD Test..... 5-15, B-3
Point average..... 4-7
Pol Loss5-51
Pout Loss5-51
Power Monitor4-29
Power Requirements 2-8
Precautions at Measurement2-14
Pulse Method.....5-48, 5-59
pW 1-3

R

Reading Data from File.....3-26
Rear Panel..... 2-6
Recall.....3-26, 3-27
Recommended storage conditions.....7-15
Ref3-15
Ref Level..... 4-6
Relationship between VBW, Sweep Time and
Minimum Optical Reception E-1
Relative.....5-20
Releasing Panel Lock3-28
Remote Control.....1-12
Repackaging7-16
Repeat.....3-13
Repeat measurement.....3-13
Replacement of Optical Connector 7-8
Res 4-8
Res Cal.....3-9
Res/VBW/Avg 4-8, B-1
Resetting System Data..... 6-8
Resolution.....1-11
Response of the Panel Keys and MouseD-3
Response of the rotary knob and mouse.....D-3

Responses of the Panel Keys and Keyboard..D-1
Ripple..... 5-86
RMS..... 4-18
Rotary knob 3-12

S

Sampling Point 4-8
S-ASE 5-50
Save 3-23
Saving Measurement Conditions and Waveform
Data..... 3-23
Saving Screens 3-25
Screen Names..... 2-45
Search Resolution..... 5-4, 5-35
Setting and Checking Instrument Data..... 6-2
Setting Control Panel.....2-21, 2-24
Setting Interfaces and File Operating
Environment 6-2
Setting Level Display 4-5
Signal Parameter.....5-21, 5-36
Level.....5-23, 5-37
S.Level..... 5-22
Wavelength5-22, 5-36
Signal Subject to Analysis 5-91
Single..... 3-13
Single measurement..... 3-13
Slice Level..... 5-4, 5-33
Smooth..... 4-9
SMSR..... 4-15
SMSR Parameter
2nd Peak 5-35
Left..... 5-35
Right..... 5-35
SNR 5-19
SNR(/*.nm)..... 5-45
SNR(Res ***nm)..... 5-44
Software Install 6-11
Software License Install 6-12
Software License View..... 6-7
Spacing 5-86
Span..... 4-2
Specifications.....A-1
Spect Dev OffSpect Dev Off..... 5-55
Spect Dev OnSpect Dev On 5-54

Spect Div Off5-4, 5-47
 Spect Div On.....5-48
 Spectrum Division Calculation Method5-66
 Spectrum Power4-20
 Start..... 4-3
 Stop.....3-13, 4-3
 Stop Band5-43
 Storage Mode.....4-24
 Sweep average 4-7
 Sweep Speed..... 1-7
 System Info..... 6-7, 6-8
 System Info View..... 6-7
 System Information Save 6-8
 System Reset 6-8
 System Setting 6-5

T

Table..... 5-20, 5-70, 5-89
 Terminate Setting 6-2
 Test Parameter
 Ripple5-93
 Test Parameter.....5-90
 BW/Pass Band.....5-92
 Detection Type5-91
 Level.....5-93
 S.Level5-91
 Search Threshold5-91
 Threshold Wavelength5-92
 Threshold.....4-14
 THz..... 1-3
 Title4-31
 Title Input Dialog box4-31
 Total5-50
 Total Power5-7, 5-10
 Trace..... 4-22, B-2
 Trace & Table5-69, 5-88
 Trace marker3-16
 Trace Type.....4-24
 Transporting.....7-16
 Troubleshooting.....7-17
 Turning Power On/Off.....2-18

U

Unpacking 2-2
 Updating Software 6-11
 Using external display..... 2-25
 Using Light Source Option..... 4-32
 Using Wavelength and Level Markers..... 3-20
 Using Zone Markers 3-21

V

Value in Air/Vac 4-4
 VBW..... 1-7, 4-8

W

Waveform Analysis..... 1-10
 Waveform Calculation 1-10
 Wavelength.....4-2, B-1
 Wavelength Accuracy 7-5
 Wavelength marker 3-16
 Wavelength Multiplexed Light..... 5-61
 Wavelength-related Settings..... 4-2
 WDM Analysis Target Peaks 5-22
 WDM Filter B-8
 WDM Measure.....5-48, 5-61
 WDM Test.....5-31, B-4
 Windows Security Measures 2-29
 W1 Cal(Ext) 3-5
 W1 Cal(Ref) 3-6
 W1 Offset..... 3-10
 Write to.....5-52, 5-68

X

XML..... 3-22

Z

Zero Cal3-8
 Zone marker 3-16
 Zone Marker 3-21, B-10

