

**MS2690A/MS2691A/MS2692A
Signal Analyzer
Operation Manual
Signal Analyzer Function
Operation**

33rd Edition

- For safety and warning information, please read this manual before attempting to use the equipment.
- Additional safety and warning information is provided within the MS2690A/MS2691A/MS2692A Signal Analyzer Operation Manual (Mainframe Operation). Please also refer to it before using the equipment.
- Keep this manual with the equipment.

ANRITSU CORPORATION

Safety Symbols

To prevent the risk of personal injury or loss related to equipment malfunction, Anritsu Corporation uses the following safety symbols to indicate safety-related information. Ensure that you clearly understand the meanings of the symbols BEFORE using the equipment. Some or all of the following symbols may be used on all Anritsu equipment. In addition, there may be other labels attached to products that are not shown in the diagrams in this manual.

Symbols used in manual

 **DANGER** This indicates a very dangerous procedure that could result in serious injury or death if not performed properly.

 **WARNING** This indicates a hazardous procedure that could result in serious injury or death if not performed properly.

 **CAUTION** This indicates a hazardous procedure or danger that could result in light-to-severe injury, or loss related to equipment malfunction, if proper precautions are not taken.

Safety Symbols Used on Equipment and in Manual

The following safety symbols are used inside or on the equipment near operation locations to provide information about safety items and operation precautions. Ensure that you clearly understand the meanings of the symbols and take the necessary precautions BEFORE using the equipment.



This indicates a prohibited operation. The prohibited operation is indicated symbolically in or near the barred circle.



This indicates an obligatory safety precaution. The obligatory operation is indicated symbolically in or near the circle.



This indicates a warning or caution. The contents are indicated symbolically in or near the triangle.



This indicates a note. The contents are described in the box.



These indicate that the marked part should be recycled.

MS2690A/MS2691A/MS2692A

Signal Analyzer

Operation Manual Signal Analyzer Function Operation

24 April 2007 (First Edition)

20 February 2019 (33rd Edition)

Copyright © 2007-2019, ANRITSU CORPORATION.

All rights reserved. No part of this manual may be reproduced without the prior written permission of the publisher.

The contents of this manual may be changed without prior notice.

Printed in Japan

Notes On Export Management

This product and its manuals may require an Export License/Approval by the Government of the product's country of origin for re-export from your country.

Before re-exporting the product or manuals, please contact us to confirm whether they are export-controlled items or not.

When you dispose of export-controlled items, the products/manuals need to be broken/shredded so as not to be unlawfully used for military purpose.

Cautions Against Computer Virus Infection

- Copying files and data

Only files that have been provided directly from Anritsu or generated using Anritsu equipment should be copied to the instrument.

All other required files should be transferred by means of USB or CompactFlash media after undergoing a thorough virus check.

- Adding software

Do not download or install software that has not been specifically recommended or licensed by Anritsu.

- Network connections

Ensure that the network has sufficient anti-virus security protection in place.

About This Manual

■ Operation manual configuration

The operation manual configuration of the MS2690A/MS2691A/MS2692A Signal Analyzer is shown below.

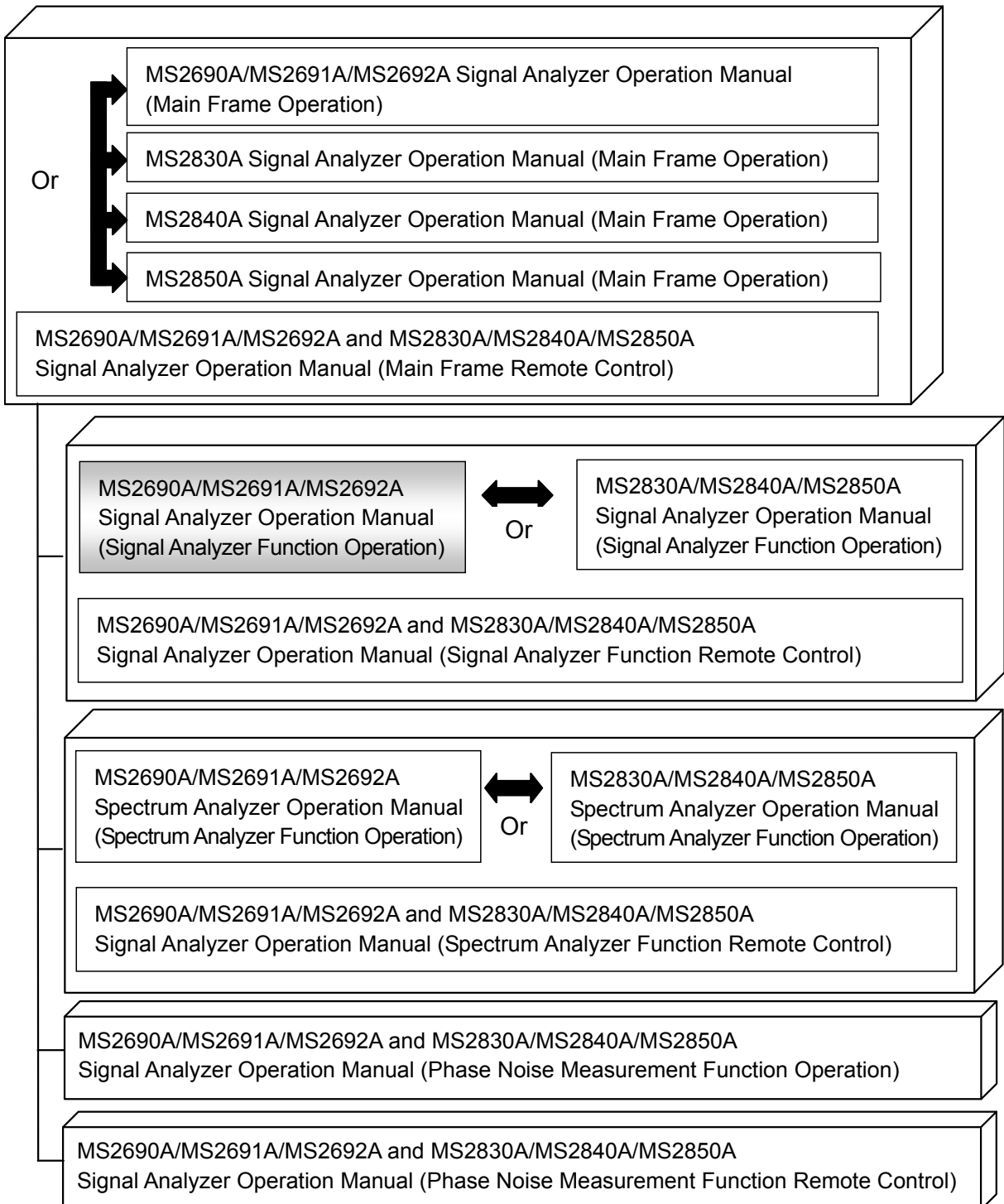

- Signal Analyzer Operation Manual (Mainframe Operation)
- Signal Analyzer Operation Manual (Mainframe Remote Control)
Description of basic operations, maintenance procedures, common functions and common remote functions of the mainframe
- Signal Analyzer Operation Manual (Signal Analyzer Function Operation)
<This document>
- Signal Analyzer Operation Manual (Signal Analyzer Function Remote Control)
Description of basic operations, functions and remote functions of the signal analyzer
- Signal Analyzer Operation Manual (Spectrum Analyzer Function Operation)
- Signal Analyzer Operation Manual (Spectrum Analyzer Function Remote Control)
Description of basic operations, functions and remote functions of the spectrum analyzer
- Signal Analyzer Operation Manual (Phase Noise Measurement Function Operation)
- Signal Analyzer Operation Manual (Phase Noise Measurement Function Remote Control)
Description of basic operations, functions and remote functions of the phase noise measurement function.

In this document,  indicates a panel key.

Table of Contents

About This Manual..... I

Chapter 1 Overview 1-1

1.1 Overview of Signal Analyzer..... 1-2
 1.2 Features of Signal Analyzer..... 1-3

Chapter 2 Basic Operation..... 2-1

2.1 Display Description 2-2
 2.2 Setting Frequency..... 2-4
 2.3 Setting Level 2-15
 2.4 Setting IQ Data Capture Time Range..... 2-31

Chapter 3 Selecting Waveform Capture

Method..... 3-1

3.1 Single/Continuous Measurement..... 3-2
 3.2 Trigger Function..... 3-3

Chapter 4 Trace 4-1

4.1 Selecting Trace..... 4-3
 4.2 Spectrum..... 4-5
 4.3 Power vs Time 4-71
 4.4 Frequency vs Time 4-118
 4.5 Phase vs Time 4-157
 4.6 CCDF 4-175
 4.7 Spectrogram 4-200
 4.8 No Trace 4-221
 4.9 Sub-Trace 4-227

Chapter 5 Digitize Function 5-1

5.1 Saving IQ Data..... 5-2
 5.2 Replay Function..... 5-10
 5.3 Playback Function 5-18

1
2
3
4
5
6
7
Appendix
Index

Chapter 6 System Setting 6-1

6.1	Setting System.....	6-2
6.2	Erasing Warm up Message	6-3
6.3	Setting Title	6-4
6.4	Adjusting Internal Reference Clock Signal	6-5
6.5	Input Source for Reference Clock Signal	6-6
6.6	Pre-Amp On/Off Display	6-7
6.7	Setting Preselector	6-8

Chapter 7 Setting DigRF 3G..... 7-1

7.1	Display Description	7-2
7.2	Setting Input.....	7-3
7.3	Setting Frequency.....	7-8
7.4	Setting Level	7-9
7.5	Setting IQ Data Capture Time Range.....	7-11
7.6	Trigger Function.....	7-14
7.7	Selecting Trace.....	7-16
7.8	Saving IQ Data.....	7-36
7.9	System Setting.....	7-40
7.10	Default Value List.....	7-42

Appendix A Error Messages..... A-1

Appendix B Default Value List B-1

Appendix C Standard Parameter List..... C-1

Appendix D FFT and RBW D-1

Appendix E IQ Data Time Actually Required.. E-1

Appendix F Saving Waveform CSV DATA F-1

Index Index-1

Chapter 1 Overview

This chapter describes an overview of the Signal Analyzer function.

1.1	Overview of Signal Analyzer.....	1-2
1.2	Features of Signal Analyzer.....	1-3

1.1 Overview of Signal Analyzer

The MS2690A/MS2691A/MS2692A Signal Analyzer (hereinafter, referred to as “MS2690A/MS2691A/MS2692A”) can measure the transmitter characteristics of wireless devices for various types of mobile communications quickly, accurately, and easily.

The Signal Analyzer function can achieve high-speed spectrum analysis and simultaneous analysis on the frequency and time axes, which cannot be achieved by a conventional sweep type spectrum analyzer, by using FFT processing (fast Fourier transformation). Also, it can record the RF input signal as digital data (digitize function).

The Signal Analyzer function has the following features:

- Broad frequency band (6 GHz/13.5 GHz/26.5 GHz)
- Broad analysis bandwidth (31.25 MHz/62.5 MHz*¹/125 MHz*²)
- Continuous analysis of captured data is available
- High-capacity waveform memory is installed
- High-speed spectrum analysis is available
- Wide variety of measurement functions

These characteristics enable the MS2690A/MS2691A/MS2692A to be used for various applications, from research and development to manufacturing.

*1: 62.5 MHz can be set only when Option 078 Analysis Bandwidth (hereafter, Option 078) is installed.

*2: 125 MHz can be set only when Option 004 Wideband Analysis Hardware or Option 078 Analysis Bandwidth (hereafter, Option 078) is installed.

1.2 Features of Signal Analyzer

A signal analyzer can perform analysis with both the frequency and time axes. It achieves high-speed spectrum analysis by using fast Fourier transformation (FFT) technology.

Differences from a sweep type spectrum analyzer

This section compares the MS2690A/MS2691A/MS2692A with a conventional sweep type spectrum analyzer and describes the differences.

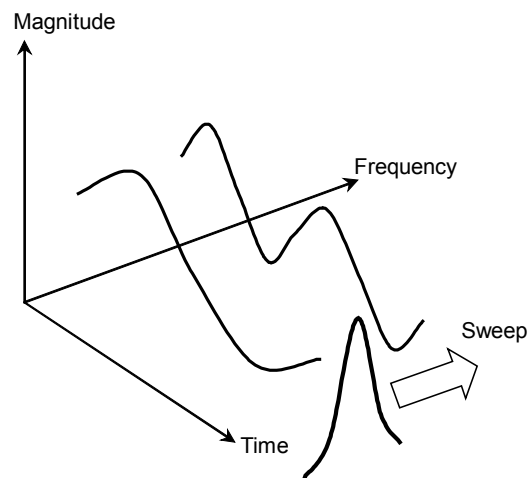

Figure 1.2-1 Principle of a sweep type spectrum analyzer

As shown in Figure 1.2-1, a sweep type spectrum analyzer sweeps a filter with a certain frequency band. Because observation is done only within the filter band, only one frequency can be observed at one given moment. To analyze a spectrum of multiple signals simultaneously, the filter must be swept in the entire band, and no signal can be detected for a high sweep speed (i.e., short sweep time). This results in a limitation of the sweep speed for accurate measurement.

On the other hand, the MS2690A/MS2691A/MS2692A captures the time domain data and performs FFT processing to display all the signals in the frequency band simultaneously, quickly, and accurately.

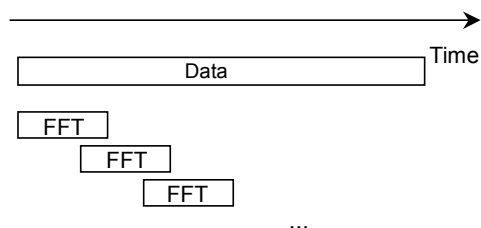

Figure 1.2-2 Principle of MS2690A/MS2691A/MS2692A

Analyzing captured IQ data in various domains

The MS2690A/MS2691A/MS2692A can analyze simultaneous input signals by capturing IQ data for a certain time interval.

- Spectrum: Performs spectrum analysis by the FFT method. It performs noise measurement and power measurement of modulation signal waves accurately and quickly, which are difficult to measure accurately by using a sweep type spectrum analyzer.
- Power vs Time: Observes time fluctuations of power. It performs burst average power accurately and quickly.
- Frequency vs Time: Observes time fluctuations of frequency. It can perform frequency lock time measurement without using any special instrument.
- Phase vs Time: Measures time fluctuation of phase.
- CCDF: Performs Complementary Cumulative Distribution Function (CCDF) analysis.
- Spectrogram: Performs Spectrogram analysis. It is used to diagram the changes in a spectrum over time.

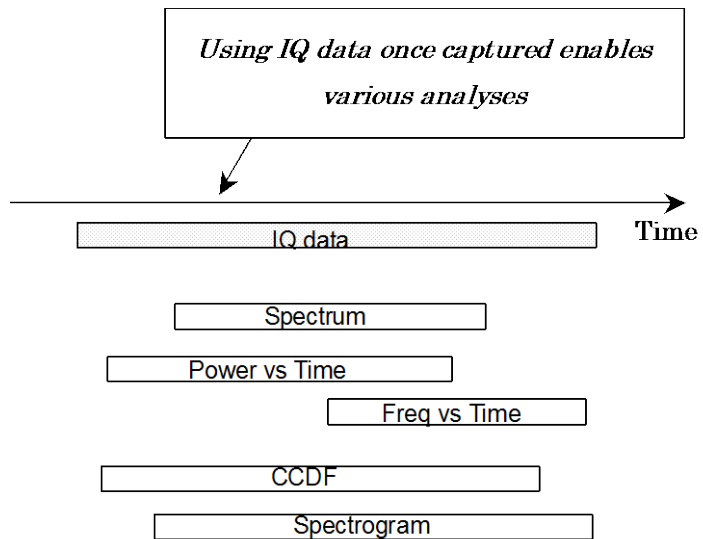

Figure 1.2-3 Multiple analyses

As shown in Figure 1.2-3, once the IQ data for a certain time interval is captured, 4 types of analysis methods can be selected for analysis in the time range.

Chapter 2 Basic Operation

This chapter describes the basic operation for the Signal Analyzer function.

2.1	Display Description	2-2
2.2	Setting Frequency.....	2-4
2.2.1	Setting center frequency	2-8
2.2.2	Setting frequency span.....	2-9
2.2.3	Setting start frequency.....	2-11
2.2.4	Setting stop frequency.....	2-12
2.2.5	Setting frequency band	2-13
2.2.6	Setting step size	2-14
2.3	Setting Level	2-15
2.3.1	Setting reference level.....	2-19
2.3.2	Setting input attenuator	2-20
2.3.3	Setting scale	2-26
2.3.4	Setting reference level unit.....	2-28
2.3.5	Setting reference level offset.....	2-29
2.3.6	Pre-Amp	2-30
2.3.7	Microwave Preselector Bypass	2-30
2.4	Setting IQ Data Capture Time Range.....	2-31
2.4.1	Setting capture time.....	2-32
2.4.2	Recapture and Reanalysis	2-34
2.4.3	Parameters recaptured when Capture Time is set to Manual.....	2-37

2.1 Display Description

This section describes the display items on the main screen of the Signal Analyzer function.

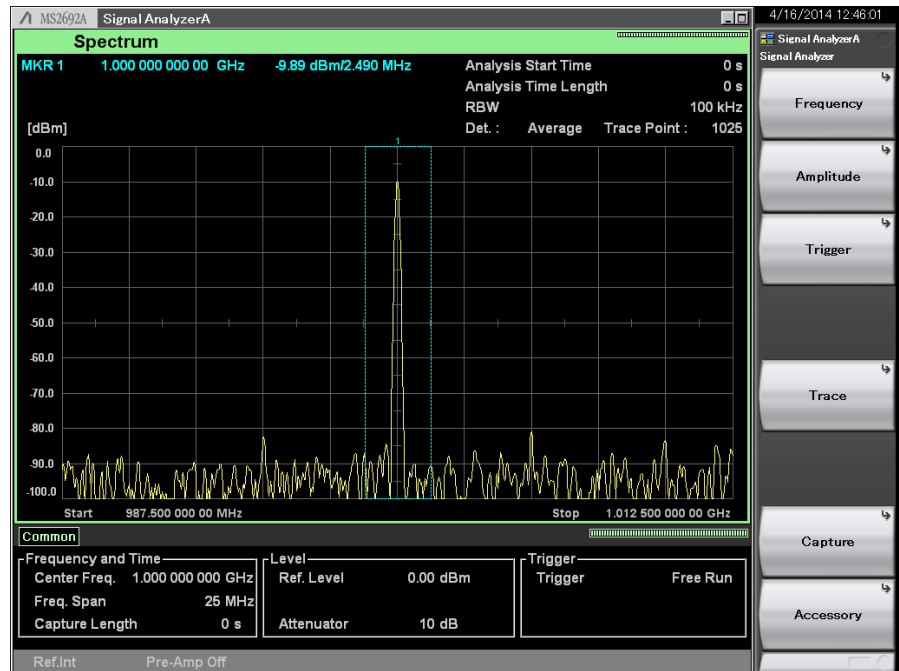

Figure 2.1-1 Main screen of Signal Analyzer function

The main function menu on the main screen is described below.

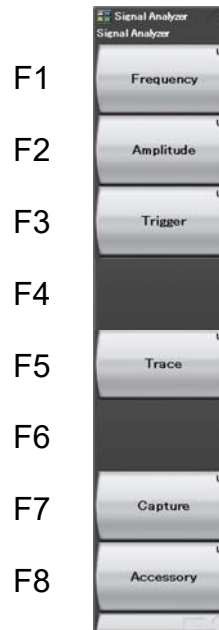

Figure 2.1-2 Main function menu

Table 2.1-1 Main function menu

Menu Display	Function
Frequency	Sets the frequency. 2.2 "Setting Frequency"
Amplitude	Sets the level. 2.3 "Setting Level"
Trigger	Sets the trigger. 3.2 "Trigger Function"
Trace	Configures the settings related to trace. "Chapter 4 Trace"
Capture	Used for setting related to IQ data capture. 2.4 "Setting IQ Data Capture Time Range"
Accessory	Sets up other functions. "Chapter 6 System Setting"

2.2 Setting Frequency

The Signal Analyzer function can set the following four measurement frequencies.

- Center frequency
- Frequency span
- Start frequency
- Stop frequency

Pressing **F1** (Frequency) from page 1 of the main function menu, or pressing **Frequency** displays the Frequency function menu.

Press the span setting key **Span** to set the frequency span.

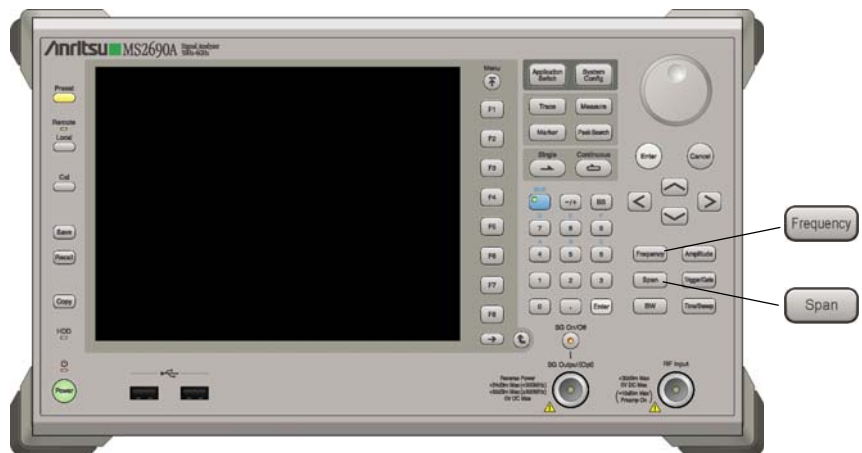

Figure 2.2-1 Frequency key and Span key





Figure 2.2-2 Frequency function menu

Table 2.2-1 Frequency function menu

Menu Display	Function
Frequency Page 1	Press F requency to display this menu.
Center	Sets the center frequency. 2.2.1 “Setting center frequency”
Start	Sets the start frequency. 2.2.3 “Setting start frequency”
Span	Sets the frequency span. 2.2.2 “Setting frequency span”
Stop	Sets the stop frequency. 2.2.4 “Setting stop frequency”
Preselector Auto Tune	Perform the preselector auto tuning. (displayed only for the MS2691A/ MS2692A). 6.7.1 “Preselector auto tuning”
Step Size	Sets the step size for center, start and stop frequency. 2.2.6 “Setting step size”
Frequency Band Mode (Spurious/Normal)	Selects the Spurious Mode (1-L band capture), or Normal Mode (normal capture) (displayed only for MS2691A/MS2692A with Option 003 installed). 2.2.5 “Setting frequency band”

Table 2.2-1 Frequency function menu (Cont'd)

Menu Display	Function
Frequency Page 2	Press Frequency , and then press  to display this menu.
Micro Wave Preselector Bypass	Enables/Disables the Micro Wave Preselector Bypass function. This function is available with MS2692A-067/167.  2.3.7 “Microwave Preselector Bypass”  1.3.7 “MS2692A-067/167” in the MS2690A/MS2691A/MS2692A Signal Analyzer Operation Manual (Mainframe Operation)

The display items related to the frequency parameters are described below.

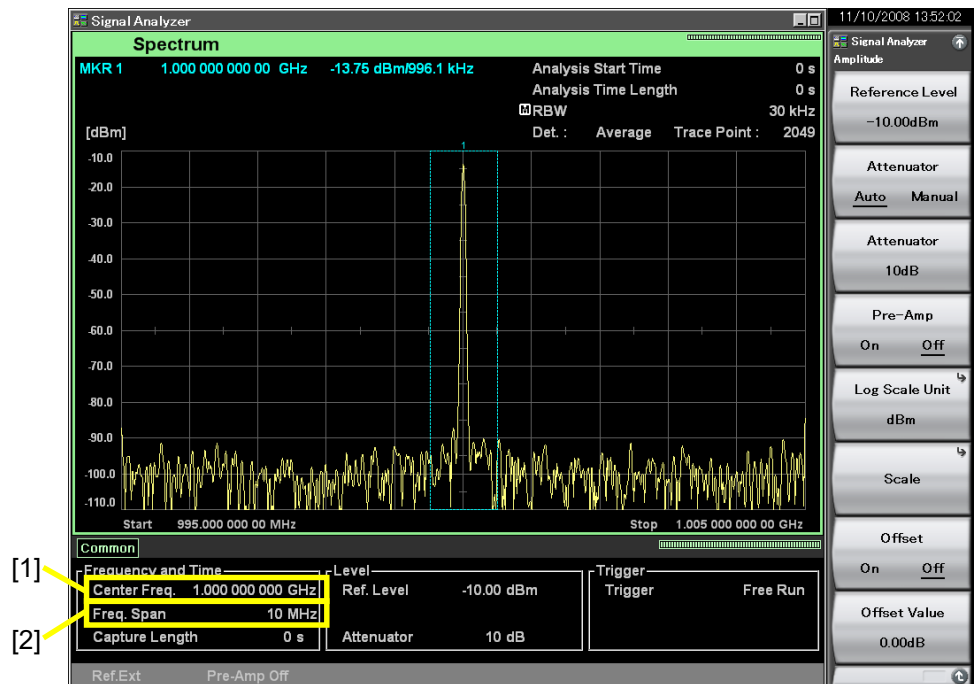

Figure 2.2-3 Display items related to frequency parameters

Table 2.2-2 Display items related to frequency parameters

No.	Display	Description
[1]	Center Freq. or Start Freq.	Displays the center frequency or start frequency.
[2]	Freq. Span	Displays the frequency span.

The relationships between the center frequency, frequency span, start frequency, and stop frequency are always as shown in Figure 2.2-4. When any of the center frequency, start frequency, stop frequency, and frequency span are set, the remaining 2 frequencies that have not been set are automatically set.

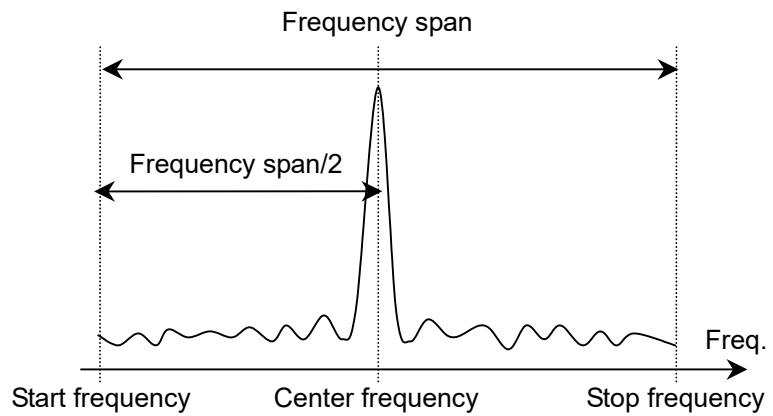

Figure 2.2-4 Center frequency, frequency span, start frequency, and stop frequency

Example: When the frequency span is set to 5 MHz, and the stop frequency to 1 GHz

Frequency span: 5 MHz

Stop frequency: 1 GHz





Start frequency: 995 MHz (auto setting)

Center frequency: 997.5 MHz (auto setting)

2.2.2 Setting frequency span

Example: To set the frequency span to 1 kHz

<Procedure>

1. Press , or press  (Span) from the Frequency function menu.
2. After pressing , press  (kHz) to set the frequency span.

Setting range and resolution for frequency span

Setting range: 1 kHz to 125 MHz

Rotary knob resolution: 1-2.5-5 step sequence [Hz]

Step key resolution: 1-2.5-5 step sequence [Hz]

The sampling rate of the IQ data is automatically set when the frequency span is set.

Table 2.2.2-1 Frequency span and sampling rate

Frequency Span	Sampling Rate
1 kHz	2 kHz
2.5 kHz	5 kHz
5 kHz	10 kHz
10 kHz	20 kHz
25 kHz	50 kHz
50 kHz	100 kHz
100 kHz	200 kHz
250 kHz	500 kHz
500 kHz	1 MHz
1 MHz	2 MHz
2.5 MHz	5 MHz
5 MHz	10 MHz
10 MHz	20 MHz
25 MHz	50 MHz
31.25 MHz	50 MHz
50 MHz ^{*1, *4}	100 MHz
62.5 MHz ^{*2, *4}	100 MHz
100 MHz ^{*3, *4}	200 MHz
125 MHz ^{*3, *4}	200 MHz

*1: 50 MHz can be set only when Option 004/104/077/177 is installed

*2: 62.5 MHz can be set only when Option 077/177 is installed.

*3: 100 MHz and 125 MHz can be set only when Option 004/104/078/178 is installed.

*4: Microwave Preselector is always bypassed if Frequency Span is 5 MHz or more.

 2.3.7 "Microwave Preselector Bypass"

Frequency Span can be set to a maximum of 31.25 MHz when Frequency Band Mode is set to Spurious.

The center/start/stop frequency setting ranges are limited, as shown below, when the frequency span is 50 MHz or more.

When the frequency span is 50 MHz or more(MS2690A/91A):

When the frequency span is 50 MHz or more (when Option 067/167 is not installed in the MS2692A):

The center frequency setting range: 100 MHz to 6 GHz

Start frequency setting range: $100\text{MHz} - \frac{x}{2}$ Hz to $6\text{GHz} - \frac{x}{2}$ Hz

Stop frequency setting range: $100\text{MHz} + \frac{x}{2}$ Hz to $6\text{GHz} + \frac{x}{2}$ Hz

When the frequency span is 50 MHz or more (when Option 067/167 is not installed in the MS2692A):

The center frequency setting range: 100 MHz to 26.5 GHz

Start frequency setting range: $100\text{MHz} - \frac{x}{2}$ Hz to $26\text{GHz} - \frac{x}{2}$ Hz

Stop frequency setting range: $100\text{MHz} + \frac{x}{2}$ Hz to $26\text{GHz} + \frac{x}{2}$ Hz





x : Frequency span [Hz]

 2.2.2 "Setting frequency span"

2.2.3 Setting start frequency

Example: To set the start frequency to 10 MHz

<Procedure>

1. Press .
2. Press  (Start).
3. After pressing  , press  (MHz) to set the start frequency.

Setting range and resolution for start frequency

Setting range: $-\frac{x}{2}$ Hz to $6\text{ GHz} - \frac{x}{2}$ Hz
(MS2690A)

$-\frac{x}{2}$ Hz to $13.5\text{ GHz} - \frac{x}{2}$ Hz
(MS2691A)

$-\frac{x}{2}$ Hz to $26.5\text{ GHz} - \frac{x}{2}$ Hz
(MS2692A)

Minimum resolution: 1 Hz

Rotary knob resolution: $\frac{x}{100}$ Hz

Up/down step key resolution:  2.2.6 "Setting step size"

Left/right step key resolution:  2.2.6 "Setting step size"

x : Frequency span [Hz]  2.2.2 "Setting frequency span"

Note:

The setting range is limited when the frequency span is 50 MHz or more. Refer to Section 2.2.2 "Setting frequency span" for details.

2.2.4 Setting stop frequency

Example: To set the stop frequency to 1 GHz

<Procedure>

1. Press .
2. Press  (Stop).
3. After pressing , press  (GHz) to set the stop frequency.

Setting range and resolution for stop frequency

Setting range: $\frac{x}{2}$ Hz to $6\text{ GHz} + \frac{x}{2}$ Hz
(MS2690A)

$\frac{x}{2}$ Hz to $13.5\text{ GHz} + \frac{x}{2}$ Hz
(MS2691A)

$\frac{x}{2}$ Hz to $26.5\text{ GHz} + \frac{x}{2}$ Hz
(MS2692A)

Minimum resolution: 1 Hz

Rotary knob resolution: $\frac{x}{100}$ Hz

Up/down step key resolution:  2.2.6 “Setting step size”

Left/right step key resolution:  2.2.6 “Setting step size”

x : Frequency span [Hz]  2.2.2 “Setting frequency span”

Note:

The setting range is limited when the frequency span is 50 MHz or more. Refer to Section 2.2.2 “Setting frequency span” for details.



2.2.5 Setting frequency band

Note:

This function can be used only when Option 003 Extension of Preselector Lower Limit to 3 GHz is installed.

When Option 003 Extension of Preselector Lower Limit to 3 GHz is installed, the passing lower limit frequency of the preselector can be changed from 6 GHz to 3 GHz by changing the frequency band mode. The setting procedure for the band mode is as follows.

<Procedure>

1. Press .
2. Press  (Frequency Band Mode).

When the frequency band mode is changed, the preselector passing frequency is changed, as shown in Table 2.2.5-1.

Table 2.2.5-1 Preselector passing lower limit frequency

Frequency Band Mode	Preselector Passing Frequency
Normal	> 6.0 GHz
Spurious	≥ 3.0 GHz

When the frequency band mode is set to Spurious, the preselector can be used for frequencies above 3.0 GHz as shown in Table 2.2.5-1.

The mode can only be set to Normal when the frequency span is set to 50 MHz or more.

2.2.6 Setting step size

The step size of the center, start and stop frequency can be set.

Example: To set the step size to 1 GHz.

<Procedure>

1. Press .
2. Press  (Step Size).
3. After pressing , press  (GHz) to set the stop frequency.

Setting range and resolution for step size

Setting range: 1 Hz to 6 GHz (MS2690A)
1 Hz to 13.5 GHz (MS2691A)
1 Hz to 26.5 GHz (MS2692A)

Minimum setting resolution: 1 Hz

Rotary knob resolution: $\frac{x}{100}$ Hz

Up/down step key resolution: $\frac{x}{10}$ Hz

Left/right step key resolution: x Hz

x : Frequency span [Hz]:  2.2.2 "Setting frequency span"

2.3 Setting Level

Pressing **F2** (Amplitude) from the main function menu, or pressing **Amplitude** displays the Amplitude function menu.



Figure 2.3-1 Amplitude key

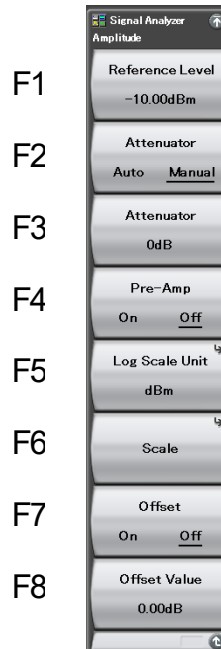













Figure 2.3-2 Amplitude function menu

Table 2.3-1 Amplitude function menu

Menu Display	Function
Amplitude Page 1	Press Amplitude to display this menu.
Reference Level	Sets the maximum level of the input signal.  2.3.1 "Setting reference level"
Attenuator (Auto/Manual)	Sets the input attenuator to the optimal value according to the reference level setting.  2.3.2 "Setting input attenuator"
Attenuator	Sets the input attenuator.  2.3.2 "Setting input attenuator"
Pre-Amp	Switches Pre-Amp On/Off.  2.3.6 "Pre-Amp"
Log Scale Unit	Sets the unit (Log scale) of the level axis.  2.3.4 "Setting reference level unit"
Scale	Sets the scale mode of the level axis.  2.3.3 "Setting scale"
Offset (On/Off)	Switches On/Off the reference level offset function.  2.3.5 "Setting reference level offset"
Offset Value	Sets the reference level offset value.  2.3.5 "Setting reference level offset"
Amplitude Page 2	Press Amplitude , and then press  to display this menu.
Micro Wave Preselector Bypass	Enables/Disables the Micro Wave Preselector Bypass function. This function is available with MS2692A-067/167.  2.3.7 "Microwave Preselector Bypass"  1.3.7 "MS2692A-067/167" in the <i>MS2690A/MS2691A/MS2692A Signal Analyzer Operation Manual (Mainframe Operation)</i>

The display items related to the level parameters are described below.

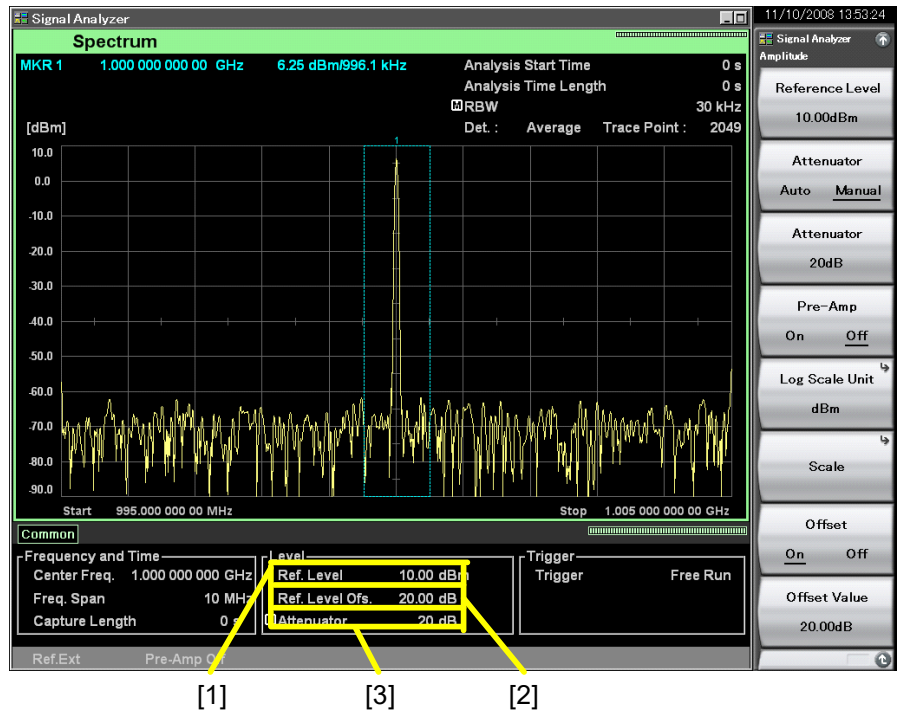

Figure 2.3-3 Display items related to level parameters

Table 2.3-2 Display items related to level parameters

No.	Display	Description
[1]	Ref. Level	Displays the reference level.
[2]	Ref. Level Ofs.	Displays the adding offset value of the reference level when the reference level offset function is On.
[3]	Attenuator	Displays the input attenuator value.

Table 2.3-3 and Table 2.3-4 show the level display modes of the Signal Analyzer function and the reference level (top of the amplitude scale) setting range of each mode.

Table 2.3-3 Reference level setting range (When Pre-Amp is set to Off)

Scale Mode	Unit	Reference Level Range
Log Scale	dBm	-120 to +50 dBm
	dB μ V	-13.01 to +156.99 dB μ V
	dBmV	-73.01 to +96.99 dBmV
	V	0.224 μ V to 70.7 V
	W	1 fW to 100 W
	dB μ V(emf)	-6.99 to +163.01 dB μ V (emf)
	dB μ V/m	-13.01 to +156.99 dB μ V/m
Linear Scale (in dBm)	V	22.4 μ V to 70.7 V (-80 to +50 dBm)

Table 2.3-4 Reference level setting range (When Pre-Amp is set to On)

Scale Mode	Unit	Reference Level Range
Log Scale	dBm	-120 to +30 dBm
	dB μ V	-13.01 to +136.99 dB μ V
	dBmV	-73.01 to +76.99 dBmV
	V	0.224 μ V to 7.07 V
	W	1 fW to 1W
	dB μ V (emf)	-6.99 to +143.01 dB μ V (emf)
	dB μ V/m	-13.01 to +136.99 dB μ V/m
Linear Scale (in dBm)	V	2.24 μ V to 7.07 V (-100 to +30 dBm)







- dBm: Unit system where 1 mW/50 Ω = 0 dBm.
- dB μ V: Unit system where 1 μ V = 0 dB μ V. Displayed with 50 Ω termination voltage.
- dBmV: Unit system where 1 mV = 0 dBmV. Displayed with 50 Ω termination voltage.
- dB μ V (emf): dB μ V unit system that uses open voltage display, where values are equal to dB μ V + 6 dB.
- dB μ V/m: Unit system that displays field intensity. Measurement values are the same as values when dB μ V is selected.

2.3.1 Setting reference level

The reference level (upper end of amplitude scale) can be set.

Example: To set the reference level to -10 dBm

<Procedure>

1. Press .
2. Press  (Reference Level).
3. After pressing   , press  (dBm) to set the reference level.

Setting range and resolution for reference level

Setting range:	Refer to Table 2.3-3.
Minimum resolution:	0.01 dB (dB unit system)
	Number of significant figures: 3 (in W)
	Number of significant figures: 3 (in V)
Rotary knob resolution:	Changes according parameter set in Scale .
Step key resolution:	Changes according parameter set in Scale .

2.3.2 Setting input attenuator

The input attenuator can be set.

(1) Auto mode

The input attenuator is automatically set according to the set reference level.

Table 2.3.2-1 and Table 2.3.2-2 show the settings in the Auto mode.

**Table 2.3.2-1 Input attenuators set in Auto mode
(When Pre-Amp is set to Off)**

$N =$ Reference Level (dBm)	Attenuator Auto (dB)
$-120 \leq N \leq 0$	10
$0 < N \leq 2$	12
$2 < N \leq 4$	14
$4 < N \leq 6$	16
$6 < N \leq 8$	18
$8 < N \leq 10$	20
$10 < N \leq 12$	22
$12 < N \leq 14$	24
$14 < N \leq 16$	26
$16 < N \leq 18$	28
$18 < N \leq 20$	30
$20 < N \leq 22$	32
$22 < N \leq 24$	34
$24 < N \leq 26$	36
$26 < N \leq 28$	38
$28 < N \leq 30$	40
$30 < N \leq 32$	42
$32 < N \leq 34$	44
$34 < N \leq 36$	46
$36 < N \leq 38$	48
$38 < N \leq 40$	50
$40 < N \leq 42$	52
$42 < N \leq 44$	54
$44 < N \leq 46$	56
$46 < N \leq 48$	58
$48 < N \leq 50$	60

**Table 2.3.2-2 Input attenuators set in Auto mode
(When Pre-Amp is set to On)**

N = Reference Level (dBm)	Attenuator Auto (dB)
$-120 \leq N \leq -20$	10
$-20 < N \leq -18$	12
$-18 < N \leq -16$	14
$-16 < N \leq -14$	16
$-14 < N \leq -12$	18
$-12 < N \leq -10$	20
$-10 < N \leq -8$	22
$-8 < N \leq -6$	24
$-6 < N \leq -4$	26
$-4 < N \leq -2$	28
$-2 < N \leq 0$	30
$0 < N \leq 2$	32
$2 < N \leq 4$	34
$4 < N \leq 6$	36
$6 < N \leq 8$	38
$8 < N \leq 10$	40
$10 < N \leq 12$	42
$12 < N \leq 14$	44
$14 < N \leq 16$	46
$16 < N \leq 18$	48
$18 < N \leq 20$	50
$20 < N \leq 22$	52
$22 < N \leq 24$	54
$24 < N \leq 26$	56
$26 < N \leq 28$	58
$28 < N \leq 30$	60

(2) Manual setting

In the Auto mode, the input attenuator is set so that the level can be measured with high accuracy, without any effect of gain compression, with a low noise level, when a signal at the same level as the reference level is input. However, to measure minute signals with increased sensitivity to measure non-harmonic spurious or proximity spurious of the signal, the attenuator value may be too high to measure with the specified sensitivity in the Auto mode. In this case, set the input attenuator in Manual setting.

The setting range of the input attenuator in Manual setting is as follows.

Setting range and resolution for input attenuator

Input attenuator setting range: Refer to Table 2.3.2-3 and Table 2.3.2-4.

Input attenuator minimum resolution: 2 dB

**Table 2.3.2-3 Input attenuator setting range
(When Pre-Amp is set to Off)**

Attenuator Manual	
Lower Limit	Upper Limit
Logic* ($\alpha = 0, \beta = 1, \gamma = 2$) The minimum value is 0 dB.	60 dB

**Table 2.3.2-4 Input attenuator setting range
(When Pre-Amp is set to On)**

Attenuator Manual	
Lower Limit	Upper Limit
Logic* ($\alpha = 20, \beta = 21, \gamma = 22$) The minimum value is 0 dB.	60 dB

*: The following rules apply:

<1> If the reference level is 0 or if it is divisible by 2.

$$\text{Attenuator (dB)} = \text{RL}^{*1} + \alpha$$

<2> Not <1>, and INT (RL)^{*2} is an odd number.

$$\text{Attenuator (dB)} = \text{INT (RL)}^{*2} + \beta$$

<3> Not <1>, and INT (RL)^{*2} is an even number.

$$\text{Attenuator (dB)} = \text{INT (RL)}^{*2} + \gamma$$

*1: Reference level (dBm)

*2: Maximum integer not exceeding reference level.

For measurement of second and third harmonic spurious, the mixer input level must be lowered to eliminate the effect of internal distortion. Internal distortion is below -75 dB (at 1 GHz) when the mixer input level is -30 dBm, so to measure harmonic spurious up to -75 dB, the mixer input level must be below -30 dBm. In this case, if the attenuator setting is Auto, the attenuator value is too small. Set the attenuator value manually.

Setting the input attenuator

Example: To set the input attenuator to 30 dB using the Auto mode

<Procedure>

1. Press **Amplitude**.
2. Press **F2** (Attenuator Auto/Manual) and select Auto.
3. Press **F1** (Reference Level).
4. After pressing **3** **0**, press **F1** (dBm). The input attenuator is set to 30 dB.

Example: To set the input attenuator to 30 dB using the Manual mode.

<Procedure>

1. Press **Amplitude**.
2. Press **F3** (Attenuator).
3. After pressing **3** **0**, press **F1** (dB) to set the input attenuator.

In Manual mode, the **M** icon is displayed.



Figure 2.3.2-1 Manual icon

Displaying Level Over

When the RF input signal level exceeds the specified value, distortion occurs and correct measurement values cannot be obtained. In this case, **↕ Level Over** is displayed on the screen. When **↕ Level Over** is displayed, lower the RF input signal level, or do the following:

- When the attenuator is in the Auto mode, increase the reference level until **↕ Level Over** disappears.
- When the attenuator is in the Manual mode, increase the attenuator until **↕ Level Over** disappears.

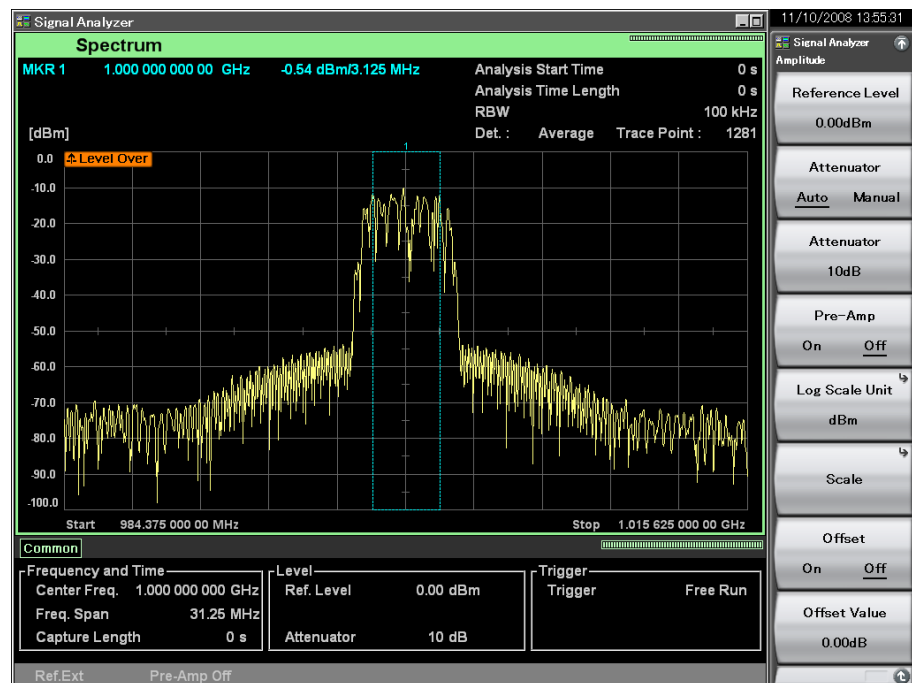

Figure 2.3.2-2 Level Over icon

2.3.3 Setting scale

Pressing **F6** (Scale) from the Amplitude function menu displays the Scale function menu.

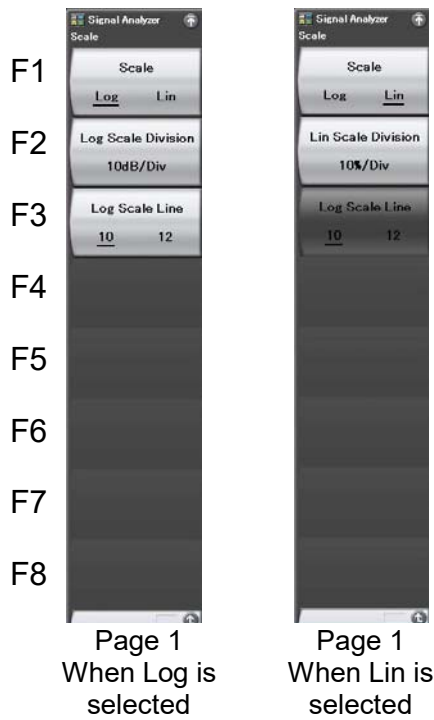

Figure 2.3.3-1 Scale function menu









Table 2.3.3-1 Scale function menu

Menu Display	Function
Scale (Log/Lin)	Sets the scale mode (Log/Lin). Cannot be set to Lin on Spectrogram trace.
Log Scale Division	Sets the scale range (Log scale range) of the vertical axis. Displayed only when trace is Spectrum or Power vs Time.
Lin Scale Division	Sets the scale range (Lin scale range) of the vertical axis. Displayed only when trace is Spectrum or Power vs Time.
Log Scale Line (10/12)	Sets the number of scale lines for Log scale. Displayed only when trace is Spectrum or Power vs Time.

(1) Setting the Log scale

Example: To set Log Scale Division to 20 dB/Div and the number of scale lines to 12

<Procedure>

1. Press .
2. Press  (Scale).
3. Press  (Scale Log/Lin) and select Log.
4. Press  (Log Scale Division).
5. After pressing  , press  (dB/Div) to set the Log Scale Division.
6. Press  (Log Scale Line) and set the number of scale lines by selecting 12.

Setting range and resolution for Log scale

Setting range: 0.1 to 20 dB/Div

Minimum resolution: 0.1 dB/Div







Rotary knob resolution: 1-2-5 sequence

Step key resolution: 1-2-5 sequence

(2) Setting the Lin scale

Example: To set Lin Scale Division to 5%/Div

<Procedure>

1. Press .
2. Press  (Scale).
3. Press  (Scale Log/Lin) and select Lin.
4. Press  (Lin Scale Division).
5. After pressing , press  (%/Div) to set the Lin Scale Division.

Setting range and resolution for Lin scale

Setting range: 1 to 10%/Div.

Minimum resolution: 1%/Div.

Rotary knob resolution: 1-2-5 sequence

Step key resolution: 1-2-5 sequence

2.3.4 Setting reference level unit









Note:

This function can be set only when the scale mode is Log.

In the Log scale, there are 7 types of units for the reference level: dBm, dB μ V, dBmV, dB μ V (emf), V, W, and dB μ V/m.

Example: To set the reference level to 10 dBmV

<Procedure>

1. Press .
2. Press  (Scale).
3. Press  (Scale Log/Lin) and select Log.
4. Return to the Amplitude function menu, press  (Log Scale Unit), and then press  (dBmV) to select the unit.
5. After pressing  , press  (dBmV) to set the reference level.

In the case of the Lin scale, no selection item is provided because the reference level unit is fixed to V for the Lin scale.

If V (W) is selected and a measurement result is more than 99.999 GV (GW), 99.999 GV (GW) is displayed.

2.3.5 Setting reference level offset

The reference level and waveform trace can be displayed with any offset value added.

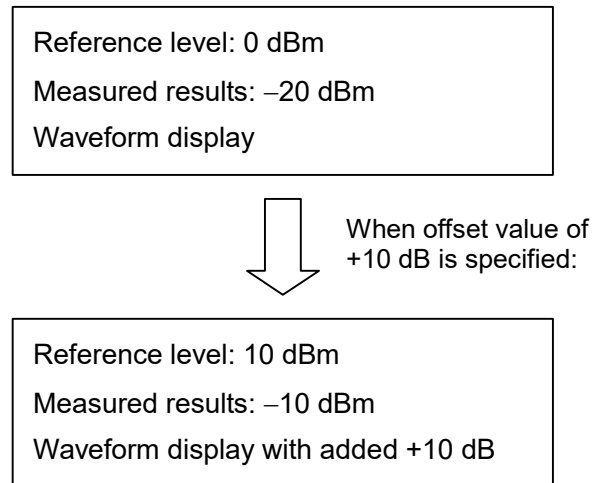

Figure 2.3.5-1 Adding an offset value

Example: To set the reference level offset value to 10 dB

<Procedure>

1. Press **Amplitude**.
2. Press **F8** (Offset Value).
3. After pressing **1** **0**, press **F7** (Set) to set the reference level offset value.

When a value is input, **F7** (Offset On/Off) is set to On.

Setting range and resolution for reference level offset

Setting range:	-100 to 100 dB
Minimum resolution:	0.01 dB
Rotary knob resolution:	1 dB
Step key resolution:	10 dB

2.3.6 Pre-Amp



Note:

This function can be set only when Option 008 6 GHz Pre-Amp is installed.

The level sensitivity can be increased by setting Pre-Amp to On.

Example: To set Pre-Amp to On

<Procedure>

1. Press .
2. Press  (Pre-Amp) to set to On.

2.3.7 Microwave Preselector Bypass

Note:



This function is available when installing Option 067 Microwave Preselector Bypass.

The frequency characteristics can be improved at 6 GHz or more of the preselector band when setting preselector Bypass to On.

If Frequency Span is 50 MHz or more, the microwave preselector is bypassed regardless of this setting.

Example: To set Preselector Bypass to On

<Procedure>

1. Press .
2. Pressing  displays the page 2 of Frequency or Amplitude function menu.
3. Pressing  (Micro Wave Preselector Bypass) sets Preselector Bypass to On.

2.4 Setting IQ Data Capture Time Range

The IQ data capture time range of the Signal Analyzer function can be set. Normally set the auto setting to obtain the optimal value.







Pressing  (Capture) from the main function menu displays the Capture function menu.

Table 2.4-1 Capture function menu

Function key	Menu Display	Function
F1	Capture Time (Auto/Manual)	Switches the capture time of the RF input signal between auto setting and manual setting.  2.4.1 "Setting capture time"
F2	Capture Time Length	Sets the capture time length of the RF input signal.  2.4.1 "Setting capture time"
F3	Save Captured Data	Saves the captured IQ data.  5.1 "Saving IQ Data"
F4	Replay	Replays the saved IQ data.  5.2 "Replay Function"
F5	Stop Replaying	Stops replaying the saved IQ data.  5.2.5 "Stopping Replay function"
F6	Capture & Playback	Performs settings to convert the saved IQ data into waveform patterns and to output them from vector signal generator option.  5.3 "Playback Function"

2.4.1 Setting capture time

The capture time length can be set.

(1) Auto

The required time range for the shortest measurement time is automatically set based on the current setting. Upon parameter changes, no re-analysis of the captured IQ data is performed, and capture of the RF signal is started again.

In the Signal Analyzer function, the initial value is Auto mode.

(2) Manual

In normal measurement, measurement can be executed without any special setting if Capture Time is set to Auto. However, to perform the following analysis for the same captured IQ data, set Capture Time to Manual.

- Changing the time range to analyze the same IQ data
- Analyzing the same IQ data with a different trace

Table 2.4.1-1 shows the setting range when Capture Time is set to Manual.





Table 2.4.1-1 Frequency span, resolution, and setting range when Capture Time is Manual

Frequency Span	Resolution	Minimum Value	Maximum Value
1 kHz	500 μs	50 ms	2000 s
2.5 kHz	200 μs	20 ms	2000 s
5 kHz	100 μs	10 ms	2000 s
10 kHz	50 μs	5 ms	2000 s
25 kHz	20 μs	2 ms	2000 s
50 kHz	10 μs	1 ms	1000 s
100 kHz	5 μs	500 μs	500 s
250 kHz	2 μs	200 μs	200 s
500 kHz	1 μs	100 μs	100 s
1 MHz	500 ns	50 μs	50 s
2.5 MHz	200 ns	20 μs	20 s
5 MHz	100 ns	10 μs	10 s
10 MHz	50 ns	5 μs	5 s
25 MHz	20 ns	2 μs	2 s
31.25 MHz	20 ns	2 μs	2 s
50 MHz*1	10 ns	1 μs	500 ms
62.5 MHz*2	10 ns	1 μs	500 ms
100 MHz*3	5 ns	500 ns	500 ms
125 MHz*3	5 ns	500 ns	500 ms

- *1: 50 MHz can be set only when Option 004/104/077/177 is installed.
- *2: 62.5 MHz can be set only when Option 077/177 is installed.
- *3: 100 MHz and 125 MHz can be set only when Option 004/104/078/178 is installed.

Example: To set the capture time length to 50 ms

<Procedure>

1. Press  (Capture) on the main function menu.
2. Press  (Capture Time Length).
3. After pressing  , press  (ms) to set the capture start time length.

2.4.2 Recapture and Reanalysis

The MS2690A/MS2691A/MS2692A can capture and save IQ data for a certain time interval to analyze the data many times. This can be used for analysis of the same IQ data with different parameters.

Reanalysis

In Capture Time Manual, when the setting is changed after the obtained IQ data is analyzed with the setting, analysis is performed again, using the same IQ data with newly set parameters. For the Signal Analyzer function, this operation is called “reanalysis.”

However, when some parameters are changed, analysis may not be performed with the captured IQ data. In this case, data recapture is performed.

Recapture

If the conditions change from the ones in which the IQ data was obtained due to parameter changes, or if the obtained IQ data length is not sufficient for the analysis, IQ data must be obtained again. For the Signal Analyzer function, this operation is called “re-capture.”

Time setting and recapture

Recapture may or may not be performed depending on the setting of Capture Time (Auto/Manual).

When the Capture Time is Auto, when data required for calculation changes according to the setting of each trace, the Capture Time is not changed, but the data length actually required for analysis is changed, so recapture is performed.

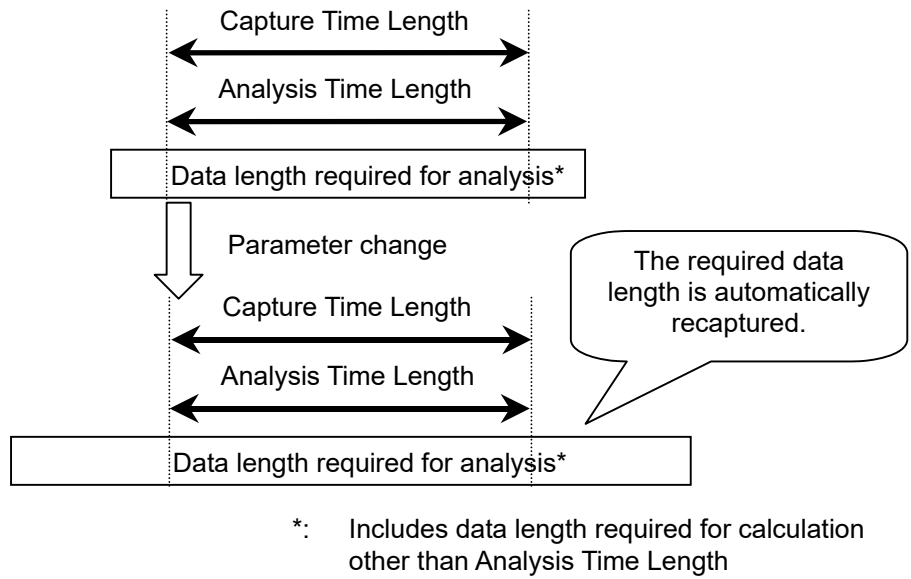

Figure 2.4.2-1 When Capture Time = Auto and Analysis Time = Auto

Also, when the Analysis Time is set manually, the Capture Time is automatically changed and the IQ data is recaptured.

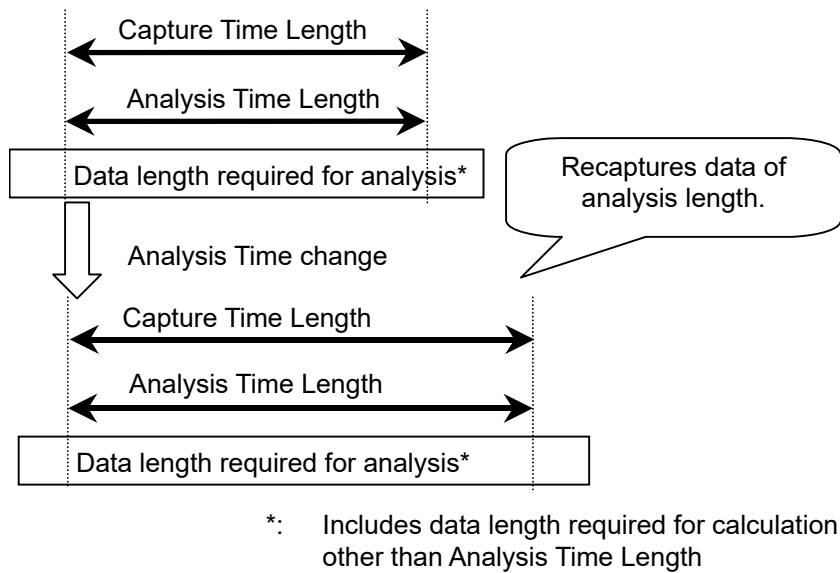
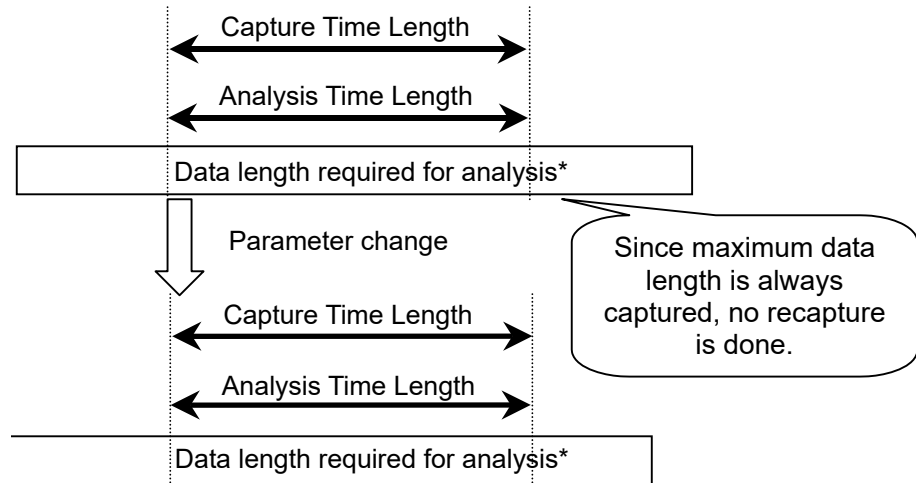

Figure 2.4.2-2 When Capture Time = Auto and Analysis Time = Manual

In addition, recapture is always performed, even if the data length is sufficient, such as the shorter Analysis Time.

On the other hand, when the Capture Time is Manual, the maximum value required for calculation is always captured. Therefore, reanalysis can be performed without recapture, except for changes of the specific parameters.



*: Includes data length required for calculation other than Analysis Time Length

Figure 2.4.2-3 When Capture Time = Manual and Analysis Time = Auto

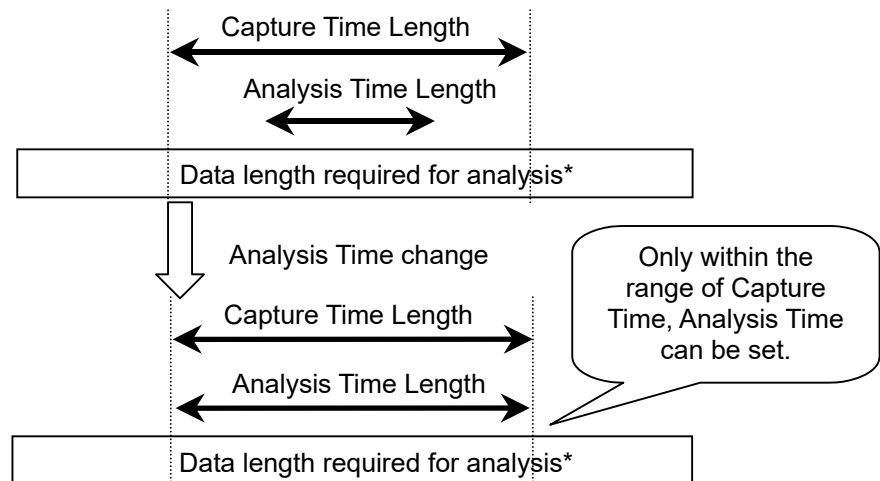

*: Includes data length required for calculation other than Analysis Time Length

Figure 2.4.2-4 When Capture Time = Manual and Analysis Time = Manual

2.4.3 Parameters recaptured when Capture Time is set to Manual

Some parameters may be recaptured and/or reanalyzed when they are changed.

Table 2.4.3-1 through Table 2.4.3-7 list the parameters that are recaptured upon a change.

Table 2.4.3-1 Common parameters recaptured upon a change

Parameter
Center Frequency
Start Frequency
Stop Frequency
Frequency Span
Preselector Auto Tune
Frequency Band Spurious Mode
Reference Level
Pre-Amp
Attenuator
Trigger Switch
Trigger Source
Trigger Slope
Trigger Level (Video)
Trigger Level (Wide IF Video)
Trigger Delay
Capture Time
Capture Time Length
Reference Clock
Reference Clock Preset
Preselector Manual
Preselector Tune Preset

Table 2.4.3-2 Common parameters recaptured upon a change in spectrum trace

Parameter
Marker to Center Freq.
Marker to Ref. Level
Standard
Load Standard Parameter
Noise Cancel

Table 2.4.3-3 Common parameters recaptured upon a change in Power vs Time

Parameter
Standard
Load Standard Parameter
Noise Cancel

Table 2.4.3-4 Common parameters recaptured upon a change in Frequency vs Time

Parameter
None

Table 2.4.3-5 Common parameters recaptured upon a change in Phase vs Time

Parameter
None

Table 2.4.3-6 Common parameters recaptured upon a change in CCDF

Parameter
None

Table 2.4.3-7 Common parameters recaptured upon a change in Spectrogram

Parameter
Marker to Center Freq
Marker to Ref. Level

Chapter 3 Selecting Waveform Capture Method

This chapter describes waveform capture methods and capture methods using triggers.

3.1	Single/Continuous Measurement.....	3-2
3.1.1	Continuous measurement mode	3-2
3.1.2	Single measurement mode	3-2
3.2	Trigger Function.....	3-3
3.2.1	Normal measurement.....	3-6
3.2.2	Trigger measurement	3-7

3.1 Single/Continuous Measurement

The capture mode (waveform capture method) of the Signal Analyzer function can be set with  .



Figure 3.1-1 Single key and Continuous key

3.1.1 Continuous measurement mode

When the trigger function is Off, measurement is executed continuously. When the trigger function is On, measurement is executed each time the trigger conditions are met.

The Continuous Measurement mode is set by pressing  (the Continuous Measurement mode is set in the initial state).

3.1.2 Single measurement mode

When the trigger function is Off, measurement is executed once when  is pressed.

When the trigger function is “Triggered”, measurement is executed once when the trigger conditions are met after  is pressed.

The Single Measurement mode is set by pressing  (measurement starts).

3.2 Trigger Function

The trigger functions of the Signal Analyzer function include normal measurement and trigger measurement.

For trigger measurement, Video, Wide IF Video, SG Marker, BBIF and External can be selected as a trigger source.

Pressing **F3** (Trigger) from the main function menu, or pressing **Trigger/Gate** displays the Trigger function menu.



Figure 3.2-1 Trigger/Gate key

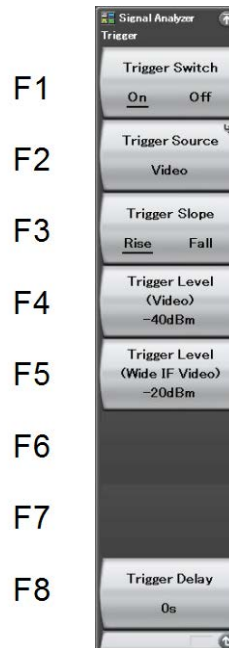







Figure 3.2-2 Trigger function menu

Table 3.2-1 Trigger function menu

Menu Display	Function
Trigger Switch (On/Off)	Sets the capture start condition.  3.2.1 “Normal measurement”
Trigger Source	Selects the trigger source.  3.2.2 “Trigger measurement”
Trigger Slope (Rise/Fall)	Selects the edge where the trigger is generated (rise or fall).  3.2.2 “Trigger measurement”
Trigger Level (Video)	Sets the trigger level for the video trigger.  3.2.2 “Trigger measurement”
Trigger Level (Wide IF Video)	Selects the trigger level for the wide IF video trigger.  3.2.2 “Trigger measurement”
Trigger Delay	Sets the delay time from the trigger input until capture is started.  3.2.2 “Trigger measurement”

The display items related to the trigger parameters are described below.

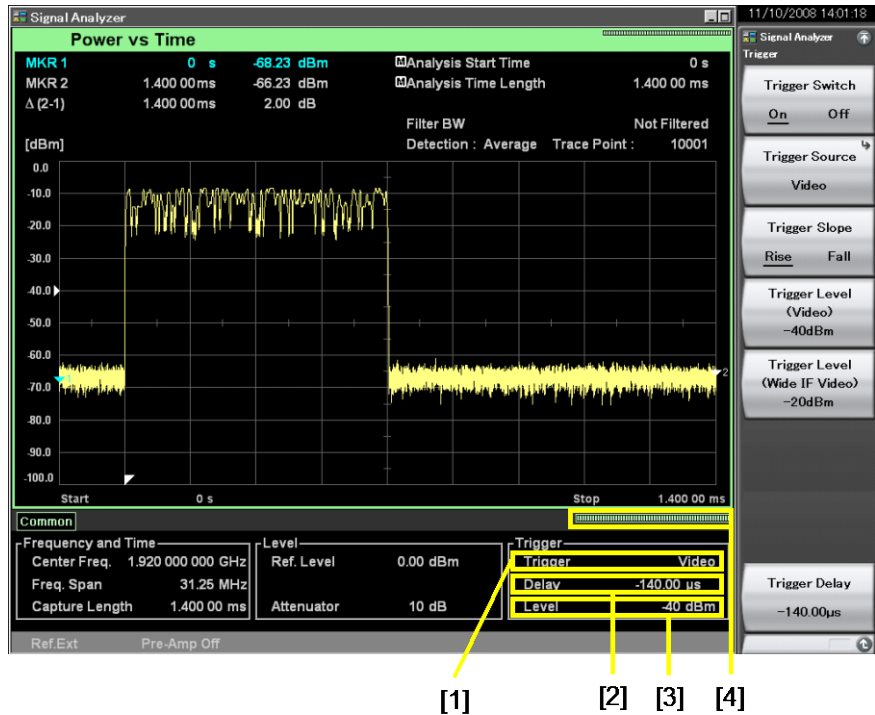



Figure 3.2-3 Display items related to trigger parameters



Table 3.2-2 Display items related to trigger parameters

No.	Display	Description
[1]	Trigger	Displays the trigger source. “Free Run” is displayed in normal measurement.
[2]	Delay	Displays the trigger delay time. It is not displayed in normal measurement.
[3]	Level	Displays the trigger level. It is not displayed in normal measurement and when the trigger source is other than Video or Wide IF Video.
[4]	Capture Indicator	Indicates the capture progress of the current IQ data.

3.2.1 Normal measurement

In the continuous measurement mode, waveforms are captured repeatedly and continuously. In the single measurement mode, a waveform is captured when  is pressed.

<Procedure>

1. Press .
2. Press  (Trigger Switch On/Off) and select Off to set the normal capture.

Note:

Digitizing should be executed after a single sweeping has been executed and ended, even when trigger function is used.

3.2.2 Trigger measurement

Measurement starts when the conditions for the selected trigger source are met.

The following five types of triggers are available:













- Video trigger
- Wide IF video trigger
- SG marker trigger
- External trigger
- BBIF trigger

(1) Video trigger

Waveform capture starts in synchronization with the rise or fall of the waveform.

Operation example: Setting the trigger level to -40 dBm, trigger delay to 2 s, and trigger slope to Rise

<Procedure>

1. Press .
2. Press  (Trigger Source) and then press  (Video).
3. After pressing   , press  (dBm) to set the trigger level.
4. Press  to return to the original menu.
5. Press  (Trigger Delay).
6. After pressing , press  (s) to set the trigger delay.
7. Press  (Trigger Slope) and select Rise.

Setting range and resolution for trigger level (video)

Setting range:	-150 to $+50$ dBm (Log scale) 0 to 100% (Lin scale)
Minimum resolution:	1 dBm (Log scale) 1% (Lin scale)
Rotary knob resolution:	1 dBm (Log scale) 1% (Lin scale)
Step key resolution:	10 dBm (Log scale) 10% (Lin scale)

Setting range and resolution for trigger delay

Table 3.2.2-1 shows the setting range and resolution for the trigger delay.

Table 3.2.2-1 Resolution and setting range for trigger delay

Frequency Span	Resolution	Minimum Value	Maximum Value
1 kHz	500 μ s	-2000 s	2000 s
2.5 kHz	200 μ s	-2000 s	2000 s
5 kHz	100 μ s	-2000 s	2000 s
10 kHz	50 μ s	-2000 s	2000 s
25 kHz	20 μ s	-2000 s	2000 s
50 kHz	10 μ s	-1000 s	1000 s
100 kHz	5 μ s	-500 s	500 s
250 kHz	2 μ s	-200 s	200 s
500 kHz	1 μ s	-100 s	100 s
1 MHz	500 ns	-50 s	50 s
2.5 MHz	200 ns	-20 s	20 s
5 MHz	100 ns	-10 s	10 s
10 MHz	50 ns	-5 s	5 s
25 MHz	20 ns	-2 s	2 s
31.25 MHz	20 ns	-2 s	2 s
50 MHz* ¹	10 ns	-500 ms	500 ms
62.5 MHz* ²	10 ns	-500 ms	500 ms
100 MHz* ³	5 ns	-500 ms	500 ms
125 MHz* ³	5 ns	-500 ms	500 ms

*1: 50 MHz can be set only when Option 004/104/077/177 is installed.

*2: 62.5 MHz can be set only when Option 077/177 is installed.











*3: 100 MHz and 125 MHz can be set only when Option 004/104/078/178 is installed.

(2) Wide IF video trigger

An IF signal with a wide passing band of about 50 MHz or greater is detected, and waveform capture starts in synchronization with the rise or fall of the detected signal.

Operation example: Setting the trigger level to –30 dBm and trigger slope to Fall

<Procedure>

1. Press .
2. Press  (Trigger Source) and then press  (Wide IF Video).
3. Press  (Trigger Level Wide IF Video). (Pressing  returns to the original menu.)
4. After pressing   , press  (dBm) to set the trigger level.
5. Press  (Trigger Slope) and select Fall.

Setting range and resolution for trigger level (wide IF video)

Setting range:	–60 to 50 dBm
Minimum resolution:	1 dBm
Rotary knob resolution:	1 dBm
Step key resolution:	10 dBm

Setting range and minimum resolution for trigger delay

As shown in Table 3.2.2-1.

(3) SG marker trigger





Note:

This function can be set only when Option 020 Vector Signal Generator is installed.

The measurement of the MS2690A/MS2691A/MS2692A is started in synchronization with the rise or fall of the marker signal output of the Vector Signal Generator (SG option). This function allows measurement in sync with the output signal of the SG option. The marker signal setting and the meaning of the marker signal vary depending on the output signal selected in the SG option. For details, refer to “MS2690A/MS2691A/MS2692A Option 020 Vector Signal Generator Operation Manual.”

Operation example: Setting the SG marker trigger

<Procedure>

1. Press .
2. Press  (Trigger Source) and then press  (SG Marker).
Press  to return to the original menu.
3. Press  (Trigger Slope) to select either Rise or Fall.

Setting range and resolution for trigger delay

As shown in Table 3.2.2-1.

(4) External trigger

Measurement starts in synchronization with the rise or fall of the waveform of the signal input via the Ext Input connector on the rear panel.

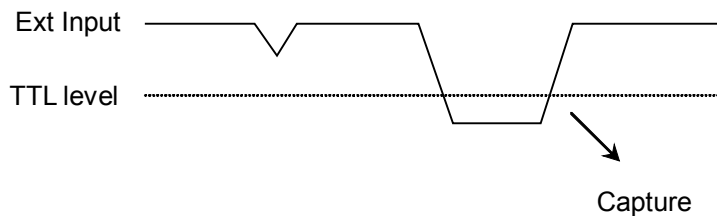





Figure 3.2.2-1 When Trigger Slope = Rise

Operation example: Setting the external trigger

<Procedure>

1. Press .
2. Press  (Trigger Source) and select External.
3. Press  (Trigger Slope) to select either Rise or Fall.

Setting range and resolution for trigger delay

As shown in Table 3.2.2-1.

(5) BBIF trigger





Note:

This function is unavailable when the Option 040/140 Baseband Interface Unit (hereafter Option 040/140) is not installed or the software package is Ver.6.00.00 or later.

The measurement of the MS2690A/MS2691A/MS2692A is started in synchronization with the rise or fall of the marker signal output of the Baseband Interface Unit. For the settings of Trigger signals, refer to “MX269041A Digital I/F Control Software for DigRF2.5G/3G Operation Manual (BBIF Operation)”.

Operation example: Setting the BBIF trigger

<Procedure>

1. Press .
2. Press  (Trigger Source) and then press  (BBIF). Press  to return to the original menu.
3. Press  (Trigger Slope) to select either Rise or Fall.

Displaying the trigger indicator

When waiting for a trigger input, the trigger indicator **Trigger Wait...** is displayed on the screen.



Trigger indicator

Figure 3.2.2-2 Trigger indicator

Chapter 4 Trace

This chapter describes the parameters and measurements for each trace.

4.1	Selecting Trace.....	4-3
4.2	Spectrum	4-5
4.2.1	What is Spectrum trace?.....	4-5
4.2.2	Setting spectrum parameters.....	4-7
4.2.3	Setting analysis time	4-9
4.2.4	Setting scale	4-13
4.2.5	Setting resolution bandwidth (RBW).....	4-18
4.2.6	Setting storage mode	4-22
4.2.7	Setting detection mode.....	4-27
4.2.8	Setting markers.....	4-30
4.2.9	Setting marker search	4-40
4.2.10	Measure measurement	4-50
4.2.11	Executing Return to Spectrogram.....	4-69
4.3	Power vs Time	4-71
4.3.1	What is Power vs Time trace?.....	4-71
4.3.2	Setting Power vs Time parameters.....	4-72
4.3.3	Setting analysis time	4-74
4.3.4	Setting scale	4-78
4.3.5	Setting filter.....	4-81
4.3.6	Setting smoothing	4-87
4.3.7	Setting storage mode	4-89
4.3.8	Setting detection mode.....	4-93
4.3.9	Setting markers.....	4-95
4.3.10	Setting marker search	4-104
4.3.11	Measure measurement	4-109
4.4	Frequency vs Time	4-118
4.4.1	What is Frequency vs Time trace?	4-118
4.4.2	Setting Frequency vs Time parameters	4-119
4.4.3	Setting analysis time	4-121
4.4.4	Setting scale	4-125
4.4.5	Setting filter.....	4-128
4.4.6	Setting smoothing	4-130
4.4.7	Setting storage mode	4-132
4.4.8	Setting detection mode.....	4-135
4.4.9	Setting markers.....	4-137
4.4.10	Setting marker search	4-145
4.4.11	Measure measurement	4-150
4.5	Phase vs Time.....	4-152
4.5.1	What is Phase vs Time trace?.....	4-157
4.5.2	Setting Phase vs Time parameter.....	4-158
4.5.3	Setting analysis time	4-160

	4.5.4	Setting scale	4-164
	4.5.5	Setting detection mode.....	4-166
	4.5.6	Setting markers.....	4-167
	4.5.7	Setting methods	4-173
4.6	CCDF		4-175
	4.6.1	What is CCDF trace?	4-175
	4.6.2	Setting CCDF parameters	4-177
	4.6.3	Selecting measurement method	4-179
	4.6.4	Setting analysis time	4-182
	4.6.5	Setting range	4-189
	4.6.6	Setting display format.....	4-190
	4.6.7	Setting cumulative data reset	4-191
	4.6.8	Setting Trace Display	4-193
	4.6.9	Setting filter.....	4-194
	4.6.10	Setting markers.....	4-196
4.7	Spectrogram		4-200
	4.7.1	What is Spectrogram Trace?.....	4-200
	4.7.2	Setting Spectrogram Parameter	4-201
	4.7.3	Setting Analysis Time.....	4-203
	4.7.4	Setting Scale.....	4-207
	4.7.5	Setting Resolution Bandwidth (RBW)	4-208
	4.7.6	Setting Storage Mode.....	4-209
	4.7.7	Setting Detection Mode	4-211
	4.7.8	Setting Marker.....	4-212
4.8	No Trace.....		4-221
	4.8.1	What is No Trace?	4-221
	4.8.2	Setting No Trace parameters.....	4-222
	4.8.3	Setting Analysis Time.....	4-223
4.9	Sub-Trace.....		4-227
	4.9.1	What is Sub Trace?.....	4-227
	4.9.2	Setting parameters for Sub Trace.....	4-228
	4.9.3	Selecting Sub Trace	4-230
	4.9.4	Setting analysis time	4-231
	4.9.5	Setting scale	4-233
	4.9.6	Setting resolution bandwidth (RBW)	4-234
	4.9.7	Setting detection mode.....	4-235

4.1 Selecting Trace

Pressing **F5** (Trace) on the main function menu, or pressing **Trace** and then **F1** (Trace Mode) displays the Trace Mode function menu. The trace type can be selected from this menu.



Figure 4.1-1 Trace key

4

Trace

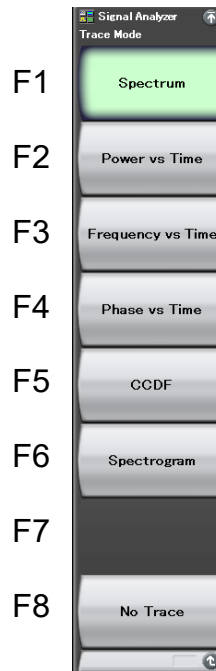









Figure 4.1-2 Trace Mode function menu

Table 4.1-1 Trace Mode function menu

Menu Display	Function
Spectrum	Spectrum trace.  4.2 “Spectrum”
Power vs Time	Displays Power vs Time trace.  4.3 “Power vs Time”
Frequency vs Time	Displays Frequency vs Time trace.  4.4 “Frequency vs Time”
Phase vs Time	Displays Phase vs Time trace.  4.5 “Phase vs Time”
CCDF	Displays CCDF trace.  4.6 “CCDF”
Spectrogram	Displays Spectrogram trace.  4.7 “Spectrogram”
No Trace	No trace. This function captures signals without executing analysis.  4.8 “No Trace”

4.2 Spectrum

4.2.1 What is Spectrum trace?

Spectrum trace is a screen that converts captured IQ data from time domain data to frequency domain data by fast Fourier transformation (FFT) processing to display a spectrum.

The display items for a spectrum trace are described below.

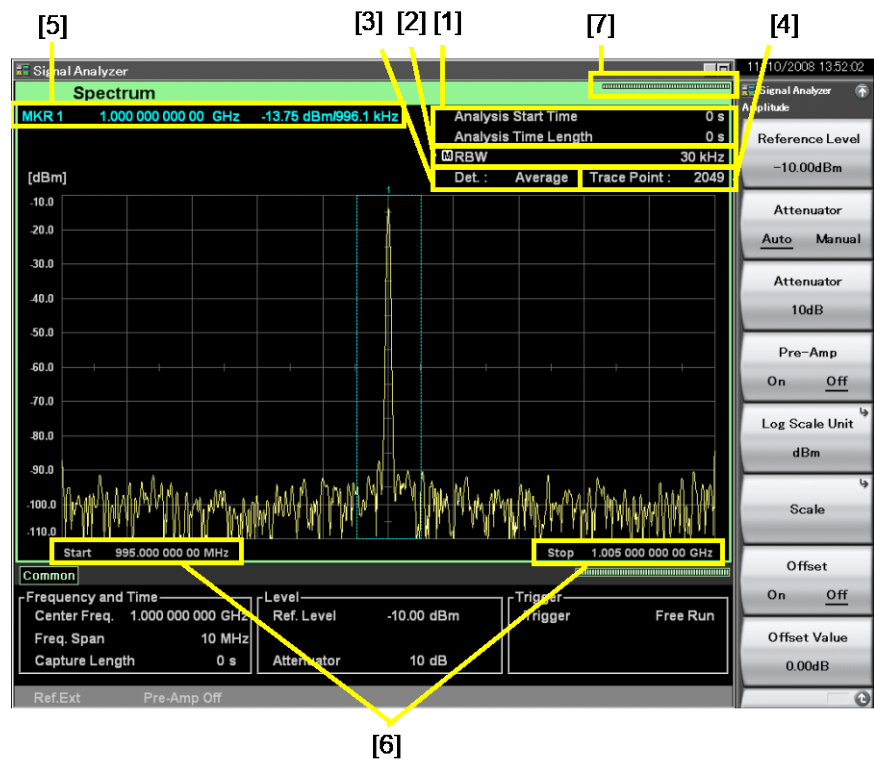

4

Trace

Figure 4.2.1-1 Display items for spectrum trace

Table 4.2.1-1 Display items for spectrum trace

No.	Display	Descriptions
[1]	Analysis Start Time/ Analysis Time Length	Displays the analysis start time and analysis time length.
[2]	RBW	Displays the resolution bandwidth (RBW).
[3]	Det.	Displays the detection mode.
[4]	Trace Point	Displays the trace point count (horizontal axis).
[5]	MKR*/ $\Delta(* - *)$	Displays the marker result value and marker frequency.
[6]	Start/Stop	Displays the start frequency and stop frequency.
[7]	Indicator	Displays the indicator showing the analysis progress rate.

4.2.2 Setting spectrum parameters

After selecting Spectrum for Trace Mode, pressing **PF6** (Trace) from the main function menu or pressing **Trace** displays the Trace function menu.

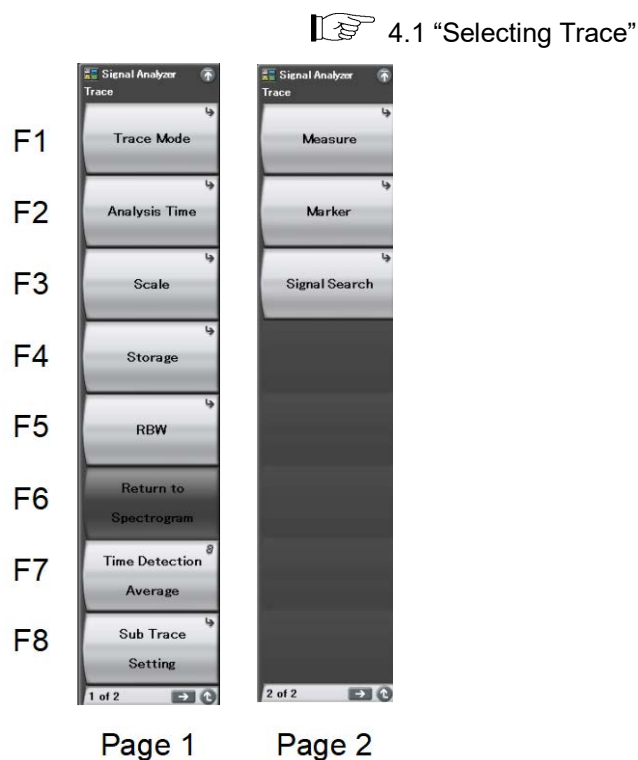







Figure 4.2.2-1 Trace function menu

Table 4.2.2-1 Trace function menu

Menu Display	Function
Trace Mode	Sets the trace type. ☞ 4.1 “Selecting Trace”
Analysis Time	Used for setting related to analysis time. ☞ 4.2.3 “Setting analysis time”
Scale	Used for setting related to the scale. ☞ 4.2.4 “Setting scale”
Storage	Used for setting related to the update and display of trace data. ☞ 4.2.6 “Setting storage mode”
RBW	Used for setting related to RBW. ☞ 4.2.5 “Setting resolution bandwidth (RBW)”
Return to Spectrogram	Used for executing Return to Spectrogram function. ☞ 4.2.11 “Executing Return to Spectrogram”

Table 4.2.2-1 Trace function menu (Cont'd)

Menu Display	Function
Time Detection	Used for setting related to detection.  4.2.7 "Setting detection mode"
Sub Trace Setting	Used for setting related to sub-trace.  4.9 "Sub-Trace"
Measure	Used for setting related to the Measure function.  4.2.10 "Measure measurement"
Marker	Used for setting related to markers.  4.2.8 "Setting markers"
Signal Search	Used for setting related to feature-point search within the measurement band.  4.2.9 "Setting marker search"

4.2.3 Setting analysis time

Pressing **F2** (Analysis Time) on the Trace function menu, or pressing **Time/Sweep** displays the Analysis Time function menu.

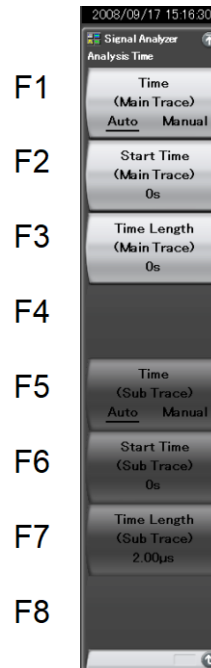

Figure 4.2.3-1 Analysis Time function menu

Table 4.2.3-1 Analysis Time function menu

Menu Display	Function
Time (Main Trace) (Auto/Manual)	Switches between auto setting and manual setting for the analysis start time and analysis time length.
Start Time (Main Trace)	Sets the analysis start time.
Time Length (Main Trace)	Sets the analysis time length.
Time (Sub Trace) (Auto/Manual)	Switches between auto setting and manual setting of the analysis start time (Analysis Start Time) and analysis time length (Analysis Time Length) of a sub-trace.
Start Time (Sub Trace)	Sets the analysis start time of a sub-trace.
Time Length (Sub Trace)	Sets the analysis time length of a sub-trace.

Setting analysis time

Analysis time is the target time range for spectrum trace analysis. The analysis time is specified with the analysis start position (Analysis Start Time) and analysis time length (Analysis Time Length).

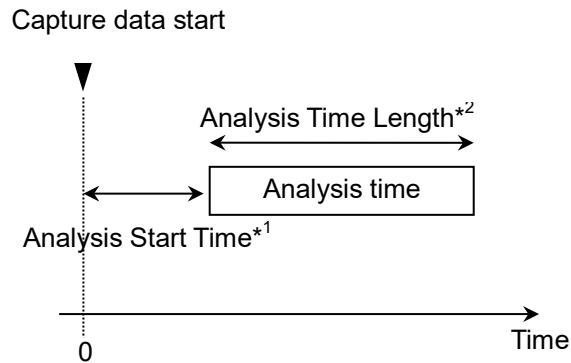

*1: Start of Analysis time based on capture data start

*2: Length of analysis time

Figure 4.2.3-2 Analysis time

The Auto mode and Manual mode can be specified for setting the analysis time. The following describes the differences between the Auto and Manual modes.

(1) Auto mode

When Capture Time is set to Auto, the analysis start time and analysis time length are automatically set to make the measurement time shortest. The Auto mode sets the minimum analysis time so that the analysis speed is the fastest. While the speed is the highest, variations of measurement values become greater in the measurement of modulation signals and noises where sufficient averaging of spectrum measurement is required. Therefore, to perform sufficient averaging of spectrum measurement, use the Manual mode.

When Capture Time is set to Manual, the capture time set in Capture Time Length is set as the analysis time length. Therefore, all of the captured IQ data is used for analysis.

Table 4.2.3-2 Setting analysis time in Auto mode

Capture Time	Analysis Start Time [s]	Analysis Time Length [s]
Auto	0	0
Manual	0	x_1

x_1 : Capture time length [s]

 2.4 “Setting IQ Data Capture Time Range”

(2) Manual mode

The analysis start time and analysis time length are set manually. This is an effective method for averaging spectrum measurements of modulation signals and noises as well as measuring discontinuous signals, such as burst.

Analysis start time setting range

Table 4.2.3-3 Analysis start time setting range in Manual mode

Capture Time	Minimum Value [s]	Maximum Value [s]
Auto	0	$x_2 - x_1$
Manual	0	$x_3 - x_1$

x_1 : Analysis time length [s]

x_2 : Maximum value [s] of capture time length

 2.4 “Setting IQ Data Capture Time Range”

x_3 : Capture time length [s]

 2.4 “Setting IQ Data Capture Time Range”

Analysis time length setting range

Table 4.2.3-4 Analysis time length setting range in Manual mode

Capture Time	Minimum Value [s]	Maximum Value [s]
Auto	0	$x_2 - x_1$
Manual	0	$x_3 - x_1$

x_1 : Analysis start time [s]

x_2 : Maximum value [s] of capture time length

 2.4 “Setting IQ Data Capture Time Range”

x_3 : Capture time length [s]

 2.4 “Setting IQ Data Capture Time Range”

Analysis start time and analysis time length resolution

Table 4.2.3-5 Frequency span and resolution

Frequency Span	Resolution
1 kHz	0.5 ms
2.5 kHz	0.2 ms
5 kHz	0.1 ms
10 kHz	50 μs
25 kHz	20 μs
50 kHz	10 μs
100 kHz	5 μs
250 kHz	2 μs
500 kHz	1 μs
1 MHz	0.5 μs
2.5 MHz	0.2 μs
5 MHz	0.1 μs
10 MHz	50 ns
25 MHz	20 ns
31.25 MHz	20 ns
50 MHz*1	10 ns
62.5 MHz*2	10 ns
100 MHz*3	5 ns
125 MHz*3	5 ns

*1: 50 MHz can be set only when Option 004/104/077/177 is installed.









*2: 62.5 MHz can be set only when Option 077/177 is installed.

*3: 100 MHz and 125 MHz can be set only when Option 004/104/078/178 is installed.

Setting procedure for analysis time

Example: To switch the analysis time to the Manual mode, and to set the analysis start time to 20 ms and analysis time to 60 ms

<Procedure>

1. Press .
2. Press  (Start Time).
3. Press  , and then press  (ms) to set the analysis start time.
4. Press  (Time Length).
5. Press  , and then press  (ms) to set the analysis time length.

4.2.4 Setting scale

Scale function menu

Pressing **F6** (Trace) on the main function menu, or pressing **Trace** and then **F3** (Scale) displays the Scale function menu.

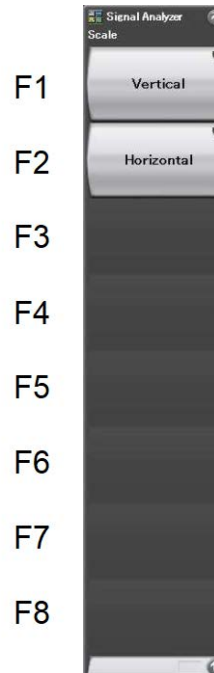

Figure 4.2.4-1 Scale function menu

Table 4.2.4-1 Scale function menu

Menu Display	Function
Vertical	Used for setting related to the vertical axis (level axis) scale.
Horizontal	Used for setting related to the horizontal axis (frequency axis) scale.

Vertical function menu

Pressing **F1** (Vertical) on the Scale function menu displays the Vertical function menu.



Figure 4.2.4-2 Vertical function menu

Table 4.2.4-2 Vertical function menu

Menu Display	Function
Log Scale Division	Sets the scale range (Log scale range) of the vertical axis.
Lin Scale Division	Sets the scale range (Lin scale range) of the vertical axis.
Log Scale Line (10/12)	Sets the number of scale lines when the Log scale is used.

Horizontal function menu

Pressing **F2** (Horizontal) on the Scale function menu displays the Horizontal function menu.

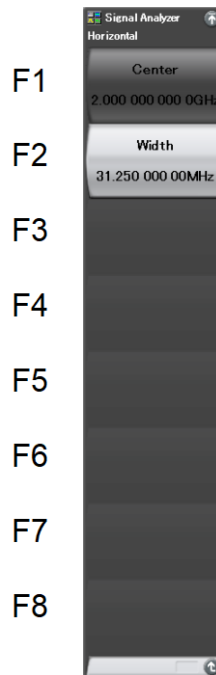

Figure 4.2.4-3 Horizontal function menu

Table 4.2.4-3 Horizontal function menu







Menu Display	Function
Center	Sets the center frequency of the horizontal axis scale.
Width	Sets the frequency width of the horizontal axis scale.

(1) Setting the vertical axis scale

The scale range Log scale and Lin scale of the main trace level axis are set.

Example: To set the Log scale to 2 dB/Div and scale line to 12

<Procedure>

1. Press .
2. Press  (Scale).
3. Press  (Vertical).
4. Press  (Log Scale Division).
5. Press , and then press  (dB/Div) to set Log Scale Division.
6. Press  (Log Scale Line), and then select "12" to set the scale line.

Setting range and resolution for vertical axis scale range

Setting range:	0.1 to 20 dB/Div (log scale) 1 to 10%/Div (linear scale)
Minimum resolution:	0.1 dB/Div (log scale) 1%/Div (linear scale)
Rotary knob resolution:	1-2-5-10 sequence
Step key resolution:	1-2-5-10 sequence







 2.3.3 "Setting scale"

(2) Setting the horizontal axis scale

In a spectrum trace, the display frequency range (horizontal axis scale) can be changed freely within the range of the center frequency and frequency span. To set the display frequency range, the setting for Center (center of the display frequency range) and Width (frequency bandwidth of the display frequency range) are changed.

Example: To set the frequency bandwidth of the display frequency range to 25 MHz

<Procedure>

1. Press .
2. Press  (Scale).
3. Press  (Horizontal).
4. Press  (Width).
5. Press  , and then press  (MHz) to set the frequency bandwidth of the display frequency range.



Trace

Setting range and resolution for horizontal axis scale

Horizontal axis scale setting range: Refer to Table 4.2.4-4.

Horizontal axis scale minimum resolution: $\frac{x_1}{x_2}$ [Hz]

The resolution is 0.1 Hz.

x_1 : Sampling rate [Hz]

 2.2.2 "Setting frequency span"

x_2 : Window function length (by RBW)

 Appendix D "FFT and RBW"

Table 4.2.4-4 Horizontal axis scale setting range

Zoom Center [Hz]		Zoom Width [Hz]	
Lower Limit	Upper Limit	Lower Limit	Upper Limit
$x_1 - \frac{x_2 - x_3}{2}$	$x_1 + \frac{x_2 - x_3}{2}$	$100 * x_4$	x_2

x_1 : Center frequency [Hz]

 2.2.1 "Setting center frequency"

x_2 : Frequency span

 2.2.2 "Setting frequency span"

x_3 : Horizontal axis scale frequency bandwidth [Hz]

x_4 : Minimum resolution [Hz]

4.2.5 Setting resolution bandwidth (RBW)

Pressing **F5** (RBW) on the Trace function menu, or pressing **BW** displays the RBW function menu.

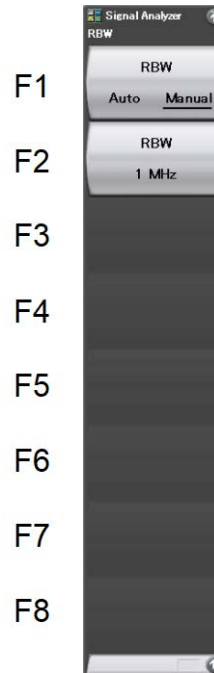

Figure 4.2.5-1 RBW function menu

Table 4.2.5-1 RBW function menu

Menu Display	Function
RBW (Auto/Manual)	Selects auto setting or manual setting for the resolution bandwidth (RBW).
RBW	Sets the resolution bandwidth (RBW).

(1) Auto mode

RBW is set to Auto in the initial state to automatically set to the optimal state so that no frequency or level measurement error occurs when the frequency span is changed.

(2) Manual mode

In normal measurement, a measurement can be performed without any special setting, if RBW is set to Auto. However, in the following cases, set RBW to Manual.

(a) General measurement

The frequency resolution can be increased by lowering RBW when observing neighboring 2 signals. At the same time, the noise level can be decreased. However, if it is too low, the spectrum waveform becomes too steep so that the response characteristics become poor. Also, the calculation time becomes longer. Determine the RBW value under practical calculation speed.

(b) Intermodulation distortion observation

Set a lower value of RBW via the Manual setting to measure intermodulation distortion of 2 signals with a relatively broad frequency span and low noise level.

Setting range and resolution for resolution bandwidth in Manual mode

Setting range:	Refer to Table 4.2.5-2.
Rotary knob resolution:	1-3 sequence
Bandwidth step key resolution:	1-3 sequence

Resolution bandwidth setting range

The setting range of the resolution bandwidth varies depending on the setting of Marker Result.

Table 4.2.5-2 Pattern of Marker Result

Integration	Density	Peak (Fast)	Peak (Accuracy)
[1]	[1]	[2]	[3]

Table 4.2.5-3 Setting range of resolution bandwidth

Frequency Span [Hz]	RBW [Hz]			
	Minimum in [1]	Minimum in [2]	Minimum in [3]	Maximum
1 k	1	1	1	30
2.5 k	1	1	1	100
5 k	1	1	1	100
10 k	1	1	1	300
25 k	1	1	3	1 k
50 k	1	3	10	1 k
100 k	3	10	10	3 k
250 k	10	10	30	10 k
500 k	10	30	100	10 k
1 M	30	100	100	30 k
2.5 M	100	100	300	100 k
5 M	100	300	300	300 k
10 M	300	300	1 k	300 k
25 M	300	1 k	3 k	1 M
31.25 M	300	1 k	3 k	1 M
50 M*1	3 k	3 k	10 k	3 M
62.5 M*2	3 k	3 k	10 k	3 M
100 M*3	10 k	10 k	30 k	10 M
125 M*3	10 k	10 k	30 k	10 M

*1: 50 MHz can be set only when Option 004/104/077/177 is installed.

*2: 62.5 MHz can be set only when Option 077/177 is installed.

*3: 100 MHz and 125 MHz can be set only when Option 004/104/078/178 is installed.

RBW is set with the 1-3 sequence.

(3) Setting the resolution bandwidth

Example: To set the resolution bandwidth to 100 kHz

<Procedure>

1. Press **BW**.
2. Press **F2** (RBW).
3. Press **1** **0** **0**, and then press **F3** (kHz) to set the resolution bandwidth.

In the Manual mode, the **M** icon is displayed.

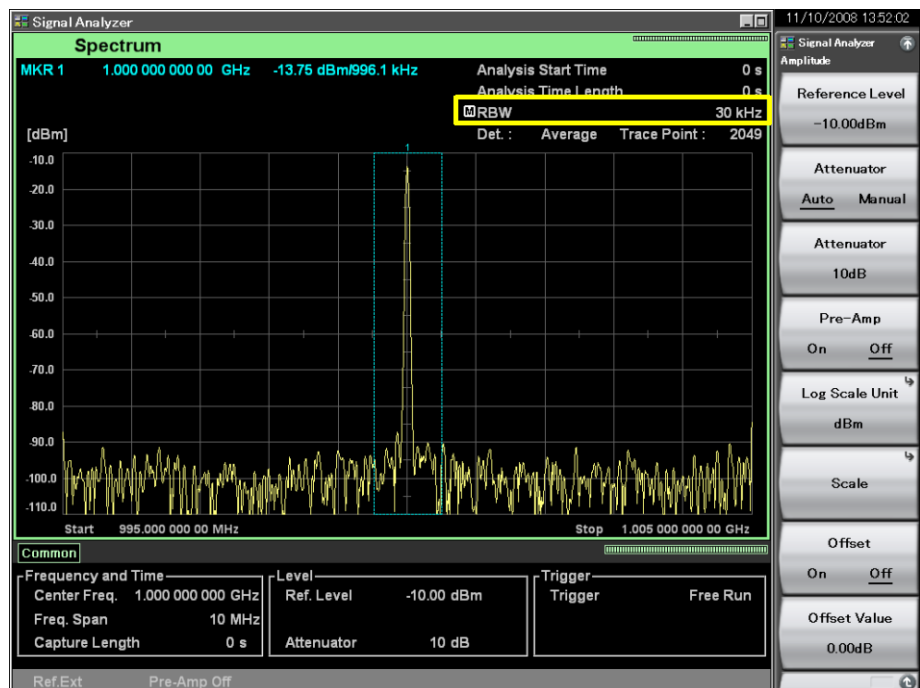

Figure 4.2.5-2 "Manual" icon

4.2.6 Setting storage mode

Pressing **Trace** and then **F4** (Storage) displays the Storage function menu.



Figure 4.2.6-1 Storage function menu

Table 4.2.6-1 Storage function menu

Menu Display	Function
Mode	Used for setting related to the updating and displaying of trace data.
Count	Sets the storage count.
Stop	Stops the storage.

Storage mode types

In a spectrum trace, the following four storage mode types can be selected.

Table 4.2.6-2 Four storage mode types

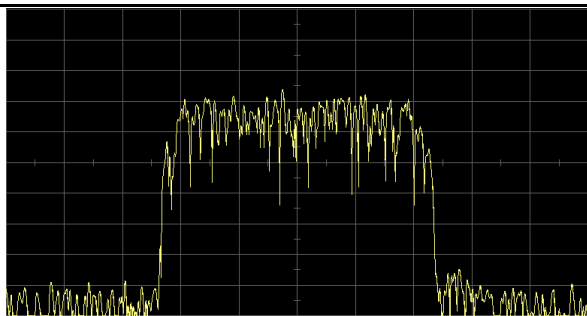
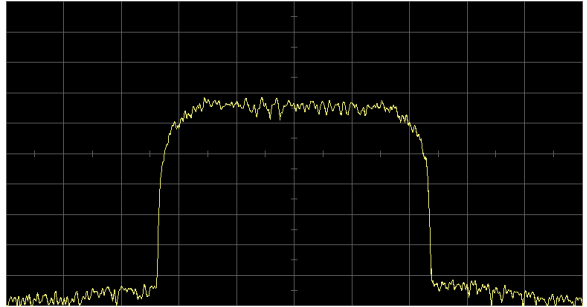
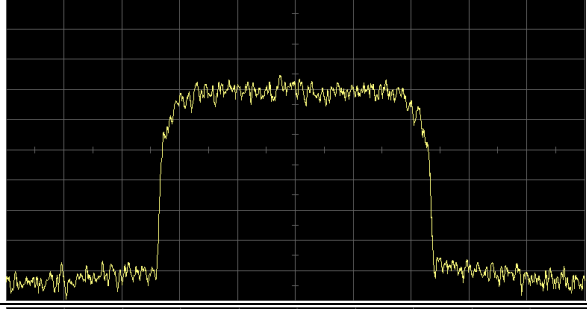
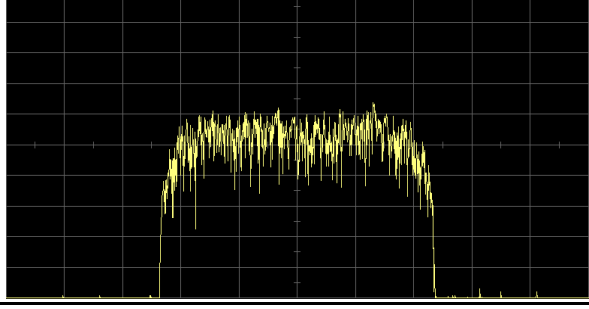
Mode	Description	Display Example
Off	At each capture, the trace data are updated and displayed. These data are used for normal measurement.	
Lin Average	Performs averaging operation at each horizontal axis point for each capture and displays the results. Averaging is done with linear values even in Log display. Used for S/N improvement.	
Max Hold	At each capture, the previous and new trace data of each horizontal axis point are compared and the larger of the two is displayed.	
Min Hold	At each capture, the previous and new trace data of each horizontal axis point are compared and the smaller of the two is displayed.	









4

Trace

(1) Selecting the storage mode and storage count

Example: To set the storage mode to Lin Average and storage count to 100

<Procedure>

1. Press .
2. Press  (Storage).
3. Press  (Mode) and select Lin Average.
4. Press  (Count).
5. Press   , and then press  (Set) to set the storage count.

Setting range and resolution for storage count

Setting range: 2 to 9999

Minimum resolution: 1

Rotary knob resolution: 1 step

Step key resolution: 1 step at the highest 1st digit

(2) Averaging function

The digital averaging function, which performs an averaging operation at a point on the horizontal axis each time trace data is captured and displays the trace, can be executed by selecting Lin Average in the storage mode.

When the measurement mode is Single, measurement stops when capture for the storage count is completed. When the measurement mode is Continuous, averaging is continued even when capture for the storage count is completed. However, the average after completion of capture for the storage count is calculated as shown in Table 4.2.6-3, so the effect of old data becomes less as the storage count increases.

Table 4.2.6-3 Averaging

Capture Count n	Measurement Value M(n)	Displayed Value Y(n)
1	M(1)	$Y(1) = M(1)$
2	M(2)	$Y(2) = \frac{Y(1) + M(2)}{2}$
3	M(3)	$Y(3) = \frac{2 \times Y(2) + M(3)}{3}$
...
N - 1	M(N - 1)	$Y(N - 1) = \frac{(N - 2) \times Y(N - 2) + M(N - 1)}{N - 1}$
N	M(N)	$Y(N) = \frac{(N - 1) \times Y(N - 1) + M(N)}{N}$
Continuous only		
N + 1	M(N + 1)	$Y(N + 1) = \frac{(N - 1) \times Y(N) + M(N + 1)}{N}$
N + 2	M(N + 2)	$Y(N + 1) = \frac{(N - 1) \times Y(N) + M(N + 1)}{N}$
...

Note:

When Storage Count = N

Using the averaging function can improve S/N according to the storage count and capture count.

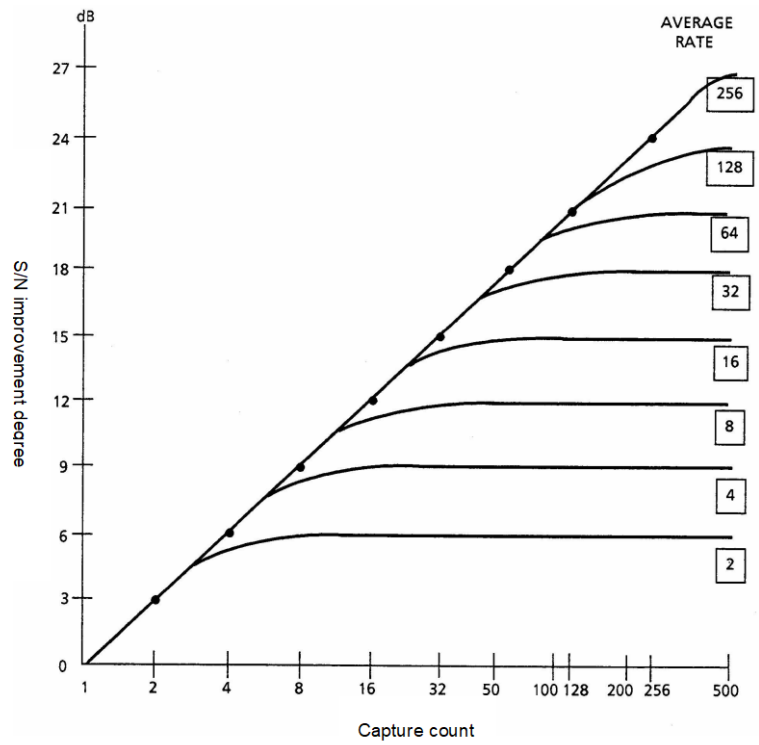

Figure 4.2.6-2 Averaging function

4.2.7 Setting detection mode

The detection mode can be selected by pressing **Trace** and then **F7** (Time Detection).

Detection mode types

The detection mode in the analysis range is set. The detection mode can be selected from the three types: Average, Positive, and Negative.

Table 4.2.7-1 Detection modes in analysis range

Detection Mode	Descriptions
Average	Traces the average value within the analysis range.
Positive	Traces the maximum value within the analysis range. The peak value of a signal near the noise level is measured in Positive mode.
Negative	Traces the minimum value within the analysis range. The lower envelope of the modulation waveform is measured in Negative mode.

4
Trace

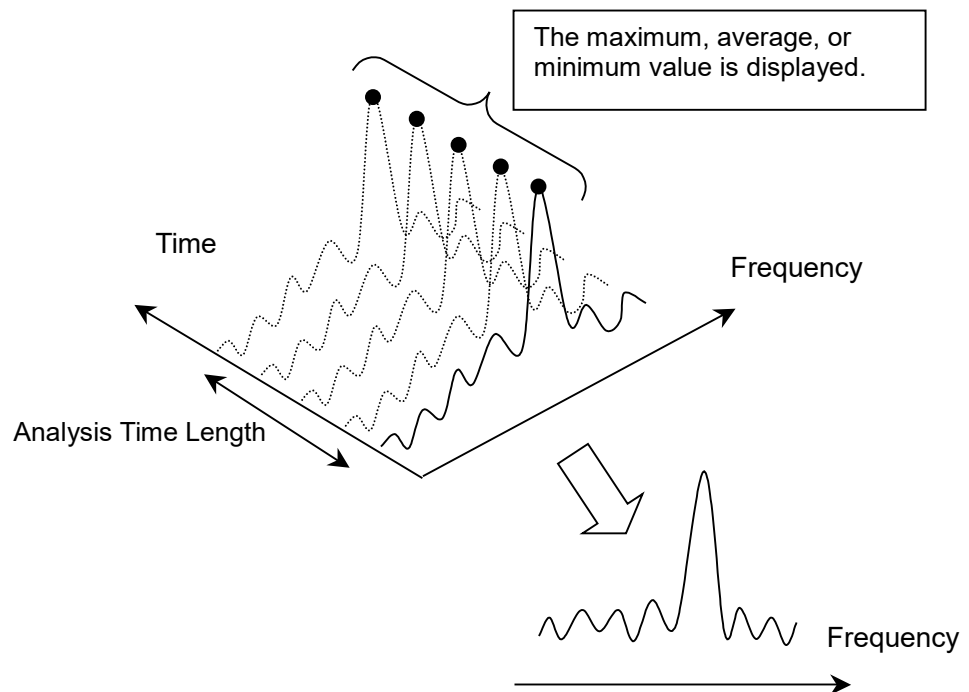

Figure 4.2.7-1 Waveform display by detection

Detection mode when Analysis Time is Auto

When Capture Time and Analysis Time are set to Auto, in the spectrum trace, the analysis time range is minimized (to one FFT) to make the measurement time fastest. Therefore, there is only one data for detection even when the detection mode is changed, so the same measurement results are displayed.

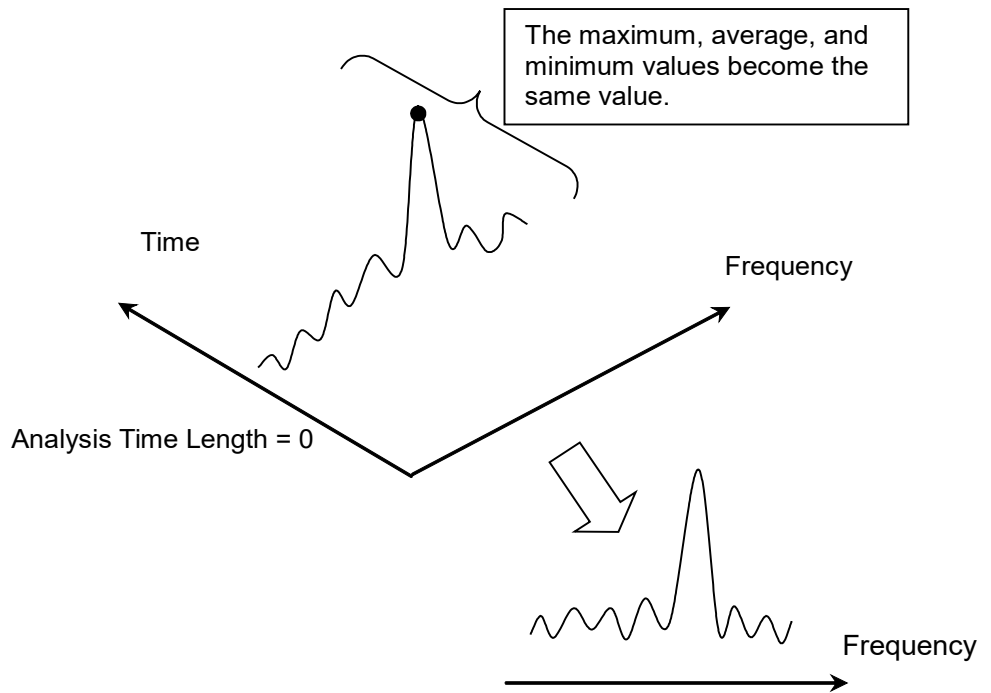

Figure 4.2.7-2 Waveform display when Capture Time is Auto

On the other hand, when Capture Time is set to Manual mode and Analysis Time is set to Auto, in the spectrum trace, the analysis time range is the time set in Capture Time Length. Therefore, detection is performed for the FFT spectrums of all the IQ data captured.

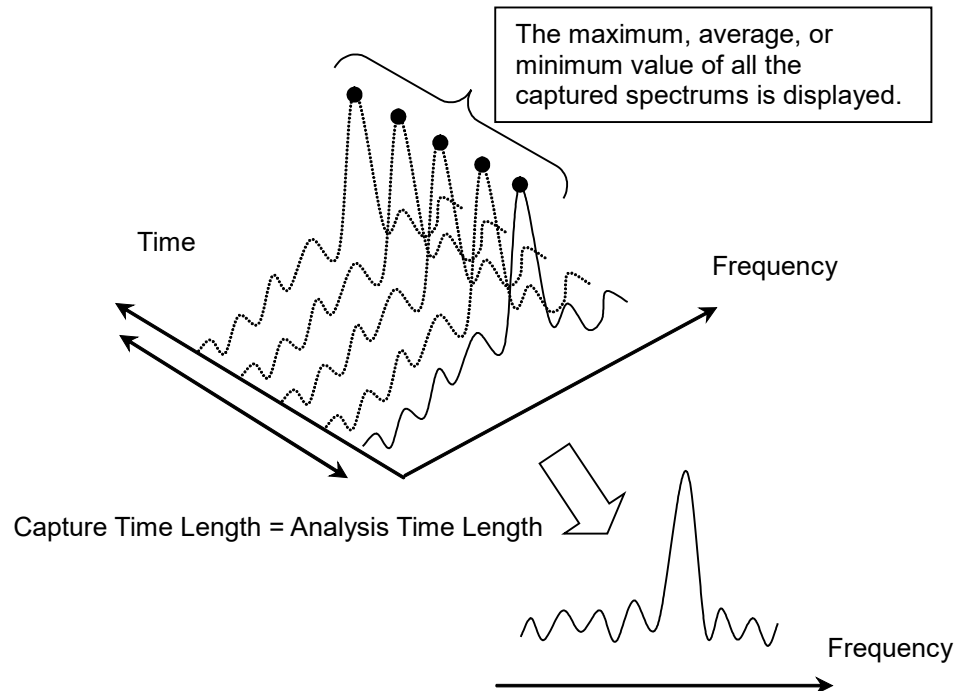

Figure 4.2.7-3 Waveform display when Capture Time is Manual

(1) Setting the detection mode

Example: To set the detection mode to Positive

<Procedure>

1. Press .
2. Press (Time Detection), and then select Positive.
3. Press to set the detection mode.

4.2.8 Setting markers

This section describes various Marker functions provided by the zone marker, and the functions to improve measurement efficiency, such as marker search and parameter setting with marker values.

Pressing **F2** (Marker) on page 2 of the Trace function menu, or pressing **Marker** displays the Marker function menu.

The Marker function menu consists of two pages, which can be toggled by pressing **→**.

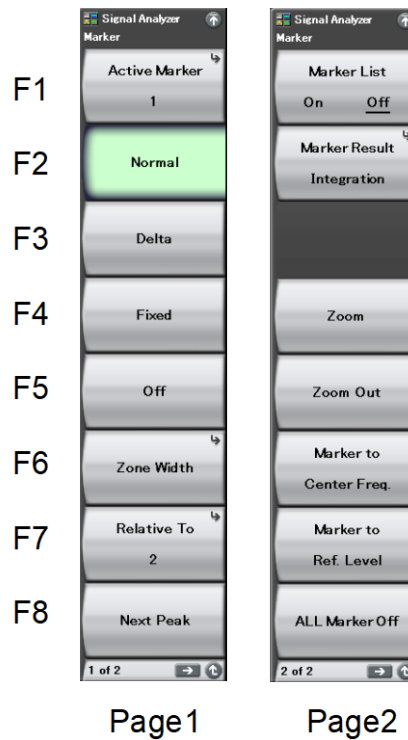

Figure 4.2.8-1 Marker function menu

Table 4.2.8-1 Marker function menu

Menu	Function
Active Marker	Sets the active marker.
Normal	Sets the marker mode of the active marker to Normal. The frequency (Time) and the level are displayed on the screen. The normal marker is displayed as ▼ on the trace when Marker Result is Peak.
Delta	Sets the marker mode of the active marker to Delta. The frequency and level at the marker are displayed as values relative to the reference point (marker set by Relative To). If the marker that is set by Relative To is set to Off, the marker is set to a Fixed marker.
Fixed	Sets the marker mode of the active marker to Fixed. The Fixed marker is displayed as □ on the screen. It is fixed on the screen and has a fixed value.
Off	Sets the marker mode of the active marker to Off.
Zone Width	Opens the Zone Width function menu. Set the frequency width for the zone marker.
Relative To	Sets the reference marker when the active marker is Delta. The frequency and level of the active marker are displayed as values relative to the reference point (marker set by Relative To).
Next Peak	Searches for the second biggest peak after the active marker, and moves the marker so that the marker becomes the center frequency of the zone marker.
Marker List (On/Off)	Sets the marker list display On/Off.
Marker Result	Opens the Marker Result function menu. Set the display type of the marker value.
Zoom	Expands and displays the specified range of the zone marker of the active marker.
Zoom Out	Compresses and displays the current screen display data in the zone of the active marker.
Marker to Center Freq.	Sets the marker center frequency of the active marker to the center frequency in the measurement band.
Marker to Ref. Level	Sets the integral values within the zone width of the active marker to the reference level.
All Marker Off	Sets all the markers to Off.

Zone Width function menu

On the Marker function menu, press **F0** (Zone Width) to display the Zone Width function menu.



Figure 4.2.8-2 Zone Width function menu

Table 4.2.8-2 Zone Width function menu

Menu	Function
Type (Zone/Spot)	Switches between the spot marker and the zone marker.
Zone Width	Sets the zone marker width of the frequency domain.
Couple Zone (On/Off)	Sets the Zone Width common setting On/Off. The settings of Zone Width Type and Zone Width are shared when set to On.
Spot Line (On/Off)	Sets the line display of the spot marker to On/Off.

Marker Result function menu

On page 2 of the Marker function menu, press  (Marker Result) to display the Marker Result function menu.

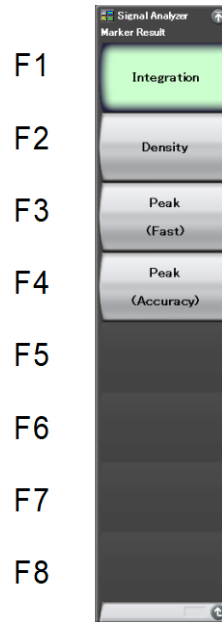

Figure 4.2.8-3 Marker Result function menu

Table 4.2.8-3 Marker Result function menu

Menu	Function
Integration	Displays the total power in the zone band.
Density	Displays the power per 1 Hz in the zone band.
Peak (Fast)	Displays the peak power in the zone (emphasis on speed).
Peak (Accuracy)	Displays the peak power in the zone (emphasis on accuracy).

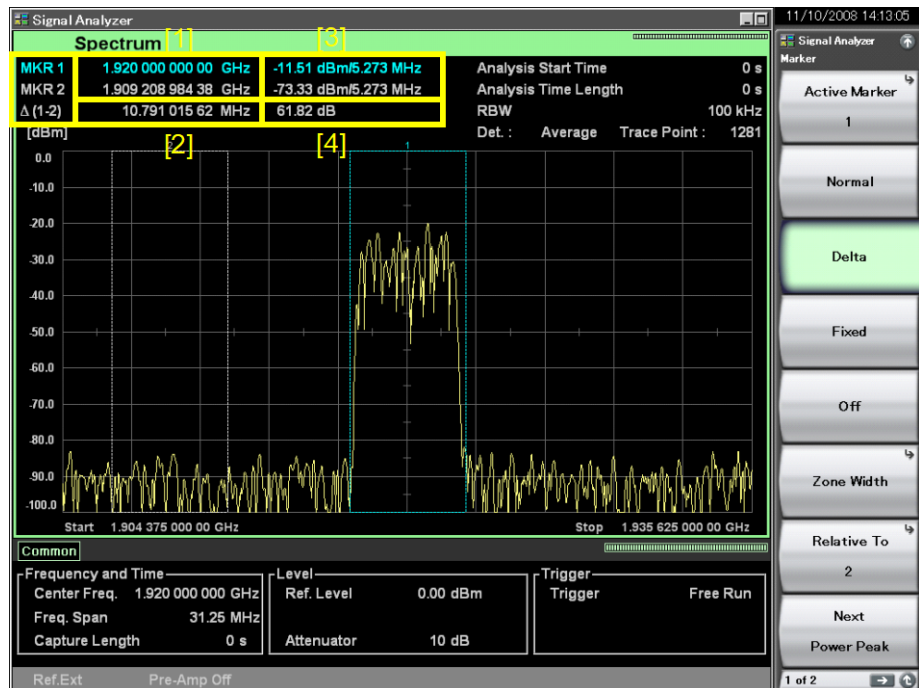

Figure 4.2.8-4 Display items of marker result

Table 4.2.8-4 Display items of marker result

No.	Display	Descriptions
[1]	Frequency	Displays the frequency of each marker.
[2]	Frequency difference	The frequency difference between the active marker and the marker set by Relative To is displayed when the active marker is Delta. The difference between the frequencies of the markers (the active marker and the marker set by Relative To) is displayed.
[3]	Marker value	The average power in the zone band, the integral power in the zone band, or the peak power is displayed. You can switch the display contents by using the Marker Result function menu.
[4]	Marker value difference	The power difference between the active marker and the marker set by Relative To is displayed when the active marker is Delta. The difference between the powers of the markers (the active marker and the marker set by Relative To) is displayed.

Changing position and width of zone marker

The area enclosed by the dashed lines at the center of the screen in Figure 4.2.8-3 is called a zone marker. The integral power, average power, or peak power is displayed as a marker value.

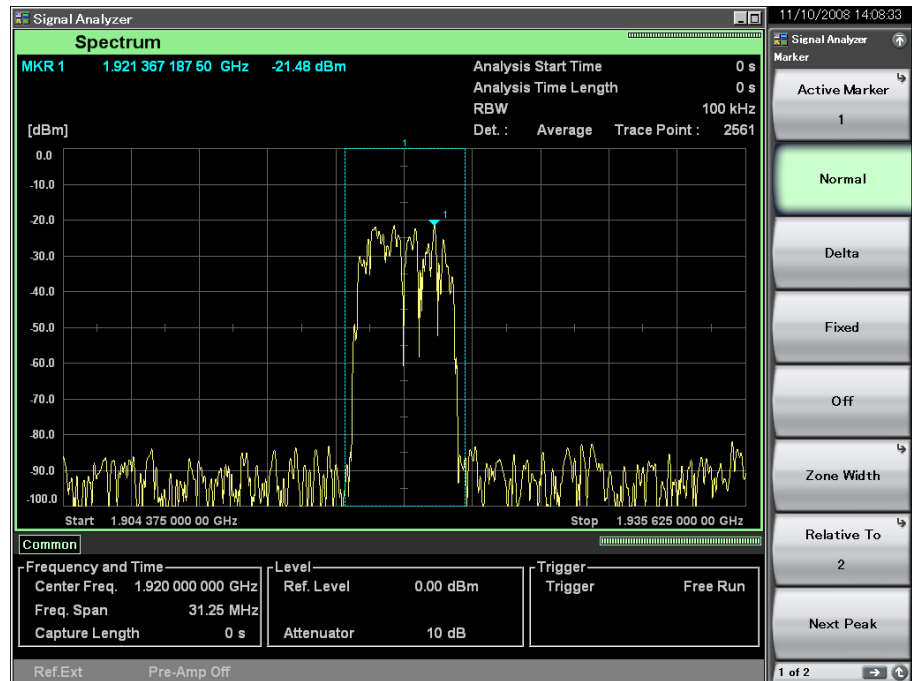

Figure 4.2.8-5 Zone width, zone center frequency, and marker value

(1) Changing Zone Center, Zone Width

Set the zone center frequency and zone width. You can configure a setting per marker.

Setting Couple Zone to On sets all the markers in a lump sum.

Example: To set the marker 1 to 5.9875 GHz and set Zone Width to 1 MHz
<Procedure>

1. Press **Marker**.
2. Press **F1** (Active Marker) and then press **F1** (Marker 1) to set the active marker to 1.
3. Press **5** **.** **9** **8** **7** **5** and then press **F1** (GHz) after the Marker main function menu has been displayed, in order to set the zone center frequency.
4. Press **F0** (Zone Width) after the Marker main function menu has been displayed.
5. Press **1** and then press **F2** (MHz) to set the zone width.

The other markers can be set in the same way.

Setting range and resolution for Zone Center and Zone Width

Setting range: Refer to Table 4.2.8-5.

Zone Center minimum resolution: $\frac{x_1}{x_2}$ [Hz]

The resolution is 0.01 Hz.

Zone Width minimum resolution: 0.01 [Hz]

x_1 : Sampling rate [Hz]

 2.2.2 “Setting frequency span”

x_2 : Window function length (by RBW)

 Appendix D “FFT and RBW”

Table 4.2.8-5 Zone Center, Zone Width setting range

Zone Center [Hz]		Zone Width [Hz]	
Lower Limit	Upper Limit	Lower Limit	Upper Limit
$x_1 - \frac{x_2}{2}$	$x_1 + \frac{x_2}{2}$	$\frac{x_3}{x_4} \times 32$	x_2

x_1 : Horizontal axis scale center frequency [Hz]

x_2 : Horizontal axis scale frequency bandwidth [Hz]

x_3 : Sampling rate [Hz]

 2.2.2 “Setting frequency span”

x_4 : Window function length (by RBW)

 Appendix D “FFT and RBW”



(2) Type of Marker Result

Select one of the following marker result types.

- Integration Displays the integral power in the zone marker band.
- Density Displays the power per 1 Hz in the zone marker band.
- Peak (Fast) Displays the peak power in the zone marker band (emphasis on speed).
- Peak (Accuracy) Displays the peak power in the zone marker band (emphasis on accuracy).

Example: To select the type of the marker result

<Procedure>

1. Press .
2. Press  (Marker Result) on page 2 of the function menu then select Integration, Density, Peak (Fast), and Peak (Accuracy) to set the marker result type.

(3) Zoom In Display Setting

Example: To enlarge the zone range of the active zone marker

<Procedure>

1. Press **Marker**.
2. Press **→** to display the page 2 of Marker function menu.
3. Press **F4** (Zoom) to enlarge the specified range.

As shown in Figure 4.2.8-6, when the Zoom function is performed after setting the range with the zone marker, Center (center of the display frequency range) and Width (frequency bandwidth of the display frequency range) are changed to the zone marker range.

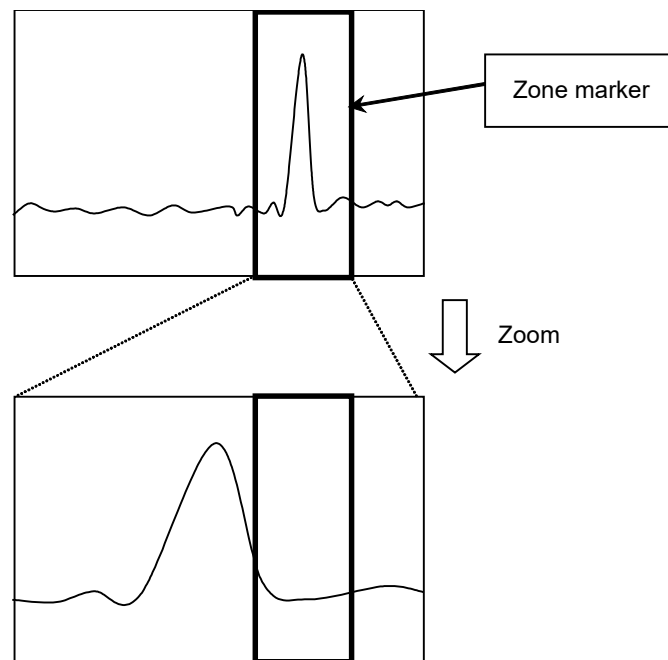





Figure 4.2.8-6 Zoom

(4) Zoom Out Display Setting

Example: To reduce the current screen display data into the zone of the active zone marker

<Procedure>

1. Press .
2. Press  to display the page 2 of Marker function menu.
3. Press  (Zoom Out) to downsize the entire screen to fit in the active zone of the zone marker.

As shown in Figure 4.2.8-7, when Zoom Out is performed after setting the range with the zone marker, the zone marker range changes to Center (center of the display frequency range) and Width (frequency bandwidth of the display frequency range).

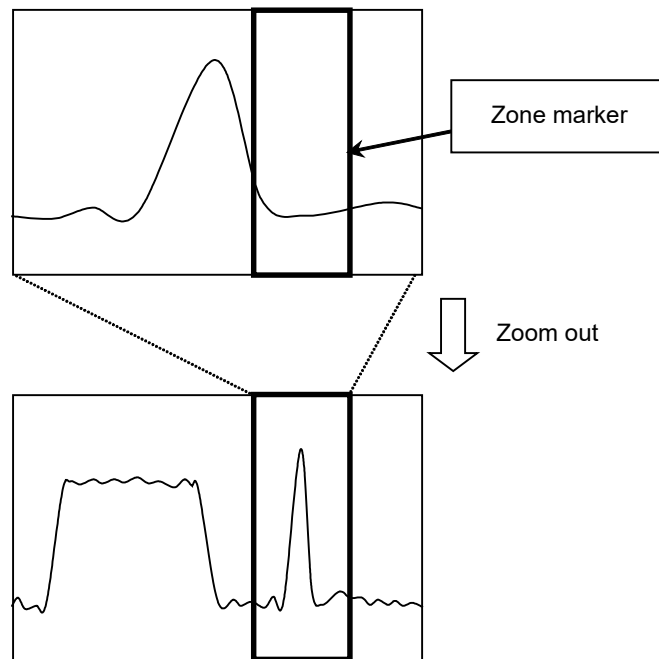





Figure 4.2.8-7 Zoom out

(5) Displaying marker list

Displays the list of the marker result. The marker frequency and the power are displayed on the list.

Example: To set the marker display to On

<Procedure>

1. Press .
2. Press  to move to page 2 of the Marker function menu, and set  (Marker List) to On.

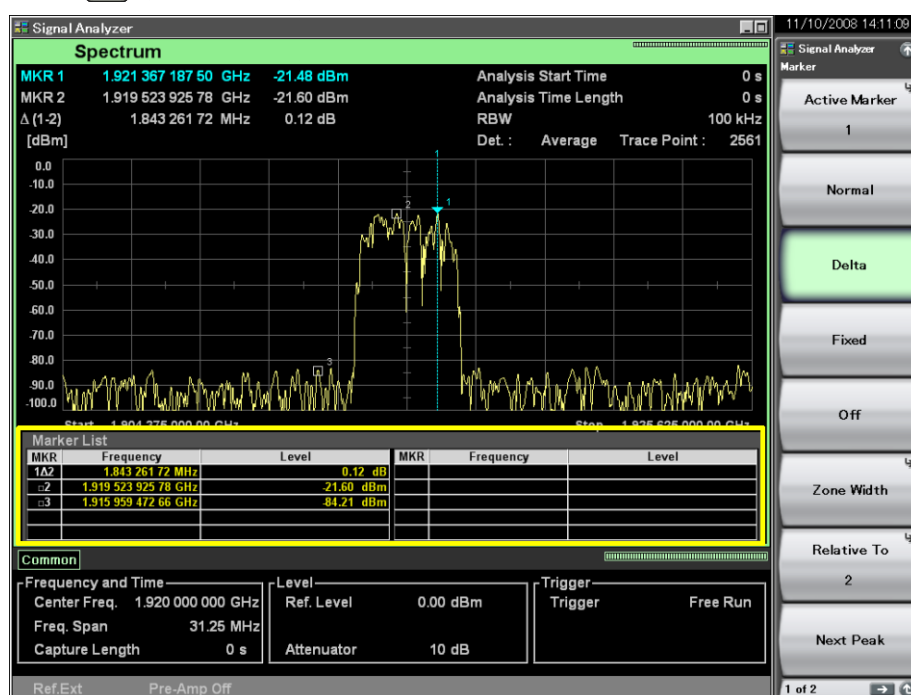

Figure 4.2.8-8 Displaying marker list



Table 4.2.8-6 Marker List Display Items

Item	Descriptions
MKR	Displays the marker number. When a number is displayed, it indicates a marker number. When Δ is displayed, it indicates the level or frequency difference between the active marker and the marker set by Relative To. When \square is displayed, it indicates a Fixed marker.
Frequency	Displays the marker frequency.
Level	Displays the marker level. The result selected in Marker Result is displayed in the units specified in Scale Unit. When Δ is displayed, the level of the active marker is displayed as a relative value to the marker set in Relative To.

4.2.9 Setting marker search

The marker search functions include Peak search and Next Peak search.

Signal Search function menu

Pressing  (Signal Search) on page 2 of the Trace function menu, or pressing  displays the Signal Search function menu.

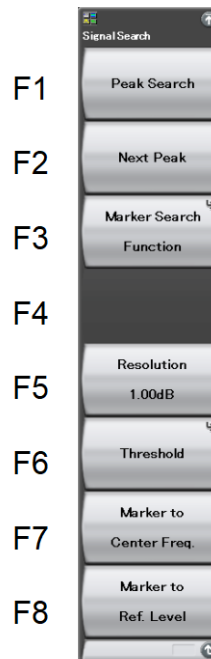

Figure 4.2.9-1 Signal search function menu

Table 4.2.9-1 Signal Search function menu

Menu Display	Function
Peak Search	Moves the active marker to the point where the integral power of the zone width of the active marker becomes maximal in the measurement band. If two or more such points exist, the point with the lowest frequency (toward the left of the scale) is selected.
Next Peak	Detects the second highest integral power of the zone width of the active marker in the measurement band and moves the active marker to that point. If two or more such points exist, the point with the lowest frequency (toward the left of the scale) is selected.
Marker Search Function	Opens the Marker Search function menu. Sorts the markers by frequency (time) or level.
Resolution	Sets the resolution for Next Peak search.
Threshold	Used for setting related to the threshold value to restrict level points to be searched.
Marker to Center Freq.	Reflects the marker center frequency of the active marker to the center frequency within the measurement band.
Marker to Ref. Level	The value of the active marker (integral power in the zone width when Marker Result is density) is used as reference level.

Threshold function menu

Pressing  (Threshold) from the Signal Search function menu displays the Threshold function menu.



Figure 4.2.9-2 Threshold function menu

Table 4.2.9-2 Threshold function menu

Menu Display	Function
Threshold (On/Off)	Selects On/Off for the detection threshold function for integral peak power detection of the zone width.
Threshold (Above/Below)	Selects whether integral peak power detection of the zone width is to be performed Above (upper detection) or Below (lower detection) the threshold.
Threshold Level	Sets the detection threshold for integral peak power detection of the zone width.

Marker Search function menu

Pressing  (Marker Search Function) on the Signal Search function menu displays the Marker Search function menu.

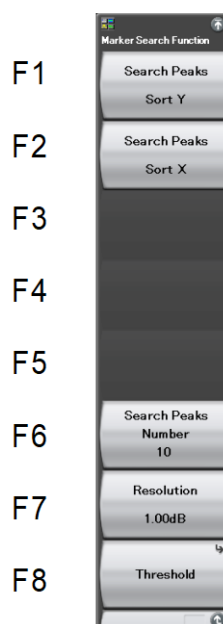

Figure 4.2.9-3 Marker Search function menu

Table 4.2.9-3 Marker Search function menu



Menu	Function
Search Peaks Sort Y	Sets the markers in the order of level in relation to the peaks on the trace of the number specified in Search Peaks Number.
Search Peaks Sort X	Sets the markers in the order of frequency (time) in relation to the peaks on the trace of the number specified in Search Peaks Number.
Search Peaks Number	Sets the number of searches when Search Peaks Sort Y/X is executed.
Resolution	Specifies the resolution of the search.
Threshold	Sets the threshold to limit the level point targeted for searching.

(1) Setting Peak search

The zone of the active marker is moved to the position where the marker value becomes the maximum in the measurement band. If two or more marker values exist, it is moved to the point with the lower marker frequency. When Marker Result is Integration or Density, the function menu is displayed as “Power Peak Search. Executing Power Peak Search moves the zone of the active marker to the point where the integral power of the zone bandwidth becomes the highest.

Example: To execute a Peak search

<Procedure>



1. Press .
2. Press  (Peak Search) to execute a Peak search.

(2) Setting Next Peak search

The zone of the active marker is moved to the position with the next highest peak power for the marker value of the current active marker. If two or more marker values exist, it is moved to the point with the lower marker frequency. When Marker Result is Integration or Density, the function menu is displayed as “Next Peak Power”. Executing Next Power Peak detects the next highest integral power to the current integral power of the zone bandwidth, and then moves the zone of the active marker to that point.

Example: To execute a Next Peak search

<Procedure>

1. Press .
2. Press  (Next Peak) to execute a Next Peak search.







When Next Peak search is executed in succession, peak values with high marker values are sequentially detected to which the marker is moved.

(3) Setting the search resolution

The Next Peak search resolution is set. Trace data with slopes greater than the resolution at both ends is to be searched.

Example: To set the search resolution value to 1.23 dB

<Procedure>

1. Press .
2. Press  (Resolution).
3. Press    , and then press  (dB) to set the search resolution.









Setting range and resolution for search resolution

Setting range:	0.01 to 50.00 dB
Minimum resolution:	0.01 dB
Rotary knob resolution:	0.1 dB
Step key resolution:	1 dB

(4) Setting the search threshold

The threshold to restrict marker values to be searched is set. A search is performed for marker values above or below the threshold.

Example: To set threshold limitation to On and a threshold below -20 dBm
<Procedure>

1. Press .
2. Press  (Threshold).
3. Press  (Threshold On/Off) to switch to On.
4. Press  (Threshold Above/Below) to switch to Below.
5. Press  (Threshold Level).
6. Press   , and then press  (dBm) to set the threshold.

(5) Executing Marker to Center Freq.

The marker center frequency (Zone Center) is set to the center frequency (Center Frequency).

Example: To detect the peak power position in the measurement band and setting it to the center frequency

<Procedure>

1. Press .
2. Press  (Marker to Center Freq.).

(6) Executing Marker to Ref. Level

The zone width integral power (Total Power) of the marker is set to the reference level (Reference Level).

Example: To detect the peak power position in the measurement band and setting it to the reference level

<Procedure>

1. Press .
2. Press  (Marker to Ref. Level).

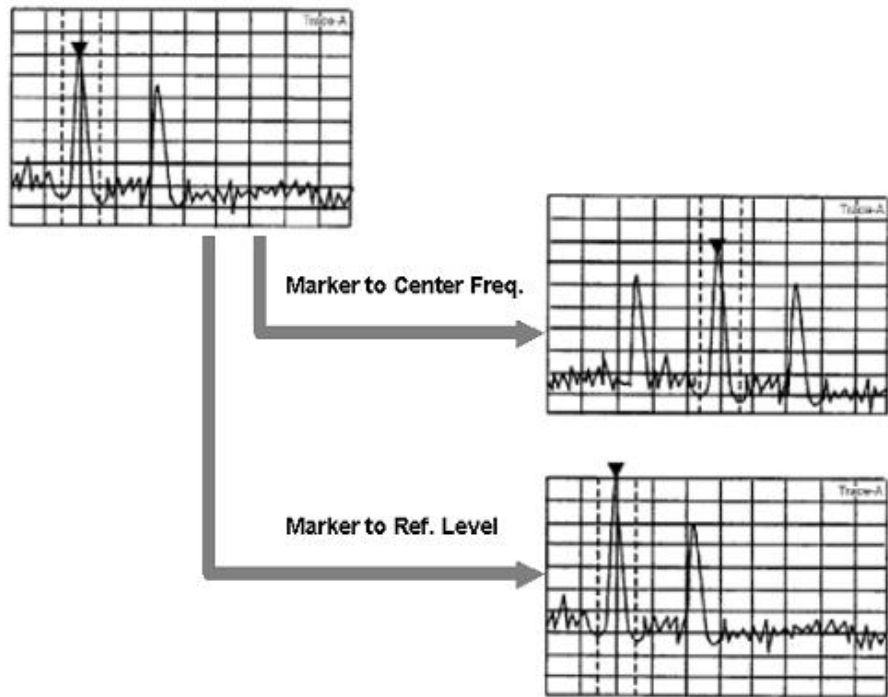

Figure 4.2.9-4 Marker to Center Freq. / Marker to Ref. Level

(7) Executing Marker Search Function

Sorts the markers set in Search Peaks Number by frequency (time) or level.

Note Marker Search Function can be executed when Marker Result is set to Peak (Fast) or Peak (Accuracy).

Example: To sort four markers by level

<Procedure>

1. Press **Peak Search**.
2. Press **F0** (Search Peaks Number) after pressing **F3** (Marker Search Function), and then press **4** to set the number of markers to 4.
3. Press **F1** (Search Peaks Sort Y) to sort the markers by level.

Example: To sort the markers by frequency

<Procedure>

1. Press **Peak Search**.
2. Press **F3** (Marker Search Function).
3. Press **F2** (Search Peaks Sort X) to sort the markers by frequency.

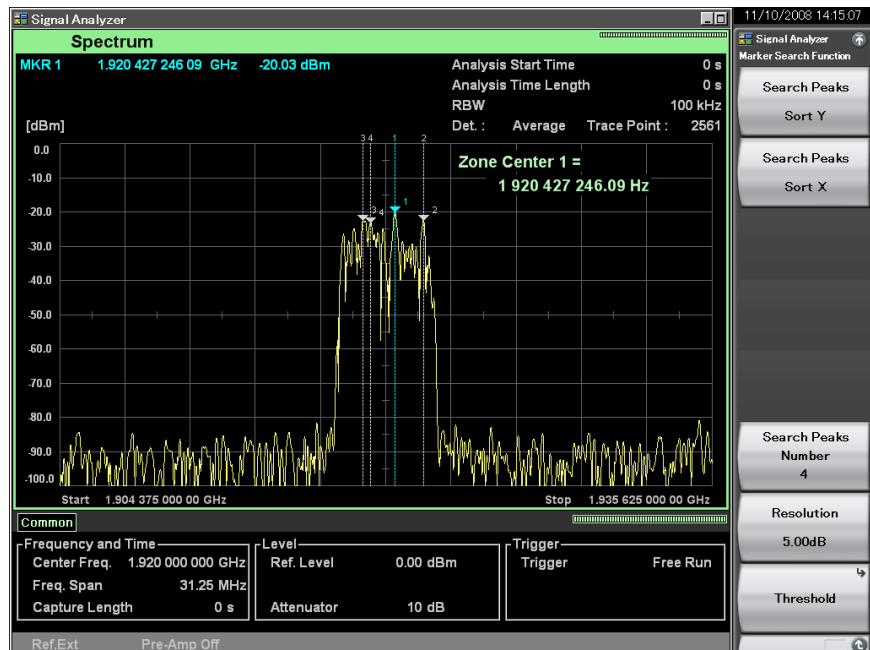
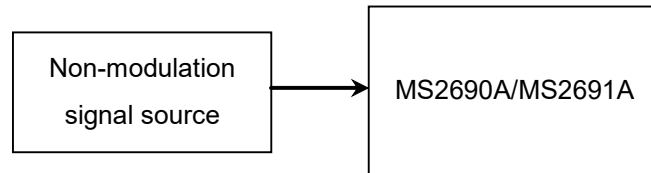

Figure 4.2.9-5 Setting markers sorted by level

Measurement example: Measuring the CN ratio

<Measurement block>



Center frequency: 1.9 GHz

Offset frequency: 100 kHz

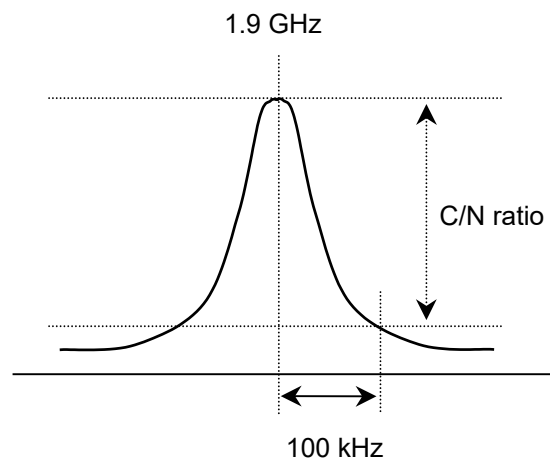

Figure 4.2.9-6 Measurement block diagram

<Procedure>

1. Press **Preset** and then press **F1** (Preset).
2. Press **Span**.
3. Press **5** **0** **0** and then press **F3** (kHz) to set the frequency span.
4. Press **Frequency**.
5. Press **1** **.** **9** and then press **F1** (GHz) to set the center frequency.
6. Press **Marker** and then press **F3** (Delta) to set the marker mode to Delta.
7. Press **→** to display page 2 of the Marker function menu.
8. Press **F2** (Marker Result) and then press **F4** (Peak (Accuracy)).
9. Press **Marker** to display the Marker function menu.
10. Press **F1** (Active Marker) and then press **F2** (Marker 2).
11. After the Marker function menu has been displayed, press **F2** (Normal) to set the marker mode to Normal.
12. Press **F6** (Zone Width) to display the Zone Width function menu.

13. Press **F9** (Couple Zone) to select Off.
14. Press **F1** (Type) to select Spot.
15. Press **1** **.** **9** **0** **0** **0** **1** **0** **0** **0** and then press **F1** (GHz) to set the center frequency of Marker 2.
16. Press **Marker** to display the Marker function menu.
17. Press **F1** (Active Marker) and then press **F1** (Marker 1).
18. Return the reading for the difference marker value $\Delta (1 - 2)$.

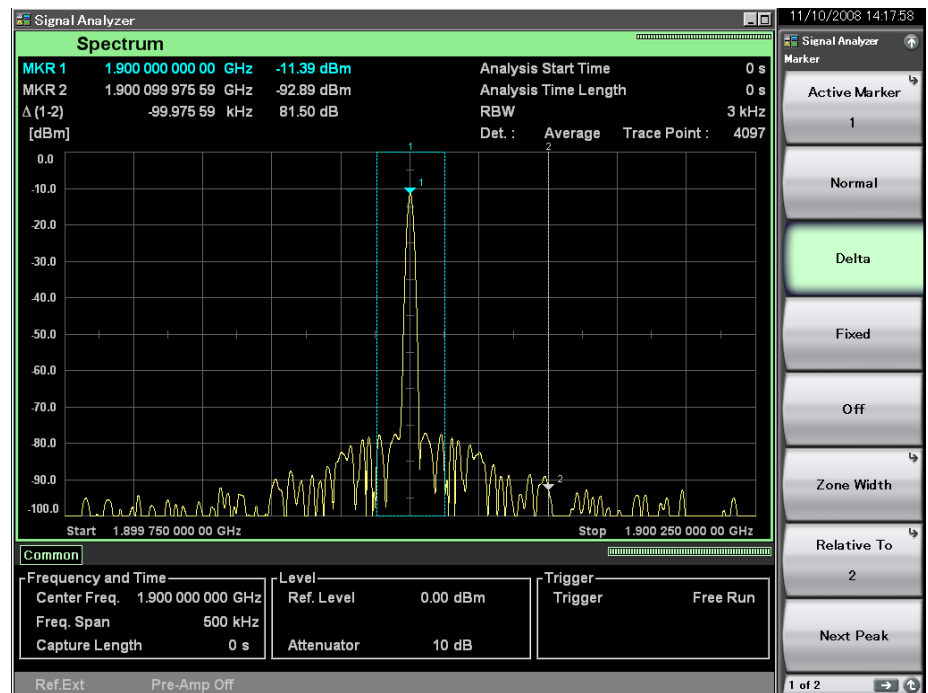

Figure 4.2.9-7 Measurement results

The measurement values can be converted to values in dBc/Hz units by the following formula:

$$CN = M + 10 \log(RBW)$$



where:

CN	C/N measurement value [dBc/Hz]
M	Difference marker value [dB]
RBW	RBW setting value [Hz]

Change the RBW value to select the best C/N measurement value.

4.2.10 Measure measurement

Measure function menu

Pressing  (Measure) on page 2 of the Trace function menu, or pressing  displays the Measure function menu.

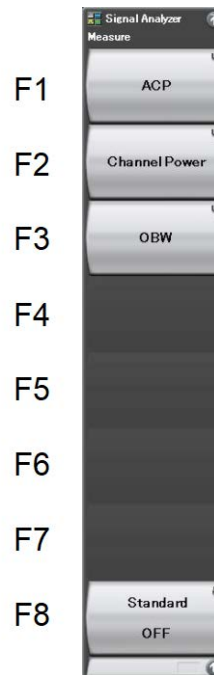



Figure 4.2.10-1 Measure function menu

Table 4.2.10-1 Measure function menu

Menu Display	Function
ACP	Performs adjacent channel leakage power measurement. Select the reference power, offset channel bandwidth, carrier bandwidth, carrier center frequency, offset channel to measure, and bandlimiting filter.
Channel Power	Performs power measurement in the specified frequency band. Sets the channel center frequency, channel bandwidth, and filter.
OBW	Measures the occupied bandwidth. Sets the dB value with the method, % power of the N% method, and X dB method.
Standard	Specify the communication method of the input signals to automatically set the parameters corresponding to the communication method. Disables the parameter load function (Load Standard Parameter) corresponding to the communication method.  Appendix C “Standard Parameter List” When moving to the function menu of each measure function that has been set to Off, the parameters corresponding to the communication method are automatically loaded. When moving to the function menu of each measure function that has been set to On, no parameter is automatically loaded.

ACP function menu

Pressing  (ACP) on the Measure function menu displays the ACP function menu.

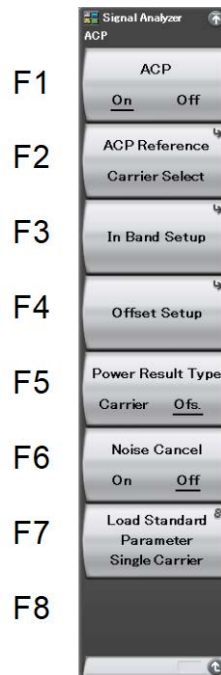



Figure 4.2.10-2 ACP function menu

Table 4.2.10-2 ACP function menu

Menu Display	Function
ACP (On/Off)	When it is set to On, other measure functions of the same trace are set to Off.
ACP Reference	<p>Sets the reference power.</p> <p>Span Total: Uses the integral power on the entire screen as a reference.</p> <p>Carrier Total: Uses the total value of all carrier power as a reference.</p> <p>Both Sides of Carriers: The carrier power of the largest carrier number is used as a reference for the upper offset, while the carrier power of the smallest carrier number is used as reference.</p> <p>Carrier Select: Carrier number used as a reference when the reference of the relative level display for Adjacent Channel Power measurement is set to Carrier.</p>
In Band Setup	Performs a setting for In-Band.
Offset Setup	Performs a setting for Offset Channel
Power Result Type (Carrier/Ofs.)	Switches Power Result Display. Displays Carrier Power Result when Carrier is selected, and displays Offset Channel Power Result when Ofs. is selected.
Noise Cancel (On/Off)	<p>Sets On/Off for the noise canceling function. When executed, it measures the internal noise of this instrument and the measured noise is deducted from the measurement value. This function is available only when Standard Parameter is set.</p> <p>Note: The internal noise may not be measured properly when the input signal level is high.</p>
Load Standard Parameter	<p>Loads the measurement parameters corresponding to the communication method selected in Standard when anything other than Off is set in Standard.</p> <p> Appendix C "Standard Parameter List"</p>

In Band Setup function menu

Press  (In Band Setup) on the ACP function menu to display the In Band Setup menu.

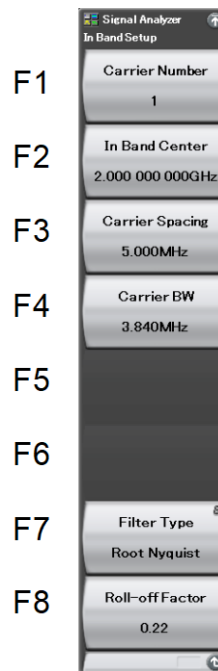



Figure 4.2.10-3 In Band Setup function menu

Table 4.2.10-3 In Band Setup function menu

Menu display	Function
Carrier Number	Sets the number of carriers.
In-Band Center	Sets the center frequency of In-Band.
Carrier Spacing	Sets an interval between carriers.
Carrier BW	Sets a bandwidth of a carrier.
Filter Type	Sets a filter type of a carrier. Selects the type from Rectangular, Nyquist, and Root Nyquist.
Roll-off Factor	Sets a roll-off factor. Available only when Nyquist or Root Nyquist is selected in Filter Type.

The Offset Setup function menu consists of two pages. Press  to change the page.

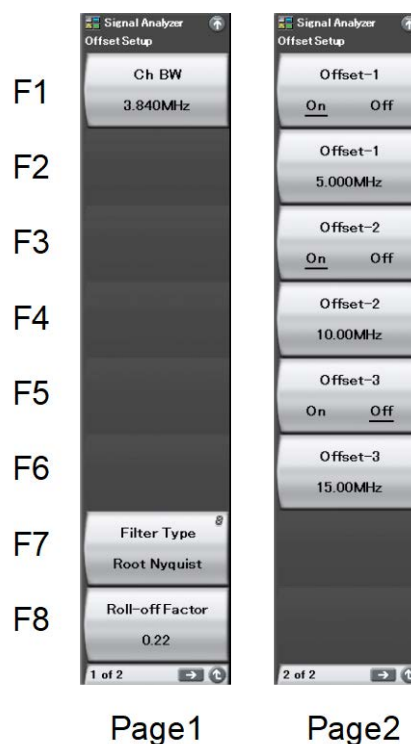

Figure 4.2.10-4 Offset Setup Function Menu

Table 4.2.10-4 Offset Setup Function Menu

Menu display	Function
Ch BW	Sets a bandwidth of the Offset Channel.
Filter Type	Sets a filter type of the Offset Channel. Selects a filter type from Rectangular, Nyquist, and Root Nyquist.
Roll-off Factor	Sets a roll-off factor. Available only when either Nyquist or Root Nyquist is selected in Filter Type.
Offset-1 (On/Off)	Sets Offset Channel 1 to On/Off.
Offset-1	Sets an offset frequency of Offset Channel 1.
Offset-2 (On/Off)	Sets Offset Channel 2 On/Off.
Offset-2	Sets an offset frequency of Offset Channel 2.
Offset-3 (On/Off)	Sets Offset Channel 3 to On/Off.
Offset-3	Sets an offset frequency of Offset Channel 3.

(1) Measuring the adjacent channel leakage power

The leakage power of the adjacent channel is measured.

The display items for the measurement results when Power Result Type is set to Offset are described below.

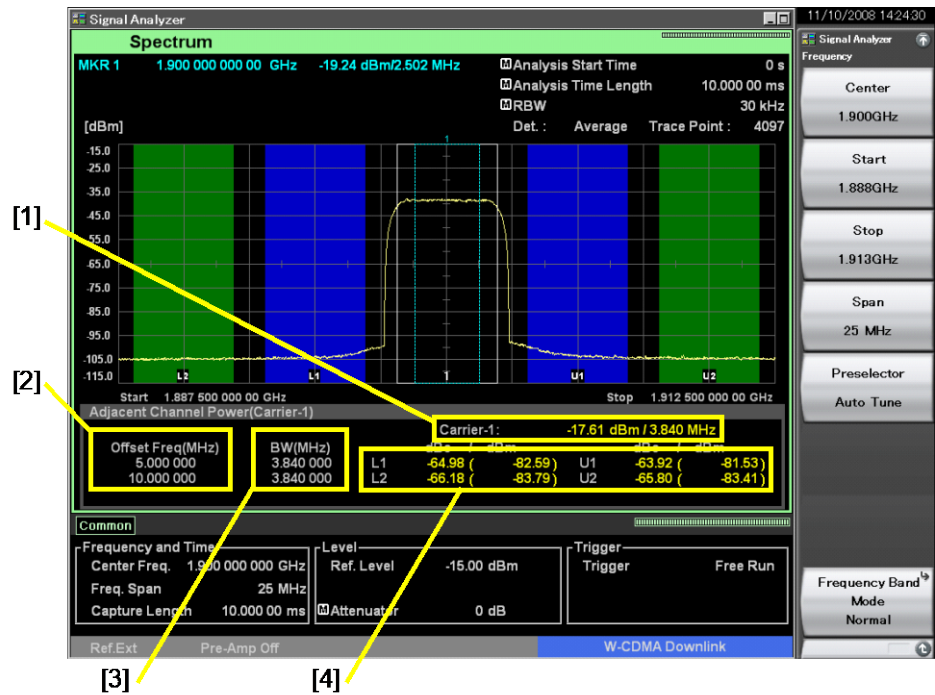

Figure 4.2.10-5 Display items for measurement results

Table 4.2.10-5 Display items for measurement results

No.	Display	Descriptions
[1]	Span Total/Carrier Total/Carrier-X	Displays the integral power in the screen display band when “ACP Reference” is “Span Total,” or the integral power in In-Band when “ACP Reference” is “Carrier Total.” Displays the selected carrier power when “ACP Reference” is “Carrier Select”. Displays the carrier power on both sides when “ACP Reference” is “Both Sides of Carriers”.
[2]	Offset Freq	Displays the setting of the offset frequency.
[3]	BW	Displays the setting of the channel bandwidth.
[4]	L1/L2/U1/U2	Displays the relative value of the total power of the Offset Channel bandwidth around Offset-1 to 3 and the reference power selected in “ACP Reference”. It also displays the total power of the Offset Channel bandwidth around Offset-1 to 3 in parentheses.

The display items for the measurement results when Power Result Type is set to Carrier are described below.

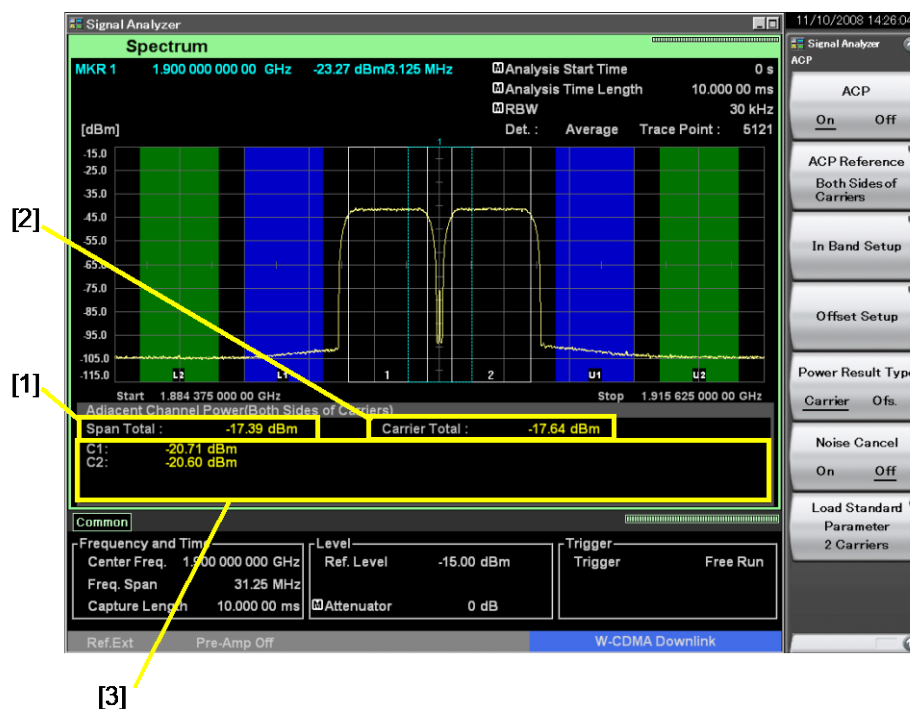



Figure 4.2.10-6 Display items for measurement results

Table 4.2.10-6 Display items for measurement results

No.	Display	Descriptions
[1]	Span Total	Displays the integral power in the screen display band. Displays it irrespective of the ACP Reference setting.
[2]	Carrier Total	Displays the integral power of the carrier set in Carrier Number. Does not display it when the ACP reference is set to Span Total.
[3]	Cx (x:Carrier Number)	Displays all the carrier powers set in Carrier Number. Does not display any of them when ACP Reference is set to Span Total.

Channel Power function menu

Pressing  (Channel Power) on the Measure function menu displays the Channel Power function menu.

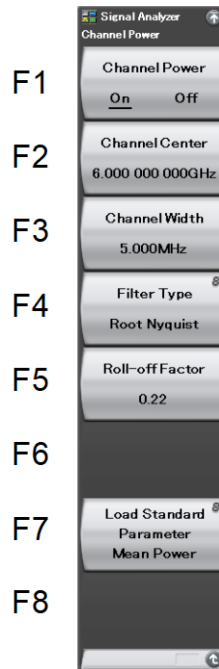



Figure 4.2.10-7 Channel Power function menu

Table 4.2.10-7 Channel Power function menu

Menu Display	Function
Channel Power (On/Off)	When it is set to On, other measure functions of the same trace are set to Off.
Channel Center	Sets the channel center frequency.
Channel Width	Sets the channel bandwidth.
Filter Type	Sets the filter shape. Selected the shape from “Rect,” “Nyquist,” and “Root Nyquist.”
Roll-off Factor	Sets the roll-off factor. It is effective only if “Nyquist” or “Root Nyquist” is selected for Filter Type.
Load Standard Parameter	Loads the measurement parameters corresponding to the communication method selected in Standard when anything other than Off is set in Standard.  Appendix C “Standard Parameter List”

(2) Measuring the channel power

The channel power is measured.

The display items for the measurement results are described below.

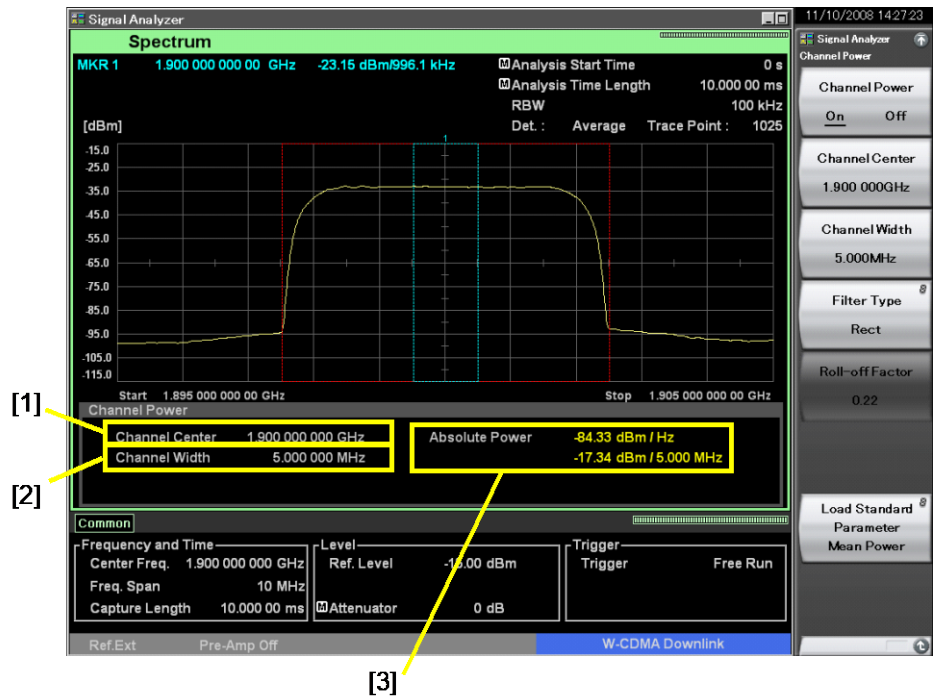

4

Trace

Figure 4.2.10-8 Display items for measurement results

Table 4.2.10-8 Display items for measurement results

No.	Display	Descriptions
[1]	Channel Center	Displays the setting value of the channel center frequency.
[2]	Channel Width	Displays the setting value of the channel bandwidth.
[3]	Absolute Power	Displays the absolute power per 1 Hz in the channel band and the integral power in the channel band.

OBW function menu

Pressing  (OBW) on the Measure function menu displays the OBW function menu.

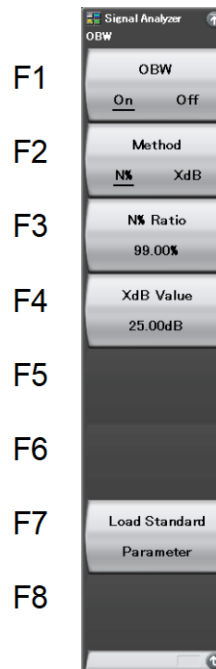



Figure 4.2.10-9 OBW function menu

Table 4.2.10-9 OBW function menu

Menu Display	Function
OBW (On/Off)	When this is set to On, other measure functions of the same trace are set to Off.
Method (N%/XdB)	<p>Selects the measurement method. X dB Down mode or N% of Power mode can be selected.</p> <ul style="list-style-type: none"> • XdB Down mode OBW is the width between 2 points below XdB from the peak point of the trace data. • N% of Power mode OBW is the width between 2 points with the power equivalent to (100 – N/2)% when power is added by 1 point from both ends of the screen, assuming the power total of the trace data in the screen is 100%.
N% Ratio	Inputs the % power in the N% of Power mode.
XdB Value	Inputs the dB value in the X dB Down mode.
Load Standard Parameter	<p>Loads the measurement parameters corresponding to the communication method selected in Standard when anything other than Off is set in Standard.</p> <p> Appendix C “Standard Parameter List”</p>

(3) Measuring the occupied bandwidth

The occupied bandwidth is measured.

The display items for the measurement results are described below.

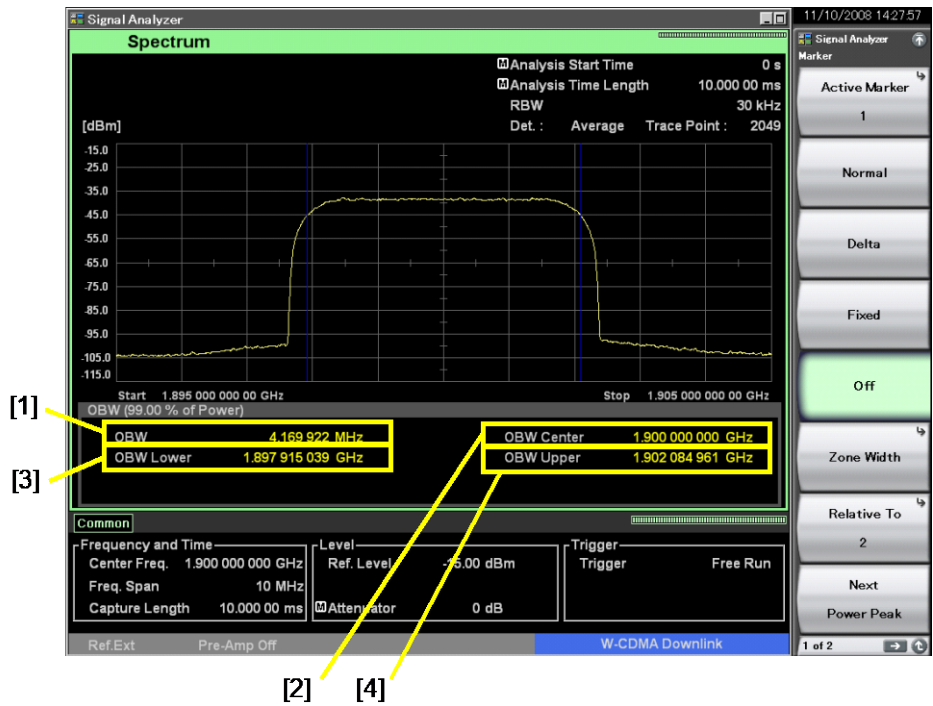

4

Trace

Figure 4.2.10-10 Display items for measurement results

Table 4.2.10-10 Display items for measurement results

No.	Display	Description
[1]	OBW	Displays the occupied bandwidth.
[2]	OBW Center	Displays the center frequency of the occupied bandwidth.
[3]	OBW Lower	Displays the left frequency of the occupied bandwidth.
[4]	OBW Upper	Displays the right frequency of the occupied bandwidth.

(4) Example of adjacent channel leakage power measurement

For measurement of the adjacent channel leakage power of the W-CDMA modulation method signal, the detection mode is set to Average.

<Measurement block>

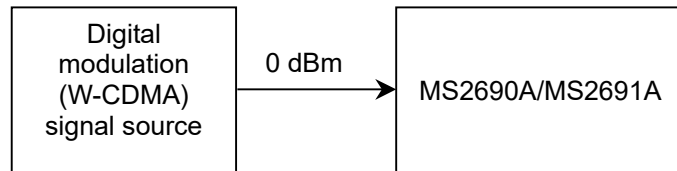

Center frequency: 1.92 GHz
 Frequency span: 25 MHz
 RBW: 30 kHz

Figure 4.2.10-11 Measurement block diagram

<Procedure>

1. Press **Preset**, and then press **F1** (Preset).
2. Press **Span**.
3. Press **2** **5**, and then press **F2** (MHz) to set the frequency span.
4. Press **Frequency**.
5. Press **1** **.** **9** **2**, and then press **F1** (GHz) to set the center frequency.
6. Press **BW**.
7. Press **3** **0**, and then press **F3** (kHz) to set the resolution bandwidth.
8. Press **Amplitude**, and then press **F1** (Reference Level).
9. Press **0**, and then press **F7** (Set) to set the reference level.
10. Press **Trace**, and then press **F7** (Time Detection) to select Average.
11. Press **Time/Sweep**, and then press **F3** (Time Length).
12. Press **1** **0**, and then press **F2** (ms) to set the analysis time length.
13. Press **Measure**, and then press **F1** (ACP).
14. Press **F4** (Offset Setup).
15. Press **F1** (Ch BW).
16. Press **3** **.** **8** **4**, and then press **F2** (MHz) to set the offset channel bandwidth.
17. Press **F7** (Filter Type) to select Root Nyquist.
18. Press **F8** (Roll-off Factor).

19. Press **0** **.** **2** **2**, and then press **F7** (Set) to set a Roll-Off factor.
20. Press **→** to switch the function menu to page 2.
21. Press **F2** (Offset-1).
22. Press **5**, and then press **F2** (MHz) to set Offset frequency-1.
23. Press **F4** (Offset-2).
24. Press **1** **0**, and then press **F2** (MHz) to set Offset frequency-2.
25. Press **Measure**, and then press **F1** (ACP).
26. Press **F3** (In-Band Setup).
27. Press **F3** (Carrier BW).
28. Press **3** **.** **8** **4**, and then press **F2** (MHz) to set the carrier bandwidth.
29. Press **F7** (Filter Type) to select Root Nyquist.
30. Press **F8** (Roll-off Factor).
31. Press **0** **.** **2** **2**, and then press **F7** (Set) to set a Roll-Off factor.
32. Press **Measure**, and then press **F1** (ACP).
33. Press **F2** (ACP Reference), and then press **F2** (Carrier Total).
34. Press **Measure**, and then press **F1** (ACP).
35. Press **F1** (ACP On/Off) to select On.

Note:

The relative level reference value for each calculation method is as follows:

Span Total method: Total of the power of all waveform data on the screen

Carrier Total method: Total of the carrier power

Both Sides of Carriers method:

The strongest power of the carrier number is used as a reference for the upper offset, whereas the weakest power is used as a reference for the lower offset.

Carrier Select method: Selected carrier power

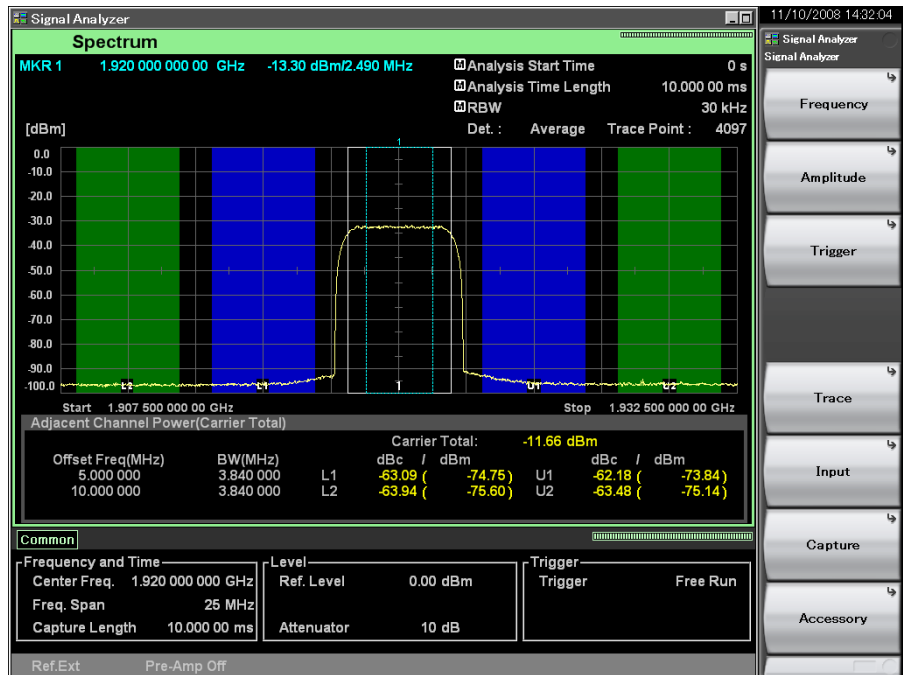
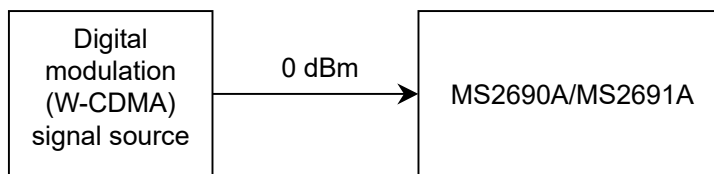

Figure 4.2.10-12 Results of measurement example

(5) Example of channel power measurement

<Measurement block>



Center frequency: 1.92 GHz
 Frequency span: 10 MHz
 RBW: 100 kHz

Figure 4.2.10-13 Measurement block diagram

<Procedure>

1. Press **Preset**, and then press **F1** (Preset).
2. Press **Span**.
3. Press **1** **0**, and then press **F2** (MHz) to set the frequency span.
4. Press **Frequency**.
5. Press **1** **.** **9** **2**, and then press **F1** (GHz) to set the center frequency.
6. Press **BW**.
7. Press **1** **0** **0**, and then press **F3** (kHz) to set the resolution bandwidth.
8. Press **Amplitude**, and then press **F1** (Reference Level).
9. Press **0**, and then press **F7** (Set) to set the reference level.
10. Press **Trace**, and then press **F7** (Time Detection) to select Average.
11. Press **Time/Sweep**, and then press **F3** (Time Length).
12. Press **1** **0**, and then press **F2** (ms) to set the analysis time length.
13. Press **Measure**.
14. Press **F2** (Channel Power), and then press **F3** (Channel Width).
15. Press **5**, and then press **F2** (MHz) to set the channel bandwidth.
16. Press **F4** (Filter Type), select "Rect," and then press **Enter**.
17. Press **F1** (Channel Power On/Off) to select On.

Note:

Weighting can be done with the filter.

Rect: Rectangular filter

Nyquist: Nyquist filter

Root Nyquist: Root Nyquist filter

For the Nyquist filter and Root Nyquist filter, set the roll-off factor.

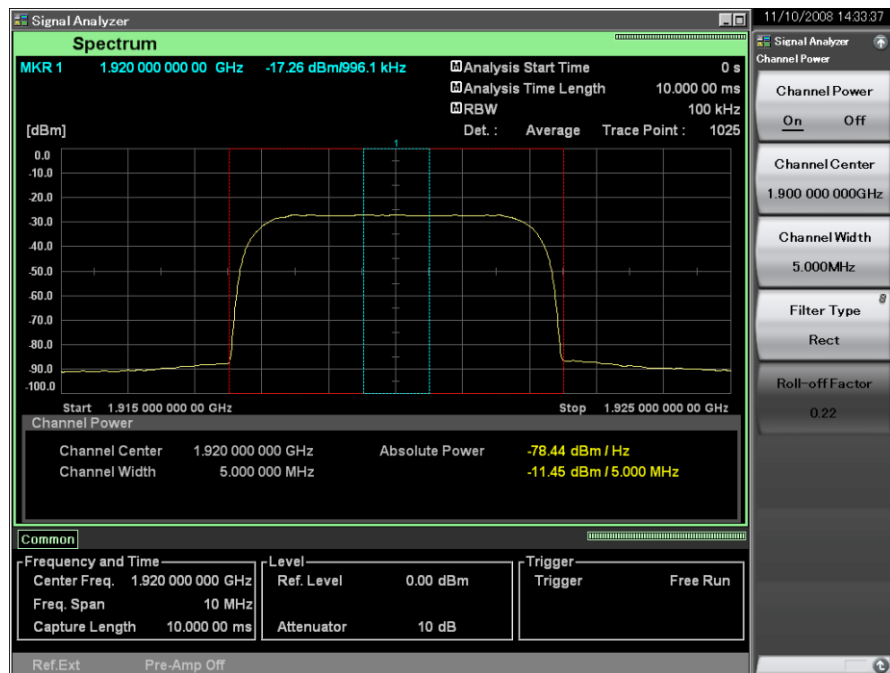
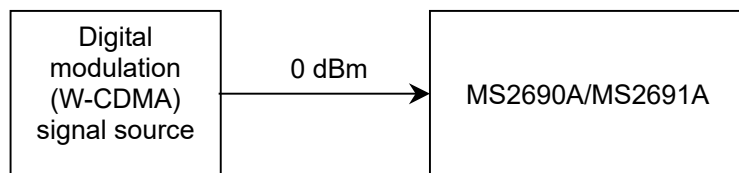

Figure 4.2.10-14 Measurement results

(6) Example of occupied frequency bandwidth measurement

For a signal source of the W-CDMA modulation method, the detection mode is set to Average.

<Measurement block>



Center frequency: 1.92 GHz

Frequency span: 10 MHz

RBW: 30 kHz

Figure 4.2.10-15 Measurement block diagram

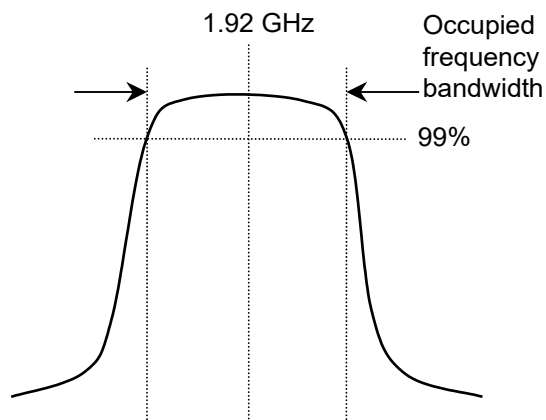

Figure 4.2.10-16 Measurement block diagram

<Procedure>

1. Press **Preset**, and then press **F1** (Preset).
2. Press **Span**.
3. Press **1** **0**, and then press **F2** (MHz) to set the frequency span.
4. Press **Frequency**.
5. Press **1** **.** **9** **2**, and then press **F1** (GHz) to set the center frequency.
6. Press **BW**.
7. Press **3** **0**, and then press **F3** (kHz) to set the resolution bandwidth.
8. Press **Amplitude**, and then press **F1** (Reference Level).
9. Press **1** **0**, and then press **F1** (dBm) to set the reference level.
10. Press **Time/Sweep**, and then press **F3** (Time Length).
11. Press **1** **0**, and then press **F2** (ms) to set the analysis time length.
12. Press **Measure**.
13. Press **F3** (OBW), and then press **F2** (Method) to select N% of Power.
14. Press **F3** (N% Ratio).
15. Press **9** **9**, and then press **F1** (%) to set %Power.
16. Press **F1** (OBW On/Off) to select On.

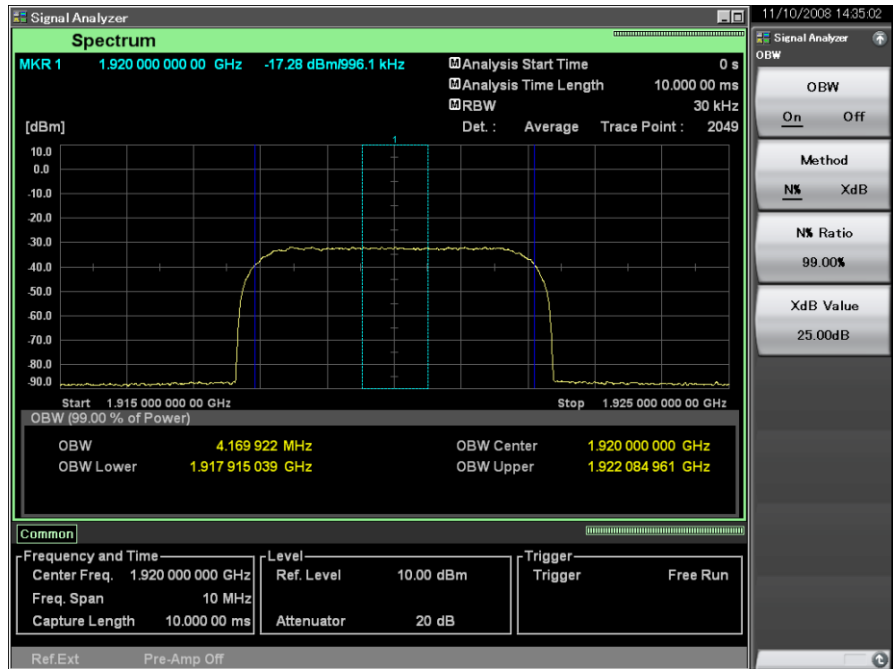



Figure 4.2.10-17 Measurement results

4.2.11 Executing Return to Spectrogram

After Analyze with Spectrum Trace has been executed on the Spectrogram trace, move on to the Spectrum trace, and press  and,  (Return to Spectrogram). Then you can return to the Spectrogram trace.

If you move on to Spectrogram trace by executing Return to Spectrogram, then the current analysis length parameters are changed to the same as the analysis length parameters set before executing Analyze with Spectrum on Spectrogram trace. Table 4.2.11-1 describes the parameters after executing Return to Spectrogram.

However, the settings are invalid if any analysis length parameter has been changed after executing Analyze with Spectrum. (See Table 4.2.11-2)

Table 4.2.11-1 Parameters after executing Return to Spectrogram

Parameter on Spectrogram trace	Setting value
RBW Auto/Manual	RBW Auto/Manual before executing Analyze with Spectrum Trace
RBW	RBW before executing Analyze with Spectrum Trace
Marker Type	Marker Type before executing Analyze with Spectrum Trace
Marker Result	Marker Result before executing Analyze with Spectrum Trace
Time Detection	Detection before executing Analyze with Spectrum Trace
Analysis Start Time	Analysis Start Time before executing Analyze with Spectrum Trace
Analysis Time Length	Analysis Time Length before executing Analyze with Spectrum Trace
Storage Mode	Storage Mode before executing Analyze with Spectrum Trace
Storage Count	Storage Count before executing Analyze with Spectrum Trace
Frequency Zone Center	Zone Center before executing Analyze with Spectrum Trace
Frequency Zone Width	Zone Width before executing Analyze with Spectrum Trace
Analysis Time Auto/Manual	Analysis Time Auto/Manual before executing Analyze with Spectrum Trace

Table 4.2.11-2 Analysis Length Parameter

Analysis Length Parameter
The setting of Capture Time Auto/Manual was changed.
Center Frequency was changed.
The setting of Capture Time Length was changed when Capture Time = Manual.
The setting of Span was changed.
The setting of Terminal was changed.
Preset was executed.
Parameter Recall was executed.
The application was restarted.
Trace Mode was switched.
Load Standard Parameter was executed.
Signal Analyzer function was transmitted from another application.

4.3 Power vs Time

4.3.1 What is Power vs Time trace?

Power vs Time trace is a screen to observe the time fluctuations of power of the obtained measured signal.

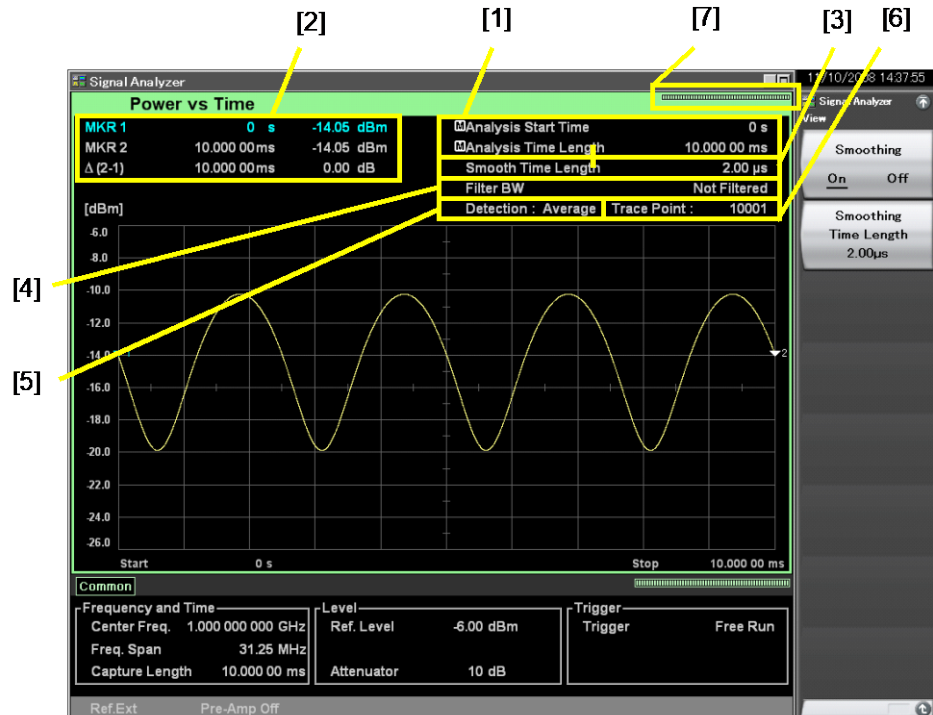

4 Trace

Figure 4.3.1-1 Display items for Power vs Time trace

Table 4.3.1-1 Display items for Power vs Time trace

No.	Display	Descriptions
[1]	Analysis Start Time/ Analysis Time Length	Displays the analysis start time and analysis time length.
[2]	MKR1/MKR2/ Δ(2 - 1)	Displays the marker result value and marker time position.
[3]	Smooth Time Length	Displays the smoothing time length when Smoothing is On.
[4]	Filter BW	Displays the filter bandwidth. "Not Filtered" is displayed when the filter is Off.
[5]	Detection	Displays the detection mode.
[6]	Trace Point	Displays the trace point count (horizontal axis).
[7]	Indicator	Displays the indicator indicating the analysis progress rate.

4.3.2 Setting Power vs Time parameters

After selecting “Power vs Time” for Trace Mode, pressing **F6** (Trace) from the Main function menu or pressing **Trace** displays the Trace function menu.

The Trace function menu consists of two pages, which can be toggled by pressing **→**.

 4.1 “Selecting Trace”

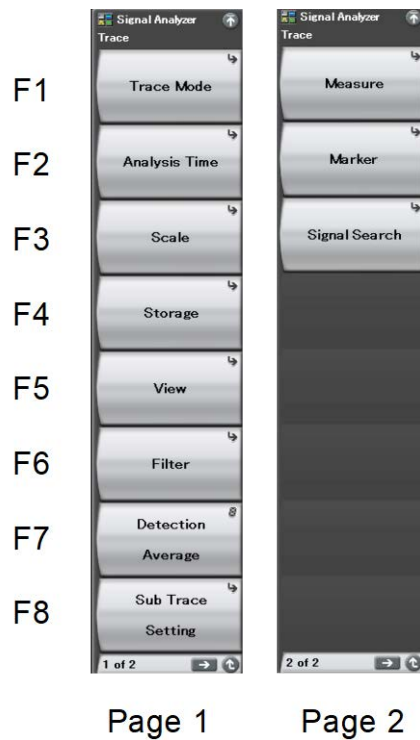















Figure 4.3.2-1 Trace function menu

Table 4.3.2-1 Trace function menu

Menu Display	Function
Trace Mode	Sets the trace type.  4.1 "Selecting Trace"
Analysis Time	Used for setting related to the time.  4.3.3 "Setting analysis time"
Scale	Used for setting related to the scale.  4.3.4 "Setting scale"
Storage	Used for setting related to update and display of trace data.  4.3.7 "Setting storage mode"
Filter	Selects the filter type.  4.3.5 "Setting filter"
View	Sets the smoothing.  4.3.6 "Setting smoothing"
Detection	Used for setting related to detection.  4.3.8 "Setting detection mode"
Sub Trace Setting	Used for setting related to sub-trace.  4.9 "Sub-Trace"
Measure	Used for setting related to the Measure function.  4.3.11 "Measure measurement"
Marker	Used for setting related to the marker.  4.3.9 "Setting markers"
Signal Search	Used for setting related to feature-point search within the measurement band.  4.3.10 "Setting marker search"

4.3.3 Setting analysis time

Pressing  (Analysis Time) from the Trace function menu, or pressing  displays the Analysis Time function menu.

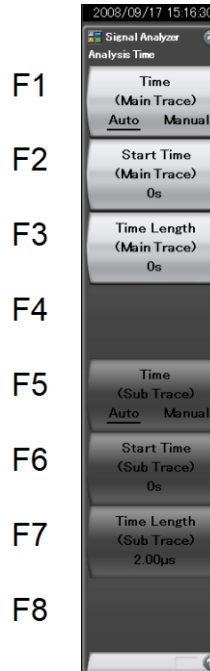

Figure 4.3.3-1 Analysis Time function menu

Table 4.3.3-1 Analysis Time function menu

Menu Display	Function
Time (Main Trace) (Auto/Manual)	Switches between auto setting and manual setting for the analysis start time (Analysis Start Time) and analysis time length (Analysis Time Length).
Start Time (Main Trace)	Sets the analysis start time.
Time Length (Main Trace)	Sets the analysis time length.
Time (Sub Trace) (Auto/Manual)	Switches between auto setting and manual setting for the analysis start time (Analysis Start Time) and analysis time length (Analysis Time Length) of a sub-trace.
Start Time (Sub Trace)	Sets the analysis start time of a sub-trace.
Time Length (Sub Trace)	Sets the analysis time length of a sub-trace.

Setting the analysis time

Analysis time is the time to be analyzed. The analysis time can be specified with the analysis start position (Analysis Start Time) and analysis time length (Analysis Time Length).

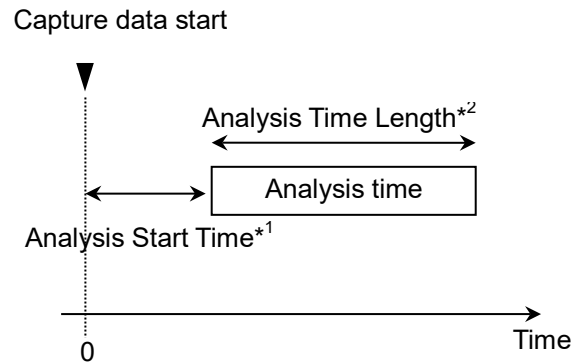

*1: Start of Analysis time based on capture data start

*2: Length of analysis time

Figure 4.3.3-2 Analysis time

(1) Auto mode

When Capture Time is set to Auto, the analysis time length is set to 100 ms for measurement. When Capture Time is set to Manual, the analysis time length is set to the capture time for measurement.

Table 4.3.3-2 Setting analysis time in the Auto mode

Capture Time	Analysis Start Time [s]	Analysis Time Length [s]
Auto	0	0.1
Manual	0	x_1

x_1 : Capture time length [s]

 2.4 "Setting IQ Data Capture Time Range"

(2) Manual mode

The analysis start time and analysis time length are set manually. This is an effective method to perform measurement of discontinuous signals such as burst.

Analysis start time setting range

Table 4.3.3-3 Analysis start time setting range in Manual mode

Capture Time	Minimum Value [s]	Maximum Value [s]
Auto	0	$x_2 - x_1$
Manual	0	$x_3 - x_1$

x_1 : Analysis time length [s]

x_2 : Capture time length [s], capture time length maximum value [s]

 2.4 "Setting IQ Data Capture Time Range"

x_3 : Capture time length [s]

 2.4 "Setting IQ Data Capture Time Range"

Analysis time length setting range

Table 4.3.3-4 Analysis time length setting range

Capture Time	Minimum Value [s]	Maximum Value [s]
Auto	$\frac{100}{x_4}$	$x_2 - x_1$
Manual	$\frac{100}{x_4}$	$x_3 - x_1$

x_1 : Analysis start time [s]

x_2 : Capture time length maximum value [s]

 2.4 "Setting IQ Data Capture Time Range"

x_3 : Capture time length [s]

 2.4 "Setting IQ Data Capture Time Range"

x_4 : Sampling rate [Hz]

 2.2.2 "Setting frequency span"

Note:

The maximum value may be less than this value because of the restrictions imposed by the resolution of the analysis time length.

Analysis start time resolution**Table 4.3.3-5 Frequency span and resolution**

Frequency Span	Resolution
1 kHz	0.5 ms
2.5 kHz	0.2 ms
5 kHz	0.1 ms
10 kHz	50 μ s
25 kHz	20 μ s
50 kHz	10 μ s
100 kHz	5 μ s
250 kHz	2 μ s
500 kHz	1 μ s
1 MHz	0.5 μ s
2.5 MHz	0.2 μ s
5 MHz	0.1 μ s
10 MHz	50 ns
25 MHz	20 ns
31.25 MHz	20 ns
50 MHz* ¹	10 ns
62.5 MHz* ²	10 ns
100 MHz* ³	5 ns
125 MHz* ³	5 ns

*1: 50 MHz can be set only when Option 004/104/077/177 is installed.









*2: 62.5 MHz can be set only when Option 077/177 is installed.

*3: 100 MHz and 125 MHz can be set only when Option 004/104/078/178 is installed.

Setting procedure for Analysis Time



Example: To switch the analysis time to Manual setting, and setting the analysis start time to 20 ms and analysis time to 2 ms

<Procedure>

1. Press .
2. Press  (Start Time).
3. Press  , and then press  (ms) to set the analysis start time.
4. Press  (Time Length).
5. Press , and then press  (ms) to set the analysis start time length.

4.3.4 Setting scale

Scale function menu

Pressing  and then  (Scale) displays the Scale function menu.

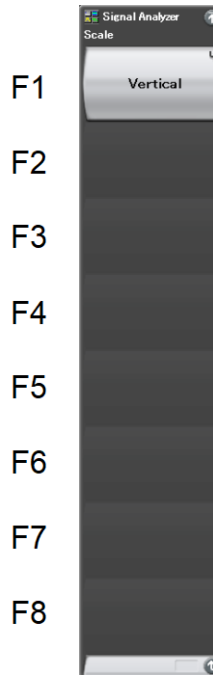

Figure 4.3.4-1 Scale function menu

Table 4.3.4-1 Scale function menu

Menu Display	Function
Vertical	Used for setting related to the vertical axis (level axis) scale.

Vertical function menu

Pressing **F1** (Vertical) on the Scale function menu displays the Vertical function menu.



Figure 4.3.4-2 Vertical function menu









Table 4.3.4-2 Vertical function menu

Menu Display	Function
Log Scale Division	Sets the scale range (Log scale range) of the vertical axis.
Lin Scale Division	Sets the scale range (Lin scale range) of the vertical axis.
Log Scale Line (10/12)	Sets the number of scale lines when the Log scale is used.

(1) Vertical axis scale

The scale range Log scale and Lin scale of the level axis are set.

Example: To set the vertical axis scale range (Log scale) to 0.1 dB/Div
<Procedure>

1. Press .
2. Press  (Scale).
3. Press  (Vertical), and then press  (Log Scale Division).
4. Press   , and then press  (dB/div) to set the 0.1 dB/Div scale.

Setting range and resolution for scale range of vertical axis

Setting range:	0.1 to 20 dB/Div (log scale) 1 to 10%/Div (linear scale)
Minimum resolution:	0.1 dB/Div (log scale) 1%/Div (linear scale)
Rotary knob resolution:	1-2-5 sequence
Step key resolution:	1-2-5 sequence

4.3.5 Setting filter

Pressing **F0** (Filter) on the Trace function menu, or pressing **BW** displays the Filter function menu.



Figure 4.3.5-1 Filter function menu

Table 4.3.5-1 Filter function menu

Menu Display	Function
Type	Selects the filter type.
Roll-off Factor	Sets the roll-off factor.
Band Width	Sets the filter band.
Freq. Offset	Sets the frequency offset for the filter.

Setting range and resolution for roll-off factor

Setting range:	0.01 to 1
Minimum resolution:	0.01
Rotary knob resolution:	0.01
Step key resolution:	0.1

Setting range and resolution for filter band

Setting range:	Refer to Table 4.3.5-2 (Rect). Refer to Table 4.3.5-3 (Gauss, Nyquist, Root Nyquist).
Minimum resolution:	1 kHz 1 Hz (SPAN = 2.5 kHz, Filter Type = Gauss)
Rotary knob resolution:	$\frac{x}{100}$ Hz
Step key resolution:	$\frac{x}{10}$ Hz
x :	Frequency span [Hz]

Setting range and resolution for filter offset

Setting range:	$-x$ to x
Minimum resolution	1 Hz
Rotary knob resolution:	$\frac{x}{100}$ Hz
Step key resolution:	$\frac{x}{10}$ Hz
x :	Frequency span [Hz]

Table 4.3.5-2 Filter band setting range (Rect)

Frequency Span	Minimum Value	Maximum Value
1 kHz	N/A	
2.5 kHz	1 kHz	2 kHz
5 kHz	1 kHz	4 kHz
10 kHz	1 kHz	9 kHz
25 kHz	1 kHz	23 kHz
50 kHz	2 kHz	47 kHz
100 kHz	4 kHz	95 kHz
250 kHz	8 kHz	238 kHz
500 kHz	16 kHz	476 kHz
1 MHz	32 kHz	952 kHz
2.5 MHz	79 kHz	2.38 MHz
5 MHz	157 kHz	4.761 MHz
10 MHz	313 kHz	9.523 MHz
25 MHz	782 kHz	23.809 MHz
31.25 MHz	977 kHz	29.761 MHz
50 MHz* ¹	1.563 MHz	47.619 MHz
62.5 MHz* ²	1.953 MHz	59.523 MHz
100 MHz* ³	3.126 MHz	95.238 MHz
125 MHz* ³	3.907 MHz	119.047 MHz

*1: 50 MHz can be set only when Option 004/104/077/177 is installed.

*2: 62.5 MHz can be set only when Option 077/177 is installed.

*3: 100 MHz and 125 MHz can be set only when Option 004/104/078/178 is installed.

Table 4.3.5-3 Filter band setting range (Gauss, Nyquist, Root Nyquist)

Frequency Span	Minimum Value	Maximum Value
1 kHz	N/A	
2.5 kHz	1 kHz 1 Hz (Gauss only)	1 kHz
5 kHz	1 kHz	2 kHz
10 kHz	1 kHz	4 kHz
25 kHz	1 kHz	10 kHz
50 kHz	2 kHz	20 kHz
100 kHz	4 kHz	40 kHz
250 kHz	8 kHz	100 kHz
500 kHz	16 kHz	200 kHz
1 MHz	32 kHz	400 kHz
2.5 MHz	79 kHz	1 MHz
5 MHz	157 kHz	2 MHz
10 MHz	313 kHz	4 MHz
25 MHz	782 kHz	10 MHz
31.25 MHz	977 kHz	12.5 MHz
50 MHz* ¹	1.563 MHz	20 MHz
62.5 MHz* ²	1.953 MHz	25 MHz
100 MHz* ³	3.126 MHz	40 MHz
125 MHz* ³	3.907 MHz	50 MHz

*1: 50 MHz can be set only when Option 004/104/077/177 is installed.

*2: 62.5 MHz can be set only when Option 077/177 is installed.

*3: 100 MHz and 125 MHz can be set only when Option 004/104/078/178 is installed.

(1) Gauss filter

Example: To set the filter shape to Gaussian, filter bandwidth to 3.84 MHz, and filter frequency offset to 1 MHz

<Procedure>

1. Press **BW**.
2. Press **F1** (Type) and select Gaussian.
3. Press **F3** (Band Width).
4. Press **3** **.** **8** **4**, and then press **F2** (MHz) to set the filter band.
5. Press **F4** (Freq. Offset).
6. Press **1**, and then press **F2** (MHz) to set the filter frequency offset.

(2) Rectangular filter

Example: To set the filter shape to "Rect," filter bandwidth to 3.84 MHz, and filter frequency offset to 1 MHz

<Procedure>

1. Press **BW**.
2. Press **F1** (Type) and select Rect.
3. Press **F3** (Band Width).
4. Press **3** **.** **8** **4**, and then press **F3** (MHz) to set the filter band.
5. Press **F4** (Freq. Offset).
6. Press **1**, and then press **F2** (MHz) to set the filter frequency offset.

(3) Nyquist filter

Example: To set the filter shape to Nyquist, filter bandwidth to 3.84 MHz, filter frequency offset to 1 MHz, and roll-off factor to 0.22

<Procedure>

1. Press **BW**.
2. Press **F1** (Type) and select Nyquist.
3. Press **F3** (Band Width).
4. Press **3** **.** **8** **4**, and then press **F2** (MHz) to set the filter band is set.
5. Press **F4** (Freq. Offset).
6. Press **1**, and then press **F2** (MHz) to set the filter frequency offset.
7. Press **F2** (Roll-off Factor).
8. Press **0** **.** **2** **2**, and then press **F7** (Set) to set the roll-off factor.

(4) Root Nyquist filter

Example: To set the filter shape to Root Nyquist, filter bandwidth to 3.84 MHz, filter frequency offset to 1 MHz, and roll-off factor to 0.22

<Procedure>

1. Press **BW**.
2. Press **F1** (Type) and select Root Nyquist.
3. Press **F3** (Band Width).
4. Press **3** **.** **8** **4**, and then press **F2** (MHz) to set the filter band.
5. Press **F4** (Freq. Offset).
6. Press **1**, and then press **F2** (MHz) to set the filter frequency offset.
7. Press **F2** (Roll-off Factor).
8. Press **0** **.** **2** **2**, and then press **F7** (Set) to set the roll-off factor.

The table below shows the setting of filter type that complies with the ETSI EN 300 113 V2.2.1 Annex C1.1 IF filter.

Table 4.3.5-4 Filter Setting Examples

Channel Separation [kHz]	Filter Setting		
	Filter Type	Roll-off Factor	Band Width [kHz]
12.5	Root Nyquist	0.19	8
20	Nyquist	0.10	14
25	Nyquist	0.10	16

4.3.6 Setting smoothing

Pressing **Trace** and then **F6** (View) displays the View function menu.

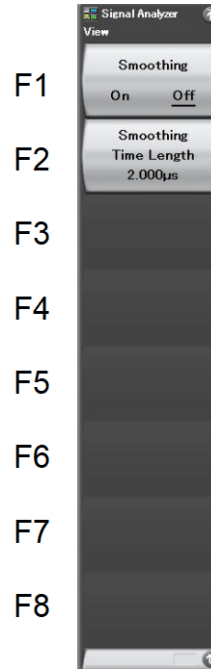

Figure 4.3.6-1 View function menu

Table 4.3.6-1 View function menu







Menu Display	Function
Smoothing (On/Off)	Sets smoothing to On/Off.
Smoothing Time Length	Sets the smoothing time length.

(1) Setting smoothing

Smoothing processing is performed. To lower the trace noise, the Smoothing function is set to On.

Example: To set the Smoothing function to On and smoothing time length to 50 μs

<Procedure>

1. Press .
2. Press  (View).
3. Press  (Smoothing On/Off) and select On.
4. Press  (Smoothing Time Length).
5. Press  , and then press  (μs) to set the smoothing time length.

Setting range and minimum resolution for smoothing time length

Setting range:	Time Resolution to 10000 \times Time Resolution
Minimum resolution:	Time Resolution

4.3.7 Setting storage mode

Pressing **Trace** and then **F4** (Storage) displays the Storage function menu.



Figure 4.3.7-1 Storage function menu

Table 4.3.7-1 Storage function menu

Menu Display	Function
Mode	Used for setting related to update and display of trace data.
Count	Sets the storage count.
Stop	Stops the storage.

Storage mode types

In a Power vs Time trace, the following four storage mode types can be selected.



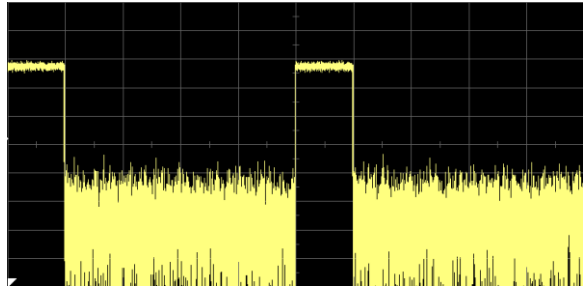
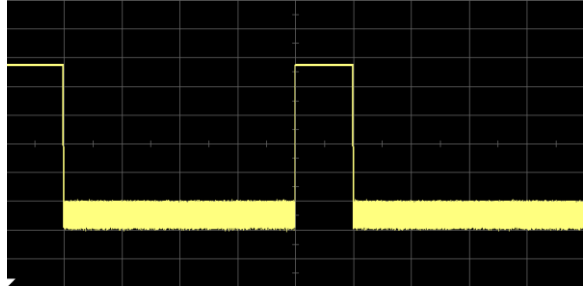
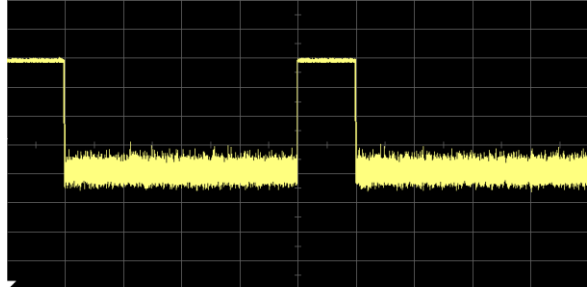
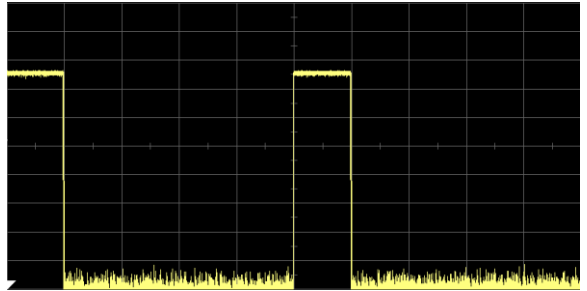





Table 4.3.7-2 Four storage mode types

Mode	Description	Display Example
Off	At each capture, the trace data are updated and displayed. These data are used for normal measurement.	
Lin Average	Performs averaging operation at each X axis point for each capture and displays the results. Averaging is done with linear values even in Log display. Used for S/N improvement.	
Max Hold	At each capture, the previous and new trace data of each X axis point are compared and the larger of the two is displayed. Used for recording signals with frequency drift.	
Min Hold	At each capture, the previous and new trace data of each X axis point are compared and the smaller of the two is displayed.	

(1) Selecting the storage mode and storage count

Example: To set the storage mode to Average and storage count to 100

<Procedure>

1. Press .
2. Press  (Storage).
3. Press  (Mode) and select Lin Average.
4. Press  (Count).
5. Press   , and then press  (Set).

Setting range and minimum resolution for storage count

Setting range:	2 to 9999
Minimum resolution:	1
Rotary knob resolution:	1 step
Step key resolution:	1 step at the highest 1st digit

(2) Averaging function

The digital averaging function, which performs an averaging operation at a point on the horizontal axis each time trace data is captured and displays the trace, can be executed by selecting Lin Average in the storage mode.

When the measurement mode is set to Single, measurement stops when capture for the storage count is completed. When the measurement mode is set to Continuous, averaging is continued even when capture for the storage count is completed. However, the average after completion of the storage count is calculated as shown in Table 4.3.7-3, so the effect of old data becomes less as the storage count increases.

Table 4.3.7-3 Averaging

Capture Count n	Measurement Value M(n)	Displayed Value Y(n)
1	M(1)	$Y(1) = M(1)$
2	M(2)	$Y(2) = \frac{Y(1) + M(2)}{2}$
3	M(3)	$Y(3) = \frac{2 \times Y(2) + M(3)}{3}$
...
N - 1	M(N - 1)	$Y(N - 1) = \frac{(N - 2) \times Y(N - 2) + M(N - 1)}{N - 1}$
N	M(N)	$Y(N) = \frac{(N - 1) \times Y(N - 1) + M(N)}{N}$
Continuous only		
N + 1	M(N + 1)	$Y(N + 1) = \frac{(N - 1) \times Y(N) + M(N + 1)}{N}$
N + 2	M(N + 2)	$Y(N + 1) = \frac{(N - 1) \times Y(N) + M(N + 1)}{N}$
...

Note:

When Storage Count = N

Using the averaging function can improve S/N according to the storage count and capture count.

4.3.8 Setting detection mode

The detection mode can be selected by pressing **Trace** and then **F7** (Detection).

Detection mode types

The detection mode in the analysis range (Detection) is set. The detection mode can be selected from the 4 types: Average, Positive, Negative, and Pos & Neg.

Table 4.3.8-1 Detection mode

Detection mode	Description
Pos&Neg	Displays the line connecting the maximum and minimum values of the sampling points within the analysis range. Used for normal measurement.
Positive	Displays the maximum value of the sampling points within the analysis range.
Negative	Displays the minimum value of the sampling points within the analysis range. The lower envelope of the modulation waveform is measured in "Negative" mode.
Average	Displays the average value of the sampling points within the analysis range.

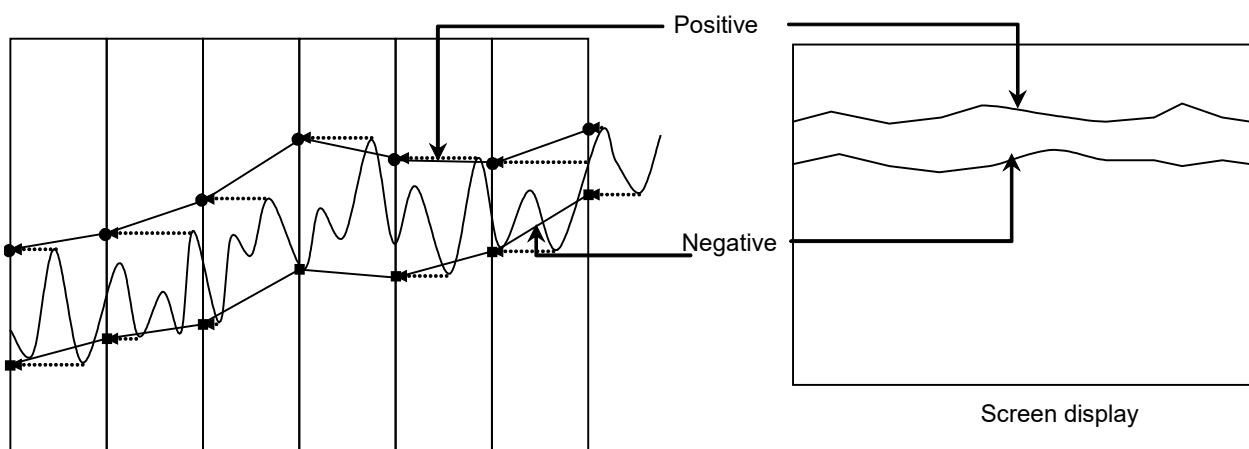





Figure 4.3.8-1 Display example of Detection mode

(1) Setting the detection mode

Example: To set the detection mode to Positive

<Procedure>

1. Press .
2. Press  (Detection), select Positive, and then press .

4.3.9 Setting markers

This section describes various functions as well as the functions to improve measurement efficiency, such as marker search and parameter setting with marker values.

Pressing **F2** (Marker) on page 2 of the Trace function menu, or pressing **Marker** displays the Marker function menu.

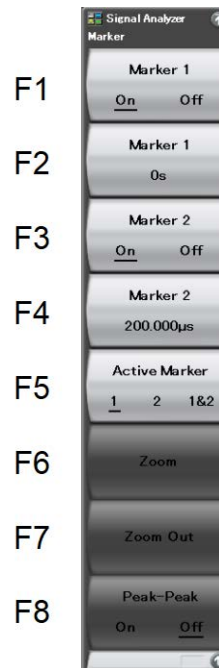

Figure 4.3.9-1 Marker function menu

Table 4.3.9-1 Marker function menu

Menu Display	Function
Marker1 (On/Off)	Sets whether to display time marker 1.
Marker1	Sets the time marker 1.
Marker2 (On/Off)	Sets whether to display time marker 2.
Marker2	Sets time marker 2.
Active Marker (1/2 /1&2)	Selects the active marker.
Zoom	Zooms in on the range of Marker1 and Marker2.
Zoom Out	Reduces the current screen display data into the range of Marker1 and Marker2.
Peak-Peak (On/Off)	Displays the AM modulation degree based on the maximum and minimum values in the marker range. This function is effective only when Scale Mode is set to Lin.

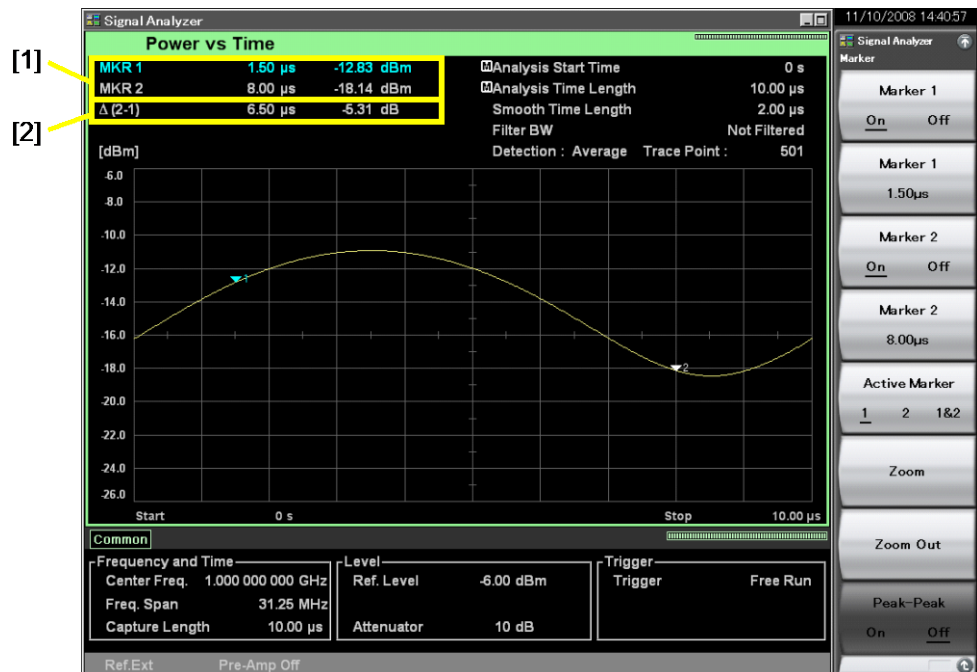

Figure 4.3.9-2 Display items for marker results

Table 4.3.9-2 Display items for marker results

No.	Display	Description
[1]	MKR1/MKR2	Displays the power at each marker time position.
[2]	$\Delta(2 - 1)$	Displays the ratio of the power at the marker time positions (Marker 1 – Marker 2).

(1) Changing the marker position

Note:

The marker position of Power vs Time, Frequency vs Time, Phase vs Time synchronizes one another.

The power in the specified time can be measured by using the marker displayed in Figure 4.3.9-3.

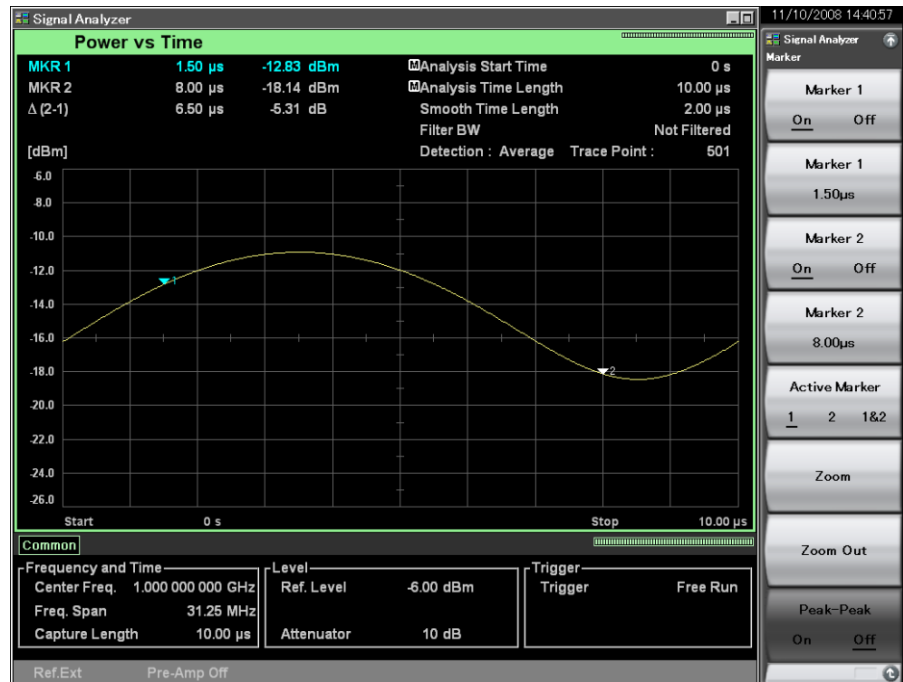

Figure 4.3.9-3 Marker

Example: To set 1.5 μs for Marker 1

<Procedure>

1. Press **Marker**, and then press **F2** (Marker 1).
2. Press **1** **.** **5**, and then press **F3** (μs).

(2) Selecting the active marker





Note:

This setting is enabled when both Markers 1 and 2 are On.

The active marker is selected. The marker position of the active marker can be set with the rotary knob or step key.

Example: To set Markers 1 and 2 to On and to select the active marker

<Procedure>



1. Press .
2. Press  (Marker 1 On/Off) and select On.
3. Press  (Marker 2 On/Off) and select On.
4. Press  (Active Marker 1/2/1&2) and select the active marker.

(3) Setting zooming in

The range from Marker 1 to Marker 2 can be zoomed in.

Example: To zoom in on Marker 1

<Procedure>

1. Press .
2. Press  (Zoom) to zoom in on the range enclosed with Markers 1 and 2.

As shown in Figure 4.3.9-4, when Zoom is performed after setting the range with Markers 1 and 2, the Analysis Start Time and Analysis Time Length are changed to the range of Markers 1 and 2.

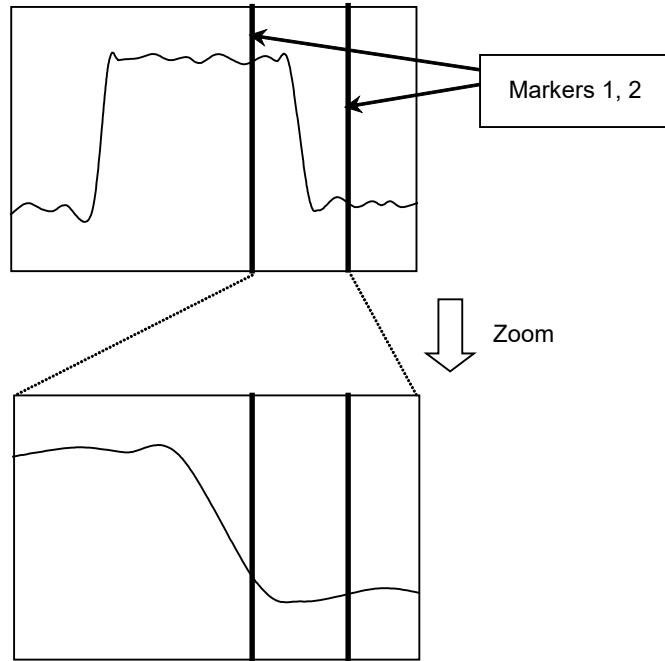

Figure 4.3.9-4 Zoom

(4) Setting zooming out

The analysis range can be zoomed out to the range from Marker 1 to Marker 2.

<Procedure>

1. Press **Marker**.
2. Press **F7** (Zoom Out) to zoom out the displayed waveform data to the range enclosed with Markers 1 and 2.

As shown in Figure 4.3.9-5, when Zoom Out is performed after setting the range with Markers 1 and 2, the range of Markers 1 and 2 is changed to the Analysis Start Time and Analysis Time Length.

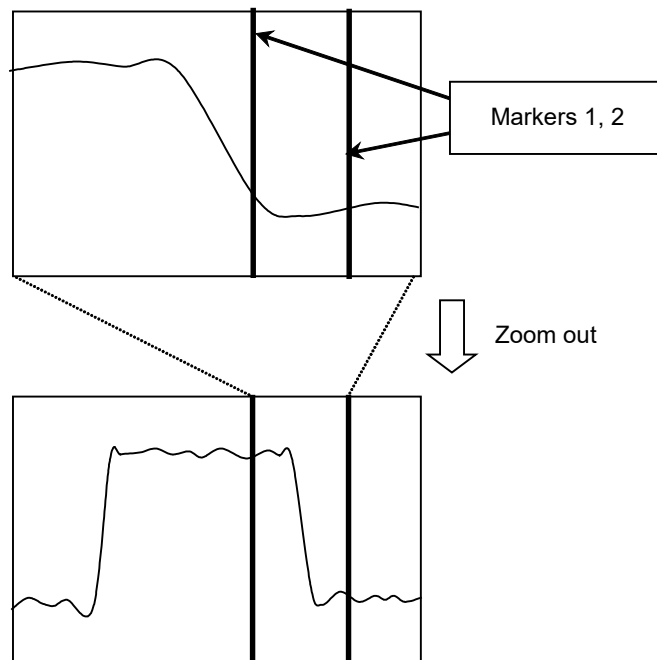

Figure 4.3.9-5 Zoom out

(5) Peak To Peak measurement

The AM modulation degree of the measured signal is measured based on the displayed trace data in the marker range. The measurement start and stop points are the trace points of the marker position. When the marker is Off, the entire analysis range becomes the target. This function can be used only when Scale is set to Lin.

The display items for measurement results are described below.

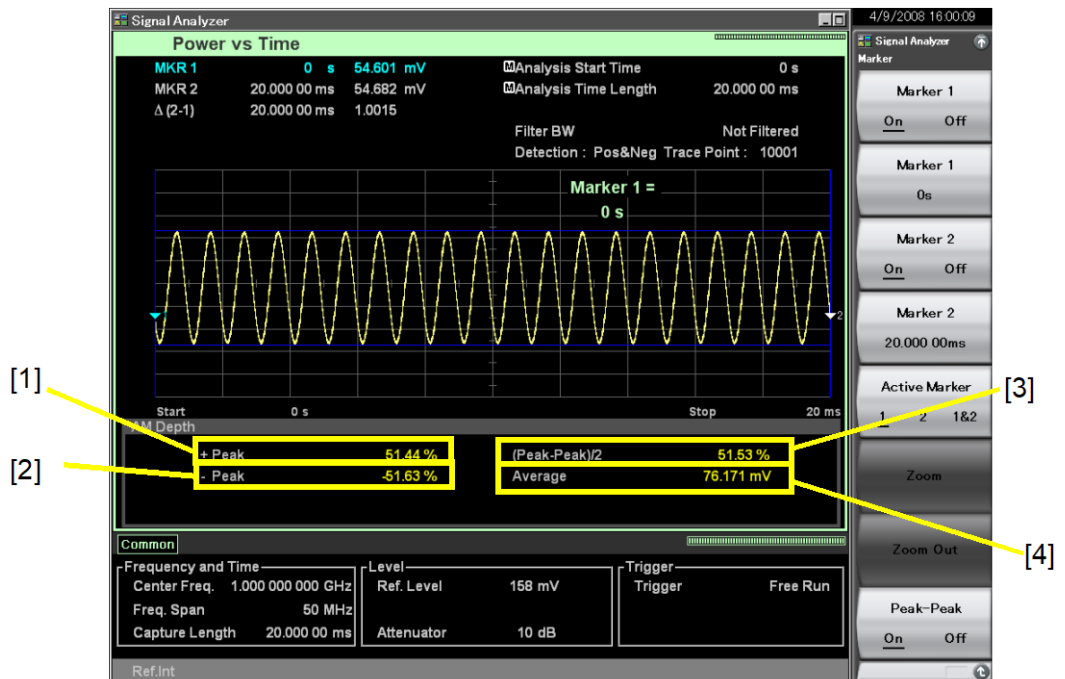

Figure 4.3.9-6 Display items for measurement results



Table 4.3.9-3 Display items for measurement results

No.	Display	Item
[1]	+Peak	<p>Displays the positive peak AM modulation degree calculated from the following formula:</p> $P_{Plus} = \frac{V_{Max} - V_{Ave}}{V_{Ave}} \times 100$ <p>where</p> <p>P_{Plus}: +Peak [%] V_{Max}: maximum voltage [V] V_{Ave}: average voltage [V]</p>
[2]	-Peak	<p>Displays the negative peak AM modulation degree calculated from the following formula:</p> $P_{Minus} = \frac{V_{Ave} - V_{Min}}{V_{Ave}} \times 100$ <p>where</p> <p>P_{Minus}: -Peak [%] V_{Min}: minimum voltage [V] V_{Ave}: average voltage [V]</p>
[3]	(Peak-Peak)/2	<p>Displays (Peak-Peak)/2 calculated from the following formula:</p> $P_{P-P} = \frac{P_{Plus} - P_{Minus}}{2}$ <p>where</p> <p>P_{P-P}: (Peak-Peak)/2 [%] P_{Plus}: +Peak [%] P_{Minus}: -Peak [%]</p>
[4]	Average	Displays the average voltage.

4.3.10 Setting marker search

The marker search functions include Peak search and Next Peak search.

Signal Search function menu

Pressing  (Signal Search) on page 2 of the Trace function menu, or pressing  displays the Signal Search function menu.

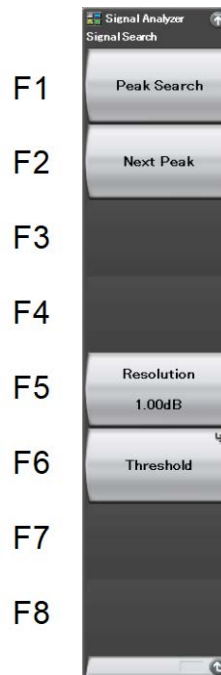

Figure 4.3.10-1 Signal Search function menu

Table 4.3.10-1 Signal Search function menu

Menu Display	Function
Peak Search	Moves the active marker to the maximum level point in the measurement band. If two or more such points exist, the point with the lowest time (toward the left of the scale) is selected.
Next Peak	Searches for the second highest local maximum point next to the active marker in the measurement band and moves the active marker to the point. If two or more such points exist, the point with the lowest time (toward the left of the scale) is selected.
Resolution	Sets the resolution for Next Peak search.
Threshold	Sets a threshold to restrict level points to be searched.

Threshold function menu

Pressing  (Threshold) on the Signal Search function menu displays the Threshold function menu.



Figure 4.3.10-2 Threshold function menu

Table 4.3.10-2 Threshold function menu



Menu Display	Function
Threshold (On/Off)	Selects On/Off for the detection threshold function for peak point detection.
Threshold (Above/Below)	Selects whether peak point detection is to be performed Above (upper detection) or Below (lower detection) the threshold.
Threshold Level	Sets the detection threshold for peak point detection.

(1) Executing Peak search

The active marker is moved to the position where the marker value becomes maximal in the measurement band. If two or more marker values exist, the point with the lower marker time is selected.

Example: To execute a Peak search

<Procedure>



1. Press .
2. Press  (Peak Search) to execute a Peak search.

(2) Executing Next Peak search

The active marker is moved to the position with the second highest peak next to the marker value of the current active marker. If two or more marker values exist, the point with the lower marker time is selected.

Example: To execute a Next Peak search

<Procedure>





1. Press .
2. Press  (Next Peak) to execute a Next Peak search.

(3) Setting the search resolution

The Next Peak search resolution is set. Trace data with slopes greater than the resolution at both ends is to be searched.

Example: To set the search resolution value to 10 dB

<Procedure>

1. Press .
2. Press  (Resolution).
3. Press  , and then press  (Set) to set the search resolution.

Setting range and resolution for search resolution

Setting range:	0.01 to 50.00 dB (Log)
	0.01 to 50.00% (Lin)
Minimum resolution:	0.01 dB (Log)
	0.01% (Lin)
Rotary knob resolution:	0.1 dB (Log)
	0.01% (Lin)
Step key resolution:	1 dB (Log)
	1% (Lin)

(4) Setting the search threshold

The threshold to restrict marker values to be searched is set. A search is performed for marker values above or below the threshold.

Example: To set threshold limitation to On and marker values below -10 dBm as search targets

<Procedure>

1. Press **Peak Search**.
2. Press **F0** (Threshold).
3. Press **F1** (Threshold On/Off) to switch to On.
4. Press **F2** (Threshold Above/Below) to switch to Below.
5. Press **F3** (Threshold Level).
6. Press **-/+** **1** **0**, and then press **F1** (dBm) to set the search threshold.

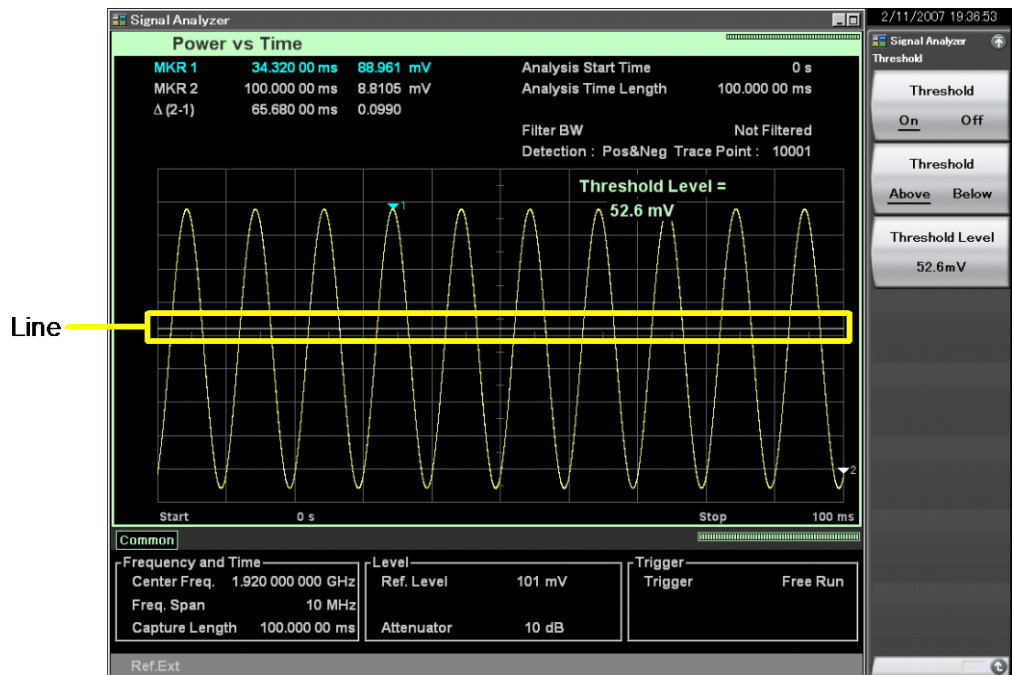



Figure 4.3.10-3 Threshold Level line of Signal Search

4.3.11 Measure measurement

Measure function menu

Pressing  (Measure) on page 2 of the Trace function menu, or pressing  displays the Measure function menu.

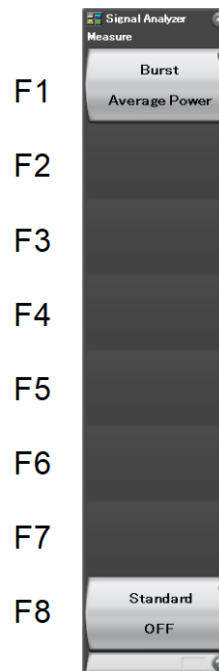



Figure 4.3.11-1 Measure function menu

Table 4.3.11-1 Measure function menu

Menu Display	Function
Burst Average Power	Measures the average power of the burst signal.
AM Depth (On/Off)	Measures the AM modulation degree.
Standard	<p>Parameters are automatically set, according to the communication method specified for the input signal.</p> <p>The parameter load function (Load Standard Parameter) corresponding to the communication method becomes available.</p> <ul style="list-style-type: none"> • W-CDMA Uplink Sets parameters of the 3GPP W-CDMA Uplink standard. • W-CDMA Downlink Sets parameters of the 3GPP W-CDMA Downlink standard. • OFF Parameters are automatically set. <p> Appendix C “Standard Parameter List”</p> <p>When moving to the function menu of each Measure function that has been set to Off, the parameters corresponding to the communication method are automatically loaded. When moving to the function menu of each Measure function that has been set to On, no parameter is automatically loaded.</p>

Burst Average Power function menu

Press  (Burst Average Power) on the Measure function menu to display the Burst Average Power function menu.

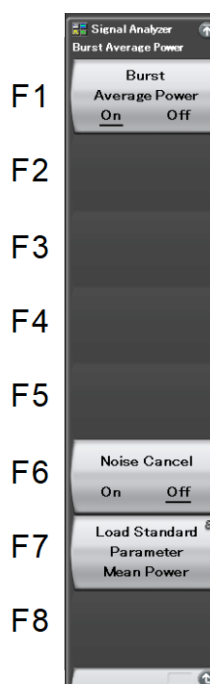



Figure 4.3.11-2 Burst Average Power function menu

Table 4.3.11-2 Burst Average Power function menu

Menu Display	Function
Burst Average Power (On/Off)	The other measure functions of the same trace are automatically set to Off when set to On.
Noise Cancel (On/Off)	Sets On/Off for noise canceling function. When executed, it measures the internal noise of this instrument and the measured noise is deducted from the measurement value. This function is available only when Standard Parameter is set. Note: The internal noise may not be measured properly when the input signal level is high.
Load Standard Parameter	Loads the measurement parameters corresponding to the communication method selected in Standard when anything other than Off is set in Standard.  Appendix C "Standard Parameter List"

(1) Measuring the burst average power

The average power of the burst signal displayed on the screen is measured.

The measurement start and stop points are marker positions. When either of the markers is set to Off, the entire analysis range will be measured.

The display items for measurement results are described below.

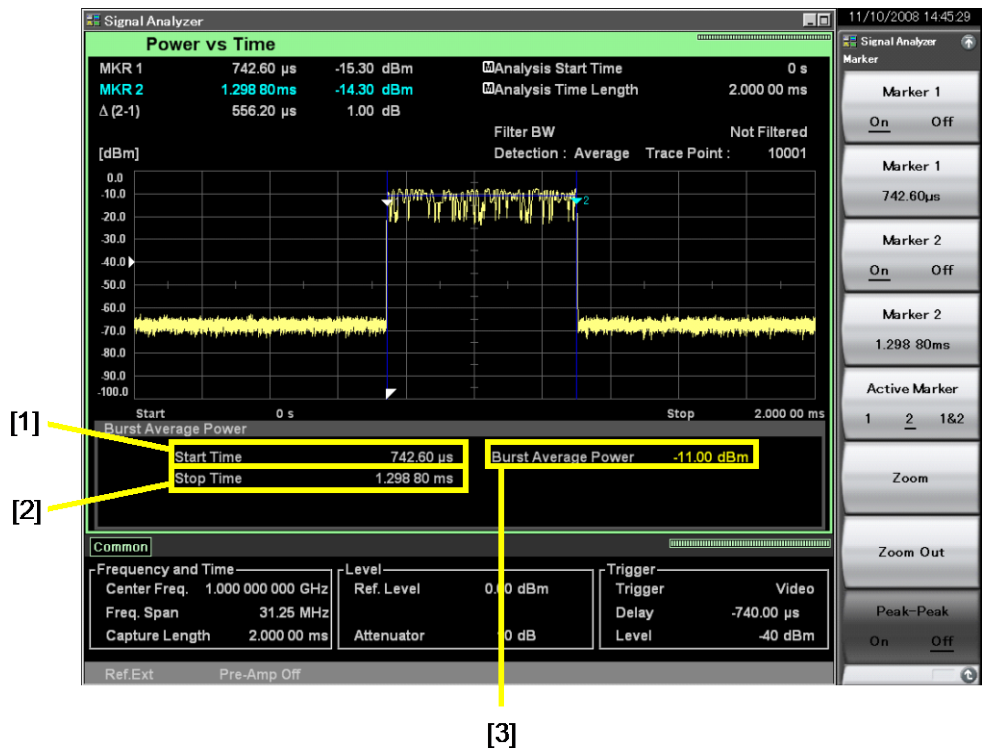

Figure 4.3.11-3 Display items for measurement results

Table 4.3.11-3 Display items for measurement results

No.	Display	Descriptions
[1]	Start Time	Displays the average power measurement start time.
[2]	Stop Time	Displays the average power measurement stop time.
[3]	Burst Average Power	Displays the average power of the burst signal.

Example: To obtain the effective average power within the range set by the marker

<Measurement block>

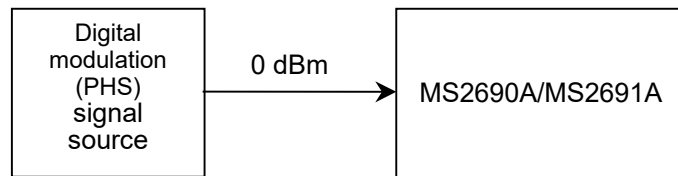

Center frequency: 1.9 GHz

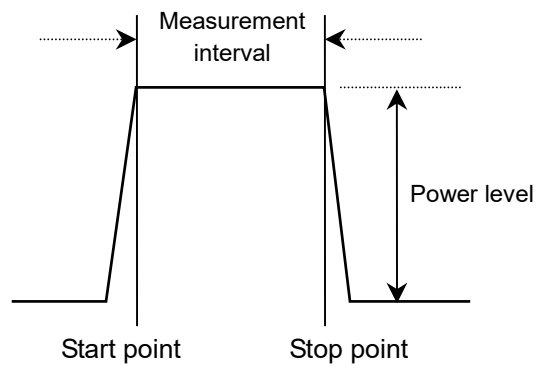

Figure 4.3.11-4 Measurement block diagram

4

Trace

<Procedure>

1. Press **Preset**, and then select **F1** (Preset).
2. Press **Frequency**.
3. Press **1** **.** **9**, and then press **F1** (GHz) to set the center frequency.
4. Press **Trace**.
5. Press **F1** (Trace Mode), and then press **F2** (Power vs Time) to set the trace type.
6. Set the Ref. Level 3 dB above the peak.
7. Press **Trigger/Gate**, and then press **F2** (Trigger Source) to select Video.
8. Press **↺** to return to the original menu.
9. Press **F3** (Trigger Slope Rise/Fall) and select Rise.
10. Press **F4** (Trigger Level video).
11. Press **-/+** **4** **0**, and then press **F1** (dBm) to set the trigger level.
12. Press **Trigger/Gate**, and then press **F8** (Trigger Delay).
13. Press **-/+** **6**, and then press **F3** (μ s) to set the analysis start time.
14. Press **Time/Sweep**, and then press **F3** (Time Length).
15. Press **8** **0** **0**, and then press **F3** (μ s) to set the analysis time length.
16. Set Marker 1 to the start position of the measurement interval.
17. Set Marker 2 to the stop position of the measurement interval.
18. Press **Measure**.
19. Press **F1** (Burst Avg Power), press **F1** (Burst Avg Power On/Off), and then select On to set the power measurement.

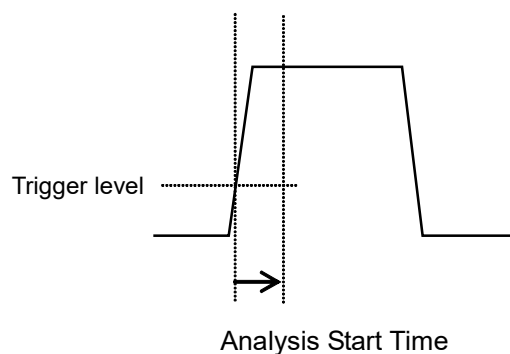

Figure 4.3.11-5 Trigger level

To obtain the average power between the burst frame, the measurement interval is set to the burst frame time for measurement.

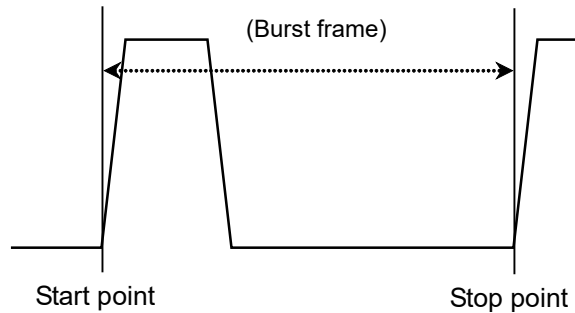

Figure 4.3.11-6 Measurement interval

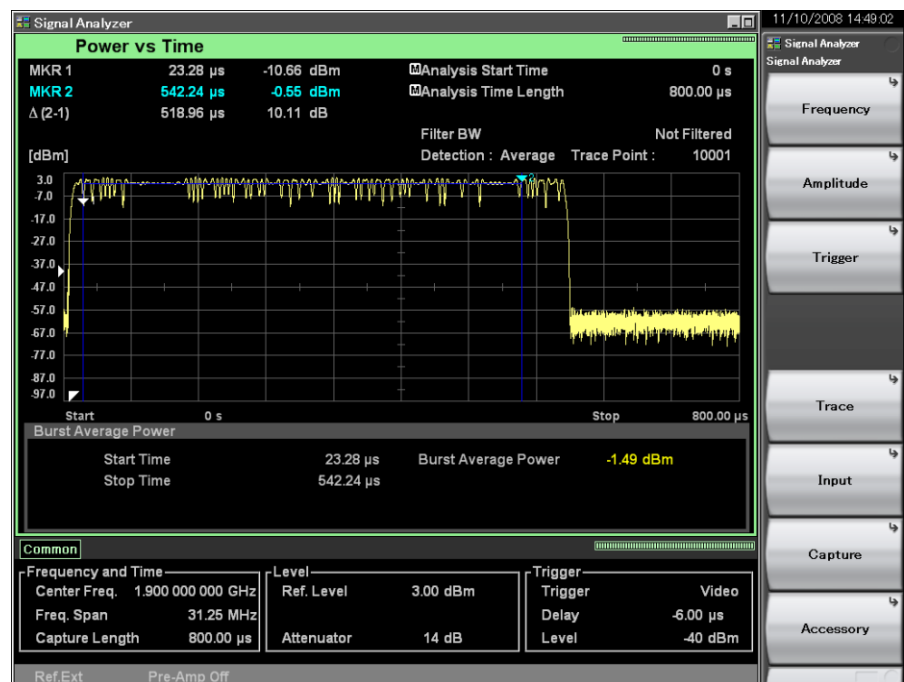

Figure 4.3.11-7 Measurement results

(2) AM Depth Measurement

Measures the AM modulation degree of the measured signal, based on the trace data within the marker range. The measurement range is between Marker 1 and 2 points on the trace. When either of the markers is set to Off, the measurement is performed throughout the range on the trace. If switched to On, Scale Mode is switched to Lin, Detection is switched to Pos & Neg, and Peak-Peak function is switched to On.

4

Trace

The display items for measurement results are described below.

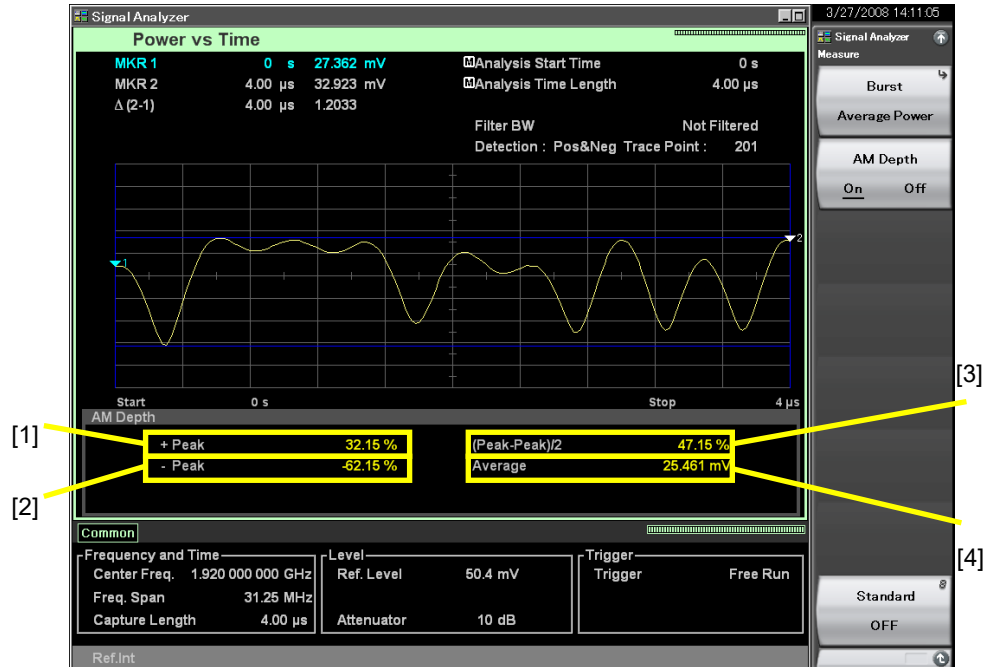

Figure 4.3.11-8 AM Depth measurement result

Table 4.3.11-4 Explanation of Measurement Results

No.	Display	Item
[1]	+Peak	<p>The AM modulation in plus peak is displayed. It is calculated by the following formula.</p> $P_{Plus} = \frac{V_{Max} - V_{Ave}}{V_{Ave}} \times 100$ <p>However;</p> <p>P_{Plus}: +Peak [%] V_{Max}: Max. voltage [V] V_{Ave}: Average voltage [V]</p>
[2]	-Peak	<p>The AM modulation in minus peak is displayed. It is calculated by the following formula.</p> $P_{Minus} = \frac{V_{Ave} - V_{Min}}{V_{Ave}} \times 100$ <p>However;</p> <p>P_{Minus}: -Peak [%] V_{Min}: Min. voltage [V] V_{Ave}: Average voltage [V]</p>
[3]	(Peak-Peak)/2	<p>(Peak-Peak)/2 is displayed. It is calculated by the following formula.</p> $P_{P-P} = \frac{P_{Plus} - P_{Minus}}{2}$ <p>However;</p> <p>P_{P-P}: (Peak-Peak)/2 [%] P_{Plus}: +Peak [%] P_{Minus}: -Peak [%]</p>
[4]	Average	The average voltage is displayed.

4.4 Frequency vs Time

4.4.1 What is Frequency vs Time trace?

Frequency vs Time trace is a screen that displays time fluctuations of the frequency from the obtained IQ digital data.

The display items for a Frequency vs Time trace are described below.

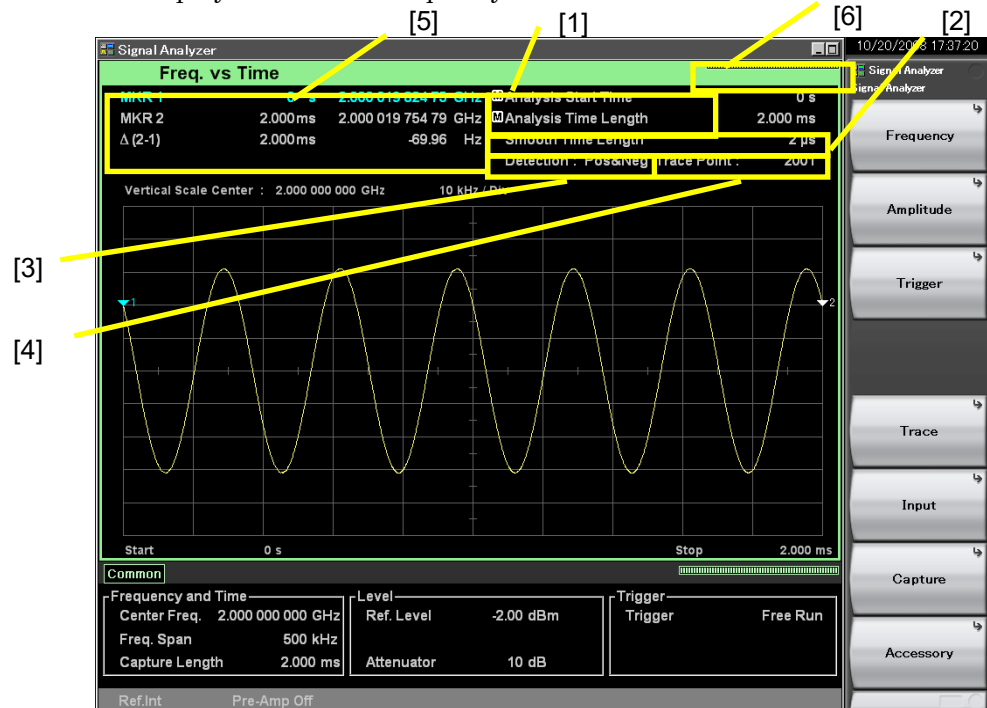

Figure 4.4.1-1 Display items for Frequency vs Time trace

Table 4.4.1-1 Display items for Frequency vs Time trace

No.	Display	Descriptions
[1]	Analysis Start Time /Analysis Time Length	Displays the analysis start time and analysis time length.
[2]	Smooth Time Length	Displays the smoothing time length when Smoothing is On.
[3]	Detection	Displays the detection mode.
[4]	Trace Point	Displays the trace point count (horizontal axis).
[5]	MKR1/MKR2/ Δ(2 - 1)	Displays the marker result value and marker frequency position.
[6]	Indicator	Displays the indicator indicating the analysis progress rate.

4.4.2 Setting Frequency vs Time parameters

After selecting Frequency vs Time for Trace Mode, pressing **F6** (Trace) from the main function menu or pressing **Trace** displays the Trace function menu.

The Trace function menu consists of two pages, which can be toggled by pressing **→**.

 4.1 "Selecting Trace"

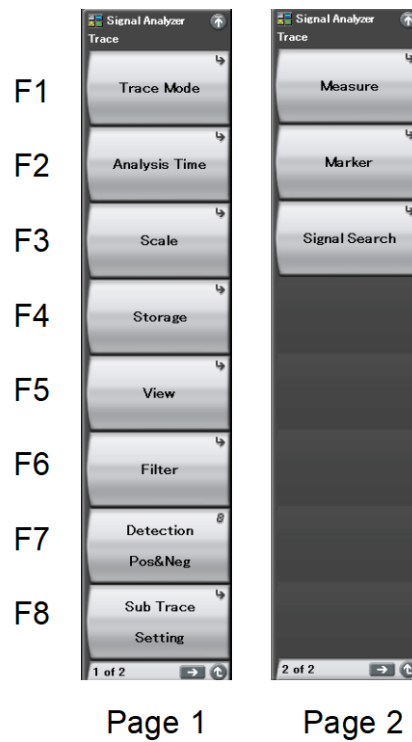













Figure 4.4.2-1 Trace function menu

Table 4.4.2-1 Trace function menu

Menu Display	Function
Trace Mode	Sets the trace type.  4.1 “Selecting Trace”
Analysis Time	Used for setting related to the analysis time.  4.4.3 “Setting analysis time”
Scale	Used for setting related to the scale.  4.4.4 “Setting scale”
Storage	Used for setting related to update and display of trace data.  4.4.7 “Setting storage mode”
Filter	Sets the filter.  4.4.5 “Setting filter”
View	Sets the smoothing. Calculation is done with the unit of the frequency axis scale.  4.4.6 “Setting smoothing”
Detection	Used for setting related to detection.  4.4.8 “Setting detection mode”
Sub Trace Setting	Used for setting related to sub-trace.  4.9 “Sub-Trace”
Measure	Used for setting related to Measure function.  4.4.11 “Measure measurement”
Marker	Used for setting related to the marker.  4.4.9 “Setting markers”
Signal Search	Moves the active marker to the maximum level point within the measurement time.  4.4.10 “Setting marker search”

4.4.3 Setting analysis time

Pressing **F2** (Analysis Time) from the Trace function menu, or pressing **Time/Sweep** displays the Analysis Time function menu.

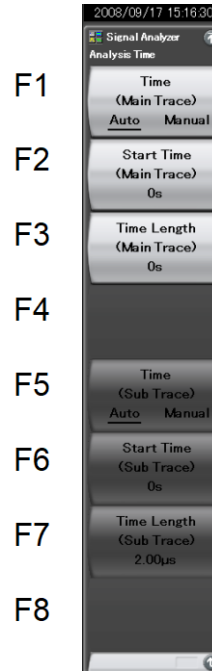

Figure 4.4.3-1 Analysis Time function menu

Table 4.4.3-1 Analysis Time function menu

Menu Display	Function
Time (Main Trace) (Auto/Manual)	Switches between auto mode and manual mode for the analysis start time (Analysis Start Time) and analysis time length (Analysis Time Length) .
Start Time (Main Trace)	Sets the analysis start time.
Time Length (Main Trace)	Sets the analysis time length.
Time (Sub Trace) (Auto/Manual)	Switches between auto mode and manual mode for the analysis start time (Analysis Start Time) and analysis time length (Analysis Time Length) of a sub-trace.
Start Time (Sub Trace)	Sets the analysis start time of a sub-trace.
Time Length (Sub Trace)	Sets the analysis time length of a sub-trace.

Setting the analysis time

Analysis time is the time to be analyzed. The analysis time can be specified with the analysis start position (Analysis Start Time) and analysis time length (Analysis Time Length).

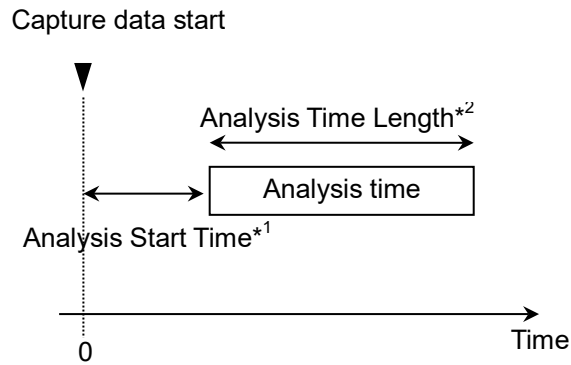

*1: Start of Analysis time based on capture data start

*2: Length of analysis time

Figure 4.4.3-2 Analysis time

(1) Auto mode

When Capture Time is set to Auto, the analysis time length is set to 100 ms for measurement.

When Capture Time is set to Manual, the analysis time length is set to the capture time for measurement.

Table 4.4.3-2 Setting analysis time in the Auto mode

Capture Time	Analysis Start Time [s]	Analysis Time Length [s]
Auto	0	0.1
Manual	0	x_1

x_1 : Capture time length [s]

 2.4 "Setting IQ Data Capture Time Range"

(2) Manual mode

The analysis start time and analysis time length are set manually. This is an effective method for measuring discontinuous signals such as burst.

Analysis start time setting range**Table 4.4.3-3 Analysis start time setting range in Manual mode**

Capture Time	Minimum Value [s]	Maximum Value [s]
Auto	0	$x_2 - x_1$
Manual	0	$x_3 - x_1$

x_1 : Analysis time length [s]

x_2 : Capture time length maximum value [s]

 2.4 "Setting IQ Data Capture Time Range"

x_3 : Capture time length [s]

 2.4 "Setting IQ Data Capture Time Range"

4

Trace

Analysis time length setting range**Table 4.4.3-4 Analysis time length setting range**

Time	Minimum Value [s]	Maximum Value [s]
Auto	$\frac{100}{x_4}$	$x_2 - x_1$
Manual	$\frac{100}{x_4}$	$x_3 - x_1$

x_1 : Analysis start time [s]

x_2 : Capture time length maximum value [s]

 2.4 "Setting IQ Data Capture Time Range"

x_3 : Capture time length [s]

 2.4 "Setting IQ Data Capture Time Range"

x_4 : Sampling rate [Hz]

 2.2.2 "Setting frequency span"

Note:

The maximum value may be less than this value due to the restrictions imposed by the trace point.

Analysis start time resolution

Table 4.4.3-5 Frequency span and resolution

Frequency Span	Resolution
1 kHz	0.5 ms
2.5 kHz	0.2 ms
5 kHz	0.1 ms
10 kHz	50 μs
25 kHz	20 μs
50 kHz	10 μs
100 kHz	5 μs
250 kHz	2 μs
500 kHz	1 μs
1 MHz	0.5 μs
2.5 MHz	0.2 μs
5 MHz	0.1 μs
10 MHz	50 ns
25 MHz	20 ns
31.25 MHz	20 ns
50 MHz* ¹	10 ns
62.5 MHz* ²	10 ns
100 MHz* ³	5 ns
125 MHz* ³	5 ns

*1: 50 MHz can be set only when Option 004/104/077/177 is installed.









*2: 62.5 MHz can be set only when Option 077/177 is installed.

*3: 100 MHz and 125 MHz can be set only when Option 004/104/078/178 is installed.

Setting procedure for analysis time

Example: To switch the analysis time to Manual setting, and setting the analysis start time to 20 ns and analysis time to 2 μs

<Procedure>

1. Press .
2. Press  (Start Time).
3. Press  , and then press  (ns) to set the analysis start time.
4. Press  (Time Length).
5. Press , and then press  (μs) to set the analysis time length.

4.4.4 Setting scale

Scale function menu

Pressing **Trace** and then **F3** (Scale) displays the Scale function menu.

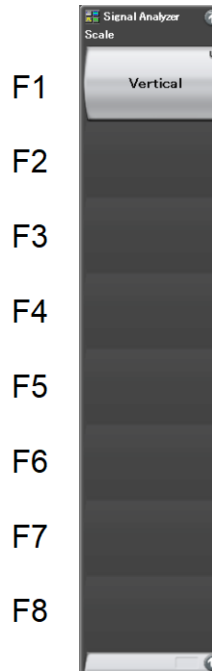



Figure 4.4.4-1 Scale function menu

Table 4.4.4-1 Scale function menu

Menu Display	Function
Vertical	Used for setting related to the vertical axis (frequency axis) scale.

Vertical function menu

Pressing  (Vertical) on the Scale function menu displays the Vertical function menu.

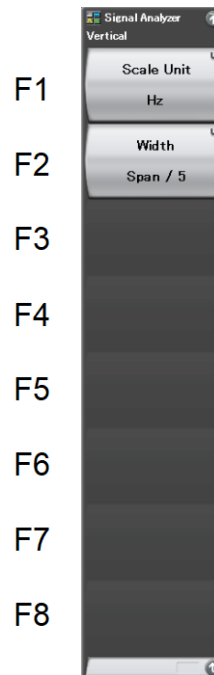

Figure 4.4.4-2 Vertical function menu

Table 4.4.4-2 Vertical function menu

Menu Display	Function
Scale Unit	Sets the unit system of the vertical axis.
Width	Sets the scale range of the vertical axis.

(1) Setting the vertical axis scale unit





In a Frequency vs Time trace, there are the following two types of units (Frequency Scale Units) for the vertical axis scale.

Hz: Measurement frequency data is displayed.

Δ Hz: Difference from the center frequency is displayed.

Example: To set the vertical axis scale unit to Δ Hz

<Procedure>

1. Press .
2. Press  (Scale).
3. Press  (Vertical).
4. Press  (Scale Unit), and then select  (Δ Hz) to select the unit.

(2) Setting the vertical axis scale range

The vertical axis scale range is set. There are the following four types:

Span/2: Sets the scale range to 1/2 of the current frequency span.





Span/5: Sets the scale range to 1/5 of the current frequency span.

Span/10: Sets the scale range to 1/10 of the current frequency span.

Span/25: Sets the scale range to 1/25 of the current frequency span.

Example: To set the vertical axis scale range to 1/5 of the frequency span

<Procedure>

1. Press .
2. Press  (Scale).
3. Press  (Vertical).
4. Press  (Width), and then select  (Span/5) to select the unit.

4.4.5 Setting filter

Pressing **F0** (Filter) on the Trace function menu, or pressing **BW** displays the Filter function menu.



Figure 4.4.5-1 Filter function menu

Table 4.4.5-1 Filter function menu

Menu Display	Function
Filter Auto/Manual	Sets the filter band auto setting function. When it is set to Auto, the maximum filter bandwidth available is selected.
Filter Bandwidth	Sets the filter band.

Setting the filter

The demodulation bandwidth of Frequency vs Time measurement is determined when the Filter Bandwidth is set. By default, the maximum available demodulation bandwidth is set.

High-frequency noise components of the demodulation signal can be reduced by restricting the demodulation signal band. If noise is a problem, restrict the band. When harmonic components of the demodulation signal are restricted, distortion may occur in the demodulation signal, and correct measurement values cannot be obtained. In this case, set a wider bandwidth.

Setting range and resolution for filter band

Setting range:	Refer to Table 4.4.5-2.
Rotary knob resolution:	1-3-10 sequence
Step key resolution:	1-3-10 sequence

Table 4.4.5-2 Filter band setting range

Frequency Span	Minimum Value	Maximum Value
1 kHz	30 Hz	300 Hz
2.5 kHz	100 Hz	1 kHz
5 kHz	100 Hz	1 kHz
10 kHz	300 Hz	3 kHz
25 kHz	1 kHz	10 kHz
50 kHz	1 kHz	10 kHz
100 kHz	3 kHz	30 kHz
250 kHz	10 kHz	100 kHz
500 kHz	10 kHz	100 kHz
1 MHz	30 kHz	300 kHz
2.5 MHz	100 kHz	1 MHz
5 MHz	100 kHz	1 MHz
10 MHz	300 kHz	3 MHz
25 MHz	1 MHz	10 MHz
31.25 MHz	1 MHz	10 MHz
50 MHz*1	1 MHz	10 MHz
62.5 MHz*2	1 MHz	10 MHz
100 MHz*3	3 MHz	30 MHz
125 MHz*3	3 MHz	30 MHz





*1: 50 MHz can be set only when Option 004/104/077/177 is installed.

*2: 62.5 MHz can be set only when Option 077/177 is installed.



*3: 100 MHz and 125 MHz can be set only when Option 004/104/078/178 is installed.

Example: To set the filter bandwidth to 1 MHz

<Procedure>

1. Press .
2. Press  (Filter Bandwidth).
3. Press , and then press  (MHz) to set the filter band.

4.4.6 Setting smoothing

Pressing  and then  (View) displays the View function menu.

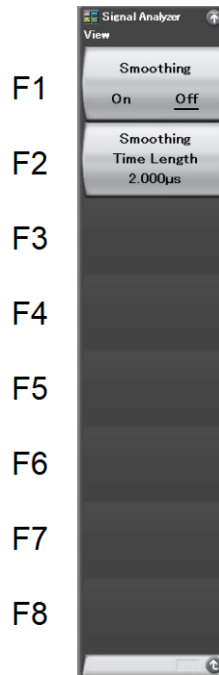

Figure 4.4.6-1 View function menu

Table 4.4.6-1 View function menu









Menu Display	Function
Smoothing (On/Off)	Sets the smoothing to On/Off.
Smoothing Time Length	Sets the smoothing time length.

(1) Setting the smoothing time length

Smoothing processing is performed. To lower the trace noise, the Smoothing function is set to On.

Example: To set the Smoothing function to On and smoothing value to 200 ns

<Procedure>

1. Press .
2. Press  (View).
3. Press  (Smoothing On/Off) and select On.
4. Press  (Smoothing Time Length).
5. Press   , and then press  (ns) to set the smoothing time length.

Setting range and resolution for smoothing time length

Setting range:

Time Resolution to

10000 × Time Resolution

Minimum resolution:

Time Resolution

4.4.7 Setting storage mode

Pressing  and then  (Storage) displays the Storage function menu.



Figure 4.4.7-1 Storage function menu

Table 4.4.7-1 Storage function menu

Menu Display	Function
Mode	Used for setting related to update and display of trace data.
Count	Sets the storage count.
Stop	Stops the storage.

Storage mode types

In a Frequency vs Time trace, the following three storage mode types can be selected.

Table 4.4.7-2 Three types of storage modes

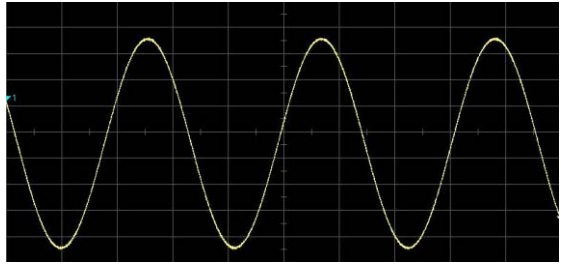
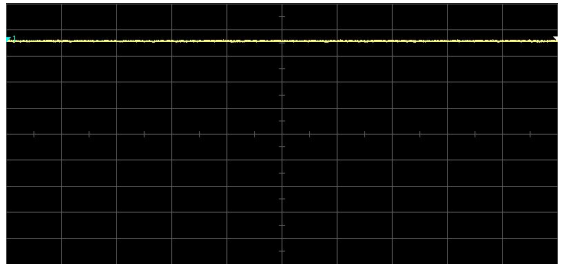
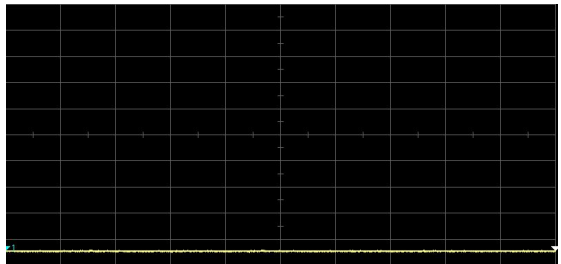
Mode	Description	Display Example
Off	At each capture, the trace data are updated and displayed. These data are used for normal measurement.	
Max Hold	At each capture, the previous and new trace data of each X axis point are compared and the larger of the two is displayed.	
Min Hold	At each capture, the previous and new trace data of each X axis point are compared and the smaller of the two is displayed.	

4









Trace

(1) Selecting the storage mode and storage count

The setting procedure for the storage mode and storage count is as follows.

Example: To set the storage mode to Max Hold and storage count to 100

<Procedure>

1. Press .
2. Press  (Storage).
3. Press  (Mode) and select Max Hold.
4. Press  (Count).
5. Press   , and then press  (Set) to set the storage count.

Setting range and resolution for storage count

Setting range:	2 to 9999
Minimum resolution:	1
Rotary knob resolution:	1 step
Step key resolution:	1 step at the highest 1st digit

4.4.8 Setting detection mode

The detection mode can be selected by pressing **Trace** and then **F7** (Detection).

Detection mode types

The detection mode in the analysis range (Detection) is set. The detection mode can be selected from four types: Average, Positive, Negative, and Pos&Neg.

Table 4.4.8-1 Detection mode

Detection Mode	Descriptions
Average	Traces the average value within the analysis range.
Positive	Traces the maximum value within the analysis range. "Positive" is used to measure the upper envelope of the modulation waveform.
Negative	Traces the minimum value within the analysis range. "Negative" is used to measure the lower envelope of the modulation waveform.
Pos&Neg	Displays the line connecting the maximum and minimum values of the sampling points within the analysis range. Used for normal measurement.

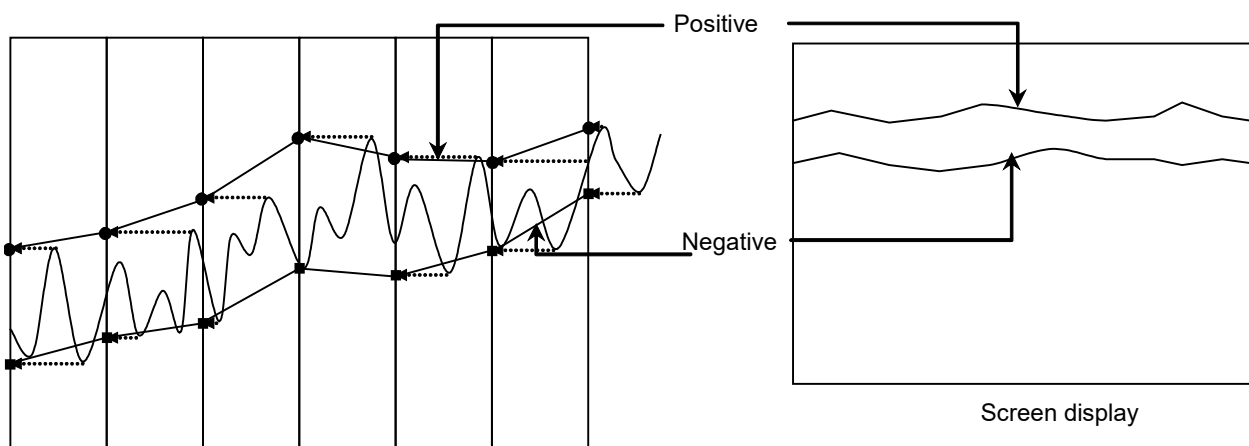



Figure 4.4.8-1 Display example of detection mode

(1) Setting the detection mode

Example: To set the detection mode to Negative

<Procedure>

1. Press .
2. Press  (Detection) and select Negative.

4.4.9 Setting markers

This section describes various Marker functions as well as the functions to improve measurement efficiency, such as marker search and parameter setting with marker values.

Pressing **F2** (Marker) on page 2 of the Trace function menu, or pressing **Marker** displays the Marker function menu.

The Marker function menu consists of two pages, which can be toggled by pressing **→**.

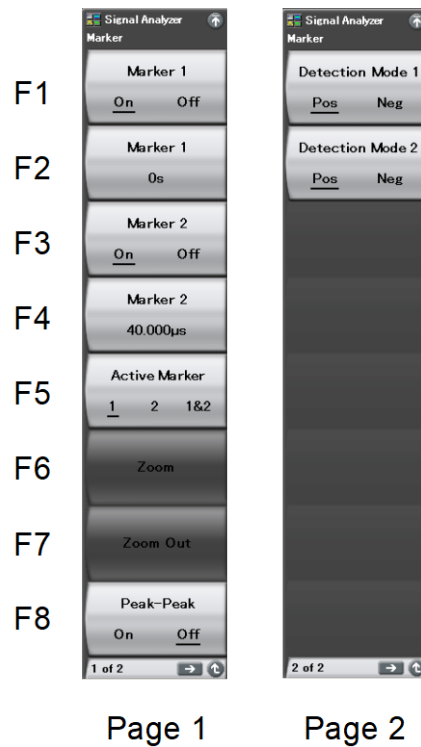

Figure 4.4.9-1 Marker function menu

Table 4.4.9-1 Marker function menu

Menu Display	Function
Marker 1 (On/Off)	Sets whether to display time marker 1.
Marker 1	Sets time marker 1.
Marker 2 (On/Off)	Sets whether to display time marker 2.
Marker 2	Sets time marker 2.
Active Marker (1 / 2 / 1&2)	Selects the active marker.
Zoom	Zooms in on the range of Marker 1 and Marker 2.
Zoom Out	Reduces the current screen display data into the range of Marker 1 and Marker 2.
Peak-Peak	Displays the difference between the maximum and minimum values in the marker range.
Detection Mode 1	Selects the target trace data for Marker 1 when the detection mode is Pos&Neg. Pos: Displays the results of the trace data with Positive detection. Neg: Displays the results of the trace data with Negative detection. It is available only when the detection mode is Pos&Neg.
Detection Mode 2	Selects the target trace data for Marker 2 when the detection mode is Pos&Neg. Pos: Displays the results of the trace data with Positive detection. Neg: Displays the results of the trace data with Negative detection. It is available only when the detection mode is Pos&Neg.

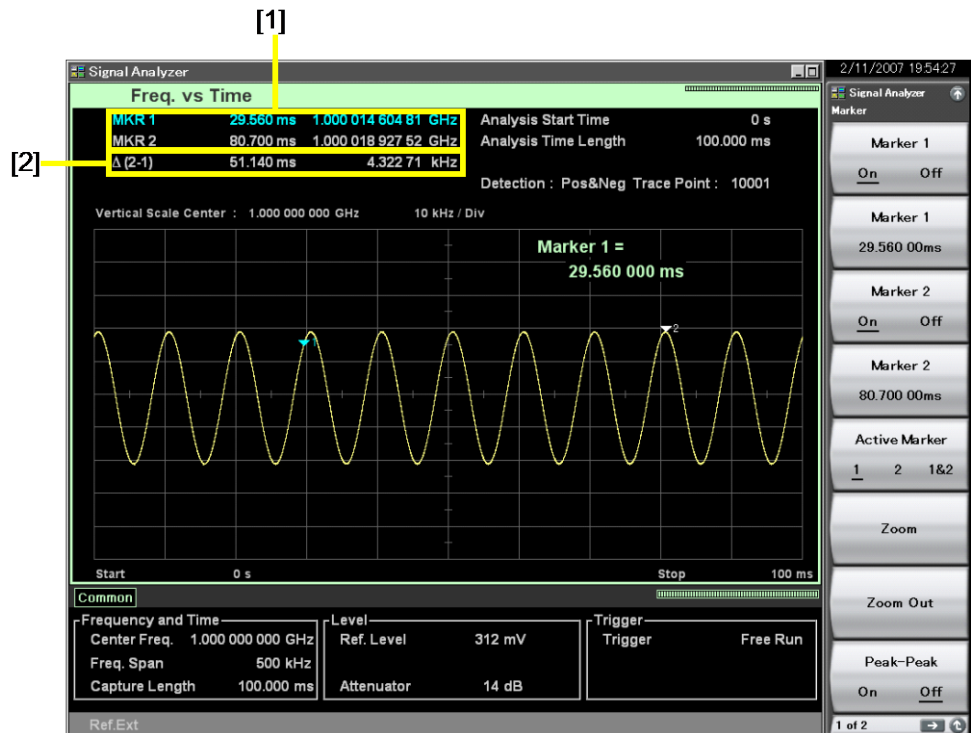

Figure 4.4.9-2 Display items for marker results

Table 4.4.9-2 Display items for marker results

No.	Display	Description
[1]	MRK1 / MRK2	Displays the frequency at each marker time position.
[2]	$\Delta(2 - 1)$	Displays the frequency difference (Marker 2 – Marker 1) at the marker time position.

(1) Changing the marker position

Note:

The marker position of Power vs Time, Frequency vs Time, Phase vs Time synchronizes one another.

The frequency in the specified time can be measured by using the marker displayed in Figure 4.4.9-3.

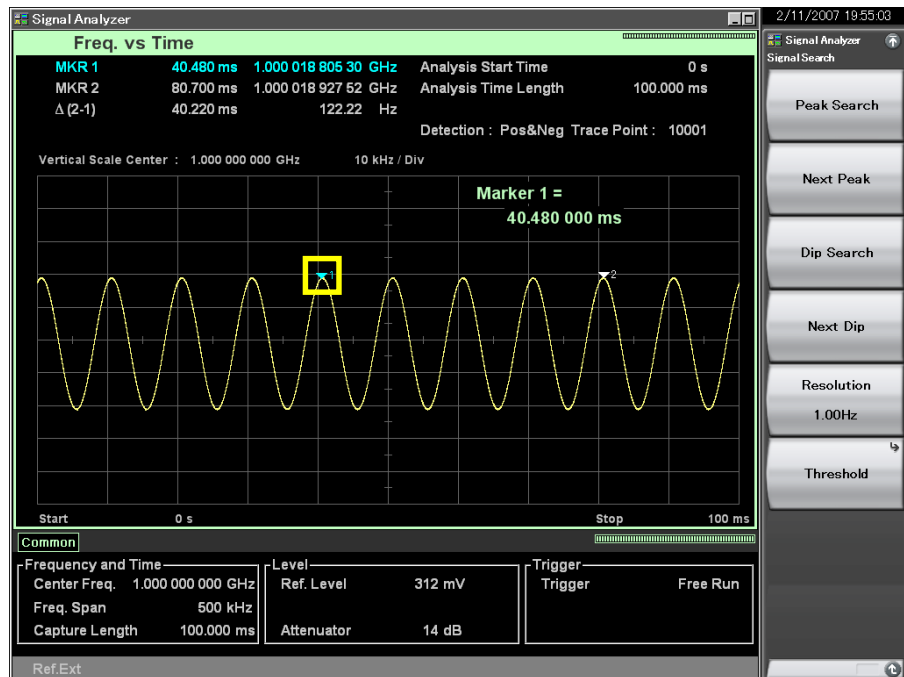

Figure 4.4.9-3 Marker

Example: To set Marker 1 to 1.5 μ s

<Procedure>

1. Press .
2. Press (Marker 1).
3. Press , and then press (μ s).

(2) Selecting the active marker





Note:

This setting is enabled when both Markers 1 and 2 are On.

The active marker is selected. The marker position of the active marker can be set with the rotary knob or step key.

Example: To set the active marker

<Procedure>

1. Press .
2. Press  (Marker 1 On/Off) and select On.
3. Press  (Marker 2 On/Off) and select On.
4. Press  (Active Marker 1/2/1&2) and select the active marker.



(3) Setting zooming in

Note:

This setting is enabled when both Markers 1 and 2 are On.

Example: To zoom in the range from Marker 1 to Marker 2

<Procedure>

1. Press .
2. Press  (Zoom). The range enclosed with Markers 1 and 2 is zoomed in.

As shown in Figure 4.4.9-4, when Zoom is performed after setting the range with Markers 1 and 2, the Analysis Start Time and Analysis Time Length are changed to the range of Markers 1 and 2.

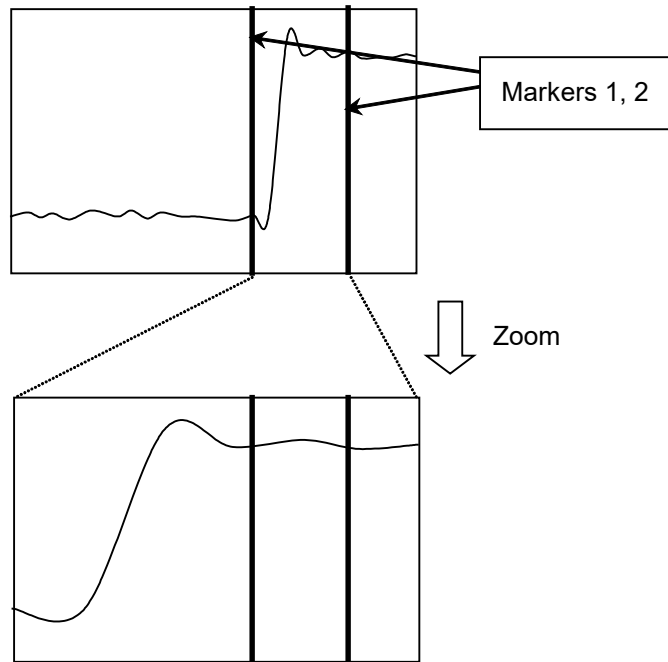

Figure 4.4.9-4 Zoom

(4) Setting zooming out

Note:

This setting is enabled when both Markers 1 and 2 are On.

Example: To reduce the analysis range to the range of Markers 1 and 2

<Procedure>

1. Press .
2. Press  (Zoom Out). The displayed waveform data is zoomed out to the range enclosed with Markers 1 and 2.

As shown in Figure 4.4.9-5, when Zoom Out is performed after setting the range with Markers 1 and 2, the range of Markers 1 and 2 is changed to the Analysis Start Time and Analysis Time Length.

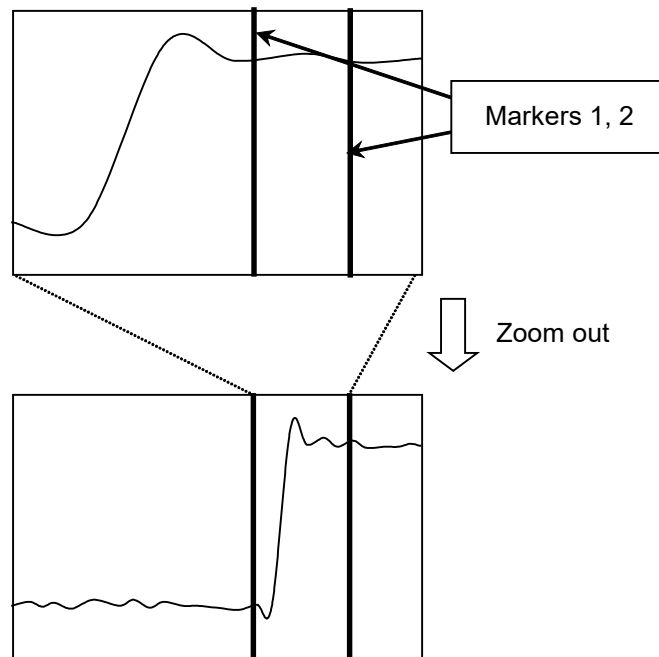

Figure 4.4.9-5 Zoom out

(5) Peak To Peak measurement

The maximum/minimum frequency is measured based on the displayed trace data in the marker range. The measurement start and stop points are the trace points of the marker position. When any of the markers is Off, the entire analysis range becomes the target.

The display items for measurement results are described below.

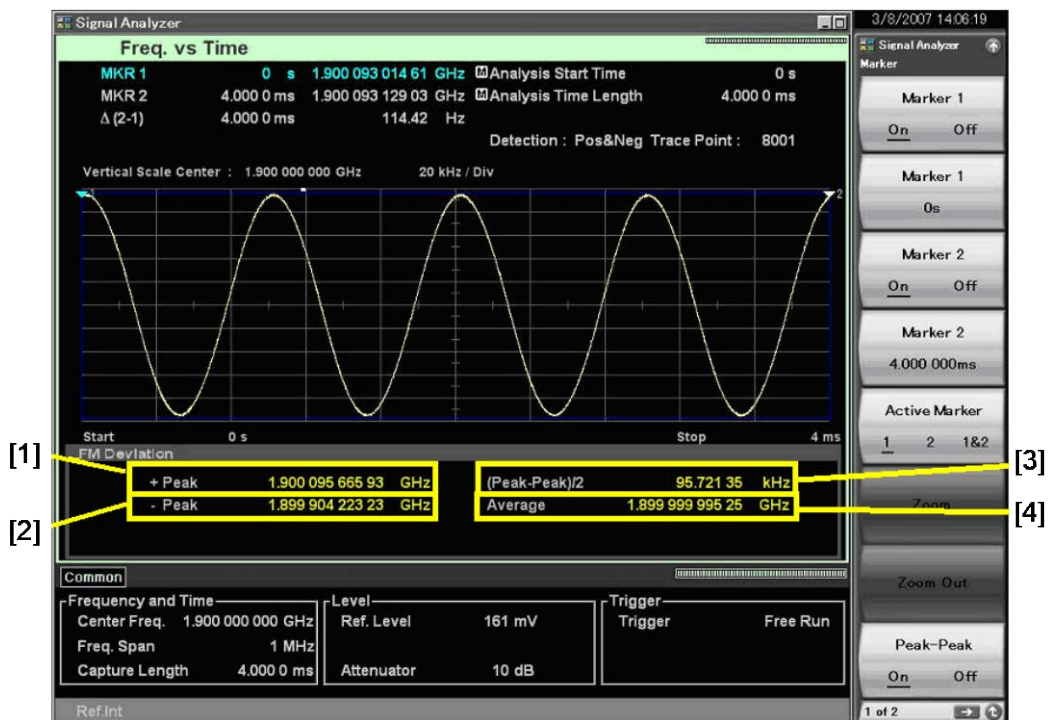

Figure 4.4.9-6 Display items for measurement results



Table 4.4.9-3 Display items for measurement results

No.	Display	Item
[1]	+Peak	Displays the maximum frequency.
[2]	-Peak	Displays the minimum frequency.
[3]	(Peak-Peak)/2	Displays (Peak-Peak)/2 calculated from the following formula: $P_{P-P} = \frac{P_{Plus} - P_{Minus}}{2}$ where P _{P-P} : (Peak-Peak)/2 [Hz] P _{Plus} : +Peak [Hz] P _{Minus} : -Peak [Hz]
[4]	Average	Displays the average frequency.

4.4.10 Setting marker search

The marker search functions include Peak search, Next Peak search, Dip search, and Next Dip search.

Signal Search function menu

Pressing  (Signal Search) on page 2 of the Trace function menu, or pressing  displays the Signal Search function menu.

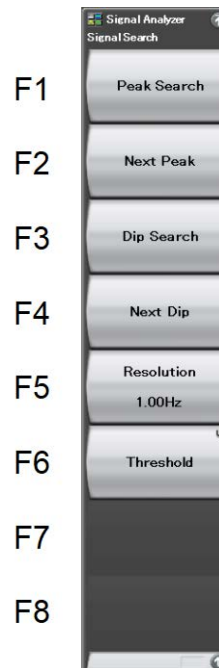

Figure 4.4.10-1 Signal Search function menu

Table 4.4.10-1 Signal Search function menu

Menu Display	Function
Peak Search	Moves the active marker to the maximum frequency point in the measurement time range. If two or more such points exist, the point with the lowest time (toward the left of the scale) is selected.
Next Peak	Moves the active marker to the second highest frequency position next to the active marker in the measurement time range. If two or more such points exist, the point with the lowest time (toward the left of the scale) is selected.
Dip Search	Moves the active marker to the minimum frequency point in the measurement time range. If two or more such points exist, the point with the lowest time (toward the left of the scale) is selected.
Next Dip	Moves the active marker to the second lowest frequency position next to the active marker in the measurement time range. If two or more such points exist, the point with the lowest time (toward the left of the scale) is selected.
Resolution	Specifies the resolution for Next Peak search and Next Dip search.
Threshold	Sets a threshold to restrict frequency points to be searched.

Threshold function menu

Pressing  (Threshold) on the Signal Search function menu displays the Threshold function menu.

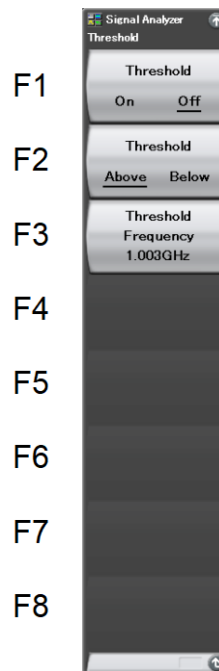

Figure 4.4.10-2 Threshold function menu

Table 4.4.10-2 Threshold function menu



Menu Display	Function
Threshold (On/Off)	Sets the detection threshold function for peak point detection to On/Off .
Threshold (Above/Below)	Selects whether peak point detection is to be performed Above (upper detection) or Below (lower detection) the threshold.
Threshold Frequency	Sets a threshold to restrict frequency points to be searched.

(1) Executing Peak search

The active marker is moved to the position where the marker value becomes maximal in the analysis time range. If two or more marker values exist, the point with the lower marker frequency is selected. When the detection mode is Pos&Neg, a search is executed depending on the marker detection mode setting: Positive detection trace data is searched when Pos is set, and Negative detection trace data is searched when Neg is set.

Example: To execute a Peak search

<Procedure>



1. Press .
2. Press  (Peak Search) to execute a Peak search.

(2) Executing Next Peak search

The second highest local maximum point (Peak) next to the marker value of the current active marker is detected and the active marker is moved to that position. If two or more marker values exist, the point with the lower marker frequency is selected. When the detection mode is Pos&Neg, a search is executed, depending on the marker detection mode setting: Positive detection trace data is searched when Pos is set, and Negative detection trace data is searched when Neg is set.

Example: To execute a Next Peak search

<Procedure>



1. Press .
2. Press  (Next Peak) to execute a Next Peak search.

(3) Executing Dip search

The active marker is moved to the position where the marker value becomes minimal in the analysis time range. If two or more marker values exist, the point with the lower marker frequency is selected. When the detection mode is Pos&Neg, a search is executed depending on the marker detection mode setting: Positive detection trace data is searched when Pos is set, and Negative detection trace data is searched when Neg is set.

Example: To execute a Dip search

<Procedure>

1. Press .
2. Press  (Dip Search) to execute a Peak Dip search.

(4) Executing Next Dip search

The second lowest local maximum point (Dip) next to the marker value of the current active marker is detected and the active marker is moved to that position. If two or more marker values exist, the point with the lower marker frequency is selected. When the detection mode is Pos&Neg, a search is executed depending on the marker detection mode setting: Positive detection trace data is searched when Pos is set, or Negative detection trace data is searched when Neg is set.

Example: To execute a Next Dip search

<Procedure>





1. Press .
2. Press  (Next Dip). A Next Dip search is executed.

(5) Setting the search resolution

The Next Peak search and Next Dip search resolutions are set. Trace data with slopes greater than the resolution at both ends is to be searched.

Example: To set the search resolution value to 10 Hz

<Procedure>









1. Press .
2. Press  (Resolution).
3. Press  , and then press  (Hz) to set the search resolution.

(6) Setting the search threshold

The threshold to restrict marker values to be searched is set. A search is performed for marker values above/below the threshold.

Example: To set the marker values below 999 MHz as search targets when the center frequency is 1 GHz and span frequency is 31.25 MHz

<Procedure>

1. Press .
2. Press  (Threshold).
3. Press  (Threshold Above/Below) to switch to Below.
4. Press  (Threshold Frequency).
5. Press   , and then press  (MHz) to set the search threshold.

4.4.11 Measure measurement

Measure function menu

Press **F1** (Measure) on page 2 of Trace menu or press **Measure** to display Measure function menu.

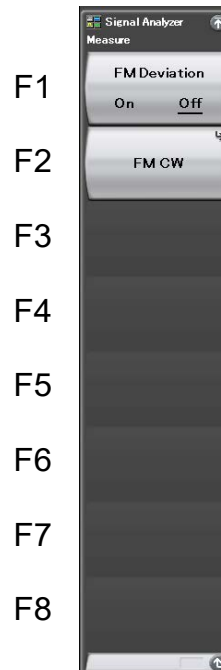

Figure 4.4.11-1 Measure function menu

Table 4.4.11-1 Measure function menu

Menu display	Function
FM Deviation (On/Off)	Executes FM Deviation measurement.
FM CW	Executes FM CW signal measurement.

(1) FM Deviation measurement

Measures the maximum and minimum frequency, based on the trace data within the marker range. The measurement range is between Marker 1 and 2 points on the trace. When either of Marker 1 and 2 is set to Off, the measurement is performed throughout the range on the trace. If set to On, then Scale Unit is set to ΔHz and Detection is set to Pos & Neg, and Peak-Peak function is set to On.

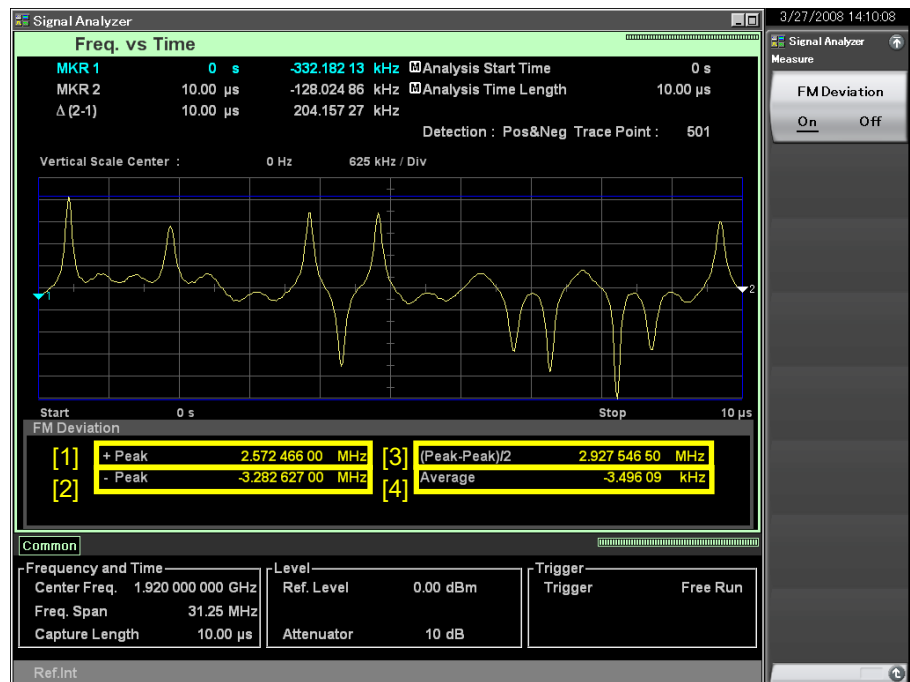

4

Trace

Figure 4.4.11-2 FM Deviation Measurement Trace

Table 4.4.11-2 Display Items

No.	Display	Descriptions
[1]	+Peak	Displays the maximum frequency.
[2]	-Peak	Displays the minimum frequency.
[3]	(Peak-Peak)/2	Displays (Peak-Peak)/2. It can be calculated by the following formula: $P_{P-P} = \frac{P_{Plus} - P_{Minus}}{2}$ Where: P _{P-P} : (Peak-Peak)/2 [Hz] P _{Plus} : +Peak [Hz] P _{Minus} : -Peak [Hz]
[4]	Average	Displays the average frequency.

(2) FM CW measurement

Measures the linearity of the time versus frequency slope of a signal in which the frequency increases or decreases with time (chirp signal) among the FM CW signals. In the FM CW measurement, the measurement range can be set by automatic detection or marker.

Automatically detectable signals

The following is the restrictions of the automatic detection and the detectable signal conditions in the FM CW measurement function.

- Up to 10 slopes can be detected by one measurement.
The slope that has been detected first is a measurement target.
- The minimum time length of a slope that is automatically detectable is one tenth or more of the analysis time length.
- The start and end of a slope need to be within the analysis time length as the following figure.

4.4.3 “Setting analysis time”

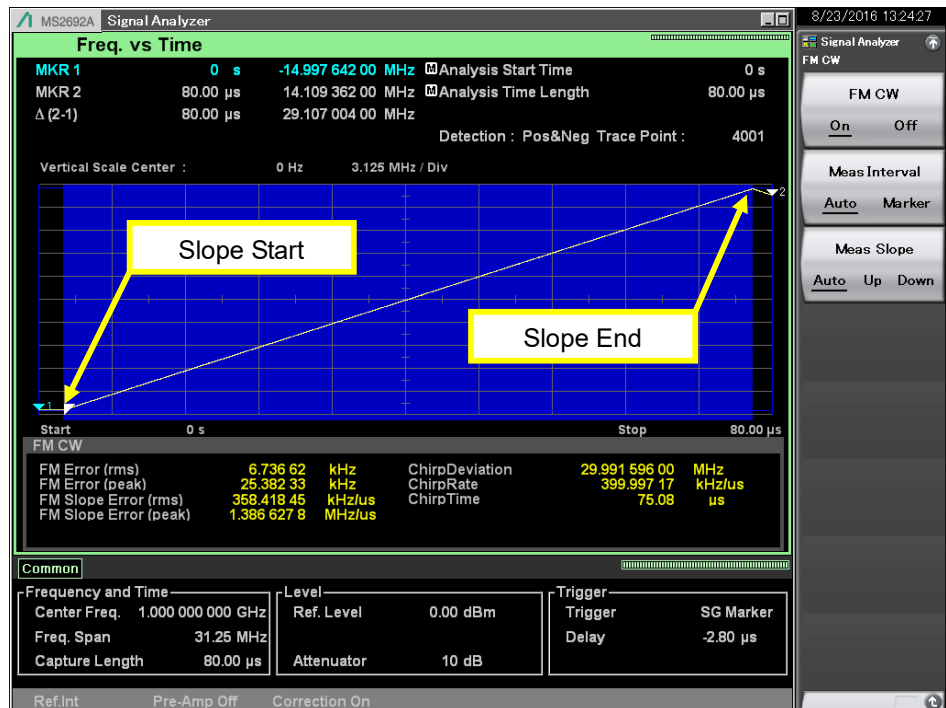
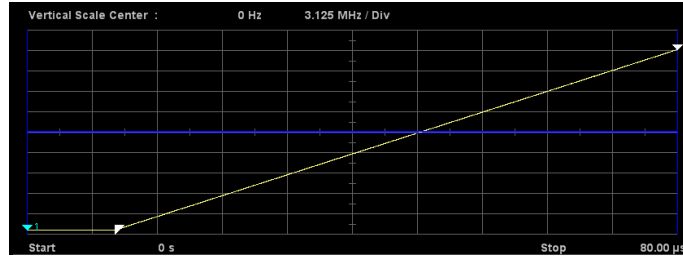
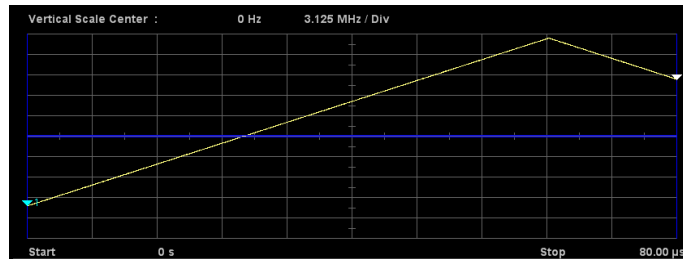

Figure 4.4.11-3 Slope start and end

If either of start or end of a slope is outside the analysis time length as the following figure, the slope is not detected automatically.



Slope end is missing



Slope start is missing

Figure 4.4.11-4 Cases where a slope is not detected automatically

4

Trace

FM CW function menu

Press  (FM CW) on Measure function menu to display FM CW function menu.

Table 4.4.11-3 FM CW function menu

Function Key	Menu display	Function
F1	FM CW (On/Off)	Sets the FM CW measurement function to On/Off. When it is set to On, other measure functions of the same trace are set to Off.
F2	Meas Interval (Auto/Marker)	Sets how to detect the slope of the FM CW signals. Auto: Detects the slope automatically. When there are multiple slopes, up to 10 slopes are automatically detected, but only the first-detected slope will be a measurement target. Marker: The range selected by Marker1 and 2 is a measurement target.
F3	Meas Slope (Auto/Up/Down)	Sets the slope type to detect automatically. Auto: Detects both upslopes and downslopes. Up: Detects upslopes. Down: Detects downslopes.

When detecting slopes automatically with Meas Interval set to Auto, the target slope is shown on a blue background as the following figure. Except the target, downslopes are shown on a green background and upslopes on a purple one.

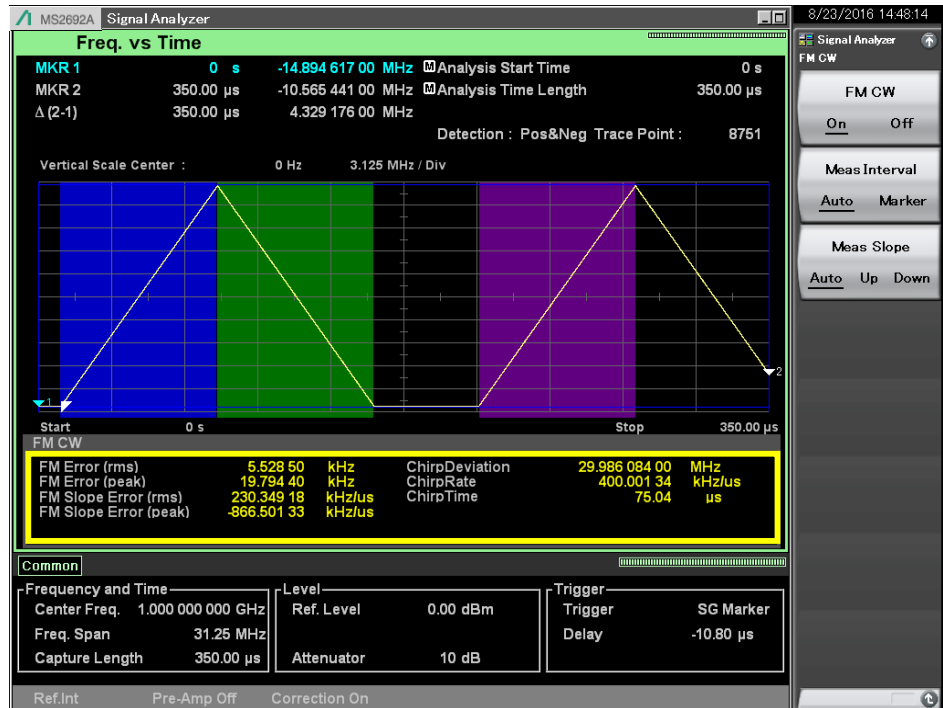

Figure 4.4.11-5 Slopes on colored backgrounds at automatic detection

4
Trace

Table 4.4.11-4 Display items of measurement results

Item	Description
FM Error (rms)	Displays the RMS value of the frequency error between the ideal slope* and measured value.
FM Error (peak)	Displays the peak value of the frequency error between the ideal slope* and measured value.
FM Slope Error (rms)	Displays the RMS value of the slope error between the ideal slope* and measured value.
FM Slope Error (peak)	Displays the peak value of the slope error between the ideal slope* and measured value.
Chirp Deviation	Displays the frequency deviation of the ideal slope*.
Chirp Rate	Displays the rate of the ideal slope*.
Chirp Time	Displays the time length of the measurement signal slope*.

*: The ideal slope is calculated using least square method in the range specified by automatic detection or marker.

The following figure shows measurement results of Table 4.4.11-4 Display Items of Measurement Results.

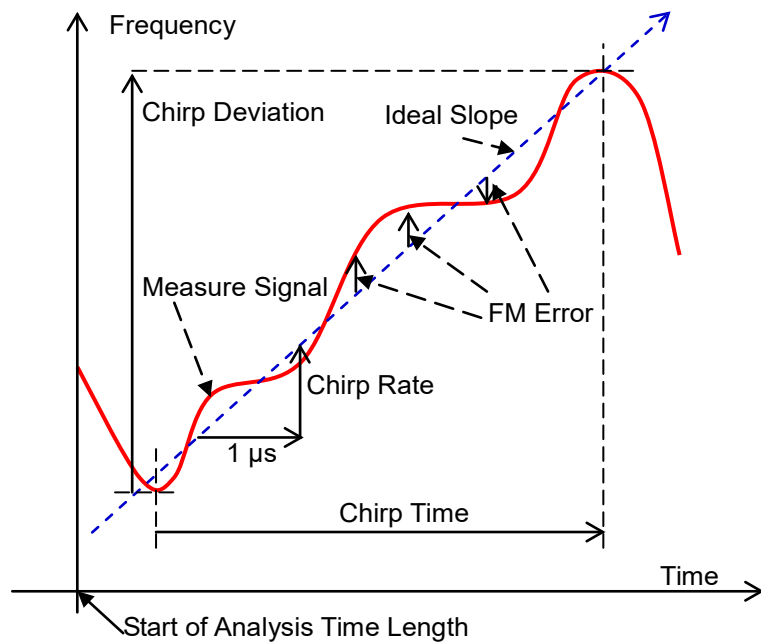

Figure 4.4.11-6 Explanatory figure of display items

4.5 Phase vs Time

4.5.1 What is Phase vs Time trace?

Phase vs Time trace is the display system to display the time fluctuation of phase from the acquired IQ digital data.

Display items of Phase vs Time trace are as follows:

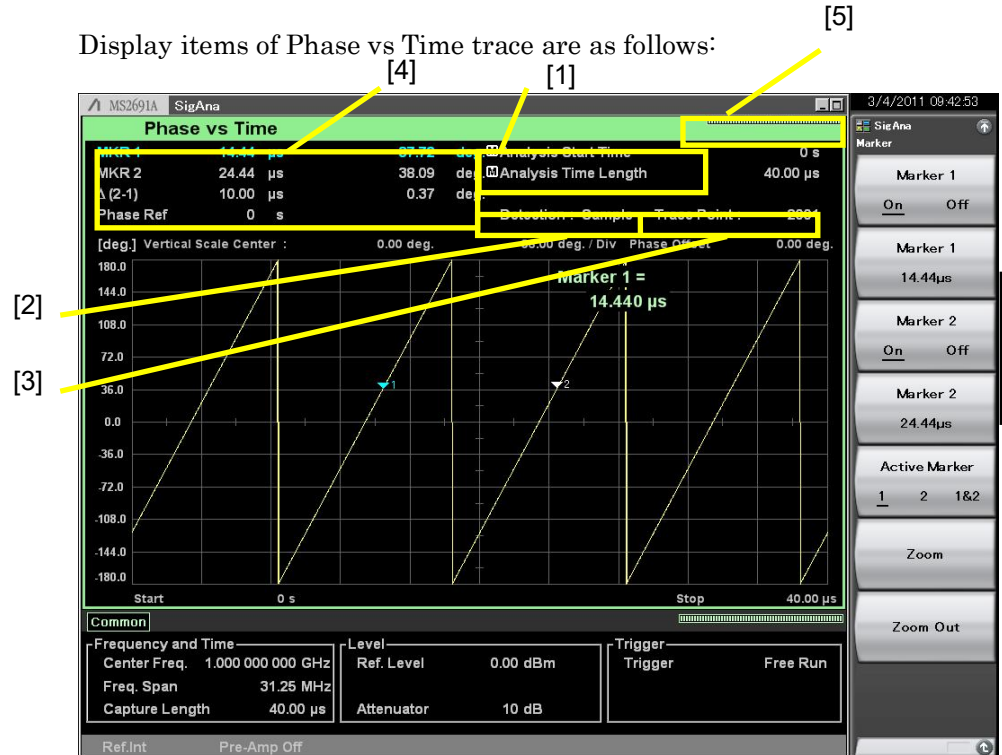

Figure 4.5.1-1 Display items for Phase vs Time trace

Table 4.5.1-1 Display items for Phase vs Time trace

No.	Display	Description
[1]	Analysis Start Time /Analysis Time Length	Displays the analysis start time and analysis time length.
[2]	Detection	Displays the detection mode.
[3]	Trace Point	Displays the trace point count (horizontal axis).
[4]	MKR1/MKR2/ Δ(2-1)	Displays the marker result value and marker frequency location.
[5]	Indicator	Displays the indicator showing analysis progress rate.

4.5.2 Setting Phase vs Time parameter

After selecting Phase vs Time for Trace Mode, pressing **F5** (Trace) of the main function key or pressing **Trace** displays the Trace function menu.

Trace function menu consists of two pages, which can be toggled by pressing **→**.

 4.1 “Selecting Trace”

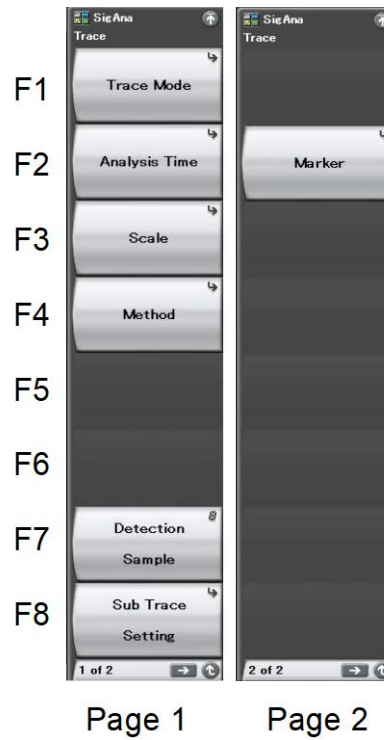











Figure 4.5.2-1 Trace function menu

Table 4.5.2-1 Trace function menu

Menu Display	Function
Trace Mode	Sets the trace type.  4.1 "Selecting Trace"
Analysis Time	Used for setting related to time.  4.5.3 "Setting analysis time"
Scale	Used for setting related to scale.  4.5.4 "Setting scale"
Detection	Used for setting related to detection.  4.5.5 "Setting detection mode"
Sub Trace Setting	Used for setting related to sub-trace.  4.9 "Sub-Trace"
Marker	Used for setting related to marker.  4.5.6 "Setting markers"
Method	Used for setting related to phase.  4.5.7 "Setting methods"

4.5.3 Setting analysis time

Pressing  (Analysis Time) on the Trace function menu or pressing  displays the Analysis Time function menu.

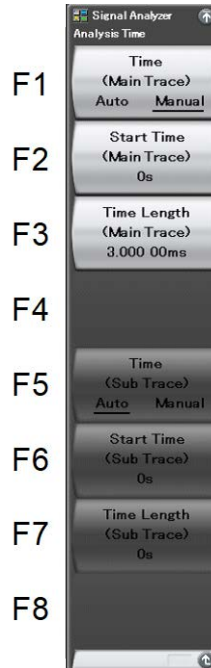

Figure 4.5.3-1 Analysis Time function menu

Table 4.5.3-1 Analysis Time function menu

Menu Display	Function
Time (Main Trace) (Auto/Manual)	Switches between auto setting and manual setting for the analysis start time (Analysis Start Time) and analysis time length (Analysis Time Length).
Start Time (Main Trace)	Sets the analysis start time.
Time Length (Main Trace)	Sets the analysis time length.
Time (Sub Trace) (Auto/Manual)	Switches between auto setting and manual setting of the analysis start time (Analysis Start Time) and analysis time length (Analysis Time Length) of a sub-trace.
Start Time (Sub Trace)	Sets the analysis start time of a sub-trace.
Time Length (Sub Trace)	Sets the analysis time length of a sub-trace.

Setting analysis time

Analysis time is time to be analyzed. The analysis time can be specified with the analysis start position (Analysis Start Time) and analysis time length (Analysis Time Length).

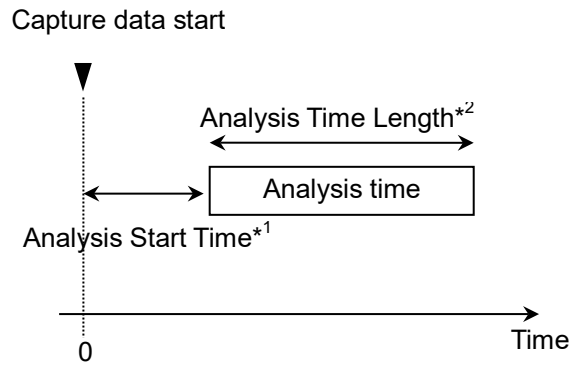

*1: Start of Analysis time based on capture data start

*2: Length of analysis time

Figure 4.5.3-2 Analysis time

(1) Auto mode

When Capture Time is set to Auto, the analysis time length is set to 100 ms for measurement.

When Capture Time is set to Manual, the analysis time length is set to the capture time for measurement.

Table 4.5.3-2 Setting analysis time in Auto mode

Capture Time	Analysis Start Time [s]	Analysis Time Length [s]
Auto	0	0.1
Manual	0	x_1

x_1 : Capture time length [s]

 2.4 "Setting IQ Data Capture Time Range"

(2) Manual mode

The analysis start time and analysis time length are set manually. This is an effective method to perform measurement of discontinuous signals such as burst.

Analysis start time setting range

Table 4.5.3-3 Analysis start time setting range in Manual mode

Capture Time	Minimum Value [s]	Maximum Value [s]
Auto	0	$x_2 - x_1$
Manual	0	$x_3 - x_1$

x_1 : Analysis time length [s]

x_2 : Capture time length maximum value [s]

 2.4 "Setting IQ Data Capture Time Range"

x_3 : Capture time length [s]

 2.4 "Setting IQ Data Capture Time Range"

Analysis time length setting range

Table 4.5.3-4 Analysis time length setting range

Time	Minimum Value [s]	Maximum value [s]
Auto	$\frac{100}{x_4}$	$x_2 - x_1$
Manual	$\frac{100}{x_4}$	$x_3 - x_1$

x_1 : Analysis start time [s]

x_2 : Capture time length maximum value [s]

 2.4 "Setting IQ Data Capture Time Range"

x_3 : Capture time length [s]

 2.4 "Setting IQ Data Capture Time Range"

x_4 : Sampling rate [Hz]

 2.2.2 "Setting frequency span"

Note:

The maximum value may be less than this value due to the restrictions imposed by the trace point.

Analysis start time resolution**Table 4.5.3-5 Frequency span and resolution**

Frequency Span	Resolution
1 kHz	0.5 ms
2.5 kHz	0.2 ms
5 kHz	0.1 ms
10 kHz	50 μ s
25 kHz	20 μ s
50 kHz	10 μ s
100 kHz	5 μ s
250 kHz	2 μ s
500 kHz	1 μ s
1 MHz	0.5 μ s
2.5 MHz	0.2 μ s
5 MHz	0.1 μ s
10 MHz	50 ns
25 MHz	20 ns
31.25 MHz	20 ns
50 MHz*1	10 ns
62.5 MHz*2	10 ns
100 MHz*3	5 ns
125 MHz*3	5 ns

*1: 50 MHz can be set only when Option 004/104/077/177 is installed.









*2: 62.5 MHz can be set only when Option 077/177 is installed.

*3: 100 MHz and 125 MHz can be set only when Option 004/104/078/178 is installed.

Setting procedure for analysis time

Example: To switch the analysis time to Manual setting, and setting the analysis start time to 20 ns and analysis time to 2 μ s

<Procedure>

1. Press .
2. Press  (Start Time).
3. Press  , and then press  (ns) to set analysis start time.
4. Press  (Time Length).
5. Press , and then press  (μ s) to set analysis time length.

4.5.4 Setting scale

Scale function menu

Pressing **Trace**, and then **F3**(Scale) displays the Scale function menu.

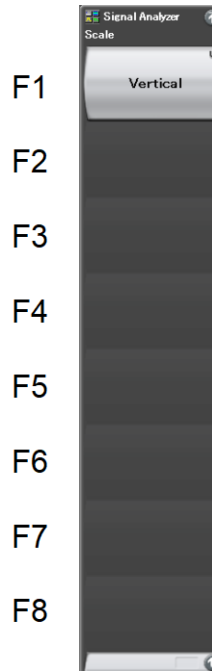

Figure 4.5.4-1 Scale function menu

Table 4.5.4-1 Scale function menu

Menu Display	Function
Vertical	Used for setting related to the vertical axis (phase axis) scale.

Vertical function menu

Pressing **F1** (Vertical) on the Scale function menu displays the Vertical function menu.



Figure 4.5.4-2 Vertical function menu

Table 4.5.4-2 Vertical function menu

Menu Display	Function
Scale Division	Sets the range of the vertical axis.

(1) Setting the numeric range of the vertical axis

For Phase vs Time trace, the vertical axis setting range (Phase Scale Division) is as follows:

Phase setting range (degree) : 0.01 to 200G

Example: To set the numeric value of the vertical axis to 1

<Procedure>

1. Press **Trace**.
2. Press **F3** (Scale).
3. Press **F1** (Vertical).
4. After pressing **F1** (Scale Division), press **1**, and then press **F7** (Set) to set the numeric value.

4.5.5 Setting detection mode

Pressing **Trace**, and then **F7** (Detection) selects the detection mode.

Detection mode types

The detection mode within analysis range (Detection) is set. The detection mode can be selected from four types: Average, Sample, Positive, and Negative.

Table 4.5.5-1 Detection Mode

Detection Mode	Description
Average	Traces the average value within the analysis range.
Sample	Traces the measured points within the analysis range.
Positive	Traces the maximum value within the analysis range. Positive is used to measure the upper envelope of the modulation waveform.
Negative	Traces the minimum value within the analysis range. Negative is used to measure the lower envelope of modulated waveform.

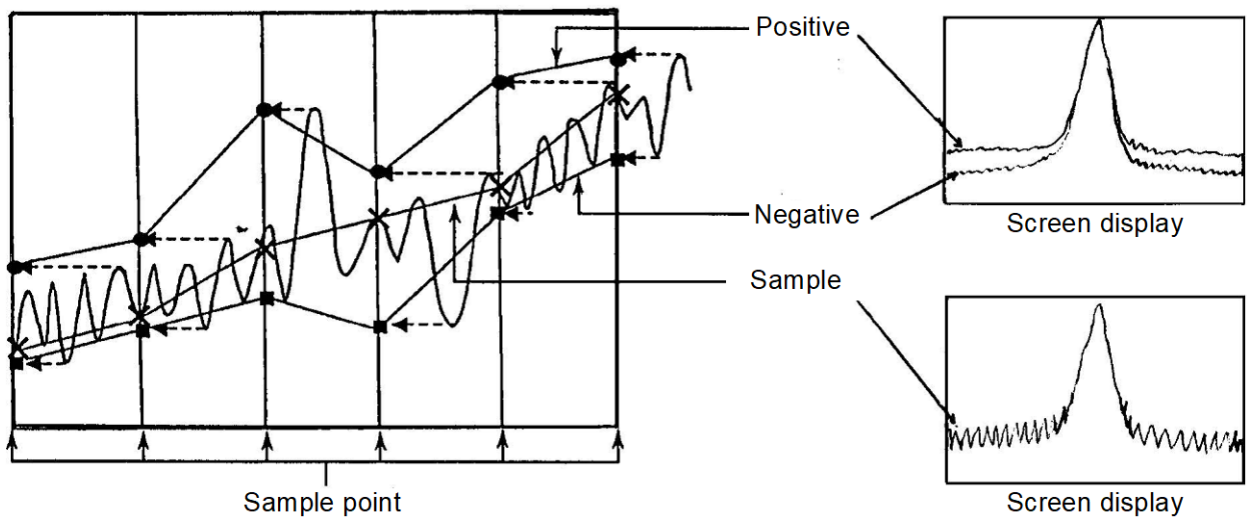

Figure 4.5.5-1 Display example of detection mode

(1) Setting detection mode

Example: To set the detection mode to Negative

<Procedure>

1. Press **Trace**.
2. Press **F7** (Detection) and select Negative.

4.5.6 Setting markers

This section describes various Marker functions as well as the functions to improve measurement efficiency, such as marker search and parameter setting with marker values.

Pressing **F2** (Marker) on page 2 of the Trace function menu, or pressing **Marker** displays the Marker function menu.

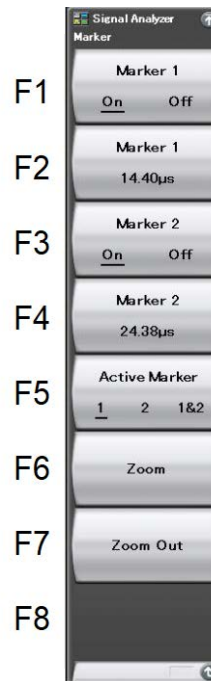

Figure 4.5.6-1 Marker function menu

Table 4.5.6-1 Marker function menu

Menu Display	Function
Marker 1 (On/Off)	Sets whether to display time marker 1.
Marker 1	Sets time marker 1.
Marker 2 (On/Off)	Sets whether to display time marker 2.
Marker 2	Sets time marker 2.
Active Marker (1 / 2 / 1&2)	Selects the active marker.
Zoom	Zooms in on the range of Marker 1 and Marker 2.
Zoom Out	Reduces the current screen display data into the range of Marker 1 and Marker 2.

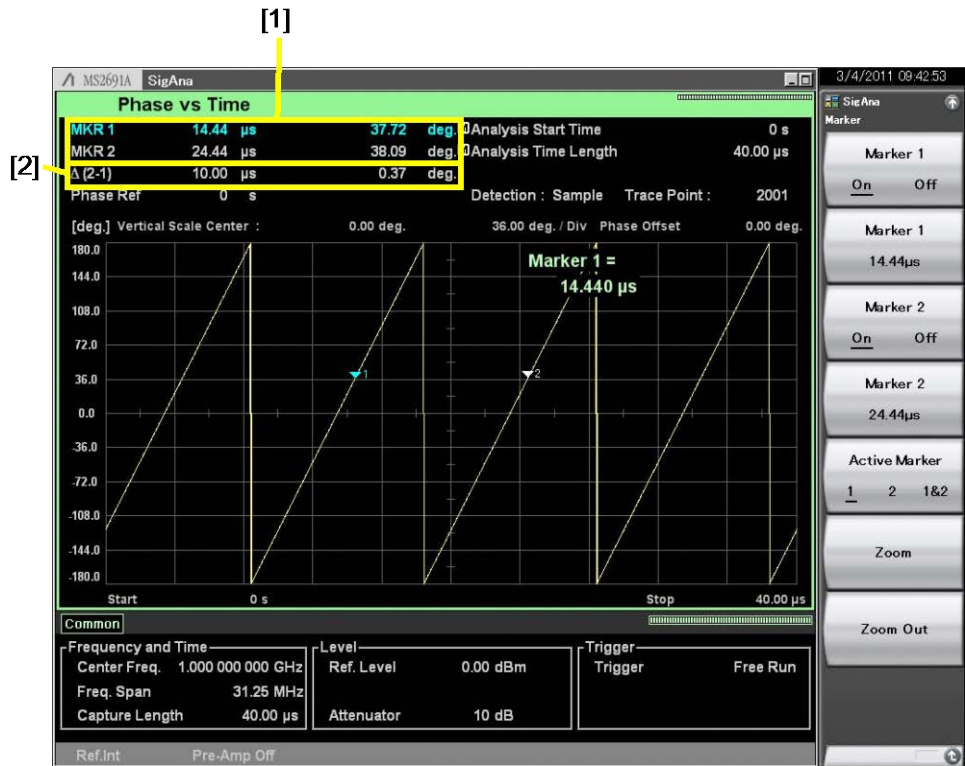

Figure 4.5.6-2 Display items for marker results

Table 4.5.6-2 Display items for marker results

No.	Display	Description
[1]	MRK1 / MRK2	Displays the phase at each marker time position.
[2]	$\Delta(2 - 1)$	Displays the phase difference (Marker 2 – Marker 1) at marker time position.

(1) Changing the marker position

Note:

The marker position of Power vs Time, Frequency vs Time, Phase vs Time synchronizes one another.

The phase in the specified time can be measured by using the marker displayed in Figure 4.5.6-3.

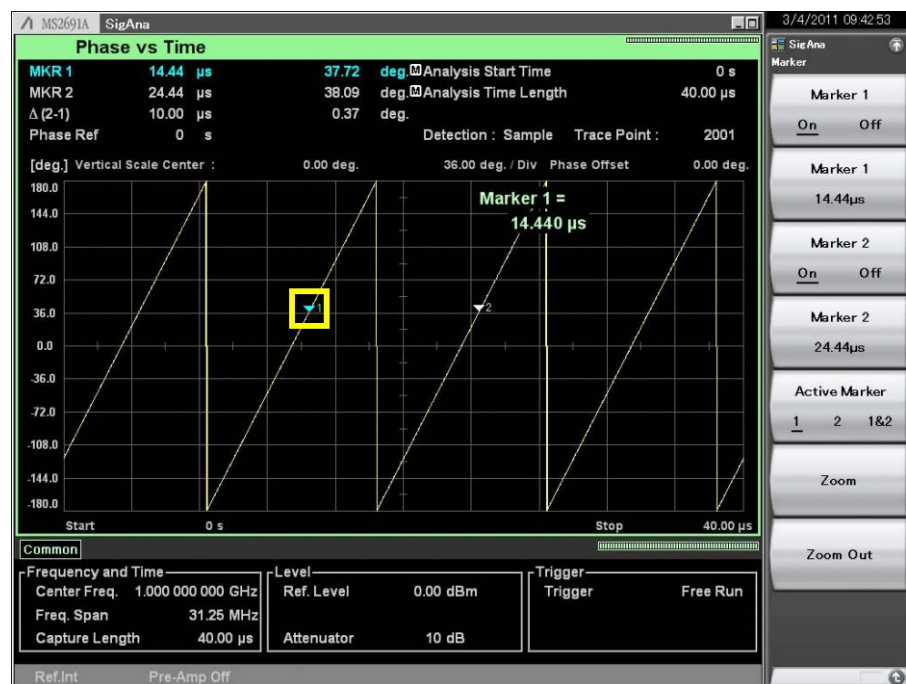

Figure 4.5.6-3 Marker

Example: To set Marker 1 to 1.5 μs

<Procedure>

1. Press **Marker**.
2. Press **F2** (Marker 1).
3. Press **1** **.** **5**, and then press **F3** (μs).

4

Trace

(2) Selecting the active marker





Note:

This setting is enabled when both Marker 1 and 2 are On.

The active marker is selected. The marker position of the active marker can be set with the rotary knob or step key.

Example: To set the active marker

<Procedure>

1. Press .
2. Press  (Marker 1 On/Off) and select On.
3. Press  (Marker 2 On/Off) and select On.
4. Press  (Active Marker 1/2/1&2) and select the active marker.



(3) Setting zooming in

Note:

This setting is enabled when both Marker 1 and 2 are On.

Example: To zoom in the range from Marker 1 to Marker 2

<Procedure>

1. Press .
2. Press  (Zoom). The range enclosed with Markers 1 and 2 is zoomed in.

As shown in Figure 4.5.6-4, when Zoom is performed after setting the range with Markers 1 and 2, the Analysis Start Time and Analysis Time Length are changed to the range of Markers 1 and 2.

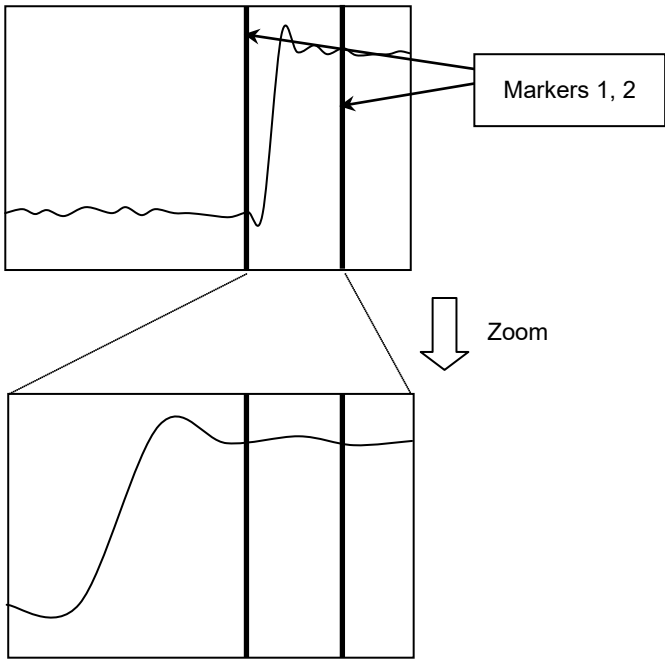

Figure 4.5.6-4 Zoom



(4) Setting zooming out

Note:

This setting is enabled when both Marker 1 and 2 are On.

Example: To reduce the analysis range to the range of Markers 1 and 2

<Procedure>

1. Press .
2. Press  (Zoom Out). The displayed waveform data is zoomed out to the range enclosed with Markers 1 and 2.

As shown in Figure 4.5.6-5, when Zoom Out is performed after setting the range with Markers 1 and 2, the range of Markers 1 and 2 is changed to the Analysis Start Time and Analysis Time Length.

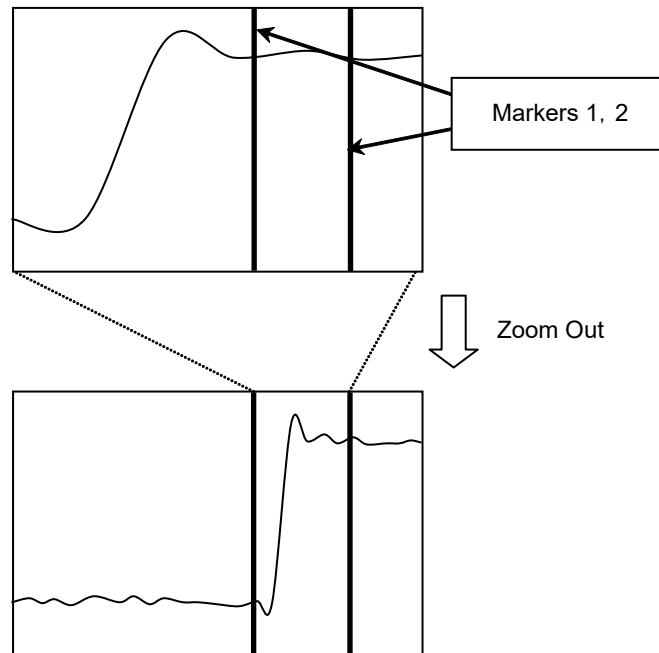



Figure 4.5.6-5 Zoom Out

4.5.7 Setting methods

Method function menu

Pressing  (Method) on page 1 of Trace function menu displays Method function menu.



Trace

Figure 4.5.7-1 Method function menu

Table 4.5.7-1 Method function menu

Menu Display	Function
Phase Mode	Sets wrap or unwrap.
Phase Offset	Sets the offset value of the Phase vs Time graph.
Phase Ref Mode	Sets whether to set phase reference time.
Phase Ref	Sets phase reference time.







(1) Setting vertical axis offset

Vertical axis offset is set. The setting range is as follows:

Setting range of phase offset: -100 M to +100 M

Example: To set the offset of the vertical axis to 10

<Procedure>

1. Press .
2. Press  (Method).
3. Press  (Phase Offset).
4. Press  , and then press  (Set) to set the numeric value.







(2) Setting the phase reference

Uses the time phase of specified time as reference. The setting range is as follows:

Setting range of phase reference: 0 s to 2000 s

Example: To set the horizontal axis reference to 10s

<Procedure>

1. Press .
2. Press  (Method).
3. Press  (Phase Ref Mode) to select On.
4. Press  (Phase Ref).
5. Press  , and then press  (Set) to set the numeric value.

(3) Setting graph display method



Graph display method is set.

Wrap: Displays the signal phase between -180 deg to +180 deg.

Unwrap: Displays the accumulated result of signal phase difference.

Example: To set the graph display method to unwrap

<Procedure>

1. Press .
2. Press  (Method).
3. Press  (Phase Mode), and select **unwrap**.

4.6 CCDF

4.6.1 What is CCDF trace?

CCDF trace is a screen that performs a CCDF (Complementary Cumulative Distribution Function) analysis of the obtained IQ digital data to display.

The display items for a CCDF trace are as described below.

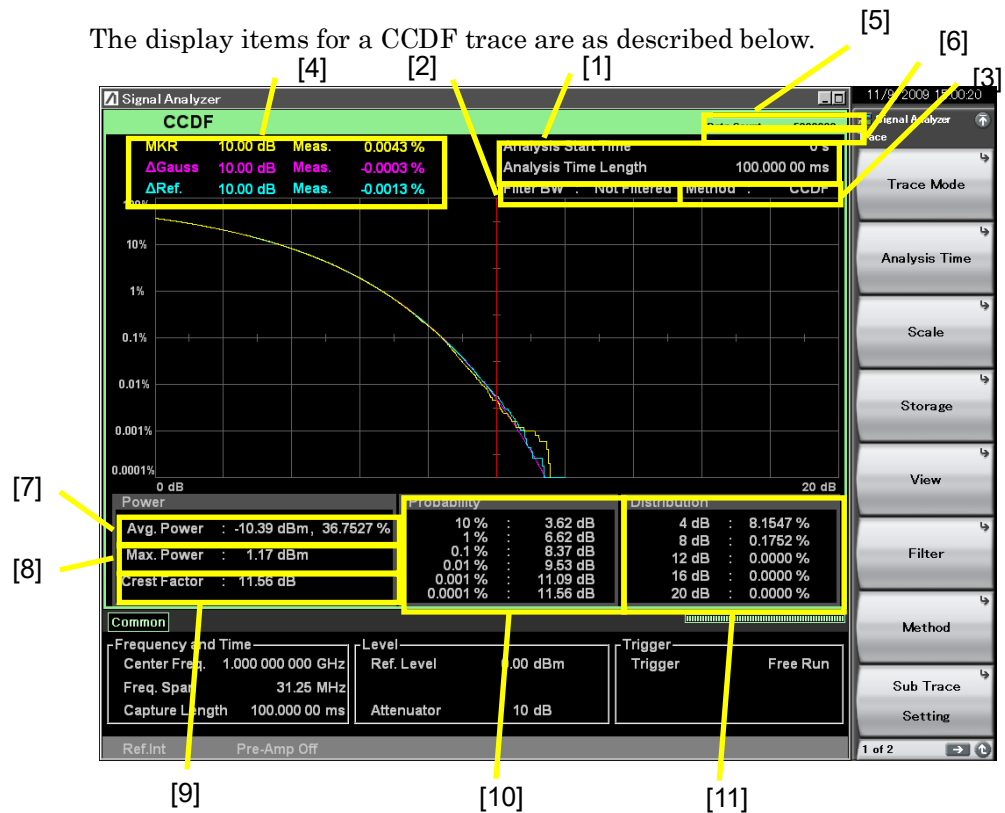

Figure 4.6.1-1 Display items for CCDF trace

4
Trace

Table 4.6.1-1 Display items for CCDF trace

No.	Display	Descriptions
[1]	Analysis Start Time/ Analysis Time Length	Displays the analysis start time and analysis time length.
[2]	Filter BW	Displays the filter bandwidth. "Not Filtered" is displayed when the filter is Off.
[3]	Method	Displays the measurement method.
[4]	MKR	Displays the marker result value and marker position.
[5]	Indicator	Displays the indicator showing the analysis progress rate.
[6]	Data Count	Displays the measurement point count.
[7]	Avg. Power	Displays the average power of the measurement point and its cumulative probability.
[8]	Max. Power	Displays the maximum power of the measurement point as an absolute value.
[9]	Crest Factor	Displays the crest factor of the measurement point.
[10]	Power Deviation	Displays the power deviations at which the probability distribution is 10%, 1%, 0.1%, 0.01%, 0.001%, and 0.0001%. If two or more corresponding power deviations exist, the greater value is assumed to be the result.
[11]	Probability Distribution	Displays the probability distribution above the deviation at the grid position.

4.6.2 Setting CCDF parameters

After selecting CCDF for Trace Mode, pressing **FG** (Trace) on the main function menu or pressing **Trace** displays the Trace function menu.

 4.1 "Selecting Trace"

Trace function menu consists of two pages, which can be toggled by pressing **→**.

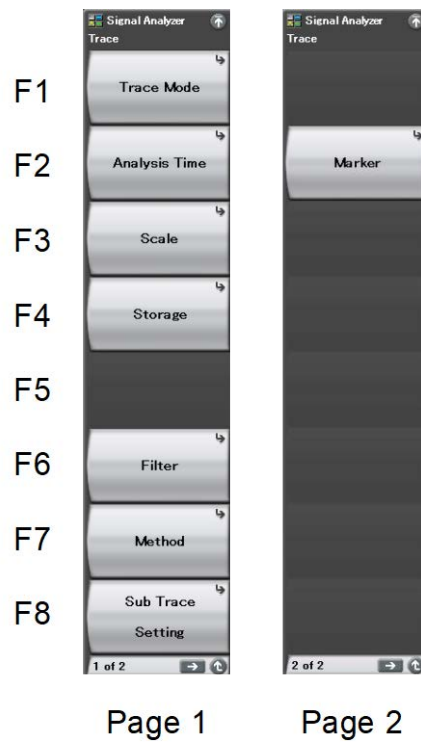









4

Trace

Figure 4.6.2-1 Trace function menu

Table 4.6.2-1 Trace function menu

Menu Display	Function
Trace Mode	Sets the trace type.  4.1 "Selecting Trace"
Analysis Time	Used for setting related to the analysis time.  4.6.4 "Setting analysis time"
Scale	Sets the scale.  4.6.6 "Setting display format"
Storage	Used for setting related to cumulative data reset.  4.6.7 "Setting cumulative data reset"
View	Used for setting trace type for viewing.  4.6.8 "Setting Trace Display"
Filter	Sets the filter.  4.6.9 "Setting filter"
Method	Selects the measurement method.  4.6.3 "Selecting measurement method"
Sub Trace Setting	Used for setting related sub trace.  4.9 "Sub-Trace"
Marker	Used for setting related to the marker.  4.6.10 "Setting markers"

4.6.3 Selecting measurement method

Pressing **Trace** and then **F7** (Method) displays the Method function menu.

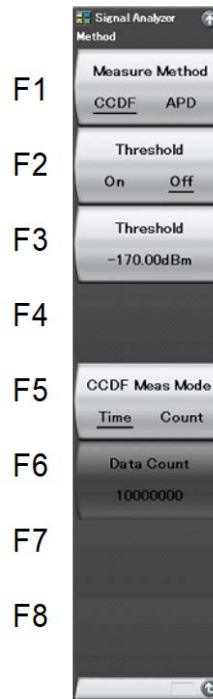

Figure 4.6.3-1 Method function menu

Table 4.6.3-1 Method function menu

Menu Display	Function
Measure Method (CCDF/APD)	Selects the measurement method.
Threshold (On/Off)	Enables/Disables the minimum level set for CCDF measurement. When it is set to On, signals under the level set in Threshold are not measured.
Threshold	Sets the minimum level used for measurement.
CCDF Meas Mode (Time/Count)	Sets the specified method of the measurement interval.
Data Count	Sets the data count for the measurement target when CCDF Meas Mode is Count.

(1) Setting the measurement method



Select the measurement method (Measure Method). There are the following two measurement method types.

CCDF: Measures and displays CCDF (Complementary Cumulative Distribution Function). In this measurement, the cumulative distribution of instantaneous power deviation for the average power is measured and displayed.

APD: Measures and displays APD (Amplitude Probability Density). In this measurement, the probability distribution of instantaneous power deviation for the average power is measured and displayed.

Example: To set Measure Method selection

<Procedure>









1. Press .
2. Press  (Method).
3. Press  (Measure Method CCDF/APD), and then select CCDF/APD to set the measurement method.

(2) Setting the minimum level

The minimum level (Threshold) of data used for measurement is set. When Threshold is set to On, any sampling points under the level specified here are not included in the data.

Example: To set the minimum level to -170 dBm

<Procedure>

1. Press .
2. Press  (Method).
3. Press  (Threshold).
4. Press    , and then press  (Set) to set the minimum level.

(3) Setting CCDF Meas Mode

Select the specified method of the measurement span. There are the following two specified method types.



- Time : The target is the measurement interval set at Analysis Time.
Count : Measures until the sample count set at Data Count is met.

Note:

This function cannot be set when Capture Time is Manual. For the Capture Time settings, refer to Section 4.6.4 “Setting analysis time”.

Example: To set CCDF Meas Mode

<Procedure>

1. Press .
2. Press  (Method).
3. Press  (CCDF Meas Mode) to select Time or Count.

4.6.4 Setting analysis time

Pressing **F2** (Analysis Time) on the Trace function menu, or pressing **Time/Sweep** displays the Analysis Time function menu.

Trace function menu consists of two pages, which can be toggled by pressing **→**.

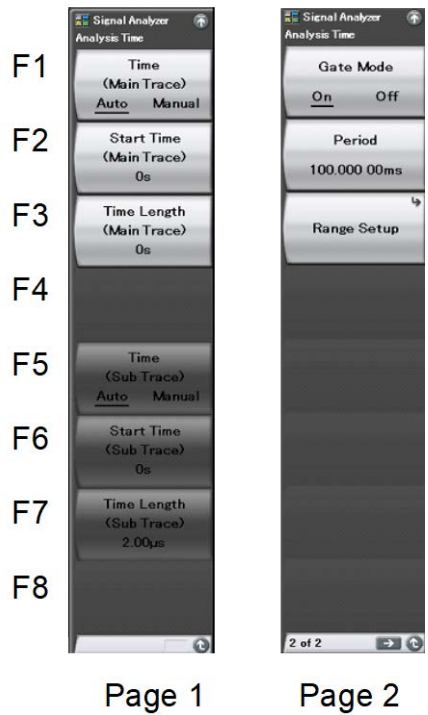



Figure 4.6.4-1 Analysis Time function menu

Table 4.6.4-1 Analysis Time function menu

Menu Display	Function
Time (Main Trace) (Auto/Manual)	Switches between auto mode and manual mode for the analysis start time (Analysis Start Time) and analysis time length (Analysis Time Length).
Start Time (Main Trace)	Sets the analysis start time.
Time Length (Main Trace)	Sets the analysis time length.
Time (Sub Trace) (Auto/Manual)	Switches between auto mode and manual mode for the analysis start time (Analysis Start Time) and analysis time length (Analysis Time Length) of a sub-trace.
Start Time (Sub Trace)	Sets the analysis start time of a sub-trace.
Time Length (Sub Trace)	Sets the analysis time length of a sub-trace.
Gate Mode (On/Off)	Sets the specified method of the measurement interval. When this is On, a part of the analysis interval specified by Start Time (Main Trace) and Time Length (Main Trace) is defined as measurement target.
Period	Sets the period interval, which is the unit of the range setting.
Range Setup	Sets the range.  4.6.5 "Setting range"

Setting the analysis time

Analysis time is the target time for analysis. The analysis time can be specified with the analysis start position (Analysis Start Time) and analysis time length (Analysis Time Length).

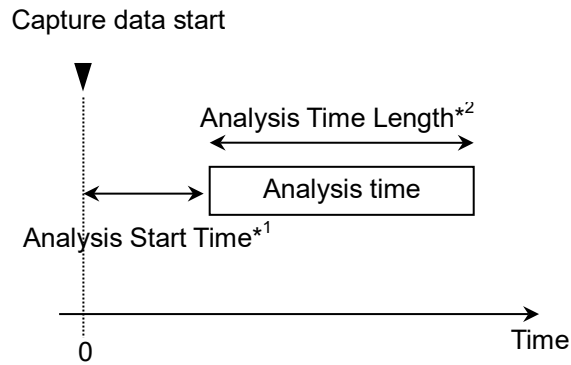

*1: Start of Analysis time based on capture data start

*2: Length of analysis time

Figure 4.6.4-2 Analysis time

(1) Auto mode

When Capture Time is set to Auto, the analysis time length is automatically set to 100 ms. When Capture Time is set to Manual, the analysis start time and analysis time length are set automatically so that the entire capture time specified in Capture Time Length becomes the analysis range.

Table 4.6.4-2 Setting analysis time in Auto mode

Capture Time	Analysis Start Time [s]	Analysis Time Length [s]
Auto	0	0.1
Manual	0	x_1

x_1 : capture time length [s]

 2.4 "Setting IQ Data Capture Time Range"

(2) Manual mode

The analysis start time and analysis time length are set manually. This is an effective method for measuring discontinuous signals such as burst.

Analysis start time setting range**Table 4.6.4-3 Analysis start time setting range in Manual mode**

Capture Time	Minimum Value [s]	Maximum Value [s]
Auto	0	$x_2 - x_1$
Manual	0	$x_3 - x_1$

x_1 : Analysis time length [s]

x_2 : Capture time length maximum value [s]

 2.4 "Setting IQ Data Capture Time Range"

x_3 : Capture time length [s]

 2.4 "Setting IQ Data Capture Time Range"

Analysis time length setting range**Table 4.6.4-4 Analysis time length setting range**

Capture Time	Minimum Value [s]	Maximum Value [s]
Auto	$\frac{1}{x_4}$	$x_2 - x_1$
Manual	$\frac{1}{x_4}$	$x_3 - x_1$

x_1 : Analysis start time [s]

x_2 : Capture time length maximum value [s]

 2.4 "Setting IQ Data Capture Time Range"

x_3 : Capture time length [s]

 2.4 "Setting IQ Data Capture Time Range"

x_4 : Sampling rate [Hz]

 2.2.2 "Setting frequency span"

Analysis start time and analysis time length resolution**Table 4.6.4-5 Frequency span and resolution**

Frequency Span	Resolution
1 kHz	0.5 ms
2.5 kHz	0.2 ms
5 kHz	0.1 ms
10 kHz	50 μ s
25 kHz	20 μ s
50 kHz	10 μ s
100 kHz	5 μ s
250 kHz	2 μ s
500 kHz	1 μ s
1 MHz	0.5 μ s
2.5 MHz	0.2 μ s
5 MHz	0.1 μ s
10 MHz	50 ns
25 MHz	20 ns
31.25 MHz	20 ns
50 MHz* ¹	10 ns
62.5 MHz* ²	10 ns
100 MHz* ³	5 ns
125 MHz* ³	5 ns

*1: 50 MHz can be set only when Option 004/104/077/177 is installed.

*2: 62.5 MHz can be set only when Option 077/177 is installed.

*3: 100 MHz and 125 MHz can be set only when Option 004/104/078/178 is installed.

Setting procedure for analysis time

Example: To set the analysis start time to 20 ms and analysis time length to 60 ms

<Procedure>

1. Press .
2. Press (Start Time).
3. Press , and then press (ms) to set the analysis start time.
4. Press (Time Length).
5. Press , and then press (ms) to set the analysis start time length.

Setting gate mode

This mode is for measuring a specific part of the analysis period specified by Analysis Start Time and Analysis Time Length at CCDF measurement of burst waveforms. Measurement is repeated over by separating the analysis time into Period units. Range 1, 2, and 3 are specified in each Period and the data to be measured is specified according to each setting to calculate CCDF.

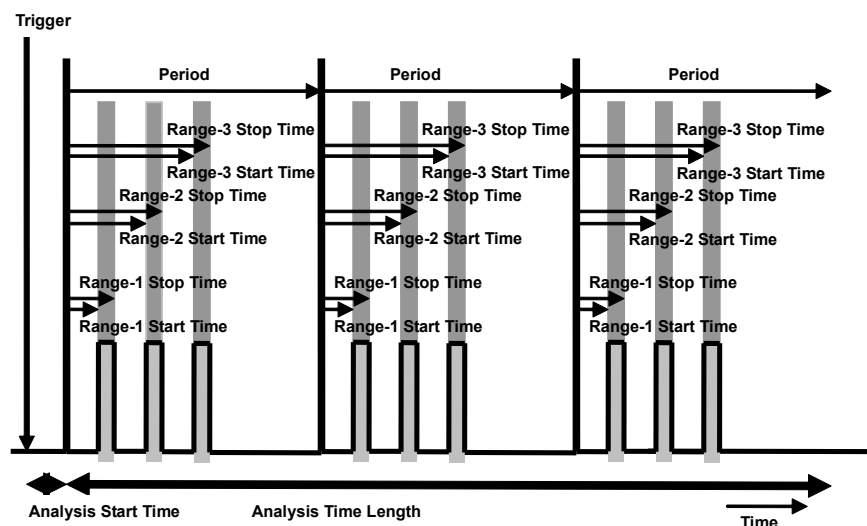





Figure 4.6.4-3 Setting gate mode

Setting procedure for gate mode

Example: To set the period to 6 ms

<Procedure>

1. Open the second page of the Analysis Time function menu, and press  (Gate Mode) to set the gate mode to On.
2. Press  (Period).
3. The period is set when pressing  and  (ms).

4.6.5 Setting range

When pressing **F2** (Analysis Time) and **F3** (Range Setup) after pressing **Trace**, the Range Setup function menu is displayed.



Figure 4.6.5-1 Range function menu

4
Trace

Table 4.6.5-1 Explanation of Range function menu

Menu Display	Function
Edit Range Number	Edits the range number to be measured.
Range (On/Off)	Sets whether to execute the range measurement.
Start time	Sets the measurement start time for each range.
Stop time	Sets the measurement stop time for each range.

Setting procedure for range measurement

Example: To set the measurement start time of the range 2 to 2 ms

<Procedure>

1. Open the second page of the Analysis Time function menu, and press **F3** (Range Setup).
2. Press **F1** (Edit Range Number), and next press **2**. Then press **F7** (Set) to set Range2.
3. Pressing **F3** (Start Time), **2**, and **F2** (ms) sets the measurement start time to 2 ms.

4.6.6 Setting display format

Pressing **Trace** and then **F3** (Scale) displays the Scale function menu.

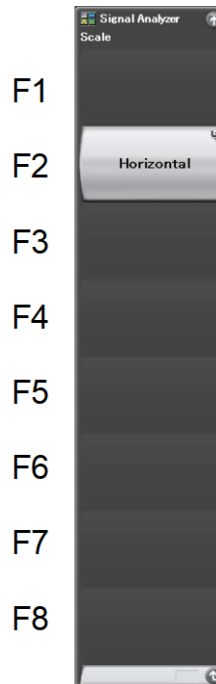

Figure 4.6.6-1 Scale function menu

Table 4.6.6-1 Scale function menu

Menu Display	Function
Horizontal Scale	Changes the scale of the power axis.

(1) Setting the Horizontal Scale

The power axis scale is set.

Example: To set the power axis scale to 5 dB

<Procedure>

1. Press **Trace**.
2. Press **F3** (Scale).
3. Press **F2** (Horizontal Scale), and then select **F1** (5 dB) to set the power axis scale.

The scale can be selected from the following four types:

- 5 dB Set the maximum value to 5 dB.
- 10 dB Set the maximum value to 10 dB.
- 20 dB Set the maximum value to 20 dB.
- 50 dB Set the maximum value to 50 dB.

4.6.7 Setting cumulative data reset

Pressing **Trace** and then **F4** (Storage) displays the Storage function menu.



Figure 4.6.7-1 Storage function menu

Table 4.6.7-1 Storage function menu

Menu Display	Function
Reset Every Capture (On/Off)	Sets whether to reset the results for each measurement.
Restart	Clears all the accumulated data.

In a CCDF trace, the obtained IQ data is accumulated as cumulative data even after one measurement is finished, unless otherwise specified.

(1) Setting Restart



All the accumulated data is erased. Data Count is re-started from 0.

Example: To set Restart

<Procedure>



1. Press .
2. Press  (Storage).
3. Press  (Restart).

(2) Setting Reset Every Capture

Whether to reset the results for each measurement is set. When Reset Every Capture is set to On, the cumulative data is deleted when  or  is pressed.

Example: To set Reset Every Capture

<Procedure>

1. Press .
2. Press  (Storage).
3. Press  (Reset Every Capture On/Off) and select On.

4.6.8 Setting Trace Display

This allows you to configure settings related to trace display for CCDF.

Pressing **F5** (View) in the Trace function menu displays the View function menu.



Figure 4.6.8-1 View function menu

Table 4.6.8-1 View function menu description

Menu Display	Function
Store to Ref Trace	Temporarily saves the currently displayed trace. When Reference Trace is set to On, the saved trace is displayed in blue. This data is not saved when the power is turned off or the application is unloaded.
Gaussian Trace	Switches between showing and hiding the Gaussian waveform.
Reference Trace	Switches between showing and hiding the trace saved using the Store to Ref Trace function.

4.6.9 Setting filter

The setting related to the filter is performed.

Pressing **F6** (Filter) from the Trace function menu, or pressing **BW** displays the Filter function menu.

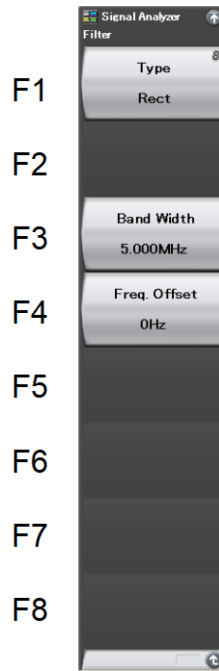

Figure 4.6.9-1 Filter function menu









Table 4.6.9-1 Filter function menu

Menu Display	Function
Type	Selects the filter type.
Band Width	Sets the filter band.
Freq. Offset	Sets the filter frequency offset.

(1) Rectangular filter

Example: To set the filter shape to Rect, filter bandwidth to 6 MHz, and filter frequency offset to 1 kHz

<Procedure>

1. Press .
2. Press  (Type) and select Rect.
3. Press  (Band Width).
4. Press , and then press  (MHz) to set the filter bandwidth.
5. Press  (Freq. Offset).
6. Press , and then press  (kHz) to set the filter frequency offset.

Refer to 4.3.5 “Setting filter” for details on the setting range and resolution.

4.6.10 Setting markers

This section describes various Marker functions.

Pressing **F2** (Marker) on page 2 of the Trace function menu, or pressing **Marker** displays the Marker function menu.

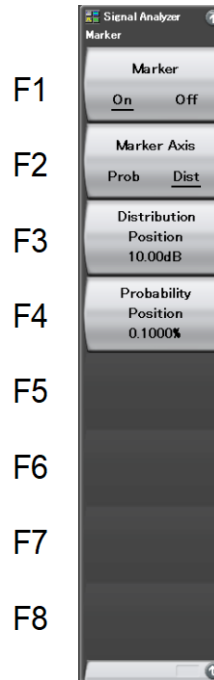

Figure 4.6.10-1 Marker function menu

Table 4.6.10-1 Marker function menu

Menu Display	Function
Marker (On/Off)	Sets the marker to On/Off .
Marker Axis (Prob/Dist)	Sets the marker line as the vertical axis (probability) or horizontal axis (power).
Distribution Position	Sets the marker position on the power distribution axis.
Probability Position	Sets the marker position on the probability distribution axis.



Figure 4.6.10-2 Display items for marker results

Table 4.6.10-2 Display items for marker results

No.	Display	Descriptions
[1]	MKR/Meas.	Displays the power deviation for the probability specified by the marker, or probability for the power deviation specified by the marker.
[2]	Δ Gauss	Displays the marker result for the Gaussian waveform. This is displayed when Gaussian Trace is On.
[3]	Δ Ref.	Displays the marker result for the temporarily saved trace. This is displayed when Reference Trace is On.

4 Trace

Changing the marker position

The power deviation with the specified probability or the probability of the specified power deviation can be measured depending on the displayed marker.



(1) Setting the marker axis

The marker axis can be selected from the following two types.

- Distribution: Sets the marker line to power
- Probability: Sets the marker line to probability

Example: To set the marker axis

<Procedure>

1. Press .
2. Press  (Marker Axis), and then select Probability/Distribution to set the marker axis.





(2) Setting the marker position

The marker position is set. The marker value is measured by specifying one of the following.

- Distribution Position: Measures probability by specifying power deviation.
- Probability Position: Measures power deviation by specifying probability.

Example: To set the Distribution Position value to 20 dB

<Procedure>





1. Press .
2. Press  (Distribution Position).
3. Press  , and then press  (dB) to set the marker position on the power distribution axis.

Setting range and minimum resolution for Distribution Position

- Setting range: -Horizontal Scale to Horizontal Scale (APD)
0 to Horizontal Scale (CCDF)
- Minimum resolution: 0.01 dB
- Rotary knob resolution: 0.01 dB
- Step key resolution: Display grid

Example: Setting the Probability Position value to 10%

<Procedure>

1. Press .
2. Press  (Probability Position).
3. Press  , and then press  (%) to set the marker position on the probability distribution axis.

Setting range and resolution for Probability Position

Setting range:	0.0001 to 100
Minimum resolution:	0.0001%
Rotary knob resolution:	1 step at the highest 1st digit
Step key resolution:	Display grid

4.7 Spectrogram

4.7.1 What is Spectrogram Trace?

Spectrogram trace analyzes the captured IQ data by using FFT (Fast Fourier Transform) and diagrams the changes in a spectrum over time.

The display items of Spectrogram trace are described below:

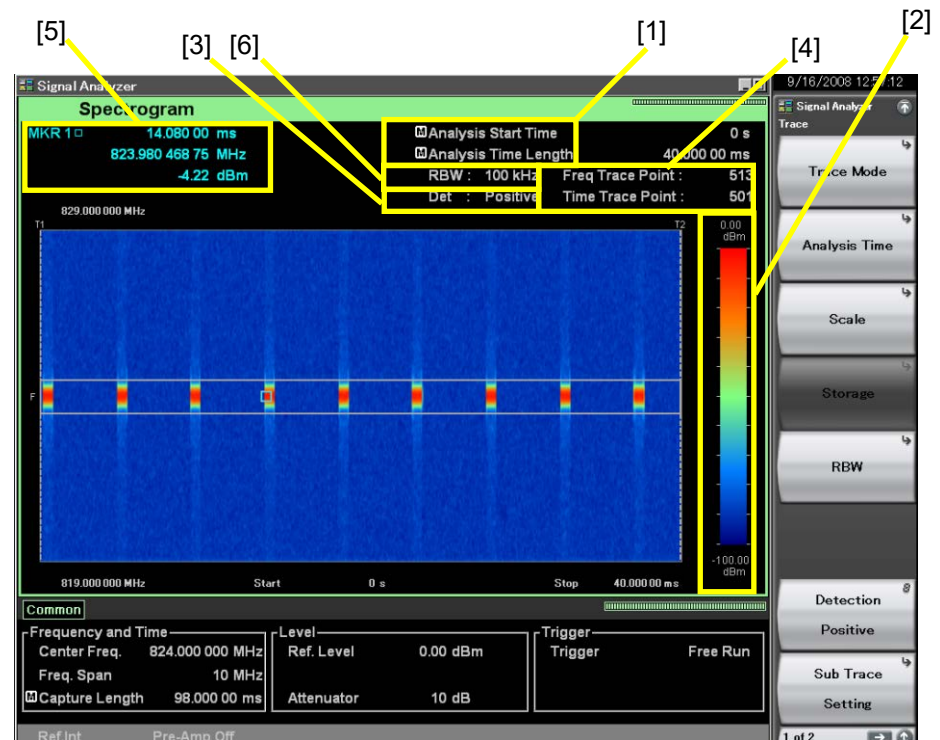

Figure 4.7.1-1 Spectrogram Trace Display Items

Table 4.7.1-1 Spectrogram Trace Display Items

No.	Display	Descriptions
[1]	Analysis Start Time /Analysis Time Length	Displays the analysis start time and the analysis time length.
[2]	Level Full Scale	Displays the scale of the level axis.
[3]	Det	Displays the detection mode.
[4]	Freq/Time Trace Point	Displays the number of the trace points on the frequency axis (vertical) and the time axis (horizontal).
[5]	MKR1/MKR2/MKR1□/MKR2□	Displays the marker time position, the marker time position, and the marker result value. When Marker Result is set to Peak, the peak point is displayed as □ on the trace.
[6]	RBW	Displays the resolution bandwidth (RBW).

4.7.2 Setting Spectrogram Parameter

Press **F6** (Trace) or press **Trace** on the main function menu of the Spectrogram trace to display Trace function menu.

Trace function menu has 2 pages. Press **→** to switch the pages.

 4.1 "Selecting Trace"

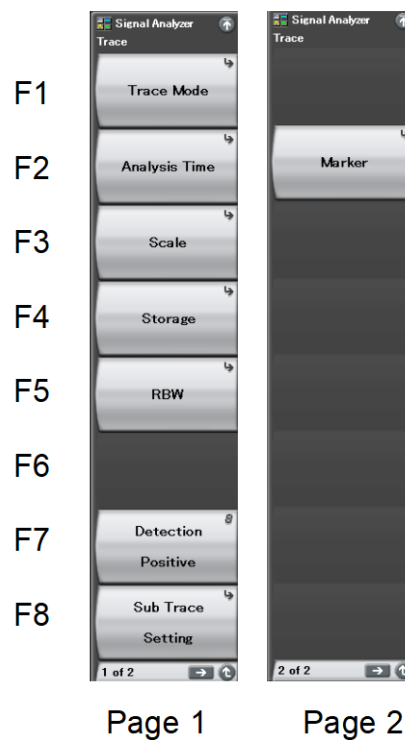









4

Trace

Figure 4.7.2-1 Trace function menu

Table 4.7.2-1 Trace function menu

Menu	Function
Trace Mode	Sets the trace mode.  4.1 “Selecting Trace”
Analysis Time	Sets the analysis time.  4.7.3 “Setting Analysis Time”
Scale	Sets the scale.  4.7.4 “Setting Scale”
Storage	Configures the setting to update and display the trace data.  4.7.6 “Setting Storage Mode”
RBW	Sets the resolution bandwidth.  4.7.5 “Setting Resolution Bandwidth (RBW)”
Detection	Sets the detection mode.  4.7.7 “Setting Detection Mode”
Sub Trace Setting	Sets the sub trace.  4.9 “Sub-Trace”
Marker	Configures the settings for Marker.  4.7.8 “Setting Marker”

4.7.3 Setting Analysis Time

Press **F2** (Analysis Time) on the Trace function menu or press **Time/Sweep** to display the Analysis Time function menu.

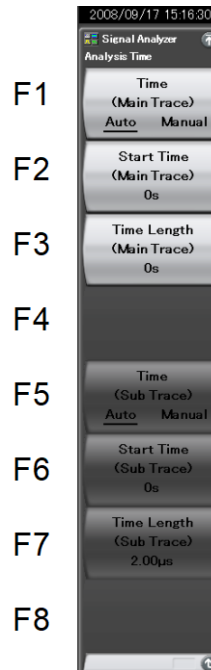

Figure 4.7.3-1 Analysis Time function menu

Table 4.7.3-1 Analysis Time function menu

Menu	Function
Time (Main Trace) (Auto/Manual)	Sets Auto/Manual for the analysis start time (Analysis Start Time) and the analysis time length (Analysis Time Length).
Start Time (Main Trace)	Sets the time at which the analysis starts.
Time Length (Main Trace)	Sets the length of the time during which the analysis is performed.
Time (Sub Trace) (Auto/Manual)	Switches between auto mode and manual mode for the analysis start time (Analysis Start Time) and analysis time length (Analysis Time Length) of a sub-trace.
Start Time (Sub Trace)	Sets the analysis start time of a sub-trace.
Time Length (Sub Trace)	Sets the analysis time length of a sub-trace.

Setting the analysis time

Analysis time is the time during which the analysis is performed. It is set by the analysis start time (Analysis Start Time) and the analysis time length (Analysis Time Length).

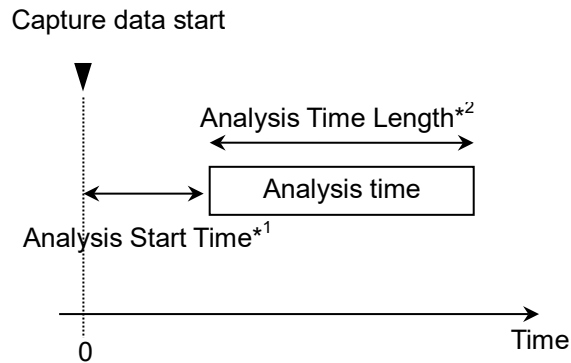

*1: Start of Analysis time based on capture data start

*2: Length of analysis time

Figure 4.7.3-2 Analysis Time

(1) Auto mode

When Capture Time is set to Auto, 100 ms is set to the analysis time length, and when set to Manual, the capture time length (Capture Time) is set to the analysis time length.

Table 4.7.3-2 Setting the analysis time in Auto mode

Capture Time	Analysis Start Time[s]	Analysis Time Length[s]
Auto	0	0.1
Manual	0	x_1

x_1 : Capture time length[s]

 2.4 "Setting IQ Data Capture Time Range"

(2) Manual mode

Manual mode allows you to set the analysis start time and the analysis time length manually. It is useful to measure a discontinuous signal such as burst.

Setting range for Analysis Start Time**Table 4.7.3-3 Setting range in Manual mode**

Capture Time	Minimum[s]	Maximum[s]
Auto	0	$x_2 - x_1$
Manual	0	$x_3 - x_1$

x_1 : Analysis time length[s]

x_2 : Maximum value of capture time length[s]

 2.4 "Setting IQ Data Capture Time Range"

x_3 : Capture time length[s]

 2.4 "Setting IQ Data Capture Time Range"

Setting range for analysis time length**Table 4.7.3-4 Setting range in Manual mode**

Capture Time	Minimum[s]	Maximum[s]
Auto	$\frac{100}{x_4}$	$x_2 - x_1$
Manual	$\frac{100}{x_4}$	$x_3 - x_1$

x_1 : Analysis Start Time[s]

x_2 : Maximum value of capture time length[s]

 2.4 "Setting IQ Data Capture Time Range"

x_3 : Capture time length[s]

 2.4 "Setting IQ Data Capture Time Range"

x_4 : Sampling rate[Hz]

 2.2.2 "Setting Frequency Span"

Note:

The maximum values may be smaller, since those are limited by the resolution of the analysis time length.

Setting resolution of Analysis Start Time

Table 4.7.3-5 Frequency Span and Setting Resolution

Frequency Span	Setting Resolution
1 kHz	0.5 ms
2.5 kHz	0.2 ms
5 kHz	0.1 ms
10 kHz	50 μs
25 kHz	20 μs
50 kHz	10 μs
100 kHz	5 μs
250 kHz	2 μs
500 kHz	1 μs
1 MHz	0.5 μs
2.5 MHz	0.2 μs
5 MHz	0.1 μs
10 MHz	50 ns
25 MHz	20 ns
31.25 MHz	20 ns
50 MHz*1	10 ns
62.5 MHz*2	10 ns
100 MHz*3	5 ns
125 MHz*3	5 ns

*1: 50 MHz can be set only when Option 004/104/077/177 is installed.









*2: 62.5 MHz can be set only when Option 077/177 is installed.

*3: 100 MHz and 125 MHz can be set only when Option 004/104/078/178 is installed.

Procedure for setting the analysis time

Example: To switch the analysis time to Manual and set the analysis start time to 20 ms and set the analysis time length to 50 ms

<Procedure>

1. Press .
2. Press  (Start Time).
3. Press   and then press  (ms) to set the analysis start time.
4. Press  (Time Length).
5. Press   and then press  (ms) to set the analysis time length.

4.7.4 Setting Scale

Scale function menu

On the main function menu, press **F6** (Trace) or press **Trace**, and then press **F3** (Scale) to display the Scale function menu.

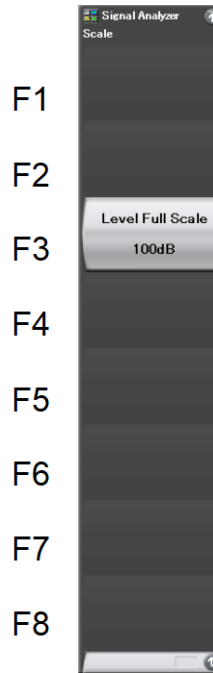

Figure 4.7.4-1 Scale function menu

Table 4.7.4-1 Scale function menu

Menu Item	Function
Level Full Scale	Sets the scale range of the level axis.

Example: To set the scale range to 10 dB

<Procedure>

1. Press **Trace**.
2. Press **F3** (Scale).
3. Press **F3** (Level Full Scale).
4. Press **1** **0** and then **Enter** to set to 10 dB scale.

Setting range of scale range:

10 to 150 dB (Resolution: 10 dB)

4.7.5 Setting Resolution Bandwidth (RBW)

On the Trace function menu, press **F5** (RBW) or press **EW** to display the RBW function menu.

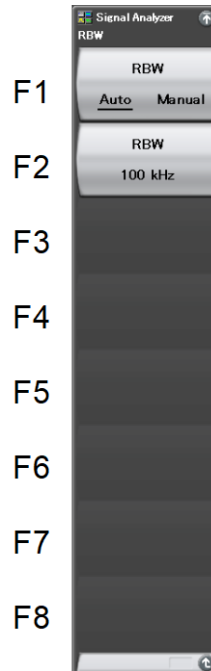

Figure 4.7.5-1 RBW function menu

Table 4.7.5-1 RBW function menu

Menu Item	Function
RBW (Auto/Manual)	Sets Auto/Manual for the resolution bandwidth (RBW).
RBW	Sets the resolution bandwidth (RBW).

The same as the resolution bandwidth of Spectrum trace is set to the resolution bandwidth of Spectrogram trace.

For details, refer to 4.2.5 “Setting resolution bandwidth (RBW)”.

4.7.6 Setting Storage Mode

Press **Trace** and then press **F4** (Storage) to display the Storage function menu.



Figure 4.7.6-1 Storage function menu

Table 4.7.6-1 Storage function menu

Menu Item	Function
Mode	Sets the mode to update and display the trace data.
Count	Sets the storage count.
Stop	Stops the storage.

Storage Mode

There are four storage modes in Spectrogram trace, as shown below:









Table 4.7.6-2 Storage Mode Type

Mode	Descriptions
Off	At each capture, the trace data are updated and displayed. These data are used for normal measurement.
Lin Average	Averages the data at each point and displays the result, each time it is captured. Used for reducing S/N.
Max Hold	At each capture, the previous and new trace data at each point are compared and the larger of the two is displayed.
Min Hold	At each capture, the previous and new trace data at each point are compared and the smaller of the two is displayed.

Setting the storage mode and the storage count

Example: To set the storage mode to Lin Average and set the storage count to 100

<Procedure>

1. Press .
2. Press  (Storage).
3. Press  (Mode) and select Lin Average.
4. Press  (Count).
5. Press    and then press  (Set) to set the storage count.

Setting range and Minimum setting resolution of storage count

- Setting range: 2 to 9999
- Minimum setting resolution: 1
- Rotary knob resolution: 1 step
- Step key resolution: 1 step at the highest 1st digit

4.7.7 Setting Detection Mode

Press **Trace** and then press **F7** (Detection) to select the detection mode.

Type of detection mode

The detection mode can be selected from three options: Average, Positive, and Negative.

Table 4.7.7-1 Detection mode within analysis range

Mode	Descriptions
Average	Traces the average point in the frequency axis and the time axis within the analysis range.
Positive	Traces the maximum point on the frequency axis and the time axis within the analysis range.
Negative	Traces the minimum point on the frequency axis and the time axis within the analysis range.

4

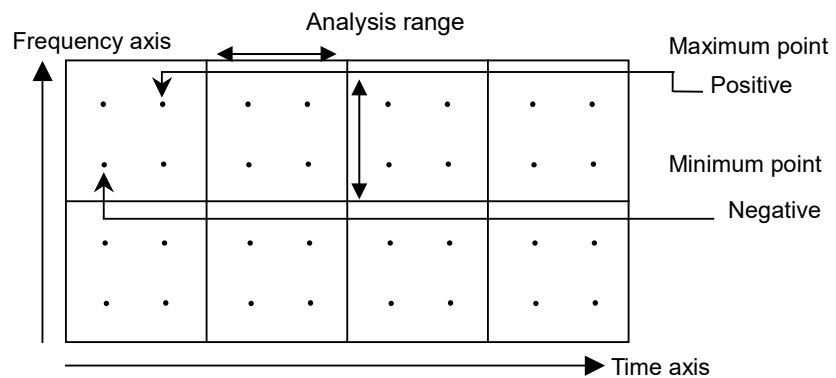

Figure 4.7.7-1 Example of Detection mode

Trace

Setting the detection mode

Example: To set the detection mode to Negative

<Procedure>

1. Press **Trace**.
2. Press **F7** (Detection) and set Negative.

4.7.8 Setting Marker

This section describes the functions to improve the measurement efficiency of the functions, such as parameter settings by a marker value.

Press **F1** (Marker) on page 2 of the Trace function menu or press **Marker** to display the Marker function menu.

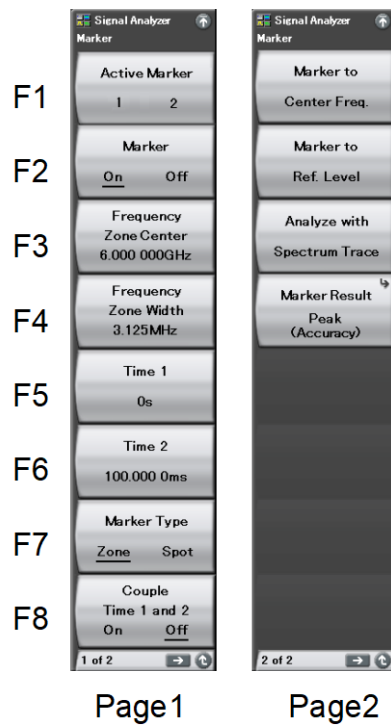

Figure 4.7.8-1 Marker function menu

Table 4.7.8-1 Marker function menu

Menu display	Function
Active Marker (1/2)	Selects the active marker. Marker (On/Off), Frequency Zone Center, Frequency Zone Width, Time1, and Time2 have their own values in both Marker 1 and 2.
Marker(On/Off)	Displays/Hides the marker set in the active marker.
Frequency Zone Center	Sets the center frequency of the active marker.
Frequency Zone Width	Sets the frequency width of the active marker. It cannot be set when Marker Type is set to Spot.
Time 1	Sets the position of Time Marker 1 of the active marker.
Time 2	Sets the position of Time Marker 2 of the active marker.
Marker Type (Zone/Spot)	Sets the marker type to Zone/Spot. When set to Spot, the spot marker is set at the peak point. When Marker Result is set to Integration or Density, the marker type is fixed to Zone.
Couple Time 1 and 2 (On/Off)	Configures the shared settings between Time and 2. When set to On, Time 1 and 2 can be moved together.
Marker to Center Freq.	Sets the marker frequency of the active marker to the center frequency in the measurement range.
Marker to Ref. Level	Sets the marker value of the active marker (When Marker Result is Density, the integral power in the band is set.).
Analyze with Spectrum Trace	Analyzes the range selected in Time 1 and 2 of the active marker on Spectrum trace.
Marker Result	Displays the Marker Result function menu. Sets the display mode of the marker values.

Marker Result function menu

Press **F1** (Marker Result) on page 2 of the Marker function menu to display the Marker Result function menu.

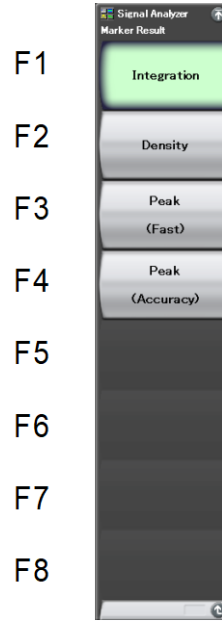

Figure 4.7.8-2 Marker Result function menu

Table 4.7.8-2 Marker Result function menu

Menu	Function
Integration	Displays the total power in the zone band.
Density	Displays the power per 1 Hz in the zone band.
Peak (Fast)	Displays the peak power in the zone quickly.
Peak (Accuracy)	Displays the peak power in the zone accurately.

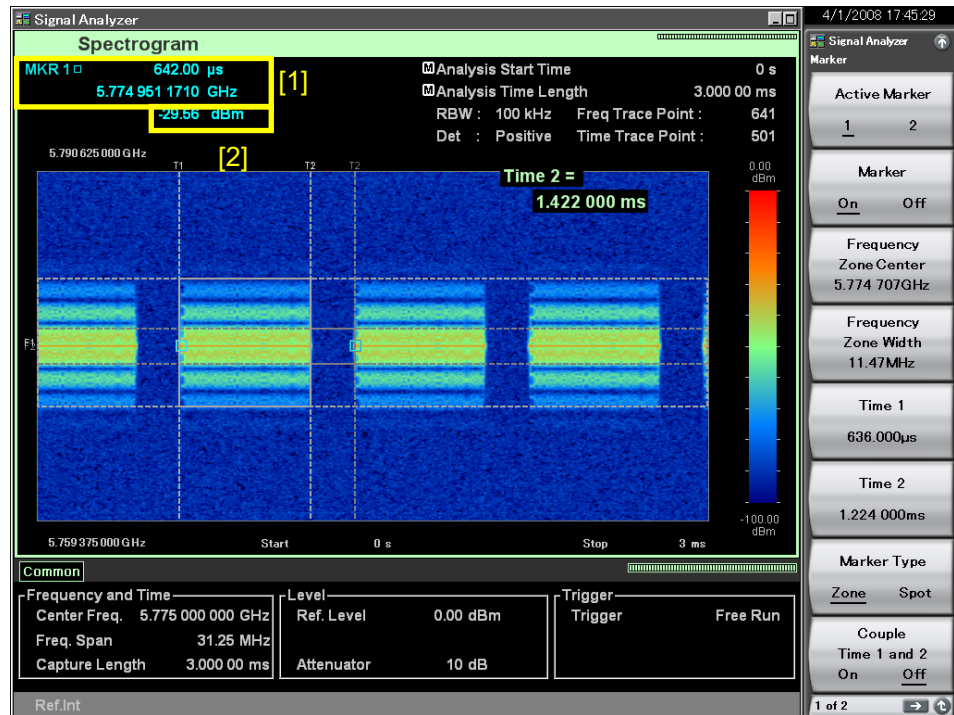

Figure 4.7.8-3 Display items of marker result

Table 4.7.8-3 Display item of marker result

No.	Display	Descriptions
[1]	MRK 1/MKR 2/MKR1□/MKR 2□	Displays the frequency and time of the active marker. When Marker Result is set to Peak, the peak point is displayed as □ on the trace. If the marker is set to active, the peak is displayed as a gray square around a light-blue square in full line. If not, the peak is displayed as a dark gray square in full line.
[2]	Marker Value	Displays the marker value displayed in the mode set in Marker Result.

4

Trace



Setting of Marker Result

The settings of Marker Result are shown below:

- Integration: Displays the total power within the zone maker band.
Density: Displays the power per 1 Hz within the zone marker width.
Peak (Fast): Displays the peak power within the zone marker width quickly.
Peak (Accuracy): Displays the peak power within the zone marker accurately.

Example: To set Marker Result

<Procedure>

1. Press .
2. Press  (Marker Result) on page 2 of the Marker function menu and select any of Integration, Density, Peak (Fast), and Peak (Accuracy).

Changing the marker position and width

On Figure 4.7.8-4 below, the frequency markers are displayed as F on the vertical (frequency) axis, and the time markers are displayed as T on the horizontal (time) axis. When Marker Type is set to Zone, the time markers (T1 and T2) are displayed. You can set the position and width of the frequency and time markers on the Marker function menu.

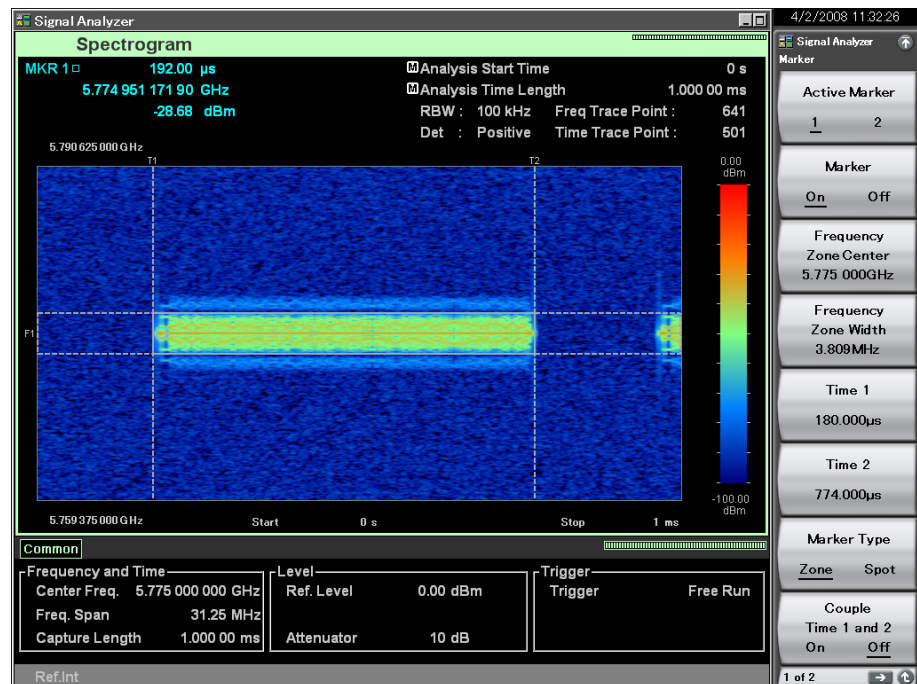

Figure 4.7.8-4 Setting Marker

(1) Changing the position of the frequency marker

Example: To set the position to 5 GHz and set the width to 1 MHz

<Procedure>







1. Press **Marker**.
2. On the Marker main function menu, press **5** and then press **F1** (GHz) to set the center frequency of the frequency marker.
3. On the Marker main function menu, press **F4** (Frequency Zone Width).
4. Press **1** and then press **F2** (MHz) to set the zone width.

The positions and widths of the other markers can be set in the same way.

(2) Changing the position of the time marker

Example: To set the position of the time marker 1 to 0.6 ms

<Procedure>



1. Press .
2. Press  (Time 1) on the Marker main function menu.
3. Press    and then press  (ms) to set the position of the time marker.

(3) Selecting the active marker

The position of the active marker can be set by the rotary knob and step key.

Example: To set the active marker

<Procedure>

1. Press .
2. Press  (Active Marker) to switch to the marker number which you would like to select.

(4) Selecting Marker Type

The marker type can be set to Zone/Spot. Only when Marker Result is Peak (Fast) or Peak (Accuracy), it can be set to Spot.

Example: To set Marker Type to Zone

<Procedure>

1. Press .
2. Press  (Marker Type) to set to Zone.

(5) Selecting Couple Time 1 and 2

Turns On/Off the shared settings of the time markers. When set to On, the time marker 1 and 2 can be moved together.

Example: To set Couple Time 1 and 2 to On

<Procedure>



1. Press .
2. Press  (Couple Time 1 and 2) to set to On.

(6) Executing Marker to Center Freq.

Sets the marker frequency to the center frequency (Center Frequency).

Example: To detect the peak power within the measurement bandwidth and set it to the center frequency

<Procedure>



1. Press .
2. Press  (Marker to Center Freq.) on page 2 of the Marker function menu.

(7) Executing Marker to Ref. Level

Sets the active marker value (the integral power within the band when Marker Result is set to Density) to the reference level.

Example: To detect the position of the peak power within the measurement band to set it the reference level

<Procedure>





1. Press .
2. Press  (Marker to Ref. Level) on page 2 of the Marker function menu.

(8) Executing Analyze with Spectrum Trace

Analyzes the range selected by time markers 1 and 2 of the active marker using Spectrum trace. After execution, Trace Mode changes to Spectrum.

Example: To analyze the range selected by time markers 1 and 2 of the Spectrum Trace using Spectrum Trace

<Procedure>

1. Press  (Trace) on the main function menu.
2. Press  (Trace Mode).
3. Press  (Spectrogram).
4. Press .
5. Press  (Analyze with Spectrum Trace) on page 2 of the Marker function page.

After executed, the parameters on Spectrum trace are set to the setting values, as Table 4.7.8-4 shows:

Table 4.7.8-4 Parameter values set after executing Analyze with Spectrum Trace

Parameter on Spectrum trace	Setting Value
RBW Auto/Manual	RBW Auto/Manual on Spectrogram trace
RBW	RBW on Spectrogram trace
Zone Width Type of Marker 1	Marker Type on Spectrogram trace
Marker Result	Marker Result on Spectrogram trace
Time Detection	Detection on Spectrogram trace
Analysis Start Time	Smaller value set in Time 1 and 2 on Spectrogram trace
Analysis Time Length	Absolute value of the difference between Time 1 and 2 on Spectrogram trace
Storage Mode	Storage Mode on Spectrogram trace
Storage Count	Storage Count on Spectrogram trace
Zone Center of Marker 1	Zone Center on Spectrogram trace
Zone Width of Marker 1	Zone Width on Spectrogram trace
Marker Mode of Marker 1	Normal
Analysis Time Auto/Manual	Manual

4.8 No Trace

4.8.1 What is No Trace?

No Trace mode does not execute signal analysis. Therefore, “IQ data output” and “IQ data readout using remote commands” can be executed quickly without the need to wait for completion of analysis. As analysis is not executed, Save Waveform function for saving waveform data cannot be used. For details of Save Waveform functions, refer to “3.6.1 Saving parameters and waveform data” in the *“MS2690A/MS2691A/MS2692A Signal Analyzer Operation Manual (Mainframe Operation).”*

The display items for No Trace are described below.

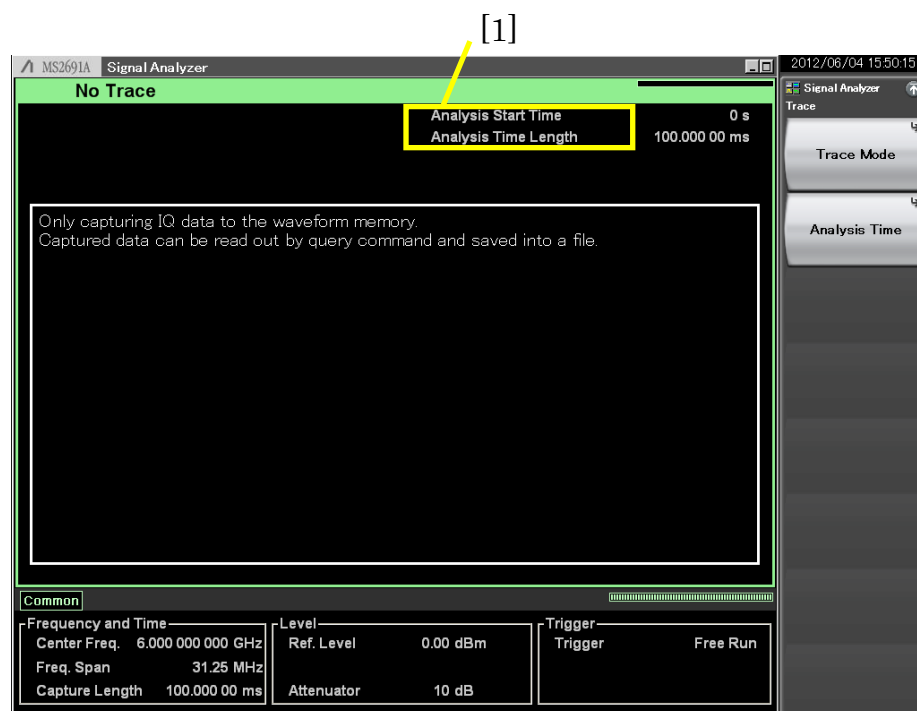

Figure 4.8.1-1 No Trace mode Display Items

Table 4.8.1-1 No Trace mode Display Items

No.	Display	Descriptions
[1]	Analysis Start Time /Analysis Time Length	Displays the analysis start time and the analysis time length.

4.8.2 Setting No Trace parameters

Press **F6** (Trace) or press **Trace** on the main function menu of the No Trace to display Trace function menu.

 4.1 "Selecting Trace"

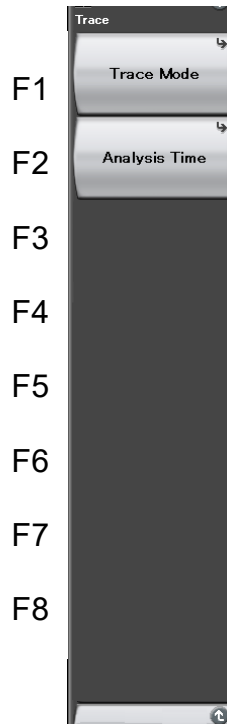



Figure 4.8.2-1 Trace function menu

Table 4.8.2-1 Trace function menu

Menu	Function
Trace Mode	Sets the trace mode.  4.1 "Selecting Trace"
Analysis Time	Sets the analysis time.  4.8.3 "Setting Analysis Time"

4.8.3 Setting Analysis Time



Press  (Analysis Time) on the Trace function menu or press  to display the Analysis Time function menu.

Table 4.8.3-1 Analysis Time function menu

Function key	Menu	Function
F1	Time (Main Trace) (Auto/Manual)	Sets Auto/Manual for the analysis start time (Analysis Start Time) and the analysis time length (Analysis Time Length).
F2	Start Time (Main Trace)	Sets the time at which the analysis starts.
F3	Time Length (Main Trace)	Sets the length of the time during which the analysis is performed.

Setting the analysis time

Analysis time is the time during which the analysis is performed. If No Trace is selected as the Trace mode, then analysis is not executed. Analysis time setting may, however, be required in outputting IQ data. It is set by the analysis start time (Analysis Start Time) and the analysis time length (Analysis Time Length).

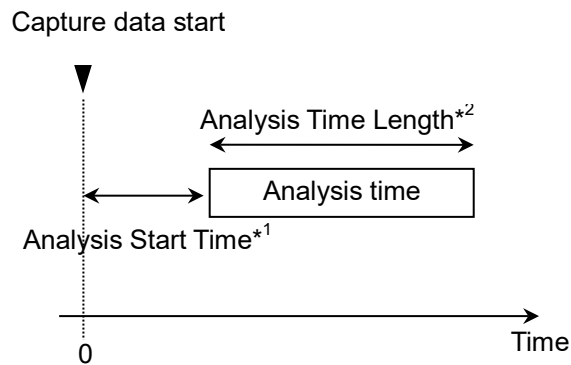

*1: Start of Analysis time based on capture data start
 *2: Length of analysis time

Figure 4.8.3-1 Analysis Time

(1) Auto mode

When Capture Time is set to Auto, 100 ms is set to the analysis time length, and when set to Manual, the capture time length (Capture Time) is set to the analysis time length.

Table 4.8.3-2 Setting the analysis time in Auto mode

Capture Time	Analysis Start Time[s]	Analysis Time Length[s]
Auto	0	0.1
Manual	0	x_1

x_1 : Capture time length[s]

 2.4 “Setting IQ Data Capture Time Range”

(2) Manual mode

Manual mode allows you to set the analysis start time and the analysis time length manually.

Setting range for Analysis Start Time**Table 4.8.3-3 Setting range in Manual mode**

Capture Time	Minimum[s]	Maximum[s]
Auto	0	$x_2 - x_1$
Manual	0	$x_3 - x_1$

x_1 : Analysis time length[s]

x_2 : Maximum value of capture time length[s]

 2.4 "Setting IQ Data Capture Time Range"

x_3 : Capture time length[s]

 2.4 "Setting IQ Data Capture Time Range"

4

Trace

Setting range for analysis time length**Table 4.8.3-4 Setting range in Manual mode**

Capture Time	Minimum[s]	Maximum[s]
Auto	$\frac{1}{x_4}$	$x_2 - x_1$
Manual	$\frac{1}{x_4}$	$x_3 - x_1$

x_1 : Analysis Start Time[s]

x_2 : Maximum value of capture time length[s]

 2.4 "Setting IQ Data Capture Time Range"

x_3 : Capture time length[s]

 2.4 "Setting IQ Data Capture Time Range"

x_4 : Sampling rate[Hz]

 2.2.2 "Setting Frequency Span"

Note:

The maximum value may be less than this value due to the restrictions imposed by the trace point.

Setting resolution of Analysis Start Time

Table 4.8.3-5 Frequency Span and Setting Resolution

Frequency Span	Setting Resolution
1 kHz	0.5 ms
2.5 kHz	0.2 ms
5 kHz	0.1 ms
10 kHz	50 μs
25 kHz	20 μs
50 kHz	10 μs
100 kHz	5 μs
250 kHz	2 μs
500 kHz	1 μs
1 MHz	0.5 μs
2.5 MHz	0.2 μs
5 MHz	0.1 μs
10 MHz	50 ns
25 MHz	20 ns
31.25 MHz	20 ns
50 MHz*1	10 ns
62.5 MHz*2	10 ns
100 MHz*3	5 ns
125 MHz*3	5 ns

*1: 50 MHz can be set only when Option 004/104/077/177 is installed.









*2: 62.5 MHz can be set only when Option 077/177 is installed.

*3: 100 MHz and 125 MHz can be set only when Option 004/104/078/178 is installed.

Procedure for setting the analysis time

Example: To switch the analysis time to Manual and set the analysis start time to 20 ns and set the time length to 2 μs

<Procedure>

1. Press .
2. Press  (Start Time).
3. Press   and then press  (ns) to set the analysis start time.
4. Press  (Time Length).
5. Press  and then press  (μs) to set the analysis time length.

4.9 Sub-Trace

4.9.1 What is Sub Trace?

A sub-trace can be displayed as an aid to the normal trace (main trace). Select either Power vs Time or Spectrogram as the sub-trace to display the trace data for any time range. Displaying the sub-trace allows the analysis range of the main trace to be confirmed and set while checking on two screens.

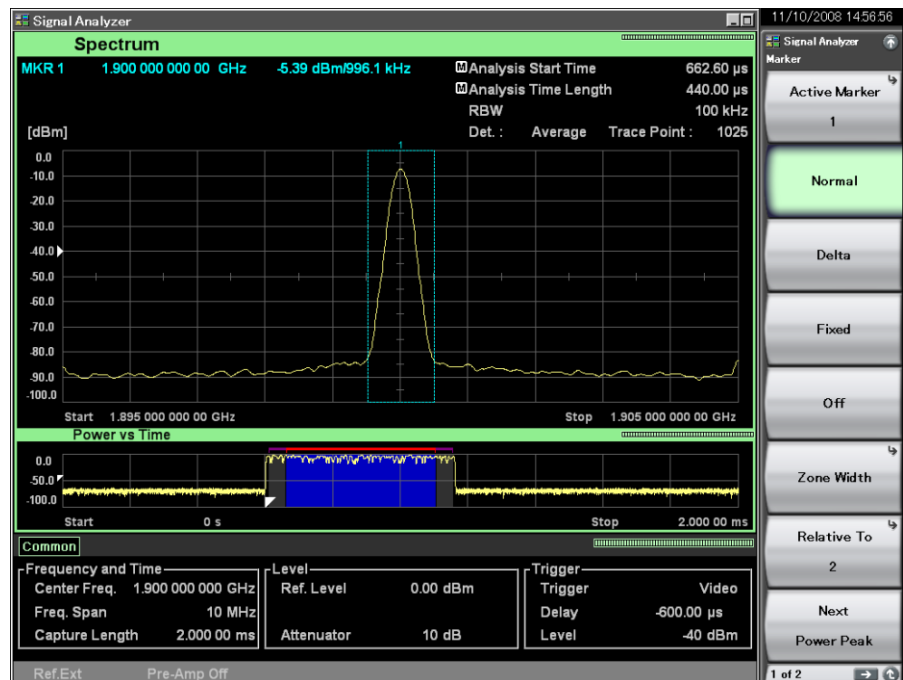

Figure 4.9.1-1 Sub Trace

4.9.2 Setting parameters for Sub Trace

Pressing **F5** (Trace) on the main function menu or pressing **Trace** displays the Trace function menu. Pressing **F8** (Sub Trace Setting) on the Trace function menu displays the Sub Trace Setting function menu. This section describes how to set parameters for a sub-trace.

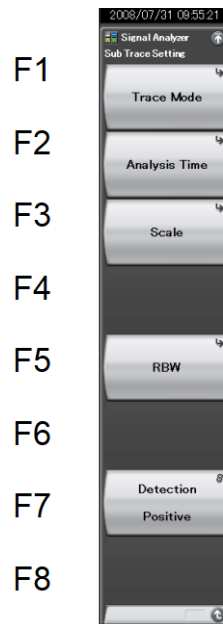







Figure 4.9.2-1 Sub Trace Setting function menu

Table 4.9.2-1 Sub Trace Setting function menu

Menu Display	Function
Trace Mode	Sets the sub-trace type.  4.9.3 "Selecting Sub Trace"
Analysis Time	Used for setting related to the analysis time.  4.9.4 "Setting analysis time"
Scale	Used for setting related to the scale.  4.9.5 "Setting scale"
RBW	Used for setting related to RBW. This menu display is not displayed if a sub-trace is not set to Spectrogram.  4.9.6 "Setting resolution bandwidth (RBW)"
Detection	Used for setting related to detection.  4.9.7 "Setting detection mode"

4.9.3 Selecting Sub Trace

Pressing **F1** (Trace Mode) on the Sub Trace Setting function menu displays the Trace Mode function menu. This section describes how to set sub-trace types.

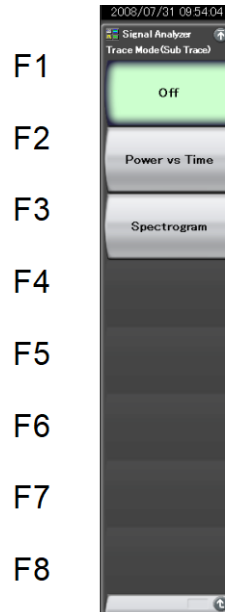

Figure 4.9.3-1 Trace Mode function menu

Table 4.9.3-1 Trace Mode function menu

Menu Display	Function
Off	Does not display a sub-trace.
Power vs Time	Sets the sub-trace to Power vs Time.
Spectrogram	Sets the sub-trace to Spectrogram. However, this setting is disabled when Scale Mode is set to Lin.

4.9.4 Setting analysis time

Pressing **F2** (Analysis Time) on the Sub Trace Setting function menu displays the Analysis Time function menu. This section describes how to set the analysis time for a sub-trace. When the sub-trace is set to Power vs Time or Spectrogram, you can set the analysis time of the sub-trace.

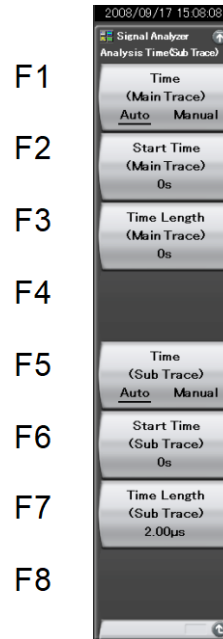

Figure 4.9.4-1 Analysis Time function menu

Table 4.9.4-1 Analysis Time function menu

Menu Display	Function
Time (Main Trace) (Auto/Manual)	Switches between auto mode and manual mode for the analysis start time (Analysis Start Time) and the analysis time length (Analysis Time Length).
Start Time (Main Trace)	Sets the analysis start time.
Time Length (Main Trace)	Sets the analysis time length.
Time (Sub Trace) (Auto/Manual)	Switches between auto mode and manual mode for the analysis start time (Analysis Start Time) and analysis time length (Analysis Time Length) of a sub-trace.
Start Time (Sub Trace)	Sets the analysis start time of a sub-trace.
Time Length (Sub Trace)	Sets the analysis time length of a sub-trace.

When both Analysis Time and Capture Time are set to Auto, the analysis start time and the analysis time length are the same as those of the main trace.

When Capture Time is set to Manual and when Analysis Time is set to Auto, the analysis start time is set to the minimum value and the time length is set to the maximum value.

The setting ranges and resolutions of the analysis start time and the analysis time length are the same as those of the main trace.

Setting analysis time

The Analysis Start Time and Analysis Time Length of the main trace are highlighted within the sub-trace for easier viewing.

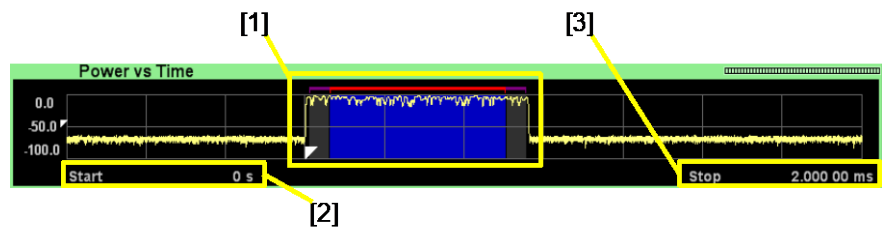



Figure 4.9.4-2 Analysis time display in Sub-trace

Table 4.9.4-2 Display items for sub-trace

No.	Descriptions
[1]	<p>Displays the analysis time. The analysis time length is indicated by a red line for emphasis. In addition, if the main trace is a spectrum, the range of IQ data captured to be used for FFT is indicated by a purple line outside of this red line. See Appendix D “FFT and RBW” for relationships between the analysis time and the captured data.</p> <p> Appendix D “FFT&RBW”</p> <p>When measuring a burst signal, you might want to display a spectrum with the rising and falling of the signal hidden. To display such a spectrum, set the analysis time so that the purple line of the IQ data range does not reach the rising and falling of the signal.</p>
[2]	Displays analysis start time.
[3]	Displays analysis end time.

Note:

This highlight displays the same when sub-trace is set to Spectrogram.

4.9.5 Setting scale

Pressing **F3** (Scale) on the Sub Trace Setting function menu displays the Scale function menu. This section describes how to set the scale range for a sub-trace.

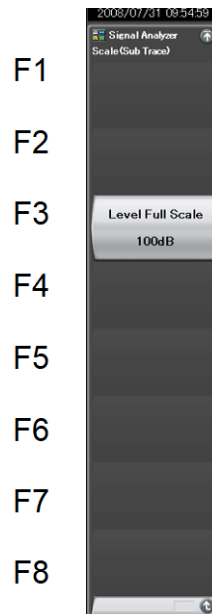

Figure 4.9.5-1 Scale function menu

Table 4.9.5-1 Scale function menu

Menu Display	Function
Level Full Scale	Sets the scale range of the level axis. The Level Full Scale setting value applies to the entire level axis. For instance, when Level Full Scale is set to 100 dB, trace data can be displayed within the range of 100 dB.

Example: To set the scale range to 10 dB

<Procedure>

1. Press **Trace**.
2. Press **F8** (Sub Trace Setting) to open the Sub Trace Setting function menu.
3. Press **F3** (Scale).
4. Press **F3** (Level Full Scale).
5. Press **1** **0**, and then press **Enter** to set to 10 dB scale.

Table 4.9.5-2 Setting Range

Scale	Setting range
Log Scale	10, 20, 50, 100, 150 dB
Lin Scale	10, 20, 50, 100 %

4.9.6 Setting resolution bandwidth (RBW)

Pressing **F5** (RBW) on the Sub Trace Setting function menu displays the RBW (Sub Trace) function menu. This setting is enabled only when the sub-trace is set to Spectrogram.

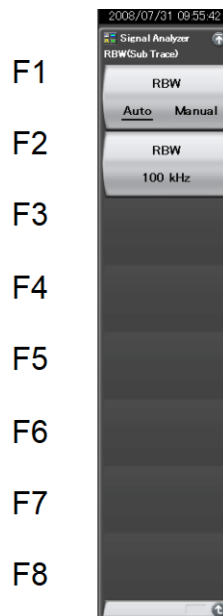

Figure 4.9.6-1 RBW function menu

Table 4.9.6-1 RBW function menu

Menu Display	Function
RBW (Auto/Manual)	Switches between auto mode and manual mode for the resolution bandwidth.
RBW	Sets the resolution bandwidth.

The setting range and the resolution for the resolution bandwidth in a sub-trace are set to the same values as when Marker Result is set to Integration on Spectrum trace.

For details, refer to 4.2.5 “Setting resolution bandwidth (RBW)”.

4.9.7 Setting detection mode

Pressing **F7** (Detection) on the Sub Trace Setting function menu displays the Detection function menu. This section describes the detection mode of a sub-trace.

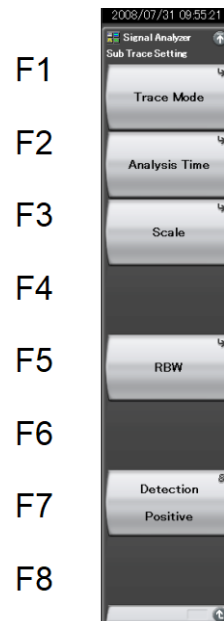

Figure 4.9.7-1 Sub Trace Setting function menu

Table 4.9.7-1 Detection modes in analysis range

Detection mode	Descriptions
Average	Traces the average value within the analysis range.
Positive	Traces the maximum value within the analysis range. The peak value of a signal near the noise level is measured in Positive mode.
Negative	Traces the minimum value within the analysis range. Negative is used to measure the lower envelope of the modulation waveform.
Pos & Neg	Displays the line connecting the maximum and minimum values of the sampling points within the analysis range. Used for normal measurement.

For details of the detection mode when a sub-trace is set to Power vs Time or when it is set to Spectrogram, refer to 4.3.8 “Setting detection mode” or 4.7.7 “Setting Detection Mode”, respectively.

Chapter 5 Digitize Function

This chapter describes how to save IQ data to external memory and data file formats and how to replay the saved IQ data.

5.1	Saving IQ Data.....	5-2
5.1.1	Format of data information file.....	5-7
5.1.2	Format of data file.....	5-9
5.2	Replay Function.....	5-10
5.2.1	Starting Replay function	5-11
5.2.2	Display During Replay Function Execution	5-13
5.2.3	Restrictions During Replay Function Execution.....	5-13
5.2.4	Condition of IQ Data File for Replay.....	5-15
5.2.5	Stopping Replay function	5-17
5.3	Playback Function	5-18
5.3.1	Starting Playback function.....	5-21
5.3.2	Display During Playback Function Execution.	5-22
5.3.3	Aborting Playback function.....	24

5.1 Saving IQ Data

Pressing **F7** (Capture) from the main function menu and then pressing **F3** (Save Captured Data) displays the Save Captured Data function menu.

Note:

IQ data should be saved or digitized after a single sweeping has been executed and ended, even when trigger function is used.

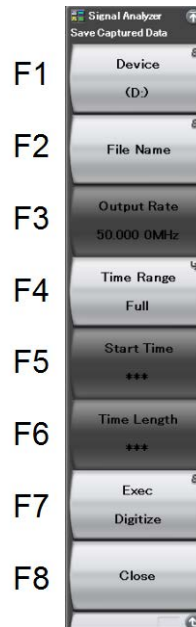

Figure 5.1-1 Save Captured Data function menu

Table 5.1-1 Save Captured Data

Menu Display	Function
Device	Selects the location of the file to be saved.
File Name	Sets the name of the file to be saved.
Output Rate	Sets the rate of the output data. The rate of the output data is fixed to the sampling rate in waveform capture when Capture Time is set to Auto. Changes the rate of the output data when Capture Time is set to Manual.
Time Range	Sets the specification method of the time range for the IQ data to be saved.





Table 5.1-1 Save Captured Data (Cont'd)

Menu Display	Function
Start Time	<p>Sets the start time of the IQ data to be saved when Time Range is set to Manual.</p> <p>Full: Saves all IQ data that are obtained. Parts of IQ data that are obtained for calculation and are not displayed on the trace data are also saved. Select this to analyze the same range in the Replay function.</p> <p>Analysis Time: Saves the IQ data for the range specified by Analysis Start Time and Analysis Time Length. Select this to save IQ data for the range displayed as trace data.</p> <p>Manual: Saves the IQ data for the range specified by Start Time and Time Length of Save Captured Data.</p>
Time Length	Sets the time length of the IQ data to be saved when Time Range is set to Manual.
Exec Digitize	Executes saving.
Close	Closes the Save Captured Data function menu.

The IQ data stored in the internal memory at the time of execution of this function is saved to the external memory.

Example: To save IQ data

<Procedure>

1. Press  (Capture) from the main function menu.
2. Press  (Save Captured Data).
3. Press  (Device) from the Save Captured Data function menu, and then select the destination drive.
4. Press  (File Name) to specify the file name.
5. Press  (Exec Digitize) to save.

Saving Files

When save processing is executed, the following files are created.

- “[File Name].dgz” Data file (binary format)
- “[File Name].xml” Data information file (XML format)

The IQ data row is saved to the data file. The information on the saved data is saved to the data information file.

Automatically named as “Digitize date sequential number” when omitted. A 2-digit sequential number from 0 to 999 is added to the file name.

Files are saved in the following directory of the saving target drive specified by  (Device).

\Anritsu Corporation\Signal Analyzer\User Data\Digitized
Data\Signal Analyzer

Up to 1000 files can be saved in the folder.

The rate of the output data when Capture Time is set to Manual can be changed.

The setting range of the output data rate and the resolution change according to the frequency span are as shown in Table 5.1-2.

Table 5.1-2 Frequency span and setting resolution/setting range

Frequency span	Setting resolution	Minimum	Maximum
1 kHz	1 Hz	1 kHz	2 kHz
2.5 kHz	1 Hz	2 kHz	5 kHz
5 kHz	1 Hz	5 kHz	10 kHz
10 kHz	1 Hz	10 kHz	20 kHz
25 kHz	1 Hz	20 kHz	50 kHz
50 kHz	1 Hz	50 kHz	100 kHz
100 kHz	1 Hz	100 kHz	200 kHz
250 kHz	1 Hz	200 kHz	500 kHz
500 kHz	10 Hz	500 kHz	1 MHz
1 MHz	10 Hz	1 MHz	2 MHz
2.5 MHz	10 Hz	2 MHz	5 MHz
5 MHz	100 Hz	5 MHz	10 MHz
10 MHz	100 Hz	10 MHz	20 MHz
25 MHz	100 Hz	20 MHz	50 MHz
31.25 MHz	100 Hz	20 MHz	50 MHz
50 MHz* ¹	1 kHz	50 MHz	100 MHz
62.5 MHz* ²	1 kHz	50 MHz	100 MHz
100 MHz* ³	1 kHz	100 MHz	200 MHz
125 MHz* ³	1 kHz	100 MHz	200 MHz























*1: 50 MHz can be set only when Option 004/104/077/177 is installed.

*2: 62.5 MHz can be set only when Option 077/177 is installed.

*3: 100 MHz and 125 MHz can be set only when Option 004/104/078/178 is installed.

Example: To save W-CDMA signal (Chip Rate: 3.84 MHz) for 10 ms with an oversampling rate of 15.36 MHz, which is four times of the chip rate.

<Procedure>

1. Press .
2. Press  , and then press  (MHz) to set the frequency span to 10 MHz.
3. Press .
4. Press  (Capture).
5. Press  , and then press  (ms) to set the capture length to 10 ms.
6. Press  (Save Captured Data).
7. Press  (Time Range) and then press  (Analysis Time).
8. Press .
9. Press  (Output Rate).
10. Press      and then press  (MHz) to set the output rate to 15.36 MHz.
11. Press .
12. Press  (Exec Digitize) to save the IQ data.

5.1.1 Format of data information file

The information on the saved IQ data is recorded in the data information file. Table 5.1.1-1 shows the details of the recorded parameters.

Table 5.1.1-1 Format of data information file

Item	Description
CaptureDate	Year/Month/Day of the captured data in the “DD/MM/YYYY” format.
CaptureTime	Data capture time in the “HH/MM/SS” format.
FileName	Data file name
Format	Data format, fixed to “Float”
CaptureSample	Number of samples of the recorded data [Sample]
Condition	Error status of the recorded data. “Normal”: Normal “OverLoad”: Level Over
TriggerPosition	Trigger occurrence position [Sample] Start point of the recorded data is 0.
CenterFrequency	Center frequency [Hz]
SpanFrequency	Frequency span [Hz]
SamplingClock	Sampling rate [Hz]
PreselectorBandMode	Frequency band switch mode. “Normal”: Normal mode “Spurious”: Spurious mode  2.2.6 “Setting frequency band”
ReferenceLevel	Reference level [dBm] Note that this value does not include the reference level offset.
AttenuatorLevel	Attenuator value [dB]
InternalGain	Internal gain value [dB] This is an internal parameter.
PreAmp	6 GHz Preamplifier gain value [dB]
IQReverse	IQ reverse setting, fixed to “Normal”
TriggerSwitch	Trigger On/Off. “FreeRun”: Trigger is not used “Triggered”: Trigger is used

Table 5.1.1-1 Format of data information file (Cont'd)

Item	Description
TriggerSource	Trigger source “Video”: Video trigger “WideIF”: Wide IF video trigger “External”: External trigger “SGMarker”: SG marker trigger
TriggerLevel	Trigger level [dBm] Note that this value does not include the reference level offset. It is in dBm units, even if the scale mode is Lin.
TriggerDelay	Trigger delay time [s] It is the relative time from the trigger input position to the start point of the recorded data.
IQReference0dBm	Reference IQ amplitude value indicating 0 dBm, fixed to “1”.
ExternalReferenceDisp	Reference signal information “Ref.Int”: Internal reference signal “Ref.Ext”: External reference signal “Ref.Int Unlock”: Internal reference signal is unlocked “Ref.Ext Unlock”: External reference signal is unlocked
Correction Factor	Corrected value [dB] calculated by Correction. The Correction Factor value is added to the IQ data of the data file. 0.000 is automatically set when Correction is Off.
Terminal	Signal Input “RF” :RF terminal “DigRF 3G”:DigRF 3G terminal
ReferencePosition	0-second reference position Indicates the 0-second reference position using the digitized data point position. During Replay function execution, the ReferencePosition position is displayed as 0 s.
Trigger Slope	Selects the edge where the trigger is generated (rise or fall). “Rise”: rising edge “Fall”: falling edge

5.1.2 Format of data file

The data file is created in binary format. From the beginning of the file, I-phase data and Q-phase data are recorded by 4 bytes. The I-phase data and Q-phase data are recorded as a float type (IEEE real*4).

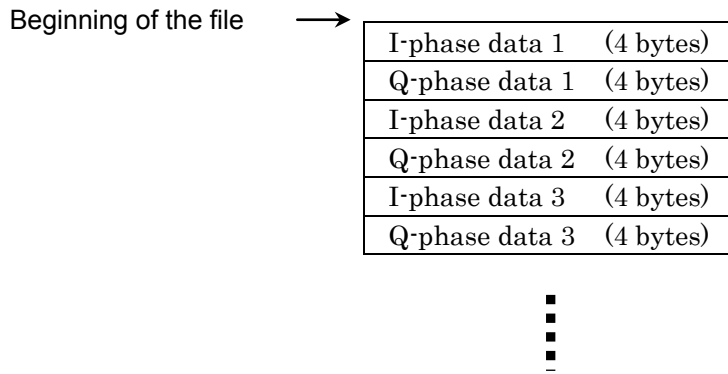

Figure 5.1.2-1 Format of data file

IQ data can be converted to power based on the following formula:

$$P = 10 \log_{10}(I^2 + Q^2)$$

where

P: Power [dBm]

I: I-phase data

Q: Q-phase data

5.2 Replay Function

The Replay function allows you to replay the saved IQ data. Pressing **F7** (Capture) on the main function menu and then **F4** (Replay) displays the Replay function menu.

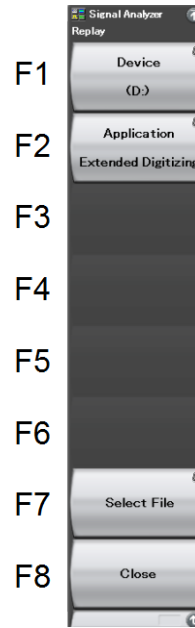

Figure 5.2-1 Replay function menu

Table 5.2-1 Description of Replay function menu





Menu Display	Function
Device	Selects the drive of the target file.
Application	Selects the application used for saving the target file.
Select File	Selects the target file. After the file has been selected, the Replay function is executed.
Close	Closes the Replay function menu.

5.2.1 Starting Replay function

Start the Replay function using the following procedure.

Example: To start the Replay function

<Procedure>

1. Press  (Capture) on the main function menu.
2. Press  (Replay) on the Capture function menu.
3. Press  (Device) on the Replay function menu to select the drive in which the target file is stored.
4. Press  (Application) to select the application used for saving the target file.
5. Press  (Select File) to display the file selection dialog. After the target file has been selected, the Replay function starts and then **Replaying** appears on the screen.

The Replay function can be executed for an IQ data file saved in the following applications:

- Signal Analyzer function *1
- Extended Digitizing Software *1,*2

*1 The Replay function cannot be executed for an IQ data file saved after the output rate has been changed. In that case, an error message “Unsupported SpanFrequency” appears.

*2 Regarding an IQ data file whose span is 18.6 MHz or 20 MHz, the span is displayed as 25 MHz.









Reanalysis of Digitized File

When the target IQ data is saved with Save Captured Data of this application, it can be analyzed in the same range as the analysis range when the data was saved, by setting the Capture Time to Manual.

Note:

IQ data files that have been saved with the previous version cannot be analyzed in the same range as the analysis range when they were saved.

<Procedure>

1. Press  (Capture) on the main function menu.
2. Set  (Capture Time) to Manual on the Capture function menu.
3. Press  (Save Captured Data).
4. Press  (Device) on the Save Captured Data function menu to select the drive in which to save the IQ data.
5. Press  (File Name) to set the target file.
6. Select Full in  (Time Range).
7. Press .
8. Press  (Exec Digitize) to save the IQ data.

The Replay function cannot be executed if the data length of the IQ data file is less than the specified length.

5.2.2 Display During Replay Function Execution

Replay Error Info. appears if the IQ data file meets the following conditions:

- Frequency reference is Unlocked when IQ data is saved
- Level Over occurs when IQ data is saved

5.2.3 Restrictions During Replay Function Execution

Since the signals to be analyzed are fixed during replay, the following functions are restricted.

Table 5.2.3-1 Functions Restricted During Replay

Function
Center Frequency
Start Frequency
Stop Frequency
Span Frequency
Frequency Band Mode
Attenuator
Attenuator Auto/Manual
Pre Amp
Trigger Switch
Trigger Source
Trigger Slope
Trigger Delay
Video Trigger Level
Wide IF Trigger Level
Continuous Measurement
Single Measurement
Capture Time Auto/Manual
Capture Time Length
Marker to Center Frequency
Storage Mode
Storage Count
Storage Stop
Reset Result Every Capture
Noise Cancel
Adjust Reference Clock
Adjust Reference Clock Preset
Pre-selector Auto Tune
Pre-selector Tune

Table 5.2.3-1 Functions Restricted During Replay (Cont'd)

Function
Erase Warm Up Message
Terminal Change
Target System
AD Full Range
I/Q Sign
Measurement Channel
Capture Sample Length
Analysis Start Sample
Analysis Sample Length
Input Source
Vertical Scale Center
Smoothing Sample Length
Marker Unit

Also, during replay, the reference level setting range is as follows, regardless of the attenuator and preamplifier.

Table 5.2.3-2 Reference level range with Replay function on

Scale mode	Unit	Reference Level Range
Log scale	dBm	-120 to +50 dBm
	dB μ V	-13.01 to +156.99 dB μ V
	dBmV	-73.01 to +96.99 dBmV
	V	0.224 μ V to 70.7 V
	W	1 fW to 100 W
	dB μ V (emf)	-6.99 to +163.01 dB μ V (emf)
	dB μ V/m	-13.01 to +156.99 dB μ V/m
Linear Scale (in dBm)	V	22.4 μ V to 70.7 V (-80 to +50 dBm)

dBm: Unit system where 1 mW/50 Ω is regarded as 0 dBm

dB μ V: Unit system where 1 μ V is regarded as 0 dB μ V. Indicated by termination voltage with 50 Ω terminator.

dBmV: Unit system where 1 mV is regarded as 0 dBmV. Indicated by termination voltage with 50 Ω terminator.

dB μ V (emf): Unit system in dB μ V, indicated by open voltage. The value is "dB μ V + 6 dB".

dB μ V/m: Unit system indicating electric field intensity. The value is the same as the dB μ V unit system.

Since data range is reserved during replay for the range required for calculation to execute replay, the actual range for which analysis can be executed is narrower than the range of the IQ data file.

The analysis range is set by using either of the following remote commands:

```
:MMEMory:LOAD:IQData:INformation?
```

or

```
:MMEMory:LOAD:IQData:INformation:LENGth?.
```

5.2.4 Condition of IQ Data File for Replay

The condition of IQ data files for which replay analysis is possible is as follows.

Format of waveform data file: I, Q (Binary format)

Table 5.2.4-1 lists the combinations of frequency span and sampling rate for which analysis is possible.

Table 5.2.4-1 Frequency Span and Sampling Rate

Frequency Span	Sampling Rate
1 kHz	2 kHz
2.5 kHz	5 kHz
5 kHz	10 kHz
10 kHz	20 kHz
25 kHz	50 kHz
50 kHz	100 kHz
100 kHz	200 kHz
250 kHz	500 kHz
500 kHz	1 MHz
1 MHz	2 MHz
2.5 MHz	5 MHz
5 MHz	10 MHz
10 MHz	20 MHz
18.6 MHz	20 MHz
20 MHz	25 MHz
25 MHz	50 MHz
31.25 MHz	50 MHz
50 MHz* ¹	100 MHz
62.5 MHz* ²	100 MHz
100 MHz* ³	200 MHz
125 MHz* ³	200 MHz

*1: 50 MHz can be set only when Option 004/104/077/177 is installed.

*2: 62.5 MHz can be set only when Option 077/177 is installed.

*3: 100 MHz and 125 MHz can be set only when Option 004/104/078/178 is installed.

Table 5.2.4-2 lists the minimum data length settings (Capture Sample) for which analysis is possible.

Table 5.2.4-2 Minimum Data Length

CaptureSample	Frequency Span
74000	1 kHz
160000	2.5 kHz
310000	5 kHz
610000	10 kHz
730000	Other than the above



Notes :

- The replay function cannot be executed if the data length (Capture Sample) of the IQ data file is less than the length required for analysis.
- It is recommended to configure the settings below, in order to replay IQ data saved by the Signal Analyzer functions.
 - To set Capture Time to Manual.
 - To set Time Range to Full.
 - To set Output Rate to the maximum value.
- The Replay function cannot be executed for any saved IQ data file, if Terminal is set to DigRF 3G.



5.2.5 Stopping Replay function

Stop the Replay function using the following procedure.

<Procedure>

1. Press  (Capture) on the main function menu.
2. Press  (Stop Replaying).

5.3 Playback Function

The Playback function converts the captured data into waveform patterns and outputs them by loading into the vector signal generator option. Press  (Capture) in the Main function menu, and then press  (Capture & Playback) in the Capture function menu to display the Playback function menu.

Note:





When Time Length of Trace Analysis Time is set to 0 s, the Playback function cannot be used because  (Capture & Playback) is disabled.

Table 5.3-1 Description of Playback function menu

Function Key	Menu Display	Function
Page 1	Playback	Displayed when pressing  (Capture & Playback).
F1	Package	Sets a package name for the waveform patterns into which the captured data is converted.
F2	Pattern Name	Sets a name for the waveform patterns into which the captured data is converted.
F3	Burst	Turns On/Off the RF Gate automatic setting function, regarding the Off interval of burst waveform as no signal output instead of modulation wave.
F4	Burst Off Threshold	Sets the burst off threshold for the RF Gate automatic setting.
F5	Minimum Burst Off Length	Sets the minimum length of Off interval of the burst wave. (Specifies the time length during which the signal level is not judged as Off interval when it goes below the threshold owing to modulation.)
F7	Exec Capture & Playback	Executes Capture & Playback.
F8	Close	Goes back to Capture Function Menu.
Page 2	Playback	Displayed when pressing  (Capture & Playback) and then  .
F1	Ramp	Turns On/Off the function to add a ramp (moderate change) to the waveform start and end for the purpose of preventing spectrum from spreading.
F2	Ramp Length	Sets the ramp length.
F8	Close	Goes back to Capture Function Menu.

Package

Default Playback

Available characters Alphanumeric characters and the following symbols

! % & () + = ' { } _ - ^ @ []

Character number 31 characters at maximum

Pattern Name

Default Same as Saving Files in 5.1 “Saving IQ Data”.

Available characters Alphanumeric characters and the following symbols

! % & () + = ' { } _ - ^ @ []

Character number 20 characters at maximum

Burst

Options On/Off

Default On

Burst Off Threshold

Range -80.00 to 0.00 dB

Resolution 0.01 dB

Default -40 dB

Minimum Burst Off Length

Range 0 to (Time Length or 50000 samples, whichever smaller)

Resolution Time Resolution

Default Time Resolution×10

Unit s, ms, μs, ns

- When the span is changed, it is reset to default.
- When the time length is changed, it is reset to default.
- When the time length is 0, it is fixed to 0.

Ramp

Options On/Off

Default Off

Ramp Length

Range 0 to (Time Length or 50000 samples, whichever smaller)

Resolution Time Resolution

Default Time Resolution×10

Unit s, ms, μs, ns

- When the span is changed, it is reset to default.
- When the time length is changed, it is reset to default.
- When the time length is 0, it is fixed to 0.

Note:



Time Length: The set value for F3 Time Length in Table 4.2.3-1 Analysis Time function menu is used here.

Time Resolution: The value is decided as in Table 4.2.3-5 Frequency span and resolution.

5.3.1 Starting Playback function

Start the Playback function using the following procedure :

<Procedure>



1. Press  (Capture) on the main function menu.
2. Press  (Capture & Playback) on the Capture function menu.

Note :

An error message appears and Playback is not performed in the cases below.

- The application of vector signal generator option is not loaded.
- Free space in HDD (C or D drive) is insufficient.

Drive	Free Space Required
C	dgz file size to output × 2
D	dgz file size to output × 2

3. Sets a package name for waveform patterns by pressing  (Package) in the Playback function menu.
4. Press  (Pattern Name) and specify a waveform pattern name.
5. Press  (Exec Capture & Playback).

At the upper right of the menu bar of the Signal Analyzer application, the Capture & Playback dialog box is displayed to show the status by icon and progress bar.

Note :

After converting data into waveforms by Playback function, the frequency and level for the vector signal generator option will be rounded up/down as below when they are out of setting range.

- Frequency and level are above the limit :
Rounded down to the upper limit.
- Frequency and level are below the limit :
Rounded up to the lower limit.

For the setting range of the vector signal generator option, refer to 1.3 “Specifications” in the *MS2690A/MS2691A/MS2692A Signal Analyzer Option 020: Vector Signal Generator Operation Manual (Operation)*.

6. Signal is output from the vector signal generator option.

5.3.2 Display During Playback Function Execution

While executing Playback function, the Capture & Playback function menu and the Capture & Playback dialog box are displayed.

Table 5.3.2-1 Description of Capture & Playback function menu

Function Key	Menu Display	Function
F8	Cancel	Aborts the execution of Playback function.

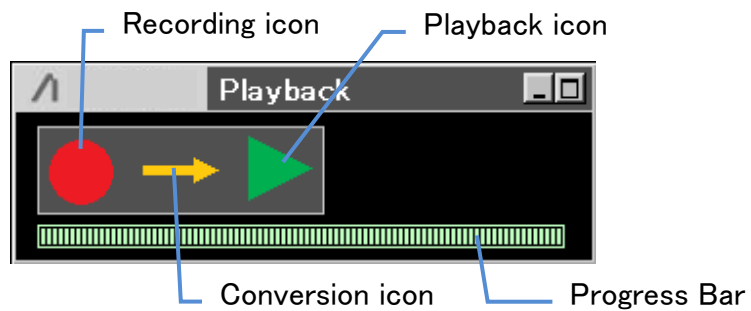





Figure 5.3.2-1 Capture & Playback Dialog box

Table 5.3.2-2 Capture & Playback Icon

Display	Name	Function
	Recording icon	Blinking: Saving captured data is in progress. Lighting: Saving captured data is completed.
	Conversion icon	Blinking: Converting captured data into waveform patterns is in progress. Lighting: Converting captured data into waveform patterns is completed.
	Playback icon	Blinking: Loading waveform patterns into the vector signal generator option is in progress. Lighting: Outputting signals from the vector signal generator option is in progress.
	Progress Bar	Recording icon is blinking: Displays the progress in saving captured data. Conversion icon is blinking: Displays the progress in converting captured data into waveform patterns. Playback icon is blinking: Displays the progress in loading waveform patterns into the vector signal generator option. Aborted: Displays the progress in aborting.

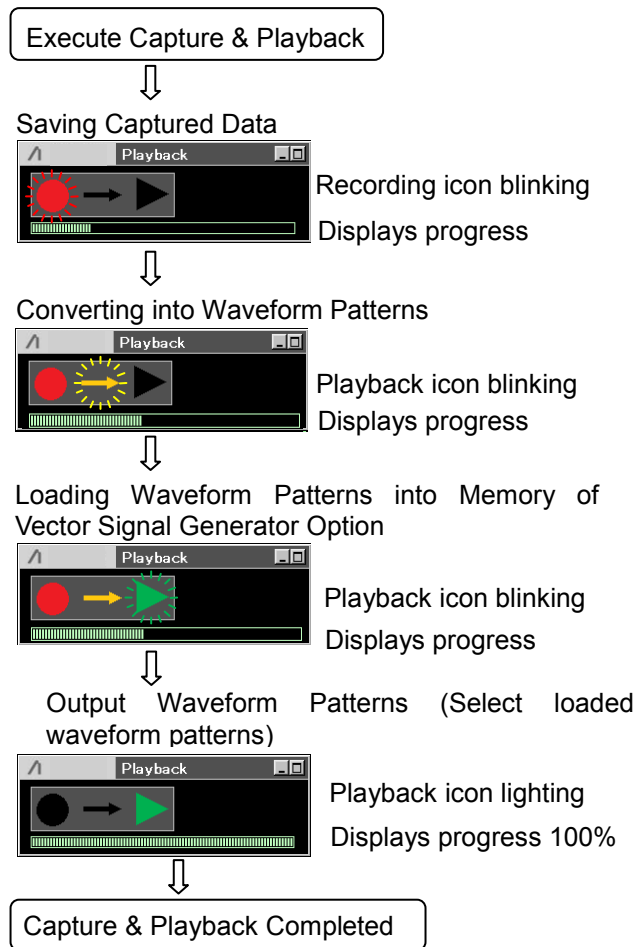



Figure 5.3.2-2 Capture & Playback icon transition

5.3.3 Aborting Playback function

While executing Playback function, pressing  (Cancel) in the Capture & Playback function menu can abort the operation.

The processing of generated data files differs depending on the aborted timing of Playback function.

Saving captured data in progress

Aborts saving captured data.

Converting into waveform patterns

Aborts converting into waveform patterns, and deletes the files and waveform patterns that have been partially converted. (The captured data already saved will not be deleted.)

Loading waveform patterns

Aborts loading waveform patterns and resets the vector signal generator option to the status before loading. (Captured data and fully-converted waveform patterns will not be deleted.)

Chapter 6 System Setting

This chapter describes how to perform system setting for the Signal Analyzer function.

6.1	Setting System.....	6-2
6.2	Erasing Warm up Message	6-3
6.3	Setting Title	6-4
6.4	Adjusting Internal Reference Clock Signal	6-5
6.5	Input Source for Reference Clock Signal	6-6
6.6	Pre-Amp On/Off Display	6-7
6.7	Setting Preselector	6-8
	6.7.1 Preselector auto tuning	6-9
	6.7.2 Preselector manual tuning.....	6-9

6.1 Setting System

Pressing  (Accessory) from the main function menu displays the Accessory function menu.

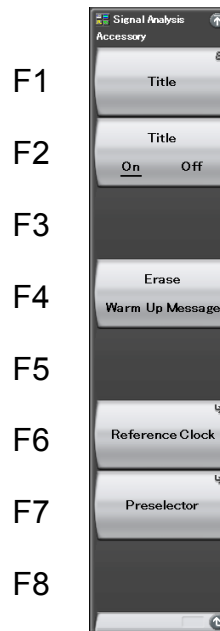







Figure 6.1-1 Accessory function menu

Table 6.1-1 Accessory function menu

Menu Display	Function
Title	Specifies the title.  6.3 “Setting Title”
Title (On/Off)	Sets whether to display the title.  6.3 “Setting Title”
Erase Warm Up Message	Forcefully erases the warmup message display.  6.2 “Erasing Warm up Message”
Reference Clock	Adjusts the internal reference clock signal.  6.4 “Adjusting Internal Reference Clock Signal”
Preselector	Opens the Preselector function menu.  6.7 “Setting Preselector”

6.2 Erasing Warm up Message

If the warm up message (**Warm Up**) indicating that the level and frequency are not stable is displayed upon power on, the message can be forcefully erased.

Setting example: Erasing the warm up message

<Procedure>

1. Press **F8** (Accessory) from the main function menu.
2. Press **F4** (Erase Warm Up Message) to erase the warm up message.

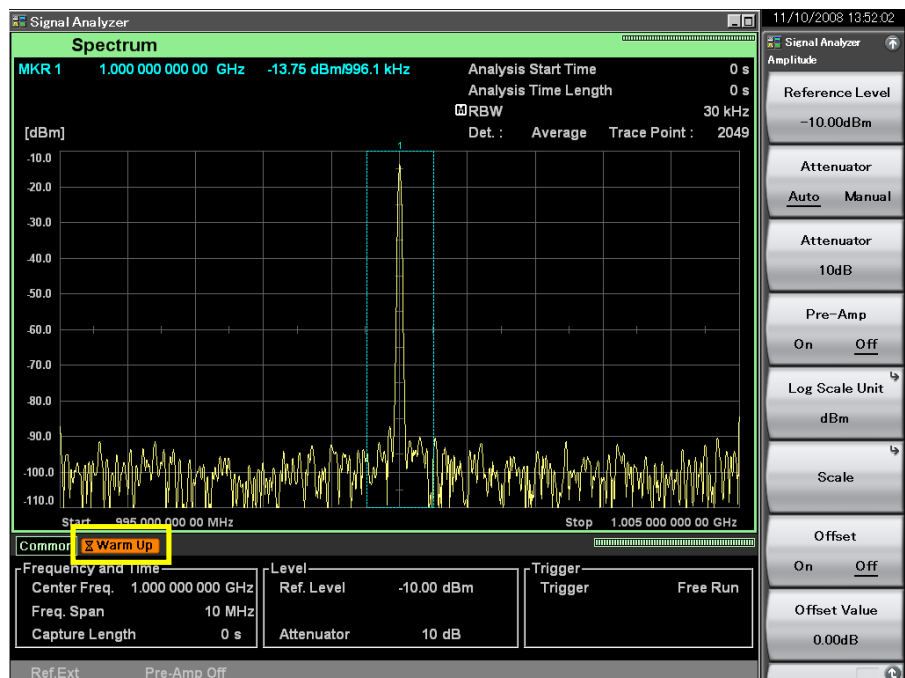

Figure 6.2-1 Warm up message

6.3 Setting Title

Settings related to the title displayed on the screen can be configured. For the Signal Analyzer function, a title of up to 32 characters can be displayed on the screen. (Character strings of up to 17 characters can be displayed on a function menu.)

Example: To set the title

<Procedure>

1. Press **F8** (Accessory) from the main function menu.
2. Press **F1** (Title) to display the character string input screen. Select a character using the rotary knob, and enter it by pressing **Enter**. Enter the title by repeating this operation.
3. When the title is entered, press **F7** (Set).

Note:

Pressing **F2** (Title On/Off) can show or hide the title.

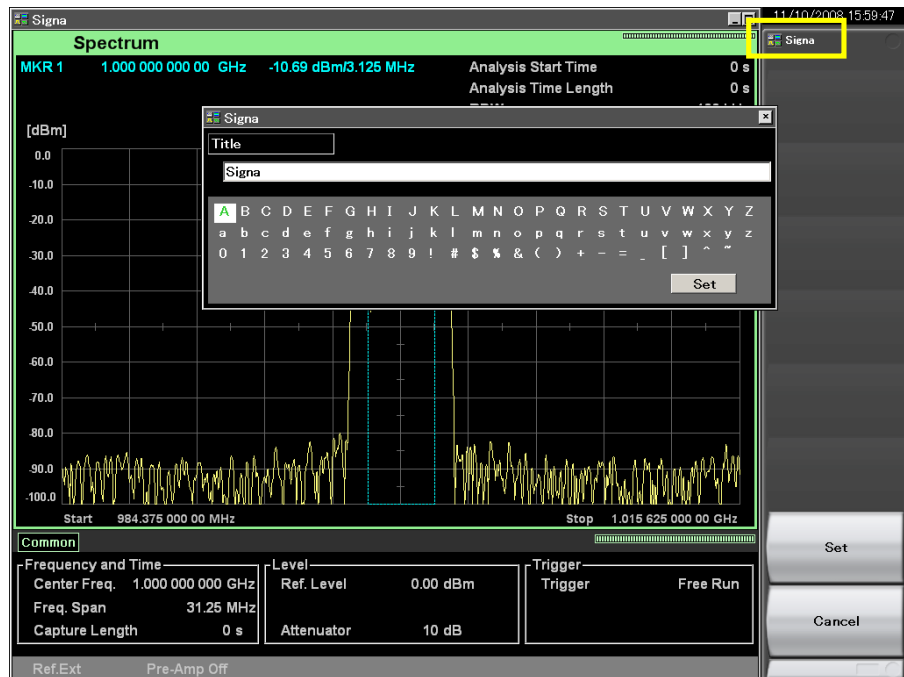

Figure 6.3-1 Setting title

6.4 Adjusting Internal Reference Clock Signal

Pressing **F6** (Reference Clock) from the Accessory function menu displays the Reference Clock function menu.

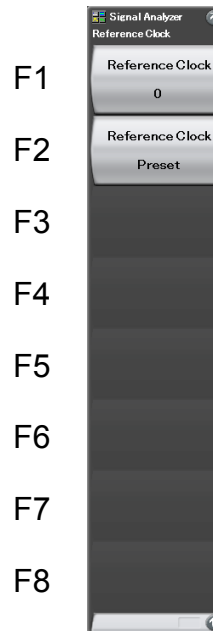

Figure 6.4-1 Reference Clock function menu

Table 6.4-1 Reference Clock function menu

Menu Display	Function
Reference Clock	Adjusts the frequency of the internal reference clock signal.
Reference Clock Preset	Resets the Reference Clock to the factory-default value.

Example: To adjust the reference clock.

<Procedure>

1. Press **F8** (Accessory) from page 1 of the main function menu.
2. Press **F6** (Reference Clock) and then press **F1** (Reference Clock) to adjust the frequency of the internal reference clock signal.

6.5 Input Source for Reference Clock Signal

The reference clock signal used is displayed on the screen.

Ref.Int: The internal reference clock signal is used.

Ref.Int Unlock: The internal reference clock signal is unlocked. The internal hardware may be faulty.

Ref.Ext: The external reference clock signal is used.

Ref.Ext Unlock: Not in sync with the external reference clock signal. Check the reference signal input to the Ref Input connector.

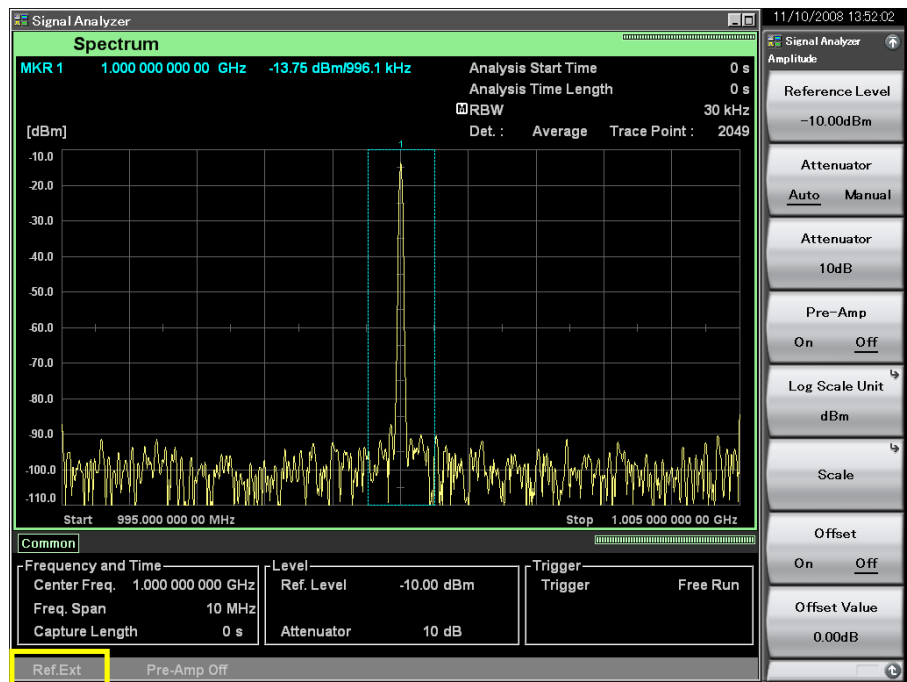



Figure 6.5-1 Input source for reference clock signal

6.6 Pre-Amp On/Off Display

If the Option 008 6 GHz Preamplifier is installed, whether the pre-amp is on or off is displayed at the lower left of the screen.

 2.3.6 “Pre Amp”

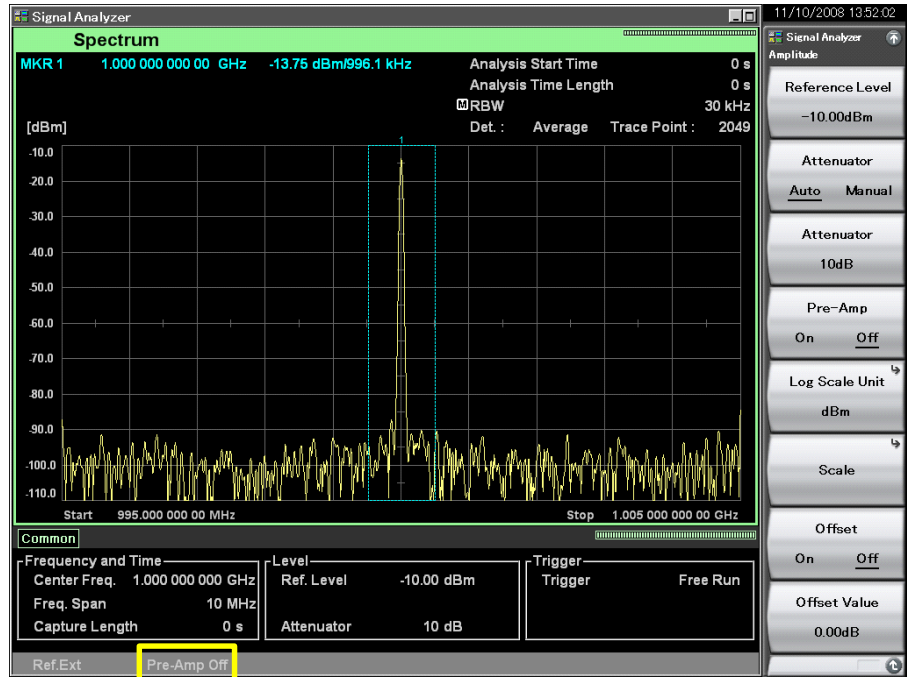

Figure 6.6-1 Pre-Amp display

6.7 Setting Preselector

Performs settings to tune preselector.

This function is available for MS2691A/MS2692A.



Pressing  (Preselector) from the Accessory function menu displays the Preselector function menu.

Table 6.7-1 Preselector function menu

Menu display	Function
Preselector Auto Tune	Auto-tunes preselector.  6.7.1 "Preselector auto tuning"
Manual	Manually tunes preselector.  6.7.2 "Preselector manual tuning"
Preselector Tune Preset	Sets the preselector peaking bias value to factory shipment defaults.

The MS2691A/MS2692A is a superheterodyne spectrum analyzer, so spurious responses such as image responses and multiple responses occur for the reception frequencies over 6 GHz. To eliminate the spurious responses to display only the real signal on the screen, the MS2691A/MS2692A uses a preselector. The preselector is a tunable band-pass filter that follows the reception frequency of the analyzer.

The preselector is set up to obtain tuning at each frequency in normal use. However, if the tuning frequency is not correct, the reception level becomes low, as shown in the left figure, below. To obtain the maximum response as shown in the right figure, below, preselector tuning frequency adjustment (preselector tuning) must be performed.

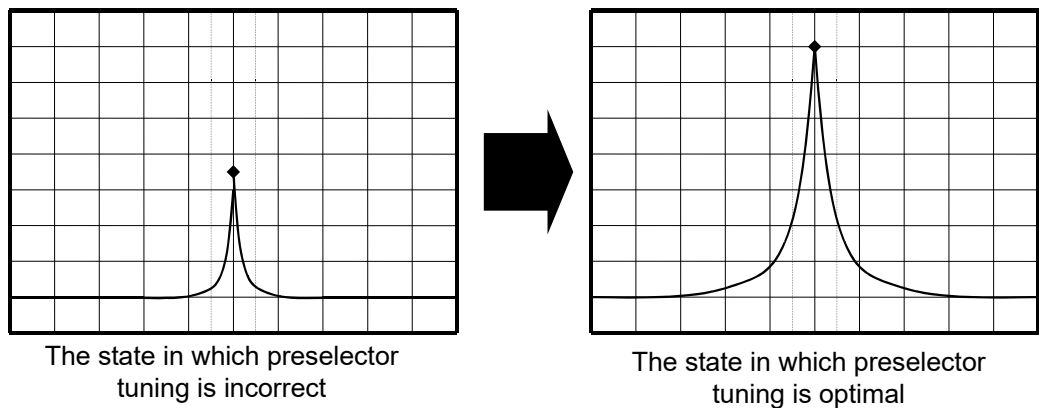

Figure 6.7-1 Preselector auto tune

For preselector tuning, use an unmodulated signal. If a modulation signal is used, proper tuning may not be executed.

Before the measurement of a modulation signal, input an unmodulated signal from the signal generator for preselector tuning in advance.

6.7.1 Preselector auto tuning

Tunes the preselector peaking bias value automatically, and performs the preselector auto tuning.

Preselector auto tuning is not available in the following condition.



- Terminal is DigRF 3G.
- Option 067/167 is installed and Preselector Bypass is ON.
- Frequency Span is ≥ 50 MHz.
- Frequency Band Mode is Normal and Center Frequency is ≤ 6.0 GHz.
- Frequency Band Mode is Spurious and Center Frequency is ≤ 4.0 GHz.

Example: To perform preselector auto tuning when the measurement signal is an unmodulated signal

<Procedure 1>

1. Press .
2. Press  (Preselector Auto Tune).

<Procedure 2>



1. Press  (Accessory) on the page 1 of main function menu.
2. Press  (Preselector), and then press  (Preselector Auto Tune).

6.7.2 Preselector manual tuning

Sets the preselector peaking bias value to tune the preselector manually.

Example: To perform preselector manual tuning

<Procedure>

1. Press  (Accessory) on Page 1 on the main function menu.
2. Press  (Preselector), and then press  (Manual).
3. Use rotary knob or cursor key to tune the peaking bias to make the signal indication level maximum.

Range: -128 to 127 MHz

Resolution: 1 MHz

Press  (Preselector Tune Preset) to return to factory shipment defaults.

Chapter 7 *Setting DigRF 3G*

This chapter describes the detailed description of the DigRF 3G settings. DigRF 3G is unavailable when the Option 040/140 is not installed or the software package is Ver.6.00.00 or later.

7.1	Display Description	7-2
7.2	Setting Input.....	7-3
7.2.1	Setting terminal.....	7-4
7.2.2	Setting DigRF 3G	7-5
7.3	Setting Frequency.....	7-8
7.4	Setting Level	7-9
7.5	Setting IQ Data Capture Time Range.....	7-11
7.5.1	Setting capture time.....	7-12
7.5.2	Parameters recaptured when Capture Time is Manual	7-13
7.6	Trigger Function.....	7-14
7.7	Selecting Trace	7-16
7.7.1	Spectrum	7-18
7.7.2	Power vs Time.....	7-25
7.7.3	Frequency vs Time	7-31
7.8	Saving IQ Data.....	7-36
7.8.1	Format of data information file.....	7-38
7.8.2	Format of data file.....	7-39
7.9	System Setting.....	7-40
7.10	Default Value List.....	7-42

7.1 Display Description

Displays  (Input) button on the main function menu on the main screen, when option 040 is installed.

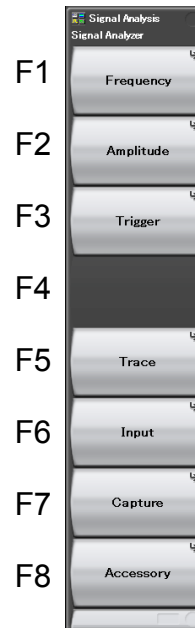









Figure 7.1-1 Main function Menu

Table 7.1-1 Main function Menu

Menu Display	Function
Frequency	Sets the frequency.  7.3 "Setting Frequency"
Amplitude	Sets the level.  7.4 "Setting Level"
Trigger	Sets the trigger.  7.6 "Trigger Function"
Trace	Configures the settings related to trace.  7.7 Selecting Trace
Input	Configures the settings related to input.  7.2 "Setting Input"
Capture	Used for settings related to IQ data capture.  7.5 "Setting IQ Data Capture Time Range"
Accessory	Sets up other functions.  7.9 "System Setting"

7.2 Setting Input



Displays the Input function menu when press the  (Input) button on the main function menu



Figure 7.2-1 Input function menu

Table 7.2-1 Input function menu

Menu Display	Function
Terminal	Sets the terminal.  7.2.1 "Setting terminal"
DigRF 3G Setting	Sets the DigRF 3G.  7.2.2 "Setting DigRF 3G"

7.2.1 Setting terminal

Displays the Terminal function menu when press the  (Terminal) button on the Input function menu.



Figure 7.2.1-1 Terminal function menu

Table 7.2.1-1 Terminal function menu

Menu Display	Function
RF	Sets RF for Terminal.
DigRF 3G	Sets DigRF 3G for Terminal. When DigRF 3G is set, several functions are limited. Refer to section 7.3 “Setting Frequency”, 7.4 “Setting Level”, 7.5 “Setting IQ Data Capture Time Range”, 7.6 “Trigger Function”, 7.7 “Selecting Trace”, 7.8 “Saving IQ Data”, and 7.9 “System Setting” for details.

Note:

When the terminal is set to DigRF 3G, it cannot be synchronized to the 13 MHz reference clock signal.

7.2.2 Setting DigRF 3G

Displays the DigRF 3G Setting function menu when press  (DigRF 3G Setting) button on the Input function menu.

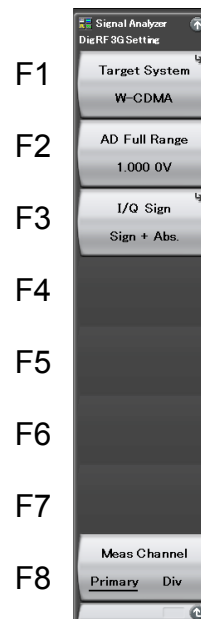

Figure 7.2.2-1 DigRF 3G Setting function menu

Table 7.2.2-1 DigRF 3G Setting function menu

Menu Display	Function
Target System	Sets the target system.
AD Full Range	Sets the AD full range.
I/Q Sign	Sets the I/Q sign.
Meas Channel	Sets the data channel of DigRF 3G.

Setting target system

Selects the communication method of input signal.

(1) W-CDMA

To set W-CDMA to the communication method of input signal.

Sample bit for the W-CDMA is 8 bits (decimal number: -128 to 127).



(2) GSM

To set GSM to the communication method of input signal.

The sample byte of GSM is 16 byte (decimal: -32768 to 32767).

Example: To set the Target System to GSM.

<Procedure>





1. Press  (DigRF 3G Setting) on the Input function menu.
2. Press  (Target System).
3. Press  (GSM) to set the Target System to GSM.

Setting AD full range

Enter the factor for converting the DigRF 3G signal to V units.

Example: To set the AD Full Range to 10.000 V.

<Procedure>

1. Press  (DigRF 3G Setting) on the Input function menu.
2. Press  (AD Full Range).
3. Press   and then press  (V) to set the AD Full Range to 10.000 V.

Setting range and resolution for AD full range

Setting range	: 1 mV to 10 V
Minimum resolution	: 0.1 mV
Rotary knob resolution	: 2 step at the highest 1st digit
Step key resolution	: 1-2-5 sequence



Setting I/Q sign

Sets the I/Q sign.

- (1) Sign + Abs.
Defined by “Sign bit + Absolute value”.
- (2) Two's Complement
Defined by “Two's complement”.

Example: To set the I/Q Sign to Two's Complement.

<Procedure>

1. Press  (DigRF 3G Setting) on the Input function menu.
2. Press  (I/Q Sign).
3. Press  (Two's Complement) to set the IQ Sign to Two's Complement.



Setting meas channel

To set the data channel to transmission DigRF 3G signal data.

- (1) Primary
To set Primary for the data channel to transmission DigRF 3G signal data.
- (2) Div
To set diversity for the data channel to transmission DigRF 3G signal data.

Example: To set the Meas Channel to diversity.

<Procedure>

1. Press  (DigRF 3G Setting) on the Input function menu.
2. Press  (Meas Channel Primary/Div) to select the Meas Channel to Diversity.

7.3 Setting Frequency

This section describes limited function of frequency settings when Terminal sets DigRF 3G.

Setting frequency

When the terminal is set to DigRF 3G, sampling rate for capturing the waveform is fixed, making impossible to set the center frequency, start frequency, frequency span, and stop frequency.

Sampling rate

W-CDMA : 7.68 MHz

GSM : 541.666 kHz

 7.2.2 “Setting DigRF 3G”

Setting preselector auto tune

Note:

The settings of this function is only enable when the instrument is MS2691A or MS2692A, also Terminal is set RF.

Settings for Preselector Auto Tune cannot be performed when the terminal is set to DigRF 3G.

Setting frequency band mode

Note:

The settings of this function are enabled only when option 003 is installed, and Terminal is set to RF.

You cannot set Frequency Band Mode when Terminal is set to DigRF 3G.

Setting Micro Wave Preselector Bypass

You cannot set Micro Wave Preselector Bypass when Terminal is set to DigRF 3G.

7.4 Setting Level

This section describes limited function of level settings when Terminal is set to DigRF 3G. Refer to Section 2.3 “Setting Level” for the settings not mentioned here, since they are the same as when terminal is RF.

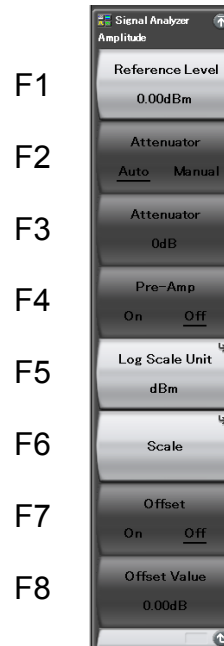

Figure 7.4-1 Amplitude function menu

Table 7.4-1 Amplitude function menu

Menu Display	Function
Reference Level	Sets the maximum level of the input signal.
Log Scale Unit	Sets the unit (Log scale) of the level axis.
Scale	Sets the scale mode of the level axis.

Setting reference level

The settings of reference level are the same as when Terminal is RF. Refer to Section 2.3.1 “Setting reference level” for settings.

Setting input attenuator

You cannot set the attenuator when Terminal is DigRF 3G.

Setting Pre-Amp

Note:

The settings of this function are enabled only when option 008 is installed, and Terminal is set to RF.

You cannot set the pre amp when Terminal is DigRF 3G.

Setting scale

The settings of scale are the same as when Terminal is RF.

Refer to Section 2.3.3 “Setting scale” for settings.

Setting reference level unit

The settings of reference level unit are the same as when Terminal is RF.

Refer to Section 2.3.4 “Setting reference level unit” for settings.

Setting reference level offset

You cannot set the reference level when Terminal is set to DigRF 3G.

Setting Micro Wave Preselector Bypass

You cannot set Micro Wave Preselector Bypass when Terminal is set to DigRF 3G.

7.5 Setting IQ Data Capture Time Range

This section describes setting method of the IQ data capture time range by sample unit when Terminal is set to DigRF 3G. Refer to Section 2.4 “Setting IQ Data Capture Time Range” for the settings not mentioned here, since they are the same as when terminal is RF.

Press **F7** (Capture) on the main function menu to display the Capture function menu.

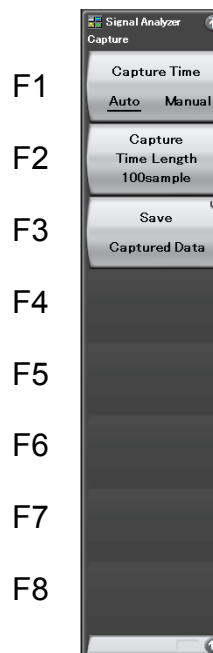





Figure 7.5-1 Capture function menu

Table 7.5-1 Capture function menu

Menu Display	Function
Capture Time (Auto/Manual)	Switches the capture time of the DigRF 3G input signal between auto mode and manual mode.  7.5.1 “Setting capture time”
Capture Time Length	Sets the capture time of the DigRF 3G input signal in sample units.  7.5.1 “Setting capture time”
Save Captured Data	Saves the captured IQ data of the DigRF 3G input signal.  7.8 “Saving IQ Data”

7.5.1 Setting capture time

Capture time length can be set in sample units.

(1) Auto

Setting values of capture time are the same as when Terminal is RF. Refer to Section 2.4.1 “Setting capture time” for settings.

(2) Manual

Setting values of capture time are the same as when Terminal is RF. Refer to Section 2.4.1 “Setting capture time” for settings.

Table 7.5.1-1 shows the setting range in sample units when Capture Time is set to Manual.

Table 7.5.1-1 Setting range of the Capture Time [sample]

Target System	Capture Time [sample]		
	Minimum Value	Maximum Value	Default Value
W-CDMA	100	500000000	*
GSM	100	200000000	*

*: Default values are determined depending on the setting values of “Capture Time = Auto”.

Example: To set the Capture Time Length to 100 Msample.

<Procedure>

1. Press **F7** (Capture) on the main function menu.
2. Press **F2** (Capture Time Length).
3. Press **1**, **0**, **0** and then press **F2** (Msample) to set Capture Time Length to 100 Msample.

Setting range and resolution for capture time

- Minimum resolution : 1 sample
- Rotary knob resolution : 2 step at the highest 1st digit
- Step key resolution : 1-2-5 sequence

7.5.2 Parameters recaptured when Capture Time is Manual

When the terminal is set to DigRF 3G, some parameters are recaptured when they are changed. The parameters are shown in Table 7.5.2-1.

Table 7.5.2-1 Recaptured Parameters Unique to DigRF 3G

Parameter
Terminal
Target System
AD Full Range
I/Q Sign
Meas Channel

7.6 Trigger Function

This section describes limitations to Trigger functions when Terminal is set to DigRF 3G. Refer to Section 3.2 “Trigger Function” for the settings not mentioned here, since they are the same as when terminal is RF.

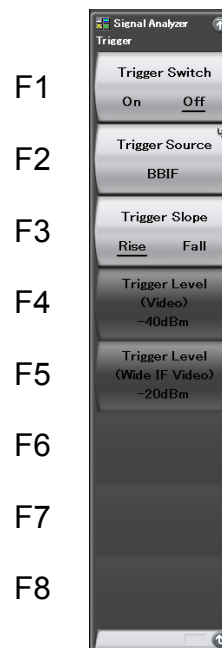

Figure 7.6-1 Trigger function menu

Table 7.6-1 Trigger function menu

Menu Display	Function
Trigger Switch (On/Off)	Sets the capture start condition.
Trigger Source	Selects the trigger source.
Trigger Slope (Rise/Fall)	Selects the edge where the trigger is generated (rise or fall).

Setting trigger switch

The settings of trigger switch are the same as when Terminal is RF. Refer to Section 3.2.1 “Normal measurement” for settings.

Setting trigger source

BBIF Trigger can only be selected when Terminal is DigRF 3G. Refer to Section 3.2.2 “Trigger measurement” for details.

Note:

The settings of this function are enabled only when option 040 is installed and Terminal is set to DigRF 3G.

The Video trigger, the Wide IF video trigger, the SG marker trigger, and External trigger cannot be selected when Terminal is DigRF 3G.

Setting trigger slope

The settings of trigger slope are the same as when Terminal is RF. Refer to 3.2.2 “Trigger measurement” for settings.

Setting video trigger level

You cannot set the trigger level for the Video trigger when Terminal is DigRF 3G.

Setting wide IF video trigger level

You cannot set the trigger level of the Wide IF Video trigger when Terminal is DigRF 3G.

7.7 Selecting Trace

This section describes limitations to Trace when Terminal is set to DigRF 3G. Press **F5** (Trace) on the main function menu and then press **F1** (Trace Mode) to display the Trace Mode function menu.

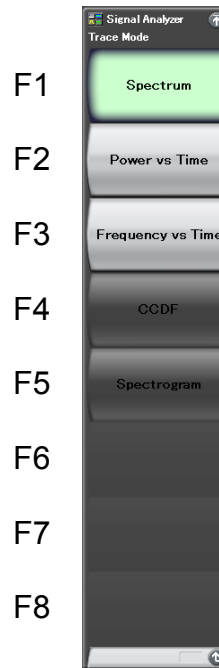





Figure 7.7-1 Trace Mode function menu

Table 7.7-1 Trace Mode function menu

Menu Display	Function
Spectrum	Displays Spectrum trace.  7.7.1 “Spectrum”
Power vs Time	Displays Power vs Time trace.  7.7.2 “Power vs Time”
Frequency vs Time	Displays Frequency vs Time trace.  7.7.3 “Frequency vs Time”

Setting Spectrum

There are several limitations when Terminal is set to DigRF 3G. Refer to Section 7.7.1 “Spectrum” for details.

Setting Power vs Time

There are several limitations when Terminal is set to DigRF 3G. Refer to Section 7.7.2 “Power vs Time” for details.

Setting Frequency vs Time

There are several limitations when Terminal is set to DigRF 3G. Refer to Section 7.7.3 “Frequency vs Time” for details.

Setting CCDF

You cannot set CCDF when Terminal is set to DigRF 3G.

Setting Spectrogram

You cannot set Spectrogram when Terminal is set to DigRF 3G.

7.7.1 Spectrum

This section describes the limitations to the Spectrum Trace when Terminal is set DigRF 3G. Refer to Section 4.2 “Spectrum” for the settings not mentioned here, since they are the same as when terminal is RF.

The display items for the spectrum trace are described below.

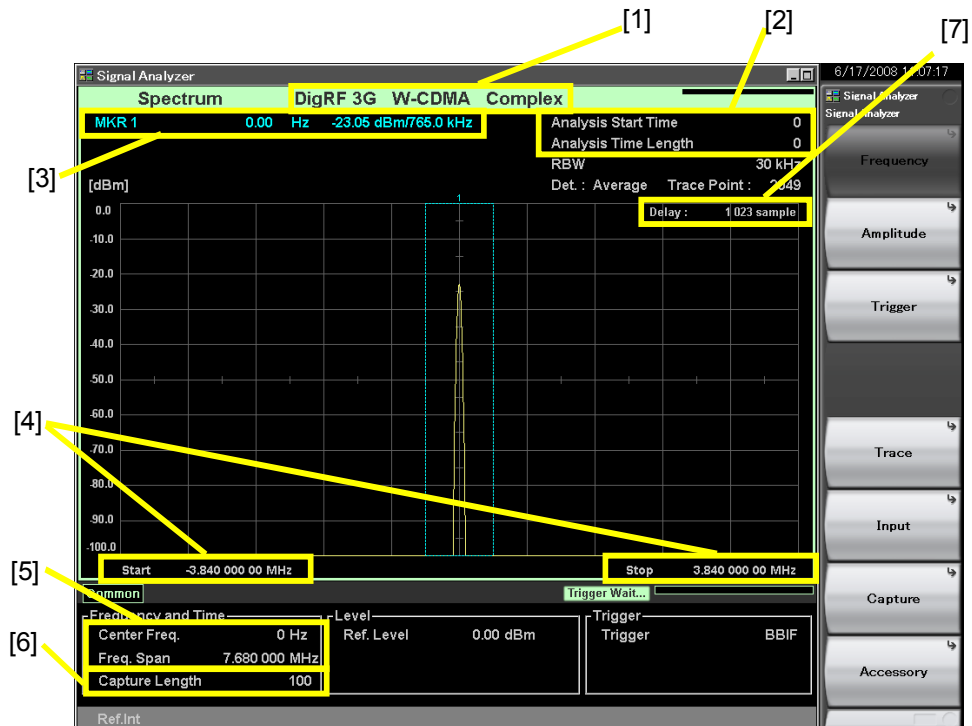

Figure 7.7.1-1 Display items for spectrum trace

Table 7.7.1-1 Display items for spectrum trace

No.	Display	Description
[1]	DigRF 3G W-CDMA Complex	Displays current Terminal, Target System, and Input Source.
[2]	Analysis Start Time/Analysis Time Length	Displays the analysis start time and analysis time length in sample units.
[3]	MKR1	Displays the Marker results and the Marker time location in sample units.
[4]	Start/Stop	Displays the start frequency and stop frequency.
[5]	Center Freq/Freq Span	Displays the centre frequency and frequency span.
[6]	Capture Length	Displays capture time length of frequency display in sample units.
[7]	Delay	Displays delay time of results in sample units.

Note:

Under the following condition, result of following equation is displayed for the marker result value for spectrum trace.

$$\text{Marker [dBm]} = 10 \times \log(F)$$

- Marker [dBm]: Marker result value [dBm]
 F: Minimum value for floating decimal point of 32 bits ($1.175494351 \times 10^{-38}$)
- Condition 1: When the reference level unit is dBm, dB μ V, dBmV, dB μ V (emf), or dB μ V/m
 However, above equation needs to be converted when it is dB μ V, dBmV, dB μ V (emf), and dB μ V/m.
- Condition 2: When AD value for DigRF 3G signal is 0

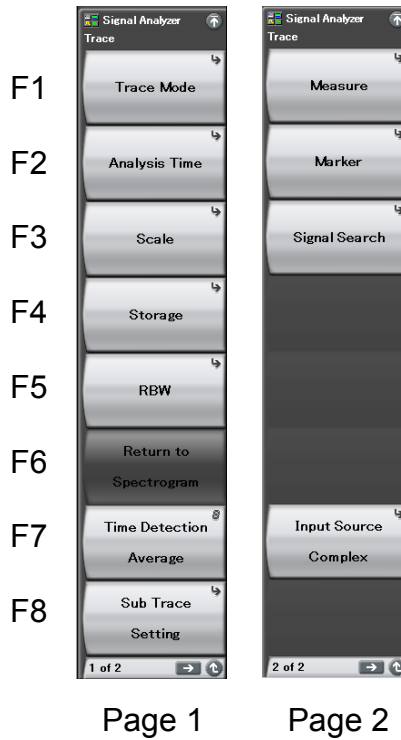

Figure 7.7.1-2 Trace function menu

Table 7.7.1-2 Trace function menu

Menu Display	Function
Trace Mode	Sets the trace type.
Analysis Time	Used for setting related to analysis time.
RBW	Used for setting related to RBW.
Sub Trace Setting	Used for setting related to sub-trace.
Measure	Used for setting related to the Measure function.
Input Source	Sets the analysis method of DigRF 3G signals.

Selecting trace type

There are several limitations when Terminal is set to DigRF 3G. Refer to Section 7.7 “Selecting Trace” for details.

Setting analysis time

Sets either Auto or Manual setting of analysis time in sample units. Sets the analysis time and the analysis time length in sample units.

Setting basis for analysis start time and analysis time length is the same as when the terminal is set to RF.

Example: To set the Analysis Start Time to 100 Msample.

<Procedure>







1. Press  (Trace) on the main function menu.
2. Press  (Analysis Time).
3. Press  (Analysis Start Time).
4. Press , , , and then press  (Msample) to set the analysis start location to 100 Msample.

Table 7.7.1-3 explains the setting ranges of analysis start time in sample units.

Analysis start time [sample] setting range

Table 7.7.1-3 Analysis start time [sample] setting range

Capture Time	Minimum Value [sample]	Maximum Value [sample]
Auto	0	$x_2 - x_1$
Manual	0	$x_3 - x_1$

x_1 : Analysis time length [sample]

x_2 : Maximum value [sample] of capture time length

x_3 : Capture time length [sample]

 7.5 "Setting IQ Data Capture Time Range"

Example: To set Analysis Time Length to 10 Msample.

<Procedure>







1. Press  (Trace) on the main function menu.
2. Press  (Analysis Time).
3. Press  (Analysis Time Length).
4. Press , , and then press  (Msample) to set the analysis time length to 10 Msample.

Table 7.7.1-4 explains the setting ranges of analysis time length by sample unit.

Analysis time length setting range

Table 7.7.1-4 Analysis time length [sample] setting range

Capture Time	Minimum Value [sample]	Maximum Value [sample]
Auto	0	$x_2 - x_1$
Manual	0	$x_3 - x_1$

x_1 : Analysis start time [sample]

x_2 : Maximum value [sample] of capture time length

x_3 : Capture time length [sample]

 7.5 “Setting IQ Data Capture Time Range”

Setting scale

The settings of scale are the same as when Terminal is RF.

Refer to Section 4.2.4 “Setting scale” for settings.

Setting storage mode

The settings of storage mode are the same as when Terminal is RF.

Refer to Section 4.2.6 “Setting storage mode” for settings.

Setting resolution bandwidth (RBW)

Setting ranges of the resolution bandwidth vary when Terminal is set to DigRF 3G.

Setting ranges of the resolution bandwidth vary depending on the settings of Marker Result, in the same way as when Terminal is RF. Also, the setting ranges vary depending on the settings of Target System.

Table 7.7.1-6 explains the setting ranges.

Table 7.7.1-5 Pattern of Marker Result

Marker Result			
Integration	Density	Peak (Fast)	Peak (Accuracy)
[1]	[1]	[2]	[3]

Table 7.7.1-6 Setting range of resolution bandwidth

Target System	RBW [Hz]			
	Minimum in [1]	Minimum in [2]	Minimum in [3]	Maximum
GSM	10	10	30	10k
W-CDMA	100	100	300	300k

Executing Return to Spectrogram

You cannot execute Return to Spectrogram when Terminal is DigRF 3G.

Setting sub-trace

You cannot set Spectrogram when the terminal is set to DigRF 3G.

Setting Detection Mode

The settings of detection mode are the same as when Terminal is RF. Refer to Section 4.2.7 “Setting detection mode” for settings.

Setting Measure

You cannot set Standard when Terminal is DigRF 3G.

For other functions of measure setting are the same as when Terminal is RF.

Refer to Section 4.2.10 “Measure measurement” for settings.

Setting Markers

The settings of markers are the same as when Terminal is RF.

Refer to Section 4.2.8 “Setting markers” for settings.

Setting Marker Search

The settings of marker search are the same as when Terminal is RF.

Refer to Section 4.2.9 “Setting marker search” for the settings.



Setting Input Source

Sets the analysis method of DigRF 3G signals.

- (1) Complex
Analyze the multiple data of I phase and Q phase.
- (2) I
Analyzes only the data of I phase.
- (3) Q
Analyzes only the data of Q phase.

Example: To set the Input Source to I phase.

<Procedure>

1. Press  (Input Source) on page 2 of the Trace function menu.
2. Press  (I) to set the Input Source to I phase.

7.7.2 Power vs Time

This section describes limitation of Power vs Time trace when Terminal is DigRF 3G. Refer to Section 4.3 “Power vs Time” for the setting not mentioned here, since it will be similar as when terminal is RF.

The display items for a Power vs Time trace are described below.

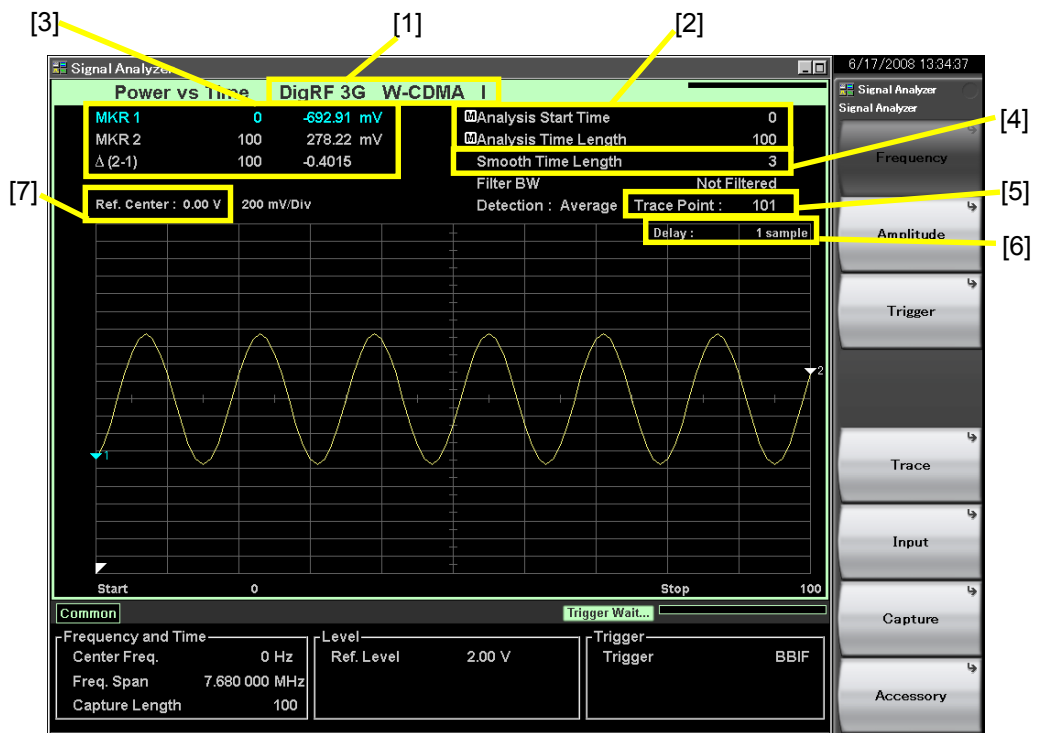

Figure 7.7.2-1 Display items for Power vs Time trace

Table 7.7.2-1 Display items for Power vs Time trace

No.	Display	Description
[1]	DigRF 3G W-CDMA I	Displays current Terminal, Target System, and Input Source.
[2]	Analysis Start Time/Analysis Time Length	Displays the analysis start time and analysis time length by sample unit.
[3]	MKR1/MKR2/ Δ (2-1)	Displays the Marker results and the Marker time location by sample unit.
[4]	Smooth Time Length	Displays the smoothing time length by sample unit when Smoothing is On.
[5]	Trace Point	Displays the trace point count (horizontal axis).
[6]	Delay	Displays delay time of results by sample unit.
[7]	Ref. Center	Displays the center of the vertical scale.

Note:

Under the following condition, result of following equation is displayed for the marker result value for Power vs Time trace.

$$\text{Marker [dBm]} = 10 \times [\log(F) + \log\{(20 \times a \times a)/(m \times m)\}]$$

- Marker [dBm]: Marker result value [dBm]
F: Minimum value for floating decimal point of 32 bits ($1.175494351 \times 10^{-38}$)
a: AD Full Range [V]
m: 127 (For the communication method is W-CDMA) or 32767 (For the communication method is GSM)
- Condition 1: When the reference level unit is dBm, dB μ V, dBmV, dB μ V (emf), or dB μ V/m
However, above equation needs to be converted when it is dB μ V, dBmV, dB μ V (emf), and dB μ V/m.
- Condition 2: When AD value for DigRF 3G signal is 0

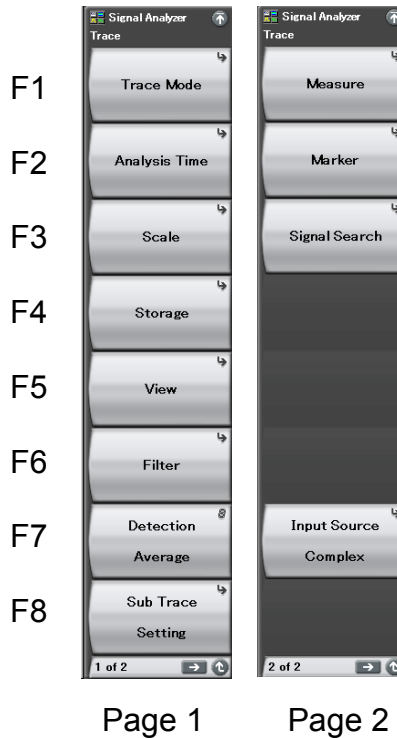

Figure 7.7.2-2 Trace function menu

Table 7.7.2-2 Trace function menu

Menu Display	Function
Trace Mode	Sets the trace type.
Analysis Time	Used for setting related to the analysis time.
Scale	Used for setting related to the scale.
Filter	Selects the filter type.
View	Sets the smoothing.
Sub Trace Setting	Used for setting related for sub-trace.
Measure	Used for setting related to the Measure function.
Marker	Used for setting related to the marker.
Input Source	Sets the analysis method of DigRF 3G signals.

Selecting trace

There are several limitations when Terminal is set to DigRF 3G. Refer to Section 7.7 “Selecting Trace” for details.

Setting analysis time

Sets either Auto or Manual setting of analysis time in sample units. Refer to Setting analysis time in Section 7.7.1 “Spectrum” for details.

Setting scale

The settings of value of the centered vertical scale are enabled when Terminal is DigRF 3G.

Example: To set the value of centered vertical scale to 100 mV.

<Procedure>

1. Press **F2** (Amplitude) on the main function menu.
2. Press **F6** (Scale).
3. Press **F1** (Scale Log/Lin) then select Lin.
4. Press **F5** (Trace) on the main function menu.
5. Press **F7** (Input Source) on page 2 of the Trace function menu.
6. Press **F2** (I) to set the Input Source to I phase.
7. Press **F3** (Scale) on the Trace function mane.
8. Press **F1** (Vertical) on the Scale function mane.
9. Press **F4** (Center) on the Vertical function mane.
10. Press **1**, **0**, **0**, and then press **F2** (mV) to set the value of centered vertical scale to 100 mV.

Setting storage mode

The settings of storage mode are the same as when Terminal is RF. Refer to Section 4.2.6 “Setting storage mode” for settings.

Setting filter

The setting range of the filter bandwidth varies when Terminal is DigRF 3G.

Alternatively, the setting range can be vary by the Target System.

Setting range and resolution for filter band

- Setting range : Refer to Table 7.7.2-3
Refer to Table 7.7.2-4
 - Minimum resolution : 1 kHz
 - Rotary knob resolution : $\frac{x}{100}$ Hz
 - Step key resolution : $\frac{x}{10}$ Hz
- x: Frequency span [Hz]

Table 7.7.2-3 Filter band setting range (Rect)

Target System	Sampling Rate	Minimum Value	Maximum Value
W-CDMA	7.68 MHz	120 kHz	3.657 MHz
GSM	541.666 kHz	9 kHz	257 kHz

Table 7.7.2-4 Filter band setting range (Gauss, Nyquist, Root Nyquist)

Target System	Sampling Rate	Minimum Value	Maximum Value
W-CDMA	7.68 MHz	120 kHz	1.536 MHz
GSM	541.666 kHz	9 kHz	109 kHz

Setting smoothing

Sets the Smoothing Time Length settings by sample unit when Terminal is DigRF 3G.

Example: To set the Smoothing function to On and to set the Smoothing Time Length to 1000.

<Procedure>

1. Press **F5** (Trace) on the main function menu.
2. Press **F5** (View).
3. Press **F1** (Smoothing On/Off) then select On.
4. Press **F2** (Smoothing Time Length).
5. Press **1**, and then press **F3** (ksample) to set the smoothing time length to 1000 sample.

Setting range and resolution for smoothing time length

Setting range	: 1 to 10000
Minimum resolution	: 1 sample
Rotary knob resolution	: 1 step at the highest 1st digit
Step key resolution	: 1-2-5 sequence

Setting detection mode

The settings of detection mode is common to when Terminal is RF. Refer to Section 4.2.7 “Setting detection mode” for settings.

Setting sub-trace

You cannot set Spectrogram when the terminal is DigRF 3G.

Setting Measure

You cannot set Standard when Terminal is DigRF 3G.

For other functions of measure setting is common to when Terminal is RF.

Refer to Section 4.2.10 “Measurement measure” for settings.



Setting markers

The unit of Marker display value is selectable when Terminal is DigRF 3G.

- (1) sample
Sets the unit of the Marker display value to sample.
- (2) second
Sets the unit of the Marker display value to second.

Example: To set the unit of the Marker display value to second.

<Procedure>

1. Press  (Trace) on the main function menu.
2. Press  (Marker) on page 2 in the Trace function menu.
3. Press  (Unit sample/second) on page 2 in the Marker function menu then selects second.

Setting marker search

The settings of marker search is common to when Terminal is RF. Refer to Section 4.2.9 “Setting marker search” for settings.



Setting input source

Sets the analysis method of DigRF 3G signals.

- (1) Complex
Analyze the multiple data of I phase and Q phase.
- (2) I
Analyzes only the data of I phase.
- (3) Q
Analyzes only the data of Q phase.

Example: To set the Input Source to I phase.

<Procedure>

1. Press  (Input Source) on page 2 of the Trace function menu.
2. Press  (I) to set the Input Source to I phase.

7.7.3 Frequency vs Time

This section describes limitation of Frequency vs Time trace when Terminal is DigRF 3G. Refer to Section 4.4 “Frequency vs Time” for the setting not mentioned here, since they are the same as when terminal is RF.

The display items for a Frequency vs Time trace are described below.

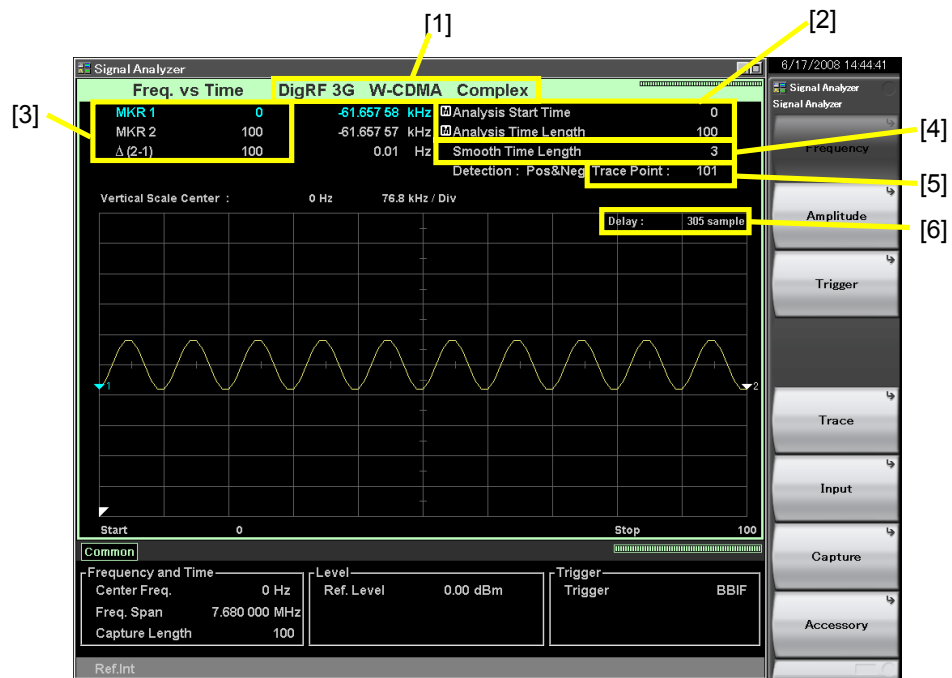

Figure 7.7.3-1 Display items for Frequency vs Time trace

Table 7.7.3-1 Display items for Frequency vs Time trace

No.	Display	Description
[1]	DigRF 3G W-CDMA Complex	Displays current Terminal, Target System, and Input Source.
[2]	Analysis Start Time/Analysis Time Length	Displays the analysis start time and analysis time length by sample unit.
[3]	MKR1/MKR2/ Δ(2-1)	Displays the Marker results and the Marker time location by sample unit.
[4]	Smooth Time Length	Displays the smoothing time length by sample unit when Smoothing is On.
[5]	Trace Point	Displays the trace point count (horizontal axis).
[6]	Delay	Displays delay time of results by sample unit.

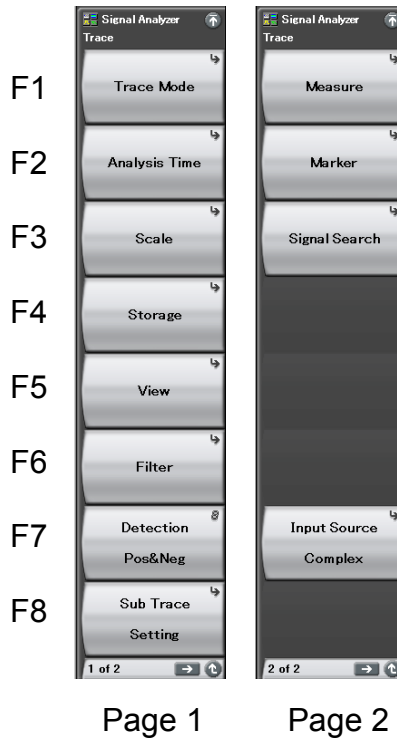

Figure 7.7.3-2 Trace function menu

Table 7.7.3-2 Trace function menu

Menu Display	Function
Trace Mode	Sets the trace type.
Analysis Time	Used for setting related to the analysis time.
Scale	Used for setting related to the scale.
Filter	Sets the filter.
View	Sets the smoothing.
Sub Trace Setting	Used for settings related to sub-trace.
Measure	Used for setting related to the Measure function.
Marker	Used for setting related to the marker.
Input Source	Sets the analysis method of DigRF 3G signals.

Selecting trace

There are several limitations of the selecting trace when Terminal is set DigRF 3G.

Refer to Section 7.7 “Selecting Trace” for details.

Setting analysis time

Sets either Auto or Manual setting of analysis time by sample unit.

Refer to the setting for analysis time in Section 7.7.1 “Spectrum” for details.

Setting scale

The settings of the frequency display range is enabled when Terminal is DigRF 3G. However, the display does not change by switching between Hz and ΔHz, since the center frequency is fixed to 0 Hz.

Example: To set the frequency display range to Frequency Span/2.

<Procedure>

1. Press **F3** (Scale) on the Trace function mane.
2. Press **F1** (Vertical) on the Scale function mane.
3. Press **F2** (Width), and then select **F1** (Span/2) to select the unit.

Setting storage mode

The settings of storage mode are the same as when Terminal is RF. Refer to Section 4.2.6 “Setting storage mode” for settings.

Setting filter type

The setting range of the filter bandwidth varies when Terminal is DigRF 3G.

Also, the setting range varies depending on the settings of Target System.

Setting range and resolution for filter band

Setting range : Refer to Table 7.7.3-3
 Rotary knob resolution : 1-3-10 sequence
 Step key resolution : 1-3-10 sequence

Table 7.7.3-3 Filter band setting range







Target System	Sampling Rate	Minimum Value	Maximum Value
W-CDMA	7.68 MHz	100 kHz	1 MHz
GSM	541.666 kHz	10 kHz	100 kHz

Setting smoothing

Sets the Smoothing Time Length settings in sample units when Terminal is DigRF 3G.

Example: To set the Smoothing function to On and to set the Smoothing Time Length to 1000.

<Procedure>

1. Press  (Trace) on the main function menu.
2. Press  (View).
3. Press  (Smoothing On/Off) then select On.
4. Press  (Smoothing Time Length).
5. Press , and then press  (ksample) to set the smoothing time length to 1000 sample.

Setting range and resolution for smoothing time length

Setting range	: 1 to 10000
Minimum resolution	: 1 sample
Rotary knob resolution	: 1 step at the highest 1st digit
Step key resolution	: 1-2-5 sequence

Setting detection mode

The settings of detection mode is common to when Terminal is RF. Refer to Section 4.2.7 “Setting detection mode” for settings.

Setting sub-trace

You cannot set Spectrogram when the terminal is set to DigRF 3G.

Setting Measure

You cannot set Standard when Terminal is DigRF 3G.

For other functions of measure setting is common to when Terminal is RF.

Refer to Section 4.2.10 “Measurement measure” for settings.



Setting markers

The unit of Marker display value is selectable when Terminal is DigRF 3G.

- (1) sample
Sets the unit of the Marker display value to sample.
- (2) second
Sets the unit of the Marker display value to second.

Example: To set the unit of the Marker display value to second.

<Procedure>

1. Press  (Trace) on the main function menu.
2. Press  (Marker) on page 2 of the Trace function menu.
3. Press  (Unit sample/second) on page 2 of the Marker function menu, and then select second.



Setting input source

Sets the analysis method of DigRF 3G signals.

- (1) Complex
Analyzes the multiple data of I phase and Q phase.
- (2) I
Analyzes only the data of I phase.
- (3) Q
Analyzes only the data of Q phase.

Example: To set the Input Source to I phase.

<Procedure>

1. Press  (Input Source) on page 2 of the Trace function menu.
2. Press  (I) to set the Input Source to I phase.

7.8 Saving IQ Data

This section describes limitations to saving IQ data when Terminal is DigRF 3G. Refer to Section 5.1 “Saving IQ Data” for the settings not mentioned here, since they are the same as when terminal is RF.

Press **F7** (Capture) on the main function menu, and then press **F3** (Save Captured Data) to display the Save Captured Data function menu.



Figure 7.8-1 Save Captured Data function menu

Table 7.8-1 Save Captured Data function menu

Menu Display	Function
Output Rate	Sets the rate of the output data.

Selecting location of files to be saved

Settings of the location of files to be saved are the same as when Terminal is RF.

Refer to Section 5.1 “Saving IQ Data” for details.

Setting output data rate

Settings for Output Rate cannot be configured because the sampling rate is fixed when the terminal is set to DigRF 3G. Alternatively, sampling rate is set to Output Rate.

Sampling rate

W-CDMA : 7.68 MHz

GSM : 541.666 kHz

Setting time range of IQ data to be saved

Start Time and Time Length are set in sample units.

Refer to Section 5.1 “Saving IQ data” for details.

Setting file name

Settings of the file names are the same as when Terminal is RF.

Refer to Section 5.1 “Saving IQ Data” for details.

Saving

Settings for saving are the same as when Terminal is RF.

Refer to Section 5.1 “Saving IQ Data” for details.

Closing the menu

Settings of the closing menu are the same as when Terminal is RF.

Refer to Section 5.1 “Saving IQ Data” for details.

7.8.1 Format of data information file

Information regarding the saved IQ data is stored in the data information file when the terminal is set to DigRF 3G. Table 7.8.1-1 shows the details of the recorded parameters.

Refer to Section 5.1.1 “Format of data information file” for the setting not mentioned here, since it will be similar as when terminal is RF.

Table 7.8.1-1 Format of data information file

Item	Description
Format	Data format It is fixed to "Float" in RF, but it will be either Int8 (W-CDMA) or Int16 (GSM) when set to DigRF 3G.
CenterFrequency	Center frequency [Hz] The center frequency is fixed to “0” when Terminal is DigRF 3G.
SpanFrequency	Frequency span [Hz] The frequency span is either 7.68 MHz (W-CDMA), or 541.666 kHz (GSM) when Terminal is DigRF 3G.
SamplingClock	Sampling rate [Hz] The sampling rate is either 7.68 MHz (W-CDMA), or 541.666 kHz (GSM) when Terminal is DigRF 3G.
TriggerSource	Trigger source “Video”: Video trigger “WideIF”: Wide IF video trigger “External”: External trigger “SGMarker”: SG marker trigger “BBIF”: BBIF trigger
IQReference0dBm	Reference IQ amplitude value representing 0 dBm It will be “***” when set to DigRF 3G.
Terminal	Signal Input Fixed to either “RF” or “DigRF 3G”.

7.8.2 Format of data file

The data file is created in binary format when Terminal is DigRF 3G. I phase data and Q phase data are recorded depending on the Target System, and those are recorded in either W-CDMA (Int8) or GSM (Int16).

- W-CDMA Digitizing Data Format

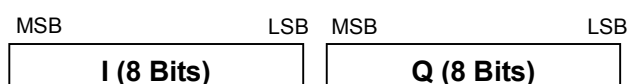

Figure 7.8.2-1 Format of W-CDMA data file

- GSM Digitizing Data Format

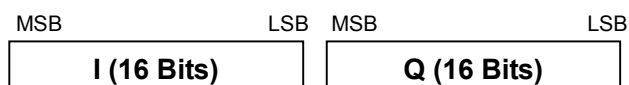



Figure 7.8.2-2 Format of GSM data file

7.9 System Setting

This section describes the limitations of setting system when Terminal is DigRF 3G. Refer to Chapter 6 “System Setting” for the settings not mentioned here, since they are the same as when terminal is RF.

Press  (Accessory) on the function menu to display the Accessory function menu.

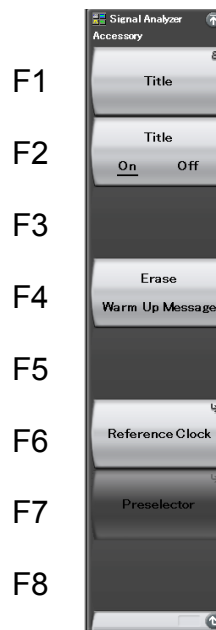

Figure 7.9-1 Accessory function menu

Table 7.9-1 Accessory function menu

Menu Display	Function
Preselector	Used for settings to tune the preselector.

Setting title

The settings of the title are the same as when Terminal is RF. Refer to Section 6.3 “Setting Title” for details.

Title display setting

The settings of the display title are the same as when Terminal is RF. Refer to Section 6.3 “Setting Title” for details.

Erasing warm up message

The settings of the erasing warm up message are the same as when Terminal is RF. Refer to Section 6.2 “Erasing Warm up Message” for details.

Adjusting Internal Reference Clock Signal

The settings of the Adjusting Internal Reference Clock Signal are the same as when Terminal is RF.

Refer to Section 6.4 “Adjusting Internal Reference Clock Signal” for details.

Setting preselector

Note:

The settings of this function is only enabled when the instrument is MS2691A or MS2692A and when Terminal is set to RF.

You cannot set Preselector when Terminal is DigRF 3G.

7.10 Default Value List

This section describes for the list of default values when Terminal is DigRF 3G. Refer to Appendix B “Default Value List” for the setting values not mentioned here, since they are the same as when Terminal is RF.

<Common parameters for all traces>

Frequency		
Center Frequency		0 Hz
Frequency Span		7.68 MHz
Start Frequency		-3.84 MHz
Stop Frequency		3.84 MHz
Trigger		
Trigger Source		BBIF
Capture		
Capture Time Length		100 sample
Input		
Terminal		RF
DigRF 3G Settings		
Target System		W-CDMA
AD Full Range		1.000 V
I/Q Sign		Sign + Abs.
Meas Channel		Primary
Input Source		Complex

<Spectrum trace>

Analysis Time		
Start		0 sample
Length		0 sample
Horizontal		
Center		0 Hz
Width		7.68 MHz
RBW		Auto, 30 kHz

Measure		
ACP		
	In Band Center	0 Hz
	Channel Power	
	Channel Center	0 Hz
Marker		
	Zone Center	0 Hz
	Zone Width	765.0 kHz

<Power vs Time trace>

Analysis Time		
	Start	0 sample
	Length	767998 sample
Filter		
	Band Width	3.657 MHz
View		
	Smoothing Time Length	Off, 16 sample
Time Detection		Average
Marker		
	Marker 1	On, 0 sample
	Marker 2	On, 767998 sample
Unit		sample
Vertical Center		***

<Frequency vs Time trace>

Analysis Time		
	Start	0 sample
	Length	767998 sample
Filter		
	Filter Bandwidth	1 MHz
View		
	Smoothing Time Length	Off, 16

Marker	
Marker 1	On, 0 sample
Marker 2	On, 767998 sample
Signal Search	
Threshold	
Frequency	768.0 kHz
Unit	sample
Vertical Center	***

Appendix A Error Message

Table A-1 Error Messages

Message	Description
Out of range	The settable range is exceeded.
Not available if not Vector Signal Generator option.	This operation is invalid when the vector signal generator option is not installed.
Not available if Zone Width is same as Zoom Width.	This operation is invalid when Zone Width is equal to Zoom Width.
Not available in Marker Off.	This operation is invalid in the Marker Off state.
Not available in Marker 1 or 2 Off.	This operation is invalid when either Marker1 or Marker2 is Off.
Not available in overlapping Marker 1 and Marker 2.	This operation is invalid when Marker1 and Marker2 overlap.
Not available if not Nyquist or Root Nyquist filter.	This operation is invalid when Nyquist filter or Root Nyquist filter is not selected.
Not available in Lin Scale.	This operation is invalid when Scale Mode is set to "Linear" (Lin scale).
Not available in Log Scale.	This operation is invalid when Scale Mode is set to "Log" (Log scale).
Not available if not executing storage.	This operation is invalid when storage is not being executed.
Not available in Trace Off.	This operation is invalid in the Trace Off state.
Not available in Free Run.	This operation is invalid in the Free Run state.
Not available in SG Marker Trigger.	This operation is invalid when SG Marker Trigger is used.
Not available if not re-capture after changing common parameter.	This operation is invalid when recapture is not executed after common parameter change.
Not available over the maximum number of characters.	This operation is invalid because the maximum number of characters has been exceeded.
Not available if not Pre-Amplifier option.	This operation is invalid when Option 008 Pre-Amplifier is not installed.
Not available unless Main Trace is Power vs Time.	This operation is invalid when the main trace is not Power vs Time.
Not available unless Main Trace is Frequency vs Time.	This operation is invalid when the main trace is not Frequency vs Time.
Not available unless Main Trace is CCDF.	This operation is invalid when the main trace is not CCDF.
Not available unless Main Trace is Spectrum or Frequency vs Time.	This operation is invalid when the main trace is not Spectrum or Frequency vs Time.
Not available unless Main Trace is Power vs Time or Frequency vs Time.	This operation is invalid when the main trace is not Power vs Time or Frequency vs Time.
Not available if Main Trace is CCDF or Phase vs Time or No Trace.	This operation is invalid when the main trace is not CCDF, Power vs Time, or No Trace.
Not available if Main Trace is CCDF or Spectrogram or No Trace.	This operation is invalid when the main trace is CCDF, Spectrogram or No Trace.
Not available if Main Trace is CCDF or Spectrogram or Phase vs Time or No Trace.	This operation is invalid when the main trace is CCDF, Spectrogram, Phase vs Time or No Trace.
Not available if Main Trace is Spectrum.	This operation is invalid when the main trace is Spectrum.

Table A-1 Error Messages (Cont'd)

Message	Description
Not available if Main Trace is CCDF or No Trace.	This operation is invalid when the main trace is CCDF or No Trace.
Not available unless Main Trace is Spectrum or CCDF.	This operation is invalid when the main trace is not Spectrum or CCDF.
Not available unless Main Trace is Power vs Time or CCDF.	This operation is invalid when the main trace is not Power vs Time or CCDF.
Not available if Main Trace is Spectrum or CCDF.	This operation is invalid when the main trace is Spectrum or CCDF.
Not available unless Main Trace is Spectrum or Power vs Time.	This operation is invalid when the main trace is not Spectrum or Power vs Time.
Not available under the minimum displaying frequency range.	This operation is invalid because the display frequency range will exceed the lower limit value.
Not available in Storage Mode Off.	This operation is invalid when Storage Mode is Off.
Not available over the maximum displaying time range.	This operation is invalid because the display frequency range will exceed the upper limit value.
Not available in Center Frequency under 1 kHz.	This operation is invalid because the center frequency is less than 1 kHz.
Not available in Measure Method APD.	This operation is invalid when Measure Method is set to APD.
Not available if not Storage Mode Off.	This operation is invalid when Storage Mode is not set to Off.
Not available if not executing Single measurement.	This operation is invalid when Single measurement is not performed.
Not available during measurement.	This operation is invalid during measurement.
Not available in Frequency Span 1kHz.	This operation is invalid when Frequency Span is set to 1 kHz.
Limited due to Capture Time.	The operation is limited due to Capture Time.
Not available if Zoom Width equals to Frequency Span.	This operation is invalid when Zoom Width is equal to Frequency Span.
Not available for invalid Digitizer parameter.	This operation is invalid because a digitize function parameter has an error.
Not available if not input save file name.	This operation is invalid when save file name is not input.
Not available in already saved the maximum number of files in the selected device.	This operation is invalid when the number of files already registered in the specified device has reached the maximum.
Not available because model name is not match.	This operation is invalid because the specified model name does not match.
Not available because option configuration is not match	This operation is invalid because the option configuration does not match.
Not available in Capture Time Manual.	This operation is invalid when Capture Time is set to Manual.
Reached to the Zoom limit.	The limit of Zoom is reached.
Reached to the Zoom Out limit.	The limit of Zoom Out is reached.

Table A-1 Error Messages (Cont'd)

Message	Description
Not available if not Pre-selector lower frequency expansion option.	This operation is invalid when the preselector lower frequency extension option is not installed.
Can not set under 4dB with Step Key and Encoder. Please Input with Numeric Key.	Use the numeric keypad when entering an attenuator less than 4 dB.
Not available when Save Captured Data isn't executed	This operation is invalid when Save Captured Data is not executed.
Unable to set when Analysis Start Time reached its limit	This operation is invalid when Analysis Start Time is set to the maximum.
Unable to set when Analysis Time Length reached its limit	This operation is invalid when Analysis Time Length is set to the maximum.
Invalid Button	Invalid key operation.
Not available when Detection isn't set to Pos&Neg	This operation is invalid when Detection is set to other than Pos&Neg.
Standard Parameter isn't found.	Standard parameter was not found.
Not available when Standard is set to OFF.	This operation is invalid when Standard is set to Off.
Not available when Capture Time is set to Auto.	This operation is invalid when Capture Time is set to Auto.
Search error	Search error
Disk is full.	Free disk capacity is insufficient.
Media not found.	Media was not found.
File not found.	File was not found.
Read/Write error.	Read/Write failed.
Format error.	Media is not converted into a format.
File Open error.	File Open failed.
File Close error.	File Close failed.
Unable to set any Digitizer parameter while waveform is read out.	It is unable to set any Digitizer parameter while waveform is read out.
Hardware setting failure.	Hardware setting failed.
Signal not found	No signal has been entered.
Not available in frequency band without the Preselector pass frequency band	It is not available while any band other than Preselector pass frequency band is used.
Not available during Save Captured Data.	It is not available while executing Save Captured Data.
Not available in ACP and Burst Average Power Off.	It is not available when ACP and Burst Average Power are set to Off.
Not available in ACP Off.	It is not available when ACP is set to Off.
Not available in Burst Average Power Off.	It is not available when Burst Average Power is set to Off.
Not available in Standard Off.	It is not available when Standard is set to Off.
Not available when unsupported Standard Parameter is selected.	Standard Parameter does not support the noise canceling function.
Not available when Load Standard Parameter isn't executed.	It is necessary to execute Load Standard Parameter.
Not available while executing Noise Measurement.	It cannot be changed or modified during noise measurement.

Table A-1 Error Messages (Cont'd)

Message	Description
Not available when ACP Reference is set to Span Total.	It is not available when ACP Reference is set to Span Total.
Not available when Freq. Span is 50MHz or more.	The setting is impossible when Freq. Span is 50 MHz or more.
Not available in Measure On.	The operation is invalid while Measure is set to On.
Not available in Zone Width Type Spot.	The operation is invalid while Zone Width Type is set to Spot.
Not available when active marker is set to Off or Fixed.	The operation is invalid while Active Marker is set to Off or Fixed.
The active marker cannot be set.	Active marker cannot be set.
The target marker cannot be set.	Target marker cannot be set.
Unable to return to Spectrogram.	It is unable to return to Spectrogram.
Not available in Marker Type Spot.	This operation is invalid when Marker Type is set to Spot.
Not available if Main Trace is CCDF or Spectrogram.	This operation is invalid when the main trace is CCDF or Spectrogram.
Not available if Main Trace is No Trace.	This operation is invalid when the main trace is No Trace.
Not available if Main Trace is Spectrum or Spectrogram or No Trace.	This operation is invalid when the main trace is Spectrum or Spectrogram or No Trace.
Not available when Analysis Start Time is set to 0 s, Analysis Time Length is set to 0 s, and Capture Time is set to Auto.	This operation is invalid when Analysis Start Time is 0 s, Analysis Time Length is 0 s , and Capture Time is Auto.
Not available if Main Trace is Spectrogram or No Trace.	This operation is invalid when the main trace is Spectrogram or No Trace.
Not available in RF Terminal.	This operation is invalid when Terminal is RF.
Not available if not RF Terminal.	This operation is invalid when Terminal is not RF.
Not available in DigRF 3G Terminal.	This operation is invalid when Terminal is DigRF 3G.
Not available if not DigRF 3G Terminal.	This operation is invalid when Terminal is not DigRF 3G.
Not available when Input Source is set to Complex.	This operation is invalid when Input Source is Complex.
Not Available in "Application Name" Application.	This operation is invalid when Application is "Application Name" status.
Not available if not Baseband Interface option.	This operation is invalid unless the Option 040 BBIF option is installed.
Unsupported SpanFrequency.	The frequency span is not supported.
Unsupported SamplingClock.	The sampling rate is not supported.
Unsupported Terminal.	The terminal is not supported.
Unsupported IQReverse.	The IQReverse is not supported.
Not available while executing replay function.	This operation is invalid while the Replay function is being executed.
Only available while replaying.	This operation is invalid unless the Replay function is executed.

Table A-1 Error Messages (Cont'd)

Message	Description
DGZ file error.	Loading an IQ data file has failed.
Selected item is empty.	There is no selectable file in this folder.
Unable to set Standard Parameter with different span while replaying.	Standard Parameter with a different span cannot be set while the Replay function is being executed.
Unable to set this Standard Parameter while replaying.	This standard parameter cannot be set while the Replay function is being executed.
Unable to set this Standard Parameter since Capture Time Length is short.	This Standard Parameter cannot be set since Capture Time Length is not sufficient.
Shortage of data samples in IQ data file	Analysis cannot be performed because the number of data samples of the IQ data file is less than the minimum number of data samples required for analysis.
Not available if Capture Time Length equals to zero.	This operation is invalid when Capture Time Length is 0.
Not available if Analysis Time Length equals to zero.	This operation is invalid when Analysis Time Length is 0.
Not available if Time Range is set to Full or Analysis Time.	This operation is invalid when Time Range is Full or Analysis Time.
Unable to set when Time Length reached its limit.	This operation is invalid when Time Length is set to the maximum.
Unable to set when Start Time reached its limit.	This operation is invalid when Start Time is set to the maximum.
Not available if Sub Trace is Off.	This operation is invalid when the sub trace is set to Off.
Not available unless Sub Trace is Off.	This operation is invalid unless the sub trace is set to Off.
Not available if Sub Trace is Spectrogram.	This operation is invalid when the sub trace is set to Spectrogram.
Not available unless Sub Trace is Spectrogram.	This operation is invalid unless the sub trace is set to Spectrogram.
Unable to set when Analysis Time Length (Sub Trace) reached its limit.	This operation is invalid when Analysis Time Length (Sub Trace) is set to the maximum.
Unable to set when Analysis Start Time (Sub Trace) reached its limit.	This operation is invalid when Analysis Start Time (Sub Trace) is set to the maximum.
Not available when CCDF Meas Mode is set to Time.	This operation is invalid when CDF Meas Mode is set to Time.
Not available when Gate Mode is set to Off.	This operation is invalid when the gate mode is set to Off.
Cannot set all Ranges to Off at the same time.	This operation cannot set all ranges to Off at the same time.
Not available if Phase Mode is wrap.	This operation is invalid when the phase mode is set to wrap.
Invalid character	—
Please Load Signal Generator.	To execute Playback, load the vector signal generator application.

Appendix B Default Value List

<Common parameters for all traces>

Frequency

Center Frequency	6 GHz
Frequency Span	31.25 MHz
Start Frequency	5.984375 GHz
Stop Frequency	6.015625 GHz
Step Size	1 GHz
Frequency Band Mode	Normal

Amplitude

Reference Level	0 dBm
Attenuator	Auto, 10 dB
Log Scale Unit	dBm
Scale Mode	Log
Reference Level Offset	Off, 0 dB
Pre-Amp	Off

Trigger

Trigger Switch	Off
Trigger Source	Video
Trigger Slope	Rise
Trigger Level (Video)	-40 dBm (Log) 60% (Lin)
Trigger Level (Wide IF Video)	-20 dBm
Trigger Delay	0 s

Trace

Trace Mode	Spectrum
------------	----------

Measure

Standard	Off
----------	-----

Capture

Capture Mode	Continuous
Capture Time	Auto
Capture Time Length	2 μ s
Save Captured Data	
Device	D
File Name	DigitizeYYMMDD_NN
Time Range	FULL

Replay

Device	D
Application	Signal Analyzer

Appendix B Default Value List

Capture & Playback

Package	Playback
Pattern Name	DigitizeYYYYMMDD_NNN
Burst	On
Burst Off Threshold	-40 dB
Minimum Burst Off Length	Time Length×10
Ramp	Off
Ramp Length	Time Length×10

Accessory

Title	On, "Signal Analyzer"
Reference Clock	Factory-adjusted value
Preselector	Factory-adjusted value

<Spectrum trace>

Analysis Time	
Auto/Manual	Auto
Start	0 s
Length	0 s
Scale	
Vertical	
Log Scale Division	10 dB/Div
Lin Scale Division	10%/Div
Log Scale Line	10
Horizontal	
Center	6 GHz
Width	31.25 MHz
Storage	
Mode	Off
Count	10
RBW	Auto, 100 kHz
Time Detection	Average
Measure	
ACP	
On/Off	Off
ACP Reference	Both Sides of Carriers
Offset Ch BW	3.84 MHz
Carrier BW	3.84 MHz
In Band Center	6 GHz
Carrier Spacing	5 MHz
Offset-1	On, 5 MHz
Offset-2	On, 10 MHz
Offset-3	Off, 15 MHz
In Band Filter Type	Root Nyquist
Offset Ch Filter Type	Root Nyquist
In Band Roll-off Factor	0.22
Offset Ch Roll-off Factor	0.22
Noise Cancel	Off
Result Type	Offset
Carrier Number	1

Appendix B Default Value List

Channel Power	
On/Off	Off
Channel Center	6 GHz
Channel Width	3.84 MHz
Filter Type	Root Nyquist
Roll-off Factor	0.22
OBW	
On/Off	Off
Method	N%
N% of Ratio	99%
XdB Value	25 dB
Marker	
Active Marker	Marker1
Zone Center	6 GHz
Zone Width	3.125 MHz
Marker Mode	Normal
Marker Result	Integration
Marker List	Off
Couple Zone	On
Spot Line	On
Relative to	Marker2 (Active Marker is 1) Marker3 (Active Marker is 2) Marker4 (Active Marker is 3) Marker5 (Active Marker is 4) Marker6 (Active Marker is 5) Marker7 (Active Marker is 6) Marker8 (Active Marker is 7) Marker9 (Active Marker is 8) Marker10 (Active Marker is 9) Marker1 (Active Marker is 10)
Signal Search	
Resolution	1 dB
Threshold	
On/Off	Off
Above/Below	Above
Level	-50 dBm
Search Peaks Number	10

<Power vs Time trace>

Analysis Time		
Auto/Manual		Auto
Start		0 s
Length		100 ms
Scale		
Vertical		
Log Scale Division		10 dB/Div
Lin Scale Division		10%/Div
Log Scale Line		10
Storage		
Mode		Off
Count		10
Filter		
Type		Off
Roll-off Factor		0.22
Band Width		5 MHz
Freq. Offset		0 Hz
View		
Smoothing Time Length		Off, 2 μ s
Time Detection		
		Average
Measure		
Burst Average Power		
On/Off		Off
Noise Cancel		Off
AM Depth		
On/Off		Off
Marker		
Marker 1		On, 0 s
Marker 2		On, 100 ms
Active Marker		1
Peak-Peak		Off
Signal Search		
Resolution		1 dB (Log) 1% (Lin)
Threshold		
On/Off		Off

Appendix B Default Value List

	Above/Below Level	Above -50 dBm
<Frequency vs Time trace>		
Analysis Time		
	Auto/Manual	Auto
	Start	0 s
	Length	100 ms
Scale		
	Vertical	
	Scale Unit	Hz
	Width	Span/5
Storage		
	Mode	Off
	Count	10
Filter		
	Auto/Manual	Auto
	Filter Bandwidth	10 MHz
View		
	Smoothing Time Length	Off, 2 μ s
	Time Detection	Pos&Neg
Marker		
	Marker 1	On, 0 s
	Marker 2	On, 100 ms
	Active Marker	1
	Peak-Peak	Off
	Detection Mode 1	Pos
	Detection Mode 2	Pos
Signal Search		
	Resolution	1 Hz
	Threshold	
	On/Off	Off
	Above/Below	Above
	Frequency	6 GHz
Measure		
	FM Deviation	
	On/Off	Off
	FM CW	

FM CW	Off
Measurement Interval	Auto
Meas Slope	Auto

<Phase vs Time trace>

Analysis Time	
Auto/Manual	Auto
Start	0 s
Length	100 ms
Scale	
Vertical	
Scale Division	36.00 deg/Div
Time Detection	Sample
Marker	
Marker 1	On, 0 s
Marker 2	On, 100 ms
Active Marker	1
Method	
Phase Offset	0.00 deg
Unwrap Phase	0s
Phase Mode	wrap

Appendix B Default Value List

<CCDF trace>

Analysis Time	
Auto/Manual	Auto
Start	0 s
Length	100 ms
Gate Mode	Off
Period	100 ms
Range Setup	
Edit Range Number 1	
Range	On
Start Time	0 s
Stop Time	100 ms
Edit Range Number 2	
Range	Off
Start Time	0 s
Stop Time	100 ms
Edit Range Number 3	
Range	Off
Start Time	0 s
Stop Time	100 ms
Scale	
Horizontal	20 dB
Storage	
Reset Every Capture	On
Filter	
Type	Off
Band Width	5 MHz
Freq. Offset	0 Hz
Method	
Measure Method	CCDF
Threshold On/Off	Off
Threshold	-170 dBm
CCDF Meas Mode	Time
Data Count	10000000
Marker	
Marker	On
Marker Axis	Dist
Distribution Position	10 dB
Probability Position	0.1%

<Spectrogram trace>

Analysis Time		
Auto/Manual		Auto
Start		0 s
Length		100 ms
Scale		
Level Full Scale		100 dB
Storage		
Mode		Off
Count		10
RBW		Auto, 100 kHz
Time Detection		Positive
Marker		
Active Marker		1
Marker On/Off		On
Zone Center		6 GHz
Zone Width		3.125 MHz
Time Marker 1		Analysis Start Time
Time Marker 2		Analysis Start Time+
		Analysis Time Length
Marker Type		Zone
Couple Time1 and 2		Off
Marker Result		Peak (Accuracy)

<No Trace trace>

Analysis Time		
Auto/Manual		Auto
Start		0 s
Length		100 ms

Appendix B Default Value List

<Sub Trace common parameter>

Trace Mode Off

<Power vs Time sub trace>

Analysis Time
 Auto/Manual Auto
 Start 0 s
 Length 100 ms

Scale
 Level Full Scale 100 dB

Time Detection Average

<Spectrogram sub trace>

Analysis Time
 Auto/Manual Auto
 Start 0 s
 Length 100 ms

Scale
 Level Full Scale 100 dB

RBW Auto, 100 kHz

Time Detection Positive

Appendix C Standard Parameter List

The parameters set by the standard functions are listed below.

C-1	ACP	C-2
	W-CDMA	C-2
	Mobile WiMAX	C-5
	LTE	C-7
	DSRC	C-20
	TD-SCDMA	C-21
	CDMA2000	C-27
	EV-DO	C-28
C-2	Channel Power	C-29
	W-CDMA	C-29
	Mobile WiMAX	C-30
	LTE	C-31
	LTE TDD	C-35
	DSRC/TD-SCDMA	C-39
	XG-PHS	C-40
	CDMA2000/EV-DO	C-41
	ISDB-Tmm	C-42
C-3	OBW	C-43
	W-CDMA/Mobile WiMAX	C-43
	LTE	C-44
	DSRC/TD-SCDMA	C-46
	XG-PHS	C-47
	CDMA2000/EV-DO	C-48
	ISDB-Tmm	C-49
C-4	Burst Average Power	C-50
	W-CDMA/Mobile WiMAX	C-50
	LTE	C-51
	DSRC/TD-SCDMA	C-55
	CDMA2000/EV-DO	C-56

C-1 ACP

W-CDMA

Table C-1 Standard parameters for ACP function

Standard	Parameter Name	Setting
W-CDMA Uplink	Frequency Span	25 MHz
	RBW	30 kHz
	Time Detection	Average
	Capture Time	Auto
	Analysis Start Time	0 s
	Analysis Time Length	10 ms
	Adjacent Channel Power	On
	ACP Reference	Carrier-1
	Carrier Number	1
	Carrier BW	3.84 MHz
	Carrier Spacing	5 MHz
	In Band Center	Center Frequency
	In Band Filter Type	Root Nyquist
	In Band Roll-off Factor	0.22
	Offset-1 On/Off	On
	Offset-2 On/Off	On
	Offset-3 On/Off	Off
	Offset Freq-1	5 MHz
	Offset Freq-2	10 MHz
	Offset Freq-3	15 MHz
Ch BW	3.84 MHz	
Offset Ch Filter Type	Root Nyquist	
Offset Ch Roll-off Factor	0.22	

Table C-1 Standard parameters for ACP function (Cont'd)

Standard	Parameter Name	Setting
W-CDMA Downlink (Single Carrier)	Frequency Span	25 MHz
	RBW	30 kHz
	Time Detection	Average
	Capture Time	Auto
	Analysis Start Time	0 s
	Analysis Time Length	10 ms
	Adjacent Channel Power	On
	ACP Reference	Carrier-1
	Carrier Number	1
	Carrier BW	3.84 MHz
	Carrier Spacing	5 MHz
	In Band Center	Center Frequency
	In Band Filter Type	Root Nyquist
	In Band Roll-off Factor	0.22
	Offset-1 On/Off	On
	Offset-2 On/Off	On
	Offset-3 On/Off	Off
	Offset Freq-1	5 MHz
	Offset Freq-2	10 MHz
	Offset Freq-3	15 MHz
Ch BW	3.84 MHz	
Offset Ch Filter Type	Root Nyquist	
Offset Ch Roll-off Factor	0.22	

Table C-1 Standard parameters for ACP function (Cont'd)

Standard	Parameter Name	Setting
W-CDMA Downlink (2 Carriers)	Frequency Span	31.25 MHz
	RBW	30 kHz
	Time Detection	Average
	Capture Time	Auto
	Analysis Start Time	0 s
	Analysis Time Length	10 ms
	Adjacent Channel Power	On
	ACP Reference	Both Sides of Carriers
	Carrier Number	2
	Carrier BW	3.84 MHz
	Carrier Spacing	5 MHz
	In Band Center	Center Frequency
	In Band Filter Type	Root Nyquist
	In Band Roll-off Factor	0.22
	Offset-1 On/Off	On
	Offset-2 On/Off	On
	Offset-3 On/Off	Off
	Offset Freq-1	5 MHz
	Offset Freq-2	10 MHz
	Offset Freq-3	15 MHz
Ch BW	3.84 MHz	
Offset Ch Filter Type	Root Nyquist	
Offset Ch Roll-off Factor	0.22	

Mobile WiMAX

Table C-1 Standard parameters for ACP function (Cont'd)

Standard	Parameter Name	Setting
Mobile WiMAX DL / UL 10 MHz BW	Frequency Span	31.25 MHz
	RBW	30 kHz
	Time Detection	Average
	Capture Time	Auto
	Analysis Start Time	0 s
	Analysis Time Length	5 ms
	Adjacent Channel Power	On
	ACP Reference	Carrier-1
	Carrier Number	1
	Carrier BW	9.5 MHz
	Carrier Spacing	10 MHz
	In Band Center	Center Frequency
	In Band Filter Type	Rect
	Offset – 1 On/Off	On
	Offset – 2 On/Off	On
	Offset – 3 On/Off	Off
	Offset Freq – 1	10 MHz
	Offset Freq – 2	20 MHz
	Offset Freq – 3	30 MHz
	Ch BW	9.5 MHz
Offset Ch Filter Type	Rect	

Table C-1 Standard parameters for ACP function (Cont'd)

Standard	Parameter Name	Setting
Mobile WiMAX DL / UL 5 MHz BW	Frequency Span	25 MHz
	RBW	30 kHz
	Time Detection	Average
	Capture Time	Auto
	Analysis Start Time	0 s
	Analysis Time Length	5 ms
	Adjacent Channel Power	On
	ACP Reference	Carrier-1
	Carrier Number	1
	Carrier BW	4.75 MHz
	Carrier Spacing	5 MHz
	In Band Center	Center Frequency
	In Band Filter Type	Rect
	Offset – 1 On/Off	On
	Offset – 2 On/Off	On
	Offset – 3 On/Off	Off
	Offset Freq – 1	5 MHz
	Offset Freq – 2	10 MHz
	Offset Freq – 3	15 MHz
	Ch BW	4.75 MHz
Offset Ch Filter Type	Rect	

LTE

Table C-1 Standard parameters for ACP function (Cont'd)

Standard	Parameter Name	Setting
LTE Uplink/ Downlink 1.4 MHz BW (UTRA 5 MHz)	Frequency Span	25 MHz
	RBW	10 kHz
	Time Detection	Average
	Capture Time	Auto
	Analysis Start Time	0 s
	Analysis Time Length	10 ms
	Adjacent Channel Power	On
	ACP Reference	Carrier Select
	Carrier Number	1
	Carrier BW	1.095 MHz (DL) 1.08 MHz (UL)
	Carrier Spacing	1.4 MHz
	In Band Center	Center Frequency
	In Band Filter Type	Rect
	In Band Roll-off Factor	0.22 (Disabled)
	Offset – 1 On/Off	On
	Offset – 2 On/Off	On
	Offset – 3 On/Off	Off
	Offset Freq – 1	3.2 MHz
	Offset Freq – 2	8.2 MHz
	Offset Freq – 3	13.2 MHz
Ch BW	3.84 MHz	
Offset Ch Filter Type	Root Nyquist	
Offset Ch Roll-off Factor	0.22	

Table C-1 Standard parameters for ACP function (Cont'd)

Standard	Parameter Name	Setting
LTE TDD Uplink/Downlink 1.4 MHz BW (UTRA 1.6 MHz)	Frequency Span	10 MHz
	RBW	10 kHz
	Time Detection	Average
	Capture Time	Auto
	Analysis Start Time	0 s
	Analysis Time Length	1 ms
	Adjacent Channel Power	On
	ACP Reference	Carrier Select
	Carrier Number	1
	Carrier BW	1.095 MHz (DL) 1.08 MHz (UL)
	Carrier Spacing	1.4 MHz
	In Band Center	Center Frequency
	In Band Filter Type	Rect
	Offset – 1 On/Off	On
	Offset – 2 On/Off	On
	Offset – 3 On/Off	Off
	Offset Freq – 1	1.5 MHz
	Offset Freq – 2	3.1 MHz
	Offset Freq – 3	4.7 MHz
	Ch BW	1.28 MHz
Offset Ch Filter Type	Root Nyquist	
Offset Ch Roll-off Factor	0.22	

Table C-1 Standard parameters for ACP function (Cont'd)

Standard	Parameter Name	Setting
LTE Uplink/ Downlink 1.4 MHz BW (E-UTRA 1.4 MHz)	Frequency Span	10 MHz
	RBW	10 kHz
	Time Detection	Average
	Capture Time	Auto
	Analysis Start Time	0 s
	Analysis Time Length	10 ms
	Adjacent Channel Power	On
	ACP Reference	Carrier Select
	Carrier Number	1
	Carrier BW	1.095 MHz (DL) 1.08 MHz (UL)
	Carrier Spacing	1.4 MHz
	In Band Center	Center Frequency
	In Band Filter Type	Rect
	In Band Roll-off Factor	0.22 (Disabled)
	Offset – 1 On/Off	On
	Offset – 2 On/Off	On
	Offset – 3 On/Off	Off
	Offset Freq – 1	1.4 MHz
	Offset Freq – 2	2.8 MHz
	Offset Freq – 3	4.2 MHz
Ch BW	1.095 MHz (DL) 1.08 MHz (UL)	
Offset Ch Filter Type	Rect	
Offset Ch Roll-off Factor	0.22 (Disabled)	

Table C-1 Standard parameters for ACP function (Cont'd)

Standard	Parameter Name	Setting
LTE TDD Uplink/Downlink 1.4 MHz BW (E-UTRA 1.4 MHz)	Frequency Span	10 MHz
	RBW	10 kHz
	Time Detection	Average
	Capture Time	Auto
	Analysis Start Time	0 s
	Analysis Time Length	1 ms
	Adjacent Channel Power	On
	ACP Reference	Carrier Select
	Carrier Number	1
	Carrier BW	1.095 MHz (DL) 1.08 MHz (UL)
	Carrier Spacing	1.4 MHz
	In Band Center	Center Frequency
	In Band Filter Type	Rect
	Offset – 1 On/Off	On
	Offset – 2 On/Off	On
	Offset – 3 On/Off	Off
	Offset Freq – 1	1.4 MHz
	Offset Freq – 2	2.8 MHz
	Offset Freq – 3	4.2 MHz
	Ch BW	1.095 MHz (DL) 1.08 MHz (UL)
Offset Ch Filter Type	Rect	

Table C-1 Standard parameters for ACP function (Cont'd)

Standard	Parameter Name	Setting
LTE Uplink/ Downlink 3 MHz BW (UTRA 5 MHz)	Frequency Span	25 MHz
	RBW	30 kHz
	Time Detection	Average
	Capture Time	Auto
	Analysis Start Time	0 s
	Analysis Time Length	10 ms
	Adjacent Channel Power	On
	ACP Reference	Carrier Select
	Carrier Number	1
	Carrier BW	2.715 MHz (DL) 2.7 MHz (UL)
	Carrier Spacing	3 MHz
	In Band Center	Center Frequency
	In Band Filter Type	Rect
	In Band Roll-off Factor	0.22 (Disabled)
	Offset – 1 On/Off	On
	Offset – 2 On/Off	On
	Offset – 3 On/Off	Off
	Offset Freq – 1	4 MHz
	Offset Freq – 2	9 MHz
	Offset Freq – 3	14 MHz
Ch BW	3.84 MHz	
Offset Ch Filter Type	Root Nyquist	
Offset Ch Roll-off Factor	0.22	

Table C-1 Standard parameters for ACP function (Cont'd)

Standard	Parameter Name	Setting
LTE TDD Uplink/Downlink 3 MHz BW (UTRA 1.6MHz)	Frequency Span	10 MHz
	RBW	30 kHz
	Time Detection	Average
	Capture Time	Auto
	Analysis Start Time	0 s
	Analysis Time Length	1 ms
	Adjacent Channel Power	On
	ACP Reference	Carrier Select
	Carrier Number	1
	Carrier BW	2.715 MHz (DL) 2.7 MHz (UL)
	Carrier Spacing	3 MHz
	In Band Center	Center Frequency
	In Band Filter Type	Rect
	Offset – 1 On/Off	On
	Offset – 2 On/Off	On
	Offset – 3 On/Off	Off
	Offset Freq – 1	2.3 MHz
	Offset Freq – 2	3.9 MHz
	Offset Freq – 3	5.5 MHz
	Ch BW	1.28 MHz
Offset Ch Filter Type	Root Nyquist	
Offset Ch Roll-off Factor	0.22	

Table C-1 Standard parameters for ACP function (Cont'd)

Standard	Parameter Name	Setting
LTE Uplink/ Downlink 3 MHz BW (E-UTRA 3 MHz)	Frequency Span	25 MHz
	RBW	30 kHz
	Time Detection	Average
	Capture Time	Auto
	Analysis Start Time	0 s
	Analysis Time Length	10 ms
	Adjacent Channel Power	On
	ACP Reference	Carrier Select
	Carrier Number	1
	Carrier BW	2.715 MHz (DL) 2.7 MHz (UL)
	Carrier Spacing	3 MHz
	In Band Center	Center Frequency
	In Band Filter Type	Rect
	In Band Roll-off Factor	0.22 (Disabled)
	Offset – 1 On/Off	On
	Offset – 2 On/Off	On
	Offset – 3 On/Off	Off
	Offset Freq – 1	3 MHz
	Offset Freq – 2	6 MHz
	Offset Freq – 3	9 MHz
Ch BW	2.715 MHz (DL) 2.7 MHz (UL)	
Offset Ch Filter Type	Rect	
Offset Ch Roll-off Factor	0.22 (Disabled)	

Table C-1 Standard parameters for ACP function (Cont'd)

Standard	Parameter Name	Setting
LTE TDD Uplink/Downlink 3 MHz BW (E-UTRA 3 MHz)	Frequency Span	25 MHz
	RBW	30 kHz
	Time Detection	Average
	Capture Time	Auto
	Analysis Start Time	0 s
	Analysis Time Length	1 ms
	Adjacent Channel Power	On
	ACP Reference	Carrier Select
	Carrier Number	1
	Carrier BW	2.715 MHz (DL) 2.7 MHz (UL)
	Carrier Spacing	3 MHz
	In Band Center	Center Frequency
	In Band Filter Type	Rect
	Offset – 1 On/Off	On
	Offset – 2 On/Off	On
	Offset – 3 On/Off	Off
	Offset Freq – 1	3 MHz
	Offset Freq – 2	6 MHz
	Offset Freq – 3	9 MHz
	Ch BW	2.715 MHz (DL) 2.7 MHz (UL)
Offset Ch Filter Type	Rect	

Table C-1 Standard parameters for ACP function (Cont'd)

Standard	Parameter Name	Setting
LTE Uplink/ Downlink 5 MHz BW (UTRA 5 MHz)	Frequency Span	25 MHz
	RBW	30 kHz
	Time Detection	Average
	Capture Time	Auto
	Analysis Start Time	0 s
	Analysis Time Length	10 ms
	Adjacent Channel Power	On
	ACP Reference	Carrier Select
	Carrier Number	1
	Carrier BW	4.515 MHz (DL) 4.5 MHz (UL)
	Carrier Spacing	5 MHz
	In Band Center	Center Frequency
	In Band Filter Type	Rect
	In Band Roll-off Factor	0.22 (Disabled)
	Offset – 1 On/Off	On
	Offset – 2 On/Off	On
	Offset – 3 On/Off	Off
	Offset Freq – 1	5 MHz
	Offset Freq – 2	10 MHz
	Offset Freq – 3	15 MHz
Ch BW	3.84 MHz	
Offset Ch Filter Type	Root Nyquist	
Offset Ch Roll-off Factor	0.22	

Table C-1 Standard parameters for ACP function (Cont'd)

Standard	Parameter Name	Setting
LTE TDD Uplink/Downlink 5 MHz BW (UTRA 1.6 MHz)	Frequency Span	25 MHz
	RBW	30 kHz
	Time Detection	Average
	Capture Time	Auto
	Analysis Start Time	0 s
	Analysis Time Length	1 ms
	Adjacent Channel Power	On
	ACP Reference	Carrier Select
	Carrier Number	1
	Carrier BW	4.515 MHz (DL) 4.5 MHz (UL)
	Carrier Spacing	5 MHz
	In Band Center	Center Frequency
	In Band Filter Type	Rect
	Offset – 1 On/Off	On
	Offset – 2 On/Off	On
	Offset – 3 On/Off	Off
	Offset Freq – 1	3.3 MHz
	Offset Freq – 2	4.9 MHz
	Offset Freq – 3	6.5 MHz
	Ch BW	1.28 MHz
Offset Ch Filter Type	Root Nyquist	
Offset Ch Roll-off Factor	0.22	

Table C-1 Standard parameters for ACP function (Cont'd)

Standard	Parameter Name	Setting
LTE TDD Downlink 5 MHz BW (UTRA 5 MHz)	Frequency Span	25 MHz
	RBW	30 kHz
	Time Detection	Average
	Capture Time	Auto
	Analysis Start Time	0 s
	Analysis Time Length	1 ms
	Adjacent Channel Power	On
	ACP Reference	Carrier Select
	Carrier Number	1
	Carrier BW	4.515 MHz
	Carrier Spacing	5 MHz
	In Band Center	Center Frequency
	In Band Filter Type	Rect
	Offset – 1 On/Off	On
	Offset – 2 On/Off	On
	Offset – 3 On/Off	Off
	Offset Freq – 1	5 MHz
	Offset Freq – 2	10 MHz
	Offset Freq – 3	15 MHz
	Ch BW	3.84 MHz
Offset Ch Filter Type	Root Nyquist	
Offset Ch Roll-off Factor	0.22	

Table C-1 Standard parameters for ACP function (Cont'd)

Standard	Parameter Name	Setting
LTE Uplink/ Downlink 5 MHz BW (E-UTRA 5 MHz)	Frequency Span	25 MHz
	RBW	30 kHz
	Time Detection	Average
	Capture Time	Auto
	Analysis Start Time	0 s
	Analysis Time Length	10 ms
	Adjacent Channel Power	On
	ACP Reference	Carrier Select
	Carrier Number	1
	Carrier BW	4.515 MHz (DL) 4.5 MHz (UL)
	Carrier Spacing	5 MHz
	In Band Center	Center Frequency
	In Band Filter Type	Rect
	In Band Roll-off Factor	0.22 (Disabled)
	Offset – 1 On/Off	On
	Offset – 2 On/Off	On
	Offset – 3 On/Off	Off
	Offset Freq – 1	5 MHz
	Offset Freq – 2	10 MHz
	Offset Freq – 3	15 MHz
Ch BW	4.515 MHz (DL) 4.5 MHz (UL)	
Offset Ch Filter Type	Rect	
Offset Ch Roll-off Factor	0.22 (Disabled)	

Table C-1 Standard parameters for ACP function (Cont'd)

Standard	Parameter Name	Setting
LTE TDD Uplink/Downlink 5 MHz BW (E-UTRA 5 MHz)	Frequency Span	25 MHz
	RBW	30 kHz
	Time Detection	Average
	Capture Time	Auto
	Analysis Start Time	0 s
	Analysis Time Length	1 ms
	Adjacent Channel Power	On
	ACP Reference	Carrier Select
	Carrier Number	1
	Carrier BW	4.515 MHz (DL) 4.5 MHz (UL)
	Carrier Spacing	5 MHz
	In Band Center	Center Frequency
	In Band Filter Type	Rect
	Offset – 1 On/Off	On
	Offset – 2 On/Off	On
	Offset – 3 On/Off	Off
	Offset Freq – 1	5 MHz
	Offset Freq – 2	10 MHz
	Offset Freq – 3	15 MHz
	Ch BW	4.515 MHz (DL) 4.5 MHz (UL)
Offset Ch Filter Type	Rect	

DSRC

Table C-1 Standard parameters for ACP function (Cont'd)

Standard	Parameter Name	Setting
DSRC $\pi/4$ DQPSK/ASK	Frequency Span	25 MHz
	RBW	30 kHz
	Time Detection	Positive
	Capture Time	Auto
	Analysis Start Time	0 s
	Analysis Time Length	7.032 ms
	Adjacent Channel Power	On
	ACP Reference	Carrier Select
	Carrier Number	1
	Carrier BW	4.4 MHz
	Carrier Spacing	5 MHz
	In Band Center	Center Frequency
	In Band Filter Type	Rect
	In Band Roll Off Ratio	0.22
	Offset – 1 On/Off	On
	Offset – 2 On/Off	On
	Offset – 3 On/Off	Off
	Offset Freq – 1	5 MHz
	Offset Freq – 2	10 MHz
	Offset Freq – 3	15 MHz
Ch BW	4.4 MHz	
Offset Ch Filter Type	Rect	
Offset Roll Off Ratio	0.22	

TD-SCDMA

Table C-1 Standard parameters for ACP function (Cont'd)

Standard	Parameter Name	Setting
TD-SCDMA 1 Carrier	Frequency Span	10 MHz
	RBW	30 kHz
	Time Detection	Average
	Capture Time	Auto
	Analysis Start Time	0 s
	Adjacent Channel Power	On
	ACP Reference	Carrier Select
	Carrier Number	1
	Carrier BW	1.28 MHz
	Carrier Spacing	1.6 MHz
	In Band Center	Center Frequency
	In Band Filter Type	Rect
	Offset – 1 On/Off	On
	Offset – 2 On/Off	On
	Offset – 3 On/Off	Off
	Offset Freq – 1	1.6 MHz
	Offset Freq – 2	3.2 MHz
	Offset Freq – 3	4.8 MHz
	Ch BW	1.28 MHz
Offset Ch Filter Type	Root Nyquist	
Offset Roll Off Ratio	0.22	

Table C-1 Standard parameters for ACP function (Cont'd)

Standard	Parameter Name	Setting
TD-SCDMA 2 Carrier	Frequency Span	10 MHz
	RBW	30 kHz
	Time Detection	Average
	Capture Time	Auto
	Analysis Start Time	0 s
	Adjacent Channel Power	On
	ACP Reference	Carrier Select
	Carrier Number	2
	Carrier BW	1.28 MHz
	Carrier Spacing	1.6 MHz
	In Band Center	Center Frequency
	In Band Filter Type	Rect
	Offset – 1 On/Off	On
	Offset – 2 On/Off	On
	Offset – 3 On/Off	Off
	Offset Freq – 1	1.6 MHz
	Offset Freq – 2	3.2 MHz
	Offset Freq – 3	4.8 MHz
	Ch BW	1.28 MHz
Offset Ch Filter Type	Root Nyquist	
Offset Roll Off Ratio	0.22	

Table C-1 Standard parameters for ACP function (Cont'd)

Standard	Parameter Name	Setting
TD-SCDMA 3 Carrier	Frequency Span	25 MHz
	RBW	30 kHz
	Time Detection	Average
	Capture Time	Auto
	Analysis Start Time	0 s
	Adjacent Channel Power	On
	ACP Reference	Carrier Select
	Carrier Number	3
	Carrier BW	1.28 MHz
	Carrier Spacing	1.6 MHz
	In Band Center	Center Frequency
	In Band Filter Type	Rect
	Offset – 1 On/Off	On
	Offset – 2 On/Off	On
	Offset – 3 On/Off	Off
	Offset Freq – 1	1.6 MHz
	Offset Freq – 2	3.2 MHz
	Offset Freq – 3	4.8 MHz
	Ch BW	1.28 MHz
Offset Ch Filter Type	Root Nyquist	
Offset Roll Off Ratio	0.22	

Table C-1 Standard parameters for ACP function (Cont'd)

Standard	Parameter Name	Setting
TD-SCDMA 4 Carrier	Frequency Span	25 MHz
	RBW	30 kHz
	Time Detection	Average
	Capture Time	Auto
	Analysis Start Time	0 s
	Adjacent Channel Power	On
	ACP Reference	Carrier Select
	Carrier Number	4
	Carrier BW	1.28 MHz
	Carrier Spacing	1.6 MHz
	In Band Center	Center Frequency
	In Band Filter Type	Rect
	Offset – 1 On/Off	On
	Offset – 2 On/Off	On
	Offset – 3 On/Off	Off
	Offset Freq – 1	1.6 MHz
	Offset Freq – 2	3.2 MHz
	Offset Freq – 3	4.8 MHz
	Ch BW	1.28 MHz
Offset Ch Filter Type	Root Nyquist	
Offset Roll Off Ratio	0.22	

Table C-1 Standard parameters for ACP function (Cont'd)

Standard	Parameter Name	Setting
TD-SCDMA 5 Carrier	Frequency Span	25 MHz
	RBW	30 kHz
	Time Detection	Average
	Capture Time	Auto
	Analysis Start Time	0 s
	Adjacent Channel Power	On
	ACP Reference	Carrier Select
	Carrier Number	5
	Carrier BW	1.28 MHz
	Carrier Spacing	1.6 MHz
	In Band Center	Center Frequency
	In Band Filter Type	Rect
	Offset – 1 On/Off	On
	Offset – 2 On/Off	On
	Offset – 3 On/Off	Off
	Offset Freq – 1	1.6 MHz
	Offset Freq – 2	3.2 MHz
	Offset Freq – 3	4.8 MHz
	Ch BW	1.28 MHz
Offset Ch Filter Type	Root Nyquist	
Offset Roll Off Ratio	0.22	

Table C-1 Standard parameters for ACP function (Cont'd)

Standard	Parameter Name	Setting
TD-SCDMA 6 Carrier	Frequency Span	25 MHz
	RBW	30 kHz
	Time Detection	Average
	Capture Time	Auto
	Analysis Start Time	0 s
	Adjacent Channel Power	On
	ACP Reference	Carrier Select
	Carrier Number	6
	Carrier BW	1.28 MHz
	Carrier Spacing	1.6 MHz
	In Band Center	Center Frequency
	In Band Filter Type	Rect
	Offset – 1 On/Off	On
	Offset – 2 On/Off	On
	Offset – 3 On/Off	Off
	Offset Freq – 1	1.6 MHz
	Offset Freq – 2	3.2 MHz
	Offset Freq – 3	4.8 MHz
	Ch BW	1.28 MHz
	Offset Ch Filter Type	Root Nyquist
Offset Roll Off Ratio	0.22	

CDMA2000

Table C-1 Standard parameters for ACP function (Cont'd)

Standard	Parameter Name	Setting
CDMA2000 Forward Link	Frequency Span	5 MHz
	RBW	30 kHz
	Time Detection	Average
	Capture Time	Auto
	Analysis Start Time	0 s
	Analysis Time Length	1.25 ms
	Adjacent Channel Power	On
	ACP Reference	Carrier-1
	Carrier Number	1
	Carrier BW	1.23 MHz
	Carrier Spacing	1.25 MHz
	In Band Center	Center Frequency
	In Band Filter Type	Rect
	Offset – 1 On/Off	On
	Offset – 2 On/Off	On
	Offset – 3 On/Off	Off
	Offset Freq – 1	765 kHz
	Offset Freq – 2	1.995 MHz
	Offset Freq – 3	4 MHz
	Ch BW	30 kHz
Offset Ch Filter Type	Rect	

EV-DO

Table C-1 Standard parameters for ACP function (Cont'd)

Standard	Parameter Name	Setting
EV-DO Forward Link	Frequency Span	5 MHz
	RBW	30 kHz
	Time Detection	Average
	Capture Time	Auto
	Analysis Start Time	0 s
	Analysis Time Length	1.666667 ms
	Adjacent Channel Power	On
	ACP Reference	Carrier-1
	Carrier Number	1
	Carrier BW	1.23 MHz
	Carrier Spacing	1.25 MHz
	In Band Center	Center Frequency
	In Band Filter Type	Rect
	Offset – 1 On/Off	On
	Offset – 2 On/Off	On
	Offset – 3 On/Off	Off
	Offset Freq – 1	765 kHz
	Offset Freq – 2	1.995 MHz
	Offset Freq – 3	4 MHz
	Ch BW	30 kHz
Offset Ch Filter Type	Rect	

C-2 Channel Power

W-CDMA

Table C-2 Standard parameters for channel power function

Standard	Parameter Name	Setting
W-CDMA Uplink/Downlink (Mean Power)	Frequency Span	10 MHz
	RBW	Auto
	Time Detection	Average
	Capture Time	Auto
	Analysis Start Time	0 s
	Analysis Time Length	10 ms
	Channel Power	On
	Channel Center	Center Frequency
	Channel Width	5 MHz
	Filter Type	Rect
W-CDMA Uplink/Downlink (RRC Filtered Power)	Frequency Span	10 MHz
	RBW	Auto
	Time Detection	Average
	Capture Time	Auto
	Analysis Start Time	0 s
	Analysis Time Length	10 ms
	Channel Power	On
	Channel Center	Center Frequency
	Channel Width	3.84 MHz
	Filter Type	Root Nyquist
	Filter Roll-off Factor	0.22

Mobile WiMAX

Table C-2 Standard parameters for channel power function (Cont'd)

Standard	Parameter Name	Setting
Mobile WiMAX DL / UL 10 MHz BW	Frequency Span	31.25 MHz
	RBW	Auto
	Time Detection	Average
	Capture Time	Auto
	Analysis Start Time	0 s
	Analysis Time Length	5 ms
	Channel Power	On
	Channel Center	Center Frequency
	Channel Width	10 MHz
	Filter Type	Rect
Mobile WiMAX DL / UL 5 MHz BW	Frequency Span	10 MHz
	RBW	Auto
	Time Detection	Average
	Capture Time	Auto
	Analysis Start Time	0 s
	Analysis Time Length	5 ms
	Channel Power	On
	Channel Center	Center Frequency
	Channel Width	5 MHz
	Filter Type	Rect

LTE

Table C-2 Standard parameters for channel power function (Cont'd)

Standard	Parameter Name	Setting
LTE Uplink/Downlink Mean Power 1.4 MHz BW	Frequency Span	5 MHz
	RBW	Auto
	Time Detection	Average
	Capture Time	Auto
	Analysis Start Time	0 s
	Analysis Time Length	10 ms
	Channel Power	On
	Channel Center	Center Frequency
	Channel Width	1.4 MHz
LTE Uplink/Downlink Mean Power 3 MHz BW	Filter Type	Rect
	Frequency Span	10 MHz
	RBW	Auto
	Time Detection	Average
	Capture Time	Auto
	Analysis Start Time	0 s
	Analysis Time Length	10 ms
	Channel Power	On
	Channel Center	Center Frequency
LTE Uplink/Downlink Mean Power 5 MHz BW	Channel Width	3 MHz
	Filter Type	Rect
	Frequency Span	10 MHz
	RBW	Auto
	Time Detection	Average
	Capture Time	Auto
	Analysis Start Time	0 s
	Analysis Time Length	10 ms
	Channel Power	On
Channel Center	Center Frequency	
Channel Width	5 MHz	
Filter Type	Rect	

Table C-2 Standard parameters for channel power function (Cont'd)

Standard	Parameter Name	Setting
LTE Uplink/Downlink Mean Power 10 MHz BW	Frequency Span	25 MHz
	RBW	Auto
	Time Detection	Average
	Capture Time	Auto
	Analysis Start Time	0 s
	Analysis Time Length	10 ms
	Channel Power	On
	Channel Center	Center Frequency
	Channel Width	10 MHz
Filter Type	Rect	
LTE Uplink/Downlink Mean Power 15 MHz BW	Frequency Span	31.25 MHz
	RBW	Auto
	Time Detection	Average
	Capture Time	Auto
	Analysis Start Time	0 s
	Analysis Time Length	10 ms
	Channel Power	On
	Channel Center	Center Frequency
	Channel Width	15 MHz
Filter Type	Rect	
LTE Uplink/Downlink Mean Power 20 MHz BW	Frequency Span	31.25 MHz
	RBW	Auto
	Time Detection	Average
	Capture Time	Auto
	Analysis Start Time	0 s
	Analysis Time Length	10 ms
	Channel Power	On
	Channel Center	Center Frequency
	Channel Width	20 MHz
Filter Type	Rect	

Table C-2 Standard parameters for channel power function (Cont'd)

Standard	Parameter Name	Setting
LTE Uplink/ Downlink Filtered Power 1.4 MHz BW	Frequency Span	5 MHz
	RBW	Auto
	Time Detection	Average
	Capture Time	Auto
	Analysis Start Time	0 s
	Analysis Time Length	10 ms
	Channel Power	On
	Channel Center	Center Frequency
	Channel Width	1.095 MHz (DL) 1.08 MHz (UL)
	Filter Type	Rect
LTE Uplink/ Downlink Filtered Power 3 MHz BW	Frequency Span	10 MHz
	RBW	Auto
	Time Detection	Average
	Capture Time	Auto
	Analysis Start Time	0 s
	Analysis Time Length	10 ms
	Channel Power	On
	Channel Center	Center Frequency
	Channel Width	2.715 MHz (DL) 2.7 MHz (UL)
	Filter Type	Rect
LTE Uplink/Downlink Filtered Power 5 MHz BW	Frequency Span	10 MHz
	RBW	Auto
	Time Detection	Average
	Capture Time	Auto
	Analysis Start Time	0 s
	Analysis Time Length	10 ms
	Channel Power	On
	Channel Center	Center Frequency
	Channel Width	4.515 MHz (DL) 4.5 MHz (UL)
	Filter Type	Rect

Table C-2 Standard parameters for channel power function (Cont'd)

Standard	Parameter Name	Setting
LTE Uplink/ Downlink Filtered Power 10 MHz BW	Frequency Span	25 MHz
	RBW	Auto
	Time Detection	Average
	Capture Time	Auto
	Analysis Start Time	0 s
	Analysis Time Length	10 ms
	Channel Power	On
	Channel Center	Center Frequency
	Channel Width	9.015 MHz (DL) 9 MHz (UL)
	Filter Type	Rect
LTE Uplink/ Downlink Filtered Power 15 MHz BW	Frequency Span	31.25 MHz
	RBW	Auto
	Time Detection	Average
	Capture Time	Auto
	Analysis Start Time	0 s
	Analysis Time Length	10 ms
	Channel Power	On
	Channel Center	Center Frequency
	Channel Width	13.515 MHz (DL) 13.5 MHz (UL)
	Filter Type	Rect
LTE Uplink/ Downlink Filtered Power 20 MHz BW	Frequency Span	31.25 MHz
	RBW	Auto
	Time Detection	Average
	Capture Time	Auto
	Analysis Start Time	0 s
	Analysis Time Length	10 ms
	Channel Power	On
	Channel Center	Center Frequency
	Channel Width	18.015 MHz (DL) 18 MHz (UL)
	Filter Type	Rect

LTE TDD

Table C-2 Standard parameters for channel power function (Cont'd)

Standard	Parameter Name	Setting
LTE TDD Uplink/Downlink Mean Power 1.4 MHz BW	Frequency Span	5 MHz
	RBW	Auto
	Time Detection	Average
	Capture Time	Auto
	Analysis Start Time	0 s
	Analysis Time Length	1 ms
	Channel Power	On
	Channel Center	Center Frequency
	Channel Width	1.4 MHz
	Filter Type	Rect
LTE TDD Uplink/Downlink Mean Power 3 MHz BW	Frequency Span	10 MHz
	RBW	Auto
	Time Detection	Average
	Capture Time	Auto
	Analysis Start Time	0 s
	Analysis Time Length	1 ms
	Channel Power	On
	Channel Center	Center Frequency
	Channel Width	3 MHz
	Filter Type	Rect
LTE TDD Uplink/Downlink Mean Power 5 MHz BW	Frequency Span	10 MHz
	RBW	Auto
	Time Detection	Average
	Capture Time	Auto
	Analysis Start Time	0 s
	Analysis Time Length	1 ms
	Channel Power	On
	Channel Center	Center Frequency
	Channel Width	5 MHz
	Filter Type	Rect

Table C-2 Standard parameters for channel power function (Cont'd)

Standard	Parameter Name	Setting
LTE TDD Uplink/Downlink Mean Power 10 MHz BW	Frequency Span	25 MHz
	RBW	Auto
	Time Detection	Average
	Capture Time	Auto
	Analysis Start Time	0 s
	Analysis Time Length	1 ms
	Channel Power	On
	Channel Center	Center Frequency
	Channel Width	10 MHz
	Filter Type	Rect
LTE TDD Uplink/Downlink Mean Power 15 MHz BW	Frequency Span	31.25 MHz
	RBW	Auto
	Time Detection	Average
	Capture Time	Auto
	Analysis Start Time	0 s
	Analysis Time Length	1 ms
	Channel Power	On
	Channel Center	Center Frequency
	Channel Width	15 MHz
	Filter Type	Rect
LTE TDD Uplink/Downlink Mean Power 20 MHz BW	Frequency Span	31.25 MHz
	RBW	Auto
	Time Detection	Average
	Capture Time	Auto
	Analysis Start Time	0 s
	Analysis Time Length	1 ms
	Channel Power	On
	Channel Center	Center Frequency
	Channel Width	20 MHz
	Filter Type	Rect

Table C-2 Standard parameters for channel power function (Cont'd)

Standard	Parameter Name	Setting
LTE TDD Uplink/Downlink Filtered Power 1.4 MHz BW	Frequency Span	5 MHz
	RBW	Auto
	Time Detection	Average
	Capture Time	Auto
	Analysis Start Time	0 s
	Analysis Time Length	1 ms
	Channel Power	On
	Channel Center	Center Frequency
	Channel Width	1.095 MHz (DL) 1.08 MHz (UL)
Filter Type	Rect	
LTE TDD Uplink/Downlink Filtered Power 3 MHz BW	Frequency Span	10 MHz
	RBW	Auto
	Time Detection	Average
	Capture Time	Auto
	Analysis Start Time	0 s
	Analysis Time Length	1 ms
	Channel Power	On
	Channel Center	Center Frequency
	Channel Width	2.715 MHz (DL) 2.7 MHz (UL)
Filter Type	Rect	
LTE TDD Uplink/Downlink Filtered Power 5 MHz BW	Frequency Span	10 MHz
	RBW	Auto
	Time Detection	Average
	Capture Time	Auto
	Analysis Start Time	0 s
	Analysis Time Length	1 ms
	Channel Power	On
	Channel Center	Center Frequency
	Channel Width	4.515 MHz (DL) 4.5 MHz (UL)
Filter Type	Rect	

Table C-2 Standard parameters for channel power function (Cont'd)

Standard	Parameter Name	Setting
LTE TDD Uplink/Downlink Filtered Power 10 MHz BW	Frequency Span	25 MHz
	RBW	Auto
	Time Detection	Average
	Capture Time	Auto
	Analysis Start Time	0 s
	Analysis Time Length	1 ms
	Channel Power	On
	Channel Center	Center Frequency
	Channel Width	9.015 MHz (DL) 9 MHz (UL)
Filter Type	Rect	
LTE TDD Uplink/Downlink Filtered Power 15 MHz BW	Frequency Span	31.25 MHz
	RBW	Auto
	Time Detection	Average
	Capture Time	Auto
	Analysis Start Time	0 s
	Analysis Time Length	1 ms
	Channel Power	On
	Channel Center	Center Frequency
	Channel Width	13.515 MHz (DL) 13.5 MHz (UL)
Filter Type	Rect	
LTE TDD Uplink/Downlink Filtered Power 20 MHz BW	Frequency Span	31.25 MHz
	RBW	Auto
	Time Detection	Average
	Capture Time	Auto
	Analysis Start Time	0 s
	Analysis Time Length	1 ms
	Channel Power	On
	Channel Center	Center Frequency
	Channel Width	18.015 MHz (DL) 18 MHz (UL)
Filter Type	Rect	

DSRC/TD-SCDMA

Table C-2 Standard parameters for channel power function (Cont'd)

Standard	Parameter Name	Setting
DSRC $\pi/4$ DQPSK	Frequency Span	10 MHz
	RBW	Auto
	Time Detection	Average
	Capture Time	Auto
	Analysis Start Time	0 s
	Analysis Time Length	7.032 ms
	Channel Power	On
	Channel Center	Center Frequency
	Channel Width	4.4 MHz
	Filter Type	Rect
DSRC ASK	Frequency Span	10 MHz
	RBW	Auto
	Time Detection	Positive
	Capture Time	Auto
	Analysis Start Time	0 s
	Analysis Time Length	7.032 ms
	Channel Power	On
	Channel Center	Center Frequency
	Channel Width	4.4 MHz
	Filter Type	Rect
TD-SCDMA	Frequency Span	5 MHz
	RBW	Auto
	Time Detection	Average
	Capture Time	Auto
	Analysis Start Time	0 s
	Analysis Time Length	662.5 μ s
	Channel Power	On
	Channel Center	Center Frequency
	Channel Width	1.6 MHz
	Filter Type	Rect

XG-PHS

Table C-2 Standard parameters for channel power function (Cont'd)

Standard	Parameter Name	Setting
XG-PHS Mean Power 10 MHz BW	Frequency Span	25 MHz
	RBW	Auto
	Time Detection	Average
	Capture Time	Auto
	Analysis Start Time	0 s
	Analysis Time Length	500 ms
	Channel Power	On
	Channel Center	Center Frequency
	Channel Width	10 MHz
	Filter Type	Rect
XG-PHS Mean Power 20 MHz BW	Frequency Span	31.25 MHz
	RBW	Auto
	Time Detection	Average
	Capture Time	Auto
	Analysis Start Time	0 s
	Analysis Time Length	500 ms
	Channel Power	On
	Channel Center	Center Frequency
	Channel Width	20 MHz
	Filter Type	Rect

CDMA2000/EV-DO

Table C-2 Standard parameters for channel power function (Cont'd)

Standard	Parameter Name	Setting
CDMA2000 Forward Link	Frequency Span	5 MHz
	RBW	Auto
	Time Detection	Average
	Capture Time	Auto
	Analysis Start Time	0 s
	Analysis Time Length	1.25 ms
	Channel Power	On
	Channel Center	Center Frequency
	Channel Width	1.23 MHz
	Filter Type	Rect
EV-DO Forward Link	Frequency Span	5 MHz
	RBW	Auto
	Time Detection	Average
	Capture Time	Auto
	Analysis Start Time	0 s
	Analysis Time Length	1.666667 ms
	Channel Power	On
	Channel Center	Center Frequency
	Channel Width	1.23 MHz
	Filter Type	Rect

ISDB-Tmm

Table C-2 Standard parameters for channel power function (Cont'd)

Standard	Parameter Name	Setting
ISDB-Tmm 14.2 MHz BW (Mean Power)	Frequency Span	25 MHz
	RBW	10 kHz
	Time Detection	Average
	Capture Time	Auto
	Analysis Start Time	0
	Analysis Time Length	1 ms
	Channel Power	On
	Channel Center	Center Frequency
	Channel Width	14.2 MHz
	Filter Type	Rect
ISDB-Tmm (ISDB-T) 5.6 MHz BW (Mean Power)	Frequency Span	10 MHz
	RBW	10 kHz
	Time Detection	Average
	Capture Time	Auto
	Analysis Start Time	0
	Analysis Time Length	1 ms
	Channel Power	On
	Channel Center	Center Frequency
	Channel Width	5.6 MHz
	Filter Type	Rect

C-3 OBW

W-CDMA/Mobile WiMAX

Table C-3 Standard parameters for OBW function

Standard	Parameter Name	Setting
W-CDMA Uplink/Downlink	Method	N% of Power
	N% Ratio	99.00%
	Frequency Span	10 MHz
	RBW	30 kHz
	Time Detection	Average
	Capture Time	Auto
	Analysis Start Time	0 s
	Analysis Time Length	10 ms
Mobile WiMAX DL / UL 10 MHz BW	Method	N% of Power
	N% Ratio	99.00%
	Frequency Span	31.25 MHz
	RBW	100 kHz
	Time Detection	Average
	Capture Time	Auto
	Analysis Start Time	0 s
	Analysis Time Length	5 ms
Mobile WiMAX DL / UL 5 MHz BW	Method	N% of Power
	N% Ratio	99.00%
	Frequency Span	10 MHz
	RBW	100 kHz
	Time Detection	Average
	Capture Time	Auto
	Analysis Start Time	0 s
	Analysis Time Length	5 ms

LTE

Table C-3 Standard parameters for OBW function (Cont'd)

Standard	Parameter Name	Setting
LTE Uplink/ Downlink 1.4 MHz BandWidth	Method	N% of Power
	N% Ratio	99.00%
	Frequency Span	5 MHz
	RBW	10 kHz
	Time Detection	Average
LTE TDD Uplink/Downlink 1.4 MHz Bandwidth	Capture Time	Auto
	Analysis Start Time	0 s
	Analysis Time Length	10 ms (LTE) 1 ms (LTE TDD)
LTE Uplink/ Downlink 3 MHz BandWidth	Method	N% of Power
	N% Ratio	99.00%
	Frequency Span	10 MHz
	RBW	30 kHz
	Time Detection	Average
LTE TDD Uplink/Downlink 3 MHz Bandwidth	Capture Time	Auto
	Analysis Start Time	0 s
	Analysis Time Length	10 ms (LTE) 1 ms (LTE TDD)
LTE Uplink/ Downlink 5 MHz BandWidth	Method	N% of Power
	N% Ratio	99.00%
	Frequency Span	10 MHz
	RBW	30 kHz
	Time Detection	Average
LTE TDD Uplink/Downlink 5 MHz Bandwidth	Capture Time	Auto
	Analysis Start Time	0 s
	Analysis Time Length	10 ms (LTE) 1 ms (LTE TDD)

Table C-3 Standard parameters for OBW function (Cont'd)

Standard	Parameter Name	Setting
LTE Uplink/ Downlink 10 MHz BandWidth	Method	N% of Power
	N% Ratio	99.00%
	Frequency Span	25 MHz
	RBW	100 kHz
	Time Detection	Average
LTE TDD Uplink/Downlink 10 MHz Bandwidth	Capture Time	Auto
	Analysis Start Time	0 s
	Analysis Time Length	10 ms (LTE) 1 ms (LTE TDD)
LTE Uplink/ Downlink 15 MHz BandWidth	Method	N% of Power
	N% Ratio	99.00%
	Frequency Span	31.25 MHz
	RBW	100 kHz
	Time Detection	Average
LTE TDD Uplink/Downlink 15 MHz Bandwidth	Capture Time	Auto
	Analysis Start Time	0 s
	Analysis Time Length	10 ms (LTE) 1 ms (LTE TDD)
LTE Uplink/ Downlink 20 MHz BandWidth	Method	N% of Power
	N% Ratio	99.00%
	Frequency Span	31.25 MHz
	RBW	100 kHz
	Time Detection	Average
LTE TDD Uplink/Downlink 20 MHz Bandwidth	Capture Time	Auto
	Analysis Start Time	0 s
	Analysis Time Length	10 ms (LTE) 1 ms (LTE TDD)

DSRC/TD-SCDMA

Table C-3 Standard parameters for OBW function (Cont'd)

Standard	Parameter Name	Setting
DSRC $\pi/4$ DQPSK/ASK	Method	N% of Power
	N% Ratio	99.00%
	Frequency Span	10 MHz
	RBW	30 kHz
	Time Detection	Positive
	Capture Time	Auto
	Analysis Start Time	0 s
	Analysis Time Length	7.032 ms
TD-SCDMA	Method	N% of Power
	N% Ratio	99.00%
	Frequency Span	5 MHz
	RBW	30 kHz
	Time Detection	Average
	Capture Time	Auto
	Analysis Start Time	0 s

XG-PHS

Table C-3 Standard parameters for OBW function (Cont'd)

Standard	Parameter Name	Setting
XG-PHS 10 MHz Bandwidth	Method	N% of Power
	N% Ratio	99.00%
	Frequency Span	25 MHz
	RBW	100 kHz
	Storage Mode	Max Hold
	Storage Count	10
	Time Detection	Positive
	Capture Time	Auto
	Analysis Start Time	0 s
	Analysis Time Length	10 ms
XG-PHS 20 MHz Bandwidth	Method	N% of Power
	N% Ratio	99.00%
	Frequency Span	31.25 MHz
	RBW	100 kHz
	Storage Mode	Max Hold
	Storage Count	10
	Time Detection	Positive
	Capture Time	Auto
	Analysis Start Time	0 s
	Analysis Time Length	10 ms

CDMA2000/EV-DO

Table C-3 Standard parameters for OBW function (Cont'd)

Standard	Parameter Name	Setting
CDMA2000 Forward Link	Method	N% of Power
	N% Ratio	99.00%
	Frequency Span	5 MHz
	RBW	30 kHz
	Time Detection	Positive
	Capture Time	Auto
	Analysis Start Time	0 s
	Analysis Time Length	1.25 ms
EV-DO Forward Link	Method	N% of Power
	N% Ratio	99.00%
	Frequency Span	5 MHz
	RBW	30 kHz
	Time Detection	Positive
	Capture Time	Auto
	Analysis Start Time	0 s
	Analysis Time Length	1.666667 ms

ISDB-Tmm

Table C-3 Standard parameters for OBW function (Cont'd)

Standard	Parameter Name	Setting
ISDB-Tmm 14.2 MHz BW	Method	N% of Power
	N% Ratio	99.00%
	Frequency Span	25 MHz
	RBW	10 kHz
	Time Detection	Average
	Capture Time	Auto
	Analysis Start Time	0 s
	Analysis Time Length	1 ms
ISDB-Tmm (ISDB-T) 5.6 MHz BW	Method	N% of Power
	N% Ratio	99.00%
	Frequency Span	10 MHz
	RBW	10 kHz
	Time Detection	Average
	Capture Time	Auto
	Analysis Start Time	0 s
	Analysis Time Length	1 ms

C-4 Burst Average Power

W-CDMA/Mobile WiMAX

Table C-4 Standard parameters for BurstAverage Power function

Standard	Parameter Name	Setting
W-CDMA Uplink/Downlink (Mean Power)	Frequency Span	10 MHz
	Time Detection	Pos & Neg
	Capture Time	Auto
	Analysis Start Time	0 s
	Analysis Time Length	10 ms
	Filter Type	Rect
	Filter BW	5 MHz
	Filter Freq Offset	0 Hz
	Burst Average Power	On
W-CDMA Uplink/Downlink (RRC Filtered Power)	Frequency Span	10 MHz
	Time Detection	Pos & Neg
	Capture Time	Auto
	Analysis Start Time	0 s
	Analysis Time Length	10 ms
	Filter Type	Root Nyquist
	Filter BW	3.84 MHz
	Filter Freq Offset	0 Hz
	Filter Roll-off Factor	0.22
Burst Average Power	On	
Mobile WiMAX DL / UL 10 MHz BW	Frequency Span	31.25 MHz
	Time Detection	Average
	Capture Time	Auto
	Analysis Start Time	0 s
	Analysis Time Length	5 ms
	Filter Type	Rect
	Filter BW	10 MHz
	Filter Freq Offset	0 Hz
	Burst Average Power	On
Mobile WiMAX DL / UL 5 MHz BW	Frequency Span	10 MHz
	Time Detection	Average
	Capture Time	Auto
	Analysis Start Time	0 s
	Analysis Time Length	5 ms
	Filter Type	Rect
	Filter BW	5 MHz
	Filter Freq Offset	0 Hz
	Burst Average Power	On

LTE

**Table C-4 Standard parameters for Burst Average Power function
(Cont'd)**

Standard	Parameter Name	Setting
LTE Uplink/ Downlink Mean Power 1.4 MHz BW	Frequency Span	5 MHz
	Time Detection	Average
	Capture Time	Auto
	Analysis Start Time	0 s
	Analysis Time Length	10 ms
LTE TDD Uplink/Downlink Mean Power 1.4 MHz BW	Filter Type	Rect
	Filter BW	1.4 MHz
	Filter Freq Offset	0 Hz
	Burst Average Power	On
LTE Uplink/ Downlink Mean Power 3 MHz BW	Frequency Span	10 MHz
	Time Detection	Average
	Capture Time	Auto
	Analysis Start Time	0 s
	Analysis Time Length	10 ms
LTE TDD Uplink/Downlink Mean Power 3 MHz BW	Filter Type	Rect
	Filter BW	3 MHz
	Filter Freq Offset	0 Hz
	Burst Average Power	On
LTE Uplink/ Downlink Mean Power 5 MHz BW	Frequency Span	10 MHz
	Time Detection	Average
	Capture Time	Auto
	Analysis Start Time	0 s
	Analysis Time Length	10 ms
LTE TDD Uplink/Downlink Mean Power 5 MHz BW	Filter Type	Rect
	Filter BW	5 MHz
	Filter Freq Offset	0 Hz
	Burst Average Power	On

Table C-4 Standard parameters for Burst Average Power function (Cont'd)

Standard	Parameter Name	Setting
LTE Uplink/ Downlink Mean Power 10 MHz BW	Frequency Span	25 MHz
	Time Detection	Average
	Capture Time	Auto
	Analysis Start Time	0 s
	Analysis Time Length	10 ms
LTE TDD Uplink/Downlink Mean Power 10 MHz BW	Filter Type	Rect
	Filter BW	10 MHz
	Filter Freq Offset	0 Hz
	Burst Average Power	On
LTE Uplink/ Downlink Mean Power 15 MHz BW	Frequency Span	31.25 MHz
	Time Detection	Average
	Capture Time	Auto
	Analysis Start Time	0 s
	Analysis Time Length	10 ms
LTE TDD Uplink/Downlink Mean Power 15 MHz BW	Filter Type	Rect
	Filter BW	15 MHz
	Filter Freq Offset	0 Hz
	Burst Average Power	On
LTE Uplink/ Downlink Mean Power 20 MHz BW	Frequency Span	31.25 MHz
	Time Detection	Average
	Capture Time	Auto
	Analysis Start Time	0 s
	Analysis Time Length	10 ms
LTE TDD Uplink/Downlink Mean Power 20 MHz BW	Filter Type	Rect
	Filter BW	20 MHz
	Filter Freq Offset	0 Hz
	Burst Average Power	On

Table C-4 Standard parameters for Burst Average Power function (Cont'd)

Standard	Parameter Name	Setting
LTE Uplink/ Downlink Filtered Power 1.4 MHz BW LTE TDD Uplink/Downlink Filtered Power 1.4 MHz BW	Frequency Span	5 MHz
	Time Detection	Average
	Capture Time	Auto
	Analysis Start Time	0 s
	Analysis Time Length	10 ms
	Filter Type	Rect
	Filter BW	1.095 MHz (DL) 1.08 MHz (UL)
	Filter Freq Offset	0 Hz
	Burst Average Power	On
LTE Uplink/ Downlink Filtered Power 3 MHz BW LTE TDD Uplink/Downlink Filtered Power 3 MHz BW	Frequency Span	10 MHz
	Time Detection	Average
	Capture Time	Auto
	Analysis Start Time	0 s
	Analysis Time Length	10 ms
	Filter Type	Rect
	Filter BW	2.715 MHz (DL) 2.7 MHz (UL)
	Filter Freq Offset	0 Hz
	Burst Average Power	On
LTE Uplink/ Downlink Filtered Power 5 MHz BW LTE TDD Uplink/Downlink Filtered Power 5 MHz BW	Frequency Span	10 MHz
	Time Detection	Average
	Capture Time	Auto
	Analysis Start Time	0 s
	Analysis Time Length	10 ms
	Filter Type	Rect
	Filter BW	4.515 MHz (DL) 4.5 MHz (UL)
	Filter Freq Offset	0 Hz
	Burst Average Power	On

Table C-4 Standard parameters for Burst Average Power function (Cont'd)

Standard	Parameter Name	Setting
LTE Uplink/ Downlink Filtered Power 10 MHz BW LTE TDD Uplink/Downlink Filtered Power 10 MHz BW	Frequency Span	25 MHz
	Time Detection	Average
	Capture Time	Auto
	Analysis Start Time	0 s
	Analysis Time Length	10 ms
	Filter Type	Rect
	Filter BW	9.015 MHz (DL) 9 MHz (UL)
	Filter Freq Offset	0 Hz
	Burst Average Power	On
LTE Uplink/ Downlink Filtered Power 15 MHz BW LTE TDD Uplink/Downlink Filtered Power 15 MHz BW	Frequency Span	31.25 MHz
	Time Detection	Average
	Capture Time	Auto
	Analysis Start Time	0 s
	Analysis Time Length	10 ms
	Filter Type	Rect
	Filter BW	13.515 MHz (DL) 13.5 MHz (UL)
	Filter Freq Offset	0 Hz
	Burst Average Power	On
LTE Uplink/ Downlink Filtered Power 20 MHz BW LTE TDD Uplink/Downlink Filtered Power 20 MHz BW	Frequency Span	31.25 MHz
	Time Detection	Average
	Capture Time	Auto
	Analysis Start Time	0 s
	Analysis Time Length	10 ms
	Filter Type	Rect
	Filter BW	18.015 MHz (DL) 18 MHz (UL)
	Filter Freq Offset	0 Hz
	Burst Average Power	On

DSRC/TD-SCDMA

**Table C-4 Standard parameters for Burst Average Power function
(Cont'd)**

Standard	Parameter Name	Setting
DSRC	Frequency Span	10 MHz
	Time Detection	Average
	Capture Time	Auto
	Analysis Start Time	0 s
	Analysis Time Length	782.00 μ s
	Filter Type	Rect
	Filter BW	4.4 MHz
	Filter Freq Offset	0 Hz
	Burst Average Power	On
TD-SCDMA	Frequency Span	5 MHz
	Time Detection	Average
	Capture Time	Auto
	Analysis Start Time	0 s
	Analysis Time Length	5.00 ms
	Filter Type	Rect
	Filter BW	1.6 MHz
	Filter Freq Offset	0 Hz
	Burst Average Power	On

CDMA2000/EV-DO

**Table C-4 Standard parameters for Burst Average Power function
(Cont'd)**

Standard	Parameter Name	Setting
CDMA2000 Forward Link	Frequency Span	5 MHz
	Time Detection	Average
	Capture Time	Auto
	Analysis Start Time	0 s
	Analysis Time Length	1.25 ms
	Filter Type	Rect
	Filter BW	1.5 MHz
	Burst Average Power	On
EV-DO Forward Link Active Slot	Frequency Span	5 MHz
	Time Detection	Average
	Capture Time	Auto
	Analysis Start Time	0 s
	Analysis Time Length	1.666667 ms
	Filter Type	OFF
	Burst Average Power	On
	Trigger Switch	Off
EV-DO Forward Link Idle Slot	Frequency Span	5 MHz
	Time Detection	Average
	Capture Time	Auto
	Analysis Start Time	326.334 μ s
	Analysis Time Length	180.660 μ s
	Filter Type	OFF
	Burst Average Power	On
	Trigger Switch	On

Appendix D FFT and RBW

The Spectrum, Spectrogram trace of the MS2690A/MS2691A/MS2692A performs spectrum analysis via FFT processing.

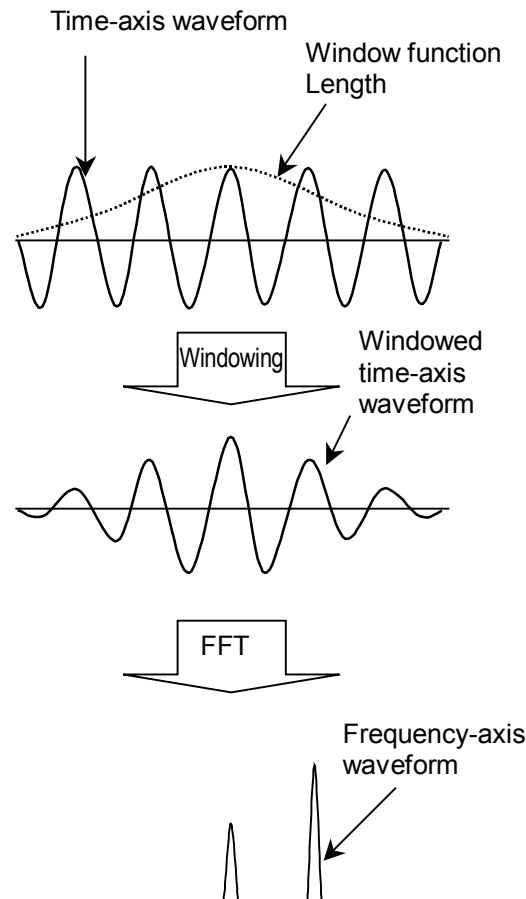

Figure D-1 Generating a spectrum waveform

Figure D-1 shows an overview of spectrum waveform generation. In FFT processing, part of a long signal is taken out for calculation. To suppress occurrences of discontinuity at the links when signals taken out are connected periodically, windowing is performed with a window function. The Signal Analyzer function uses the Gauss window as a window function.

Next, the length of the window function (Window Function Length) and capture data length are described. Figure D-2 illustrates the relation between capture data length and window function length. To display a spectrum waveform with a given analysis time length, capture data length with window function length added is required. Table D-2, D-3, D-4, D-5, D-6, D-7 shows the relation between window function length and RBW of the Spectrum, Spectrogram trace.

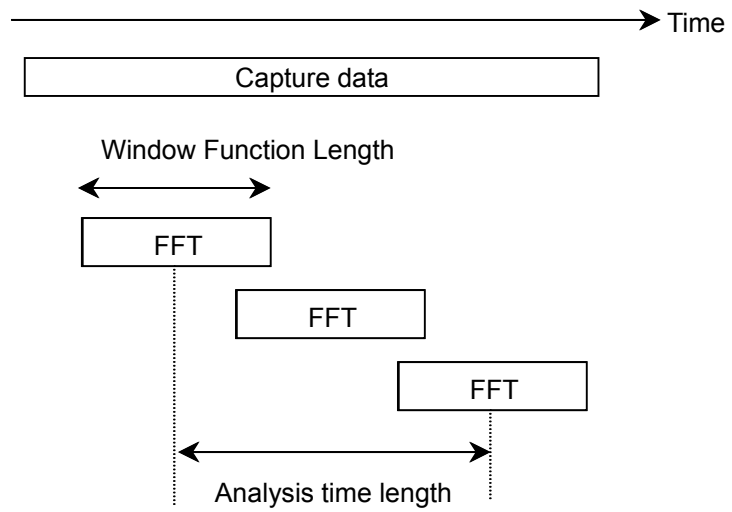

Figure D-2 Capture data length and window function length

A value varies depending on the Marker Result settings.

Table D-1 Marker Result Settings

Integration	Density	Peak(Fast)	Peak(Accuracy)
[1]	[1]	[2]	[3]

Table D-2 RBW and window function length in Spectrum trace and [1]

RBW Span	1 Hz	3 Hz	10 Hz	30 Hz	100 Hz	300 Hz	1 kHz
100/125 MHz*3							
50*1/62.5*2 MHz							
25/31.25 MHz						524288	262144
10 MHz						262144	131072
5 MHz					524288	131072	65536
2.5 MHz					262144	65536	32768
1 MHz				524288	131072	32768	8192
500 kHz			524288	262144	65536	16384	4096
250 kHz			262144	131072	32768	8192	2048
100 kHz		524288	131072	32768	8192	4096	2048
50 kHz	524288	262144	65536	16384	4096	2048	2048
25 kHz	262144	131072	32768	8192	2048	2048	2048
10 kHz	131072	32768	8192	4096	2048	2048	
5 kHz	65536	16384	4096	2048	2048		
2.5 kHz	32768	8192	2048	2048	2048		
1 kHz	16384	4096	2048	2048			

*1: 50 MHz can be set only when Option 004/104/077/177 is installed.

*2: 62.5 MHz can be set only when Option 077/177 is installed.

*3: 100 MHz and 125 MHz can be set only when Option 004/104/078/178 is installed.

Table D-2 RBW and window function length in Spectrum trace and [1] (Cont'd)

RBW Span	3 kHz	10 kHz	30 kHz	100 kHz	300 kHz	1 MHz	3 MHz	10 MHz
100/125 MHz* ³		262144	65536	32768	8192	2048	2048	2048
50* ¹ /62.5* ² MHz	262144	65536	32768	8192	2048	2048	2048	
25/31.25 MHz	65536	32768	8192	2048	2048	2048		
10 MHz	32768	8192	4096	2048	2048			
5 MHz	16384	4096	2048	2048	2048			
2.5 MHz	8192	2048	2048	2048				
1 MHz	4096	2048	2048					
500 kHz	2048	2048						
250 kHz	2048	2048						
100 kHz	2048							
50 kHz								
25 kHz								
10 kHz								
5 kHz								
2.5 kHz								
1 kHz								

Table D-3 RBW and Window Function Length in Spectrum trace and [2]

RBW Span	1 Hz	3 Hz	10 Hz	30 Hz	100 Hz	300 Hz	1 kHz
100/125 MHz *3							
50*1/62.5*2 MHz							
25/31.25 MHz							524288
10 MHz						524288	262144
5 MHz						262144	131072
2.5 MHz					524288	131072	65536
1 MHz					262144	65536	16384
500 kHz				524288	131072	32768	8192
250 kHz			524288	262144	65536	16384	4096
100 kHz			262144	65536	16384	8192	2048
50 kHz		524288	131072	32768	8192	4096	2048
25 kHz	524288	262144	65536	16384	4096	2048	2048
10 kHz	262144	65536	16384	8192	2048	2048	
5 kHz	131072	32768	8192	4096	2048		
2.5 kHz	65536	16384	4096	2048	2048		
1 kHz	32768	8192	2048	2048			

*1: 50 MHz can be set only when Option 004/104/077/177 is installed.

*2: 62.5 MHz can be set only when Option 077/177 is installed.

*3: 100 MHz and 125 MHz can be set only when Option 004/104/078/178 is installed.

Table D-3 RBW and Window Function Length in Spectrum trace and [2] (Cont'd)

RBW Span	3 kHz	10 kHz	30 kHz	100 kHz	300 kHz	1 MHz	3 MHz	10 MHz
100/125 MHz *3		524288	131072	65536	16384	4096	2048	2048
50*1/62.5*2 MHz	524288	131072	65536	16384	4096	2048	2048	
25/31.25 MHz	131072	65536	16384	4096	2048	2048		
10 MHz	65536	16384	8192	2048	2048			
5 MHz	32768	8192	4096	2048	2048			
2.5 MHz	16384	4096	2048	2048				
1 MHz	8192	2048	2048					
500 kHz	4096	2048						
250 kHz	2048	2048						
100 kHz	2048							
50 kHz								
25 kHz								
10 kHz								
5 kHz								
2.5 kHz								
1 kHz								

Table D-4 RBW and Window Function Length in Spectrum trace and [3]

RBW Span	1 Hz	3 Hz	10 Hz	30 Hz	100 Hz	300 Hz	1 kHz
100/125 MHz*3							
50*1/62.5*2 MHz							
25/31.25 MHz							
10 MHz							524288
5 MHz						524288	262144
2.5 MHz						262144	131072
1 MHz					524288	131072	32768
500 kHz					262144	65536	16384
250 kHz				524288	131072	32768	8192
100 kHz			524288	131072	32768	16384	4096
50 kHz			262144	65536	16384	8192	2048
25 kHz		524288	131072	32768	8192	4096	2048
10 kHz	524288	131072	32768	16384	4096	2048	
5 kHz	262144	65536	16384	8192	2048		
2.5 kHz	131072	32768	8192	4096	2048		
1 kHz	65536	16384	4096	2048			

*1: 50 MHz can be set only when Option 004/104/077/177 is installed.

*2: 62.5 MHz can be set only when Option 077/177 is installed.

*3: 100 MHz and 125 MHz can be set only when Option 004/104/078/178 is installed.

Table D-4 RBW and Window Function Length in Spectrum trace and [3] (Cont'd)

RBW Span	3 kHz	10 kHz	30 kHz	100 kHz	300 kHz	1 MHz	3 MHz	10 MHz
100/125 MHz* ³			262144	131072	32768	8192	4096	2048
50* ¹ /62.5* ² MHz		262144	131072	32768	8192	4096	2048	
25/31.25 MHz	262144	131072	32768	8192	4096	2048		
10 MHz	131072	32768	16384	4096	2048			
5 MHz	65536	16384	8192	2048	2048			
2.5 MHz	32768	8192	4096	2048				
1 MHz	16384	4096	2048					
500 kHz	8192	2048						
250 kHz	4096	2048						
100 kHz	2048							
50 kHz								
25 kHz								
10 kHz								
5 kHz								
2.5 kHz								
1 kHz								

Table D-5 RBW and Window Function Length in Spectrogram trace and [1]

RBW Span	1 Hz	3 Hz	10 Hz	30 Hz	100 Hz	300 Hz	1 kHz
100/125 MHz*3							
50*1/62.5*2 MHz							
25/31.25 MHz						524288	262144
10 MHz						262144	131072
5 MHz					524288	131072	65536
2.5 MHz					262144	65536	32768
1 MHz				524288	131072	32768	8192
500 kHz			524288	262144	65536	16384	4096
250 kHz			262144	131072	32768	8192	2048
100 kHz		524288	131072	32768	8192	4096	1024
50 kHz	524288	262144	65536	16384	4096	2048	1024
25 kHz	262144	131072	32768	8192	2048	1024	1024
10 kHz	131072	32768	8192	4096	1024	1024	
5 kHz	65536	16384	4096	2048	1024		
2.5 kHz	32768	8192	2048	1024	1024		
1 kHz	16384	4096	1024	1024			

*1: 50 MHz can be set only when Option 004/104/077/177 is installed.

*2: 62.5 MHz can be set only when Option 077/177 is installed.

*3: 100 MHz and 125 MHz can be set only when Option 004/104/078/178 is installed.

Table D-5 RBW and Window Function Length in Spectrogram trace and [1] (Cont'd)

RBW Span	3 kHz	10 kHz	30 kHz	100 kHz	300 kHz	1 MHz	3 MHz	10 MHz
100/125 MHz*3		262144	65536	32768	8192	2048	1024	1024
50*1/62.5*2 MHz	262144	65536	32768	8192	2048	1024	1024	
25/31.25 MHz	65536	32768	8192	2048	1024	1024		
10 MHz	32768	8192	4096	1024	1024			
5 MHz	16384	4096	2048	1024	1024			
2.5 MHz	8192	2048	1024	1024				
1 MHz	4096	1024	1024					
500 kHz	2048	1024						
250 kHz	1024	1024						
100 kHz	1024							
50 kHz								
25 kHz								
10 kHz								
5 kHz								
2.5 kHz								
1 kHz								

Table D-6 RBW and Window Function Length in Spectrogram trace and [2]

Span \ RBW	1 Hz	3 Hz	10 Hz	30 Hz	100 Hz	300 Hz	1 kHz
100/125 MHz*3							
50*1/62.5*2 MHz							
25/31.25 MHz							524288
10 MHz						524288	262144
5 MHz						262144	131072
2.5 MHz					524288	131072	65536
1 MHz					262144	65536	16384
500 kHz				524288	131072	32768	8192
250 kHz			524288	262144	65536	16384	4096
100 kHz			262144	65536	16384	8192	2048
50 kHz		524288	131072	32768	8192	4096	1024
25 kHz	524288	262144	65536	16384	4096	2048	1024
10 kHz	262144	65536	16384	8192	2048	1024	
5 kHz	131072	32768	8192	4096	1024		
2.5 kHz	65536	16384	4096	2048	1024		
1 kHz	32768	8192	2048	1024			

*1: 50 MHz can be set only when Option 004/104/077/177 is installed.

*2: 62.5 MHz can be set only when Option 077/177 is installed.

*3: 100 MHz and 125 MHz can be set only when Option 004/104/078/178 is installed.

Table D-6 RBW and Window Function Length in Spectrogram trace and [2] (Cont'd)

RBW Span	3 kHz	10 kHz	30 kHz	100 kHz	300 kHz	1 MHz	3 MHz	10 MHz
100/125 MHz* ³		524288	131072	65536	16384	4096	2048	1024
50* ¹ /62.5* ² MHz	524288	131072	65536	16384	4096	2048	1024	
25/31.25 MHz	131072	65536	16384	4096	2048	1024		
10 MHz	65536	16384	8192	2048	1024			
5 MHz	32768	8192	4096	1024	1024			
2.5 MHz	16384	4096	2048	1024				
1 MHz	8192	2048	1024					
500 kHz	4096	1024						
250 kHz	2048	1024						
100 kHz	1024							
50 kHz								
25 kHz								
10 kHz								
5 kHz								
2.5 kHz								
1 kHz								

Table D-7 RBW and Window Function Length in Spectrogram trace and [3]

Span \ RBW	1 Hz	3 Hz	10 Hz	30 Hz	100 Hz	300 Hz	1 kHz
100/125 MHz*3							
50*1/62.5*2 MHz							
25/31.25 MHz							
10 MHz							524288
5 MHz						524288	262144
2.5 MHz						262144	131072
1 MHz					524288	131072	32768
500 kHz					262144	65536	16384
250 kHz				524288	131072	32768	8192
100 kHz			524288	131072	32768	16384	4096
50 kHz			262144	65536	16384	8192	2048
25 kHz		524288	131072	32768	8192	4096	1024
10 kHz	524288	131072	32768	16384	4096	1024	
5 kHz	262144	65536	16384	8192	2048		
2.5 kHz	131072	32768	8192	4096	1024		
1 kHz	65536	16384	4096	2048			

*1: 50 MHz can be set only when Option 004/104/077/177 is installed.

*2: 62.5 MHz can be set only when Option 077/177 is installed.

*3: 100 MHz and 125 MHz can be set only when Option 004/104/078/178 is installed.

Table D-7 RBW and Window Function Length in Spectrogram trace and [3] (Cont'd)

RBW Span	3 kHz	10 kHz	30 kHz	100 kHz	300 kHz	1 MHz	3 MHz	10 MHz
100/125 MHz* ³			262144	131072	32768	8192	4096	1024
50* ¹ /62.5* ² MHz		262144	131072	32768	8192	4096	1024	
25/31.25 MHz	262144	131072	32768	8192	4096	1024		
10 MHz	131072	32768	16384	4096	1024			
5 MHz	65536	16384	8192	2048	1024			
2.5 MHz	32768	8192	4096	1024				
1 MHz	16384	4096	1024					
500 kHz	8192	2048						
250 kHz	4096	1024						
100 kHz	1024							
50 kHz								
25 kHz								
10 kHz								
5 kHz								
2.5 kHz								
1 kHz								

Appendix E IQ Data Time Actually Required

IQ data time actually required

In FFT and filtering processing, additional IQ data time is required for calculation in addition to the specified capture time. The Signal Analyzer function automatically calculates the data length required for calculation to capture the data. However, note that some data such as digitized data already include IQ data.

The IQ data time actually captured for the Spectrum trace is as shown below.

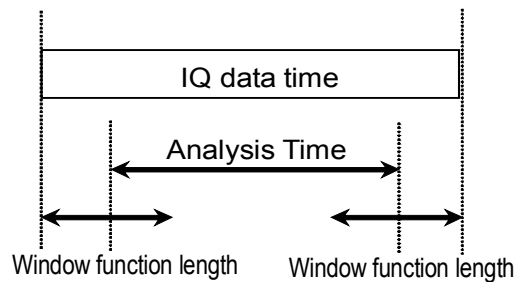

Figure E-1 IQ data time for the Spectrum trace

The Spectrum trace uses the FFT method for calculation, so data with window function length is captured as required data length for calculation in addition to the specified analysis time.

The IQ data time actually captured for the Power vs Time trace is as shown below.

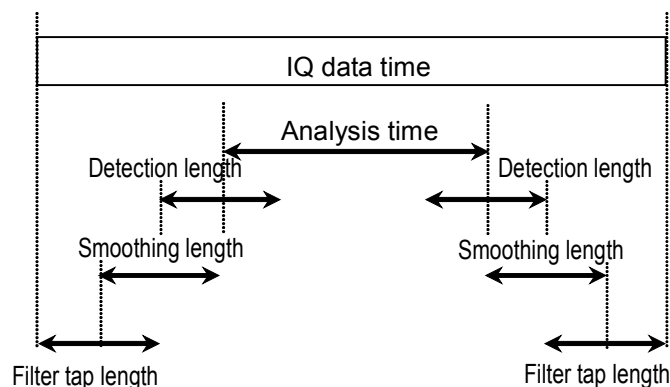

Figure E-2 IQ data time for the Power vs Time trace

The Power vs Time trace performs filtering processing, smoothing processing, and detection processing depending on the setting, so the data required for the calculations is captured, which is longer than the analysis time.

The minimum capture time for the Frequency vs Time trace is as shown below.

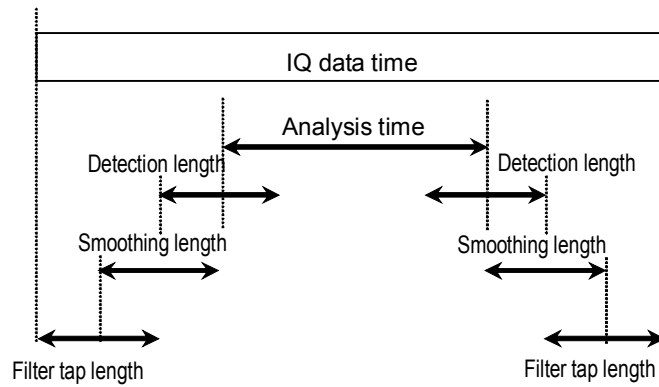

Figure E-3 IQ data time for the Frequency vs Time trace

The Frequency vs Time trace performs band limiting processing, so the data required for the calculation is captured, which is longer than the analysis time. It also performs smoothing processing and detection processing depending on the setting, so the data required for processing is captured.

The minimum capture time for the CCDF trace is as shown below.

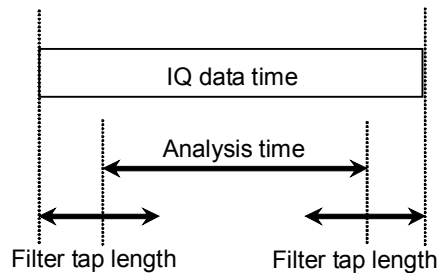

Figure E-4 IQ data time for the CCDF trace

The CCDF trace performs filtering processing depending on the setting, so the data required for the calculation is captured, which is longer than the analysis time.

The minimum capture time for the Spectrogram trace is as shown below.

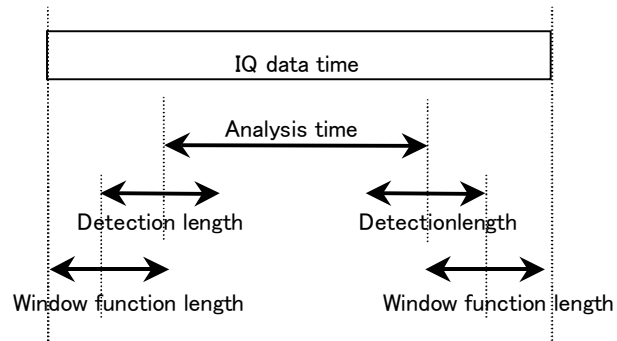

Figure E-5 IQ data time for the Spectrogram trace

The Spectrogram trace uses the FFT method for calculation, so data with window function length is captured as required data length for calculation in addition to the specified analysis time. It also performs smoothing processing and detection processing depending on the setting, so the data required for processing is captured.

Auto mode and Manual mode for capture time

When Capture Time is set to the Auto mode, the data length required for calculation is automatically set to the minimum data length. This makes the IQ data time actually captured the shortest, allowing the user to obtain analysis results in the shortest time. On the other hand, if Capture Time is set to the Manual mode, the data length required for calculation is always maximized to capture IQ data. This makes the time to obtain analysis results longer, but allows the user to use the same IQ data for analysis with multiple traces.

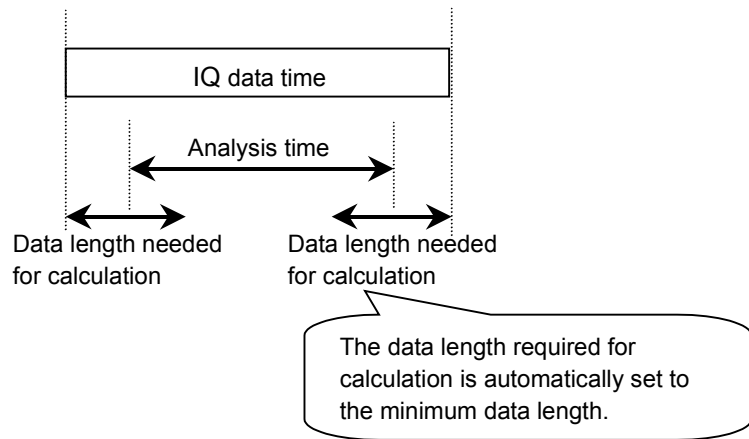

Figure E-6 IQ data time in the Auto mode

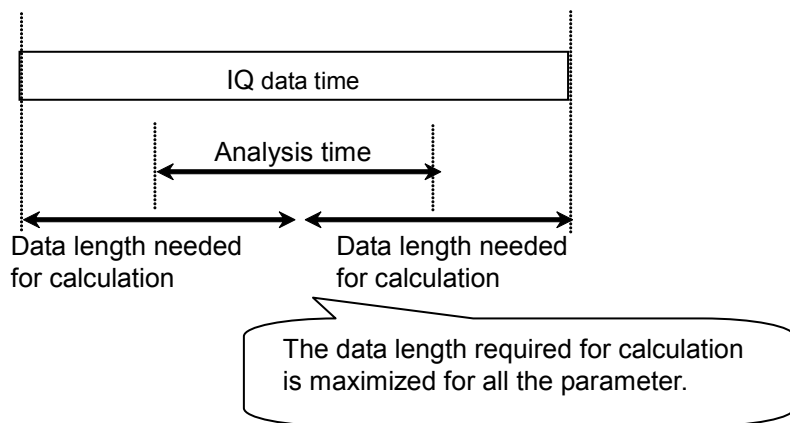

Figure E-7 IQ data time in the Manual mode

Appendix F Saving Waveform CSV DATA

This appendix describes the trace-data file used when a signal analyzer application is used to save trace data (data displayed on the screen) to a file.

Trace data to be saved

Trace Mode trace data (trace data displayed on the screen) selected from Spectrum/Power vs Time/Freq. vs Time/Spectrogram/CCDF

If Sub-Trace is displayed, Sub-Trace data is saved at the same time.

Default file name

WaveDataYYYYMMDD_NNN.csv: YYYYMMDD is a date and NNN is a suffix number.

Save folder

\Anritsu Corporation\Signal Analyzer\User Data\Trace Data\Signal Analyzer

Table F-1 Spectrum trace file information

Line number	Recorded Information		Remarks
1	"Main-Trace", "Start Freq (Hz)", "Stop Freq (Hz)", "Center Freq (Hz)", "Span Freq (Hz)"		Data title
2	The data for the above		Main-Trace: "Spectrum"
3	Blank		
4	"Analysis Start Time (ms)", "Analysis Time Length (ms)", "Capture Time (ms)", "ATT (dB)"		Data title
5	The data for the above		
6	Blank		
7	When Scale = Log	When Scale = Lin	Data title Without Preamplifier option installed, "Pre-Amp" not displayed.
	Log Scale Unit display "Ref Level (dBm)", "Pre-Amp" or "Ref Level (dBuV)", "Pre-Amp" or "Ref Level (dBmV)", "Pre-Amp" or "Ref Level (dBmV)", "Pre-Amp" or "Ref Level (V)", "Pre-Amp" or "Ref Level (W)", "Pre-Amp" or "RefLevel (dBuV (emf))", "Pre-Amp" or "Ref Level (dBuV/m)", "Pre-Amp"	"Ref Level (V)", "Pre-Amp"	
8	The data for the above	The data for the above	Reference level (Log): 0.001 dB resolution Reference level (Lin): A three-digit index is displayed. Pre-Amp: "On" or "Off"
9	Blank		
10	"RBW (Hz)", "Marker Result"		Data title
11	The data for the above		Marker Result: "Integration" or "Density" or "Peak (Fast)" or "Peak (Accuracy)"
12	Blank		
13	"Detection", "Trace Point"		Data title
14	The data for the above		Detection: "Average" or "Positive" or "Negative"

Table F-1 Spectrum trace file information (Continued)

Line number	Recorded Information		Remarks
15	Blank		
16	"Storage Mode"		Data title
17	The data for the above		Storage Mode: "Lin Average" or "Max Hold" or "Min Hold" or "Off"
18	Blank		
19	When Scale = Log	When Scale = Lin	Data title
	"Wave Data (dBm)"	"Wave Data (V)"	
20	Trace data at the Trace Point – 0 position (Log)	Trace data at the Trace Point – 0 position (Lin)	Trace data (Log): 0.001 dBm resolution Trace data (Lin): A three-digit index is displayed. Includes Offset value
–	–	–	
20 + Trace Point – 1	Trace data at the Trace Point – 1 position (Log)	Trace data at the Trace Point – 1 position (Lin)	Same as above

Table F-2 Power vs Time trace file information

Line number	Recorded Information		Remarks
1	"Main-Trace", "Center Freq (Hz)", "Span Freq (Hz)"		Data title
2	The data for the above		Main-Trace: "Power vs Time"
3	Blank		
4	"Analysis Start Time (ms)", "Analysis Time Length (ms)", "Capture Time (ms)", "ATT (dB)"		Data title
5	The data for the above		
6	Blank		
7	When Scale = Log	When Scale = Lin	Data title
	Same as Spectrum trace	Same as Spectrum trace	Same as Spectrum trace
8	The data for the above	The data for the above	Same as Spectrum trace
9	Blank		
10	"Filter Type", "Roll-off Factor", "Bandwidth (Hz)", "Freq. Offset (Hz)", "Smoothing", "Time Length (us)"		Data title
11	Filter Type, Roll-off Factor, Bandwidth, Freq Offset, Smoothing, Smoothing Time Length		Filter Type: "Rect" or "Gaussian" or "Nyquist" or "Root Nyquist" or "Off" Roll-off Factor: 0.01 resolution Smoothing: "On" or "Off"
12	Blank		
13	"Detection", "Trace Point"		Data title
14	The data for the above		Detection: "Pos&Neg" or "Positive" or "Negative" or "Average"
15	Blank		

Table F-2 Power vs Time trace file information (Continued)

Line number	Recorded Information		Remarks
16	"Storage Mode"		Data title
17	The data for the above		Storage Mode: "Lin Average" or "Max Hold" or "Min Hold" or "Off"
18	Blank		
19	When Scale = Log	When Scale = Lin	Data title
	"Wave Data (dBm)", "(neg)"	"Wave Data (V)", "(neg)"	
20	Trace data at the Trace Point – 0 position (Log), trace data (Log-neg)	Trace data at the Trace Point – 0 position (Lin), trace data (Lin-neg)	Trace data (Log): 0.001 dBm resolution Trace data (Lin): A three-digit index is displayed. Trace data (Log-neg): Neg data that is only recorded when Detection = Pos&Neg Trace data (Lin-neg): Neg data that is only recorded when Detection = Pos&Neg and that is displayed as a three-digit index Includes Offset value
–	–	–	
20 + Trace Point – 1	Trace data at the Trace Point – 1 position (Log), trace data (Log-neg)	Trace data at the Trace Point – 1 position (Lin), trace data (Lin-neg)	Same as above

Table F-3 Freq vs Time trace file information

Line number	Recorded Information		Remarks
1	"Main-Trace", "Center Freq (Hz)", "Span Freq (Hz)"		Data title
2	The data for the above		Main-Trace: "Frequency vs Time"
3	Blank		
4	"Analysis Start Time (ms)", "Analysis Time Length (ms)", "Capture Time (ms)", "ATT (dB)"		Data title
5	The data for the above		
6	Blank		
7	When Scale = Log	When Scale = Lin	Data title
	Same as Spectrum trace	Same as Spectrum trace	Same as Spectrum trace
8	The data for the above	The data for the above	Same as Spectrum trace
9	Blank		
10	"Bandwidth (Hz)", "Freq. Offset (Hz)", "Smoothing", "Time Length (us)"		Data title
11	The data for the above		Smoothing: "On" or "Off" Time Length: Smoothing Time Length
12	Blank		
13	"Detection", "Trace Point"		Data title
14	The data for the above		Detection: "Pos&Neg" or "Positive" or "Negative" or "Average"
15	Blank		
16	"Storage Mode"		Data title
17	The data for the above		Storage Mode: "Lin Average", "Max Hold", "Min Hold", "Off"
18	Blank		

Table F-3 Freq vs Time trace file information (Continued)

Line number	Recorded Information		Remarks
19	When Scale Unit = Hz	When Scale Unit = ΔHz	Data title
	“Wave Data (Hz)”, “(neg)”	“Wave Data (Delta Hz)”, “(neg)”	
20	Trace data at the Trace Point – 0 position (Hz), trace data (Hz-neg)	Trace data at the Trace Point – 0 position (Delta Hz), trace data (Delta Hz-neg)	Trace data (Hz): 0.001 Hz resolution Trace data (Delta Hz): 0.001 Hz resolution Trace data (Hz-neg): Neg data that is only recorded when Detection = Pos&Neg Trace data (Delta Hz-neg): Neg data that is only recorded when Detection = Pos&Neg
–	–	–	
20 + Trace Point – 1	Trace data at the Trace Point – 1 position (Hz), trace data (Hz-neg)	Trace data at the Trace Point – 1 position (Delta Hz), trace data (Delta Hz-neg)	Same as above

Table F-4 Phase vs Time trace file information

Line number	Recorded Information		Remarks
1	"Main-Trace", "Center Freq (Hz)", "Span Freq (Hz)"		Data title
2	The data for the above		Main-Trace: "Phase vs Time"
3	Blank		
4	"Analysis Start Time (ms)", "Analysis Time Length (ms)", "Capture Time (ms)", "ATT (dB)"		Data title
5	The data for the above		
6	Blank		
7	When Scale = Log	When Scale = Lin	Data title
	Same as Spectrum trace	Same as Spectrum trace	Same as Spectrum trace
8	The data for the above	The data for the above	Same as Spectrum trace
9	Blank		
10	"Bandwidth (Hz)"		Data title
11	The data for the above		
12	Blank		
13	"Detection", "Trace Point"		Data title
14	The data for the above		Detection: "Positive" or "Negative" or "Sample" or "Average"
15	Blank		
16	"Storage Mode"		Data title
17	The data for the above		Storage Mode: "Off"
18	Blank		

Table F-4 Phase vs Time trace file information (Continued)

Line number	Recorded Information	Remarks
19	“Phase Offset”	Data title
20	The data for the above	
21	Blank	
22	“Wave Data (degree)”	Data title
23	Trace data at the Trace Point – 0 position (degree)	Trace data (degree): 0.001 degree resolution
—	—	—
23 + Trace Point – 1	Trace data at the Trace Point – 1 position (degree)	Same as above

Table F-5 Spectrogram trace file information

Line number	Recorded Information		Remarks
1	"Main-Trace", "Start Freq (Hz)", "Stop Freq (Hz)", "Center Freq (Hz)", "Span Freq (Hz)"		Data title
2	The data for the above		Main-Trace: "Spectrogram"
3	Blank		
4	"Analysis Start Time (ms)", "Analysis Time Length (ms)", "Capture Time (ms)", "ATT (dB)"		Data title
5	The data for the above		
6	Blank		
7	When Scale = Log	When Scale = Lin	Data title
	Same as Spectrum trace	Not available	Same as Spectrum trace
8	The data for the above	The data for the above	Same as Spectrum trace
9	Blank		
10	"RBW (Hz)", "Marker Result"		Data title
11	The data for the above		Marker Result: "Integration" or "Density" or "Peak (Fast)" or "Peak (Accuracy)"
12	Blank		
13	"Detection", "Freq Trace Point", "Time Trace Point"		Data title
14	The data for the above		Detection: "Average" or "Positive" or "Negative"
15	Blank		
16	"Storage Mode"		Data title
17	The data for the above		Storage Mode: "Lin Average" or "Max Hold" or "Min Hold" or "Off"
18	Blank		

Table F-5 Spectrogram trace file information (Continued)

Line number	Recorded Information	Remarks
19	“Wave Data Time Trace 0 (dBm)”, “Wave Data Time Trace 1 (dBm)”,“Wave Data Time Trace 0 (dBm)”, “Wave Data Time Trace” + NT-1 + “(dBm)”	Data title NT is the number of trace points in the time direction.
20The time-direction trace data (Log)[0], (Log)[1], and (Log)[NT-1] at the trace point 0 position in the frequency direction	Trace data (Log): 0.001 dB resolution NT is the number of trace points in the time direction. Includes Offset value
21The time-direction trace data (Log)[0], (Log)[1], and (Log)[NT-1] at the trace point 1 position in the frequency direction<	Same as above
	—	—
20 + NF - 1The time-direction trace data (Log)[0], (Log)[1], and (Log)[NT-1] at the trace point NF - 1 position in the frequency direction	NF is the trace point in the frequency direction.

Table F-6 CCDF trace file information

Line number	Recorded Information		Remarks
1	"Main-Trace", "Center Freq (Hz)", "Span Freq (Hz)"		Data title
2	The data for the above		Main-Trace: "CCDF"
3	Blank		
4	"Analysis Start Time (ms)", "Analysis Time (ms)", "Capture Time (ms)", "ATT (dB)"		Data title
5	The data for the above		Same as Spectrum trace
6	Blank		
7	When Scale = Log	When Scale = Lin	Data title
	Same as Spectrum trace	Same as Spectrum trace	Same as Spectrum trace
8	The data for the above	The data for the above	Same as Spectrum trace
9	Blank		
10	"Method", "Filter Type", "Bandwidth (Hz)", "Freq. Offset (Hz)"		Data title
11	The data for the above		Method: "CCDF" or "APD" Filter Type: "Rect" or "Off"
12	Blank		
13	"Data Count"		Data title
14	The data for the above		
15	Blank		
16	"Avg. Power (dBm)", "Max Power (dBm)", "Crest Factor (dB)"		Data title
17	The data for the above		Includes Offset value
18	Blank		

Table F-6 CCDF trace file information (Continued)

Line number	Recorded Information				Remarks
19	"Wave Data (%)", "(Reference)"				Data title When Reference Trace = Off, "(Reference)" is not recorded.
20	When Method = APD		When Method = CCDF		Trace data (Log): 0.0001% resolution When Reference Trace = Off, Reference Trace data is not recorded.
	Accumulated value (%) at -50.00 dB	Accumulated Reference Trace value (%) at -50.00 dB	Accumulated value (%) at 0.00 dB	Accumulated Reference Trace value (%) at 0.00 dB	
21	Accumulated value (%) at -49.99 dB	Accumulated Reference Trace value (%) at -49.99 dB	Accumulated value (%) at 0.01 dB	Accumulated Reference Trace value (%) at 0.01 dB	Same as above
—	—	—	—	—	
5020	Accumulated value (%) at 00.00 dB	Accumulated Reference Trace value (%) at 00.00 dB	Accumulated value (%) at 50.00 dB	Accumulated Reference Trace value (%) at 50.00 dB	Same as above
—	—	—	-	-	
10020	Accumulated value (%) at 50.00 dB	Accumulated Reference Trace value (%) at 50.00 dB	-	-	Same as above

Appendix F Saving Waveform CSV DATA

When a sub-trace is displayed, the information below is recorded after the last main trace line.

Table F-7 Additional Power vs Time trace file information when Sub-Trace is displayed

Line number	Recorded Information		Remarks
+1	Blank		
+2	"Sub-Trace"		Data title
+3	"Power vs Time"		
+4	Blank		
+5	"Analysis Start Time (ms)", "Analysis Time (ms)"		Data title
+6	The data for the above		Same as Spectrum trace
+7	Blank		
+8	Blank		
+9	"Detection", "Trace Point"		Data title
+10	The data for the above		Detection: "Pos&Neg" or "Positive" or "Negative" or "Average"
+11	Blank		
+12	When Scale = Log	When Scale = Lin	Data title
	"Wave Data (dBm)", "(neg)"	"Wave Data (V)", "(neg)"	
+13	Trace data at the Trace Point – 0 position (Log), trace data (Log-neg)	Trace data at the Trace Point – 0 position (Lin), trace data (Lin-neg)	Trace data (Log): 0.001 dB resolution Trace data (Lin): A three-digit index is displayed. Trace data (Log-neg): Neg data that is only recorded when Detection = Pos&Neg Trace data (Lin-neg): Neg data that is only recorded when Detection = Pos&Neg and that is displayed as a three-digit index Includes Offset value
–	–	–	
+13 + Trace Point – 1	Trace data at the Trace Point – 1 position (Log), trace data (Log-neg)	Trace data at the Trace Point – 1 position (Lin), trace data (Lin-neg)	Same as above

When a sub-trace is displayed, the information below is recorded after the last main trace line.

Table F-8 Additional Spectrogram trace file information when Sub-Trace is displayed

Line number	Recorded Information	Remarks
+1	Blank	
+2	“Sub-Trace”	Data title
+3	“Spectrogram”	
+4	Blank	
+5	“Analysis Start Time (ms)”, “Analysis Time (ms)”	Data title
+6	The data for the above	Same as Spectrum trace
+7	Blank	
+8	“RBW (Hz)”	Data title
+9	The data for the above	
+10	Blank	
+11	“Detection”, “Trace Point”	Data title
+12	The data for the above	Detection: “Pos&Neg” or “Positive” or “Negative” or “Average”
+13	Blank	
+14	“Wave Data Time Trace 0 (dBm)”, “Wave Data Time Trace 1 (dBm)”,“Wave Data Time Trace 0 (dBm)”, “Wave Data Time Trace” + NT-1 + “(dBm)”	Data title NT is the number of trace points in the time direction.
+15The time-direction trace data (Log)[0], (Log)[1], and (Log)[NT-1] at the trace point 0 position in the frequency direction	Trace data (Log): 0.001 dB resolution NT is the number of trace points in the time direction. Includes Offset value
+16The time-direction trace data (Log)[0], (Log)[1], and (Log)[NT-1] at the trace point 1 position in the frequency direction	Same as above
–	–	–
15 + NF – 1The time-direction trace data (Log)[0], (Log)[1], and (Log)[NT-1] at the trace point NF - 1 position in the frequency direction	NF is the trace point in the frequency direction.<

References are to section numbers.

A

Accessory	2.1, 6.1
ACP	4.2.10
Active Marker	4.3.9, 4.4.9, 4.7.8
AD Full Range	7.2.1
Adjacent channel leakage power (ACP) measurement	4.2.10
AM Depth	4.3.11
Amplitude	2.1
Analysis Start Time	4.2.3, 4.3.3, 4.4.3, 4.6.4
Analysis Time	4.2.2, 4.2.3, 4.3.2, 4.3.3, 4.4.2, 4.4.3, 4.6.2, 4.6.4, 4.7.2, 4.7.3
Analysis Time Length	4.2.3, 4.3.3, 4.4.3, 4.5.4
APD	4.5.3
Attenuator	2.3
Average	4.2.7, 4.3.8, 4.4.8, 4.7.7
Averaging	4.2.6, 4.3.7

B

Band Width	4.3.5, 4.6.9
BBIF trigger	3.2.2, 7.6
Burst Average Power	4.3.11

C

Capture	2.1, 5.1
Capture Time	2.4, 4.2.3, 4.3.3, 4.4.3, 4.6.4
Capture Time Length	2.4
Capture mode	3.1
Carrier Center	4.2.10
Carrier Spacing	4.2.10
CCDF	1.2, 4.1, 4.6, Appendix E
Center	2.2, 4.2.4
Ch BW	4.2.10
Channel Center	4.2.10
Channel Power	4.2.10
Channel Width	4.2.10
Chirp	4.4.11
Count	4.2.6, 4.3.7, 4.4.7, 4.7.6

D

Data Count	4.6.3
Detection	4.2.2, 4.2.7, 4.3.2, 4.3.8, 4.4.2, 4.4.8
Detection mode	4.2.7, 4.3.8, 4.4.8, 4.4.9
DigRF 3G Setting	7.2.1
Dip Search	4.4.10
Distribution Position	4.6.8

E

Erase Warm Up Message	6.1
Exec Digitize	5.1
External trigger	3.2.2

Index

F

FFT	1.1, 1.2, Appendixes D, E
Filter	4.2.10, 4.3.2, 4.3.5, 4.4.2, 4.4.5, 4.6.2, 4.6.7
Filter Bandwidth	4.4.5
Filter Type	4.2.10
FM CW	4.4.11
FM Deviation	4.4.11
FM Error	4.4.11
FM Slope	4.4.11
Freq. Offset	4.3.5, 4.6.9
Frequency	2.1
Frequency Band Mode	2.2
Frequency vs Time	1.2, 4.1, 4.4, Appendix E

H

Horizontal	4.2.4, 4.6.5
------------	--------------

I

I/Q sign	7.2.2
Input attenuator	2.3.2
Input Source	7.7.1, 7.7.2, 7.7.3
IQ data	2.4, 5.1, Appendix E

L

Level Over	2.3.2
Lin Average	4.2.6, 4.3.7, 4.7.6
Lin Scale Division	2.3.3, 4.2.4, 4.3.4
Load Standard Parameter	4.2.10, 4.3.11
Log Scale Division	2.3.3, 4.2.4, 4.3.4
Log Scale Line	2.3.3, 4.2.4, 4.3.4
Log Scale Unit	2.3

M

Marker	4.2.2, 4.2.8, 4.3.2, 4.3.9, 4.4.2, 4.4.9, 4.6.2, 4.6.8, 4.7.2, 4.7.8
Marker Axis	4.6.8
Marker Result Type	4.2.8, 4.7.8
Marker search	4.2.9, 4.3.10, 4.4.10
Marker to Center Freq	4.2.8, 4.2.9
Marker to Ref. Level	4.2.8, 4.2.9
Max Hold	4.2.6, 4.3.7, 4.4.7, 4.7.6
Meas channel	7.2.2
Measure	4.2.2, 4.2.10, 4.3.2, 4.3.11
Measure Interval	4.4.11
Measure Method	4.6.3
Measure Slope	4.4.11
Method	4.2.10, 4.6.2, 4.6.3
Min Hold	4.2.6, 4.3.7, 4.4.7, 4.7.6
Mode	4.2.6, 4.3.7, 4.4.7, 4.7.6

N

N% Ratio	4.2.10
Negative	4.2.7, 4.3.8, 4.4.8, 4.7.7
Next Dip	4.4.10
Next Peak	4.2.9, 4.3.10, 4.4.10
Next Peak search	4.2.9, 4.3.10, 4.4.10

O

OBW	4.2.10
Occupied bandwidth (OBW) measurement	4.2.10
Offset	2.3, 4.2.10

P

Peak Search	4.2.9, 4.3.10, 4.4.10
Peak to Peak	4.3.9, 4.4.9
Phase Offset	4.5.7
Phase Mode	4.5.7
Pos&Neg	4.3.8, 4.4.8
Positive	4.2.7, 4.3.8, 4.4.8, 4.7.7
Power measurement	4.2.10
Power vs Time	1.2, 4.1, 4.3, Appendix E
Preselector	2.2.5, 6.1
Preselector Auto Tune	2.2, 6.7
Preselector Tune Preset	6.7
Probability Position	4.6.8

R

RBW	4.2.2, 4.2.5, Appendix D, 4.7.2, 4.7.5
Reference Clock	6.1, 6.4
Reference Clock Preset	6.4
Reference clock signal	6.4, 6.5
Reference Level	2.3
Reset Every Capture	4.6.6
Resolution	4.2.9, 4.3.10, 4.4.10
Resolution bandwidth	4.2.5
Restart	4.6.6
Roll-off Factor	4.2.10, 4.3.5

S

Save Captured Data	2.4, 5.1
Scale	2.3, 2.3.3, 4.2.2, 4.3.2, 4.3.4, 4.4.2, 4.4.4, 4.6.2, 4.6.5, 4.7.2, 4.7.4
Scale Unit	4.4.4
Setting Input	7.2
Setting terminal	7.2.1
SG marker trigger	3.2.2
Signal Search	4.2.2, 4.2.9, 4.3.2, 4.3.10, 4.4.2, 4.4.10
Slope	4.4.11
Smoothing	4.3.6, 4.4.6
Smoothing Time Length	4.3.6, 4.4.6
Span	2.2
Spectrum	1.2, 4.1, 4.2, Appendix E
Spectrogram	1.2, 4.1, 4.7, Appendix E
Standard	4.2.10, 4.3.11
Start	2.2
Start Time	4.2.3, 4.3.3, 4.4.3, 4.6.4, 4.7.3
Stop	2.2, 4.2.6, 4.3.7, 4.4.7, 4.7.6
Storage	4.2.2, 4.2.6, 4.3.2, 4.3.7, 4.4.2, 4.4.7, 4.6.2, 4.6.6, 4.7.2, 4.7.6

Index

T

Target system	7.2.2
Terminal	7.2.1
Threshold	4.2.9, 4.3.10, 4.4.10, 4.6.3
Threshold Frequency	4.4.10
Threshold Level	4.2.9, 4.3.10
Time	4.2.3, 4.3.3, 4.4.3, 4.6.4, 4.7.2, 4.7.3
Time Detection	4.2.2, 4.2.7, 4.7.2, 4.7.7
Time Length	4.2.3, 4.3.3, 4.4.3, 4.6.4, 4.7.3
Time Marker	4.7.8
Title	6.1, 6.3
Trace	2.1, 4.2.2, 4.3.2, 4.4.2, 4.6.2, 4.7.2
Trace Mode	4.1, 4.2.2, 4.3.2, 4.4.2, 4.6.2, 4.7.2
Trigger	2.1, 3.2, 3.2.2
Trigger Delay	3.2
Trigger Level	3.2
Trigger Slope	3.2
Trigger Source	3.2
Trigger Switch	3.2
Type	4.3.5, 4.6.9

U

Unwrap Phase Ref	4.5.7
------------------	-------

V

Vertical	4.2.4, 4.3.4, 4.4.4
Video trigger	3.2.2
View	4.3.2, 4.3.6, 4.4.2, 4.4.6

W

Warm Up	6.2
Wide IF video trigger	3.2.2
Width	4.2.4, 4.4.4
Window function	Appendixes D, E

X

XdB Value	4.2.10
-----------	--------

Z

Zone Center	4.2.8, 4.7.8
Zone marker	4.2.8, 4.7.8
Zone Width	4.2.8
Zoom	4.2.8, 4.3.9, 4.4.9
Zoom Out	4.2.8, 4.3.9, 4.4.9