

Anritsu Advancing beyond

Field Master™

Handheld RF Spectrum Analyzer

MS2080A

9 kHz to 4 GHz

9 kHz to 6 GHz



Introduction

Anritsu is proud to introduce the next line in handheld spectrum analyzer with real-time spectrum analysis. With frequency coverage up to 6 GHz, the new Field Master™ MS2080A completely redefines the standards for portable handheld analyzers, setting another new industry benchmark for performance and accuracy. The new MS2080A is the culmination of over 60 years of microwave test and measurement equipment development, using the very latest technologies to deliver accuracy and precision in measurements previously reserved only for benchtop instruments.

Instrument Highlights

- Modulation Bandwidth: 20 MHz standard
40 MHz with Option 102
- Dynamic Range: > 105 dB Typical
- DANL: -167 dBm Typical with Preamp On
- Sweep Speed: 45 GHz/s (Option 102)
- Resolution Bandwidth (RBW): 1 Hz up to 5 MHz
- RTSA with 2.5 μs POI
- Built In Preamplifier Included as Standard
- Battery Life > three hours
- Level Accuracy: ±1 dB

Capabilities and Functional Highlights

- 5GNR FDD/TDD FR1 Analyzer
- Real-Time Spectrum Analyzer
- LTE FDD and TDD Analyzer
- Spectrogram
- Gated Sweep
- AM/FM Audio Demodulation
- Field Strength
- EIRP
- Occupied Bandwidth
- Channel Power
- Adjacent Channel Power
- Spectral Emissions Mask
- Signal Strength and RSSI
- Carrier Aggregation
- Coverage Mapping in SPA, 5GNR, and LTE
- Carrier-to-Interference
- Trace Recording/Playback
- High Accuracy Power Measurements (external sensor sold separately)
- Cable and Antenna Analyzer
- Interference Finder
- Multi-language Support
- Built-in PDF Report Generator

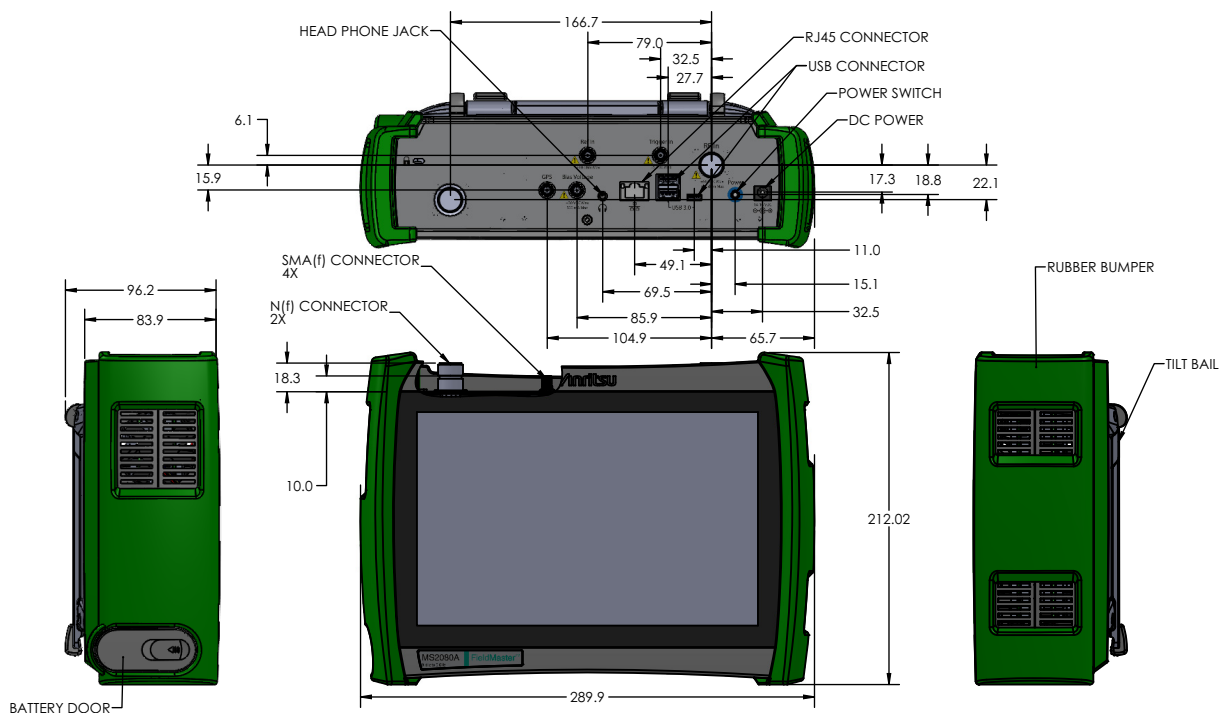

MS2080A

All dimensions in mm

Table of Contents

Definitions..... 3

Spectrum Analyzer Features 4

Spectrum Analyzer Performance 5

Real-Time Spectrum Analyzer Features (Option 199) 7

High Accuracy Power Meter (Option 19) 8

Interference Finder and AM/FM Audio Demodulation (Option 24) 8

GNSS Receiver (Option 31) 8

Gated Sweep (Option 90) 9

Cable and Antenna Analyzer 9

Coverage Mapping (Option 431) 10

AM/FM Modulation Measurement (Option 509)..... 11

LTE FDD/TDD Signal Analyzer (Option 883) 12

5GNR FDD/TDD FR1 Signal Analyzer (Option 888) 14

General Specifications 15

Remote Interface Software 16

Programmable Remote Control 16

Ordering Information – Instrument Options 16

Standard Accessories 17

Related Manuals 17

USB Power Sensors and S331P Site Master Cable and Antenna Analyzer 18

Optional Accessories 18

Definitions

Specifications	All specifications and characteristics apply under the following conditions, unless stated otherwise: <ul style="list-style-type: none"> • After 10 minutes of warm-up time, where the instrument is left in the ON state • When using the internal 10 MHz reference signal
Typical Performance	Typical specifications are not tested and are not warranted. They are generally representative of characteristic performance.
Nominal Performance	Nominal specifications are design parameters; they are not tested and are not warranted.
Calibration Cycle	Calibration is within the recommended 12 month period All specifications in this data sheet apply to instruments with Option 704 Rev2 hardware and Option 706 with Rev1 hardware or later. Note that specifications are subject to change without notice. For the most current data sheet, please visit the Anritsu website: www.anritsu.com .

Spectrum Analyzer Features

Smart Measurements

Field Strength	Measures field strength (dBm/m ² , dBW/m ² , dBV/m, dBmV/m, dBμV/m, V/m, W/m ² , W/cm ² , A/m) with antenna gain vs. frequency plot
Channel Power	Measures the total power and power spectral density within a specified bandwidth
Occupied Bandwidth	Measures the 99 % to 1 % power channel of a signal
Adjacent Channel Power	Measures the channel power of the adjacent channel
Spectral Emission Mask	Standards based limits for wireless emissions.
Carrier-to-Interference (C/I)	Measures the ratio of power (dB) in an RF carrier to the interference power in the channel.

Setup Parameters

Frequency	Center/Start/Stop, Frequency Step, Frequency Offset, Gestures
Span	Span (Manual/Increment 1, 2, 5), Full Span, Last Span, Zero Span
Amplitude	Reference Level (Manual/Auto and Offset), Scale/Division, Y-Axis Unit (dBm, dBW, dBV, dBmV, dBμV, dBA, V, W, A), Preamp (On/Off), Attenuation (Auto/Manual), Attenuation Level, Field Strength, Gestures
Bandwidth	RBW/VBW (Auto/Manual), VBW Type (Linear/Logarithmic), RBW:VBW Ratio, SPAN:RBW Ratio
Sweep	Single/Continuous, Restart, Sweep Once, Sweep to N, Auto/Manual Time, Gated Sweep (see "Gated Sweep (Option 90)" on page 9)

Spectrogram

Number of Lines	142
Trace Time/Position Cursor	Up to six cursors (display historical trace data by trace position or time)
Cursor State	Active, Hold/View, Blank
Color Setup	Color Scale Top/Bottom Range, Reference Hue, Preset Setup

Trace Functions

Traces	Up to Six Traces
Trace Type	Clear/Write, Average (2 to 1000), Max Hold, Min Hold, Rolling Average, Rolling Max Hold, Rolling Min Hold
Trace Math	T1-T2, T2-T1 (when T5 and T6 are selected)
Trace Mode	Active, Hold/View, Blank
Detector Type per Trace	Peak, RMS/Avg, Negative, Sample, Normal
Trace Record	Record live samples with manual tagging to internal or external storage
Trace Playback	Play recorded samples from internal or external storage; set playback interval
CSV Logging	Record live or playback traces in CSV format for post processing

Trigger Functions (zero span only)

Sources	Free Run, Video, External
Settings	Level, Delay, Holdoff, Periodic, Slope (Rising/Falling), Hysteresis

Marker Functions

Markers	Up to 12 Markers
Marker Measurements	Amplitude, Frequency (swept spectrum display) Amplitude, Time (Zero Span)
Marker Mode	Normal, Delta, Fixed
Delta Marker	Relative to any Normal or Fixed Marker
Marker Function	None, Noise, Frequency Counter (1 Hz, 100 mHz, 10 mHz, 1 mHz resolutions), Quasi-Peak (per CISPR 16-1-1)
Marker Trace	Assign Marker to any Trace
Peak Search	Peak Search, Next Peak, Next Peak Left, Next Peak Right, Next Point Left, Next Point Right
Peak Search Setup	Peak Threshold, Peak Excursion
Marker	Mkr → Center, Mkr → Ref Level
Marker Table	Up to 12 Markers Showing Marker, Mode, Function, Trace, Frequency, Amplitude, Delta Frequency & Offset

Limit Line Functions

Limit Setup	Upper/Lower, Limit On/Off, Limit Alarm On/Off, Set Default Limit Line, Absolute/Relative
Limit Line Edit	Frequency, Amplitude, Add Point, Add Vertical, Delete Point, Next Point Left/Right
Limit Line Move	Center, X-Offset (Hz), Left, Right, Y-Offset, Up, Down, To Marker 1, Marker 1 Offset (dB)
Limit Line Envelope	Select Envelope (Upper/Lower), Set Envelope, Envelope Points (2-41), Amplitude Offset, Shape (Square/Slope)

Spectrum Analyzer Performance

Frequency (usable to 0 Hz)

MS2080A-0704	9 kHz to 4 GHz (Option 704)
MS2080A-0706	9 kHz to 6 GHz (Option 706)
Tuning Resolution	1 Hz
Span	10 Hz to max frequency, Zero Span
Frequency Reference	Internal, GNSS, External
Internal Frequency Reference	Standard TCXO: Aging: $\pm 1.0 \times 10^{-6}$ per year Accuracy: $\pm 2.8 \times 10^{-7}$ (-10°C $\pm 55^\circ\text{C}$) plus aging (see "GNSS Receiver (Option 31)" on page 8 for improved accuracy)
External Frequency Reference	10 MHz, -10 dBm to +10 dBm

Bandwidth

Analysis Bandwidth	20 MHz (standard), 40 MHz (Option 102)
Resolution Bandwidth (RBW)	1 Hz to 5 MHz, 10 Hz to 10 MHz in zero span (standard), 10 Hz to 20 MHz in zero span (Option 102)
Video Bandwidth (VBW)	1 Hz to 5 MHz, 10 Hz to 10 MHz in zero span (standard), 10 Hz to 20 MHz in zero span (Option 102)
RBW Selectivity	4:1 nominal (-60 dB / -3 dB)
CISPR Bandwidth	Resolution bandwidth when using Quasi-Peak marker function: 200 Hz, 9 kHz, and 120 kHz

Sweep

Manual Sweep	Maximum sweep time is 3600 s (1 hour)
Sweep Points	10 to 10,001 (1001 in zero span)
Sweep Rate (non-zero span)	32 GHz/s (standard), 45 GHz/s (Option 102)

Zero Span

Sweep Time	60 ns to 3600 s in zero span
Sweep Time Accuracy	$\pm 2\%$ in zero span

Spectral Purity – SSB Phase Noise

	SSB Phase Noise	
Offset from 1 GHz RF Input	Maximum	Typical
10 kHz	-93 dBc/Hz	-94 dBc/Hz
100 kHz	-95 dBc/Hz	-97 dBc/Hz
1 MHz	-120 dBc/Hz	-123 dBc/Hz

Spurs

Residual Spurious	< -110 dBm (RF input terminated, 0 dB input attenuation, > 10 MHz, preamp On) < -95 dBm (RF input terminated, 0 dB input attenuation, 10 MHz to 4 GHz, preamp Off) < -90 dBm (RF input terminated, 0 dB input attenuation, 4 GHz to 6 GHz, preamp Off)
Input-Related Spurious	< -70 dBc (0 dB attenuation, -30 dBm input)
Exceptions, typical	< -68 dBc @ 700 MHz to 3300 MHz with 2086 MHz Input < -65 dBc @ $2*(F1 - 1484)$ MHz, where 3140 MHz < F1 < 3580 MHz < -68 dBc @ F1 - 2086 MHz where 2100 MHz < F1 < 4970 MHz
Local-Oscillator Related Spurious	< -60 dBc nominal for offsets > 1 MHz

Amplitude Ranges

Dynamic Range	105 dB typical at 1 GHz, 2/3 (TOI-DANL) in 1 Hz RBW
Measurement Range	DANL to +30 dBm
Display Range	1 to 15 dB/div in 1 dB steps, ten divisions displayed
Reference Level Range	-150 dBm to +30 dBm
Attenuator Resolution	0 to 50 dB, 5 dB steps
Reference Level Offset	99.9 dB external loss to 99.9 dB external gain
Maximum Continuous Input	+30 dBm CW, ± 50 VDC (≥ 10 dB attenuation) +23 dBm CW, ± 50 VDC (< 10 dB attenuation) +10 dBm CW, ± 50 VDC (preamp ON)
Damage Level	5 W (+37 dBm) to 6 GHz

Amplitude Accuracy (≥ 10 dB attenuation, -50 dBm \leq input signal \leq -10 dBm, 1 kHz RBW, auto-coupled, excluding effects of VSWR, noise, and spurs. Values below 100 kHz are with preamp off))

	20°C to 30°C (after 30 minute warm-up)		-10°C to 55°C (after 60 minute warm-up)	
Frequency Range	Maximum	Typical	Maximum	Typical
9 kHz to 6 GHz	± 1.0 dB	± 0.5 dB	± 2.0 dB	± 0.5 dB

Displayed Average Noise Level (DANL) (RMS detection, VBW/Avg type = Log, reference level = -20 dBm for preamp Off and -50 dBm for preamp On, auto attenuation On, normalized to 1 Hz RBW)

Frequency Range	Preamp = On		Preamp = Off	
	Maximum	Typical	Maximum	Typical
10 MHz to 2 GHz	-161 dBm	-167 dBm	-142 dBm	-150 dBm
> 2 GHz to 4 GHz	-160 dBm	-165 dBm	-140 dBm	-146 dBm
> 4 GHz to 5 GHz	-157 dBm	-162 dBm	-137 dBm	-144 dBm
> 5 GHz to 6 GHz	-152 dBm	-160 dBm	-133 dBm	-142 dBm

Third-Order Intercept (TOI) (-20 dBm tones 100 kHz apart, 0 dB input attenuation, preamp Off, reference level -20 dBm)

1 GHz	+7 dBm, Typical
2 GHz	+11 dBm, Typical
3 GHz	+14 dBm, Typical
4 GHz	+13 dBm, Typical
5 GHz	+15 dBm, Typical
6 GHz	+17 dBm, Typical

Second Harmonic Distortion (0 dB input attenuation, -30 dBm input, preamp Off)

50 MHz	-65 dBc maximum
> 50 MHz to 3 GHz	-70 dBc, typical

VSWR (≥ 10 dB input attenuation)

9 kHz to 2.0 GHz	1.5:1 typical
2 GHz to 6.0 GHz	1.8:1 typical

Real-Time Spectrum Analyzer Features (Option 199)

Setup Parameters

Frequency	Center/Start/Stop, Frequency Step, Frequency Offset Gestures (Drag Center Frequency (on/off), Pinch Span (on/off))				
Span	Span, Full Span (max span: 20 MHz standard, 40 MHz with Option 102)				
Amplitude	Reference Level (Manual/Auto and Offset), Scale/Division, Y-Axis Unit (dBm, dBW, dBV, dBmV, dBμV, dBA), Preamp (on/off), Attenuation (Auto/Manual), Gestures (Drag Ref Level (on/off))				
Bandwidth	RBW (span dependent), Auto RBW, Span/RBW Ratio (1-100000)				
Probability of Intercept	Analysis Bandwidth	Density Resolution	Span	RBW	POI
	20 MHz (Standard)	Normal	20 MHz	3 MHz	3.036 μs
		High	20 MHz	3 MHz	4.929 μs
	40 MHz (Option 102)	Normal	40 MHz	5 MHz	2.464 μs
		High	40 MHz	5 MHz	4.357 μs
Density Color	Set Color Top/Bottom Range, Auto Scale				
Persistence	Infinite or Variable from 0 to 10 s				
Acquisition Time	50 ms to 5 s				
FFT Rate	527,000 FFT/s (normal resolution), 263,000 FFT/s (high resolution)				
Minimum Detectable Signal	9 ns				

Sweep Functions

Sweep	Single/Continuous, Sweep Once
-------	-------------------------------

Trace Functions

Traces	Up to Six Traces
Trace Type	Clear/Write, Average (2 to 1000), Max Hold, Min Hold, Rolling Average, Rolling Max Hold, Rolling Min Hold
Trace Mode	Active, Hold/View, Blank
Detector Type per Trace	Peak, Sample, Negative, Normal
Trace Record	Record live samples with manual tagging to internal or external storage (only applies to trace and not for spectral density graphic)
Trace Playback	Play recorded samples from internal or external storage; set playback interval (only applies to trace and not for spectral density graphic)
CSV Logging	Record live or playback traces in CSV format for post processing

Spectrogram

Number of Lines	142
Trace Time/Position Cursor	Up to Six Cursors (display historical trace data by trace position or time)
Cursor State	Active, Hold/View, Blank
Color Setup	Set Color Top/Bottom Range, Set Color Reference Hue

Marker Functions

Markers	Up to 12 Markers
Marker Measurements	Power, Frequency, Time (Spectrogram)
Marker Mode	Normal, Delta, Fixed
Delta Reference Marker	Relative to any Normal or Fixed Marker
Marker Function	None, Noise
Marker Trace	Assign Marker to any Trace
Peak Search	Peak Search, Next Peak, Next Peak Left, Next Peak Right, Next Point Left, Next Point Right
Peak Search Setup	Peak Threshold, Peak Excursion
Marker →	Mkr → Center, Mkr → Ref Level
Marker Table	On/Off, up to 12 Markers Showing Marker Mode, Function, Trace, Frequency, Amplitude, Delta Frequency & Offset

Limit Line Functions

Limit Setup	Upper/Lower, Limit On/Off, Limit Alarm On/Off, Set Default Limit Line, Limit Type: Absolute/Relative
Limit Line Edit	Selected Point, Frequency, Amplitude, Add Point, Add Vertical, Delete Point, Next Point Left/Right
Limit Line Move	Center, X-Offset, Left, Right, Y-offset, Up, Down, Marker Offset, To Marker 1
Limit Line Envelope	Select Envelope (Upper/Lower), Envelope Points (41 max), Amplitude Offset, Shape (Square/Slope) Set Envelope

High Accuracy Power Meter (Option 19) (requires external USB power sensor, sold separately)

Amplitude Setup	Maximum Display, Minimum Display, External Gain, External Loss, Relative Power On/Off, Units (dBm, W)			
Zero/Cal Limits	# of Running Averages, Max Hold, Measuring Mode (Continuous/Single), Run/Hold, Sensor Info			
	Limit On/Off, Upper/Lower Limit, Alarm On/Off			
Power Sensor Model	MA24106A	MA24108A/18A/26A	MA24208A/18A	MA24330A/40A/50A
Description	High Accuracy RF Power Sensor	Microwave USB Power Sensor	Microwave Universal USB Power Sensor	Microwave CW USB Power Sensor
Frequency Range	50 MHz to 6 GHz	10 MHz to 8/18/26 GHz	10 MHz to 8/18 GHz	10 MHz to 33/40/50 GHz
Connector	Type N(m), 50 Ω	Type N(m), 50 Ω (8/18 GHz) Type K(m), 50 Ω (26 GHz)	Type N(m), 50 Ω	Type K(m), 50 Ω (33/40 GHz) Type V(m), 50 Ω (50 GHz)
Dynamic Range	-40 dBm to +23 dBm (0.1 μW to 200 mW)	-40 dBm to +20 dBm (0.1 μW to 100 mW)	-60 dBm to +20 dBm (1 nW to 100 mW)	-70 dBm to +20 dBm (0.1 nW to 100 mW)
Measurand	True-RMS	True-RMS, Slot Power, Burst Average Power	True-RMS, Slot Power, Burst Average Power	Average Power
Measurement Uncertainty	±0.16 dB ^a	±0.18 dB ^b	±0.17 dB ^c	±0.17 dB ^d
Data Sheet (for complete specifications)	11410-00424	11410-00504	11410-00841	11410-00906
Notes:	<p>a. Total RSS measurement uncertainty (0 °C to 50 °C) for power measurements of a CW signal greater than -20 dBm with zero mismatch errors.</p> <p>b. Expanded uncertainty with K=2 for power measurements of a CW signal greater than -20 dBm with zero mismatch errors.</p> <p>c. Power uncertainty expressed with two sigma confidence level for CW measurement after zero operation. Includes calibration factor and linearity over temperature uncertainties, but not the effects of mismatch, zero set and drift, or noise.</p> <p>d. Includes linearity over temperature uncertainties, but not the effects of calibration factor, mismatch, zero set and drift, and noise.</p>			

Interference Finder and AM/FM Audio Demodulation (Option 24) (requires GNSS Receiver (Option 31))
The interference finder option is available in spectrum analyzer or RTSA (Option 199).

Supported Features

- Interference Finding Audio Tone
- AM/FM Audio Demodulation
- Interference Triangulation Mapping (recommended InterferenceHunter™ MA2700A)
- Interference Polar Plot (requires InterferenceHunter MA2700A)

Interference Finder Audio Tone (for use with directional antennas, sold separately)

Setup	Integration Bandwidth, Power Limit (on/off), MAX/MIN Level, Volume, Mute (on/off)
Audio Tone	20 Hz to 20 kHz (tone pitch and volume changes with detected signal strength)

AM/FM Audio

Demod Frequency	Full range of instrument
Audio Demodulation	AM, USB, LSB, Wideband FM, Narrowband FM (6.25, 12.5 and 25 kHz)
Markers	Selectable demodulation marker (1 to 12)
Audio	Toggle On/Off
Volume	Set 0 % to 100 %
Record Audio	Record audio up to 100,000 s (dependent on instrument memory)
Squelch Level	-120 dBm to +30 dBm (set RF level threshold to break audio silence, supports log and linear units)
RF Spectrum Setup	Show Density (On/Off), Auto Scale (On/Off), Density Scale Top/Bottom (0 to 100%) Density Resolution (Normal/High), Persistence State (Variable/Infinite), Acquisition Time (0.05 to 5 s)

Interference Map Triangulation (recommended for use with InterferenceHunter MA2700A handle and requires directional antenna, sold separately. If not using MA2700A, Option 31, GNSS and antenna are required)

Triangulation	Triangulates on source of interference location using eCompass and digital maps displayed on screen
Manual Setup	Manual entry of compass bearing values

Interference Polar Plot (requires InterferenceHunter MA2700A handle and directional antenna, sold separately)

Signal Strength Radar Plot	360° radar plot of single frequency signal strength centered on current GNSS location
----------------------------	---

GNSS Receiver (Option 31) (Requires GPS antenna, sold separately)

Supported Satellite Systems	GNSS (includes combinations of GPS, GLONASS, Galileo, BeiDou)
Setup	On/Off, Antenna Voltage 3.3 V/5.0 V, GPS/GNSS Info
GNSS Time/Location Indicator	UTC Time, Latitude, Longitude, and Altitude on display (UTC Time and Altitude on GNSS Info display)
High Frequency Accuracy	< ±2.5 x 10 ⁻⁸ with GNSS On, 3 minutes after satellite lock in selected mode (GNSS antenna connected)
Connector	SMA, female

Gated Sweep (Option 90)

Gate Source	GNSS (GPS)
Frame Time	1 s, 20 ms, 10 ms
Gate Delay	up to 200 ms
Gate Length	1 μ s up to 200 ms
Power vs. Time, Display Length	100 μ s to 200 ms

Cable and Antenna Analyzer (requires external Site Master™ S331P analyzer, sold separately)

Frequency

Frequency Ranges	150 kHz to 4 GHz (S331P-0704) 150 kHz to 6 GHz (S331P-0706)
Frequency Accuracy	\pm 2.5 ppm @ 23 °C \pm 3 °C
Frequency Resolution	1 kHz

Refer to the Site Master S331P Technical Data Sheet (11410-00964) for hardware characteristics, performance specifications, compliance information, and related accessories for the S331P analyzer.

Measurements

- VSWR
- Return Loss
- Cable Loss
- Distance-to-Fault (DTF) Return Loss
- Distance-to-Fault (DTF) VSWR
- Smith Chart 50 Ω
- 1-Port Phase
- Transmission (Ext)

Setup Parameters

Measurement Display	Single/Dual Display with independent markers
Frequency	Start Frequency, Stop Frequency
DTF	Start Distance, Stop Distance, Units m/ft, DTF Aid, Cable List, Cable Loss, Propagation Velocity
Windowing	Rectangular, Normal Side Lobe, Low Side Lobe, Minimum Side Lobe
Amplitude	Top, Bottom, Auto Scale, Full Scale
Sweep	Data Points, Run/Hold, Single/Continuous, RF Immunity (High/Low)
Data Points	130, 259, 517, 1033, 2065
Marker	Markers 1 to 8 (On/Off), Delta Markers 2 to 8 (Ref M1), Track Marker (On/Off), Marker Search (Peak/Valley), Marker Table (on/off), To Memory (On/Off), Mode (Reference), Independent Markers for Frequency and Distance Measurements
Traces	Copy Trace to Memory, Memory Display (Trace Memory, Both) Trace Math: None, Trace - Memory, Trace + Memory, (Trace + Memory)/2
Limit Line	Upper Limit (on/off), Lower Limit (on/off), Upper/Lower Level Limit Test (On/Off), Move Active Limit, Edit Segments (42 upper and 42 lower segments maximum), Limit Alarm, Pass/Fail On/Off, Limit Preset
Calibration	Factory default 1-Port ReadyCal (automatically applied to all measurements) User calibration (User Cal) overrides ReadyCal Start Calibration, Cal Info, User Cal (On/Off), USB CAA Info, Power Sensor Cal Methods: OSL, Ext Transmission, OSL + Ext Trans Cal Types: Standard, FlexCal™
Save/Recall	Quick Save, Setups, Measurements, Screen Shots (saves data (.dat) format for analysis using Line Sweep Tools (LST)), PDF Report (Recall, Report Setup)

Coverage Mapping (Option 431) (Spectrum Analyzer, 5G NR, LTE measurements)

Spectrum Analyzer Measurements

Channel Power	Plots channel power in dBm, dBW, dBV, dBmV, dBµV, dBA, V, W, A
Spectral Density	Plots spectral density in dBm/Hz, dBW/Hz, dBV/Hz, dBmV/Hz, dBµV/Hz, dBA/Hz, V/Hz, W/Hz, A/Hz
RSSI	Plots received signal strength indicator in dBm, dBW, dBV, dBmV, dBµV, dBA, V, W, A
Field Strength	Plots field strength in dBm/m ² , dBW/m ² , dBV/m, dBmV/m, dBµV/m, dBA/m, V/m, W/m ² , W/cm ² , A/m ²
Power Flux Density	Plots power flux density in dBm/m ² /Hz, dBW/m ² /Hz, dBV/m/Hz, dBmV/m/Hz, dBµV/m/Hz, dBA/m/Hz, V/m/Hz, W/m ² /Hz, W/cm ² /Hz, A/m/Hz

Spectrum Analyzer Measurement Setup

Map Type	Indoor: PNG or JPEG Outdoor: OpenStreetMap® (downloaded direct from Internet to instrument or using external PC software)
Frequency (Excluding RSSI)	Center/Start/Stop, Frequency Step, Frequency Offset
Span (Excluding RSSI)	Span (Manual/Increment 1, 2, 5), Full Span, Last Span, Zero Span
Amplitude	Reference Level (Manual/Auto and Offset), Scale/Division, Y-Axis Unit, Preamp (on/off), Attenuation (Auto/Manual), Field Strength
Bandwidth	RBW/VBW (Auto/Manual), VBW Type (Linear/Logarithmic), RBW:VBW Ratio, SPAN:RBW Ratio
Mapping Colors	Customizable Amplitude Range Thresholds for Each Color Blue (Excellent), Green (Very Good), Yellow (Good), Orange (Fair), Pink (Poor)
Point Distance or Time Setup	Repeat Type: Time (1 s to 60 s) or Distance (1 m to 10,000 m), Distance Units: Meters or Feet
Save	Indoor: Setup, Measurement File (fm spa), PNG Outdoor: Setup, KML Points, PNG, Tab Delimited
Recall	Setup, KML Points File, Measurement File (fm spa)

LTE Measurement (Option 883 is required (see [“LTE FDD/TDD Signal Analyzer \(Option 883\)” on page 12](#)))

Channel Power	Plots channel power in dBm, dBW, dBV, dBmV, dBµV, dBA
Spectral Density	Plots spectral density in dBm/Hz, dBW/Hz, dBV/Hz, dBmV/Hz, dBµV/Hz, dBA/Hz
RSRP	Plots received signal strength indicator in dBm, dBW, dBV, dBmV, dBµV, dBA
RSRQ	Plots received signal strength indicator in dBm, dBW, dBV, dBmV, dBµV, dBA
SINR	Plots received signal strength indicator in dBm, dBW, dBV, dBmV, dBµV, dBA

LTE Measurement Setup

Map Type	Indoor: PNG or JPEG Outdoor: OpenStreetMap® (downloaded direct from Internet to instrument or using external PC software)
Frequency	Center Frequency, Channel Bandwidth, EARFCN, Signal Standard
Amplitude	Auto Range (On/Off), Reference Level (Manual/Auto and Offset), Scale/Division, Y-Axis Unit, Preamp (on/off), Attenuation (Auto/Manual)
Bandwidth	RBW/VBW (Auto/Manual), VBW Type (Linear/Logarithmic), RBW:VBW Ratio, SPAN:RBW Ratio
Mapping Colors	Customizable Amplitude Range Thresholds for Each Color Channel Power and Spectral Density: Blue (Excellent), Green (Very Good), Yellow (Good), Orange (Fair), Pink (Poor) RSRP, RSRQ, SINR: Blue (Excellent), Green (Good), Yellow (Poor), Pink (Bad), Gray (No Sync)
Point Distance or Time Setup	Repeat Type: Time (1 s to 60 s) or Distance (1 m to 10,000 m), Distance Units: Meters or Feet
Map Source	Any PCI, Defined PCI
Save	Indoor: Setup, Measurement File (fm lte), PNG Outdoor: Setup, KML Points, CSV, PNG,
Recall	Setup, KML Points File

5G NR Measurement (Option 888 is required (see [“5G NR FDD/TDD FR1 Signal Analyzer \(Option 888\)” on page 14](#)))

Channel Power	Plots channel power in dBm, dBW, dBV, dBmV, dBµV, dBA
Spectral Density	Plots spectral density in dBm/Hz, dBW/Hz, dBV/Hz, dBmV/Hz, dBµV/Hz, dBA/Hz
SS-RSRP	Plots received signal strength indicator in dBm, dBW, dBV, dBmV, dBµV, dBA
SS-RSRQ	Plots received signal strength indicator in dBm, dBW, dBV, dBmV, dBµV, dBA
SS-SINR	Plots received signal strength indicator in dBm, dBW, dBV, dBmV, dBµV, dBA

5G NR Measurement Setup

Map Type	Indoor: PNG or JPEG Outdoor: OpenStreetMap® (downloaded direct from Internet to instrument or using external PC software)
Frequency	Center Frequency, Channel Bandwidth, EARFCN, Signal Standard
Amplitude	Auto Range (On/Off), Reference Level (Manual/Auto and Offset), Scale/Division, Y-Axis Unit, Preamp (on/off), Attenuation (Auto/Manual)
Bandwidth	RBW/VBW (Auto/Manual), VBW Type (Linear/Logarithmic), RBW:VBW Ratio, SPAN:RBW Ratio
Mapping Colors	Customizable Amplitude Range Thresholds for Each Color Channel Power and Spectral Density: Blue (Excellent), Green (Very Good), Yellow (Good), Orange (Fair), Pink (Poor) SS-RSRP, SS-RSRQ, SS-SINR: Blue (Excellent), Green (Good), Yellow (Poor), Pink (Bad), Gray (No Sync)
Point Distance or Time Setup	Repeat Type: Time (1 s to 60 s) or Distance (1 m to 10,000 m), Distance Units: Meters or Feet
Map Source	Any PCI, Defined PCI
Save	Indoor: Setup, Measurement File (fm 5gnr), PNG Outdoor: Setup, KML Points, PNG, CSV
Recall	Setup, KML Points File

AM/FM Modulation Measurement (Option 509) (Spectrum Analyzer, RTSA, IA Spectrum and IA RTSA measurements)

AM Measurements

AM Depth	0% to 100%, ±2% accuracy, typical
AM Bandwidth	20 kHz
AM Standards	Standard AM, Upper/Lower Sideband suppressed carrier
SINAD	0 to 60 dB, nominal based on 1kHz modulating tone
THD	-60 dB, using up to 10 harmonics of 1 kHz modulating tone
Demodulated AM Spectrum	Frequency Scale, 0 to 24 kHz
Audio Time Domain	5 s or auto zoomed
Graphs	Audio Spectrum (Log AM depth percentage vs frequency), RF Spectrum Audio Time Domain (Linear AM depth percentage vs time), Audio Results
Audio Results	Signal Power (dBm), Carrier Frequency, RMS Depth, (Peak-to-peak)/2 Depth, Peak Positive/Peak Negative Depth, SINAD (dB), Upper/Lower AM Depth, THD (dB)
Setup	Demodulation Frequency, Demodulation Marker (on/off), Marker Tracked (1 to 12), Zoomed Time Graph (on/off), Modulation (AM, USB, LSB), Audio (on/off), Volume (on/off), Record Duration (1 to 100000 S), Record, Squelch Level (-120 to 30 dBm)

FM Measurements

FM Bandwidth	96 kHz (wide)
FM Deviation	Up to 75 kHz with 2% accuracy, ±1 kHz typical
SINAD	0 to 60 dB, nominal based on 1 kHz modulating tone
THD	-75 to 0 dB, using up to 10 harmonics of 1 kHz modulating tone
Demodulated FM Spectrum	Wideband: 96 kHz full span, 20 kHz zoomed Narrowband: 25 kHz, 24 kHz (audio spectrum) 12.5 kHz, 14 kHz (audio spectrum) 6.25 kHz, 6 kHz (audio spectrum)
Audio Time Domain	5 s or auto zoomed
Graphs	Audio Spectrum (Log FM deviation vs frequency), RF Spectrum Audio Time Domain (Linear FM deviation vs time), Audio Results
Audio Results	Signal Power (Hz), Carrier Frequency, RMS FM deviation, (Peak-to-peak)/2 Deviation, SINAD, Total Harmonic Distortion (THD) Peak Positive/Negative Deviation
Setup	Demodulation Frequency, Demodulation Marker (on/off), Marker Tracked (1 to 12), Zoomed Audio Graph (on/off), Zoomed Time Graph (on/off), Modulation (FM Narrowband (6.25, 12.5, 25 kHz), FM Wideband), Audio (on/off), Volume (on/off), Record Duration (1 to 100000 S), Record, Squelch Level (-120 to 30 dBm)

LTE FDD/TDD Signal Analyzer (Option 883)

General	
Frequency Range	10 MHz to 6 GHz (option dependent)
Channel Bandwidth (MHz)	1.4, 3, 5, 10, 15, 20
Amplitude	Auto Range, Reference Level (Manual/Auto), Scale/Division, Y Axis Unit, Attenuation Level (Auto/Manual), Reference Level Offset, Preamp
Input Signal Range	-76 dBm to +10 dBm
Sweep	Single/Continuous, Hold (On/Off)
MIMO Antenna Setup	Auto, Antenna 0, 1, 2, or 3
LTE Demodulation Summary	
PCI Summary Measurements	Physical Cell ID, Sector ID, Cell Group, Frequency Error, Time Offset, Cyclic Prefix, Status of Primary Synchronization Signal (PSS), MIMO Time Alignment Error, Resource Block Power
Signal Power Measurements (dBm)	Physical Broadcast Channel Power (PBCH), Sync Signal (SS), Reference Signal (RS), OFDM Symbol Transmit Power (OSTP)
Error Vector Magnitude Measurements (%)	Physical Broadcast Channel (QPSK), Physical Downlink Shared Channel (QPSK), PDSCH (16-QAM/64-QAM/256-QAM)
Demod Summary View	PCI, Sector ID, Cell Group, Frequency Error, Time Offset, Cyclic Prefix, Sync Status, Power (PBCH, SS, RS), EVM (PBCH(QPSK), PDSCH (QPSK, 16-QAM, 64-QAM, 256-QAM), Average EVM, Peak EVM
Time Alignment Error (TAE) View	PCI, Sector ID, Cell Group, Frequency Error, Time Offset, Cyclic Prefix, Sync Status, TAE between each antenna pair, Power (RS, SS), EVM (RMS, PEAK)
Resource Block View	PCI, Sector ID, Cell Group, Frequency Error, Time Offset, Cyclic Prefix, Sync Status, RB (number of active RBs, Utilization, OSTP), EVM (QPSK, 16-QAM, 64-QAM, 256-QAM)
Setup Parameters	Antenna (Auto/1/2/3/4), Cyclic Prefix (Auto/Normal/Extended), Duplex Type (FDD/TDD), UL/DL Config (TDD only), CFI (Auto/CFI1/CFI2/CFI3), SSB Offset, Auto Detect SSB
RS Power Accuracy	±1.0 dB typical (RF input -50 dBm to +10 dBm)
Frequency Error	±10 Hz + time base error (99 % confidence level)
Residual EVM (rms)	2.0 % typical (E-UTRA Test Model 3.1, RF Input -50 dBm to +10 dBm)
LTE DSS Detection	
Setup Parameters	DSS Detect (On/Off), Status, PCI, Beam, SS-RSRP
LTE Multi PCI	
Measurements	Multiple Physical Cell IDs, Secondary Sync Signal Power (S-SS), Reference Signal Received Power (RSRP), Reference Signal Received Quality (RSRQ), Signal to Interference and Noise Ratio (SINR), Average Error Vector Magnitude (EVM), Peak EVM, Frequency Error (Hz and PPM), Dominance (dB)
Graph Displays	PCI, SINR, RSRP, RSRQ, SS Power
Setup Parameters	Cyclic Prefix (Auto/Normal/Extended), Duplex Type (FDD/TDD), UL/DL Config (TDD only), CFI (Auto/CFI1/CFI2/CFI3), DSS Detect On/Off (Status, PCI, Beam, SS-RSRP), SSB Offset, Auto Detect SSB
LTE Channel Power	
Measurements	Total Channel Power, Total Power Spectral Density (PSD), Limit Test (Power and PSD)
Setup Parameters	Integration Bandwidth, PSD Units (Hz/MHz), Power Limit (dBm), PSD Limit (dBm/Hz)
RF Channel Power Accuracy	±1 dB typical (-50 dBm to +10 dBm)
LTE Channel Spectrum	
Measurements	Occupied Bandwidth (OBW), Total Power, Reference Signal (RS), Frequency Error, Limit Test (OBW)
Setup Parameters	% OBW Power (%/dB), XdB, OBW Limit (on/off) (Hz), Method (percent (%), x dB)
LTE Carrier Aggregation	
Measurements	Carrier, Physical-layer Cell ID (PCI), RSRP, RSRQ, SINR, EVM (% RMS), Frequency Error (Hz), Bandwidth (BW), Center Frequency, Antennas
Setup Parameters	Carrier, Carrier Count (up to eight), Antenna (Auto/0/1/2/3), Cyclic Prefix (Auto/Normal/Extended), Duplex Type (FDD/TDD)
LTE Control Channel	
PCI Summary Measurements	Physical Cell ID, Sector ID, Cell Group, Frequency Error, Time Offset, Cyclic Prefix, Status of Primary Synchronization Signal (PSS)
Power Measurements	Reference Signal (RS), P-Primary Synchronization Signal (P-SS), Secondary Synchronization Signal (S-SS), Physical Broadcast Channel (PBCH), Physical Control Format Indicator Channel (PCFICH), Physical Hybrid Automatic Repeat Request Indicator Channel (PHICH), Physical Downlink Control Channel (PDCCH), Total Power per Resource Element and Power (dBm/watts), EVM (%)
Setup Parameters	Antenna (Auto/0/1/2/3), Cyclic Prefix (Auto/Normal/Extended), Duplex Type (FDD/TDD), UL/DL Config (TDD only), NG (1/6, 1/2, 1, 2), CFI (Auto/CFI1/CFI2/CFI3)

LTE Constellation

Measurements	Physical Cell ID, Sector ID, Cell Group, Frequency Error, Time Offset, Cyclic Prefix, Status of Primary Synchronization Signal (PSS), Constellation Display of PBCH or PDSCH
Power Measurements	Reference Signal (RS) Power, P-Primary Synchronization Signal (P-SS) Power, Secondary Synchronization Signal (S-SS) power, RMS EVM (%), Peak RMS, Physical Downlink Started Channel (PDSCH), QPSK, 16-QAM, 64-QAM, 256-QAM
Setup Parameters	Antenna (Auto/0/1/2/3), Cyclic Prefix (Auto/Normal/Extended), Duplex Type (FDD/TDD), UL/DL Config (TDD only), CFI (Auto/CFI1/CFI2/CFI3), Data Select (PBCH/PDSCH), Modulation (All/QPSK/16-QAM/64-QAM/256-QAM), Ref Points

LTE Frame Power

Measurements	Physical Cell ID, Sector ID, Cell Group, Frequency Error, Time Offset, Cyclic Prefix, Status of Primary Synchronization Signal (PSS)
Sub-Frame Power Measurements	Sub-Frame, Slot (0 and 1), Total Frame Power, Uplink and Downlink Pilot Time Slots (DwPTS and UpPTS), and Transmit Off Power
Setup Parameters	Analysis (Frame/Subframe/Slot), SSF Config (Auto/0-9/Invalid), Sub-Frame (0-9), Slot (0/1) Antenna (Auto/0/1/2/3), Cyclic Prefix (Auto/Normal/Extended), Duplex Type (FDD/TDD), UL/DL Config (TDD only), NG (1/6, 1/2, 1, 2)

5G NR FDD/TDD FR1 Signal Analyzer (Option 888)**General**

Frequency Range	10 MHz to 6 GHz (option dependent)
Band Configuration	Manual, Global All or selectable Band #, Absolute Radio Frequency Channel Number (ARFCN), Global Synchronization Raster Channel (GSCN), Channel Bandwidth (5 MHz to 100 MHz in steps of 5 MHz), SSB Offset, Subcarrier Spacing (15, 30, 120, 240 kHz), Mapping Pattern (Auto, P1, P2), Auto SSB Detect
Auto SSB Detect	Searches 3GPP defined GSCN raster
Amplitude	Auto Range, Reference Level, Scale/Division, Y Axis Unit, Reference Level Offset, Attenuation Level (Auto/Manual), Preamp
Input Signal Range	-76 dBm to +10 dBm
Sweep	Single/Continuous, Sweep Once, Hold

5G NR Summary

Multi-Beam Measurements	Physical-layer Cell ID, Beam Index, Sector ID, Cell Group, Frequency Error, Time Offset (μ s), Status, SS-RSRP (dBm), SS-RSRQ (dB), SS-SINR (dB), SS-RSSI (dBm), Sync and Demod Status Indicators
Single-Beam Measurements	Physical Cell ID, Sector ID, Cell Group, Frequency Error, Time Offset, Status, SS-RSRP (dBm), SS-RSRQ (dB), SS-SINR (dB), SS-RSSI, Sync and Demod Status Indicators, Block Measurements (PSS, SSS, PBCH, PBCH-DMRS), Average EVM, Peak EVM (@ subcarrier/symbol), Beam Power (dBm)
Views	Multi-Beam (up to 64), Single Beam
Setup Parameters	SINR Threshold (dB), Duplex Type (FDD/TDD), GMC Offset (μ s), Distance to Antenna (m), Distance Unit (m/ft)
RSRP Accuracy	± 1.0 dB typical
Residual EVM (rms)	2.0 % typical
Frequency Error	< $\pm 4.0E-9$ + time base error, typical (FR1, Channel BW \leq 50 MHz) < $\pm 5.0E-9$ + time base error, typical (FR1, Channel BW > 50 MHz) < $\pm 1.0E-8$ + time base error, typical (FR2)

5G NR OTA (Multi PCI)

Measurements	Multiple Physical-layer Cell (PCI) IDs, Beam Index, SS-RSRP (dBm), SS-RSRQ (dB), SS-SINR (dB), SS-RSSI (dB) SS-EVM (%), Time Offset (μ s)
Views	Multi PCI Beam Scanner (up to 64 beams), Table, Time Offset Table
Setup Parameters	SINR Threshold (dB), Duplex Type (FDD/TDD)

5G NR RF EIRP

Measurements	EIRP (Active, Horizontal/Vertical, Sum), Upper/Lower Limit Test
Views	Normal (RF spectrum), Quick View (summary)
Setup Parameters	Save (Horizontal/Vertical), Reset Sum, RX Antenna Gain, Distance to Antenna, Distance Unit (Meters/Feet), Upper/Lower Limit Test, RX Cable Loss (dB)

5G NR RF Occupied Bandwidth

Measurements	Occupied Bandwidth, Total Power, Limit Test
View	Normal (RF Spectrum)
Setup Parameters	Method (% or X dB), % OBW Power, OBW Limit (On/Off), X dB

5G NR RF Channel Power

Measurements	Total Channel Power, Total PSD, Limit Test
View	Normal (RF Spectrum)
Setup Parameters	Integration Bandwidth, PSD Units (Hz and MHz), Power Limit (On/Off), PSD Limit (On/Off)
RF Channel Power Accuracy	± 1 dB typical (-76 dBm to +10 dBm)

5G NR Carrier Aggregation

Component Carriers	Up to Eight Component Carriers
PCI Measurements	Carrier, Sync status (PSS), Physical-layer Cell ID (PCI), Center Frequency, Bandwidth (BW), RSRP Max, EVM (RMS), Frequency Error (Hz), Time Offset
Setup Parameters	Carrier, Carrier Count (up to 8), Duplex Type (FDD/TDD)

5G NR Constellation

Measurements	Beam, PBCH-DMRS Power, PSS Power, SSS Power, RMS EVM, Peak EVM
PCI Measurements	Physical Cell ID, Sector ID, Cell Group, Frequency Error, Time Offset, Status
Setup Parameters	Modulation (QPSK), Data Select (PBCH), Beam Select, Reference Points (on/off)

5G NR Spectral Emission Mask (supported in normal spectrum analyzer mode)

Measurements	Segment, RBW, Peak PWR, Peak Freq
Setup Parameters	Select Mask, Import Mask, Export Mask, REF CH BW, Auto Max PWR, Manual Max PWR

5G NR Adjacent Channel Power (supported in normal spectrum analyzer mode)

Measurements	Channel, Absolute, Relative, Limit
Setup Parameters	Channel Spacing, Main Integ BW, ADJ Integ BW, ALT Integ BW, Limit Type, Limits, Main CH Limit, ADJ CH Limit, ALT CH Limit

General Specifications

Setup and File Parameters

Date and Time	Date and Time settings, Time Zone settings, Time synced to Internet/GNSS
Language	English, Spanish, Chinese-simplified, Japanese, French, Korean
Display	Brightness adjustment, Auto screen dimming shutoff timer (On/Off), Color schemes (Default, Light, Black & White, Night Vision)
Screen Shot Settings	Image capture size, Image header/footer
Option Configuration	Enable options using file (USB)
GNSS (GPS)	see "GNSS Receiver (Option 31)" on page 8
Ethernet	Ethernet (IP4 & IP6 formats), Type (DHCP, Static)
Reset	Factory Reset, Delete All User Files, Delete System Files, Master Reset, Diagnostics
Diagnostics	Self Test, Service Tools, exportable event and system error logs
Save/Recall	Measurement Setup, Screenshot Image (PNG), Export Measurement data (DAT, TXT, CSV), Location (saved CAA measurements are compatible with Line Sweep Tools (LST))
File Management	Save, Copy, Paste, Delete, Create New Folder, Set File Name and File Type, Rename

Report Generator

PDF Reports	Creates detailed measurement reports on the instrument
Report Contents	Free form text fields to identify and locate the site of measurements, company logo image, Cable and Antenna analyzer trace files, instrument screen captures and site photographs
Report Format	PDF and HTML

Connectors

RF In	Type N(f), 50 Ω
GPS	SMA(f)
External Power	5.5 mm barrel connector, 14 to 16 VDC
Ethernet Interface	RJ45 connector for Ethernet 10/100/1000 Mbps (connect to PC or LAN for remote access)
USB Interface	Two USB 3 Type A (supports file transfer) One USB 3 Type C (USBTMC)
Headset Jack	3.5 mm headset jack
External Reference In	SMA(f), 50 Ω
External Trigger In	SMA(f), 50 Ω, TTL-compatible levels
DC Bias Voltage	SMA(f), Setup: On/Off, Voltage, Trip Reset Voltage Range: +1 V to +34 V, Resolution: 0.1 V

Display and Keyboard

Display	10.1-inches capacitive touchscreen, 1280 x 800 resolution
Shortcuts	Maximum of five user-configured measurement setup shortcuts
Screen Strength	IK08 (protected against a five joule impact)
Keyboard	Common alphanumeric/symbolic keys and customizable EZ keyboard
Touch Gestures	Pinch to zoom x (span), Drag in x (center frequency, markers, limit line points)
Toolbar	System menu, application menu, camera icon, USB eject icon, software update icon, local host icon, lock status (touchscreen), notification icon, Wi-Fi icon, GNSS icon, battery percentage icon, time and date

Battery

Type	Li-ion
Internal Battery	3 hours operation, typical
Charging Temperature Limit	0 °C to +45 °C, relative humidity ≤ 80 %
Nominal Capacity	8400 mAh
Nominal Energy	94 Wh
External Battery Accessory	6 hours operation, typical (with an accessory battery contained in soft carrying case)

Regulatory Compliance

European Union	EMC 2014/30/EU, EN 61326-1:2013 CISPR 11/EN 55011, IEC/EN 61000-4-2/3/4/5/6/8/11 Low Voltage Directive 2014/35/EU Safety EN 61010-1:2010 RoHS Directive 2011/65/EU & 2015/863
United Kingdom	EMC SI 2016/1091; BS EN 55011 & BS 61000-4-2/3/4/5/6/8/11 Consumer Protection (Safety) SI 2016/1101; BS EN 61010-1:2010 Environmental Protection SI 2012/3032;2011/65/EU & 2015/863
Australia and New Zealand	RCM AS/NZS 4417:2012
South Korea	KCC-REM-A21+-0004
Canada	ICES-3(A)/NMB-3(A)
United States	FCC ID: SQG-60SIPT

Environmental	MIL-PRF-28800F Class 2
Operating Temperature Range	-10°C to 55°C
Storage Temperature Range	-51°C to 71°C
Maximum Relative Humidity	95 % RH at 30°C, non-condensing
Vibration, Sinusoidal	5 Hz to 55 Hz
Vibration, Random	10 Hz to 500 Hz
Half Sine Shock	30 g _n
Altitude	4600 meters, operating and non-operating
Explosive Atmosphere	MIL-PRF-28800F Section 4.5.6.3 MIL-STD-810G, Method 511.5, Procedure 1
Ingress Protection Rating	Complies with IP52 when installed in soft carrying case

Warranty	Duration	Standard three-year warranty One-year warranty on battery
-----------------	----------	--

Size and Weight	Size	290 mm x 212 mm x 96 mm (11.4 in x 8.3 in x 3.7 in)
	Weight	MS2080A-0704, -0706: 3.8 kg (8.39 lb)

Remote Interface Software

Functionality	Free MS2080A software download from www.anritsu.com Full instrument graphical user interface control from a PC with simulated hardware support for on-screen measurement analysis
Interfaces	Ethernet, WLAN

Programmable Remote Control

Functionality	Full instrument programming control (except power On/Off) via Ethernet and Wi-Fi, and USBTMC. See the Programming Manual for details.
Programming Language	Standard Commands for Programmable Instruments (SCPI)
Interfaces	Ethernet, WLAN, USBTMC (USB C port)

Ordering Information – Instrument Options



Part Number	Description
MS2080A	Field Master Spectrum Analyzer (Requires Option 704 or 706)
Options	
MS2080A-0704	9 kHz to 4 GHz Spectrum Analyzer
MS2080A-0706	9 kHz to 6 GHz Spectrum Analyzer
MS2080A-0019*	High Accuracy Power Meter (requires compatible USB power sensor, sold separately)
MS2080A-0024*	Interference Finder (requires GNSS Receiver Option 31, and directional antenna, sold separately)
MS2080A-0031*	GNSS Receiver (requires GPS antenna, sold separately)
MS2080A-0090*	Gated Sweep
MS2080A-0102*	40 MHz Analysis Bandwidth (20 MHz standard)
MS2080A-0199*	Real Time Spectrum Analyzer
MS2080A-0431*	Coverage Mapping (requires GNSS Receiver Option MS2080A-0031)
MS2090A-0509*	AM/FM Modulation Measurement
MS2080A-0883*	LTE FDD/TDD Measurements (requires GNSS Receiver Option MS2080A-0031)
MS2080A-0888*	5G NR FDD/TDD FR1 Measurements (requires GNSS Receiver Option MS2080A-0031)
MS2080A-xxxx-0097	Accredited Calibration to ISO17025 and ANSI/NCSL Z540-1
MS2080A-xxxx-0098	Standard Calibration to ISO17025 and ANSI/NCSL Z540-1
MS2080A-xxxx-0099	Premium Calibration to ISO17025 and ANSI/NCSL Z540-1 plus test data
* Time-Limited Options	Options marked with an asterisk are offered as a 90-day time limited option by ordering as a -9xxx series option. For example, MS2080A-9888 is the 90-day time limited option for 5G NR FDD/TDD FR1 Measurements. The option start time begins when the user first activates the option.
Supported Software	MX280007A Mobile InterferenceHunter™ MS2080A PC Remote User Interface

Standard Accessories (included with instrument)

Accessory	Description
	2000-2071-R MS2080A Soft Case
	Certificate of Calibration and Conformance
	633-79 Li-ion Battery, 94Wh
	40-204-R AC/DC Power Adapter (Field Master Series)





Accessory	Description
	2000-1371-R Ethernet Cable, 2 m
	2000-1859-R USB Cable, USB 3.0 Type-A to Type-C, 1 m
	806-442-R SMA(m) to BNC(m) cable, 1 m
	2000-2054-R SMA(m) to BNC(f) Adapter (qty 3)

Related Manuals (available at www.anritsu.com)

Part Number	Description
10100-00069	Product Information, Compliance, and Safety
10580-00483	Field Master User Guide
10580-00484	Field Master Programming Manual
10580-00447	Field Master Series Spectrum Analyzer Measurement Guide Interference Finder (Option 24, requires Option 31) Gated Sweep (Option 90) Coverage Mapping (Option 431) AM/FM Modulation Measurement (Option 509)
10580-00448	Field Master Series RTSA Measurement Guide (Option 199) Interference Finder (Option 24, requires Option 31)
10580-00449	Field Master Series 5GNR Measurement Guide (Option 888) Gated Sweep (Option 90) Coverage Mapping (Option 431, requires Option 31)
10580-00450	Field Master Series LTE Measurement Guide (Option 883) Gated Sweep (Option 90) Coverage Mapping (Option 431)
10580-00492	Field Master Series High Accuracy Power Meter Measurement Guide (Option 19)
10580-00493	Field Master Series Cable and Antenna Analyzer Measurement Guide (Option 331)





USB Power Sensors and S331P Site Master Cable and Antenna Analyzer (for complete ordering information, see the respective data sheets of each sensor)

Accessory	Description
	MA24330A Microwave CW USB Power Sensor, 10 MHz to 33 GHz, +20 dBm
	MA24340A Microwave CW USB Power Sensor, 10 MHz to 40 GHz, +20 dBm
	MA24350A Microwave CW USB Power Sensor, 10 MHz to 50 GHz, +20 dBm
	MA24208A Microwave Universal USB Power Sensor, 10 MHz to 8 GHz, +20 dBm to -60 dBm
	MA24218A Microwave Universal USB Power Sensor, 10 MHz to 18 GHz, +20 dBm to -60 dBm
	MA24106A High Accuracy RF Power Sensor, 50 MHz to 6 GHz, +23 dBm to -40 dBm

Accessory	Description
	MA24108A Microwave USB Power Sensor, 10 MHz to 8 GHz, +20 dBm to -40 dBm
	MA24118A Microwave USB Power Sensor, 10 MHz to 18 GHz, +20 dBm to -40 dBm
	MA24126A Microwave USB Power Sensor, 10 MHz to 26 GHz, +20 dBm to -40 dBm
	S331P Ultraportable Cable & Antenna Analyzer 150 kHz to 4.0 GHz or 6 GHz
	MA25100A RF Power Indicator

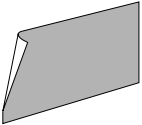

Optional Accessories

Miscellaneous Accessories

Accessory	Description
	67135 Anritsu Backpack (for Handheld Instrument and PC)
	40-207-R Automotive DC/DC Power Adapter
	2000-2048-R Screen Protector
	MA2700A Handheld Interference Hunter (For full specifications, refer to the MA2700A Technical Data Sheet 11410-00692)
	2000-1689-R EMI Near Field Probe Kit

Accessory	Description
	760-243-R Large Transit Case with Wheels and Handle 56 cm x 45.5 cm x 26.5 cm (22.07" x 17.92" x 10.42")
	2000-1374-R External Dual Charger for Li-Ion Batteries
	2000-2074-R Extended Power Pack with Cable
	2000-2053-R Shoulder Harness
	12N50-75B Matching Pad, DC to 3 GHz, 50 Ω to 75 Ω

GPS Antennas (active)

Accessory	Description
	2000-1528-R Magnet Mount, SMA (m) with 5 m (16.4 ft) cable, requires 5 VDC
	2000-1652-R Magnet Mount, SMA (m) with 0.3 m (1 ft) cable, requires 3.3 VDC or 5 VDC

Accessory **Description**

	2000-1760-R Miniature Antenna, SMA (m), requires 2.5 VDC to 3.7 VDC
---	--



Portable Antennas

Accessory	Description
	2000-1200-R 806 MHz to 866 MHz, SMA(m), 50 Ω
	2000-1473-R 870 MHz to 960 MHz, SMA(m), 50 Ω
	2000-1035-R 896 MHz to 941 MHz, SMA(m), 50 Ω (1/2 wave)
	2000-1030-R 1710 MHz to 1880 MHz, SMA(m), 50 Ω (1/2 wave)
	2000-1474-R 1710 MHz to 1880 MHz with knuckle elbow (1/2 wave)
	2000-1031-R 1850 MHz to 1990 MHz, SMA(m), 50 Ω (1/2 wave)

Accessory **Description**

	2000-1475-R 1920 MHz to 1980 MHz and 2110 MHz to 2170 MHz, SMA(m), 50 Ω
	2000-1032-R 2400 MHz to 2500 MHz, SMA(m), 50 Ω (1/2 wave)
	2000-1751-R 698 MHz to 960 MHz, 1710 MHz to 2100 MHz, 2500 MHz to 2700 MHz, SMA(m), 2 dB, typical, 50 Ω
	2000-1361-R 2400 MHz to 2500 MHz, 5000 MHz to 6000 MHz, SMA(m), 50 Ω
	2000-1636-R Antenna Kit (Consists of: 2000-1030-R, 2000-1031-R, 2000-1032-R, 2000-1200-R, 2000-1035-R, 2000-1361-R, and carrying pouch)









Mag Mount and Broadband Antennas

Accessory	Description
	2000-2141-R 20 MHz to 21000 MHz, N(f), 50 Ω
	2000-1645-R 694 MHz to 894 MHz, 3 dBi peak gain 1700 MHz to 2700 MHz, 3 dBi peak gain, N(m), 50 Ω, 10 ft
	2000-1646-R 750 MHz to 1250 MHz, 3 dBi peak gain, 1650 MHz to 2000 MHz, 5 dBi peak gain, 2100 MHz to 2700 MHz, 5 dBi peak gain, N(m), 50 Ω, 10 ft





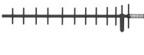

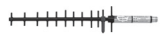

Accessory **Description**

	2000-1648-R 1700 MHz to 6000 MHz, 3 dBi peak gain, N(m), 50 Ω, 10 ft
	2000-1946-R Cable 1: 617 MHz to 960 MHz, 3 dBi peak gain, 1710 MHz to 3700 MHz, 4 dBi peak gain, N(m), 50 Ω, 10 ft Cable 2: 3000 MHz to 6000 MHz, 5 dBi peak gain, N(m), 50 Ω, 10 ft Cable 3: GPS 26 dB gain, SMA(m), 50 Ω, 10 ft
	2000-1647-R Cable 1: 698 MHz to 1200 MHz, 2 dBi peak gain, 1700 MHz to 2700 MHz, 5 dBi peak gain, N(m), 50 Ω, 10 ft Cable 2: 3000 MHz to 6000 MHz, 5 dBi peak gain, N(m), 50 Ω, 10 ft Cable 3: GPS 26 dB gain, SMA(m), 50 Ω, 10 ft

Directional Antennas

Accessory	Description
	2000-1411-R 824 MHz to 896 MHz, N(f), 12.3 dBi, Yagi
	2000-1412-R 885 MHz to 975 MHz, N(f), 12.6 dBi, Yagi
	2000-1413-R 1710 MHz to 1880 MHz, N(f), 12.3 dBi, Yagi
	2000-1414-R 1850 MHz to 1990 MHz, N(f), 11.4 dBi, Yagi
	2000-1415-R 2400 MHz to 2500 MHz, N(f), 14.1 dBi, Yagi
	2000-1416-R 1920 MHz to 2170 MHz, N(f), 14.3 dBi, Yagi
	2000-1659-R 698 MHz to 787 MHz, N(f), 10.1 dBi, Yagi
	2000-1660-R 1425 MHz to 1535 MHz, N(f), 14.3 dBi, Yagi
	2000-1715-R 698 MHz to 2500 MHz, N(f), gain of 2 dBi to 10 dBi, typical
	2000-2107-R Log Periodic, 20 MHz to 8.5 GHz

Accessory Description

Accessory	Description
	2000-1726-R 2500 MHz to 2700 MHz, N(f), 14.1 dBi, Yagi
	2000-1747-R Log Periodic, 300 MHz to 7000 MHz, N(f), 5.1 dBi, typical
	2000-1748-R Log Periodic, 1 GHz to 18 GHz, N(f), 6 dBi, typical
	2000-1777-R 9 kHz to 20 MHz, N(f) (requires port extender 2000-1798-R when used with MA2700A)
	2000-1778-R 20 MHz to 200 MHz, N(f) (requires port extender 2000-1798-R when used with MA2700A)
	2000-1779-R 200 MHz to 500 MHz, N(f) (requires port extender 2000-1798-R when used with MA2700A)
	2000-1812-R Portable Yagi Antenna, 450 MHz to 512 MHz, N(f), 7.1 dBi
	2000-1825-R Portable Yagi Antenna, 380 MHz to 430 MHz, N(f), 7.1 dBi
	2000-1798-R Port Extender, DC to 6 GHz

Bandpass Filters

Accessory	Description
	1030-114-R 806 MHz to 869 MHz, N(m) to SMA(f), 50 Ω
	1030-109-R 824 MHz to 849 MHz, N(m) to SMA(f), 50 Ω
	1030-110-R 880 MHz to 915 MHz, N(m) to SMA(f), 50 Ω
	1030-111-R 1850 MHz to 1910 MHz, N(m) to SMA(f), 50 Ω
	1030-112-R 2400 MHz to 2484 MHz, N(m) to SMA(f), 50 Ω
	1030-105-R 890 MHz to 915 MHz, N(m) to N(f), 50 Ω
	1030-106-R 1710 MHz to 1790 MHz, N(m) to N(f), 50 Ω
	1030-107-R 1910 MHz to 1990 MHz, N(m) to N(f), 50 Ω
	1030-149-R High Pass, 150 MHz, N(m) to N(f), 50 Ω
	1030-150-R High Pass, 400 MHz, N(m) to N(f), 50 Ω
	1030-151-R High Pass, 700 MHz, N(m) to N(f), 50 Ω
	1030-152-R Low Pass, 200 MHz, N(m) to N(f), 50 Ω
	1030-153-R Low Pass, 550 MHz, N(m) to N(f), 50 Ω
	1030-155-R 2500 MHz to 2700 MHz, N(m) to N(f), 50 Ω
	1030-178-R 1920 MHz to 1980 MHz, N(m) to N(f), 50 Ω
	1030-179-R 777 MHz to 798 MHz, N(m) to N(f), 50 Ω
	1030-180-R 2500 MHz to 2570 MHz, N(m) to N(f), 50 Ω



Accessory Description

Accessory	Description
	2000-1734-R 699 MHz to 715 MHz, N(m) and N(f), 50 Ω
	2000-1735-R 776 MHz to 788 MHz, N(m) and N(f), 50 Ω
	2000-1736-R 815 MHz to 850 MHz, N(m) and N(f), 50 Ω
	2000-1737-R 1711 MHz to 1756 MHz, N(m) and N(f), 50 Ω
	2000-1738-R 1850 MHz to 1910 MHz, N(m) and N(f), 50 Ω
	2000-1739-R 880 MHz to 915 MHz, N(m) and N(f), 50 Ω
	2000-1740-R 1710 MHz to 1785 MHz, N(m) and N(f), 50 Ω
	2000-1741-R 1920 MHz to 1980 MHz, N(m) and N(f), 50 Ω
	2000-1742-R 832 MHz to 862 MHz, N(m) and N(f), 50 Ω
	2000-1743-R 2500 MHz to 2570 MHz, N(m) and N(f), 50 Ω
	2000-1799-R 2305 MHz to 2320 MHz, N(m) and N(f), 50 Ω
	2000-1684-R 791 MHz to 821 MHz, N(m) to N(f), 50 Ω



Adapters	
Accessory	Description
	1091-26-R SMA(m) to N(m), DC to 18 GHz, 50 Ω
	1091-27-R SMA(f) to N(m), DC to 18 GHz, 50 Ω
	1091-80-R SMA(m) to N(f), DC to 18 GHz, 50 Ω
	1091-81-R SMA(f) to N(f), DC to 18 GHz, 50 Ω
	1091-172-R BNC(f) to N(m), DC to 1.3 GHz, 50 Ω
	1091-417-R N(m) to QMA(f), DC to 6 GHz, 50 Ω
	1091-418-R N(m) to QMA(m), DC to 18 GHz, 50 Ω
Precision Adapters	
Accessory	Description
	34NN50A N(m) to N(m), DC to 18 GHz, 50 Ω

Accessory	Description
	510-102-R N(m) to N(m), DC to 11 GHz, 50 Ω, 90 degrees right angle
	510-90-R 7/16 DIN(f) to N(m), DC to 7.5 GHz, 50 Ω
	510-91-R 7/16 DIN(f) to N(f), DC to 7.5 GHz, 50 Ω
	510-92-R 7/16 DIN(m) to N(m), DC to 7.5 GHz, 50 Ω
	510-93-R 7/16 DIN(m) to N(f), DC to 7.5 GHz, 50 Ω
	510-96-R 7/16 DIN(m) to 7/16 DIN(m), DC to 7.5 GHz, 50 Ω
	510-97-R 7/16 DIN(f) to 7/16 DIN(f), DC to 7.5 GHz, 50 Ω
Accessory	Description
	34NFN50 N(f) to N(f), DC to 18 GHz, 50 Ω

Attenuators

Accessory	Description
	1010-121-R 40 dB, 100 W, DC to 18 GHz, N(f) to N(m), Uni-directional
	3-1010-122 20 dB, 5 W, DC to 12.4 GHz, N(m) to N(f)
	3-1010-123 30 dB, 50 W, DC to 8.5 GHz, N(m) to N(f)
	3-1010-124 40 dB, 100 W, DC to 8.5 GHz, N(f) to N(m), Uni-directional

Accessory Description

Accessory	Description
	42N50-20 20 dB, 5 W, DC to 18 GHz, N(m) to N(f)
	42N50A-30 30 dB, 50 W, DC to 18 GHz, N(m) to N(f)
	1010-127-R 30 dB, 150 W, DC to 3 GHz, N(m) to N(f)
	1010-128-R 40 dB, 150 W, DC to 3 GHz, N(m) to N(f)

T5raining at Anritsu

Anritsu has designed courses to help you stay up to date with technologies important to your job. For available training courses, visit: <https://www.anritsu.com>, and search for training and education.



• United States

Anritsu Americas Sales Company
450 Century Parkway, Suite 190,
Allen, TX 75013, U.S.A.
Phone: +1-800-Anritsu (1-800-267-4878)

• Canada

**Anritsu Electronics Ltd.
Americas Sales and Support**
450 Century Parkway, Suite 190,
Allen, TX 75013, U.S.A.
Phone: +1-800-Anritsu (1-800-267-4878)

• Brazil

Anritsu Eletronica Ltda.
Praça Amadeu Amaral, 27 - 1 Andar
01327-010 - Bela Vista - Sao Paulo - SP, Brazil
Phone: +55-11-3283-2511
Fax: +55-11-3288-6940

• Mexico

Anritsu Company, S.A. de C.V.
Blvd Miguel de Cervantes Saavedra #169 Piso 1,
Col. Granada, Mexico, Ciudad de Mexico,
11520, MEXICO
Phone: +52-55-4169-7104

• United Kingdom

Anritsu EMEA Ltd.
200 Capability Green,
Luton, Bedfordshire, LU1 3LU, U.K.
Phone: +44-1582-433200
Fax: +44-1582-731303

• France

Anritsu S.A.
12 avenue du Québec, Immeuble Goyave,
91140 VILLEBON SUR YVETTE, France
Phone: +33-1-60-92-15-50

• Germany

Anritsu GmbH
Nemetschek Haus, Konrad-Zuse-Platz 1,
81829 München, Germany
Phone: +49-89-442308-0
Fax: +49-89-442308-55

• Italy

Anritsu S.r.l.
Spaces Eur Arte, Viale dell'Arte 25, 00144 Roma, Italy
Phone: +39-6-509-9711

List Revision Date: 20230407

• Sweden

Anritsu AB
Kistagången 20 B, 2 tr, 164 40 Kista, Sweden
Phone: +46-8-534-707-00

• Finland

Anritsu AB
Technopolis Aviapolis, Teknobulevardi 3-5 (D208.5),
FI-01530 Vantaa, Finland
Phone: +358-20-741-8100

• Denmark

Anritsu A/S
c/o Regus Winghouse, Ørestads Boulevard 73, 4th
floor,
2300 Copenhagen S, Denmark
Phone: +45-7211-2200

• Spain

**Anritsu EMEA Ltd.
Representation Office in Spain**
Paseo de la Castellana, 141.
Planta 5, Edificio Cuzco IV
28046, Madrid, Spain
Phone: +34-91-572-6761

• Austria

Anritsu EMEA GmbH
Am Belvedere 10, A-1100 Vienna, Austria
Phone: +43-(0)1-717-28-710

• United Arab Emirates

**Anritsu EMEA Ltd.
Anritsu A/S**
Office No. 164, Building 17, Dubai Internet City
P. O. Box – 501901, Dubai, United Arab Emirates
Phone: +971-4-3758479

• India

Anritsu India Private Limited
6th Floor, Indiqueb ETA, No.38/4, Adjacent to EMC2,
Doddanekundi, Outer Ring Road,
Bengaluru – 560048, India
Phone: +91-80-6728-1300
Fax: +91-80-6728-1301

• Singapore

Anritsu Pte. Ltd.
11 Chang Charn Road, #04-01, Shriro House
Singapore 159640
Phone: +65-6282-2400
Fax: +65-6282-2533

• Vietnam

Anritsu Company Limited
16th Floor, Peakview Tower, 36 Hoang Cau Street,
O Cho Dua Ward, Dong Da District, Hanoi, Vietnam
Phone: +84-24-3201-2730

• P.R. China (Shanghai)

Anritsu (China) Co., Ltd.
Room 2701-2705, Tower A, New Caohejing
International Business Center No. 391 Gui Ping Road
Shanghai, 200233, P.R. China
Phone: +86-21-6237-0898
Fax: +86-21-6237-0899

• P.R. China (Hong Kong)

Anritsu Company Ltd.
Unit 1006-7, 10/F., Greenfield Tower, Concordia Plaza,
No. 1 Science Museum Road, Tsim Sha Tsui East,
Kowloon, Hong Kong, P.R. China
Phone: +852-2301-4980
Fax: +852-2301-3545

• Japan

Anritsu Corporation
8-5, Tamura-cho, Atsugi-shi, Kanagawa, 243-0016
Japan
Phone: +81-46-296-6509
Fax: +81-46-225-8352

• South Korea

Anritsu Corporation, Ltd.
5FL, 235 Pangyoyeok-ro, Bundang-gu, Seongnam-si,
Gyeonggi-do 13494, South Korea
Phone: +82-31-696-7750
Fax: +82-31-696-7751

• Australia

Anritsu Pty. Ltd.
Unit 20, 21-35 Ricketts Road,
Mount Waverley, Victoria 3149, Australia
Phone: +61-3-9558-8177
Fax: +61-3-9558-8255

• Taiwan

Anritsu Company Inc.
7F, No. 316, Sec. 1, NeiHu Rd., Taipei 114, Taiwan
Phone: +886-2-8751-1816
Fax: +886-2-8751-1817