

Anritsu Advancing beyond

Field Master Pro™

High-Performance RF Spectrum Analyzer

MS2090A

9 kHz to 9 GHz, 14 GHz, 20 GHz, 26.5 GHz, 32 GHz, 43.5 GHz, 54 GHz

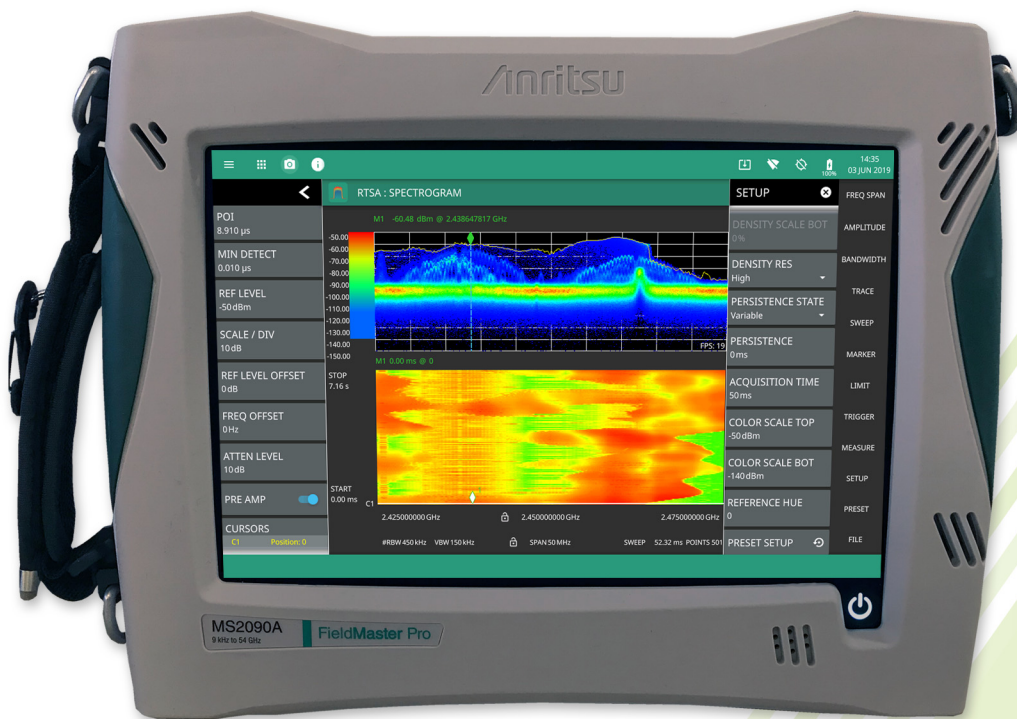

Introduction

Anritsu is proud to introduce the world’s most advanced handheld spectrum analyzer with real-time spectrum analysis capability. With frequency coverage up to 54 GHz, the new Field Master Pro™ MS2090A completely redefines the standards for portable handheld analyzers, setting another new industry benchmark for performance and accuracy. The new MS2090A is the culmination of over 60 years of microwave test and measurement equipment development, using the very latest technologies to deliver accuracy and precision in measurements previously reserved only for benchtop instruments.

Instrument Highlights

- Modulation Bandwidth: up to 110 MHz
- Dynamic Range: > 106 dB in 1 Hz RBW
- DANL: -164 dBm in 1 Hz RBW
- Phase Noise: -106 dBc/Hz @ 10 kHz offset at 1 GHz
- Resolution Bandwidth (RBW): 1 Hz up to 10 MHz
- RTSA with 2.05 μs POI
- Full-band Preamplifiers
- Operation to +55 °C: Full Performance on AC or Battery
- GNSS (GPS, GLONASS, Galileo, BeiDou)
- USB 3.0
- 10.1" Capacitive Touchscreen
- Two Hour Battery

Capabilities and Functional Highlights

- 5GNRFDD and TDD Analyzer
- Real-Time Spectrum Analyzer
- LTE FDD and TDD Analyzer
- Spectrogram
- Zero Span IF Output
- Gated Sweep
- IQ Waveform Capture/Streaming
- Pulse Profile Measurements
- AM/FM Audio Demodulation
- Multi-language Support
- Electromagnetic Field (EMF) Measurements
- EIRP
- Field Strength
- Occupied Bandwidth
- Channel Power
- Adjacent Channel Power
- Spectral Emissions Mask
- Signal Strength and RSSI
- Carrier Aggregation
- Carrier-to-Interference
- Signal Mapper (MA8100A)
- Coverage Mapping measurements in SPA, 5GNR and LTE applications
- Trace Recording/Playback
- Hi Accuracy Power Measurements (external sensor sold separately)
- Cable and Antenna Analyzer
- Interference Finder
- Interference Analysis
- Built-in PDF Report Generator

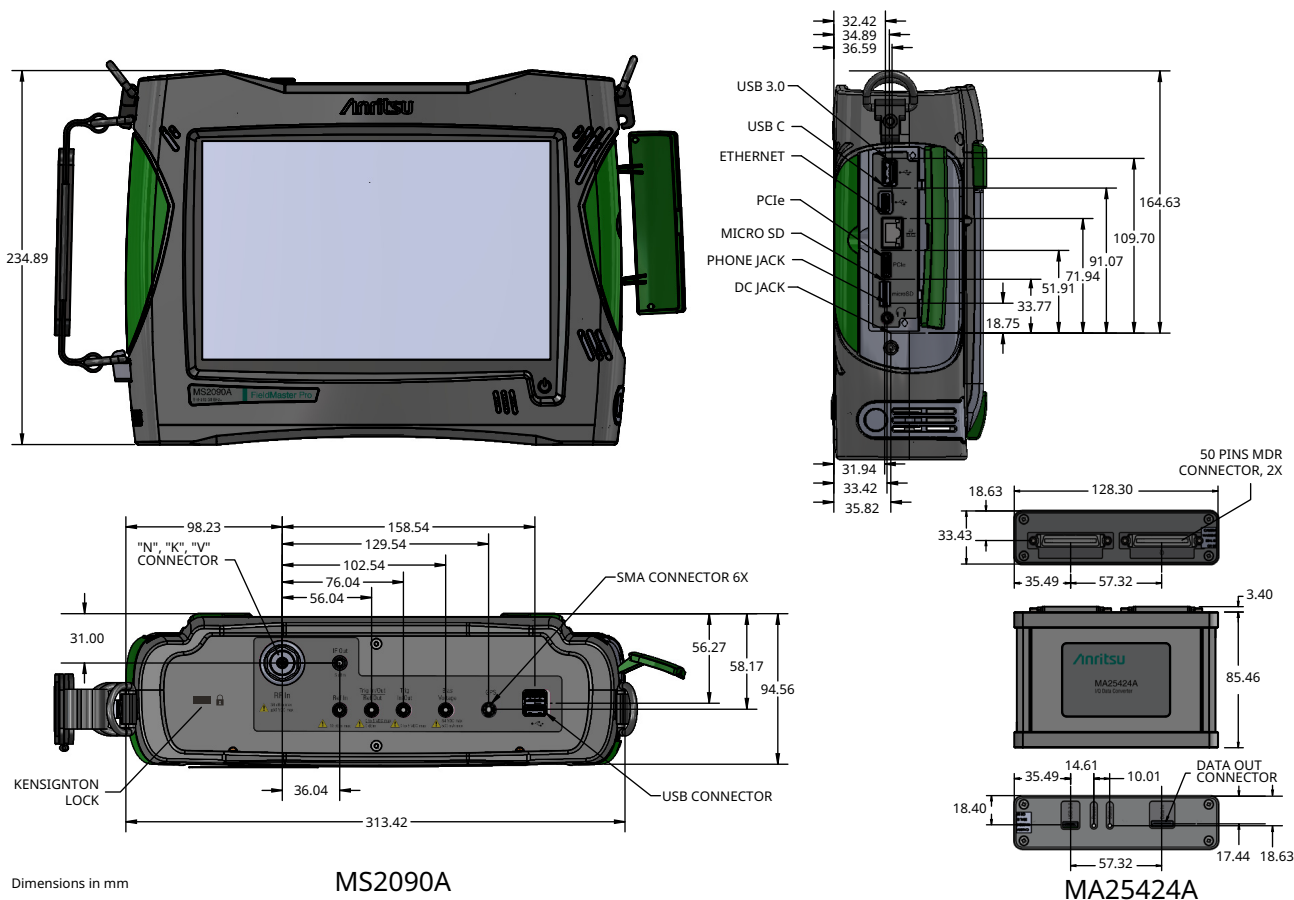

Table of Contents

Definitions 3

Spectrum Analyzer Features 4

Spectrum Analyzer Performance 5

High Accuracy Power Meter (Option 19) 7

Interference Finder and AM/FM Audio Demodulation (Option 24) 8

GNSS Receiver (Option 31) 8

Zero Span IF Output (Option 89) 8

Gated Sweep (Option 90) 8

IQ Waveform Capture (Option 124/126) 9

IQ Waveform Streaming (Option 125/127) 9

Real-Time Spectrum Analyzer (Option 199) 10

Cable and Antenna Analyzer (Option 331) 11

Pulse Analyzer (Option 421) 12

Coverage Mapping (Option 431) 13

Electromagnetic Field (EMF) Measurement (Option 444) 14

Electromagnetic Field (EMF) Meter (Option 445) 14

AM/FM Modulation Measurement (Option 509) 15

LTE FDD/TDD Signal Analyzer (Option 883) 16

5G NR FDD/TDD Signal Analyzer (Option 888) 18

General Specifications 19

Remote Interface Software 20

Programmable Remote Control 20

MA25424A IQ Data Converter 20

MA25101A IQ Streaming PCIe Kit 21

Ordering Information – Instrument Options 22

Standard Accessories 23

Related Manuals 23

USB Sensors and Power Indicator 24

Optional Accessories 25

Definitions

Specifications	All specifications and characteristics apply to Revision 4 instruments under the following conditions, unless otherwise stated: <ul style="list-style-type: none"> • Over the 25 ± 5 °C temperature range. • After 10 minutes of warm-up time, where the instrument is left in the ON state. • When using internal reference signal.
Typical Performance	Typical specifications are not tested and are not warranted. They are generally representative of characteristic performance.
Nominal Performance	Nominal specifications are design parameters; they are not tested and are not warranted.
Time Base Error	Input Frequency × Frequency Reference Error
Calibration Cycle	Calibration is within the recommended 12 month period
	All specifications in this data sheet are subject to change without notice. For the most current data sheet, please visit the Anritsu web site: www.anritsu.com

Spectrum Analyzer Features

Smart Measurements

Field Strength	Measures field strength (dBm/m ² , dBW/m ² , dBV/m, dBmV/m, dBμV/m, V/m, W/m ² , W/cm ² , A/m) with antenna gain vs. frequency plot
Channel Power	Measures the total power and power spectral density within a specified bandwidth
Occupied Bandwidth	Measures the 99 % to 1 % power channel of a signal
Adjacent Channel Power	Measures the channel power of the adjacent channel
Spectral Emission Mask	Standards based limits for wireless emissions
Carrier-to-Interference (C/I)	Measures the ratio of power (dB) in an RF carrier to the interference power in the channel.

Setup Parameters

Frequency	Center/Start/Stop Frequency, Frequency Step, Frequency Offset, Gestures
Span	Span (Manual/Increment 1, 2, 5) Full Span, Last Span, Zero Span
Amplitude	Reference Level (Manual/Auto and Offset), Scale/Division, Y-Axis Unit (dBm, dBW, dBV, dBmV, dBμV, dBA, V, W, A), Preamp (On/Off), Attenuation (Auto/Manual), Attenuation Level, Field Strength, Gestures
Bandwidth	RBW/VBW (Auto/Manual), VBW Type (Linear/Logarithmic), RBW:VBW Ratio, SPAN:RBW Ratio
Sweep	Single/Continuous, Restart, Sweep Once, Sweep to N, Auto/Manual Time, Gated Sweep (see “Gated Sweep (Option 90)” on page 8)

Spectrogram

Number of Lines	142
Trace Time/Position Cursor	Up to Six Cursors (display historical trace data by trace position or time)
Cursor State	Active, Hold/View, Blank
Color Setup	Color Scale Top/Bottom Range, Reference Hue

Trace Functions

Traces	Up to Six Traces
Trace Type	Clear/Write, Average (2 to 1000), Max Hold, Min Hold, Rolling Average, Rolling Max Hold, Rolling Min Hold
Trace Math	T1-T2, T2-T1 (when T5 and T6 are selected)
Trace Mode	Active, Hold/View, Blank
Detector Type per Trace	Peak, RMS/Avg, Negative, Sample, Normal
Trace Record	Record live samples with manual tagging to internal or external storage
Trace Playback	Play recorded samples from internal or external storage; set playback interval
CSV Logging	Record live or playback traces in CSV format for post processing

Trigger Functions

Trigger Input Sources (zero span only)	Free Run, Video, External1/2
Trigger Output	Enables GPS 1 PPS output
Settings	Timestamps (on/off), Level, Time Interval, Delay, Holdoff, Periodic, Slope (Rising/Falling), Hysteresis Refer to Section “IQ Waveform Capture (Option 124/126)” on page 2-9 for IQ Trigger Functions

Marker Functions

Markers	Up to 12 Markers
Marker Measurements	Amplitude, Frequency (swept spectrum display) Amplitude, Time (Zero Span)
Marker Mode	Normal, Delta, Fixed
Delta Marker	Relative to any Normal or Fixed Marker
Marker Function	None, Noise, Frequency Counter (1 Hz, 100 mHz, 10 mHz, 1 mHz resolutions), Quasi-Peak (per CISPR 16-1-1)
Marker Trace	Assign Marker to any Trace
Peak Search	Peak Search, Next Peak, Next Peak Left, Next Peak Right, Next Point Left, Next Point Right
Peak Search Setup	Peak Threshold, Peak Excursion
Marker	Mkr → Center, Mkr → Ref Level
Marker Table	Up to 12 Markers Showing Marker, Mode, Function, Trace, Frequency, Amplitude, Delta Frequency & Offset

Limit Line Functions

Limit Setup	Upper/Lower, Limit On/Off, Limit Alarm On/Off, Set Default Limit Line, Absolute/Relative
Limit Line Edit	Frequency, Amplitude, Add Point, Add Vertical, Delete Point, Next Point Left/Right
Limit Line Move	Center, X-Offset (Hz), Left, Right, Y-Offset, Up, Down, To Marker 1, Marker 1 Offset (dB)
Limit Line Envelope	Select Envelope (Upper/Lower), Set Envelope, Envelope Points (2-41), Amplitude Offset, Shape (Square/Slope)

Spectrum Analyzer Performance

Frequency (usable to 0 Hz)

MS2090A-0709	9 kHz to 9 GHz (Option 709)
MS2090A-0714	9 kHz to 14 GHz (Option 714)
MS2090A-0720	9 kHz to 20 GHz (Option 720)
MS2090A-0726	9 kHz to 26.5 GHz (Option 726)
MS2090A-0732	9 kHz to 32 GHz (Option 732)
MS2090A-0743	9 kHz to 43.5 GHz (Option 743)
MS2090A-0754	9 kHz to 54 GHz (Option 754)
Tuning Resolution	1 Hz
Span	10 Hz to max frequency, Zero Span
Frequency Reference	Internal, GNSS, External
Internal Frequency Reference	Aging: $\pm 1.0 \times 10^{-6}$ per 10 years Accuracy: $\pm 0.3 \times 10^{-6}$ (-10 °C to 55 °C) plus aging (see "GNSS Receiver (Option 31)" on page 8 for improved accuracy)
External Frequency Reference	10 MHz, -10 dBm to +10 dBm

Bandwidth

Analysis Bandwidth	20 MHz (standard), 50 MHz (Option 103), or 100 MHz (Option 104)
RTSA Bandwidth	22 MHz (standard), 55 MHz (Option 103), 110 MHz (Option 104)
Resolution Bandwidth (RBW)	1 Hz to 10 MHz (in RTSA, minimum RBW varies by span, max is 40 MHz), 1 Hz to 40 MHz in zero span
Video Bandwidth (VBW)	0.1 Hz to 10 MHz, 1 Hz to 40 MHz in zero span
CISPR Bandwidth	Resolution bandwidth when using Quasi-Peak marker function: 200 Hz, 9 kHz, and 120 kHz
VBW/Average Type	Linear/Log

Sweep

Manual Sweep	Maximum sweep time is 3600 s (1 hour)
Sweep Points	10 to 10,001 (1001 in zero span)
Sweep Rate (non-zero span)	15 GHz/s typical (full span, RBW = VBW = 3 MHz)

Zero Span

Sweep Time	60 ns to 3600 s in zero span
Sweep Time Accuracy	$\pm 2\%$ in zero span

Spectral Purity – SSB Phase Noise

Offset from 1 GHz	Maximum	Typical
10 kHz	-102 dBc/Hz	-106 dBc/Hz
100 kHz	-106 dBc/Hz	-110 dBc/Hz
1 MHz	-111 dBc/Hz	-116 dBc/Hz
10 MHz	-123 dBc/Hz	-129 dBc/Hz

Spurs (0 dB input attenuation)

Residual Spurs (RF input terminated)	Preamp = Off	Preamp = On
< 14 GHz	-90 dBm, maximum	-100 dBm, maximum
14 to 20 GHz	-85 dBm, maximum	-100 dBm, maximum
> 20 to 32 GHz	-80 dBm, maximum	-100 dBm, maximum
> 32 to 54 GHz	-80 dBm, maximum	-95 dBm, maximum
Input-Related Spurious (-30 dBm input)	Maximum ^a -60 dBc	Typical -70 dBc

a. Instrument centered on single signal, span < 1.7 GHz, 0 dB input attenuation.

Amplitude Ranges

Dynamic Range	>106 dB minimum at 2.4 GHz, 2/3 (TOI-DANL) in 1 Hz RBW
Measurement Range	DANL to +30 dBm
Display Range	1 to 15 dB/div in 1 dB steps, ten divisions displayed
Reference Level Range	-150 dBm to +30 dBm
Attenuator Resolution	0 to 65 dB, 5 dB steps
Reference Level Offset	99.9 dB external loss to 99.9 dB external gain
Maximum Continuous Input	+30 dBm peak typical, ± 50 VDC (≥ 10 dB attenuation) +23 dBm peak typical, ± 50 VDC (< 10 dB attenuation) +10 dBm peak typical, ± 50 VDC (preamp = On)

Amplitude Accuracy (10 dB attenuation, -50 dBm ≤ input signal ≤ -10 dBm, 1 kHz RBW, auto-coupled, excluding effects of VSWR, noise, and spurs)

	20 °C to 30 °C (after 30 minute warm-up)		-10 °C to 55 °C (after 60 minute warm-up)	
	Maximum	Typical	Maximum	Typical
9 GHz to 20 GHz Instruments				
9 kHz to 14 GHz	± 1.3 dB	± 0.5 dB	± 2.0 dB	± 0.5 dB
> 14 GHz to 18 GHz	± 1.3 dB	± 0.5 dB	± 2.0 dB	± 0.5 dB
> 18 GHz to 20 GHz	-	± 1.0 dB	-	± 1.0 dB
26.5 GHz to 54 GHz Instruments				
9 kHz to 14 GHz	± 1.3 dB	± 0.5 dB	± 2.0 dB	± 0.5 dB
> 14 GHz to 20 GHz	± 1.3 dB	± 0.5 dB	± 2.0 dB	± 0.5 dB
> 20 GHz to 43.5 GHz	± 1.8 dB	± 0.5 dB	± 2.5 dB	± 0.5 dB
> 43.5 GHz to 54 GHz	± 1.8 dB	± 0.5 dB	± 2.5 dB	± 0.5 dB

Displayed Average Noise Level (DANL) (RMS detection, VBW/Avg type = Log, reference level = -20 dBm for preamp Off and -50 dBm for preamp On, auto attenuation On)

	Preamp = Off		Preamp = On	
	Maximum	Typical	Maximum	Typical
9 GHz to 20 GHz Instruments				
10 MHz to 4 GHz	-145 dBm	-148 dBm	-161 dBm	-164 dBm
> 4 GHz to 9 GHz	-142 dBm	-145 dBm	-159 dBm	-162 dBm
> 9 GHz to 14 GHz	-136 dBm	-139 dBm	-156 dBm	-159 dBm
> 14 GHz to 20 GHz	-138 dBm	-144 dBm	-156 dBm	-161 dBm
26.5 GHz to 54 GHz Instruments				
10 MHz to 4 GHz	-145 dBm	-148 dBm	-161 dBm	-164 dBm
> 4 GHz to 9 GHz	-142 dBm	-145 dBm	-159 dBm	-162 dBm
> 9 GHz to 14 GHz	-136 dBm	-139 dBm	-156 dBm	-159 dBm
> 14 GHz to 20 GHz	-138 dBm	-142 dBm	-156 dBm	-159 dBm
> 20 GHz to 32 GHz	-135 dBm	-140 dBm	-154 dBm	-159 dBm
> 32 GHz to 43.5 GHz	-135 dBm	-140 dBm	-152 dBm	-154 dBm
> 43.5 GHz to 54 GHz	-130 dBm	-134 dBm	-147 dBm	-151 dBm

Third-Order Intercept (TOI) (-20 dBm tones 2 MHz apart, 0 dB input attenuation, preamp OFF, reference level -20 dBm)

2.4 GHz	+14 dBm minimum
50 MHz to < 9 GHz	+15 dBm typical
9 GHz to 20 GHz	+20 dBm typical
> 20 GHz to 32 GHz	+11 dBm typical
> 32 GHz to 54 GHz	+15 dBm typical

P1dB (nominal)

< 4 GHz	+5 dBm
4 GHz to 20 GHz	+12 dBm
> 20 GHz to 32 GHz	+7 dBm
> 32 GHz to 54 GHz	+12 dBm

Second Harmonic Distortion (0 dB input attenuation, -30 dBm input)

50 MHz	-75 dBc maximum
< 10 GHz	-80 dBc typical
≥ 10 GHz	-75 dBc typical

VSWR (≥ 10 dB input attenuation)

< 20 GHz	1.5:1 typical
20 GHz to 54 GHz	2.0:1 typical

High Accuracy Power Meter (Option 19) (requires external USB power sensor, sold separately)

Amplitude Setup	Maximum Display, Minimum Display, External Gain, External Loss, Relative Power On/Off, Units (dBm, W)			
Zero/Cal Limits	Zero, Cal Frequency, Signal Standard			
	Limit On/Off, Upper/Lower Limit, Alarm On/Off			
Power Sensor Model	MA24106A	MA24108A/18A/26A	MA24208A/18A	MA24330A/40A/50A
Description	High Accuracy RF Power Sensor	Microwave USB Power Sensor	Microwave Universal USB Power Sensor	Microwave CW USB Power Sensor
Frequency Range	50 MHz to 6 GHz	10 MHz to 8/18/26 GHz	10 MHz to 8/18 GHz	10 MHz to 33/40/50 GHz
Connector	Type N(m), 50 Ω	Type N(m), 50 Ω (8/18 GHz) Type K(m), 50 Ω (26 GHz)	Type N(m), 50 Ω	Type K(m), 50 Ω (33/40 GHz) Type V(m), 50 Ω (50 GHz)
Dynamic Range	-40 dBm to +23 dBm (0.1 μW to 200 mW)	-40 dBm to +20 dBm (0.1 μW to 100 mW)	-60 dBm to +20 dBm (1 nW to 100 mW)	-70 dBm to +20 dBm (0.1 nW to 100 mW)
Measurand	True-RMS	True-RMS, Slot Power, Burst Average Power	True-RMS, Slot Power, Burst Average Power	Average Power
Measurement Uncertainty	± 0.16 dB ^a	± 0.18 dB ^b	± 0.17 dB ^c	± 0.17 dB ^d
Data sheet (for complete specifications)	11410-00424	11410-00504	11410-00841	11410-00906

- Notes:
- a. Total RSS measurement uncertainty (0 °C to 50 °C) for power measurements of a CW signal greater than -20 dBm with zero mismatch errors.
 - b. Expanded uncertainty with K=2 for power measurements of a CW signal greater than -20 dBm with zero mismatch errors.
 - c. Power uncertainty expressed with two sigma confidence level for CW measurement after zero operation. Includes calibration factor and linearity over temperature uncertainties, but not the effects of mismatch, zero set and drift, or noise.
 - d. Includes linearity over temperature uncertainties, but not the effects of calibration factor, mismatch, zero set and drift, and noise.

Interference Finder and AM/FM Audio Demodulation (Option 24) (SPA, RTSA, requires GNSS Receiver (Option 31))**Supported Measurements**

Interference Finding Audio Tone
 AM/FM Audio Demodulation
 Interference Triangulation Mapping (Requires MA2700A)
 Interference Polar Plot (Requires MA2700A)

Interference Finder Audio Tone (for use with directional antennas, sold separately)

Setup Integration Bandwidth, Power Limit, MAX/MIN Level, Volume
 Audio Tone 20 Hz to 20 kHz (Tone pitch and volume changes with detected signal strength)

AM/FM Audio Demodulation

Demod Frequency Full range of instrument
 Audio Demodulation AM, USB, LSB, Wideband FM, Narrowband FM (6.25, 12.5, 25 kHz)
 Demod Marker On/Off
 Markers Selectable demodulation marker (1 to 12)
 Audio Toggle On/Off
 Volume Set 0% to 100%
 Record Audio Record audio up to 100,000 s (dependent on instrument memory)
 Squelch Level -120 dBm to +30 dBm (set RF level threshold to break audio silence, supports log and linear units)

Interference Map Triangulation (for use with InterferenceHunter handle and directional antenna, sold separately)

Triangulation Triangulates on source of interference location using eCompass and digital maps displayed on screen
 Manual Setup Manual entry of compass bearing values for signals above 6 GHz

Interference Polar Plot (for use with InterferenceHunter handle and directional antenna, sold separately)

Signal Strength Radar Plot 360° radar plot of single frequency signal strength centered on current GNSS location

GNSS Receiver (Option 31) (requires external GPS antenna, sold separately)

Supported Satellite Systems GNSS (includes combinations of GPS, GLONASS, Galileo, BeiDou)
 Setup On/Off, Antenna Voltage 3.3 V/5.0 V, GPS/GNSS Info
 GNSS Time/Location Indicator UTC Time, Latitude, Longitude, and Altitude on display (UTC Time and Altitude on GPS/GNSS Info display)
 High Frequency Accuracy $< \pm 2.5 \times 10^{-8}$ with GNSS On, 3 minutes after satellite lock in selected mode (GNSS antenna connected)
 $< \pm 5.0 \times 10^{-8}$ 24 hour holdover accuracy, -10 °C to 55 °C ambient temperature (GNSS antenna disconnected)
 Connector SMA(f), 50 Ω

Zero Span IF Output (Option 89)

Mode Spectrum Analyzer/Zero Span only
 Center Frequency 325 MHz (nominal, FFT capture BW \leq 32 MHz)
 300 MHz (nominal, FFT capture BW $>$ 32 MHz, requires Option 103 or 104)
 Output Level -4 dBm (nominal, -20 dBm input level, 0 dB input attenuation, preamp Off, 10 MHz input frequency)
 Spectrum is inverted in certain input RF bands.
 Reference Level -57 dBm to +30 dBm (Preamp Off)
 -87 dBm to -40 dBm (Preamp On)
 IF Bandwidth \leq 32 MHz; \leq 110 MHz with Option 103 or 104
 Rise Time $<$ 20 ns
 Connector SMA(f), 50 Ω

Gated Sweep (Option 90)

Gate Source GNSS (GPS), External 1/2
 Trigger Slope Rising/Falling
 Frame Time 1 s, 20 ms, 10 ms
 Gate Delay Up to 200 ms
 Gate Length 1 μs up to 200 ms
 Power vs. Time, Display Length 100 μs to 200 ms

IQ Waveform Capture (Option 124/126)

(Option 126 is non-export controlled and limits bit depth to 8 or 10 bits when bandwidth is 110 MHz)

IQ Capture

Mode	Spectrum Analyzer, RTSA
Capture Mode	Single, Continuous, Streaming
Capture Settings	Capture Length, Time Stamps (on/off), Save to File (Automatic/Normal), Save Capture, File Name Prefix Capture Signing (on/off), Storage Device (Internal/USB)
Trigger Source	Free Run, External 1/2, Video
Trigger Settings	Time Stamps (on/off), Level, Delay (negative in RTSA mode only), Time Interval, Slope (Rising/Falling), Hysteresis
Maximum Sample Rate ^a	200 MHz
Maximum Signal Bandwidth ^a	110 MHz
Bit Resolution	8, 10, 16, or 32-bit
Total Capture Memory	2 GB

IQ Capture Time Typical Maximum

Signal Bandwidth (MHz)	IQ Sample Rate (MSPS)	IQ Bit Resolution				Mode ^a	
		32 bit	16 bit	10 bit	8 bit	SPA	RTSA
110	200	1.34 s	2.68 s	4.29 s	5.37 s	x	x
100	122.88	2.18 s	4.37 s	6.99 s	8.74 s	x	
80	100	2.68 s	5.37 s	8.59 s	10.74 s	x	x
74	92.16	2.91 s	5.83 s	9.32 s	11.65 s	x	
50	61.44	4.37 s	8.74 s	13.98 s	17.48 s	x	
40	50	5.37 s	10.74 s	17.18 s	21.47 s	x	x
36	46.08	5.83 s	11.65 s	18.64 s	23.3 s	x	
25	30.72	8.74 s	17.48 s	27.96 s	34.95 s	x	
20	25	10.74 s	21.47 s	34.36 s	42.95 s	x	x
18	23.04	11.65 s	23.30 s	37.28 s	46.6 s	x	
12	15.36	17.48 s	34.95 s	55.92 s	1.17 min	x	
10	12.5	21.47 s	42.95 s	1.15 min	1.43 min	x	x
6	7.68	34.95 s	1.17 min	1.86 min	2.33 min	x	
5	6.25	42.95 s	1.43 min	2.29 min	2.86 min	x	x
3	3.84	1.17 min	2.33 min	3.73 min	4.66 min	x	
2.5	3.125	1.43 min	2.86 min	4.58 min	5.73 min	x	x
1.5	1.92	2.33 min	4.66 min	7.46 min	9.32 min	x	
1.25	1.5625	2.86 min	5.73 min	9.16 min	11.45 min	x	x
0.28	0.36	12.43 min	24.86 min	39.77 min	49.71 min	x	
0.036	0.045	99.42 min	198.84 min	318.15 min	397.68 min	x	

a. Option Dependent: Standard Analysis Bandwidth up to 20 MHz, Option 103 up to 55 MHz, Option 104 up to 110 MHz.

IQ Waveform Streaming (Option 125/127) (requires Option 124 or 126; Option 127 is non-export controlled and limits streams to 100 MHz BW or less.)

Bit Resolution	8, 10, 16, or 32-bit
Ethernet Port	Maximum gapless bandwidth depends on network transfer speed
USB Port	Requires USB 3.0 solid state drive. Device formatted as external file system (ext4). Maximum gapless streaming bandwidth: 8 bit: 100 MHz BW, 122.88 MSPS sample rate 10 bit: 74 MHz BW, 92.16 MSPS sample rate 16 bit: 50 MHz BW, 61.44 MSPS 32 bit: 25 MHz BW, 30.72 MSPS Device formatted as extensible file allocation table system (exFAT) with 32 MB allocation unit size Maximum gapless streaming bandwidth: 8 bit: 80 MHz BW, 100 MSPS sample rate 10 bit: 50 MHz BW, 61.44 MSPS sample rate 16 bit: 40 MHz BW, 50 MSPS sample rate 32 bit: 20 MHz BW, 25 MSPS sample rate
Data Out Port	Gapless streaming of 110 MHz bandwidth at 16-bit resolution or 100 MHz bandwidth at 32-bit resolution (requires MA25101A IQ Streaming PCIe kit and compatible PC) Stream to Bird IQC5000B at 16-bit resolution only, full bandwidth/sample rate (requires MA25424A receiver)

Real-Time Spectrum Analyzer (Option 199)

Setup Parameters

Frequency	Center/Start/Stop, Frequency Step, Frequency Offset Gestures (Drag Center Frequency (on/off), Pinch Span (on/off)) Span, Full Span (max span: 22 MHz standard, 55 MHz with option 103, 110 MHz with option 104)				
Amplitude	Reference Level (Manual/Auto and Offset), Scale/Division, Y-Axis Unit (dBm, dBW, dBV, dBmV, dBμV, dBA), Preamp, Attenuation (Auto/Manual), Gestures				
Bandwidth	RBW (span dependent), Auto RBW, Span:RBW Ratio				
Probability of Intercept	Analysis Bandwidth	Density Resolution	Span	RBW	POI
	20 MHz (Standard)	Normal High	22 MHz	10 MHz	2.520 μs 4.420 μs
	55 MHz (Opt. 103)	Normal High	55 MHz	25 MHz	2.210 μs 4.110 μs
	110 MHz (Opt. 104)	Normal High	110 MHz	40 MHz	2.055 μs 3.950 μs
Setup	Show Density (on/off), Auto Scale (on/off), Density Scale Top/Bottom (100% max), Density Res (Normal, High) Density Resolution				
Density Color	Set Color Top/Bottom Range, Auto Scale				
Persistence	Infinite or Variable from 0 to 10 s				
Acquisition Time	50 ms to 5 s				
FFT Rate	527,000 FFT/s (normal resolution), 263,000 FFT/s (high resolution)				
Minimum Detectable Signal	5 ns				

Trace Functions

Traces	Up to Six Traces
Trace Type	Clear/Write, Average (2 to 1000), Max Hold, Min Hold, Rolling Average, Rolling Max Hold, Rolling Min Hold, T1-T2, T2-T1
Trace Mode	Active, Hold/View, Blank
Detector Type per Trace	Peak, Sample, Negative, Normal
Trace Record	Record live samples with manual tagging to internal or external storage (only applies to trace and not for spectral density graphic)
Trace Playback	Play recorded samples from internal or external storage; set playback interval (only applies to trace and not for spectral density graphic)
CSV Logging	Record live or playback traces in CSV format for post processing

Sweep Functions

Sweep	Single/Continuous, Sweep Once
-------	-------------------------------

Spectrogram

Number of Lines	142
Trace Time/Position Cursor	Up to Six Cursors (display historical trace data by trace position or time)
Cursor State	Active, Hold/View, Blank
Color Setup	Color Scale Top/Bottom Range, Reference Hue, Preset Setup

Marker Functions

Markers	Up to 12 Markers
Marker Measurements	Power, Frequency, Time (Spectrogram)
Marker Mode	Normal, Delta, Fixed
Delta Marker	Relative to any Normal or Fixed Marker
Marker Function	None, Noise
Marker Trace	Assign Marker to any Trace
Peak Search	Peak Search, Next Peak, Next Peak Left, Next Peak Right, Next Point Left, Next Point Right
Peak Search Setup	Peak Threshold, Peak Excursion
Marker →	Mkr → Center, Mkr → Ref Level
Marker Table	Up to 12 Markers Showing Marker Mode, Function, Trace, Frequency, Amplitude, Delta Frequency & Offset

Limit Line Functions

Limit Setup	Upper/Lower, Limit On/Off, Limit Alarm On/Off, Set Default Limit Line, Limit Type: Absolute/Relative
Limit Line Edit	Frequency, Amplitude, Add Point, Add Vertical, Delete Point, Next Point Left/Right
Limit Line Move	Center, X-Offset, Left, Right, Y-offset, Up, Down, Marker Offset, To Marker 1
Limit Line Envelope	Select Envelope (Upper/Lower), Envelope Points (41 max), Amplitude Offset, Shape (Square/Slope), Set Envelope

Trigger Functions

Source	Free Run, Video, External1/2
Settings	Timestamps (on/off), Level, Time Interval, Delay, Holdoff, Periodic, Slope (Rising/Falling), Hysteresis Refer to Section "IQ Waveform Capture (Option 124/126)" on page 2-9 for IQ Trigger Functions

Cable and Antenna Analyzer (Option 331) (requires external Site Master™ S331P analyzer, sold separately)

Frequency

Frequency Ranges	150 kHz to 4 GHz (S331P-0704) 150 kHz to 6 GHz (S331P-0706)
Frequency Accuracy	± 2.5 ppm @ 23 °C ± 3 °C
Frequency Resolution	1 kHz

Refer to the Site Master S331P Technical Data Sheet (11410-00964) for hardware characteristics, performance specifications, compliance information, and related accessories for the S331P analyzer.

Measurements

Measurements	Return Loss Distance-to-Fault (DTF) Return Loss VSWR Cable Loss (One Port) Transmission (Ext) Distance-to-Fault (DTF) VSWR Smith Chart 50 Ω Cable Loss (Two Port) 1-Port Phase
--------------	--

Setup Parameters

Measurement Display	Single/Dual Display with independent markers
Frequency	Start Frequency, Stop Frequency
Distance and DTP Setup	Start Distance, Stop Distance, Units m/ft, Start Frequency, Stop Frequency, Data Points, Cable List, Cable Loss, Propagation Velocity
Windowing	Rectangular, Normal Side Lobe, Low Side Lobe, Minimum Side Lobe
Amplitude	Top, Bottom, Auto Scale, Full Scale
Sweep	Data Points, Run/Hold, Sweep Type (Single/Continuous), RF Immunity (High/Low)
Data Points	130, 259, 517, 1033, 2065
Marker	Markers 1 to 8 (On/Off), Delta Markers 2 to 8 (Ref M1), Track Marker (On/Off), Marker Search (Peak/Valley), Marker Table, Independent Markers for Frequency and Distance Measurements, To Memory (On/Off), Mode (Reference), Frequency
Trace	Copy Trace to Memory, Memory Display (Trace/Memory/Both) Trace Math: None, Trace - Memory, Trace + Memory, (Trace + Memory)/2
Limit	Upper Limit, Lower Limit, Limit Test (On/Off), Mode (Single/Segmented), Upper Level, Lower Level, Edit Segments (42 upper and 42 lower segments maximum), Alarm, Pass/Fail On/Off, Segment, Limit Table, Add Segment, Delete Segment, Clear All, X1, Y2, Segment Type (upper/lower), Y Offset
Calibration	Factory default 1-Port ReadyCal (automatically applied to all measurements) User calibration (User Cal) overrides ReadyCal Start Calibration, Cal Info, User Cal (On/Off), USB CAA Info, Power Sensor Cal Methods: OSL, EXT Transmission, OSL + Ext Trans Cal Types: Standard, FlexCal™
Save/Recall	PDF Report, Quick Save, Setups, Measurements, Screen Shots (saves data (.dat) format for analysis using Line Sweep Tools (LST)), PDF Report (Recall, Report Setup)

Pulse Analyzer (Option 421)

Pulse Measurements (in accordance with *IEEE Standard for Transitions, Pulses, and Related Waveforms* (181-2011, section 5.2.1)

Power Measurements	Average power, Peak power, Wave Average, Peak Wave Average, Pulse Average
Pulse Characteristics	Duration, Center, Tilt, Period, Off Time, Duty Factor, Frequency
First Transition Characteristics	Transition Duration, Duration Instant, Low Reference Instant, High Reference Instant, Pre Transition Overshoot, Post Transition Overshoot, Pre Transition Undershoot, Post Transition Undershoot
Second Transition Characteristics	Transition Duration, Duration Instant, Low Reference Instant, High Reference Instant
Pulse View Settings	Pulse Analyzer (enables pulse analyzer measurements above), Pulse Viewer (removes pulse analyzer measurements and enables standard marker measurements)
Rise Time	(trace averages set to 100; RBW:VBW = 1) 30 ns, 40 MHz RBW (Option 104) 60 ns, 25 MHz RBW (Option 103) 100 ns, 10 MHz RBW (Standard)

DANL and dynamic range are the same as the [“Spectrum Analyzer Performance”](#).

Setup Parameters

Frequency	Center Frequency, Frequency Step, Frequency Offset
Amplitude	Reference Level (Manual/Auto and Offset), Scale/Division, Y-Axis Unit (dBm, dBW, dBV, dBmV, dBμV, dBA), Preamp On/Off, Attenuation (Auto/Manual)
Bandwidth	RBW/VBW (Auto/Manual), VBW Type (Linear/Logarithmic), RBW:VBW Ratio, SPAN:RBW Ratio
Pulse Setup	Pulse Level Type (Auto/User), Pulse Type (Positive/Negative), User TOP (S2), User BOTTOM (S1), Pulse Reference High (%), Pulse Reference Low (%), Pulse Duration Reference (0.2-99.9%), Simulation, Display

Trace Functions

Traces	Up to Six Traces
Trace Type	Clear/Write, Min Hold, Max Hold, Average, Rolling Max Hold, Rolling Min Hold, Rolling Average
Trace Mode	Active, Hold/View, Blank
Detector Type per Trace	Peak, Negative, Sample

Sweep Functions

Sweep	Single/Continuous, Restart, Sweep Once, Sweep to N, Sweep Time
Sweep Points	1001
Sweep Time	60 ns to 3600 s
Sweep Time Accuracy	±2%

Marker Functions (enabled only in Pulse Viewer)

Markers	Up to 12 Markers
Marker Measurements	Time, Amplitude
Marker Mode	Normal, Delta, Fixed
Delta Marker	Relative to any Normal or Fixed Marker
Marker Function	None, Noise
Marker Trace	Assign Marker to any Trace
Peak Search	Peak Search, Next Peak, Next Peak Left, Next Peak Right, Next Point Left, Next Point Right
Peak Search Setup	Peak Threshold, Peak Excursion
Marker →	Mkr → Center, Mkr → Ref Level
Marker Table	Up to 12 Markers Showing Marker Mode, Function, Trace, Time, Amplitude, Delta Time & Offset

Trigger Functions

Trigger Sources	Free Run, Video, External 1/2
Trigger Settings	Level, Delay, Holdoff, Periodic, Slope (Rising/Falling), Hysteresis
Trigger Jitter	20 ns

Pulse Simulation Provides visual and measurement data of simulated pulse types.

Waveform Types	Single Positive, Single Negative, Train, Double
Settings	Simulation (ON/OFF) Amplitude (High and Low), Period (0 s-3600 s), Duty Factor (0.01-1)

Pulse Display

Settings	Ref High (On/Off), Duration Ref (On/Off), Post-T Over (On/Off), Post-T Under (On/Off), Pre-T Over (On/Off), Pre-T Under (On/Off), S2 High (On/Off), S1 Low (On/Off), HRI First/Second, LRI First/Second, DI First/Second (On/Off)
----------	---

Coverage Mapping (Option 431) (Spectrum Analyzer, 5GNR, LTE measurements)

Spectrum Analyzer Measurements

Channel Power	Plots channel power in dBm, dBW, dBV, dBmV, dBμV, dBA, V, W, A
Spectral Density	Plots spectral density in dBm/Hz, dBW/Hz, dBV/Hz, dBmV/Hz, dBμV/Hz, dBA/Hz, V/Hz, W/Hz, A/Hz
RSSI	Plots received signal strength indicator in dBm, dBW, dBV, dBmV, dBμV, dBA, V, W, A
Field Strength	Plots field strength in dBm/m ² , dBW/m ² , dBV/m, dBmV/m, dBμV/m, dBA/m, V/m, W/m ² , W/cm ² , A/m ²
Power Flux Density	Plots power flux density in dBm/m ² /Hz, dBW/m ² /Hz, dBV/m/Hz, dBmV/m/Hz, dBμV/m/Hz, dBA/m/Hz, V/m/Hz, W/m ² /Hz, W/cm ² /Hz, A/m/Hz

Spectrum Analyzer Measurement Setup

Map Type	Indoor: PNG or JPEG Outdoor: OpenStreetMap® (downloaded direct from Internet to instrument or using external PC software)
Frequency (Excluding RSSI)	Center/Start/Stop, Frequency Step, Frequency Offset
Span (Excluding RSSI)	Span (Manual/Increment 1, 2, 5), Full Span, Last Span, Zero Span
Amplitude	Reference Level (Manual/Auto and Offset), Scale/Division, Y-Axis Unit, Preamp (on/off), Attenuation (Auto/Manual), Field Strength
Bandwidth	RBW/VBW (Auto/Manual), VBW Type (Linear/Logarithmic), RBW:VBW Ratio, SPAN:RBW Ratio
Mapping Colors	Customizable Amplitude Range Thresholds for Each Color Blue (Excellent), Green (Very Good), Yellow (Good), Orange (Fair), Pink (Poor)
Point Distance or Time Setup	Repeat Type: Time (1 s to 60 s) or Distance (1 m to 10,000 m), Distance Units: Meters or Feet
Save	Indoor: Setup, Measurement File (fm spa), PNG Outdoor: Setup, KML Points, PNG, Tab Delimited
Recall	Setup, KML Points File, Measurement File (fm spa)

LTE Measurements (Option 883 is required (see [“LTE FDD/TDD Signal Analyzer \(Option 883\)” on page 16](#)))

Channel Power	Plots channel power in dBm, dBW, dBV, dBmV, dBμV, dBA
Spectral Density	Plots spectral density in dBm/Hz, dBW/Hz, dBV/Hz, dBmV/Hz, dBμV/Hz, dBA/Hz
RSRP	Plots received signal strength indicator in dBm, dBW, dBV, dBmV, dBμV, dBA
RSRQ	Plots received signal strength indicator in dBm, dBW, dBV, dBmV, dBμV, dBA
SINR	Plots received signal strength indicator in dBm, dBW, dBV, dBmV, dBμV, dBA

LTE Measurement Setup

Map Type	Indoor: PNG or JPEG Outdoor: OpenStreetMap® (downloaded direct from Internet to instrument or using external PC software)
Frequency	Center Frequency, Channel Bandwidth, EARFCN, Signal Standard
Amplitude	Auto Range (On/Off), Reference Level (Manual/Auto and Offset), Scale/Division, Y-Axis Unit, Preamp (on/off), Attenuation (Auto/Manual)
Bandwidth	RBW/VBW (Auto/Manual), VBW Type (Linear/Logarithmic), RBW:VBW Ratio, SPAN:RBW Ratio
Mapping Colors	Customizable Amplitude Range Thresholds for Each Color Channel Power and Spectral Density: Blue (Excellent), Green (Very Good), Yellow (Good), Orange (Fair), Pink (Poor) RSRP, RSRQ, SINR: Blue (Excellent), Green (Good), Yellow (Poor), Pink (Bad), Gray (No Sync)
Point Distance or Time Setup	Repeat Type: Time (1 s to 60 s) or Distance (1 m to 10,000 m), Distance Units: Meters or Feet
Map Source	Any PCI, Defined PCI
Save	Indoor: Setup, Measurement File (fmlte), PNG Outdoor: Setup, KML Points, CSV, PNG,
Recall	Setup, KML Points File

5GNR Measurement (Option 888 is required (see [“5GNR FDD/TDD Signal Analyzer \(Option 888\)” on page 18](#)))

Channel Power	Plots channel power in dBm, dBW, dBV, dBmV, dBμV, dBA
Spectral Density	Plots spectral density in dBm/Hz, dBW/Hz, dBV/Hz, dBmV/Hz, dBμV/Hz, dBA/Hz
SS-RSRP	Plots received signal strength indicator in dBm, dBW, dBV, dBmV, dBμV, dBA
SS-RSRQ	Plots received signal strength indicator in dBm, dBW, dBV, dBmV, dBμV, dBA
SS-SINR	Plots received signal strength indicator in dBm, dBW, dBV, dBmV, dBμV, dBA

5G NR Measurement Setup

Map Type	Indoor: PNG or JPEG Outdoor: OpenStreetMap® (downloaded direct from Internet to instrument or using external PC software)
Frequency	Center Frequency, Channel Bandwidth, EARFCN, Signal Standard
Amplitude	Auto Range (On/Off), Reference Level (Manual/Auto and Offset), Scale/Division, Y-Axis Unit, Preamp (on/off), Attenuation (Auto/Manual)
Bandwidth	RBW/VBW (Auto/Manual), VBW Type (Linear/Logarithmic), RBW:VBW Ratio, SPAN:RBW Ratio
Mapping Colors	Customizable Amplitude Range Thresholds for Each Color Channel Power and Spectral Density: Blue (Excellent), Green (Very Good), Yellow (Good), Orange (Fair), Pink (Poor) SS-RSRP, SS-RSRQ, SS-SINR: Blue (Excellent), Green (Good), Yellow (Poor), Pink (Bad), Gray (No Sync)
Point Distance or Time Setup	Repeat Type: Time (1 s to 60 s) or Distance (1 m to 10,000 m), Distance Units: Meters or Feet
Map Source	Any PCI, Defined PCI
Save	Indoor: Setup, Measurement File (fm5gnr), PNG Outdoor: Setup, KML Points, PNG, CSV
Recall	Setup, KML Points File

Electromagnetic Field (EMF) Measurement (Option 444) (requires a supported antenna, sold separately)

The Spectrum Analyzer mode provides electromagnetic field strength measurements in three axis (X, Y, Z) with trace displays for each measurement and tabular results.

Measurements/Settings

Setup	Limit lines, Axis Dwell Time, Measurement Time, Measurement Count, Measurement Units, Data Logging with storage location
Units	dBm/m^2 , dBW/m^2 , dBV/m , dBmV/m , $\text{dB}\mu\text{V/m}$, V/m , W/m^2 , W/cm^2 , A/m
Results	Maximum, Minimum, and Average of all measurements conducted
Displayed Information	Measurement progress, number of measurements taken, Pass/fail indicators

Frequency Range

Supported Antenna	
2000-1800-R	9 kHz to 300 MHz
2000-1792-R	30 MHz to 3 GHz
2000-1791-R	700 MHz to 6 GHz

Electromagnetic Field (EMF) Meter (Option 445) (requires a supported probe, sold separately)

The EMF Meter mode provides electromagnetic field strength measurements in three axis (X, Y, Z) with bar graph for each measurement and tabular results.

Measurements/Settings

Limit	Standard (FCC Public, ICNIRP Public, FCC Workers, ICNIRP Worker), Limit Mode (Lowest, Frequency), Alarm, Volume, Mute, Preset Supports the International Commission on Non-Ionizing Radiation Protection limit (ICNIRP)
Measure	Selected sample (1 through 16), Start Sampling, Clear Results
Setup	EMF Meter Calibration, Probe info
Units	mW/cm^2
Preset	Preset Mode
Setup File	Quick save, Save As, Recall (.stp file type), Browse Files
Results (%)	Maximum, Minimum, and Average of all samples (1 through 8)
Display	Bar graph of each sample (1 through 16) with Standard Limit Line, Time (mm:ss)

Frequency Range

Supported Probe	
2000-1985-R	Isotropic EMF Probe, 20 MHz to 40 GHz (refer to data sheet 11410-01185)

AM/FM Modulation Measurement (Option 509) (Spectrum Analyzer, RTSA, IA Spectrum and IA RTSA measurements)

AM Measurements

AM Depth	0% to 100%, ±2% accuracy, typical
AM Bandwidth	20 kHz
AM Standards	Standard AM, Upper/Lower Sideband suppressed carrier
SINAD	0 to 60 dB, nominal based on 1kHz modulating tone
THD	-60 dB, using up to 10 harmonics of 1 kHz modulating tone
Demodulated AM Spectrum	Frequency Scale, 0 to 24 kHz
Audio Time Domain	5 s or auto zoomed
Graphs	Audio Spectrum (Log AM depth percentage vs frequency), RF Spectrum Audio Time Domain (Linear AM depth percentage vs time), Audio Results
Audio Results	Signal Power (dBm), Carrier Frequency, RMS Depth, (Peak-to-peak)/2 Depth, Peak Positive/Peak Negative Depth, SINAD (dB), Upper/Lower AM Depth, THD (dB)
Setup	Demodulation Frequency, Demodulation Marker (on/off), Marker Tracked (1 to 12), Zoomed Time Graph (on/off), Modulation (AM, USB, LSB), Audio (on/off), Volume (on/off), Record Duration (1 to 100000 S), Record, Squelch Level (-120 to 30 dBm)

FM Measurements

FM Bandwidth	96 kHz (wide)
FM Deviation	Up to 75 kHz with 2% accuracy, ±1 kHz typical
SINAD	0 to 60 dB, nominal based on 1 kHz modulating tone
THD	-75 to 0 dB, using up to 10 harmonics of 1 kHz modulating tone
Demodulated FM Spectrum	Wideband: 96 kHz full span, 20 kHz zoomed Narrowband: 25 kHz, 24 kHz (audio spectrum) 12.5 kHz, 14 kHz (audio spectrum) 6.25 kHz, 6 kHz (audio spectrum)
Audio Time Domain	5 s or auto zoomed
Graphs	Audio Spectrum (Log FM deviation vs frequency), RF Spectrum Audio Time Domain (Linear FM deviation vs time), Audio Results
Audio Results	Signal Power (Hz), Carrier Frequency, RMS FM deviation, (Peak-to-peak)/2 Deviation, SINAD, Total Harmonic Distortion (THD) Peak Positive/Negative Deviation
Setup	Demodulation Frequency, Demodulation Marker (on/off), Marker Tracked (1 to 12), Zoomed Audio Graph (on/off), Zoomed Time Graph (on/off), Modulation (FM Narrowband (6.25, 12.5, 25 kHz), FM Wideband), Audio (on/off), Volume (on/off), Record Duration (1 to 100000 S), Record, Squelch Level (-120 to 30 dBm)

LTE FDD/TDD Signal Analyzer (Option 883)

General

Frequency Range	10 MHz to 54 GHz (option dependent)
Channel Bandwidth (MHz)	1.4, 3, 5, 10, 15, 20
Amplitude	Auto Range, Reference Level (Manual/Auto), Scale/Division, Y Axis Unit, Attenuation Level (Auto/Manual), Reference Level Offset, Pre Amp
Input Signal Range	-76 dBm to +10 dBm (≤20 GHz) -72 dBm to +10 dBm (>20 GHz)
Sweep	Single/Continuous, Hold (On/Off)
MIMO Antenna Setup	Auto, Antenna 0, 1, 2, or 3

LTE Demodulation Summary

PCI Summary Measurements	Physical Cell ID, Sector ID, Cell Group, Frequency Error, Time Offset, Cyclic Prefix, Status of Primary Synchronization Signal (PSS), MIMO Time Alignment Error, Resource Block Power
Signal Power Measurements (dBm)	Physical Broadcast Channel Power (PBCH), Sync Signal (SS), Reference Signal (RS), OFDM Symbol Transmit Power (OSTP)
Error Vector Magnitude Measurements (%)	Physical Broadcast Channel (QPSK), Physical Downlink Shared Channel (QPSK), PDSCH (16-QAM/64-QAM/256-QAM)
Demod Summary View	PCI, Sector ID, Cell Group, Frequency Error, Time Offset, Cyclic Prefix, Sync Status, Power (PBCH, SS, RS), EVM (PBCH(QPSK), PDSCH (QPSK, 16-QAM, 64-QAM, 256-QAM), Average EVM, Peak EVM
Time Alignment Error (TAE) View	PCI, Sector ID, Cell Group, Frequency Error, Time Offset, Cyclic Prefix, Sync Status, TAE between each antenna pair, Power (RS, SS), EVM (RMS, PEAK)
Resource Block Power View	PCI, Sector ID, Cell Group, Frequency Error, Time Offset, Cyclic Prefix, Sync Status, RB (number of active RBs, Utilization, OSTP), EVM (QPSK, 16-QAM, 64-QAM, 256-QAM)
Setup Parameters	Antenna (Auto/1/2/3/4), Cyclic Prefix (Auto/Normal/Extended), Duplex Type (FDD/TDD), UL/DL Config (TDD only), CFI (Auto/CFI1/CFI2/CFI3), SSB Offset, Auto Detect SSB
RS Power Accuracy	± 1.0 dB typical (RF input -50 dBm to +10 dBm)
Frequency Error	± 10 Hz + time base error (99 % confidence level)
Residual EVM (rms)	2.0 % typical (E-UTRA Test Model 3.1, RF Input -50 dBm to +10 dBm)

LTE DSS Detection

Setup Parameters	DSS Detect (On/Off), Status, PCI, Beam, SS-RSRP
------------------	---

LTE Multi PCI

Measurements	Multiple Physical Cell IDs, Secondary Sync Signal Power (S-SS), Reference Signal Received Power (RSRP), Reference Signal Received Quality (RSRQ), Signal to Interference and Noise Ratio (SINR), Average Error Vector Magnitude (EVM), Peak EVM, Frequency Error (Hz and PPM), Dominance (dB)
Graph Displays	PCI, SINR, RSRP, RSRQ, SS Power
Setup Parameters	Cyclic Prefix (Auto/Normal/Extended), Duplex Type (FDD/TDD), UL/DL Config (TDD only), CFI (Auto/CFI1/CFI2/CFI3), DSS Detect On/Off (Status, PCI, Beam, SS-RSRP), SSB Offset, Auto Detect SSB

LTE Channel Power

Measurements	Total Channel Power, Total Power Spectral Density (PSD), Limit Test (Power and PSD)
Setup Parameters	Integration Bandwidth, PSD Units (Hz/MHz), Power Limit (dBm), PSD Limit (dBm/Hz)
RF Channel Power Accuracy	± 1 dB typical (-50 dBm to +10 dBm)

LTE Channel Spectrum

Measurements	Occupied Bandwidth (OBW), Total Power, Reference Signal (RS) Power, Frequency Error, Limit Test (OBW)
Setup Parameters	% OBW Power (%/dB), XdB, OBW Limit (on/off) (Hz), Method (percent (%), x dB)

LTE Carrier Aggregation

Measurements	Carrier, Physical-layer Cell ID (PCI), RSRP, RSRQ, SINR, EVM (% RMS), Frequency Error (Hz), Bandwidth (BW), Center Frequency, Antennas
Setup Parameters	Carrier, Carrier Count (up to eight), Antenna (Auto/0/1/2/3), Cyclic Prefix (Auto/Normal/Extended), Duplex Type (FDD/TDD)

LTE Control Channel

PCI Summary Measurements	Physical Cell ID, Sector ID, Cell Group, Frequency Error, Time Offset, Cyclic Prefix, Status of Primary Synchronization Signal (PSS)
Power Measurements	Reference Signal (RS), P-Primary Synchronization Signal (P-SS), Secondary Synchronization Signal (S-SS), Physical Broadcast Channel (PBCH), Physical Control Format Indicator Channel (PCFICH), Physical Hybrid Automatic Repeat Request Indicator Channel (PHICH), Physical Downlink Control Channel (PDCCH), Total Power per Resource Element and Power (dBm/watts), EVM (%)
Setup Parameters	Antenna (Auto/0/1/2/3), Cyclic Prefix (Auto/Normal/Extended), Duplex Type (FDD/TDD), UL/DL Config (TDD only), NG (1/6, 1/2, 1, 2), CFI (Auto/CFI1/CFI2/CFI3)

LTE Constellation

Measurements	Physical Cell ID, Sector ID, Cell Group, Frequency Error, Time Offset, Cyclic Prefix, Status of Primary Synchronization Signal (PSS), Constellation Display of PBCH or PDSCH
Power Measurements	Reference Signal (RS) Power, P-Primary Synchronization Signal (P-SS) Power, Secondary Synchronization Signal (S-SS) power, RMS EVM (%), Peak RMS, Physical Downlink Shared Channel (PDSCH), QPSK, 16-QAM, 64-QAM, 256-QAM
Setup Parameters	Antenna (Auto/0/1/2/3), Cyclic Prefix (Auto/Normal/Extended), Duplex Type (FDD/TDD), UL/DL Config (TDD only), CFI (Auto/CFI1/CFI2/CFI3), Data Select (PBCH/PDSCH), Modulation (All/QPSK/16-QAM/64-QAM/256-QAM), Ref Points

LTE Frame Power

Measurements	Physical Cell ID, Sector ID, Cell Group, Frequency Error, Time Offset, Cyclic Prefix, Status of Primary Synchronization Signal (PSS)
Sub-Frame Power Measurements	Sub-Frame, Slot (0 and 1), Total Frame Power, Uplink and Downlink Pilot Time Slots (DwPTS and UpPTS), and Transmit Off Power
Setup Parameters	Analysis (Frame/Subframe/Slot), SSF Config (Auto/0-9/Invalid), Sub-Frame (0-9), Slot (0/1) Antenna (Auto/0/1/2/3), Cyclic Prefix (Auto/Normal/Extended), Duplex Type (FDD/TDD), UL/DL Config (TDD only), NG (1/6, 1/2, 1, 2)

5G NR FDD/TDD Signal Analyzer (Option 888)

General

Frequency Range	10 MHz to 54 GHz (option dependent)
Band Configuration	Manual, Global All or selectable Band #, Absolute Radio Frequency Channel Number (ARFCN), Global Synchronization Raster Channel (GSCN), Channel Bandwidth (5 MHz to 100 MHz in steps of 5 MHz), SSB Offset, Subcarrier Spacing (15, 30, 120, 240 kHz), Mapping Pattern (Auto, P1, P2), Auto SSB Detect
Auto SSB Detect	Searches 3GPP defined GSCN raster
Amplitude	Auto Range, Reference Level, Scale/Division, Y Axis Unit, Reference Level Offset, Attenuation Level (Auto/Manual), Preamp
Input Signal Range	-76 dBm to +10 dBm (≤20 GHz) -72 dBm to +10 dBm (>20 GHz)
Sweep	Single/Continuous, Sweep Once, Hold

5G NR Summary

Multi-Beam Measurements	Physical-layer Cell ID, Beam Index, Sector ID, Cell Group, Frequency Error, Time Offset (μs), Status, SS-RSRP (dBm), SS-RSRQ (dB), SS-SINR (dB), SS-RSSI (dB), Sync and Demod Status Indicators
Single-Beam Measurements	Physical Cell ID, Sector ID, Cell Group, Frequency Error, Time Offset, Status, SS-RSRP (dBm), SS-RSRQ (dB), SS-SINR (dB), SS-RSSI, Sync and Demod Status Indicators, Block Measurements (PSS, SSS, PBCH, PBCH-DMRS), Average EVM, Peak EVM (@ subcarrier/symbol), Beam Power (dBm)
Views	Multi Beam (up to 64), Single Beam
Setup Parameters	SINR Threshold (dB), Duplex Type (FDD/TDD), GMC Offset (μs), Distance to Antenna (m), Distance Unit (m/ft)
RSRP Accuracy	± 1.0 dB typical
Residual EVM (rms)	2.0 % typical
Frequency Error	< ± 4.0E-9 + time base error, typical (FR1, Channel BW ≤ 50 MHz) < ± 5.0E-9 + time base error, typical (FR1, Channel BW > 50 MHz) < ± 1.0E-8 + time base error, typical (FR2)

5G NR OTA (Multi PCI)

Measurements	Multiple Physical-layer Cell (PCI) IDs, Beam Index, SS-RSRP (dBm), SS-RSRQ (dB), SS-SINR (dB), SS-RSSI (dB) SS-EVM (%), Time Offset (μs)
Views	Multi PCI Beam Scanner (up to 64 beams), Table, Time Offset Table
Setup Parameters	SINR Threshold (dB), Duplex Type (FDD/TDD)

5G NR RF EIRP

Measurements	EIRP (Active, Horizontal/Vertical, Sum), Upper/Lower Limit Test
Views	Normal (RF spectrum), Quick View (summary)
Setup Parameters	Save (Horizontal/Vertical), Reset Sum, RX Antenna Gain, Distance to Antenna, Distance Unit (Meters/Feet), Upper/Lower Limit Test, RX Cable Loss (dB)

5G NR RF Occupied Bandwidth

Measurements	Occupied Bandwidth, Total Power, Limit Test
View	Normal (RF Spectrum)
Setup Parameters	Method (% or X dB), % OBW Power, OBW Limit (On/Off), X dB

5G NR RF Channel Power

Measurements	Total Channel Power, Total PSD, Limit Test
View	Normal (RF Spectrum)
Setup Parameters	Integration Bandwidth, PSD Units (Hz and MHz), Power Limit (On/Off), PSD Limit (On/Off)
RF Channel Power Accuracy	± 1 dB typical (-76 dBm to +10 dBm)

5G NR Carrier Aggregation

Component Carriers	Up to Eight Component Carriers
PCI Measurements	Carrier, Sync status (PSS), Physical-layer Cell ID (PCI), Center Frequency, Bandwidth (BW), RSRP Max, EVM (RMS), Frequency Error (Hz), Time Offset
Setup Parameters	Carrier, Carrier Count (up to 8), Duplex Type (FDD/TDD)

5G NR Constellation

Measurements	Beam, PBCH-DMRS Power, PSS Power, SSS Power, RMS EVM, Peak EVM
PCI Measurements	Physical Cell ID, Sector ID, Cell Group, Frequency Error, Time Offset
Setup Parameters	Modulation (QPSK), Data Select (PBCH), Beam Select, Reference Points (on/off)

5G NR Spectral Emission Mask (supported in normal spectrum analyzer mode)

Measurements	Segment, RBW, Peak PWR, Peak Freq
Setup Parameters	Select Mask, Import Mask, Export Mask, REF CH BW, Auto Max PWR, Manual Max PWR

5G NR Adjacent Channel Power (supported in normal spectrum analyzer mode)

Measurements	Channel, Absolute, Relative, Limit
Setup Parameters	Channel Spacing, Main Integ BW, ADJ Integ BW, ALT Integ BW, Limit Type, Limits, Main CH Limit, ADJ CH Limit, ALT CH Limit

General Specifications

Setup Parameters

Display	Brightness adjustment, Auto screen dimming shutoff timer (on/off), Color schemes (Default, Light, Black on White, Night Vision), Shortcuts (Hide Shortcuts On/Off)
Sound	System Volume (Mute All On/Off), Defaults
Date and Time	Date and Time settings (Automatic, Manual), Time Zone settings, Time synced to Internet/GNSS
Language	English, Spanish, Chinese-simplified, Japanese, French, Korean
Display	Brightness adjustment, Auto screen dimming shutoff timer (on/off), Color schemes (Default, Light, Black on White, Night Vision), Shortcuts (Hide Shortcuts On/Off)
Screenshot	Capture Region (Graphs Only, Entire Application), Color (Printable, Standard), Annotations (Header, Footer) File naming (Automatic Timestamp, Manual), Directory
Options	Installed Options, Available Options, Install Options from web, Enable options using file (USB), Save Config
GNSS (GPS)	See "GNSS Receiver (Option 31)" on page 8
Ethernet	Ethernet (IP4 & IP6 formats), Type (DHCP, Static IP)
WLAN (Wi-Fi)	2x2 MIMO, 802.11 a/b/g/n/ac, On/Off, Auto detect wireless networks
Port Setup	Bias Voltage On/Off, Voltage, Info, Ref/Trig: Port 0 (Ref In), Port 1 (Ref Out, Trig In) Port 2 (Trig In, GPS 1 PPS Trig Out)
Maps	Remote Tile Usage, Local Tile Usage
Advanced	RF Safe Mode On/Off, SCPI Errors On/Off, Defaults

File Menu

Save/Recall	Measurement Setup, Screenshot Image (.PNG), Export Measurement data (Text, CSV), Location
File Management	Save, Copy, Paste, Delete, Create New Folder, Set File Name and File Type, Rename

Diagnostics Menu

Battery Information, Event Log (Export File), Self Test, Service (Enable Service Mode)

Tools Menu

Web, IQ Streaming, Map Tool, PDF Reports

Report Generator

PDF Reports	Creates detailed measurement reports on the instrument
Report Contents	Free form text fields to identify and locate the site of measurements, company logo image Cable and Antenna analyzer trace files, instrument screen captures and site photographs
Report Format	PDF and HTML

Connectors

RF In	MS2090A-0709, -0714, -0720: Type N(f), 50 Ω MS2090A-0726, -0732, -0743: Ruggedized Type K(m), 50 Ω MS2090A-0754: Ruggedized Type V(m), 50 Ω
GPS	SMA(f), 50 Ω
External Power	5.5 mm barrel connector, 14 to 16 VDC, 5.0 A max
Ethernet Interface	RJ45 connector for Ethernet 10/100/1000 Mbps (connect to PC or LAN for remote access and IQ streaming)
USB Interface	Two USB 3 Type A (supports file transfer and IQ capture/streaming) One USB 3 Type C (USB-TMC) (Compatible with external USB memory device that have an integrated keypad and are FIPS compliant using AES 256-bit encryption.)
Headset Jack	3.5 mm 3-wire headset jack
External Reference In	SMA(f), 50 Ω, maximum input +10 dBm
External Reference Out	SMA(f), 50 Ω, 10 MHz
External Trigger In	SMA(f), 50 Ω, TTL-compatible levels, max input/output: 0 to 5 VDC
External Trigger Out	SMA(f), 50 Ω, TTL-compatible levels, max input/output: 0 to 5 VDC
IF Out	SMA(f), 50 Ω (see "Zero Span IF Output (Option 89)" on page 8)
DC Bias Voltage	SMA(f), Setup: On/Off, Voltage, Trip Reset Voltage Range: +1 V to +34 V, Resolution: 0.1 V Max Current: 1 A, Max Power: 15 W

Display and Keyboard

Display	10.1-inches capacitive touchscreen, 1280 x 800 resolution
Shortcuts	Maximum of five user-configured measurement setup shortcuts
Screen Strength	IK08 (protected against a five joule impact)
Keyboard	Common alphanumeric/symbolic keys and customizable EZ keyboard
Touch Gestures	Pinch to zoom x (span), Drag in x (center frequency, markers, limit line points)
Toolbar	System menu, application menu, camera icon, USB eject icon, software update icon, local host icon, lock status (touchscreen), notification icon, Wi-Fi icon, GNSS icon, battery percentage icon, time and date

Battery

Type	Li-Ion
Battery Operation	Two hours operation, typical
Charging Temperature Limit	0 °C to +45 °C, relative humidity ≤ 80 %
Nominal Capacity	7500 mAh
Nominal Energy	84 Wh

Warranty

Duration	Standard three-year warranty One-year warranty on battery
----------	--

Size and Weight

Size	314 mm x 235 mm x 95 mm (12.4 in x 9.25 in x 3.74 in)
Weight	MS2090A-0709, -0714, -0720: 5.06 kg (11.15 lb) MS2090A-0726, -0732, -0743, -0754: 5.4 kg (11.9 lb)

Regulatory Compliance

European Union	EMC 2014/30/EU, EN 61326-1:2013 CISPR 11/EN 55011, IEC/EN 61000-4-2/3/4/5/6/8/11 Low Voltage Directive 2014/35/EU Safety EN 61010-1:2010 RoHS Directive 2011/65/EU & 2015/863
United Kingdom	EMC SI 2016/1091; BS EN 55011 & BS 61000-4-2/3/4/5/6/8/11 Consumer Protection (Safety) SI 2016/1101; BS EN 61010-1:2010 Environmental Protection SI 2012/3032; 2011/65/EU & 2015/863
Australia and New Zealand	RCM AS/NZS 4417:2012
South Korea	KCC-REM-A21+-0004
Canada	ICES-3(A)/NMB-3(A) ICES-1(A)/NMB-1(A) with Option 6
United States	FCC ID: SQG-60SIPT

Environmental

	MIL-PRF-28800F Class 2
Operating Temperature Range	-10°C to 55°C
Storage Temperature Range	-51°C to 71°C
Maximum Relative Humidity	95 % RH at 30°C, non-condensing
Vibration, Sinusoidal	5 Hz to 55 Hz
Vibration, Random	10 Hz to 500 Hz
Half Sine Shock	30 g _n
Altitude	4600 meters, operating and non-operating
Explosive Atmosphere	MIL-PRF-28800F Section 4.5.6.3 MIL-STD-810G, Method 511.5, Procedure 1

Remote Interface Software

Functionality	Free MS2090A software download from www.anritsu.com Full instrument graphical user interface control from a PC with simulated hardware support for on-screen measurement analysis
Interfaces	Ethernet, WLAN

Programmable Remote Control

Functionality	Full instrument programming control (except power on/off) via Ethernet and WLAN connectivity. See the Programming Manual for details.
Programming Language	Standard Commands for Programmable Instruments (SCPI)
Interfaces	Ethernet, WLAN, USBTMC (USB C port)

MA25424A IQ Data Converter (requires Options 124 and 125 or Options 126 and 127)

IQ Streaming (used for streaming IQ data components of a waveform from the MS2090A Data Out port to an IQCS5000)

Shipping Contents	MA25424A Module PCIe OCuLink I/O Data Cable USB 3.0 Type A to Type C Cable
Mode	Spectrum Analyzer, RTSA
Input Ports	Data In (PCIe), USB (for power)
Output Port	IEEE 1284-C, 50 pin
Data Throughput	200 MSPS @ 16 bit max
Power Consumption	3.33 W (USB 3.0)

Warranty

Duration	Standard one-year warranty
----------	----------------------------

Size and Weight

Size	128.3 mm x 33.43 mm x 88.86 mm
Weight	377 g (including cables)

MA25101A IQ Streaming PCIe Kit (requires Option 125 or Option 127)

IQ Streaming (used for streaming IQ data components of a waveform from the MS2090A Data Out port to a PC)

Shipping Contents	PCIe Computer Card with mounting hardware PCIe OCuLink I/O Data Cable
Software	MX280006A IQ Acquisition Tool (download from www.anritsu.com)
Mode	Spectrum Analyzer and RTSA
Input Ports	Data In (PCIe) (use PC Ethernet for instrument control and low speed IQ data streaming)
Data Rate	>800 MB/s max; 110 MHz @ 16 bits max

Warranty

Duration	90 days warranty
----------	------------------

Ordering Information – Instrument Options

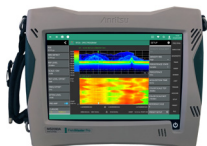
**Part Number Description**

MS2090A Field Master Pro (Requires Option 709, 714, 720, 726, 732, 743, or 754)

Options

MS2090A-0709	Frequency Range 9 kHz to 9 GHz
MS2090A-0714	Frequency Range 9 kHz to 14 GHz
MS2090A-0720	Frequency Range 9 kHz to 20 GHz
MS2090A-0726	Frequency Range 9 kHz to 26.5 GHz
MS2090A-0732	Frequency Range 9 kHz to 32 GHz
MS2090A-0743	Frequency Range 9 kHz to 43.5 GHz
MS2090A-0754	Frequency Range 9 kHz to 54 GHz
MS2090A-0006	Remove Wi-Fi
MS2090A-0019*	High Accuracy Power Meter (requires compatible USB power sensor, sold separately)
MS2090A-0024*	Interference Finder (requires GNSS Receiver Option 31 and directional antenna, sold separately)
MS2090A-0031*	GNSS Receiver (requires GPS antenna, sold separately)
MS2090A-0089*	Zero Span IF Output
MS2090A-0090*	Gated Sweep
MS2090A-0103*	55 MHz Analysis Bandwidth
MS2090A-0104*	110 MHz Analysis Bandwidth
MS2090A-0124*	IQ Waveform Capture
MS2090A-0125*	IQ Waveform Streaming (requires Option 124, MA25424A recommended)
MS2090A-0126*	IQ Waveform Capture (non-export controlled)
MS2090A-0127*	IQ Waveform Streaming (non-export controlled, requires Option 126, MA25424A recommended)
MS2090A-0128*	Vector Signal Analysis Enabled (requires Option 124 or 126; use with MX280005A software)
MS2090A-0199*	Real-Time Spectrum Analyzer
MS2090A-0331*	Cable and Antenna Analyzer (requires Site Master S331P analyzer, sold separately)
MS2090A-0400*	Vision Monitor Enabled
MS2090A-0407*	Vision High-Speed Port Scanner Enabled
MS2090A-0421*	Pulse Analyzer
MS2090A-0431*	Coverage Mapping (requires GNSS Receiver Option 31)
MS2090A-0444*	EMF Measurement (requires a compatible Anritsu isotropic antenna)
MS2090A-0445*	EMF Meter Enabled (requires 2000-1985-R isotropic EMF probe)
MS2090A-0509*	AM/FM Modulation Measurement
MS2090A-0883*	LTE FDD/TDD Measurements (requires GNSS Receiver Option 31)
MS2090A-0888*	5G NR FDD/TDD Measurements (requires GNSS Receiver Option 31)
MS2090A-xxxx-0097	Accredited Calibration to ISO17025 and ANSI/NCSL Z540-1 (xxxx is the frequency option number)
MS2090A-xxxx-0098	Standard Calibration to ISO17025 and ANSI/NCSL Z540-1 (xxxx is the frequency option number)
MS2090A-xxxx-0099	Premium Calibration to ISO17025 and ANSI/NCSL Z540-1 plus test data (xxxx is the frequency option number)

* **Timed-Limited Options** Options marked with an asterisk are offered as a 90-day time limited option by ordering as a -9xxx series option. For example, MS2090A-9888 is the 90-day time limited option for 5G NR FDD/TDD Measurements. The option start time begins when the user first activates the option.

Supported Software

MX280005A	IQ Signal Master™ Vector Modulation Analysis
MX280007A	Mobile InterferenceHunter™
MS2090A	PC Remote User Interface

Standard Accessories (included with instrument)





Accessory	Description
	3-2000-1928 Shoulder Strap
	2000-1931-R Stylus
	633-75 Li-Ion Rechargeable Battery
	40-204-R AC/DC Power Adapter (Field Master Series)
Certificate of Calibration and Conformance	





Accessory	Description
	2000-1371-R Ethernet Cable, 2 m
	2000-1859-R USB Cable, USB 3.0 Type-A to Type-C, 1 m
	806-442-R SMA(m) to BNC(m) cable, 1 m
	2000-2054-R SMA(m) to BNC(f) Adapter (qty 3)

Related Manuals (available at www.anritsu.com)

Part Number	Description
10100-00069	Product Information, Compliance, and Safety
10580-00444	Field Master Pro User Guide
10580-00445	Field Master Pro Programming Manual
10580-00447	Field Master Series Spectrum Analyzer Measurement Guide Interference Finder (Option 24, requires Option 31) Zero Span IF Output (Option 89) Gated Sweep (Option 90) Coverage Mapping (Option 431) EMF Measurement (Option 444) AM/FM Modulation Measurement (Option 509)
10580-00448	Field Master Series RTSA Measurement Guide (Option 199) Interference Finder (Option 24, requires Option 31)
10580-00449	Field Master Series 5G NR Measurement Guide (Option 888) Gated Sweep (Option 90) Coverage Mapping (Option 431)
10580-00450	Field Master Series LTE Measurement Guide (Option 883) Gated Sweep (Option 90) Coverage Mapping (Option 431)
10580-00451	Field Master Series Pulse Analyzer Measurement Guide (Option 421)
10580-00489	Field Master Series EMF Meter Measurement Guide (Option 445)
10580-00490	Field Master Series IQ Capture/Streaming Measurement Guide (Options 124/126 and Options 125/127)
10580-00492	Field Master Series High Accuracy Power Meter Measurement Guide (Option 19)
10580-00493	Field Master Series Cable and Antenna Analyzer Measurement Guide (Option 331)

USB Sensors and Power Indicator (for complete ordering information, see the respective data sheets of each sensor)

Accessory	Description
	MA24330A Microwave CW USB Power Sensor, 10 MHz to 33 GHz, +20 dBm
	MA24340A Microwave CW USB Power Sensor, 10 MHz to 40 GHz, +20 dBm
	MA24350A Microwave CW USB Power Sensor, 10 MHz to 50 GHz, +20 dBm
	MA24208A Microwave Universal USB Power Sensor, 10 MHz to 8 GHz, +20 dBm to -60 dBm
	MA24218A Microwave Universal USB Power Sensor, 10 MHz to 18 GHz, +20 dBm to -60 dBm
	MA24106A High Accuracy RF Power Sensor, 50 MHz to 6 GHz, +23 dBm to -40 dBm

Accessory	Description
	MA24108A Microwave USB Power Sensor, 10 MHz to 8 GHz, +20 dBm to -40 dBm
	MA24118A Microwave USB Power Sensor, 10 MHz to 18 GHz, +20 dBm to -40 dBm
	MA24126A Microwave USB Power Sensor, 10 MHz to 26 GHz, +20 dBm to -40 dBm
	S331P Ultraportable Cable & Antenna Analyzer 150 kHz to 4.0 GHz or 6 GHz
	MA25100A RF Power Indicator



Optional Accessories



Miscellaneous Accessories

Accessory	Description
	2000-1945-R MS2090A Soft Case
	67135 Anritsu Backpack (for Handheld Instrument and PC)
	760-243-R Large Transit Case with Wheels and Handle 56 cm x 45.5 cm x 26.5 cm (22.07" x 17.92" x 10.42")
	40-207-R Automotive DC/DC Power Adapter
	2000-2048-R Screen Protector (Field Master Pro)
	760-283 Transit Case, USB 1 Port VNA (for transport of Site Master S331P)

Accessory	Description
	MA2700A Handheld InterferenceHunter (For full specifications, refer to the MA2700A Technical Data Sheet 11410-00692)
	MA25424A I/Q Data Converter Module Includes: 2000-2030-R PCIe OCuLink I/O Data Cable 2000-1859-R USB 3.0 Type A to Type C Cable
	MA25101A IQ Streaming PCIe Kit Includes: PCIe Card with mounting hardware 2000-2030-R PCIe OCuLink I/O Data Cable
	2000-1374-R External Dual Charger for Li-Ion Batteries
	2000-2053-R Shoulder Harness (Field Master Pro)

USB Extender Kit (for use with external USB sensors; requires Cat 5e extension cable, sold separately)

Accessory	Description
	2000-1900-R USB 2.0 Active 100 meter Extender (with Type A power cord for USA, Japan, North America, Central America and Caribbean)
	2000-1901-R USB 2.0 Active 100 meter Extender (with Type C power cord for use in Europe, India, South Korea, and many countries in Middle East and Africa)
	2000-1902-R USB 2.0 Active 100 meter Extender (with Type I power cord for use in Australia, New Zealand, Argentina, and the South Pacific)
	2000-1903-R USB 2.0 Active 100 meter Extender (with Type G power cord for use in the UK, and several other countries in Asia, the Middle East, and Africa)



Accessory	Description
	2000-1717-R USB 1.1 Passive 40 m Extender (Not compatible with sensors MA24208A, MA24218A, MA24330A, MA24340A, MA24350A; must use active extenders with these sensors).
	2100-28-R Cat 5e extension cable for use with USB Extender (22.5 m)

Calibration Components, 50 Ω

Accessory	Description
	OSLN50A-8 High Performance Type N(m), DC to 8 GHz, 50 Ω
	OSLNF50A-8 High Performance Type N(f), DC to 8 GHz, 50 Ω
	2000-1914-R Precision Open/Short/Load, 4.3-10(f), DC to 6 GHz, 50 Ω
	2000-1915-R Precision Open/Short/Load, 4.3-10(m), DC to 6 GHz, 50 Ω
	2000-1618-R Precision Open/Short/Load, 7/16 DIN(m), DC to 6.0 GHz 50 Ω

Accessory	Description
	2000-1619-R Precision Open/Short/Load, 7/16 DIN(f), DC to 6.0 GHz 50 Ω
	22N50 Open/Short, N(m), DC to 18 GHz, 50 Ω
	22NF50 Open/Short, N(f), DC to 18 GHz, 50 Ω
	SM/PL-1 Precision Load, N(m), 42 dB, 6.0 GHz
	SM/PLNF-1 Precision Load, N(f), 42 dB, 6.0 GHz

GPS Antennas (active)

Accessory	Description
	2000-1528-R Magnet Mount, SMA(m) with 5 m (16.4 ft) cable, requires 5 VDC
	2000-1652-R Magnet Mount, SMA(m) with 0.3 m (1 ft) cable, requires 3.3 VDC or 5 VDC



Accessory	Description
	2000-1760-R Miniature Antenna, SMA(m), requires 2.5 VDC to 3.7 VDC

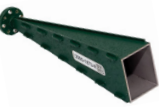

Directional Horn Antennas











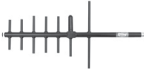





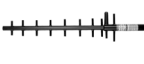

Accessory	Description
	2000-1867-R 17.6 GHz to 26.7 GHz, WR42, 25 dBi gain
	2000-1868-R 26.4 GHz to 40.1 GHz, WR28, 25 dBi gain
	2000-1869-R 33.0 GHz to 50.1 GHz, WR22, 25 dB gain
	2000-1870-R 39.3 GHz to 59.7 GHz, WR19, 25 dBi gain

Accessory	Description
	2000-2003-R 24 GHz to 40 GHz, WR28, 19 dBi gain (small form factor assembly with K(f) adapter, mounting bracket, and case)

EMF Antennas/Probes

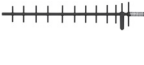
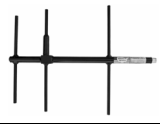

Accessory	Description
	2000-1800-R Isotropic Antenna, H-Field, 9 kHz to 300 MHz
	2000-1792-R Isotropic Antenna, E-Field, 30 MHz to 3 GHz

Accessory	Description
	2000-1791-R Isotropic Antenna, E-Field, 0.7 GHz to 6 GHz
	2000-1985-R EMF Probe, 20 MHz to 40 GHz

Directional Antennas		Accessory	
Accessory	Description	Accessory	Description
	2000-1411-R 824 MHz to 896 MHz, N(f), 12.3 dBi, Yagi		2000-1726-R 2500 MHz to 2700 MHz, N(f), 14.1 dBi, Yagi
	2000-1412-R 885 MHz to 975 MHz, N(f), 12.6 dBi, Yagi		2000-1747-R Log Periodic, 300 MHz to 7000 MHz, N(f), 5.1 dBi, typical
	2000-1413-R 1710 MHz to 1880 MHz, N(f), 12.3 dBi, Yagi		2000-1748-R Log Periodic, 1 GHz to 18 GHz, N(f), 6 dBi, typical
	2000-1414-R 1850 MHz to 1990 MHz, N(f), 11.4 dBi, Yagi		2000-1777-R Portable Directional Antenna, 9 kHz to 20 MHz, N(f) (requires port extender 2000-1798-R when used with MA2700A)
	2000-1415-R 2400 MHz to 2500 MHz, N(f), 14.1 dBi, Yagi		2000-1778-R Portable Directional Antenna, 20 MHz to 200 MHz, N(f) (requires port extender 2000-1798-R when used with MA2700A)
	2000-1416-R 1920 MHz to 2170 MHz, N(f), 14.3 dBi, Yagi		2000-1779-R Portable Directional Antenna, 200 MHz to 500 MHz, N(f) (requires port extender 2000-1798-R when used with MA2700A)
	2000-1659-R 698 MHz to 787 MHz, N(f), 10.1 dBi, Yagi		2000-1812-R Portable Yagi Antenna, 450 MHz to 512 MHz, N(f), 7.1 dBi
	2000-1660-R 1425 MHz to 1535 MHz, N(f), 14.3 dBi, Yagi		2000-1825-R Portable Yagi Antenna, 380 MHz to 430 MHz, N(f), 7.1 dBi
	2000-1715-R Directional Antenna, 698 MHz to 2500 MHz, N(f), gain of 2 dBi to 10 dBi, typical		2000-1798-R Port Extender, DC to 6 GHz
	2000-2107-R Log Periodic, 20 MHz to 8.5 GHz		



Magnet Mount and Broadband Antennas

Accessory	Description
	2000-2141-R 20 MHz to 21000 MHz, N(f), 50 Ω
	2000-1645-R 694 MHz to 894 MHz, 3 dBi peak gain 1700 MHz to 2700 MHz, 3 dBi peak gain, N(m), 50 Ω, 10 ft
	2000-1646-R 750 MHz to 1250 MHz, 3 dBi peak gain, 1650 MHz to 2000 MHz, 5 dBi peak gain, 2100 MHz to 2700 MHz, 5 dBi peak gain, N(m), 50 Ω, 10 ft
	2000-1647-R Cable 1: 698 MHz to 1200 MHz, 2 dBi peak gain, 1700 MHz to 2700 MHz, 5 dBi peak gain, N(m), 50 Ω, 10 ft Cable 2: 3000 MHz to 6000 MHz, 5 dBi peak gain, N(m), 50 Ω, 10 ft Cable 3: GPS 26 dB gain, SMA(m), 50 Ω, 10 ft

Accessory	Description
	2000-1648-R 1700 MHz to 6000 MHz, 3 dBi peak gain, N(m), 50 Ω, 10 ft
	2000-1946-R Cable 1: 617 MHz to 960 MHz, 3 dBi peak gain, 1710 MHz to 3700 MHz, 4 dBi peak gain, N(m), 50 Ω, 10 ft Cable 2: 3000 MHz to 6000 MHz, 5 dBi peak gain, N(m), 50 Ω, 10 ft Cable 3: GPS 26 dB gain, SMA(m), 50 Ω, 10 ft
	2000-1940-R Ka Band 26.5 GHz to 40 GHz, K(f) (2.92 mm), 3 dBi gain

Portable Antennas

Accessory	Description
	2000-1200-R 806 MHz to 866 MHz, SMA(m), 50 Ω
	2000-1473-R 870 MHz to 960 MHz, SMA(m), 50 Ω
	2000-1035-R 896 MHz to 941 MHz, SMA(m), 50 Ω (1/2 wave)
	2000-1030-R 1710 MHz to 1880 MHz, SMA(m), 50 Ω (1/2 wave)
	2000-1474-R 1710 MHz to 1880 MHz with knuckle elbow (1/2 wave)
	2000-1031-R 1850 MHz to 1990 MHz, SMA(m), 50 Ω (1/2 wave)

Accessory	Description
	2000-1475-R 1920 MHz to 1980 MHz and 2110 MHz to 2170 MHz, SMA(m), 50 Ω
	2000-1032-R 2400 MHz to 2500 MHz, SMA(m), 50 Ω (1/2 wave)
	2000-1751-R 698 MHz to 960 MHz, 1710 MHz to 2100 MHz, 2500 MHz to 2700 MHz, SMA(m), 2 dB, typical, 50 Ω
	2000-1361-R 2400 MHz to 2500 MHz, 5000 MHz to 6000 MHz, SMA(m), 50 Ω
	2000-1636-R Antenna Kit (Consists of: 2000-1030-R, 2000-1031-R, 2000-1032-R, 2000-1200-R, 2000-1035-R, 2000-1361-R, and carrying pouch)

Bandpass Filters

Accessory	Description
	1030-114-R 806 MHz to 869 MHz, N(m) to SMA(f), 50 Ω
	1030-109-R 824 MHz to 849 MHz, N(m) to SMA(f), 50 Ω
	1030-110-R 880 MHz to 915 MHz, N(m) to SMA(f), 50 Ω
	1030-111-R 1850 MHz to 1910 MHz, N(m) to SMA(f), 50 Ω
	1030-112-R 2400 MHz to 2484 MHz, N(m) to SMA(f), 50 Ω
	1030-105-R 890 MHz to 915 MHz, N(m) to N(f), 50 Ω
	1030-106-R 1710 MHz to 1790 MHz, N(m) to N(f), 50 Ω
	1030-107-R 1910 MHz to 1990 MHz, N(m) to N(f), 50 Ω
	1030-149-R High Pass, 150 MHz, N(m) to N(f), 50 Ω
	1030-150-R High Pass, 400 MHz, N(m) to N(f), 50 Ω
	1030-151-R High Pass, 700 MHz, N(m) to N(f), 50 Ω
	1030-152-R Low Pass, 200 MHz, N(m) to N(f), 50 Ω
	1030-153-R Low Pass, 550 MHz, N(m) to N(f), 50 Ω
	1030-155-R 2500 MHz to 2700 MHz, N(m) to N(f), 50 Ω
	1030-178-R 1920 MHz to 1980 MHz, N(m) to N(f), 50 Ω
	1030-179-R 777 MHz to 798 MHz, N(m) to N(f), 50 Ω
	1030-180-R 2500 MHz to 2570 MHz, N(m) to N(f), 50 Ω

Accessory Description

Accessory	Description
	2000-1734-R 699 MHz to 715 MHz, N(m) and N(f), 50 Ω
	2000-1735-R 776 MHz to 788 MHz, N(m) and N(f), 50 Ω
	2000-1736-R 815 MHz to 850 MHz, N(m) and N(f), 50 Ω
	2000-1737-R 1711 MHz to 1756 MHz, N(m) and N(f), 50 Ω
	2000-1738-R 1850 MHz to 1910 MHz, N(m) and N(f), 50 Ω
	2000-1739-R 880 MHz to 915 MHz, N(m) and N(f), 50 Ω
	2000-1740-R 1710 MHz to 1785 MHz, N(m) and N(f), 50 Ω
	2000-1741-R 1920 MHz to 1980 MHz, N(m) and N(f), 50 Ω
	2000-1742-R 832 MHz to 862 MHz, N(m) and N(f), 50 Ω
	2000-1743-R 2500 MHz to 2570 MHz, N(m) and N(f), 50 Ω
	2000-1799-R 2305 MHz to 2320 MHz, N(m) and N(f), 50 Ω
	2000-1911-R 703 MHz to 748 MHz, N(m) to N(f), 50 Ω
	2000-1912-R 788 MHz to 798 MHz, N(m) to N(f), 50 Ω
	2000-1925-R 663 MHz to 698 MHz, N(m) to N(f), 50 Ω
	2000-1926-R 776 MHz to 806 MHz, N(m) to N(f), 50 Ω
	2000-1684-R 791 MHz to 821 MHz, N(m) to N(f), 50 Ω

Attenuators

Accessory	Description
	1010-121-R 40 dB, 100 W, DC to 18 GHz, N(f) to N(m), Unidirectional
	3-1010-122 20 dB, 5 W, DC to 12.4 GHz, N(m) to N(f)
	3-1010-123 30 dB, 50 W, DC to 8.5 GHz, N(m) to N(f)
	3-1010-124 40 dB, 100 W, DC to 8.5 GHz, N(f) to N(m), Unidirectional

Accessory Description

Accessory	Description
	42N50-20 20 dB, 5 W, DC to 18 GHz, N(m) to N(f)
	42N50A-30 30 dB, 50 W, DC to 18 GHz, N(m) to N(f)
	1010-127-R 30 dB, 150 W, DC to 3 GHz, N(m) to N(f)
	1010-128-R 40 dB, 150 W, DC to 3 GHz, N(m) to N(f)

Fixed Attenuators

Accessory	Description
	43KC-3 Precision, DC to 26.5 GHz, 1W, 3 dB, K(m) to K(f)
	43KC-6 Precision, DC to 26.5 GHz, 1W, 6 dB, K(m) to K(f)
	43KC-10 Precision, DC to 26.5 GHz, 1W, 10 dB, K(m) to K(f)
	43KC-20 Precision, DC to 26.5 GHz, 1W, 20 dB, K(m) to K(f)

	41KB-3 Precision, DC to 26.5 GHz, 1W, 3 dB, K(m) to K(f)
---	---

	41KB-6 Precision, DC to 26.5 GHz, 1W, 6 dB, K(m) to K(f)
---	---

	41KB-10 Precision, DC to 26.5 GHz, 1W, 10 dB, K(m) to K(f)
--	---



	41KB-20 Precision, DC to 26.5 GHz, 1W, 20 dB, K(m) to K(f)
---	---

Precision Adapters

Accessory	Description
	34NN50A N(m) to N(m), DC to 18 GHz, 50 Ω

	34NFnF50 N(f) to N(f), DC to 18 GHz, 50 Ω
---	--

Accessory Description

	41VA-3 Precision, DC to 70 GHz, 1W, 3 dB, V(m) to V(f)
	41VA-6 Precision, DC to 70 GHz, 1W, 6 dB, V(m) to V(f)
	41VA-10 Precision, DC to 70 GHz, 1W, 10 dB, V(m) to V(f)
	41VA-20 Precision, DC to 70 GHz, 1W, 20 dB, V(m) to V(f)

	41KC-3 Precision, DC to 40 GHz, 1W, 3 dB, K(m) to K(f)
---	---

	41KC-6 Precision, DC to 40 GHz, 1W, 6 dB, K(m) to K(f)
---	---

	41KC-10 Precision, DC to 40 GHz, 1W, 10 dB, K(m) to K(f)
--	---

	41KC-20 Precision, DC to 40 GHz, 1W, 20 dB, K(m) to K(f)
---	---

Accessory Description

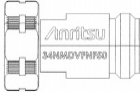
	34NMDVnF50 NMD, V(f) to N(f), DC to 18 GHz, 50 Ω
---	---

	71693-R Ruggedized K(f) to N(f), DC to 18 GHz, 50 Ω
---	--

Adapters Accessory	Description
	1091-26-R SMA(m) to N(m), DC to 18 GHz, 50 Ω
	1091-27-R SMA(f) to N(m), DC to 18 GHz, 50 Ω
	1091-80-R SMA(m) to N(f), DC to 18 GHz, 50 Ω
	1091-81-R SMA(f) to N(f), DC to 18 GHz, 50 Ω
	1091-172-R BNC(f) to N(m), DC to 1.3 GHz, 50 Ω
	1091-417-R N(m) to QMA(f), DC to 6 GHz, 50 Ω
	1091-418-R N(m) to QMA(m), DC to 18 GHz, 50 Ω

Accessory	Description
	510-102-R N(m) to N(m), DC to 11 GHz, 50 Ω, 90° right angle
	510-90-R 7/16 DIN(f) to N(m), DC to 7.5 GHz, 50 Ω
	510-91-R 7/16 DIN(f) to N(f), DC to 7.5 GHz, 50 Ω
	510-92-R 7/16 DIN(m) to N(m), DC to 7.5 GHz, 50 Ω
	510-93-R 7/16 DIN(m) to N(f), DC to 7.5 GHz, 50 Ω
	510-96-R 7/16 DIN(m) to 7/16 DIN (m), DC to 7.5 GHz, 50 Ω
	510-97-R 7/16 DIN(f) to 7/16 DIN (f), DC to 7.5 GHz, 50 Ω



Coaxial Adapters

Accessory	Description
	34VFK50A DC to 43.5 GHz, V(f) to K(m), 50 Ω
	34VFKF50A DC to 43.5 GHz, V(f) to K(f), 50 Ω
	34VV50 DC to 65 GHz, V(m) to V(m), 50 Ω
	34VVF50 DC to 65 GHz, V(f) to V(m), 50 Ω
	34VVF50 DC to 65 GHz, V(f) to V(f), 50 Ω



Accessory	Description
	2000-1880-R DC to 18 GHz, N(m) to V(f), 50 Ω
	2000-1881-R DC to 18 GHz, N(f) to V(f), 50 Ω
	K222B DC to 40 GHz, K(f) to K(f), 50 Ω



Precision Waveguide Coaxial Adapters (right angle)

Accessory	Description
	35WR42KF 18 GHz to 26.5 GHz, WR42 to K(f)
	35WR28KF 26.5 GHz to 40 GHz, WR28 to K(f)
	35WR22VF 33 GHz to 50 GHz, WR22 to V(f)

Accessory	Description
	35WR15VF 50 GHz to 65 GHz, WR15 to V(f)
	35WR19VF 40 GHz to 60 GHz, WR19 to V(f)

Waveguide to Coaxial End Launch Adapters (straight through)

Accessory	Description
	2000-1889-R 17.6 GHz to 26.7 GHz, WR42 to K(f)
	2000-1890-R 26.4 GHz to 40.1 GHz, WR28 to K(f)
	1091-460-R 17.6 GHz to 26.7 GHz, WR42 to V(f)
	1091-459-R 26.4 GHz to 40.1 GHz, WR28 to V(f)



Accessory	Description
	1091-458-R 33.0 GHz to 50.1 GHz, WR22 to V(f)
	1091-457-R 39.3 GHz to 59.7 GHz, WR19 to V(f)
	1091-456-R 49.9 GHz to 67.0 GHz, WR15 to V(f)

Test Port Cables (Armored, Semi-rigid)

Accessory	Description
	3670K50A-1 K(f) to K(m), 30.48 cm
	3670K50A-2 K(f) to K(m), 60.96 cm

Accessory	Description
	3670V50A-1 DC to 70 GHz, V(f) to V(m), 30.5 cm (1 ft)
	3670V50A-2 DC to 70 GHz, V(f) to V(m), 61.0 cm (2 ft)

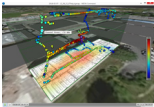
NEON® MA8100A Signal Mapper

Accessory	Description
	MA8100A-000 NEON Signal Mapper with Anritsu Integration and Tracking Unit. Includes 3 months NEON Software License with 3 months of maintenance and support and 3 months of Cloud Service (PN: 2300-607).
	MA8100A-001 NEON Signal Mapper with Anritsu Integration and Tracking Unit. Includes 1 year NEON Software License with 1 year of maintenance and support and 1 year of Cloud Service (PN: 2300-574).
	MA8100A-003 NEON Signal Mapper with Anritsu Integration and Tracking Unit. Includes 3 year NEON Software License with 3 years of maintenance and support and 3 years of Cloud Service (PN: 2300-575).
	MA8100A-005 NEON Signal Mapper with Anritsu Integration and Tracking Unit. Includes 5 year NEON Software License with 5 years of maintenance and support and 5 years of Cloud Service (PN: 2300-576).
	MA8100A-100 NEON Signal Mapper with Anritsu Integration and Tracking Unit. Includes Perpetual NEON Software License with 3 years of maintenance and support and 3 years of Cloud Service (PN: 2300-606).
	2000-1852-R NEON Tracking Unit (includes USB cable and belt clip, Worldwide version)
	2000-2015-R NEON Tracking Unit (includes USB cable and belt clip, Japan version)
	2000-1853-R Belt clip (for NEON Tracking Unit)

Accessory	Description
	2300-606 Perpetual NEON Software License with 3 years of maintenance and support and 3 years of Cloud Service. Part number can also be used to order a perpetual license after a limited term license has expired.
	2300-612 Renewal of 1 year NEON Software License with 1 year of maintenance and support and 1 year of Cloud Service.
	2300-613 Renewal of 3 year NEON Software License with 3 years of maintenance and support and 3 years of Cloud Service.
	2300-614 Renewal of 5 year NEON Software License with 5 years of maintenance and support and 5 years of Cloud Service.

Training at Anritsu

Anritsu has designed courses to help you stay up to date with technologies important to your job. For available training courses, visit: <https://www.anritsu.com> and search for training and education.



• United States

Anritsu Americas Sales Company
450 Century Parkway, Suite 190,
Allen, TX 75013, U.S.A.
Phone: +1-800-Anritsu (1-800-267-4878)

• Canada

Anritsu Electronics Ltd.
Americas Sales and Support
450 Century Parkway, Suite 190,
Allen, TX 75013, U.S.A.
Phone: +1-800-Anritsu (1-800-267-4878)

• Brazil

Anritsu Elettronica Ltda.
Praça Amadeu Amaral, 27 - 1 Andar
01327-010 - Bela Vista - Sao Paulo - SP, Brazil
Phone: +55-11-3283-2511
Fax: +55-11-3288-6940

• Mexico

Anritsu Company, S.A. de C.V.
Blvd Miguel de Cervantes Saavedra #169 Piso 1,
Col. Granada, Mexico, Ciudad de Mexico,
11520, MEXICO
Phone: +52-55-4169-7104

• United Kingdom

Anritsu EMEA Ltd.
200 Capability Green,
Luton, Bedfordshire, LU1 3LU, U.K.
Phone: +44-1582-433200
Fax: +44-1582-731303

• France

Anritsu S.A.
12 avenue du Québec, Immeuble Goyave,
91140 VILLEBON SUR YVETTE, France
Phone: +33-1-60-92-15-50

• Germany

Anritsu GmbH
Nemetschek Haus, Konrad-Zuse-Platz 1,
81829 München, Germany
Phone: +49-89-442308-0
Fax: +49-89-442308-55

• Italy

Anritsu S.r.l.
Spaces Eur Arte, Viale dell'Arte 25, 00144 Roma, Italy
Phone: +39-6-509-9711

List Revision Date: 20230407

• Sweden

Anritsu AB
Kistagången 20 B, 2 tr, 164 40 Kista, Sweden
Phone: +46-8-534-707-00

• Finland

Anritsu AB
Technopolis Aviapolis, Teknobulevardi 3-5 (D208.5),
FI-01530 Vantaa, Finland
Phone: +358-20-741-8100

• Denmark

Anritsu A/S
c/o Regus Winghouse, Ørestads Boulevard 73, 4th floor,
2300 Copenhagen S, Denmark
Phone: +45-7211-2200

• Spain

Anritsu EMEA Ltd.
Representation Office in Spain
Paseo de la Castellana, 141.
Planta 5, Edificio Cuzco IV
28046, Madrid, Spain
Phone: +34-91-572-6761

• Austria

Anritsu EMEA GmbH
Am Belvedere 10, A-1100 Vienna, Austria
Phone: +43-(0)1-717-28-710

• United Arab Emirates

Anritsu EMEA Ltd.
Anritsu A/S
Office No. 164, Building 17, Dubai Internet City
P. O. Box - 501901, Dubai, United Arab Emirates
Phone: +971-4-3758479

• India

Anritsu India Private Limited
6th Floor, Indiqube ETA, No.38/4, Adjacent to EMC2,
Doddanekundi, Outer Ring Road,
Bengaluru - 560048, India
Phone: +91-80-6728-1300
Fax: +91-80-6728-1301

• Singapore

Anritsu Pte. Ltd.
11 Chang Charn Road, #04-01, Shriro House
Singapore 159640
Phone: +65-6282-2400
Fax: +65-6282-2533

• Vietnam

Anritsu Company Limited
16th Floor, Peakview Tower, 36 Hoang Cau Street,
O Cho Dua Ward, Dong Da District, Hanoi, Vietnam
Phone: +84-24-3201-2730

• P.R. China (Shanghai)

Anritsu (China) Co., Ltd.
Room 2701-2705, Tower A, New Caohejing
International Business Center No. 391 Gui Ping Road
Shanghai, 200233, P.R. China
Phone: +86-21-6237-0898
Fax: +86-21-6237-0899

• P.R. China (Hong Kong)

Anritsu Company Ltd.
Unit 1006-7, 10/F., Greenfield Tower, Concordia Plaza,
No. 1 Science Museum Road, Tsim Sha Tsui East,
Kowloon, Hong Kong, P.R. China
Phone: +852-2301-4980
Fax: +852-2301-3545

• Japan

Anritsu Corporation
8-5, Tamura-cho, Atsugi-shi, Kanagawa, 243-0016 Japan
Phone: +81-46-296-6509
Fax: +81-46-225-8352

• South Korea

Anritsu Corporation, Ltd.
5FL, 235 Pangyojeok-ro, Bundang-gu, Seongnam-si,
Gyeonggi-do 13494, South Korea
Phone: +82-31-696-7750
Fax: +82-31-696-7751

• Australia

Anritsu Pty. Ltd.
Unit 20, 21-35 Ricketts Road,
Mount Waverley, Victoria 3149, Australia
Phone: +61-3-9558-8177
Fax: +61-3-9558-8255

• Taiwan

Anritsu Company Inc.
7F, No. 316, Sec. 1, NeiHu Rd., Taipei 114, Taiwan
Phone: +886-2-8751-1816
Fax: +886-2-8751-1817