

Anritsu Advancing beyond

ShockLine™ Performance Vector Network Analyzers

MS46522B

50 kHz to 43.5 GHz, E-Band



Introduction

The MS46522B is part of the ShockLine™ family of Vector Network Analyzers from Anritsu. It is a series of high performance, 3U tall, 2-port VNAs available in five different models: Three frequency models from 50 kHz to 43.5 GHz, and two E-band options with either one meter or five meter tethers. The MS46522B series is optimized for measuring S-parameters and time domain characteristics of passive RF and microwave devices.

The VNA supports SCPI command programming and has software driver support for the most common programming environments. The MS46522B uses industry standard LAN communications for robust remote control in test applications. ShockLine VNAs also provide a powerful graphical user interface for manual testing of devices. A full-featured user interface is enabled by attaching a (user-supplied) touchscreen monitor, keyboard, and mouse.

This document provides detailed specifications for the MS46522B Vector Network Analyzers (VNAs) and related options.

Instrument Models and Operating Frequencies

Base Model

- MS46522B, 2-Port ShockLine VNA

Requires one Frequency Option

- MS46522B-010, 50 kHz to 8.5 GHz
- MS46522B-020, 50 kHz to 20 GHz
- MS46522B-043, 50 kHz to 43.5 GHz
- MS46522B-082, 55 GHz to 92 GHz, one meter tethers
- MS46522B-083, 55 GHz to 92 GHz, five meter tethers

Principal Options

- MS46522B-002, Time Domain
- MS46522B-022, Advanced Time Domain
- MS46522B-024, Universal Fixture Extraction
- MS46522B-061, Bias Tee (Only available with Option 10)

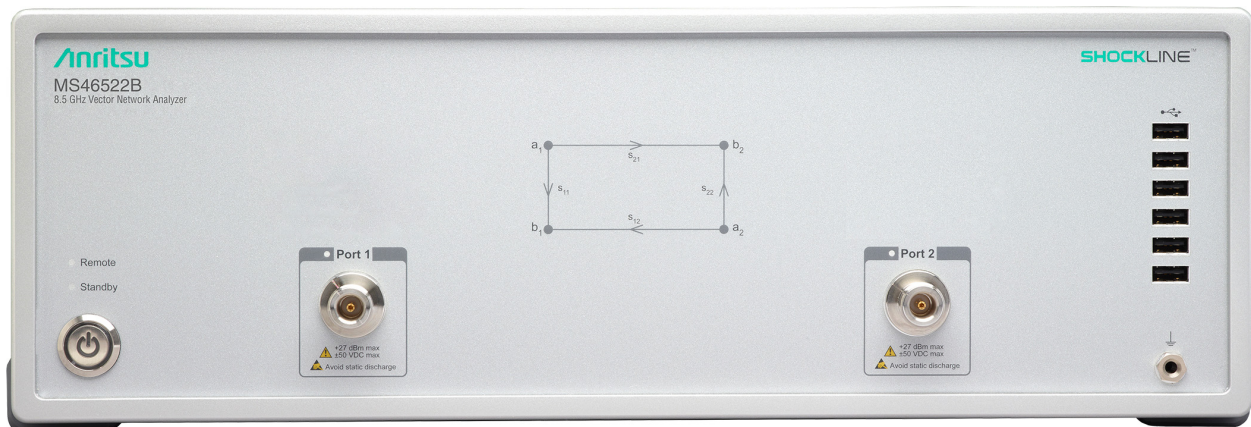

MS46522B ShockLine Performance VNA (8.5 GHz model shown)

Table of Contents

Definitions 4

System Dynamic Range 5

Receiver Compression Levels 5

High Level Noise 5

Output Power Range 7

Output Default Power 8

Power Accuracy 8

Power Setting Resolution 8

Measurement Stability 8

Frequency Resolution, Accuracy, and Stability 8

Source Harmonics and Non-Harmonics (Spurious) 8

Uncorrected (Raw) Port Characteristics 8

MS46522B-010 VNA System Performance with Manual Cal Kits 9

MS46522B-020 VNA System Performance with Manual Cal Kits 10

MS46522B-043 VNA System Performance with Manual Cal Kits 11

MS46522B-043 VNA System Performance with Manual Cal Kits 12

MS46522B-010 VNA System Performance with SmartCal™ 13

MS46522B-010 VNA System Performance with SmartCal™ 14

MS46522B-010 and MS46522B-020 VNA System Performance with SmartCal™ 15

MS46522B-010 and MS46522B-020 VNA System Performance with SmartCal™ 16

MS46522B-043 VNA System Performance with Precision AutoCal™ 17

MS46522B E-Band VNA System Performance 18

MS46522B-082 and MS46522B-083 E-Band VNA System Performance with Waveguide Cal Kit 20

Measurement Throughput Summary 21

Standard Capabilities 21

Calibration and Correction Capabilities 23

Optional Capabilities 24

Remote Operability 24

Front Panel Connections 25

Rear Panel Connections 26

CPU, Memory, and Security Features 27

Mechanical 27

Regulatory Compliance 27

Environmental 27

Warranty 27

Ordering Information 28

Definitions

	This technical data sheet applies to the following hardware revisions: MS46522B base model, revision 5 MS46522B-010 8.5 GHz option, revision 5 MS46522B-020 20 GHz option, revision 5 MS46522B-043 43.5 GHz option, revision 1 MS46522B-082 E-band 1m tethers option, revision 4 MS46522B-083 E-band 5m tethers option, revision 2 All specifications and characteristics apply under the following conditions, unless otherwise stated:
Warm-Up Time	After 45 minutes of warm-up time, where the instrument is left in the ON state.
Temperature Range	Over the 25 °C ± 5 °C temperature range.
Frequency Range	Unless otherwise noted, the instrument operates in the following frequency ranges without any implied or warranted specifications: 55 GHz to 60 GHz, and from 90 GHz to 92 GHz.
Specifications	Error-corrected specifications are valid over 23 °C ± 3 °C, with < 1 °C variation from calibration temperature. Specifications are warranted and include guard-bands, unless otherwise stated.
Frequency Bands in Tables	When a frequency is listed in two rows of the same table, the specification for the common frequency is taken from the lower frequency band.
User Cables	Specifications do not include effects of any user cables attached to the instrument.
Discrete Spurious Responses	Specifications may exclude discrete spurious responses.
Internal Reference Signal	All specifications apply with internal 10 MHz Crystal Oscillator Reference Signal.
Interpolation Mode	All specifications are with Interpolation Mode Off.
Standard	Refers to instruments with mandatory frequency option only.
Typical Performance	Typical performance indicates the measured performance of an average unit. It does not include guard-bands and is not covered by the product warranty. Typical specifications are shown in parenthesis, such as (-102 dB), or noted as Typical.
Characteristic Performance	Characteristic performance indicates a performance designed-in and verified during the design phase. It does include guard-bands and is not covered by the product warranty.
Recommended Calibration Cycle	12 months (Residual specifications also require calibration kit calibration cycle adherence.)
Specifications Subject to Change	All specifications subject to change without notice. For the most current data sheet, please visit the Anritsu web site: www.anritsu.com

The instrument may be protected by one or more of the following patents: 6894581, 7088111, 7545151, 7683633, 7924024, 8417189, 8718586, 10778592.

System Dynamic Range

System dynamic range is calculated as the difference between the test port maximum source power and the RMS noise floor at 10 Hz IF Bandwidth with ports terminated, averaging off, and smoothing on after calibrating the instrument for transmission frequency response and isolation. Measurement uncertainty and interfering signals must be taken into account when determining effective dynamic range.

MS46522B 8.5 GHz Model

Frequency Range	Standard (dB)	Typical (dB)
50 kHz to 1 MHz	90	101
> 1 MHz to 50 MHz	100	108
> 50 MHz to 1.8 GHz	140	144
> 1.8 GHz to 4 GHz	137	142
> 4 GHz to 6 GHz	130	137
> 6 GHz to 8 GHz	128	130
> 8 GHz to 8.5 GHz	120	127

MS46522B 20 GHz and 43.5 GHz Models

Frequency Range	Standard (dB)	Typical (dB)
50 kHz to 1 MHz	90	101
> 1 MHz to 50 MHz	100	108
> 50 MHz to 1.8 GHz	140	144
> 1.8 GHz to 4 GHz	137	142
> 4 GHz to 6 GHz	130	137
> 6 GHz to 8 GHz	122	124
> 8 GHz to 8.5 GHz	118	122
> 8.5 GHz to 12 GHz	114	120
> 12 GHz to 25 GHz	117	122
> 25 GHz to 40 GHz	119	126
> 40 GHz to 43.5 GHz	110	120

Receiver Compression Levels

Port power level beyond which the response may be compressed more than 0.2 dB relative to the normalization level. Measured at 300 Hz IF bandwidth. Match not included. Characteristic performance.

Frequency Range	Level (dBm)
50 kHz to 300 kHz	+10
> 300 kHz to 8 GHz ^a	+15
> 8 GHz to 43.5 GHz	+10

a. 8.5 GHz for Option 10

High Level Noise

Measured at 100 Hz IF bandwidth and at default power level, RMS.

Frequency	Magnitude (dB)	Phase (deg)
50 kHz to 300 kHz	0.02 (0.01, typical)	0.15 (0.08, typical)
> 300 kHz to 1 GHz	0.004 (0.003, typical)	0.04 (0.02, typical)
> 1 GHz to 25 GHz	0.004 (0.002, typical)	0.05 (0.02, typical)
> 25 GHz to 43.5 GHz	0.004 (0.002, typical)	0.05 (0.04, typical)

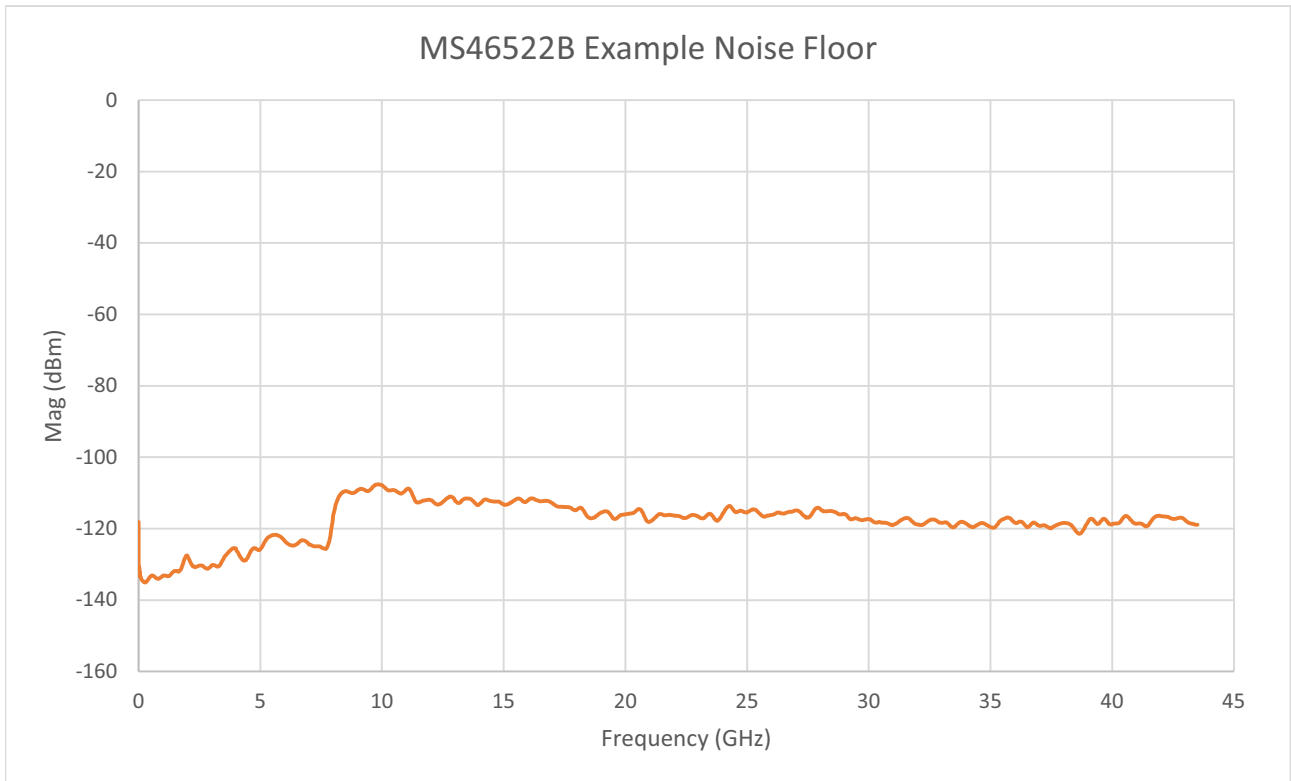

Output Power Range

Minimum to maximum rated power level.

Frequency	Standard (dBm)	Typical (dBm)
50 kHz to 300 kHz	-30 to +5	-30 to +10
50 kHz to 300 kHz	-30 to +9	-30 to +12
> 300 kHz to 6 GHz	-30 to +15	-30 to +17
> 6 GHz to 8 GHz	-30 to +12 ^a	-30 to +13
> 8 GHz to 8.5 GHz	-30 to +10	-30 to +11
> 8.5 GHz to 40 GHz	-30 to +6	-30 to +9
> 40 GHz to 43.5 GHz	-30 to +2	-30 to +4

a. Maximum power degrades by 2 dB for Options 20 and 43.

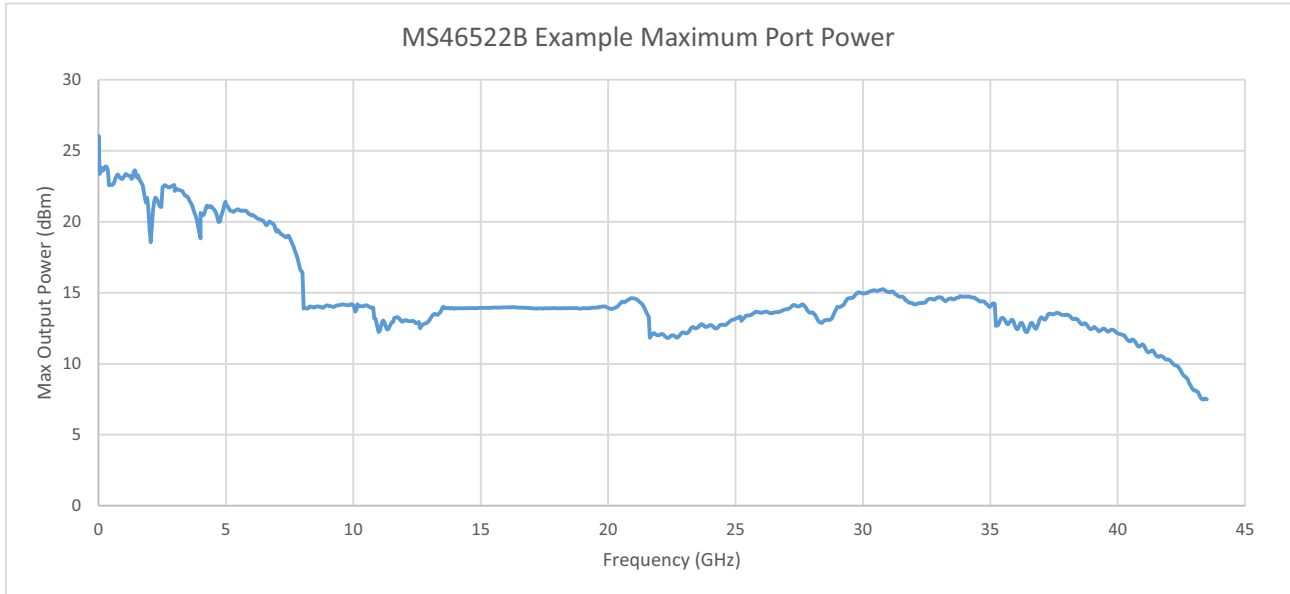

Output Default Power

Instrument default power is 0 dBm. For maximum rated power, refer to Output Power Range above. Not applicable to MS46522B-08x.

Power Accuracy

Not applicable to MS46522B-08x.

Output Power	50 kHz to 8.5 GHz (dB)	> 8.5 GHz to 25 GHz (dB)	> 25 GHz to 40 GHz (dB)	> 40 GHz to 43.5 GHz (dB)
At 0 dBm	$\pm 1.5^a$ (± 0.5)	± 2.0 (± 0.5)	± 2.5 (± 0.5)	± 3.0 (± 1.0)
At -30 dBm ^b	± 3.0	± 3.0	± 3.0	± 3.0

a. Source is open loop below 300 kHz. ± 2 dB typical.

b. Performance is typical.

Power Setting Resolution

Output Power	Setting Resolution (dB)
50 kHz to 43.5 GHz	0.01

Measurement Stability

Ratioed measurement, with ports shorted. Typical.

Frequency	Magnitude (dB/°C)	Phase (deg/°C)
50 kHz to 8.5 GHz	0.02	0.5
> 8.5 GHz to 40 GHz	0.01	1.0
> 40 GHz to 43.5 GHz	0.02	1.5

Frequency Resolution, Accuracy, and Stability

Applies to all MS46522B frequency models.

Resolution	Accuracy (ppm)	Stability/Temperature ^a	Stability ^a
1 Hz	± 0.1 (at time of calibration)	± 0.1 ppm/10 °C to 50 °C	± 0.02 ppm/24 hours ± 0.2 ppm/1 month ± 1.0 ppm/1 year ± 2.0 ppm/3 years

a. Typical

Source Harmonics and Non-Harmonics (Spurious)

Measured at 0 dBm. All specifications typical.

Frequency	Harmonics (second and third) (dBc)	Non-Harmonic Spurious (dBc)	Phase Noise @ 10 kHz Offset (dBc/Hz)
50 kHz to 8 GHz ^{a,b}	< -30	< -30	< -60
> 8 GHz to 15 GHz ^c	< -12	< -30	< -60
> 15 GHz to 22 GHz	< -15	< -30	< -60
> 22 GHz to 43.5 GHz	< -20	< -30	< -60

a. 50 kHz to 8.5 GHz for Option 10.

b. 50 kHz to 300 kHz: <-8 dBc harmonics, <-20 dBc Non-Harmonic Spurious.

c. In High Fidelity mode for Frequency Options 20 and 43.

MS46522B 20 GHz and 43.5 GHz Models

Frequency	Harmonics (second and third) (dBc)	Non-Harmonic Spurious (dBc)	Phase Noise @ 10 kHz Offset (dBc/Hz)
50 kHz to 300 kHz	< -15	< -20	< -60
> 300 kHz to 8 GHz	< -30	< -30	< -60
> 8 GHz to 10.8 GHz	< -8	< -30	< -60
> 10.8 GHz to 20 GHz	< -15	< -30	< -60
> 20 GHz to 43.5 GHz	< -20	< -30	< -50

Uncorrected (Raw) Port Characteristics

User correction off. System correction on. All specifications typical.

Frequency Range	Directivity (dB)	Port Match (dB) ^a
50 kHz to 1 GHz	> 21	> 17
> 1 GHz to 4 GHz	> 21	> 17
> 4 GHz to 8.5 GHz	> 15	> 15
> 8.5 GHz to 43.5 GHz	> 15	> 15

a. Port Match is defined as the worst of source and load match.

MS46522B-010 VNA System Performance with Manual Cal Kits

Error-Corrected Specifications

With 12-term SOLT Calibration using the TOSLN50A-18 N Type Connector Calibration Kit.

Frequency Range	Directivity (dB)	Source Match (dB)	Load Match ^a (dB)	Reflection Tracking ^a (dB)	Transmission Tracking ^a (dB)
50 kHz to 50 MHz	> 40	> 35	> 38	±0.15	±0.09
> 50 MHz to 6 GHz	> 40	> 35	> 38	±0.08	±0.05
> 6 GHz to 8 GHz	> 36	> 35	> 34	±0.08	±0.05
> 8 GHz to 8.5 GHz	> 36	> 35	> 34	±0.10	±0.08

a. Characteristic performance.

Measurement Uncertainties

The graphs give measurement uncertainties after the above error-corrected calibration. The errors are a worst-case contribution of residual directivity, load and source match, frequency response and isolation, network analyzer dynamic accuracy, and connector repeatability. 10 Hz IF Bandwidth is used. For transmission uncertainties, it is assumed that $S_{11} = S_{22} = 0$. For reflection uncertainties, it is assumed that $S_{21} = S_{12} = 0$. All calibrations and measurements were performed at 0 dBm or default port power, whichever is less. For other conditions, please use our free Exact Uncertainty Calculator software, available for download from the Anritsu web site at www.anritsu.com.

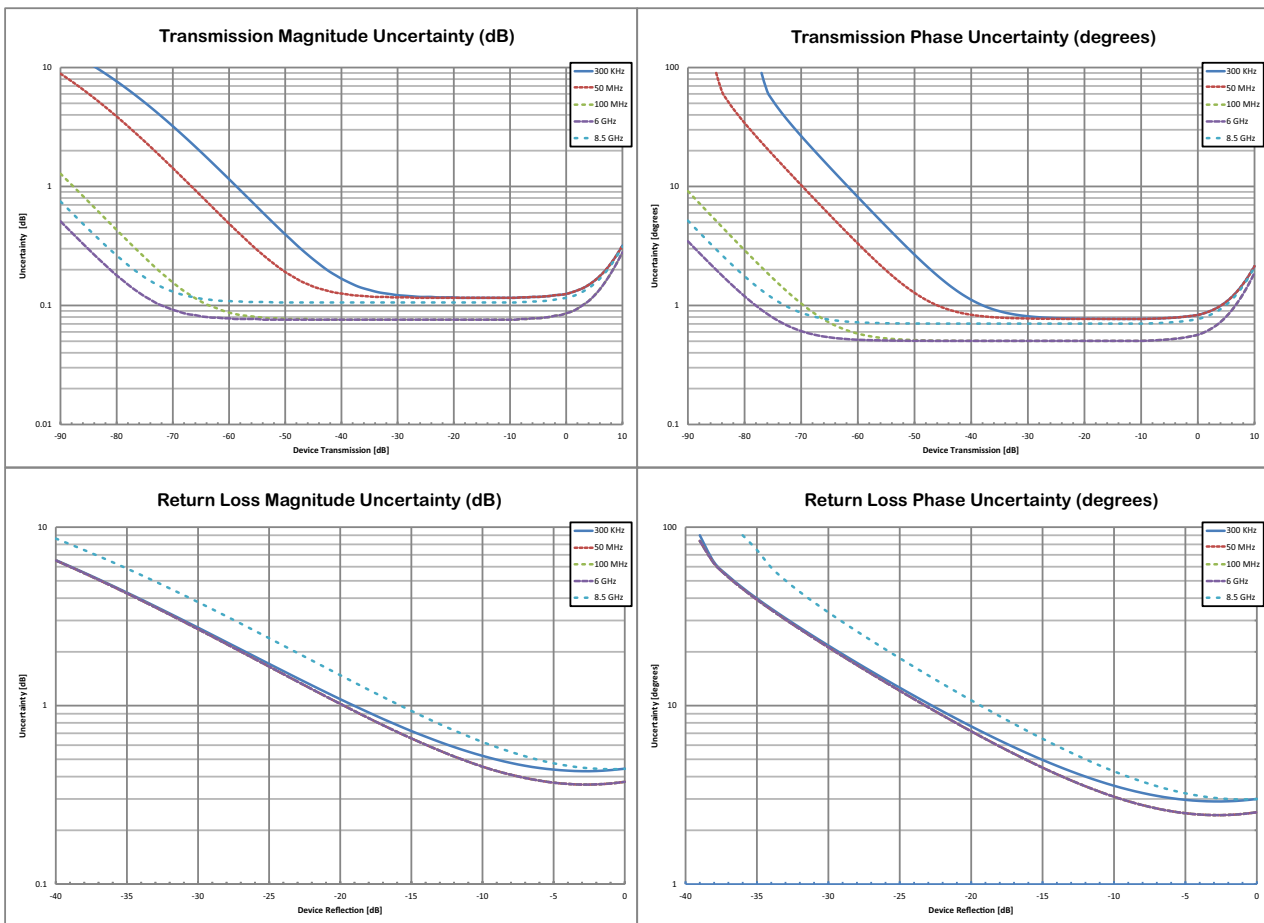

MS46522B-020 VNA System Performance with Manual Cal Kits

Error-Corrected Specifications

With 12-term SOLT Calibration using the TOSLKF50A-40 K Type Connector Calibration Kit.

Frequency Range	Directivity (dB)	Source Match (dB)	Load Match ^a (dB)	Reflection Tracking ^a (dB)	Transmission Tracking ^a (dB)
50 kHz to 50 MHz	> 42	> 35	> 42	±0.10	±0.09
> 50 MHz to 10 GHz	≥ 42	≥ 35	≥ 42	±0.10	±0.05
> 10 GHz to 20 GHz	≥ 36	≥ 26.5	≥ 36	±0.10	±0.05

a. Characteristic performance.

Measurement Uncertainties

The graphs give measurement uncertainties after the above error-corrected calibration. The errors are a worst-case contribution of residual directivity, load and source match, frequency response and isolation, network analyzer dynamic accuracy, and connector repeatability. 10 Hz IF Bandwidth is used. For transmission uncertainties, it is assumed that $S_{11} = S_{22} = 0$. For reflection uncertainties, it is assumed that $S_{21} = S_{12} = 0$. All calibrations and measurements were performed at 0 dBm or default port power, whichever is less. For other conditions, please use our free Exact Uncertainty Calculator software, available for download from the Anritsu web site at www.anritsu.com.

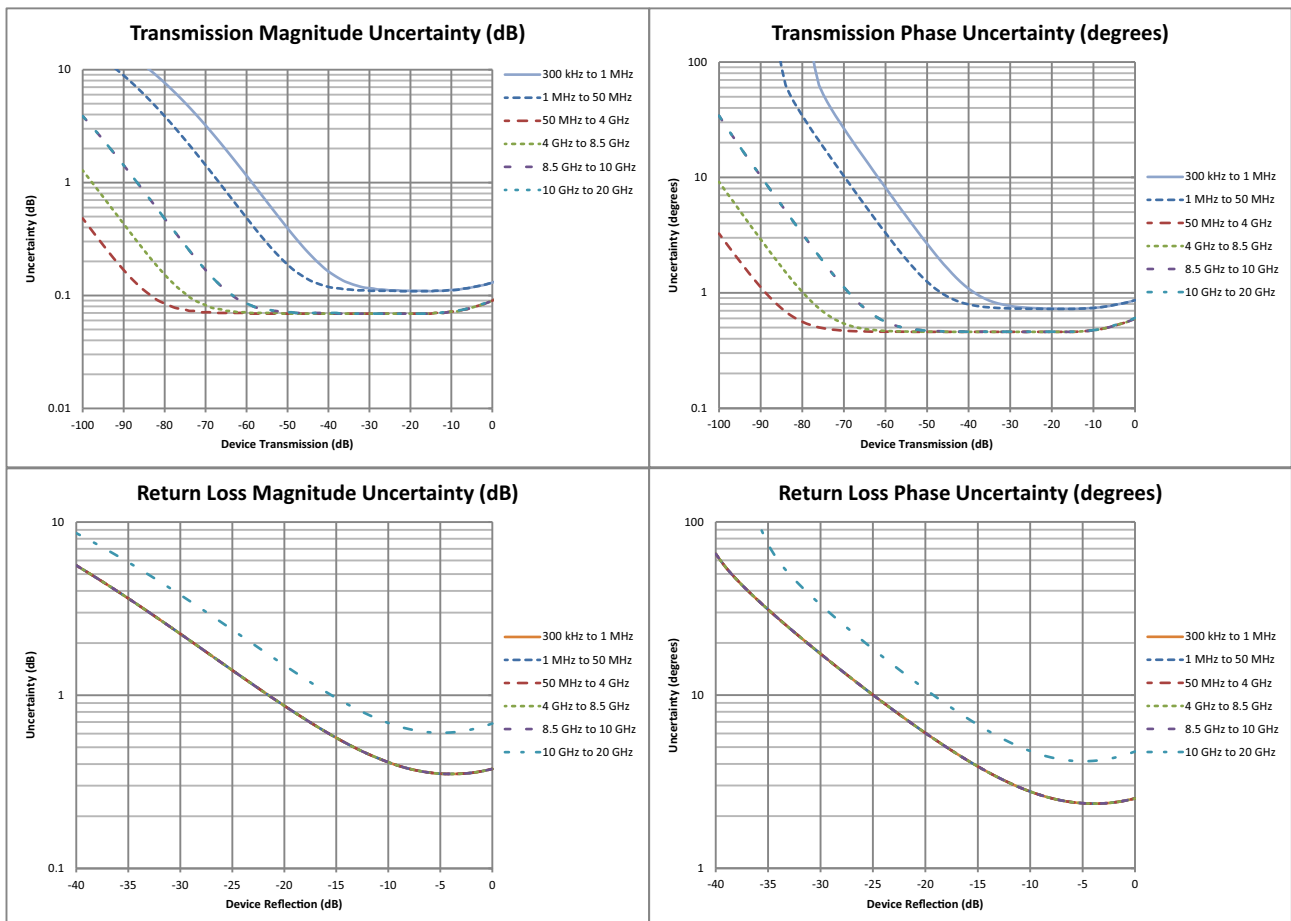

MS46522B-043 VNA System Performance with Manual Cal Kits

Error-Corrected Specifications

With 12-term SOLT Calibration using the TOSLK50A-43.5 or TOSLKF50A-43.5 K Type Connector Calibration Kit with generic calibration coefficients.

Frequency Range	Directivity (dB)	Source Match (dB)	Load Match ^a (dB)	Reflection Tracking ^a (dB)	Transmission Tracking ^a (dB)
50 kHz to 50 MHz	> 42	> 35	> 42	±0.10	±0.09
> 50 MHz to 10 GHz	≥ 42	≥ 35	≥ 42	±0.10	±0.05
> 10 GHz to 20 GHz	≥ 36	≥ 26.5	≥ 36	±0.10	±0.05
> 20 GHz to 30 GHz	≥ 32	≥ 22.5	≥ 32	±0.10	±0.05
> 30 GHz to 40 GHz	≥ 30	≥ 20	≥ 30	±0.10	±0.05
> 40 GHz to 43.5 GHz	≥ 28	≥ 20	≥ 28	±0.10	±0.05

a. Characteristic performance.

Measurement Uncertainties

The graphs give measurement uncertainties after the above error-corrected calibration. The errors are a worst-case contribution of residual directivity, load and source match, frequency response and isolation, network analyzer dynamic accuracy, and connector repeatability. 10 Hz IF Bandwidth is used. For transmission uncertainties, it is assumed that $S_{11} = S_{22} = 0$. For reflection uncertainties, it is assumed that $S_{21} = S_{12} = 0$. All calibrations and measurements were performed at 0 dBm or default port power, whichever is less. For other conditions, please use our free Exact Uncertainty Calculator software, available for download from the Anritsu web site at www.anritsu.com.

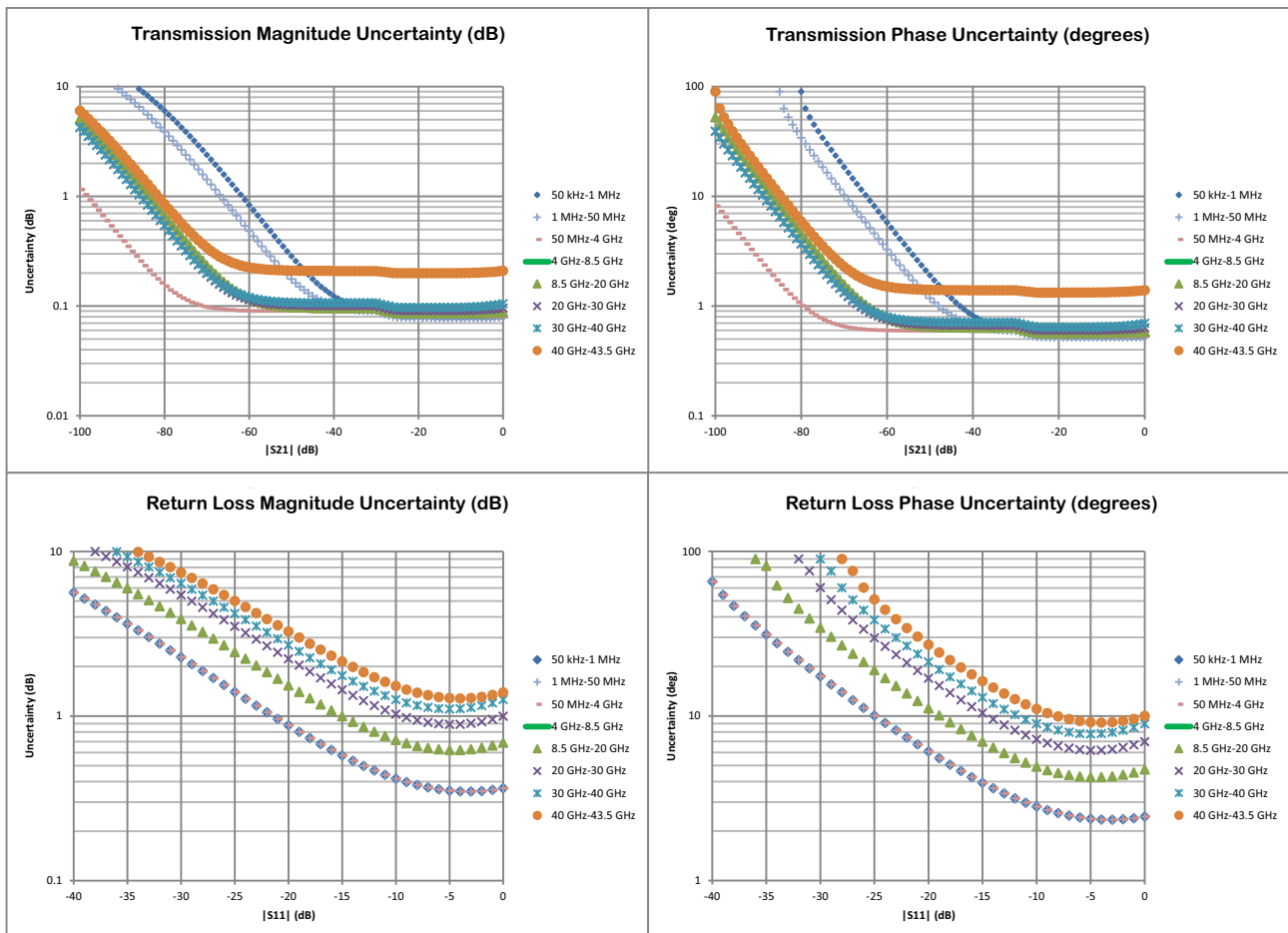

MS46522B-043 VNA System Performance with Manual Cal Kits

Error-Corrected Specifications

With 12-term SOLT Calibration using the TOSLK50A-43.5 or TOSLKF50A-43.5 Type Connector Calibration Kit with .s1p definitions.

Frequency Range	Directivity (dB)	Source Match (dB)	Load Match ^a (dB)	Reflection Tracking ^a (dB)	Transmission Tracking ^a (dB)
< 50 MHz	> 45	> 45	> 44	±0.10	±0.05
> 0.05 GHz to 10 GHz	≥ 45	≥ 45	≥ 44	±0.10	±0.05
> 10 GHz to 20 GHz	≥ 45	≥ 45	≥ 44	±0.10	±0.05
> 20 GHz to 30 GHz	≥ 45	≥ 44	≥ 44	±0.10	±0.05
> 30 GHz to 40 GHz	≥ 45	≥ 42	≥ 44	±0.10	±0.05
> 40 GHz to 43.5 GHz	≥ 42	≥ 41	≥ 41	±0.175	±0.15

a. Characteristic performance.

Measurement Uncertainties

The graphs give measurement uncertainties after the above error-corrected calibration. The errors are a worst-case contribution of residual directivity, load and source match, frequency response and isolation, network analyzer dynamic accuracy, and connector repeatability. 10 Hz IF Bandwidth is used. For transmission uncertainties, it is assumed that $S_{11} = S_{22} = 0$. For reflection uncertainties, it is assumed that $S_{21} = S_{12} = 0$. All calibrations and measurements were performed at 0 dBm or default port power, whichever is less. For other conditions, please use our free Exact Uncertainty Calculator software, available for download from the Anritsu web site at www.anritsu.com.

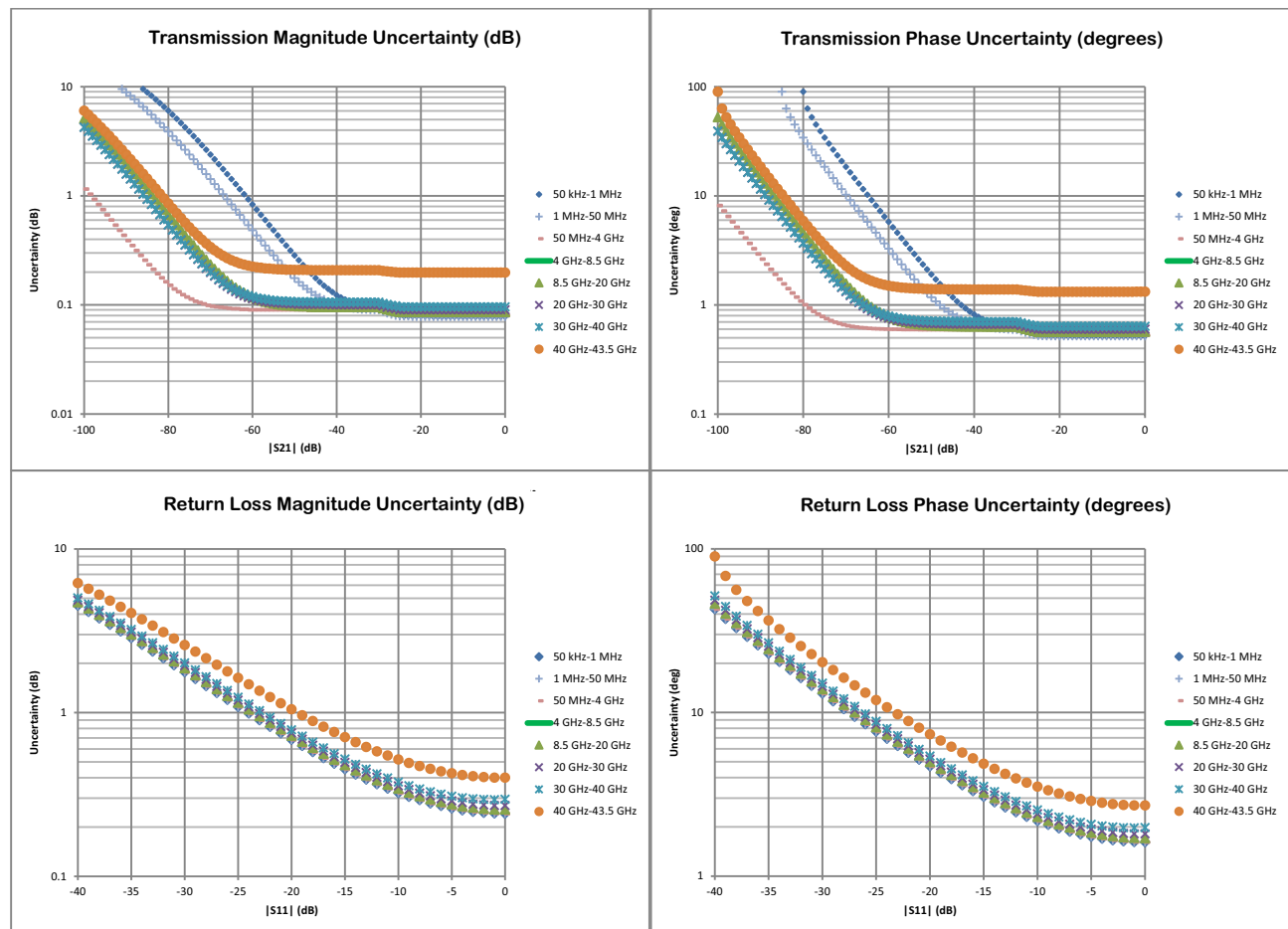

MS46522B-010 VNA System Performance with SmartCal™

Error-Corrected Specifications

With 12-term calibration using the MN25208A SmartCal™ automatic calibration kit with connector options MN25208A-001, -002, -003

Frequency Range	Directivity (dB)	Source Match (dB)	Load Match ^a (dB)	Reflection Tracking ^a (dB)	Transmission Tracking ^a (dB)
300 kHz to 1 GHz	> 42	> 35	> 38	±0.15	±0.08
> 1 GHz to 5 GHz	> 42	> 35	> 38	±0.08	±0.08
> 5 GHz to 8.5 GHz	> 36	> 35	> 33	±0.10	±0.08

a. Characteristic performance.

Measurement Uncertainties

The graphs give measurement uncertainties after the above error-corrected calibration. The errors are a worst-case contribution of residual directivity, load and source match, frequency response and isolation, network analyzer dynamic accuracy, and connector repeatability. 10 Hz IF Bandwidth is used. For transmission uncertainties, it is assumed that $S_{11} = S_{22} = 0$. For reflection uncertainties, it is assumed that $S_{21} = S_{12} = 0$. All calibrations and measurements were performed at 0 dBm or default port power, whichever is less. For other conditions, please use our free Exact Uncertainty Calculator software, available for download from the Anritsu web site at www.anritsu.com.

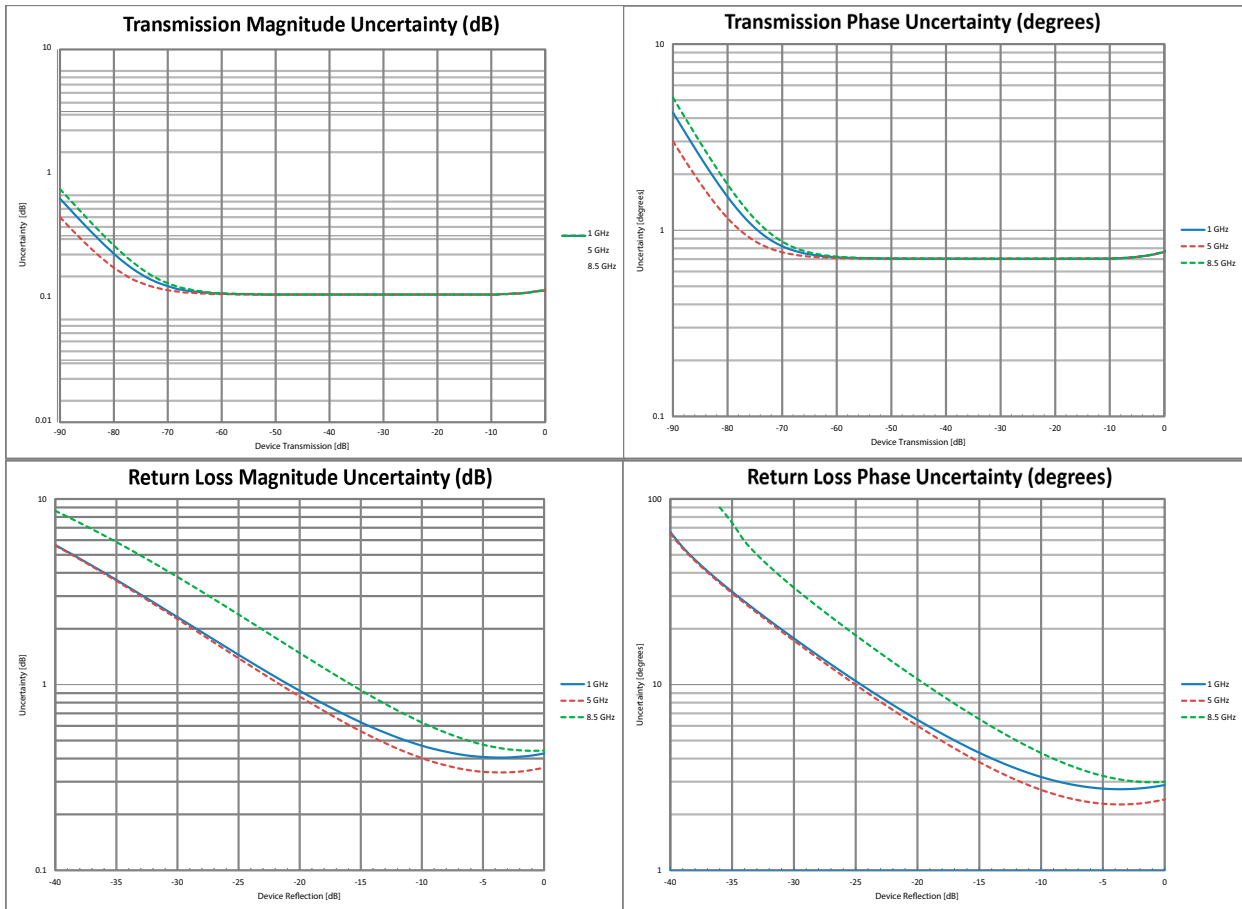

MS46522B-010 VNA System Performance with SmartCal™

Error-Corrected Specifications

With 12-term calibration using the MN25408A SmartCal™ automatic calibration kit with option MN25408A-001, -002, -003

Frequency Range	Directivity (dB)	Source Match (dB)	Load Match ^a (dB)	Reflection Tracking ^a (dB)	Transmission Tracking ^a (dB)
300 kHz to 1 GHz	> 42	> 35	> 38	±0.15	±0.2
> 1 GHz to 5 GHz	> 40	> 35	> 38	±0.08	±0.2
> 5 GHz to 8.5 GHz	> 33	> 32	> 33	±0.10	±0.2

a. Characteristic performance.

Measurement Uncertainties

The graphs give measurement uncertainties after the above error-corrected calibration. The errors are a worst-case contribution of residual directivity, load and source match, frequency response and isolation, network analyzer dynamic accuracy, and connector repeatability. 10 Hz IF Bandwidth is used. For transmission uncertainties, it is assumed that $S_{11} = S_{22} = 0$. For reflection uncertainties, it is assumed that $S_{21} = S_{12} = 0$. All calibrations and measurements were performed at 0 dBm or default port power, whichever is less. For other conditions, please use our free Exact Uncertainty Calculator software, available for download from the Anritsu web site at www.anritsu.com.

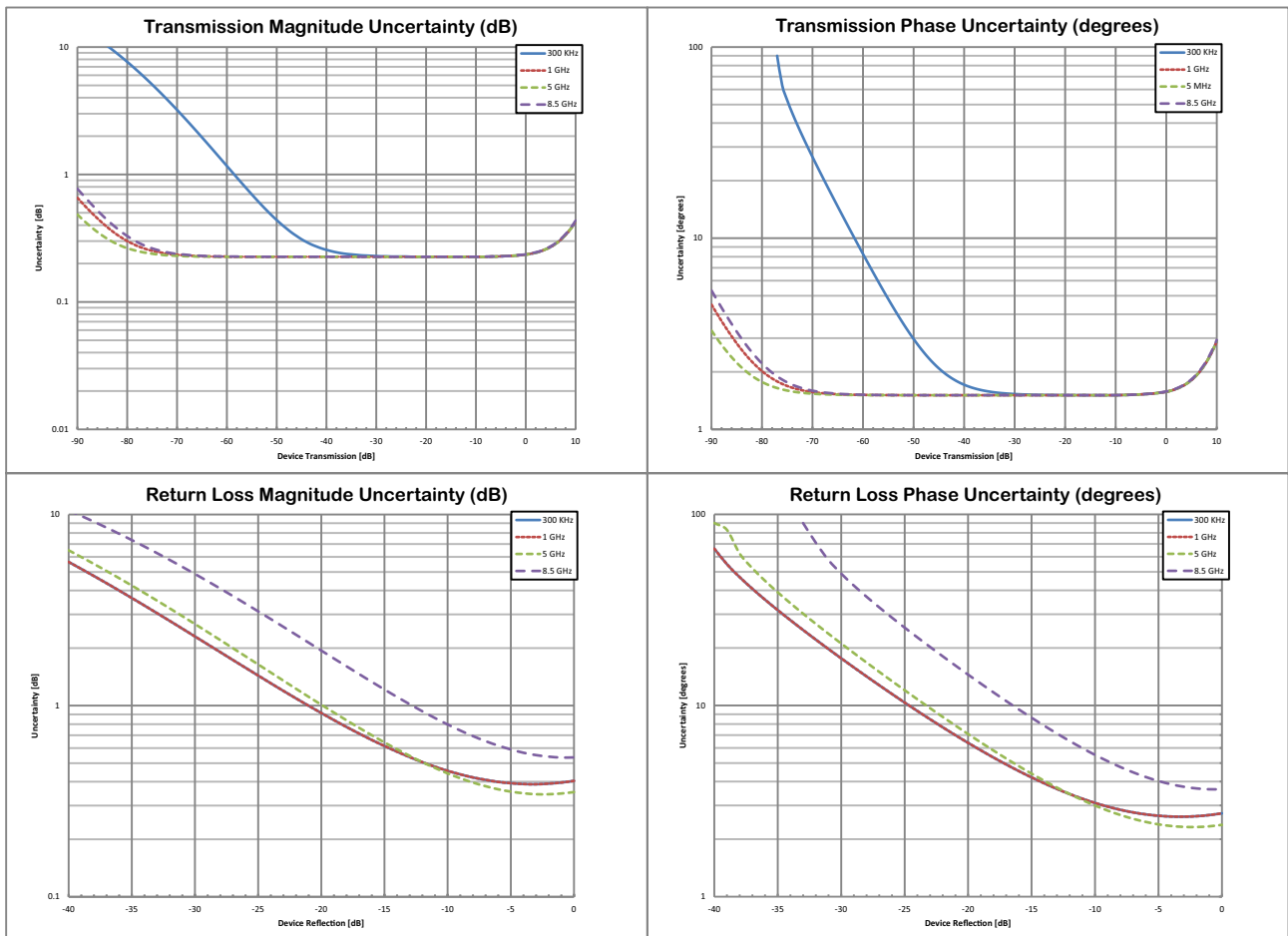

MS46522B-010 and MS46522B-020 VNA System Performance with SmartCal™

Error-Corrected Specifications

With 12-term calibration using the 2-port MN25218A SmartCal™ automatic calibration kit.

Frequency Range	Directivity (dB)	Source Match (dB)	Load Match ^a (dB)	Reflection Tracking ^a (dB)	Transmission Tracking ^a (dB)
300 kHz to 1 GHz ^b	> 42	> 33	> 42	±0.15	±0.06
> 1 GHz to 10 GHz	> 37	> 33	> 42	±0.15	±0.06
> 10 GHz to 18 GHz	> 37	> 33	> 37	±0.15	±0.10
> 18 GHz to 20 GHz	> 37	> 33	> 37	±0.20	±0.20

a. Characteristic performance

b. Applies to Rev 2 SmartCal Modules. MN25218A with serial numbers <1817999 operate from 1 MHz to 20 GHz.

Measurement Uncertainties

The graphs give measurement uncertainties after the above error-corrected calibration. The errors are a worst-case contribution of residual directivity, load and source match, frequency response and isolation, network analyzer dynamic accuracy, and connector repeatability. 10 Hz IF Bandwidth is used. For transmission uncertainties, it is assumed that $S_{11} = S_{22} = 0$. For reflection uncertainties, it is assumed that $S_{21} = S_{12} = 0$. All calibrations and measurements were performed at 0 dBm or default port power, whichever is less. For other conditions, please use our free Exact Uncertainty Calculator software, available for download from the Anritsu web site at www.anritsu.com.

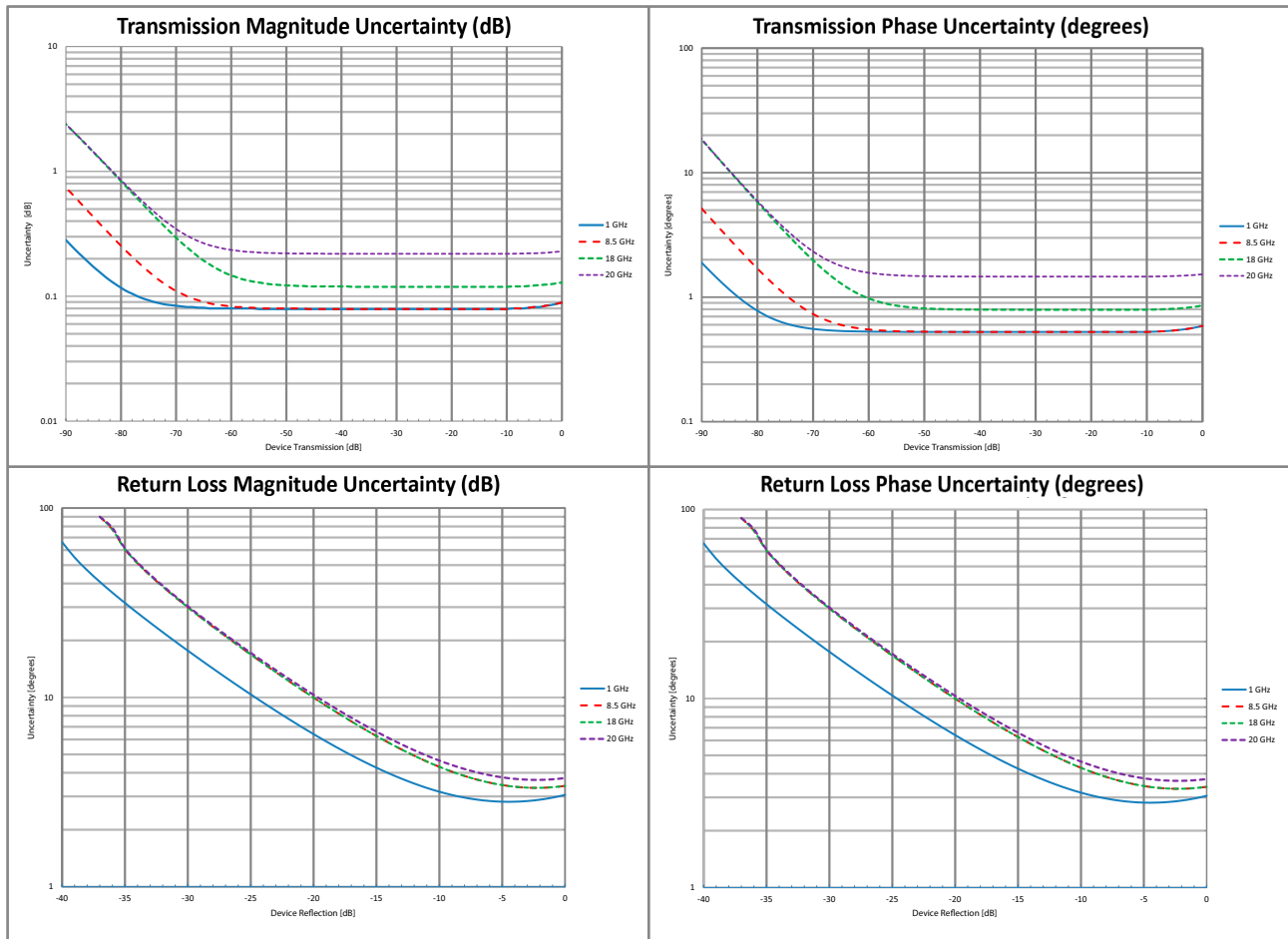

MS46522B-010 and MS46522B-020 VNA System Performance with SmartCal™

Error-Corrected Specifications

With 12-term calibration using the 4-port MN25418A SmartCal™ automatic calibration kit.

Frequency Range	Directivity (dB)	Source Match (dB)	Load Match ^a (dB)	Reflection Tracking ^a (dB)	Transmission Tracking ^a (dB)
300 kHz to 6 GHz	≥ 40	≥ 31	≥ 42	±0.15	±0.15
> 6 GHz to 18 GHz	≥ 35	≥ 31	≥ 37	±0.20	±0.20
> 18 GHz to 20 GHz	≥ 35	≥ 31	≥ 34	±0.20	±0.25

a. Characteristic performance.

Measurement Uncertainties

The graphs give measurement uncertainties after the above error-corrected calibration. The errors are a worst-case contribution of residual directivity, load and source match, frequency response and isolation, network analyzer dynamic accuracy, and connector repeatability. 10 Hz IF Bandwidth is used. For transmission uncertainties, it is assumed that $S_{11} = S_{22} = 0$. For reflection uncertainties, it is assumed that $S_{21} = S_{12} = 0$. All calibrations and measurements were performed at 0 dBm or default port power, whichever is less. For other conditions, please use our free Exact Uncertainty Calculator software, available for download from the Anritsu web site at www.anritsu.com.

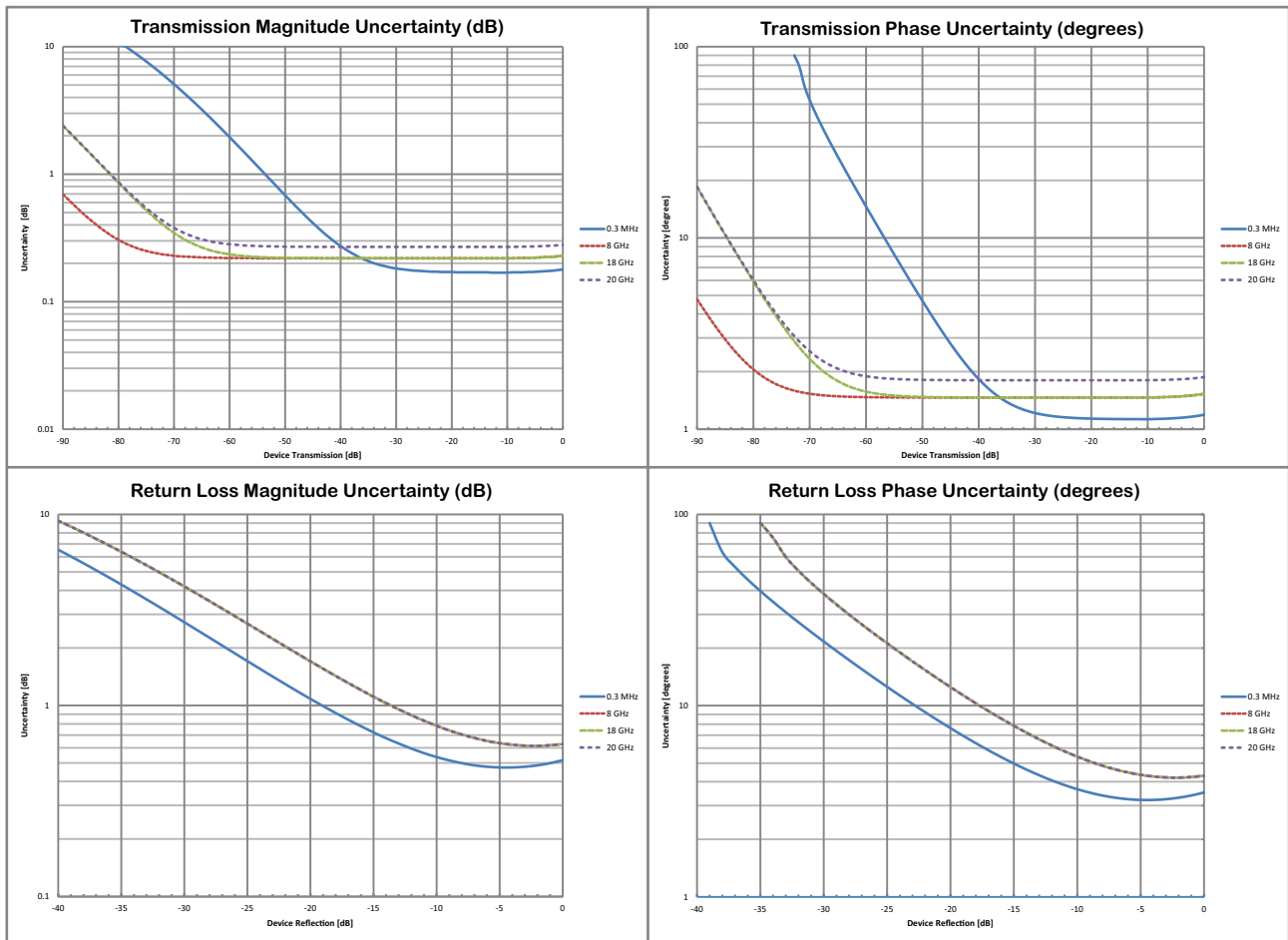

MS46522B-043 VNA System Performance with Precision AutoCal™

Error-Corrected Specifications

With 12-term calibration using the 2-port 36585K automatic calibration kit with type K connectors.

Frequency Range	Directivity (dB)	Source Match (dB)	Load Match ^a (dB)	Reflection Tracking ^a (dB)	Transmission Tracking ^a (dB)
70 kHz to < 10 MHz	≥ 40	≥ 40	≥ 40	±0.10	±0.20
10 MHz to < 2.5 GHz	≥ 43	≥ 47	≥ 43	±0.20	±0.20
2.5 GHz to < 4 GHz	≥ 50	≥ 47	≥ 50	±0.20	±0.20
4 GHz to < 8 GHz	≥ 50	≥ 47	≥ 50	±0.30	±0.20
8 GHz to < 11 GHz	≥ 50	≥ 47	≥ 50	±0.40	±0.20
11 GHz to < 20 GHz	≥ 50	≥ 47	≥ 50	±0.30	±0.20
20 GHz to 40 GHz	≥ 48	≥ 47	≥ 48	±0.40	±0.20

a. Characteristic performance.

Measurement Uncertainties

The graphs give measurement uncertainties after the above error-corrected calibration. The errors are a worst-case contribution of residual directivity, load and source match, frequency response and isolation, network analyzer dynamic accuracy, and connector repeatability. 10 Hz IF Bandwidth is used. For transmission uncertainties, it is assumed that $S_{11} = S_{22} = 0$. For reflection uncertainties, it is assumed that $S_{21} = S_{12} = 0$. All calibrations and measurements were performed at 0 dBm or default port power, whichever is less. For other conditions, please use our free Exact Uncertainty Calculator software, available for download from the Anritsu web site at www.anritsu.com.

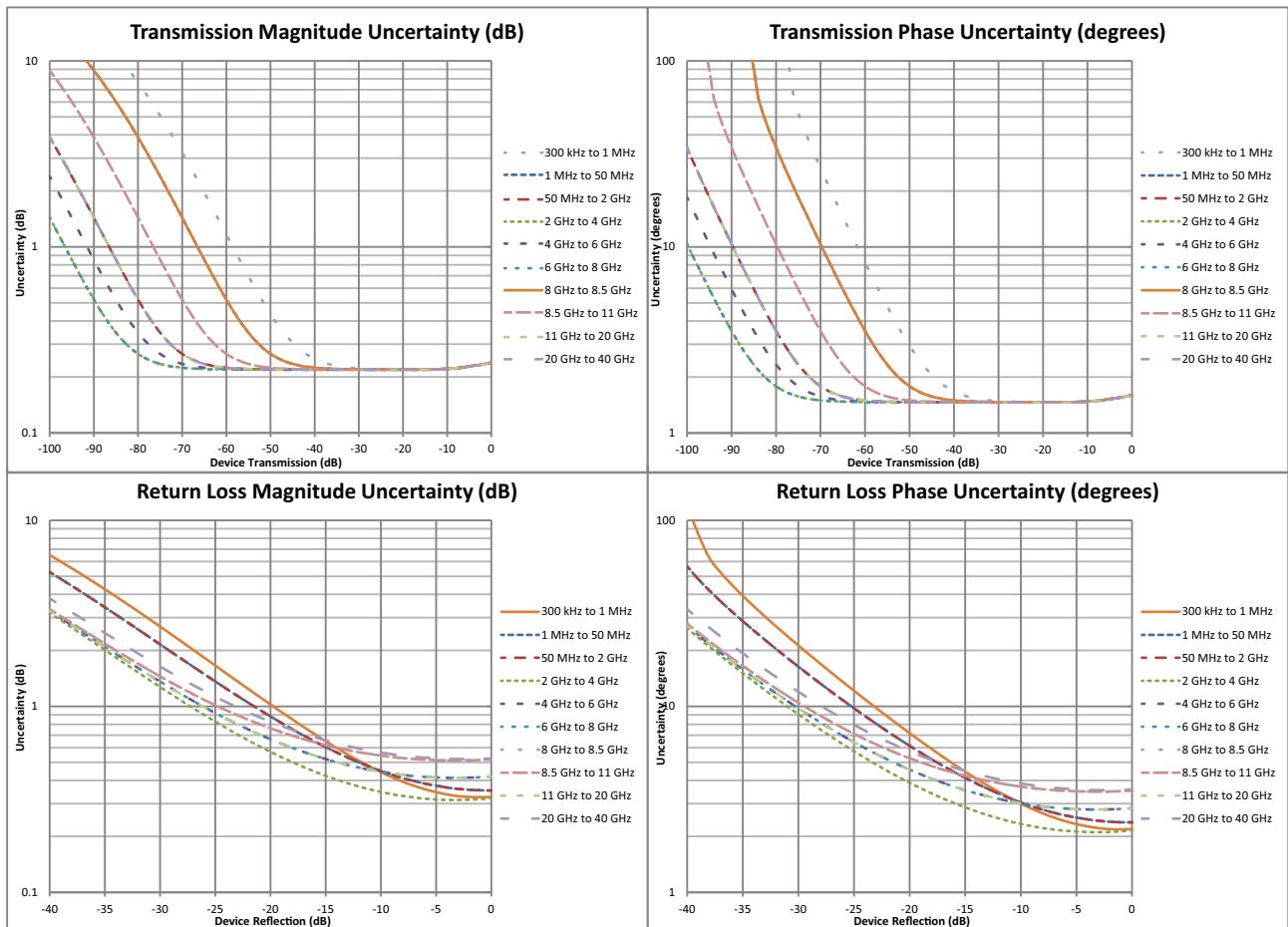

MS46522B E-Band VNA System Performance

Introduction

The E-band Option 82 and Option 83 consist of the MS46522B Series VNA base chassis and small source/receiver modules. The modules are attached to the chassis through one meter (Option 82) or five meter (Option 83) flexible tethers that are permanently attached to the unit. Units must have options 82 and 83 ordered and installed new by the factory. Those options are not interchangeable nor upgradeable on existing units.

Band	Frequency Range	Waveguide Flange
Extended E-Band	55 GHz to 92 GHz	WR-12



MS46522B E-Band VNA with E-band Option MS46522B-082



MS46522B E-Band VNA with E-band Option MS46522B-083

System Dynamic Range

System dynamic range is calculated as the difference between the test port maximum source power and the RMS noise floor at 10 Hz IF Bandwidth with averaging off and smoothing on after calibrating the instrument for transmission frequency response and isolation.¹

Frequency	Option -082, 1 meter tethers (dB)		Option -083, 5 meter tethers (dB)	
	Standard	Typical	Standard	Typical
55 GHz to 60 GHz	-	97	-	97
> 60 GHz to 62 GHz	103	109	106	111
> 62 GHz to 67 GHz	106	112	106	111
> 67 GHz to 83 GHz	110	118	110	118
> 83 GHz to 87 GHz	110	118	98	104
> 87 GHz to 90 GHz	98	111	98	104
> 90 GHz to 92 GHz	-	102	-	102

High Level Noise

Measured at 100 Hz IF bandwidth and at default power level, RMS. Performance is typical.

Frequency	Magnitude (dB)	Phase (deg)
60 GHz to 90 GHz	0.004	0.06

Output Power Range

Minimum to maximum rated leveled output power. Performance is typical

Frequency	Standard (dBm)
60 GHz to 69 GHz	-55 to -5
> 69 GHz to 88 GHz	-50 to 0
> 88 GHz to 90 GHz	-60 to -10

Power Accuracy

Accuracy is defined at maximum rated power -5 dB. Performance is typical

Frequency	Accuracy (dB)	Resolution (dB)
60 GHz to 90 GHz	±2.0	0.01

Mechanical Stability

Ratioed measurement, with ports connected. Tested with pictured fixture ~18 inches in front of chassis with modules moving 100 mm and 15 degrees as shown. Applies to MS46522B-082 >= revision 3 and MS46522B-083 >= revision 1. Typical.

Frequency	Magnitude	Phase
60 to 90 GHz	±0.1 dB	±3.0 degrees

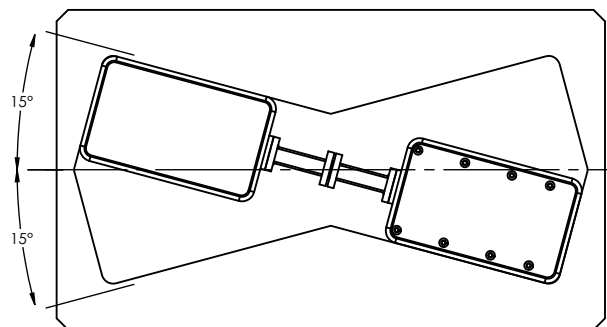
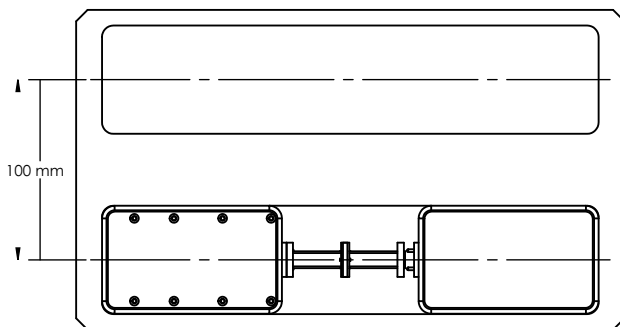

1. Option -082 supports the ability to turn off the unused test receiver during s-parameter measurements (Spur Reduction) to reduce spurious signals reflected back from highly reflective DUTs like deep stop-band filters. Option -083 does not support this functionality.

MS46522B-082 and MS46522B-083 E-Band VNA System Performance with Waveguide Cal Kit

Error-Corrected Specifications

With 12-term SSLT Calibration using the 3655E WR12 Waveguide Calibration Kit. Typical.

Frequency Range	Directivity (dB)	Source Match (dB)	Load Match ^a (dB)	Reflection Tracking ^a (dB)	Transmission Tracking ^a (dB)
60 GHz to 63 GHz	> 36	> 31	> 36	±0.10	±0.10
> 63 GHz to 67 GHz	≥ 45	≥ 29	≥ 45	±0.10	±0.10
> 67 GHz to 71 GHz	≥ 47	≥ 31	≥ 47	±0.10	±0.10
> 71 GHz to 75 GHz	≥ 42	≥ 33	≥ 42	±0.10	±0.10
> 75 GHz to 79 GHz	≥ 40	≥ 36	≥ 40	±0.10	±0.10
> 79 GHz to 83 GHz	≥ 44	≥ 36	≥ 44	±0.10	±0.10
> 83 GHz to 87 GHz	≥ 44	≥ 42	≥ 44	±0.10	±0.10
> 87 GHz to 90 GHz	≥ 41	≥ 40	≥ 41	±0.10	±0.10

a. Characteristic performance.

Measurement Uncertainties

The graphs give measurement uncertainties after the above error-corrected calibration. The errors are a worst-case contribution of residual directivity, load and source match, frequency response and isolation, network analyzer dynamic accuracy, and connector repeatability. 10 Hz IF Bandwidth is used. For transmission uncertainties, it is assumed that $S_{11} = S_{22} = 0$. For reflection uncertainties, it is assumed that $S_{21} = S_{12} = 0$. All calibrations and measurements were performed at 0 dBm or default port power, whichever is less. For other conditions, please use our free Exact Uncertainty Calculator software, available for download from the Anritsu web site at www.anritsu.com.

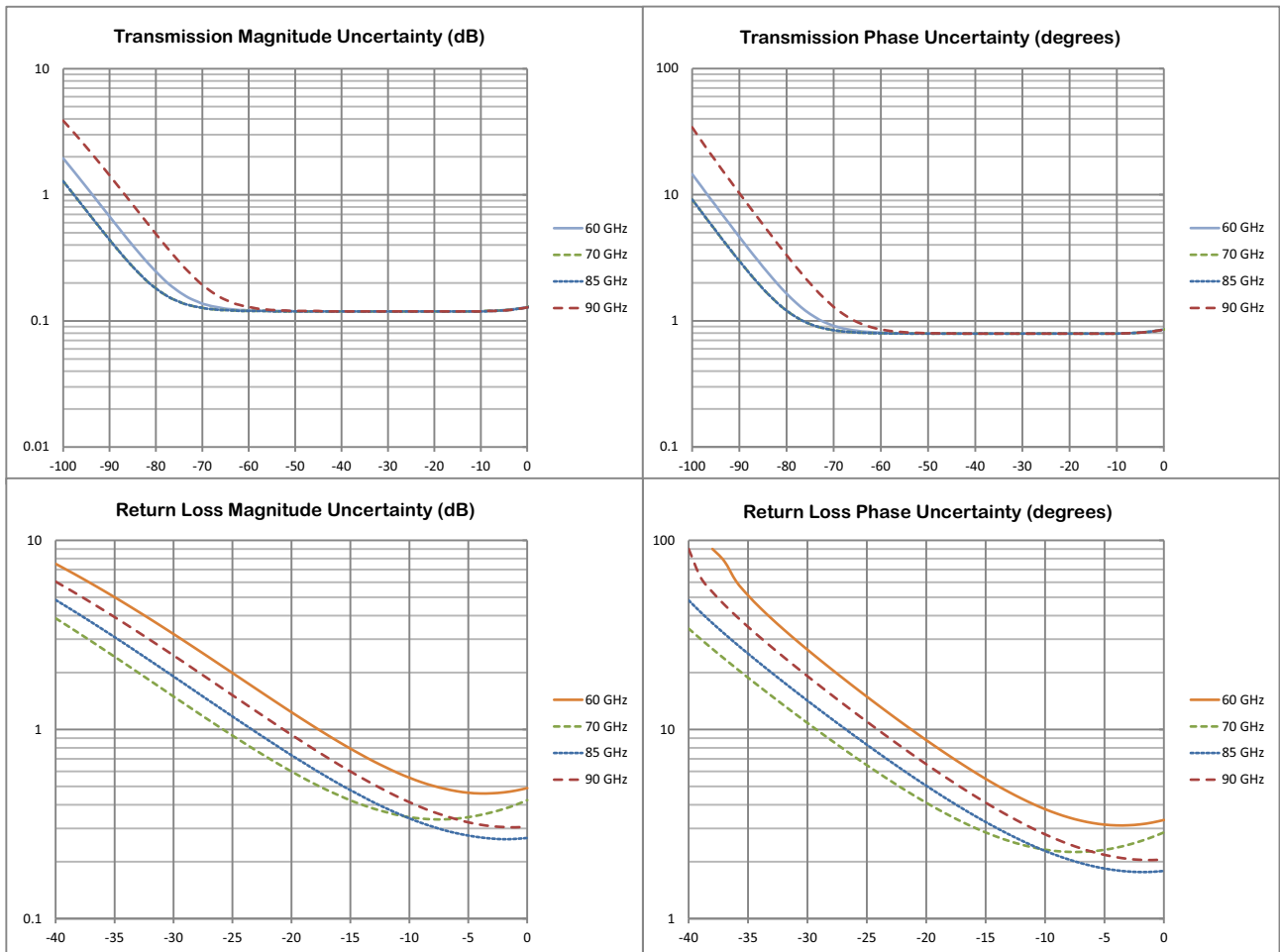

Measurement Throughput Summary

Cycle Time for Measurement Completion (ms)

Number of traces = 1; system error correction on. Includes retrace time. Typical performance data.

Number of Points	500 kHz IF Bandwidth				1 kHz IF Bandwidth			
	51	201	401	1601	51	201	401	1601
Start 1 GHz, stop 1.2 GHz								
Uncorrected	2	5	9	33	54	211	421	1677
2-Port Cal	4	9	18	64	108	442	841	3353
Start 50 kHz, stop 8 GHz								
Uncorrected	7	10	14	42	58	216	426	1685
2-Port Cal	13	20	28	78	115	432	851	3370
Start 19 GHz, stop 20 GHz								
Uncorrected	3	7	14	52	58	217	430	1703
2-Port Cal	5	14	27	103	115	434	859	3410
Start 50 kHz, stop 43.5 GHz								
Uncorrected	43	50	58	104	99	261	475	1759
2-Port Cal	85	99	115	207	197	520	949	3517

Data Transfer Time (ms)

Transferred complex S11 data, using "CALC:DATA:SDATA?" command. Typical performance data.^a

Number of Points	51	201	401	1601
SCPI over LAN				
REAL 64	4	4	4	8
REAL 32	4	4	4	8
ASCII	4	4	4	16

a. Data transfer time varies depending on the PC and control software used with the VNA.

Standard Capabilities

Operating Frequencies

MS46522B-010	50 kHz to 8.5 GHz
MS46522B-020	50 kHz to 20 GHz
MS46522B-043	50 kHz to 43.5 GHz
MS46522B-082	55 GHz to 92 GHz, one meter tethers
MS46522B-083	55 GHz to 92 GHz, five meter tethers

Measurement Parameters

2-Port Measurements	$S_{11}, S_{21}, S_{22}, S_{12}$, and any user-defined combination of $a_1, a_2, b_1, b_2, 1$ Maximum Efficiency Analysis, Mixed-mode SDD, SDC, SCD, SCC
Domains	Frequency Domain, Time (Distance) Domain (Option 2), Power Domain

Sweeps

Sweep Configurations	Standard or Simultaneous (MS46522B-010 option only)
Frequency Sweep Types	Linear, Log, CW, or Segmented
Power Sweep Types	Linear CW

Display Graphs

Single Rectilinear Graph Types	Log Magnitude, Phase, Group Delay, Linear Magnitude, Real, Imaginary, SWR, Impedance, KQ and η Max
Dual Rectilinear Graph Types	Log Mag and Phase, Linear Mag and Phase, Real and Imaginary, KQ and η Max
Circular Graph Types	Smith Chart (Impedance), Polar

Measurements Data Points

Maximum Data Points	2 to 20,001 points
---------------------	--------------------

Limit Lines

Limit Lines	Single or segmented. 2 limit lines per trace. 50 segments per trace.
Single Limit Readouts	Uses interpolation to determine the intersection frequency.
Test Limits	Both single and segmented limits can be used for PASS/FAIL testing.

Ripple Limit Lines

Limit Lines	Single or segmented. 2 limit lines per trace. 50 segments per trace.
Ripple Value	Absolute Value or Margin
Test Limits	Both single and segmented limits can be used for PASS/FAIL testing.

Averaging		Point-by-Point Sweep-by-Sweep	Point-by-point (default), maximum number of averages = 4096 Sweep-by-sweep, maximum number of averages = 4096
IF Bandwidth			10, 20, 30, 50, 70, 100, 200, 300, 500, 700 Hz 1, 2, 3, 5, 7, 10, 20, 30, 70, 100, 200, 300, 500 kHz
Reference Plane		Line Length or Time Delay	The reference planes of a calibration or other normalization can be changed by entering a line length or time delay.
	Dielectric Constants		Dielectric constants may be entered for different media so the length entry can be physically meaningful.
	Dispersion Modeling		Dispersion modeling is used in the cases of microstrip and waveguide to take into account frequency dependent phase velocities.
	Attenuation		Attenuation (with frequency slope) and constant phase offsets can be entered to better describe any reference plane distortions. The frequency dependence exponent is changeable.
	Auto Modes		Automatic reference plane finding tools are available for phase alone or phase + magnitude. These routines do a fitting process on phase or phase and magnitude to estimate the reference plane location and enter correcting values.
	De-embedding		For more complete reference plane manipulation, the full de-embedding system can also be used.
Measurement Frequency Range		Frequency Range Change CW Mode Interpolation Not Activated Interpolation Activated	Frequency range of the measurement can be narrowed within the calibration range without recalibration. CW mode permits single frequency measurements also without recalibration. If interpolation is not activated, the subset frequency range is forced to use calibration frequency points. If interpolation is activated, any frequency range that is a subset of the calibration frequency range can be used, but there may be some added interpolation error.
Group Delay		Group Delay Aperture Aperture Minimum Aperture Group Delay Range	Defined as the frequency span over which the phase change is computed at a given frequency point. The aperture can be changed without recalibration. The minimum aperture is the frequency range divided by the number of points in calibration and can be increased to 20 % of the frequency range. < 180° of phase change within the aperture
Channels, Display, and Traces		Channels and Traces Display Colors Trace Memory Trace Math	16 channels, each with up to 16 traces Unlimited colors for data traces, memory, text, markers, graticules, and limit lines A separate memory for each trace can be used to store measurement data for later display or comparison, with current measurement data. Up to 20 data traces per channel can be saved and recalled. Any two traces within the same or different channels can be combined (via addition, subtraction, multiplication, or division) and displayed on another trace. An equation editor mode is also available that allows the combination of trace data, trace memory and S-parameter data in more complex equations. Over 30 built-in functions are available. Simple editing tools and the ability to save/recall equations are also provided.
Scale Resolution		Log Magnitude Linear Magnitude Phase Group Delay Time Distance SWR Power	Minimum per division, varies with graph type. 0.001 dB 10 μ U 0.01° 0.1 ps 0.0001 ps 0.1 μ m 10 μ U 0.001 dB
Markers		Markers Marker Coupling Marker Overlay Marker Data Reference Marker Marker Statistics Marker Search and Tracking	12 markers + 1 reference marker per trace Coupled or decoupled Display markers on active trace only or on all traces when multiple trace responses are present on the same trace Data displayed in graph area or in table form Additional marker per trace for reference Mean, maximum, minimum, standard deviation Per trace or over a marker region Search and/or track for minimum, maximum, peak, or target value. Multiple marker search ranges per trace are available.
Other		Filter Parameters S-Parameter Conversion	Display bandwidth (user-selectable loss value), corner and center frequencies, loss, Q, and shape factors. Z Reflection Impedance Z Transmission Impedance Y Reflection Admittance Y Transmission Admittance 1/S

Calibration and Correction Capabilities

Calibration Methods	<p>Short-Open-Load-Through (SOLT) Short-Open-Load-Reciprocal (SOLR) Offset-Short-Offset-Short-Load-Through (SSLT) Triple-Offset-Short-Through (SSST) Line-Reflect-Line (LRL) / Line-Reflect-Match (LRM) Thru-Reflect-Line (TRL) / Thru-Reflect-Match (TRM) Source Calibration Receiver Calibration SmartCal™ AutoCal™ Thru Update available Secondary match correction available for improved low insertion loss measurements</p>
Correction Models	<p>2-Port (Forward, Reverse, or both directions) 1-Port (S_{11}, S_{22}, or both) Transmission Frequency Response (Forward, Reverse, or both directions) Reflection Frequency Response (S_{11}, S_{22}, or both)</p>
Coefficients for Calibration Standards	<p>Use the Anritsu calibration kit USB memory device to load kit coefficients and characterization files. Use predefined coefficients for Anritsu calibration kits in ShockLine software. Enter coefficients into user-defined locations. Use complex load models.</p>
Interpolation	<p>Allows interpolation between calibration frequency points.</p>
Adapter Removal Calibration	<p>Characterizes and “removes” an adapter that is used during calibration that will not be used for subsequent device measurements; for accurate measurement of non-insertable devices.</p>
Dispersion Compensation	<p>Selectable as Coaxial, other non-dispersive (e.g., for coplanar waveguide), Waveguide, or Microstrip</p>
Power	<p>Power Meter Correction Different power meter calibrations are available to enhance power accuracy at the desired reference plane. The source power will match the target calibration power, as read by the power meter, to within ~0.1 dB for short periods of time (determined by thermal drift of the system and the power meter). The absolute accuracy of the calibrated power will be dependent on the power meter and sensor used.</p> <p>Flat Power Calibrations A flat power calibration (when in frequency sweep mode) is available at a user-selectable power level, if it is within the power adjustment range of the internal source. The flat power correction is applied to other power levels.</p> <p>Linear Power Calibrations A linear power calibration is performed over a range of power levels for use in power sweep mode and is performed at a specified frequency or frequency range.</p> <p>External Power Meter Both calibrations are performed using an external USB power sensor (Anritsu MA24106A, MA24108A, MA24118A, MA24126A, MA24330A, MA24340A, MA24350A) over a USB 2.0 port.</p>
Embedding/De-embedding	<p>The MS46522B is equipped with an Embedding/De-embedding system.</p> <p>De-embedding De-embedding is generally used for removal of test fixture contributions, modeled networks, and other networks described by S-parameters (s2p files) from measurements.</p> <p>Embedding Similarly, the Embedding function can be used to simulate matching circuits for optimizing amplifier designs or simply adding effects of a known structure to a measurement.</p> <p>Multiple Networks Multiple networks can be embedded/de-embedded and changing the port and network orientations is handled easily.</p> <p>Extraction Utility An extraction utility is part of this package that allows easier computation of de-embedding files based on additional calibration steps and measurements.</p>
Optical/Electrical Conversion	<p>O/E, E/O, & O/O</p> <p>O/E, E/O, and O/O setup wizards are provided</p>
Impedance Conversion	<p>Allows entry of different reference impedances (complex values) for different ports</p>

Optional Capabilities

Time Domain Measurements, Option 2	Displays all S-parameters and overlays with Frequency Domain, Low-pass Mode with added harmonics frequency list flexibility, Band-pass Mode, Phasor Impulse Mode, Windowing, Gating (pass-band or reject-band), and Frequency with Time Gate.
Advanced Time Domain Measurements, Option 22	The ATD option has two basic elements. The first element is an Eye Diagram automatically created from a stored .SnP data file after launching the ADK software. The second element accesses the following functions: Check Passivity and Causality, Combine .SnP Files, Plot Eye Diagram, Plot Crosstalk, Plot TDT/TDR/Skew, and Perform Compliance Test. Option 2 recommended with Option 22, but is not required.
Universal Fixture Extraction, Option 24	Provides a suite of additional network extraction techniques for different de-embedding problems, particularly those when only partial interface information is available at the DUT plane. These are often useful for on-wafer and fixtured environments with more complex DUT interfaces where traditional standards may not be available. In most cases, .s1p definition/model of reflect standards is allowed and generally automatic fixture length detection is available. In addition, a sequential extraction (peeling) of isolated fixture defects is possible and allows one to generate sNp files for portions of the fixture for design analysis.

Remote Operability

ShockLine supports several remote operability options.

Communication Type	Data Format	Performance	Description
Via LAN	Using VXI-11 Protocol	Gigabit Data Transfer Speed	Use SCPI commands
Drivers for LAN	IVI-C drivers are available for download from the Anritsu website. The IVI-C package supports National Instruments LabVIEW and LabWindows, C#, .NET, MATLAB, and Python programming environments.		
Triggering	Start Trigger	Software and digital edge	
	Input Range	+3.3 V logic level (+5 V tolerant)	
	Minimum Trigger Width	50 ns	
	Trigger Delay	6 μ s, typical	

Front Panel Connections

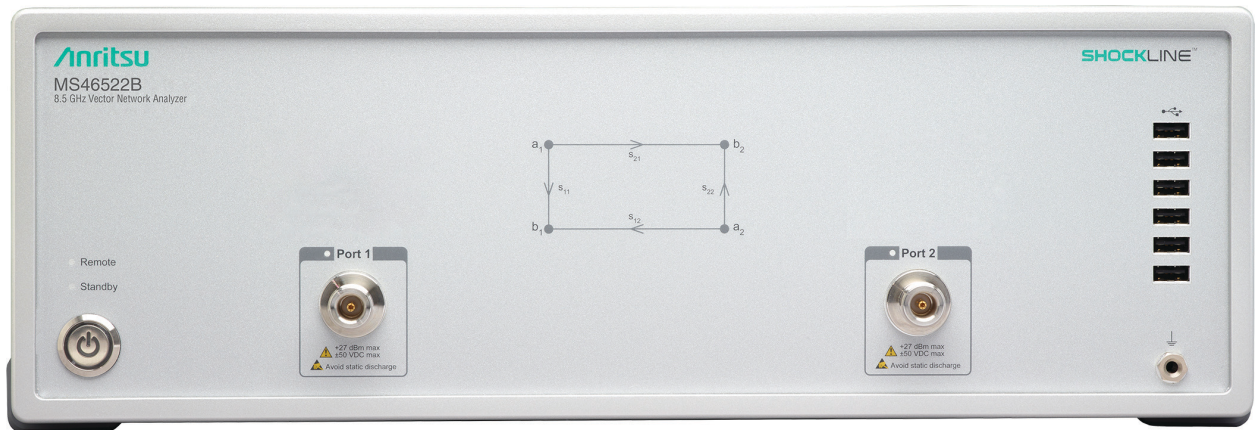

MS46522B Front Panel (8.5 GHz model shown)

Test Ports 1 and 2

MS46522B-010	N(f)
MS46522B-020	K(m)
MS46522B-043	Extended-K™(m)
MS46522B-082	WR12 Waveguide Flange
MS46522B-083	WR12 Waveguide Flange
Damage Input Levels	+27 dBm maximum, 50 VDC maximum

USB Ports

Six type A USB 2.0 Ports for peripherals such as keyboard, mouse, memory stick, hardware key, and similar devices.

Chassis Grounding Port

Banana(f)

Rear Panel Connections



MS46522B Rear Panel

AC Power Input		AC Input connector, with On/Off switch, and fuses 350 VA maximum, 90 to 264 VAC, 47 to 63 Hz (power factor controlled)
USB and LAN		
	USB Ports	Four type A USB 3.0 for peripherals such as keyboard, mouse, memory stick, USB monitor, and hardware key.
	LAN Port	Gigabit Ethernet
Media		
	HDMI and Display Port	Video output, touchscreen compatible
	Audio	External stereo speaker and microphone (3.5 mm)
10 MHz In		
	Connector Type	BNC(f)
	Signal	+0 dBm, typical; 50 Ω, nominal
10 MHz Out		
	Connector Type	BNC(f)
	Signal	+8 dBm, typical; 50 Ω, nominal
External Trigger Input		
	Connector Type	BNC(f)
	Voltage Input	0 to 3.3 V input (5 V tolerant)
	Impedance	High impedance (> 100 kΩ)
	Pulse Width	50 ns minimum input pulse width
	Trigger Delay	6 μs typical
External Trigger Output		
	Connector type	BNC(f)
	Voltage Output	0 to 3.3 V (HCMOS logic)
	Drive Current	24 mA maximum
	Pulse Width	1 μs, typical
Bias Inputs (Only available with Option 10)		
	Connector	BNC(f) (one input per port); 50 VDC maximum, 0.5 A maximum
	Required	Frequency Option 10

CPU, Memory, and Security Features

CPU	Intel Core™ i5/i7
Storage	Serial-ATA (SATA) Solid State Drive for OS, Programs, and Data (> 30 GB).
Security Features	If the VNA is attached to a network, best practices recommend installing anti-virus software.

Mechanical

Dimensions	H x W x D	Dimensions listed are for the instrument body only, without rack mount option attached. 152 mm (5.98 in.) x 445 mm (17.52 in.) x 442 mm (17.4 in.)
	H x W x D	Dimensions listed below are for the E-band modules for frequency options 82 and 83: 38 mm x 60 mm x 102.4 mm
Weight		< 11 kg (< 25 lb), typical weight for a fully-loaded MS46522B-010 VNA < 13 kg (< 28 lb), typical weight for a fully-loaded MS46522B-020 or MS46522B-043 VNA < 14 kg (< 31 lb), typical weight for a fully loaded MS46522B-082 including tethers < 15 kg (< 33 lb), typical weight for a fully loaded MS46522B-083 including tethers

Regulatory Compliance

European Union	EMC 2014/30/EU, EN 61326:2013, CISPR 11/EN 55011, IEC/EN 61000-4-2/3/4/5/6/11 Low Voltage Directive 2014/35/EU Safety EN 61010-1:2010 RoHS Directive 2011/65/EU & Amendment 2015/863
United Kingdom	EMC SI 2016/1091; BS EN 55011 & BS EN 61000-4-2/3/4/5/6/8/11 Consumer Protection (Safety) SI 2016/1101; BS EN 61010-1:2010 Environmental Protection SI 2012/3032; 2011/65/EU & 2015/863
Canada	ICES-1(A)/NMB-1(A)
Australia and New Zealand	RCM AS/NZS 4417:2012
South Korea	R-R-A2J-1010

Environmental

	MIL-PRF-28800F Class 3 (vibration and shock do not apply to Option 82 and Option 83 instruments)
Operating Temperature Range	0 °C to 50 °C
Storage Temperature Range	-40 °C to 71 °C
Maximum Relative Humidity	95 % RH at 30 °C, non-condensing
Vibration, Sinusoidal	5 Hz to 55 Hz
Vibration, Random	10 Hz to 500 Hz
Half Sine Shock	30 g _n
Altitude	4600 meters, operating and non-operating

Warranty

Instrument and Built-In Options	3 years from the date of shipment (standard warranty)
Calibration Kits	Typically 1 year from the date of shipment
Test Port Cables	Typically 1 year from the date of shipment
Warranty Options	Additional warranty available

Ordering Information

Instrument Models		
	MS46522B	ShockLine 2-Port Vector Network Analyzer (base model)
Requires One Frequency Option		
	MS46522B-010	50 kHz to 8.5 GHz, type N(f) ports
	MS46522B-020	50 kHz to 20 GHz, type K(m) Ruggedized ports (compatible with 3.5 mm and SMA connectors)
	MS46522B-043	50 kHz to 43.5 GHz, type Extended-K™(m) Ruggedized ports (compatible with standard K (2.92 mm), 3.5 mm, and SMA connectors)
	MS46522B-082	55 GHz to 92 GHz, WR12 waveguide flange, one meter tethers
	MS46522B-083	55 GHz to 92 GHz, WR12 waveguide flange, five meter tethers
Included Accessories		
		Each VNA comes with a power cord and instructions on where to download software and related literature.
Main VNA Options		
	MS46522B-001	Rack Mount, adds handles and removes feet for shelf-mounting into a 19 inch universal rack
	MS46522B-002	Time Domain with Time Gating
	MS46522B-022	Advanced Time Domain
	MS46522B-024	Universal Fixture Extraction
	MS46522B-061	Bias Tee (Only available with Option 10)
Calibration Options (not available for the MS46522B-082 and MS46522B-083)		
	MS46522B-097	Accredited Calibration, with data
	MS46522B-098	Standard Calibration, ISO 17025 compliant, without data
	MS46522B-099	Premium Calibration, ISO 17025 compliant, with data
O/E Calibration Module		
	MN4765B-0040	Configured for 70 kHz to 40 GHz range, with 850 nm wavelength coverage
	MN4765B-0042	Configured for 70 kHz to 40 GHz range, with 850 and 1060 nm wavelength coverage
	MN4765B-0043	Configured for 70 kHz to 40 GHz range, with 850/1060/1310/1550 nm wavelength coverage
	MN4765B-0070	Configured for 70 kHz to 70 GHz range, with 1550 nm wavelength coverage
	MN4765B-0071	Configured for 70 kHz to 70 GHz range, with 1310 nm wavelength coverage
	MN4765B-0072	Configured for 70 kHz to 70 GHz range, with 1310 and 1550 nm wavelength coverage
	MN4765B-0110	Configured for 70 kHz to 110 GHz range, with 1550 nm wavelength coverage
E/O Converter		
	MN4775A-0040	40 GHz modulation bandwidth and internal 850 nm laser
	MN4775A-0070	70 GHz modulation bandwidth and internal C-band laser set to 1550 nm
	MN4775A-0071	70 GHz modulation bandwidth and internal 1310 fixed lase
Precision Automatic Calibrator Modules		
	MN25208A	2-port USB SmartCal Module, 300 kHz to 8.5 GHz (available with connector Options -001 N(f), -002 K(f), -003 3.5 mm(f))
	MN25408A	4-port USB SmartCal Module, 300 kHz to 8.5 GHz (available with connector Options -001 N(f), -002 K(f), -003 3.5 mm(f))
	MN25218A ¹	2-port USB SmartCal Module, 300 kHz to 20 GHz (available with connector Option -002 K(f))
	MN25418A	4-port USB SmartCal Module, 300 kHz to 20 GHz (available with connector Option -002 K(f))
	36585K-2M	K Precision AutoCal Module, 70 kHz to 40 GHz, K(m) to K(m)
	36585K-2F	K Precision AutoCal Module, 70 kHz to 40 GHz, K(f) to K(f)
	36585K-2MF	K Precision AutoCal Module, 70 kHz to 40 GHz, K(m) to K(f)
	2000-1809-R	Serial to USB Adapter (required for use with 36585 AutoCal module)

1. Applies to Rev 2 SmartCal Modules. MN25218A with serial numbers <1817999 operate from 1 MHz to 20 GHz.

Mechanical Calibration Kits

3650A	SMA/3.5 mm Calibration Kit, Without Sliding Loads, DC to 26.5 GHz, 50 Ω
3652A	K Connector Calibration Kit, Without Sliding Loads, DC to 40 GHz, 50 Ω
3653A	N Connector Calibration Kit, Without Sliding Loads, DC to 18 GHz, 50 Ω
3655E	Waveguide Calibration Kit (WR12)
OSLN50A-8	Precision N Male Open/Short/Load Mechanical Calibration Tee, DC to 8 GHz, 50 Ω
OSLNF50A-8	Precision N Female Open/Short/Load Mechanical Calibration Tee, DC to 8 GHz, 50 Ω
TOSLN50A-8	Precision N Male Through/Open/Short/Load Mechanical Calibration Tee, DC to 8 GHz, 50 Ω
TOSLNF50A-8	Precision N Female Through/Open/Short/Load Mechanical Calibration Tee, DC to 8 GHz, 50 Ω
OSLN50A-18	Precision N Male Open/Short/Load Mechanical Calibration Tee, DC to 18 GHz, 50 Ω
OSLNF50A-18	Precision N Female Open/Short/Load Mechanical Calibration Tee, DC to 18 GHz, 50 Ω
TOSLN50A-18	Precision N Male Through/Open/Short/Load Mechanical Calibration Tee, DC to 18 GHz, 50 Ω
TOSLNF50A-18	Precision N Female Through/Open/Short/Load Mechanical Calibration Tee, DC to 18 GHz, 50 Ω
TOSLK50A-20	Precision K Male Through/Open/Short/Load Mechanical Calibration Tee, DC to 20 GHz, 50 Ω
TOSLKF50A-20	Precision K Female Through/Open/Short/Load Mechanical Calibration Tee, DC to 20 GHz, 50 Ω
TOSLK50A-40	Precision K Male Through/Open/Short/Load Mechanical Calibration Tee, DC to 40 GHz, 50 Ω
TOSLKF50A-40	Precision K Female Through/Open/Short/Load Mechanical Calibration Tee, DC to 40 GHz, 50 Ω
TOSLK50A-43.5	Precision K Male Through/Open/Short/Load Mechanical Calibration Tee, DC to 43.5 GHz, 50 Ω Includes .s1p files for data-based calibration support
TOSLKF50A-43.5	Precision K Female Through/Open/Short/Load Mechanical Calibration Tee, DC to 43.5 GHz, 50 Ω Includes .s1p files for data-based calibration support

Verification Kit

3663-3	N Connector Verification Kit
3668-4	K Connector Verification Kit

USB Power Sensors

MA24106A	True-RMS USB Power Sensor, 50 MHz to 6 GHz
MA24108A	True-RMS USB Power Sensor, 10 MHz to 8 GHz
MA24118A	True-RMS USB Power Sensor, 10 MHz to 18 GHz
MA24126A	True-RMS USB Power Sensor, 10 MHz to 26 GHz
MA24330A	Microwave CW USB Power Sensor, 10 MHz to 33 GHz
MA24340A	Microwave CW USB Power Sensor, 10 MHz to 40 GHz
MA24350A	Microwave CW USB Power Sensor, 10 MHz to 50 GHz

Cables and Adapters

N120-6	RF Cables, Semi-Rigid, N(m) to N(m), 1 each, 0.01 to 18 GHz, 50 Ω, 15 cm (5.9 in)
NS120MF-6	RF Cables, Semi-Rigid, N(f) to N(f), 1 each, 0.01 to 18 GHz, 50 Ω, 15 cm (5.9 in)
1091-26-R	Adapter, SMA(m) to N(m), DC to 18 GHz, 50 Ω
1091-27-R	Adapter, SMA(f) to N(m), DC to 18 GHz, 50 Ω
1091-80-R	Adapter, SMA(m) to N(f), DC to 18 GHz, 50 Ω
1091-81-R	Adapter, SMA(f) to N(f), DC to 18 GHz, 50 Ω
33KK50C	Calibration Grade Adapter, DC to 43.5 GHz, K(m) to K(m), 50 Ω
33KKF50C	Calibration Grade Adapter, DC to 43.5 GHz, K(m) to K(f), 50 Ω
33KFKF50C	Calibration Grade Adapter, DC to 43.5 GHz, K(f) to K(f), 50 Ω
34NN50A	Precision Adapter, N(m) to N(m), DC to 18 GHz, 50 Ω
34NFN50	Precision Adapter, N(f) to N(f), DC to 18 GHz, 50 Ω
34NK50	Precision Adapter, N(m) to K(m), DC to 18 GHz, 50 Ω
34NKF50	Precision Adapter, N(m) to K(f), DC to 18 GHz, 50 Ω
34NFK50	Precision Adapter, N(f) to K(m), DC to 18 GHz, 50 Ω
34NFKF50	Precision Adapter, N(f) to K(f), DC to 18 GHz, 50 Ω
34VFK50A	Precision Adapter, DC to 43.5 GHz, V(f) - K(m), 50 Ω
34VFKF50A	Precision Adapter, DC to 43.5 GHz, V(f) - K(f), 50 Ω
34VK50A	Precision Adapter, DC to 43.5 GHz, V(m) - K(m), 50 Ω
34VKF50A	Precision Adapter, DC to 43.5 GHz, V(m) - K(f), 50 Ω
K220B	Precision Adapter, K(m) to K(m), DC to 40 GHz, 50 Ω
K222B	Precision Adapter, K(f) to K(f), DC to 40 GHz, 50 Ω
K224B	Precision Adapter, K(m) to K(f), DC to 40 GHz, 50 Ω
SC7260	WR12 to W1(m) Adapter, W1 (1 mm) to WR12 Waveguide
SC7442	WR12 to W1(f) Adapter, W1 (1 mm) to WR12 Waveguide
35WR12WF-EE	Precision Waveguide to Coax Adapter Kit, 56 GHz to 94 GHz, WR-12 to 1.0 mm(f)

Test Port Cables, Flexible, Ruggedized, Phase Stable

15 Series Cable Example

15NNF50-1.0B	Test Port Cable, Flexible, Phase Stable, 1.0 m (39"), DC to 18 GHz, N(f) to N(m), 50 Ω
15NNF50-1.5B	Test Port Cable, Flexible, Phase Stable, 1.5 m (59"), DC to 18 GHz, N(f) to N(m), 50 Ω
15NN50-1.0B	Test Port Cable, Flexible, Phase Stable, 1.0 m (39"), DC to 18 GHz, N(m) to N(m), 50 Ω
15LL50-1.0A	Test Port Extension Cable, Armored, Phase Stable, 1.0 m, DC to 26.5 GHz, 3.5 mm(m) to 3.5 mm(m), 50 Ω
15LLF50-1.0A	Test Port Extension Cable, Armored, Phase Stable, 1.0 m, DC to 26.5 GHz, 3.5 mm(m) to 3.5 mm(f), 50 Ω
15KK50-1.0A	Test Port Extension Cable, Armored, Phase Stable, 1.0 m, DC to 26.5 GHz, K(m) to K(m), 50 Ω
15KKF50-1.0A	Test Port Extension Cable, Armored, Phase Stable, 1.0 m, DC to 26.5 GHz, K(m) to K(f), 50 Ω

Phase-Stable 18 GHz and 43.5 GHz Semi-Rigid Cables (Armored)

3670 Series Cable Example

3670N50-1	0.3 m (12"), DC to 18 GHz, N(f) to N(m), 50 Ω
3670NN50-1	0.3 m (12"), DC to 18 GHz, N(m) to N(m), 50 Ω
3670N50-2	0.6 m (24"), DC to 18 GHz, N(f) to N(m), 50 Ω
3670NN50-2	0.6 m (24"), DC to 18 GHz, N(m) to N(m), 50 Ω
3670K50A-1	0.3 m (12"), DC to 43.5 GHz, K(f) to K(m), 50 Ω
3670K50A-2	0.6 m (24"), DC to 43.5 GHz, K(f) to K(m), 50 Ω

Phase-Stable 20, 40, and 70 GHz Test Port Cables (Flexible)



3671 Series Cable Example

- 3671KFS50-60 60 cm (23.6 in), DC to 20 GHz, K(f) to 3.5 mm(m), 50 Ω
- 3671KFSF50-60 60 cm (23.6 in), DC to 20 GHz, K(f) to 3.5 mm(f), 50 Ω
- 3671KFKF50-60 60 cm (23.6 in), DC to 40 GHz, K(f) to K(f), 50 Ω
- 3671KFK50-100 100 cm (39.4 in), DC to 40 GHz, K(f) to K(m), 50 Ω
- 3671VVF50-60 60 cm (23.6 in), DC to 70 GHz, V(f) to V(m), 50 Ω
- 3671VVF50-60 60 cm (23.6 in), DC to 70 GHz, V(f) to V(f), 50 Ω
- 3671VVF50-100 100 cm (39.4 in), DC to 70 GHz, V(f) to V(m), 50 Ω

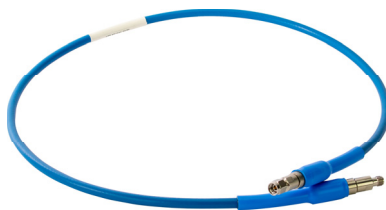

806-304-R Cable Example

- 806-304-R 91.5 cm (36 in), DC to 40 GHz, K(m) to K(f), 50 Ω
- 806-423-R 60 cm (23.6 in), DC to 43.5 GHz, K(f) - K(f), 50 Ω
- 806-424-R 60 cm (23.6 in), DC to 43.5 GHz, K(m) - K(f), 50 Ω
- 806-425-R 100 cm (39.4 in), DC to 43.5 GHz, K(f) - K(f), 50 Ω
- 806-426-R 100 cm (39.4 in), DC to 43.5 GHz, K(m) - K(f), 50 Ω



806-423-R Cable Example

Tools

- 01-200 Calibrated Torque End Wrench, GPC-7 and Type N
- 01-201 Torque End Wrench, 5/16 in, 0.9 N·m (8 lbf·in)
(for tightening male devices, for SMA, 3.5 mm, 2.4 mm, K, and V connectors)
- 01-204 End Wrench, 5/16 in, Universal, Circular, Open-ended
(for SMA, 3.5 mm, 2.4 mm, K, and V connectors)
- More Information Refer to our Precision RF & Microwave Components Catalog for descriptions of adapters and other components.

Documentation

- User Documentation Soft copies of the manuals as Adobe Acrobat PDF files are available for download from the instrument model web page at www.anritsu.com. For more information and product support, please contact www.anritsu.com/contact-us.
- 10100-00067 ShockLine Product Information, Compliance, and Safety
- 10410-00743 MS46522B/524B VNA Operation Manual
- 10410-00744 MS46522B/524B VNA User Interface Reference Manual
- 10410-00746 ShockLine Programming Manual
- 10410-00753 MS46522B/524B VNA Calibration and Measurement Guide

Notes

Training at Anritsu

Anritsu has designed courses to help you stay up to date with technologies important to your job. For available training courses, visit: www.anritsu.com and search for training and education.



• United States

Anritsu Americas Sales Company
450 Century Parkway, Suite 190,
Allen, TX 75013, U.S.A.
Phone: +1-800-Anritsu (1-800-267-4878)

• Canada

**Anritsu Electronics Ltd.
Americas Sales and Support**
450 Century Parkway, Suite 190,
Allen, TX 75013, U.S.A.
Phone: +1-800-Anritsu (1-800-267-4878)

• Brazil

Anritsu Elettronica Ltda.
Praça Amadeu Amaral, 27 - 1 Andar
01327-010 - Bela Vista - Sao Paulo - SP, Brazil
Phone: +55-11-3283-2511
Fax: +55-11-3288-6940

• Mexico

Anritsu Company, S.A. de C.V.
Blvd Miguel de Cervantes Saavedra #169 Piso 1,
Col. Granada, Mexico, Ciudad de Mexico,
11520, MEXICO
Phone: +52-55-4169-7104

• United Kingdom

Anritsu EMEA Ltd.
200 Capability Green,
Luton, Bedfordshire, LU1 3LU, U.K.
Phone: +44-1582-433200
Fax: +44-1582-731303

• France

Anritsu S.A.
12 avenue du Québec, Immeuble Goyave,
91140 VILLEBON SUR YVETTE, France
Phone: +33-1-60-92-15-50

• Germany

Anritsu GmbH
Nemetschek Haus, Konrad-Zuse-Platz 1,
81829 München, Germany
Phone: +49-89-442308-0
Fax: +49-89-442308-55

• Italy

Anritsu S.r.l.
Spaces Eur Arte, Viale dell'Arte 25, 00144 Roma, Italy
Phone: +39-6-509-9711

List Revision Date: 20230407

• Sweden

Anritsu AB
Kistagången 20 B, 2 tr, 164 40 Kista, Sweden
Phone: +46-8-534-707-00

• Finland

Anritsu AB
Technopolis Aviapolis, Teknobulevardi 3-5 (D208.5.),
FI-01530 Vantaa, Finland
Phone: +358-20-741-8100

• Denmark

Anritsu A/S
c/o Regus Winghouse, Ørestads Boulevard 73, 4th floor,
2300 Copenhagen S, Denmark
Phone: +45-7211-2200

• Spain

**Anritsu EMEA Ltd.
Representation Office in Spain**
Paseo de la Castellana, 141.
Planta 5, Edificio Cuzco IV
28046, Madrid, Spain
Phone: +34-91-572-6761

• Austria

Anritsu EMEA GmbH
Am Belvedere 10, A-1100 Vienna, Austria
Phone: +43-(0)1-717-28-710

• United Arab Emirates

**Anritsu EMEA Ltd.
Anritsu A/S**
Office No. 164, Building 17, Dubai Internet City
P. O. Box - 501901, Dubai, United Arab Emirates
Phone: +971-4-3758479

• India

Anritsu India Private Limited
6th Floor, Indiqube ETA, No.38/4, Adjacent to EMC2,
Doddanekundi, Outer Ring Road,
Bengaluru - 560048, India
Phone: +91-80-6728-1300
Fax: +91-80-6728-1301

• Singapore

Anritsu Pte. Ltd.
11 Chang Charn Road, #04-01, Shriro House
Singapore 159640
Phone: +65-6282-2400
Fax: +65-6282-2533

• Vietnam

Anritsu Company Limited
16th Floor, Peakview Tower, 36 Hoang Cau Street,
O Cho Dua Ward, Dong Da District, Hanoi, Vietnam
Phone: +84-24-3201-2730

• P.R. China (Shanghai)

Anritsu (China) Co., Ltd.
Room 2701-2705, Tower A, New Caohejing
International Business Center No. 391 Gui Ping Road
Shanghai, 200233, P.R. China
Phone: +86-21-6237-0898
Fax: +86-21-6237-0899

• P.R. China (Hong Kong)

Anritsu Company Ltd.
Unit 1006-7, 10/F., Greenfield Tower, Concordia Plaza,
No. 1 Science Museum Road, Tsim Sha Tsui East,
Kowloon, Hong Kong, P.R. China
Phone: +852-2301-4980
Fax: +852-2301-3545

• Japan

Anritsu Corporation
8-5, Tamura-cho, Atsugi-shi, Kanagawa, 243-0016 Japan
Phone: +81-46-296-6509
Fax: +81-46-225-8352

• South Korea

Anritsu Corporation, Ltd.
5FL, 235 Pangyojeok-ro, Bundang-gu, Seongnam-si,
Gyeonggi-do 13494, South Korea
Phone: +82-31-696-7750
Fax: +82-31-696-7751

• Australia

Anritsu Pty. Ltd.
Unit 20, 21-35 Ricketts Road,
Mount Waverley, Victoria 3149, Australia
Phone: +61-3-9558-8177
Fax: +61-3-9558-8255

• Taiwan

Anritsu Company Inc.
7F, No. 316, Sec. 1, NeiHu Rd., Taipei 114, Taiwan
Phone: +886-2-8751-1816
Fax: +886-2-8751-1817